

TK 151

.H75

ELECTRICIAN'S
OPERATING AND TESTING
MANUAL

HORSTMANN AND TOUSLEY

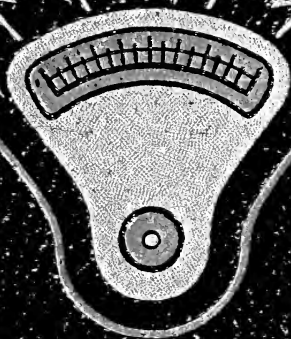



Class TH 15

Book .H 75

Copyright N^o 7

COPYRIGHT DEPOSIT.





ELECTRICIANS' OPERATING AND TESTING MANUAL

A HAND BOOK FOR MEN IN CHARGE OF ELECTRICAL APPARATUS, REPAIR MEN, TROUBLE MEN, LAMP TRIMMERS AND ELECTRICIANS GENERALLY

BY

HENRY C. HORSTMANN

AND

VICTOR H. TOUSLEY

AUTHORS OF MODERN WIRING DIAGRAMS AND DESCRIPTIONS:
MODERN ELECTRICAL CONSTRUCTION: ELECTRICAL
WIRING AND CONSTRUCTION TABLES: PRACTICAL
ARMATURE AND MAGNET WINDING: ETC.

ILLUSTRATED



CHICAGO
FREDERICK J. DRAKE & CO.
PUBLISHERS

TK 151
.475

COPYRIGHT 1910
BY
HENRY C. HORSTMANN
AND
VICTOR H. TOUSLEY

11-499

© CL.A278565

Oct 20 1911

PREFACE

The object of this work is to instruct the practical electrician in the management, operation and testing of the more important electrical devices now in use.

Almost every line of industry, great or small, now has much to do with electric motors and lights, to say nothing of the ever increasing number of small isolated plants using gas or gasoline engines in connection with electrical generators.

From observation of many such plants in actual operation it has long been apparent to the authors that some hand book giving in a condensed, simple manner all of the instructions needed for the intelligent installation and operation of electrical devices is greatly needed.

The method adopted has been that of familiarizing the student with the underlying principles governing the design of motors, dynamos, arc lamps, etc., rather than to go overmuch into detail on the construction of particular commercial forms. It is confidently believed that the student who has mastered the general theory of dynamos, motors, etc., will have no difficulty in comprehending such variations in their application as he may meet with.

In order to avoid unnecessary bulkiness and to give the reader as much of the necessary information as

possible within the limits of the space, all catalogue cuts have been omitted; it being assumed that the reader is familiar with the general appearance of motors, arc lamps, storage battery, etc.

It is in the hope that this work may meet with the same success and kindly reception as previous efforts of the authors that this volume is offered to the public.

THE AUTHORS.

TABLE OF CONTENTS

CHAPTER I.		Page
The Electric Current		7
CHAPTER II.		
Electrical Units		14
CHAPTER III.		
Magnetism		19
CHAPTER IV.		
Principles of Dynamo Electric Machines		39
CHAPTER V.		
Types of Dynamos		56
CHAPTER VI.		
Principles of Electric Motors—Direct Current		74
CHAPTER VII.		
Types of Motors—Direct Current		80
CHAPTER VIII.		
Principles of Alternating Current Motors		86
CHAPTER IX.		
Types of Motors—Alternating Current		96
CHAPTER X.		
Dynamo Operation—Direct Current		102
CHAPTER XI.		
Operation of Alternators		124
CHAPTER XII.		
Motor Operation		145

CHAPTER XIII.

Transformers151

CHAPTER XIV.

Batteries170

CHAPTER XV.

Arc Lamps184

CHAPTER XVI.

Incandescent Lamps217

CHAPTER XVII.

Nernst and Cooper Hewitt Lamps239

CHAPTER XVIII.

Instruments for Testing243

CHAPTER XIX.

Testing269

CHAPTER XX.

Dynamo and Motor Troubles298

CHAPTER XXI.

Recording Wattmeters307

CHAPTER XXII.

Life and Fire Hazard342

CHAPTER XXIII.

Ground Detectors and Lightning Arresters347

CHAPTER I

THE ELECTRIC CURRENT

By the electric current is meant that agency which comes into action when a circuit containing an electro-motive force is closed. Electro-motive force is, as the name implies, the impelling force, and the circuit is the system of conductors along which alone electrical action takes place. This flow of current is quite analogous to the flow of water in a system of piping or over the surface of the earth. Such a flow of water can take place only when the water is at different levels, or, when from any cause, a difference of pressure exists between different points. When either or both of these conditions exist the flow always takes place in a certain direction, i. e., from the high level or pressure to the lower, and this flow is always more or less diminished by obstacles or resistances. The same observations hold true of electric currents; they flow only in obedience to electrical pressure; they flow always in a certain direction determined by that pressure and the quantity of the flow depends, or is governed, other things being equal, by obstacles which are spoken of as resistances.

We cannot prove, and it is not necessary, that there is any actual direction, or, much less, a change of direc-

tion, or even a flow of current, but the phenomena noticed make the assumption a very convenient one and it is, to say the least, very helpful in the study and application of these phenomena.

Refer now to Figure 1 which shows a common glass jar nearly filled with water and which also contains a small quantity of sulphuric acid and one plate of zinc Z and another of copper C. While the two ends of the wires connected to the plates remain apart there is no flow of current, but an electrical pressure

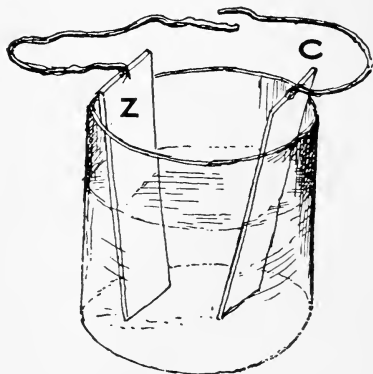

Figure 1

exists, as can readily be shown. As soon, however, as we bring the two ends of wire together a flow of current takes place. It is the high resistance of the air between the two terminals of the wires which prevents the flow of current in this case, just as the resistance of the valve in a water pipe prevents the flow of water when it is closed.

The direction of the flow of current is said to be from the zinc to the copper inside of the cell and from the copper back to the zinc in the exterior circuit or

outside of the cell. In all batteries (a battery is a number of cells coupled together) the copper plate or terminal is spoken of as the positive or + pole from which the current flows and the zinc plate as the negative or - pole toward which the current flows. From the cell shown, which is the simplest of all forms, we

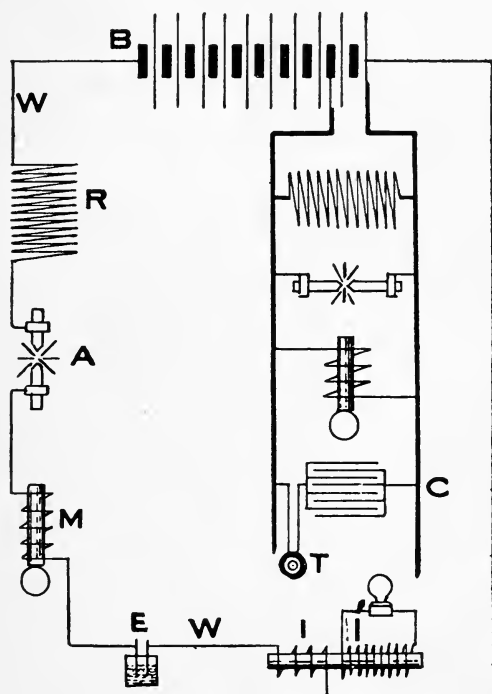

Figure 2

can obtain but a very insignificant current, and that for only a very short time, for reasons to be given later on. If we couple a number of cells together, as conventionally indicated at B in Figure 2, we shall be able to obtain a considerable current. In this representation of a battery the long thin lines stand for the copper plate from which the current flows to the

outside circuit and the short thick lines stand for the zinc element from which the current flows inside of the cell to the copper element.

Figure 2 has been drawn principally to acquaint the reader with the general effects obtainable from the electric current. In the outer system of wires W, W, etc., the same current passes through all of the devices, and this is known as a series circuit. R represents fine wire, which will be heated to redness or even melted if the current is made strong enough. At A is shown the manner in which an arc or a flash may be produced; first bring the ends of carbon or metal together until the current is started, then separate them a little and the current will continue, thus forming a very hot flame known as the electric arc.

If a wire carrying a current be wound about an iron core M, magnetism will be generated and enable the iron bar to attract other pieces of iron. This magnetism will exist only while the current is flowing.

If the current is forced to pass through water, as indicated at E, it will decompose it and this decomposition will be noticeable by the bubbles of gas given off. If the current pass through a suitably prepared bath in which metals are properly connected to the wires, the metal will be eaten away from the positive pole and deposited at the negative.

The arrangement of wires shown at I, I¹ is drawn to illustrate the method of inducing currents of electricity in transformers. When a current is passed around the bar at I a current will be induced in I'. This current will last only a very short time, but if I is connected to a circuit in which the current is contin-

ually changing in value the induction of currents will follow every change in current strength and it is possible to arrange these variations in such a manner that light may be obtained from these induced currents.

The inner circuit shown connected to the battery by heavy lines is known as a parallel circuit, all of the devices being connected in parallel instead of in series as in the other. In such a circuit each device is independent of the others and the current increases in proportion to the needs of the devices connected. The more there are connected the greater becomes the current, but the voltage need not be increased. In a series circuit the more devices there are connected the more cells of battery must be provided to increase the pressure so that the current may remain the same. Only such devices as use the same amount of current can be run in a series circuit.

In the parallel circuit at C there is shown a condenser. A condenser is an arrangement of plates which is capable of taking a charge of electricity at rest much as a jar is capable of taking a charge of water. The positive and negative plates of a condenser are perfectly insulated from each other and a current of electricity cannot pass from one to the other. When, however, the plates are connected to a source of current a small quantity of current will pass into the condenser. Such a charge may be held in a condenser for some time or will pass out of it when the voltage at the terminals is withdrawn or the circuit around the condenser closed. Enough current can be made to pass in and out of a small condenser to affect a telephone receiver T, or a sensitive polarized bell.

CONDUCTORS AND INSULATORS

An appreciable current flow can take place only in a system of electrical conductors. The best conductors are the various metals in the order here given: silver, copper, gold, platinum, tin, lead, etc. The difference in favor of silver as against copper is so small compared to the higher price of silver that the latter is seldom used. A pound of copper will, under the same circumstances, carry about 6 or 7 times as much current as a pound of iron and as this fact makes copper much cheaper than iron, copper is the metal almost universally used for electrical purposes.

It is not, however, sufficient to provide conductors along which the current can flow; it is also necessary to surround these conductors with some material which will prevent the current from flowing anywhere except along these conductors. A bare copper wire lying on some other conducting material can no more be depended upon to carry the current than a lot of broken or disconnected pipes can be depended upon to carry a stream of water. Even under such conditions the current may flow along the wires and the water may flow along the pipes if these happen to offer the easiest path, but in neither case will it be possible to get any work done. To get the proper service from either we must be able to force the flow where our machinery needs it; whatever portion of it we can not so confine is a direct loss.

Such materials as resist the flow of current sufficiently to prevent its escape from the conductors in appreciable quantities are known as insulators. Some

of them are: air, glass, silk, rubber, dry asbestos, porcelain, slate, marble, wood, mica, shellac, paraffine, etc. All insulators to give the best service require to be dry. If they are wet current will leak through the body of those that are porous and over the surface of those that are not. It should be borne in mind that there is no such thing as, either a perfect conductor or a perfect insulator. Every conductor offers some resistance to the flow of current and no matter what the insulator may consist of, if we but make the pressure great enough we can force some current through it.

CHAPTER II

ELECTRICAL UNITS

In order to make any practical use of electricity we must be able to measure it, and for the purpose of measurement and calculation the following units have been adopted by electricians, and in turn legalized by the U. S. government:

The *ohm* as the unit of resistance.

The *ampere* as the unit of current flow or current strength.

The *volt* as the unit of electro-motive-force or electrical pressure.

The *coulomb* as the unit of quantity.

The *farad* as the unit of capacity.

The *joule* as the unit of work.

The *watt* as the unit of power.

The *henry* as the unit of induction.

THE OHM

The ohm is the unit of resistance. Resistance is a property possessed by all materials, but in varying degrees. It always varies inversely as the cross-section of the material; that is, the larger the wire the less will be its resistance and the smaller the wire the

greater will be its resistance. The resistance of all materials increases directly as the length, and is, also, to a small extent, affected by a rise in temperature. This resistance acts electrically much as friction does mechanically; it is very useful in the proper place and very objectionable in the wrong place. It is this resistance in the filament of a lamp that gives us light when current is forced through it, and heat in the heater, but it is also this resistance which causes the loss in voltage or pressure which makes it so difficult to transmit currents of magnitude over wide areas. Resistance tends to diminish current flow and, when great enough, prevents it entirely.

The legal ohm is equivalent to the resistance of a column of mercury 106.3 centimeters long, 14.4521 grammes in mass and at the temperature of melting ice. As an illustration of more practical value: 2 3/10 feet of No. 36 B. & S. gauge wire has a resistance of one ohm; 380 feet of No. 14 wire a resistance of one ohm and 1,000 feet of No. 10 wire a resistance of one ohm.

THE AMPERE

The ampere is the unit of current strength. It expresses the rate of current flow. It is not correct to speak of it as measuring quantity. To obtain the quantity we must multiply the amperes flowing by the length of time they flow. The heating of a wire, the chemical action and the magnetism produced are all due to the amperes flowing in the circuit. The legal ampere is that current, which, when passed through a solution of nitrate of silver, prepared in accordance

with certain specifications, deposits silver at the rate of 0.001118 grammes per second.

It is the current which results from a pressure of one volt acting in a closed circuit on a resistance of one ohm. A 16 c. p. 110 volt incandescent lamp requires a current of one-half ampere; an open, series arc lamp a current of about 10 amperes.

THE VOLT

The volt is the unit of electro-motive-force, or electrical pressure. It is this pressure which is the immediate cause of current flow and we speak of it as of so many volts, just as we speak of steam pressure as of so many pounds.

The volt is defined as the electro-motive-force which will force a current of one ampere through a resistance of one ohm. This is equal to about $1000/1434$ of the electro-motive-force of a Clarkes cell. The common wet carbon battery gives about 1.2 volts; a storage battery about 2 volts per cell.

THE COULOMB

The coulomb is the unit of quantity. It is the current delivered by one ampere in a second. To find the number of coulombs we multiply the number of amperes by the time in seconds. This unit is seldom used.

THE FARAD

The farad is the unit of capacity. Under certain circumstances electrical conductors and certain appliances chiefly known as condensers can be heavily charged with static electricity (electricity in a state of rest) and can be again discharged; and, in fact, if

subjected to an alternating electro-motive-force this charging and discharging is continually taking place. This charge depends upon the nature of the material out of which the condenser is made upon the number and size of the plates and upon the electro-motive-force of the circuit. The more current there is forced into a given condenser the greater will be its potential difference. This can not, of course, be greater than that maintained at its terminals unless a static charge be given.

Such a conductor or condenser is said to have a capacity of one farad, when a charge of one coulomb produces a difference of potential of one volt. This unit comes into use very seldom in ordinary work.

THE JOULE

The joule is the unit of work. It is equal to the energy expended in forcing one ampere through a resistance of one ohm, in one second. This unit is also seldom used.

THE WATT

The watt is the unit of power. Just as the ampere expresses the rate of current flow, without telling us anything about the actual quantity delivered, so the watt measures the rate of doing work, or the rate of energy consumption in the circuit. The watts in any circuit are equal to the volts multiplied by the amperes. An incandescent lamp requiring 110 volts and $\frac{1}{2}$ ampere is said to consume energy at the rate of 55 watts. Seven hundred and forty-six watts equal one horsepower. The watt is a much used unit and charges for use of light or power are usually based

upon watt-hours. The watts supplied, multiplied by the time, measure the power delivered.

THE HENRY

The henry is the unit of induction. It is seldom used in ordinary practical calculations but an understanding of its meaning is important.

The henry represents the induction in the circuit when the induced electro-motive-force is equal to one volt while the inducing current varies at the rate of one ampere per second.

CHAPTER III

MAGNETISM

The simplest form of magnet and also the one with which people are most familiar is the compass needle. This needle is merely a bit of magnetized steel and has the property of pointing toward the north with one of its ends and, of course, south with the other. Such a compass needle is a very convenient instrument to have about and many instructive little experiments can be made with it. If we take a compass and explore any piece of steel that has been lying in a north and south direction, as, for instance some portion of a steel building, we shall quickly see that the north end of the piece of steel has a tendency to repel the north seeking end of the needle, but will attract the south seeking end of the same needle with as much force as it repelled the other end. In making this experiment and in all other similar experiments care must be exercised not to bring the needle, especially if it should not be free to swing, too close to the bar of steel, if this be strongly magnetized, otherwise the powerful magnetism of the bar may overpower that of the needle and reverse its polarity. In such a case the former north seeking end would become the south seeking end.

We have mentioned the needle and the bar as being made of steel because steel differs from iron in that it has the power to retain whatever magnetism it may be charged with for an indefinite time, while iron, especially if it be well annealed and soft, loses its magnetism the instant the magnetizing force ceases to act. A bar of iron will attract the needle as well as the steel but to a lesser extent; with the steel bar the attracting or repelling force will be due to the action of both magnets while with the iron bar it will be only the force of the needle that does the attracting.

Magnets consisting of hardened steel are known as permanent magnets and usually made up either in



Figure 3

horse-shoe shape or in the form of straight bars as shown in the following figures. It is impossible to make a magnet with one pole only. No matter into how many pieces we may divide a magnetized bar, each piece will possess a north and a south pole. This is illustrated in Figure 3 where the different poles are designated by the iron filings which cling to them. If these pieces be all joined again perfectly the intermediate poles will all disappear and there will be only the two poles, one at each end. It is, however, possible to arrange a bar magnet so that it shall have a number of poles throughout its length, even while it remains solid. This is illustrated in Figure 4, where

the two ends of the bar are magnetized in opposite direction so that two poles of same sign are formed in the center and oppose each other.

Consider now the horse-shoe magnet shown in Figure 5. If we take a magnet of this kind and sprinkle a lot of iron filings or small tacks about the ends they will be attracted and form around it in the manner shown. If the magnet is weak it will be necessary to assist the formation somewhat by gently placing the tacks where they will stick. If we now raise the magnet, a large part of the filings or tacks will follow and we can carefully put on a number more, but shall soon learn that there is a limit and that as we put on

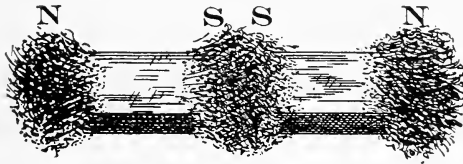

Figure 4

more tacks in one place some of the others will fall off. If we now take the armature A and place it across the pole of the magnet, say at O, by far the greater part of the tacks will fall off. The reason for this is that the magnetic flow or flux, as it is usually termed, follows along the lines of least resistance like any other flow. The armature offering a path of much lower resistance than the partially disconnected tacks simply shunts the flow around them and they cease to be attracted.

The magnetism is conceived to consist of a flow of lines of force as indicated in Figure 6. These lines are supposed to leave the magnet at the north pole N

and passing through the intervening space, to return to the south pole S of the same magnet. If we take a compass and beginning, say at the right hand end, move the needle along the path of the lines of force

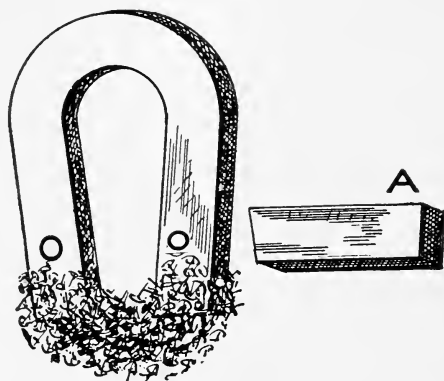

Figure 5

we shall see it align itself to them and as it is brought to the other end of the bar the other end of the needle will meet it. The flow of these lines of force is greatly facilitated by iron or steel but there is no medium

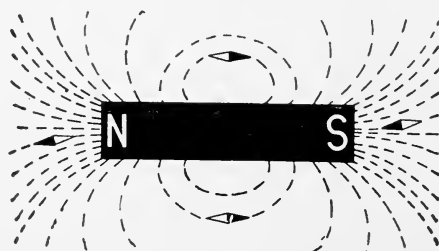

Figure 6

which can be interposed that will prevent the flow entirely; in other words, there is no insulation for magnetism. It is, however, possible to shield bodies from it by introducing an easier path for it as we have seen in the experiment with the tacks.

Permanent magnets are generally made by "touching," that is, a magnet is wiped across the end of the bar which is to be magnetized as shown in Figure 7. If the inducing magnet is strong it is not even necessary to bring it in contact with the bar to be magnetized. One must proceed in a systematic manner, however, that is, always touch the same end of the bar to be magnetized with the same end of the magnetizing bar and move it over the bar in the same direction. If this is not done one "touch" will neutralize the other and the result will be either no magnetism at all or at best but a very little of it.



Figure 7

Permanent magnets are often made up of a number of bars of equal length and shape fastened together and are then known as compound magnets. Permanent magnets can be demagnetized by heating to a red heat.

ELECTRO-MAGNETS

Electro-magnets differ from permanent magnets; first, in being made of soft iron instead of steel; second, the magnetizing force is not another magnet, but a current of electricity; third, the magnetism lasts only while the current is circulating in the wire wound

around the core; fourth, the strength of magnetism is variable and within certain limits in proportion to the current flowing; fifth, the polarity, or the direction of the lines of force changes with the direction of the current and can therefore be instantly reversed.

We may now consider the generation of magnetism by means of the electric current.

If we assume the black circle (Figure 8) to be an electrical conductor in which the current is flowing in the positive direction (i. e., away from us) that conductor will be surrounded by lines of force circling about it in the direction of the arrows shown. The number of lines of force will be directly in proportion



Figure 8



Figure 9



Figure 10

to the current strength (number of amperes) in the circuit. If we reverse the direction of the current the lines of force will circulate in the opposite direction. If we lay two wires, carrying current in the opposite direction, side by side as shown in Figure 9 the lines of force will repel each other and tend to separate the wires; if, however, these wires be carrying current in the same direction the lines of force will act in harmony and tend to draw the wires together as in Figure 10. These lines of force are, of course, only conceptions, but they are very natural ones. If wires such as those shown be thrust through a piece of paper or cardboard at right angles to it and if iron filings be

sprinkled on the paper and near the wires, these filings will have a tendency to arrange themselves in circles around the wires as outlined in the figures. In order to properly get such an outline it will be necessary to gently jar the paper several times thus temporarily annulling the friction which tends to hold them in their place, so that they may more readily align themselves to the lines of force surrounding the wire.

If we now wrap a wire carrying a current of electricity around a bar of iron as shown in Figure 11 these lines of force will pass through the iron as depicted and we shall have a similar circulation of lines of force in this case as was observed in a magnetized



Figure 11

bar of steel. Magnetism is also produced by a coil of wire wound in this way that contains no iron but the magnetic flux will be much less. This is due to the fact that the iron offers a much lower resistance to the flow of lines of force than does air and hence their number is greatly increased. The law that governs magnetic flux is exactly similar to Ohm's law which governs current flow It is:

$$\text{Magnetic flux} = \frac{\text{Magneto-motive force}}{\text{Magnetic resistance}}$$

The magneto-motive-force is produced by the current circulating in the coil of wire and so far as mag-

netism is concerned it matters not at all whether the 100 amperes circulate once around the bar or certain air space or whether one ampere circulates 100 times. The magnetizing force is always proportional to the product of the number of turns of wire and the current flowing in the wire. This product is generally known as the "ampere turns."

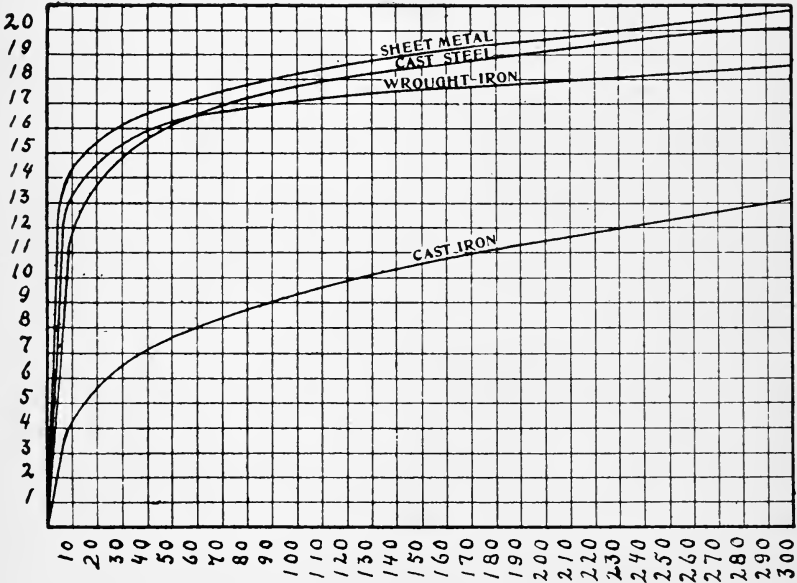

Figure 12

The magnetic resistance varies with the material used inside of the coil, or helix, as it is often termed. It is greatest with air (with exception of a few substances that need not be considered in practical work) and least with well annealed wrought iron. The magnetic resistance also decreases as the cross-section of the iron increases and, conversely, increases as the cross-section of the iron decreases, i. e., the core be-

comes smaller. The above is rigidly true only for air and approximately only within certain limits for iron. The conductivity of iron for lines of force has a limit and if we attempt to force too many lines of force through a given core a point will soon be reached where the iron assists the magnetization only to a very small extent and any further increase in the strength of that magnet will be little more than in the ratio that is possible for air. This is illustrated by Figure 12 which shows graphically, by means of the curves the relative magnetism produced in different kinds of iron and steel. The highest magnetization is possible with annealed sheet iron, the lowest curve shown is for cast iron. The numbers along the bottom line indicate the relative ampere-turns or magnetizing force and those along the vertical line the resulting magnetic flux or magnetism.

We have seen by Figure 11 how the lines of force produced by currents of electricity produce magnetism, either in the surrounding air or in a bar of iron. If we now coil another wire about the bar and send current through it in the opposite direction, or reverse a part of the winding in any coil so that current will circulate in the opposite direction we shall neutralize the influence of the first coil; that is, the lines of force produced by the two windings will oppose each other and there will be no magnetism if they are exactly equal to each other. If they are not equal then the resulting magnetism will be proportional to the difference in strength of the two opposing coils. It must not be understood that the number of turns of wire, size of wire, and current in the wire must be the

same, but that the "ampere turns" in the two coils must be equal. To find the difference we must subtract the ampere turns in the weaker coil from those in the stronger. It is not possible to quite neutralize the action of one coil by the action of the other but we can come very close to it and the remaining magnetism can be detected by the most delicate instruments only. Such a winding is known as "differential" and is made use of in many dynamos, motors, arc lamps, measuring instruments, etc.

We may now briefly consider the forms of magnets suitable for different purposes. The attraction of an

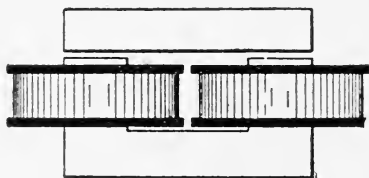

Figure 13

electromagnet for its armature varies as the square of the number of lines of force passing through both. If then we desire to obtain the greatest traction, we must see that we obtain the greatest number of lines of force that a given current can produce. For this purpose it is necessary to arrange the magnetic circuit so that it shall have the least possible resistance. This we obtain when we make the cross-section of the core large enough so that the magnetization need never be pushed beyond the nearly straight rise of the curves shown in Figure 12. The iron core should also be made as short as possible. We must, however, have space to place a certain number of turns of wire

around the core and it must be long enough to allow this. It need not be a bit longer. We must not, however, imagine that very much can be gained by crowding the windings together as shown in Figure 13, for in such a case the outer layers of wire become very long and introduce unnecessary resistance into the electrical circuit and also, this construction makes necessary an unusual length of the yoke. As a general rule it will be found advisable to make the thickness of the coil about equal to the thickness of the core; to make the yoke just long enough so that the coils

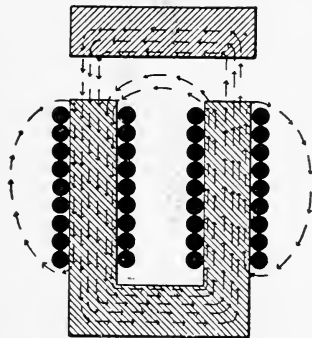

Figure 14

will not interfere with each other when they are being placed in position and to make the core long enough to accommodate the necessary wire.

In Figure 14 we have shown a cross-section through an electromagnet showing the windings surrounding the iron and a general scheme of the lines of force existing in such a magnetic circuit. The armature is shown out of contact with the magnet and there is also indicated a considerable leakage of lines of force. If the armature is brought down in contact with the core it will have a double effect upon the

lines of force; first, these lines will be increased in number because the resistance of the magnetic circuit has been lowered; second, because the leakage also is very much reduced. Reasoning from these facts we can readily see that the best proportions for the limbs of a magnet depend somewhat upon the use it is to be put to; whether the armature is to work close to the core, i. e., if the range of action is to be small the tendency to leakage will be small and we can let the poles of the magnet come reasonably close to-

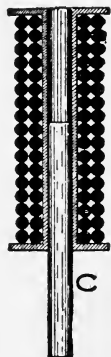

Figure 15

gether and make the magnet very short, but if the range of action is to be long we must separate the poles more and make the cores longer so as to lessen the tendency to leakage.

Different arrangements of the magnetic circuit are also necessary to provide for different speeds of action. The solenoid, Figure 15, has a very long range of action, it tends to pull the core C up into the coil but this action is, on the whole, very slow and not very sensitive to small currents.

Figure 16 shows a type of magnet that is very sensitive to small currents. The main yoke is a compound permanent magnet consisting of a number of pieces of magnetized steel fastened together. On the ends of these permanent magnets are fastened soft iron extensions and on these the magnetizing coils are wound. This form of magnet was invented by Prof. Hughes for use with a printing telegraph and means were provided to bring the armature tight against the poles where it would stick, held by the

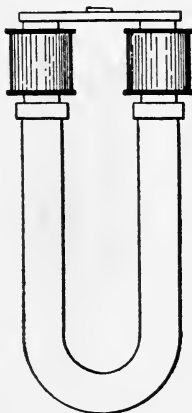

Figure 16

magnetism of the steel bars which also magnetized the soft iron ends. It was the function of the electric current circulating in the coils around the soft iron extension to oppose or neutralize this magnetism and thus release the armature. In this way the armature could be very quickly controlled and with very small currents.

For quick action the magnetic circuit should not be too good. The cores should be short, the winding extra thick upon them and the air gap between the

cores and the armature considerable. If the armature comes in contact with the cores the demagnetization is greatly retarded as this helps increase the hysteresis, of which we shall speak later.

A special form of magnet that is often used is diagrammatically shown in Figure 17. In this form of magnet the armature *A* is continually under the influence of the permanent magnet *M*. While current is passing through the coils in one direction one of the cores will attract the armature and the other will repel it. If the current in the coils is now reversed

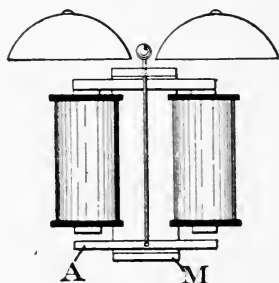

Figure 17

the magnetism will also be reversed and the armature thrown the other way. The end that before was attracted will now be repelled and the one that before was repelled will now be attracted. Under the influence of an alternating current the armature will move in time with the current and cause the bell to ring as long as the current flows. This form of magnet is also very sensitive and such a bell and all apparatus of this kind is known as "polarized."

The cores for alternating current magnets require to be laminated and thoroughly annealed. A laminated core is made up of a number of thin plates as

in Figure 18. The core is subdivided in this way as otherwise currents would be induced in the iron and these currents would heat the iron and cause considerable waste of energy. The oxidization on the plates introduces sufficient resistance to prevent the circulation of such currents.

There is another source of heating of alternating current magnets and this is known as "hysteresis."

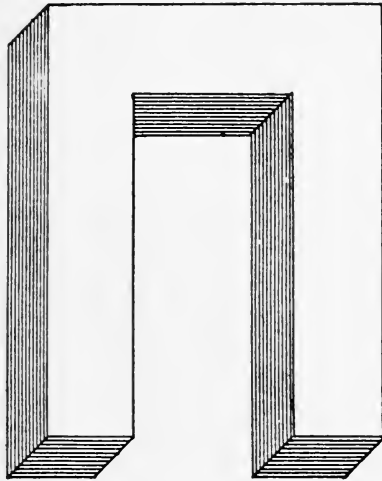

Figure 18

Every piece of iron has a tendency to retain some of its magnetism and this magnetism must, when the direction of current is changed, be dispelled. This effect is small with very good annealed iron but quite great with inferior iron or steel.

There is also assumed to exist a sort of friction between the molecules of iron of which every bar consists and that, with changes in magnetization these molecules are forced to align themselves in a different manner; thus if these changes are rapid and continu-

ous the friction of the molecules will also cause the iron to heat.

Figure 19 shows the waste of energy due to residual magnetism of different kinds of iron and steel.

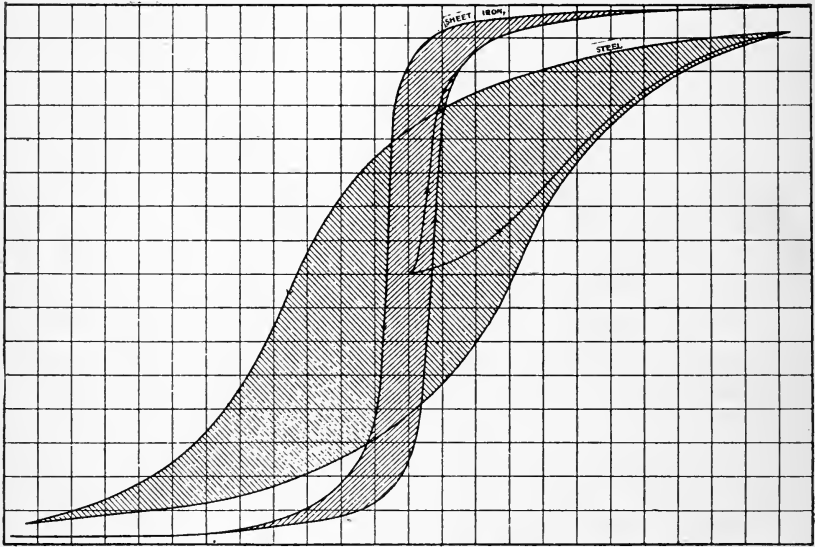

Figure 19

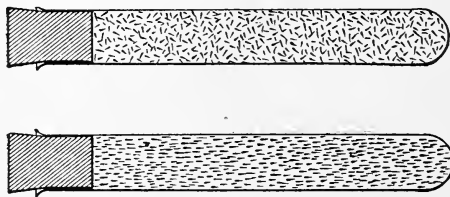

Figure 20

The shaded portion between the two sets of curves showing the relative amount of magnetizing energy wasted.

Figure 20 illustrates the molecular friction in an iron bar. With each reversal of current the molecules are supposed to reverse their positions.

WINDING OF ELECTROMAGNETS

We have seen that currents of electricity circulating in the wires wound around an iron core or bar produce magnetism and it behooves us now to learn the most advantageous way of applying such currents so as to obtain the greatest amount of magnetism from a given current. We know from Ohm's law that the current increases as the length of the wire in the circuit decreases. If then, considering a fixed electromotive force or E.M.F., we wind more coils around a given core, the current becomes steadily less as the number of turns increases. At the same time, however, the effect of what current there is increases because it circulates around the core oftener. If we assume the resistance of the wire around the core to be the only one influencing the current we shall obtain the following results. Suppose we have ten turns of wire, a resistance of one ohm and a pressure of ten volts, this will give us a current of ten amperes and consequently a magnetizing force of 100 ampere turns. Now double the number of turns, the resistance will be double and consequently the current only 5 amperes, but twenty times 5 again equals 100. So long as we use the same size of wire it will matter not a bit how many turns of wire we take, we shall still be able to get the same number of ampere turns from the same battery unless, however, the length of the wire necessary to make a turn increases very much as it will if a large number of layers are wound over each other. As the current decreases with more turns, while the E.M.F. remains constant throughout, it is

evident that we are getting our magnetism with less and less expenditure of energy as we put on more coils. How much energy it is advisable to consume in producing a certain flow of magnetism depends on circumstances. If power is cheap we can use a few turns of wire and a large amount of current, if it is dear we shall find it to our advantage to provide more windings and thus save energy.

The determining factor of the winding is, however, not alone the amount of energy we are willing to expend in the coils, but the temperature we are allowed to maintain. The magnetism created in any coil increases directly as the current but the heat generated increases as the square of the current. If in any coil we double the current we double the magnetism and at the same time increase the heating four-fold. The heating of the wires must therefore never be lost sight of.

Let us examine now how a change in the size of wire affects the economy of winding. If we take a coil containing say 100 turns of wire and place in the same space a wire of half the diameter of that of the first coil (neglecting differences that may be caused by variations in the relative thickness of the insulation) we shall obtain four times as many turns and the wire will have but one fourth of the cross-section of the former. Its total resistance will therefore be sixteen times as great as that of the old coil and from the same voltage it will receive but one sixteenth of the current; there will be, however, four times as many turns and the magnetizing force will therefore be one fourth that of the old coil. As the current is here

but one sixteenth of the former the energy expended per ampere turn will be but one fourth of the former. In this case again we receive from the energy expended per watt, a much greater amount of magnetism, but in order to get the same total amount we must increase the E.M.F. in proportion to the increased resistance divided by the increased number of turns, in this case sixteen divided by four.

We cannot always assume, however, that the coils of the magnet are the only resistance in the circuit. This would apply very well to the field coils of dynamos or the regulating coils of arc lamps, but not at all to telegraphy for instance. Here the magnets are long distances apart and far from the source of current and economy demands the use of small wires and these have high resistances. In such cases only a part of the energy is expended in the magnet coils. To illustrate the most advantageous winding of magnet coils for these conditions, let us assume the following case. Suppose we have an E.M.F. of 100 volts, a line resistance of sixteen ohms and a magnet which is wound with 100 turns of wire which just fill out the space allotted to the coils and which have a resistance of one ohm. This gives us a total resistance of 17 ohms and with 100 volts we therefore obtain very nearly 6 amperes making, 6 times 100 or 600 ampere turns. The energy consumed in this case will be about 600 watts. If we now try a wire of half the diameter of the former we shall in the same space have 4 times as many turns and each turn having only $\frac{1}{4}$ th the cross-section will have 4 times the resistance, so that the total resistance of the coil will be 16 ohms and the

total of line and magnet 32. Our current will now be about 3.2 and give us 1280 ampere turns. The energy (in watts) consumed is now 320. For a third trial let us again take a wire of half the diameter of the former. The number of turns will now be 1600 and the resistance of the coil 256 ohms, giving us a total resistance of 272 and a current of about .4 amperes and a total of 640 ampere turns. The energy consumed in this case will be only 40 watts. Similar results will be obtained with all variations in diameter of wire and an inspection of these results will illustrate to us the rule, by which most designers of magnets for such work are guided, which is: make the resistance of the magnet coils in the circuit equal to the resistance of the line. If there are many magnets their combined resistance is made equal to that of the line. It must be understood of course that only copper wire of the highest conductivity should be used.

CHAPTER IV

PRINCIPLES OF DYNAMO-ELECTRIC MACHINES

The dynamo consists of two main parts, one of which is a huge electro-magnet, in the simpler forms approximating closely in shape to the horse-shoe magnets with which we are familiar. This magnet in the

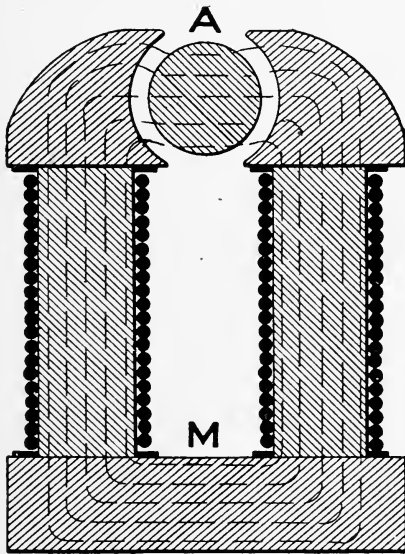

Figure 21

dynamo is known as the “field magnet” and is often spoken of merely as “the fields.” In the simpler forms of generator these fields are usually stationary.

The other part of the dynamo is known as the armature. In all machines in which the fields are station-

ary the armature is made to revolve. In Figure 21 the fields of the dynamo are designated by the letter M and the armature by the letter A. Upon the iron core of the fields are always wound a number of turns of wire as upon any electro-magnet, and in this wire currents of electricity circulate, producing lines of force, just as in the different types of electro-magnets we have discussed in the previous chapter.

In the dynamo the electro-motive-force is developed by "cutting" lines of force. Lines of force are said to be "cut" when a conductor of electricity is moved in a magnetic field in a direction at right angles to the lines as indicated in Figure 22. Such a field is shown in Figure 22 between S and N and if the bar be moved through this field at right angles to the lines of force an E.M.F. proportional to the number of lines of force cut per second will be generated. No current will be generated in the bar as shown as it does not form an electrical circuit; but the fact that an E.M.F. exists could be readily shown by connecting a voltmeter across the ends of the bar. The direction of the flow of current generated depends upon the direction in which the lines of force are cut. By reversing the direction of motion of the bar, or by reversing the direction of the lines of force, i. e., reversing the current which produces them, the direction of the flow of current in the bar will be reversed.

The direction of the flow of current induced in any moving conductor may be determined by the following method: Place the thumb and first two fingers of the right hand in such a position that each forms a right angle with the others as shown in Figure 23. If the

thumb points in the direction of motion of the moving wire and the first finger in the direction of the lines of force, or from the north to the south pole of the magnet, the third finger will point in the direction of the flow of the induced current.

If the bar in Figure 22 is moved slowly the E.M.F. generated will be but small. If the number of lines of force remains constant, the E.M.F. will be directly proportional to the speed with which the bar is moved. If the speed of the bar remains constant the E.M.F.

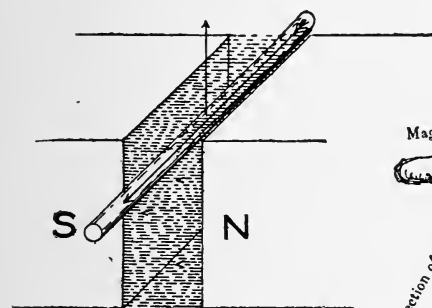

Figure 22

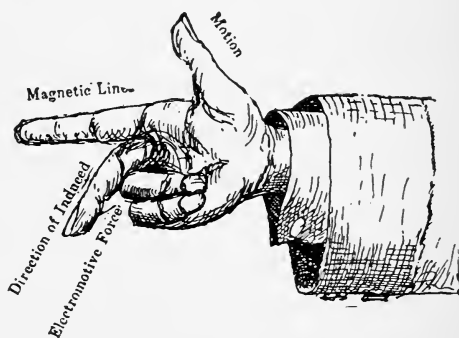

Figure 23

will vary directly as the lines of force vary. We can therefore raise or lower the E.M.F. of any dynamo by varying either the speed of the moving conductors or the intensity of the magnetization of the fields or by both.

An E.M.F. of one volt is obtained for every 100,000,000 lines of force cut per second. If therefore the gap in the iron of the fields has a cross-section of 100 square inches, and the magnetization is equal to 20,000 lines per inch, the bar would have to cut

through this field 50 times per second to generate an E.M.F. of one volt.

The generation of E.M.F. in this way is known as electro-magnetic induction.

Figure 24 represents a coil of wire the ends of which are connected to the two collector rings 1 and 2. Brushes bearing upon these collector rings connect the coil to the external circuit C. If now this coil of wire were revolved around an axis indicated by the dotted line through the center of it and in the

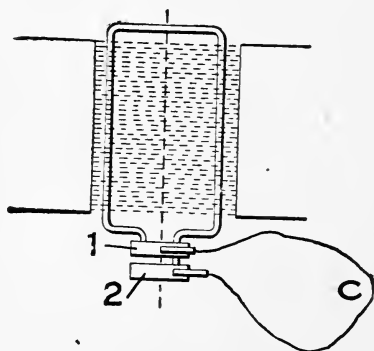

Figure 24

magnetic field, it would generate a current which would manifest itself in the outer wires C, either by heating them or by its effect upon instruments we may place in the circuit. We can get a clearer idea of the nature of this current and the laws governing it by reference to Figure 25 which shows an end view of the same coil of wire.

Let the points 1 1¹ represent opposite sides of the coil and let them revolve at a uniform rate of speed; they will then successively move to the points 2 2¹; 3 3¹; 4 4¹ until 1¹ is at the point now occupied by

1. The wires will in this time have made one half revolution. We have seen that the E.M.F. generated is proportional to the rate of cutting lines of force. We can see by an inspection of Figure 25 that the rate of cutting lines of force is not uniform, for at 1, for an instant the wire is moving practically parallel

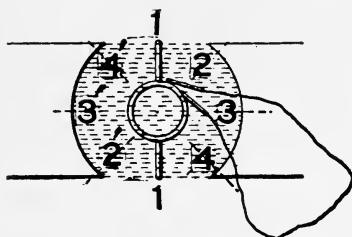

Figure 25

to them and is not cutting any. Also during $\frac{1}{8}$ of one revolution from 1 to 2 it is not cutting nearly as many lines as during the time it travels from 2 to 3. In fact while the wires are at the exact points 1 1', no E.M.F. is generated, but as they pass this point it begins gradually to rise until 1 is at 3 when it begins

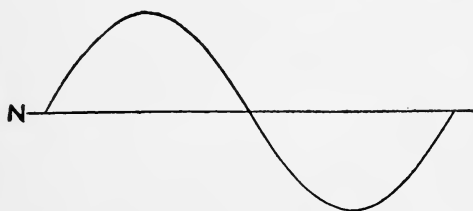

Figure 26

gradually to fall until 1 is at 1' when it is again at zero. When 1 has passed the point now occupied by 1' the E.M.F. again begins to rise but in the opposite direction, for the lines of force are now being cut in the opposite direction. The rise and fall of E.M.F. or current in an armature coil operating in this man-

ner can be illustrated by mean of "curves" as shown in Figure 26. Everything above the neutral line N being taken as representing E.M.F. in one direction and everything below as in the opposite direction. These curves show us also that the currents actually generated in a dynamo-electric-machine are alternating in direction and variable in strength. Alternating currents are not, however, always desirable and it becomes necessary to rectify them so as to obtain continuous or direct currents. For this purpose a commutator is provided.

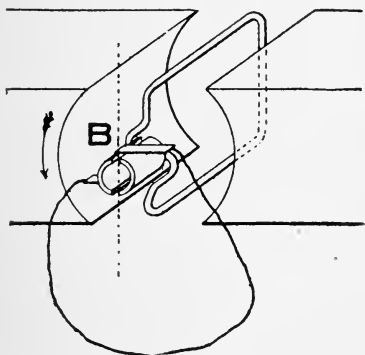

Figure 27

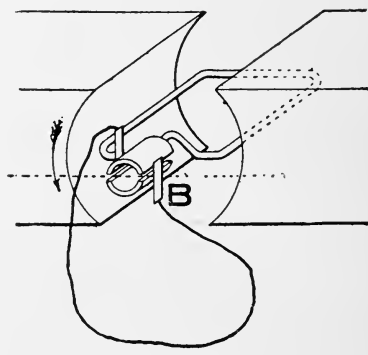

Figure 28

The nature and general construction of the commutator can be seen from Figure 27. It consists in these simple cases of two sections of copper connected to the terminals of the coils arranged as an armature. If the coil equipped with such a commutator is now revolved, it will be seen that just at the time when the open section of the commutator is in line with the dotted line in either one of the figures, the brushes B, which bear upon the commutator and connect it with the exterior circuit are in a position to change

from one section to the other. If the brushes are properly set this will occur at the precise moment when the coil is at the point where it is generating no current as in Figure 27. This is the point at which the current in the armature (coil of wire between the pole pieces) changes in direction.

The current in the armature continues to alternate, i.e., change in direction, at every half revolution, but by means of the commutator the coils are disconnected from one side of the external circuit and connected to the other so that the current in the exterior circuit remains always in the same direction. The E.M.F. or current generated by an armature containing only

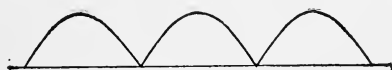

Figure 29

one or a few turns of wire like the one shown would still produce a pulsating current and this current would be represented by such curves as are shown in Figure 29. These currents are all in one direction but vary in strength from zero to the maximum of which the machine is capable.

It will be noticed that the brushes, during the moment they are changing from one commutator segment to the other, are in contact with both of them. It could of course be arranged to avoid this by making the brushes narrow and the space or insulated material between the two segments wide so that the brushes would leave one section before they came in contact with the other. This would, however, cause

an opening of the circuit every time the armature made a half revolution and would result in very unsatisfactory lighting and motor service besides causing very annoying and destructive sparking, as every break in an electric circuit is accompanied by an arc which rapidly eats away copper and insulating material. The brushes connecting together the two segments, it will be seen by inspection of Figure 27, cause the coil to be on short circuit during the time that the brush is in contact with both of them. If this happens while the coil is in a position where it is not generating any E.M.F. and consequently no current is flowing no harm will be done; but if this occurs at a time when the coil is in an active part of the field and generating, a very considerable current will be produced because the resistance of such a coil is usually very low. This current will heat the wire and cause considerable waste of energy,—energy that should appear in the external circuit, but now does no useful work. Aside from this waste of energy and troublesome heating of the armature, when the brush breaks contact with one of the segments, this current will be broken and manifest itself in the form of a spark which, recurring often, will quickly destroy the commutator.

Not only this, but the commutator, if the position of the brushes is very wrong, as in Figure 28, would fail of its purpose and not rectify the current at all. With a single coil and the brushes set as in Figure 28 the current would be graphically represented by curves such as shown in Figure 30, it would still be an alternating current changing in direction in an

irregular way. In practice armatures do not consist of a single coil and only in very exceptional cases would these considerations in the extreme form apply. The commercial armature has a greater number of turns of wire and for bipolar, or the simpler machines,

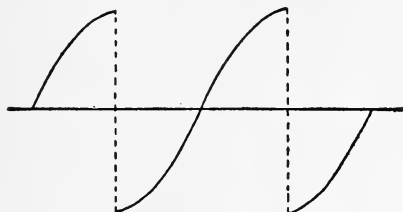

Figure 30

is made up either as shown in Figure 31 or diagrammatically in Figure 32 which is known as the gramme ring type of armature, or as shown in Figures 33 and 34 which is known as the "drum" armature.

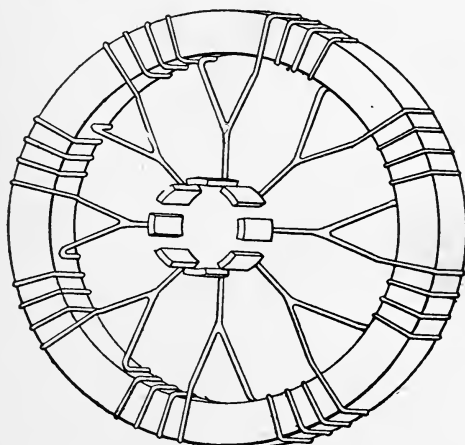

Figure 31

By reference to Figure 32 we can continue our study of the armature in a more commercial form. By noting the position of the brush B we can see that it is about to short circuit the coil connected to the two

segments to which it is nearest. This coil is, however, only a small part of the whole and a wrong placing of the brushes would not have the effect outlined before in regard to armatures having but one coil. No matter how the brushes may be set, they short circuit only one coil each and therefore only a small part of the current is ever broken or changed in direction at one time. As the resistance of such a coil is, however,

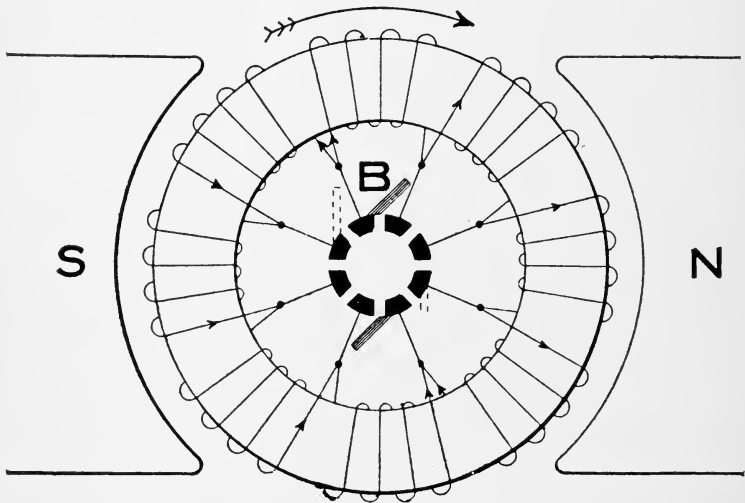

Figure 32

very low the current generated in it is, if it is in an active part of the field at the time, quite sufficient to cause trouble, which usually indicates itself by more or less severe sparking. If the coil is located in the neutral part of the field as that of Figure 32, for instance, there will be no sparking. The smaller each individual coil is made the easier it becomes to realize this condition and for this reason dynamo armatures are generally made up of a large number of coils, and

of course a corresponding large number of commutator segments.

The position of the brushes also has a great deal to do with the E.M.F. generated by the dynamo. To comprehend this let us again refer to Figure 32. The lines of force are passing through the fields and armature in a certain direction, from N to S. We know that the direction of the current depends upon the direction in which these lines are cut by the wires. As the armature is revolving always in the same direction those lines at S are cut in an opposite direction

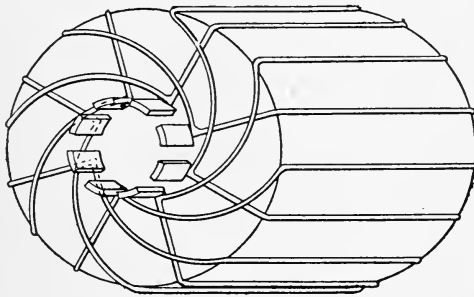

Figure 33

from those at N, consequently the currents generated in the two halves of the armature are flowing in a direction towards each other; this causes them to meet at the positive brush, flow out through the circuit and return to the negative brush, dividing again in the armature. In this way it can readily be seen that the two halves of the armature are in parallel. Now let us move the brush one section forward. Before, we had two coils in the neutral part of the field, generating no current, and three coils under the influence of each field doing active work. Now we have still two coils in the neutral field, idle, and the currents in each

direction are generated by two coils under the influence of each field and one under the influence of the the other; but this latter coil is not generating in harmony with the other two, it is actually opposing them as it is under the influence of the opposite field. This position of the brushes is therefore not only the cause of much sparking but also reduces the voltage of the dynamo. By shifting the brushes, forward or back,

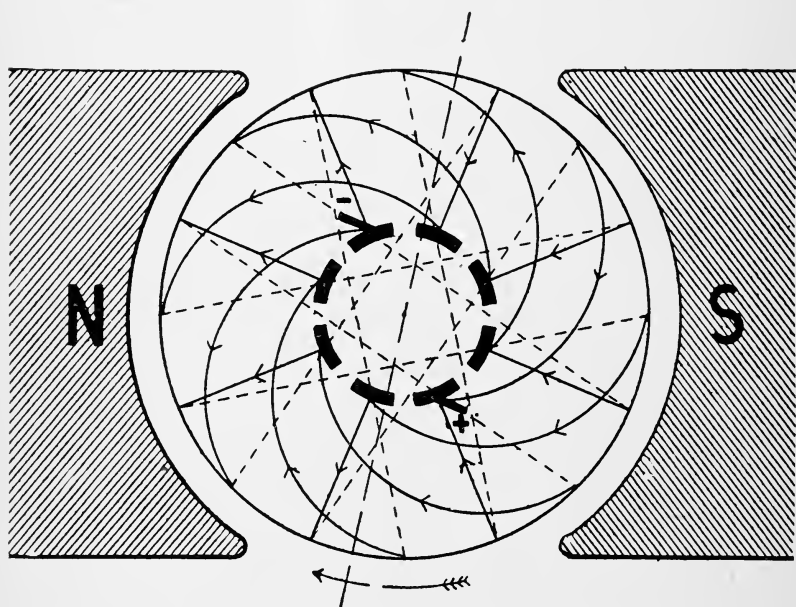

Figure 34

until they are at right angles to the neutral line the voltage can be reduced to zero. If the brushes are shifted still farther the voltage will again begin to rise but in the external circuit current will be in the opposite direction.

In present day practice the brushes are used to regulate the voltage of dynamos only in exceptional cases which will be considered in another chapter. The

necessary regulation is almost invariably brought about by means of a variable resistance or "rheostat." Such a rheostat is cut into the field circuit of a dynamo as shown in Figure 35 which shows a diagram of a simple shunt dynamo, A being the armature, F the field wires, R the rheostat and L the exterior or lead wires of the dynamo. When the machine is in operation current circulates around the fields and through the wires of R. The arm of R is a conductor

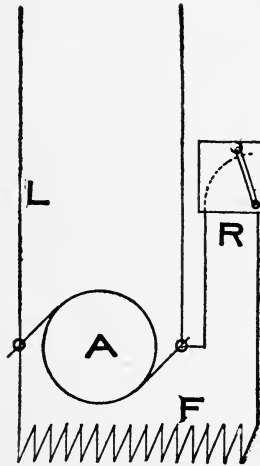

Figure 35

and is movable. In the position shown the current in the wires must traverse the greater part of the wires in R. If the arm of R, however, is moved to the left it gradually cuts out coil after coil until when it arrives at the last notch all of the resistance of R is out of the circuit. The resistance of the circuit is then at its lowest and consequently the current at its highest value and the field the strongest. By moving the arm in the opposite direction we cut more re-

sistance into the circuit and thus weaken the fields of the dynamo.

By moving the bar in the proper direction we can therefore increase or decrease the current strength in the fields and thus change the number of lines of force in the armature and these in turn (speed of armature remaining unchanged) will govern the E.M.F. of the generator.

The current flowing in the external circuit depends upon the E.M.F. and the resistance in the circuit. The current is all generated in the armature and of

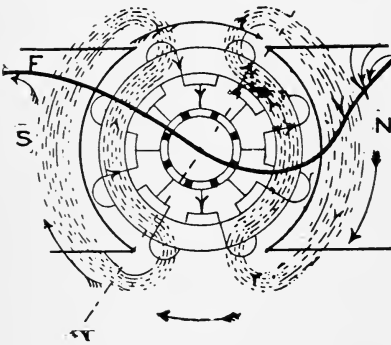

Figure 36

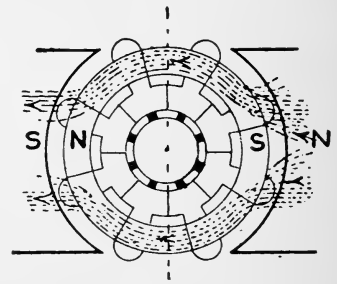

Figure 37

course all passes through it. And this current also makes a magnet out of the armature and the resulting magnetism opposes the magnetism of the fields to a certain extent as we shall see by reference to Figure 36. We can determine the direction of current in an armature by the following rule which has already been given but is repeated here for convenience of the student. Grasp the north pole of the dynamo with the right hand arranged as in Figure 23. Let the index finger point in the direction of the lines of force and the thumb in the direction of motion; the middle fin-

ger will then point in the direction the current is said to be flowing. With condition as shown in Figure 36 the current will be flowing around the armature as indicated by arrow points. Current flowing in this direction will produce lines of force in the armature as indicated by the other arrow points. It will be noted that these lines of force oppose those coming from the N pole to a certain extent. As lines of force can never intersect each other the result of this opposition is that the lines of force which pass through the armature and induce poles in it as shown in Figure 37 while no current is flowing in the armature, are deflected to a certain extent as shown in Figure 36.

Figure 36 shows the counter-magnetization of the armature which results in deflecting the lines of force from the fields somewhat in the direction of motion of the armature. In actual practice the lines of force from the fields reverse those of the armature but are deflected by them and the general trend of the resultant lines of force is indicated by the curved line F, Figure 36.

The neutral point or point at which the brushes must be set for least sparking is therefore no longer in the center between the two pole pieces as in Figure 37, but is shifted somewhat in the direction of motion of the armature as in Figure 36. If we reverse any one of the conditions the current will be reversed but the same relation between shifting of the neutral point and direction of motion will always hold. The counter-magnetization of the armature increases as the current increases and therefore it becomes necessary to shift the brushes in the direction of motion as the load

increases and in the opposite direction as the load decreases.

It is evident that this shifting of the brushes which becomes necessary when the current flow in the dynamo changes, depends almost entirely upon the relative strength magnetically of the fields and armature. If the machine is so constructed that the magnetism of the armature is very strong, then, as the current increases the magnetism will increase and greatly shift the neutral line and make necessary considerable shifting of the brushes. But if the fields are very strong compared to the armature the latter will have but little effect and but a very little shifting of the brushes will be necessary.

In connection with dynamos two terms are often used erroneously as having the same meaning. These terms are electro-motive force or E.M.F. and difference of potential or P.D. for short. Strictly speaking, the term E.M.F. refers only to the greatest difference of potential the machine or battery can produce and this P.D. can exist only while an infinitesimally small current is flowing. Whenever any appreciable current is flowing there is always a loss of potential which is always equal to $I \times R$. To get the maximum voltage of a dynamo we must therefore arrange that no current except that through the voltmeter be flowing. In a poorly constructed armature the difference between E.M.F. and difference of potential is considerable.

Aside from the foregoing there are many other points about dynamos that require explanation but these can more readily be treated in connection with

the particular type of machine in which they are of greatest importance.

In general a good dynamo has a large number of commutator sections. (To avoid sparking.) A magnetically weak armature and strong fields. (To avoid shifting of brushes.) The fields are wound with many turns of fine wire. (To save energy. See chapter on magnetism.) A small air gap between fields and armature. (To prevent leakage and unnecessary magnetic resistance.) The ends of pole pieces not too close together. (To prevent leakage around armature.) Large wires on armature. (To prevent loss of voltage and heating.)

CHAPTER V

TYPES OF DYNAMOS

The oldest type of dynamo is shown diagrammatically in Figure 38. The use of this type is generally restricted to direct current arc lighting. It is known

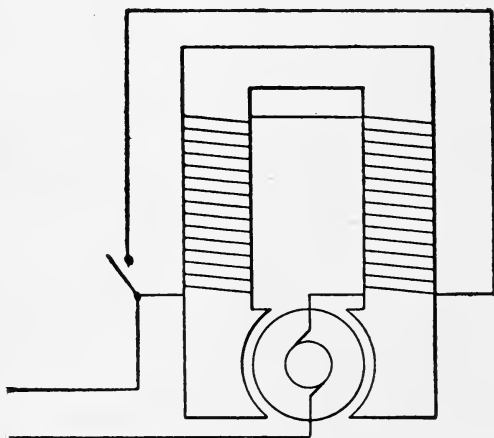

Figure 38

as the series dynamo, the same current passing in series, first through the armature, then through the fields. Such a machine cannot be used with a variable current because the strength of the fields would be constantly fluctuating. Whenever there would be an increase of current strength there would also be an increase in voltage and with a decrease in current strength there would be a drop in voltage. As the potential of series arc circuits is generally very high,

shunt wound dynamos would require a great length of very fine wire and consequently would be very expensive and also very likely to be damaged. This is one reason why series dynamos are in special favor in connection with series arc circuits.

The regulation of this type of dynamo always has as its object the raising of the E.M.F. as more lights are cut into the circuit and a corresponding lowering of it as lights are cut out of the circuit, so that the

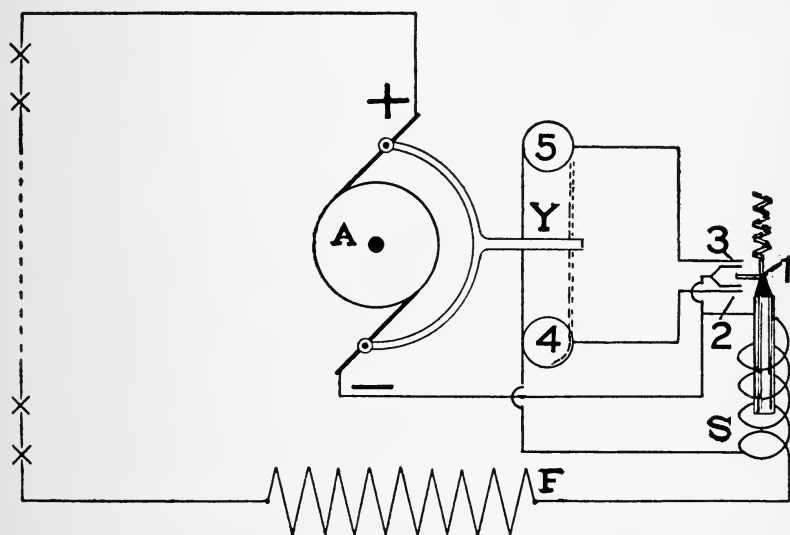

Figure 39

E.M.F. is always at its proper value in regard to the resistance of the circuit to cause the necessary current to flow. This regulation is generally brought about in one of the following ways: By shifting of the brushes, by commutation of the fields, or by a combination of these two methods.

The method employed of shifting the brushes automatically is diagrammatically illustrated in Figure

39. The total dynamo current passes from the positive pole of the armature A to the lamps, thence to field F, solenoid S and negative pole of dynamo. We know that the solenoid has power to control the position of the core within it. The stronger the current the farther will the core be pulled in in opposition to the supporting spring. This core is so arranged that with the normal current strength the extension 1 rests about midway between the points 2 and 3. If now there is a slight increase in current strength, as when a lamp is switched out, the core will be drawn downward and close an electric circuit at 2. This circuit is a shunt to the solenoid and requires but a small current. When it is closed current passes through the clutch 4 and this (by a mechanical contrivance not shown) causes the yoke Y to be drawn over so that the brushes are shifted in the direction which causes a lowering of the voltage and a decrease in current strength. As soon as the current goes back to its normal strength the circuit at 2 is again open and the brushes remain at rest until another change in current strength causes the solenoid to change its position. If the current becomes too weak the spring draws the solenoid up until the circuit at 3 is closed and the brushes shifted in the opposite direction by means of clutch 5.

The principle of varying the E.M.F. by field commutation is illustrated in Figure 40. The automatic control is not shown and instead hand control is used. By moving the lever L to the right or left more or less of the field winding can be cut into the circuit.

Instead of cutting out field coils, a resistance R (see

Figure 41) is sometimes arranged as a shunt around the field coils and as the arm is moved forward or back the resistance is increased or decreased, thus taking more or less current around the fields and weakening or strengthening them accordingly.

The highest E.M.F. of which the dynamo is capable is obtained when the brushes are near the neutral point. This position of the brushes can only obtain when the maximum number of lights are in the circuit. With a lesser number of lights the brushes must

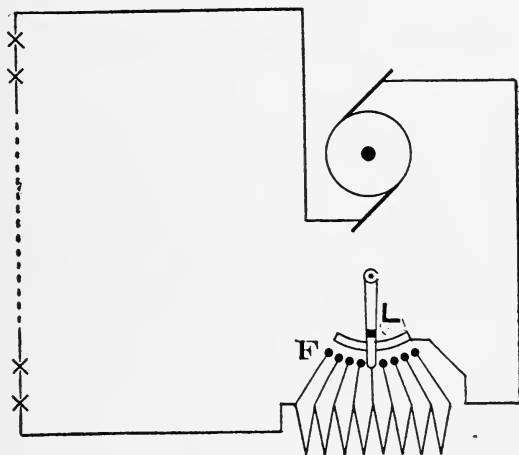

Figure 40

be shifted away from the neutral point sufficient to cause a certain number of the armature coils to generate in opposition to the rest and thus reduce the E.M.F. of the dynamo until the current has its predetermined value.

From what we have learned in chapter on Principles of Dynamos it is evident that all dynamos subject to such regulation must spark considerably at the brushes. There must also be considerable tendency

toward heating of armature wire with this kind of regulation as some of the coils are nearly always on short circuit. This applies also to a great extent to machines regulated by field commutation. Machines of this type are in consequence usually equipped with some special form of commutator calculated to withstand the destructive effects of the arcs formed. In the Thomson-Houston dynamo a blower is provided which blows out the arc.

For dynamos of this type the Gramme ring armature is preferable because from the nature of its wind-

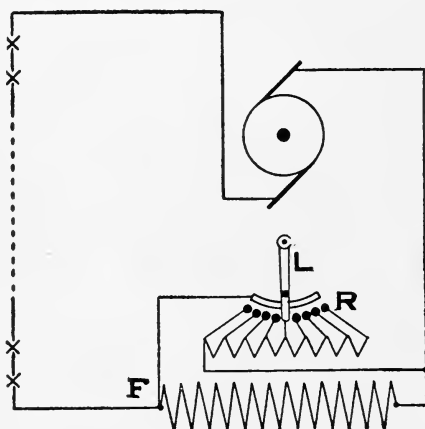

Figure 41

ing wires of opposite polarity do not cross each other as they do in drum armatures.

Two special types of dynamos very generally used for series arc lighting are the Brush and Thomson-Houston.

Figure 42 shows the coils and commutator sections of an 8 coil Brush arc dynamo. The diametrically opposite coils 1-1; 2-2, etc., are connected in series and each coil has its own exclusive commutator section.

By tracing out the circuit from the brush A, it will be seen that current enters at this brush, passes through coil 1-1 to brush A¹; thence to field II, brush B, coils 2 and 4 in parallel, thence to brush B¹ and out at the positive pole of the dynamo.

With this armature one coil is always on open circuit and the adjustment must be such that this coil while open is in the dead part of the field. Each commutator segment embraces three eighths of a circle.

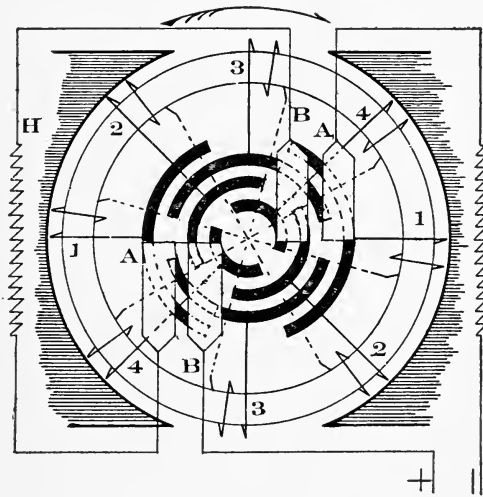

Figure 42

As the different coils are not in series with each other but at times in parallel the brushes must be so arranged that at no time can a coil that is not generating be left in circuit. Such a coil would simply form a short circuit to the line and much of the current that should flow through the line would flow through it. By following out in imagination a complete revolution of the armature one can see that the brushes always break contact with the coils as they pass

out of the influence of the fields. It is very important to see that the commutator is always set with regard to this.

The Thomson-Houston is another type of open circuit dynamo armature. The nature of its winding is shown in Figure 43. One end of each coil is connected to one of the 3 commutator sections and the other to a brass ring R common to all the coils.

A series dynamo if left without regulation will, with an increase of current, run its E.M.F. to the maxi-

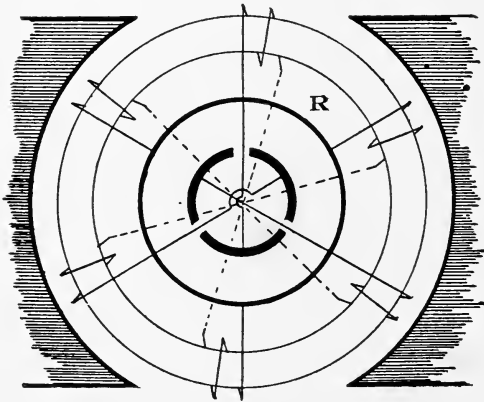

Figure 43

mum of which it may be capable and probably burn out. The greater the current the greater will be the pressure, but after the fields have become fully saturated the increase in E.M.F. will be small. Figure 44 shows the characteristic curve of such dynamos. Such curves are obtained by plotting the E.M.F. and current existing at the same time on squared paper as shown and then combining the points so obtained in a curve. This may be to any convenient scale. The figure shows only the general outline of such curves

as they are of course different with different types and design.

For incandescent lighting, motor service, constant potential are lighting and storage battery work the shunt dynamo is much used although of late years the

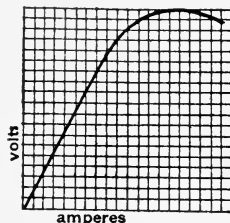

Figure 44

compound wound dynamo is crowding it out. Figure 45 is a diagram of the shunt dynamo. This dynamo is generally equipped with a drum armature. It is sel-

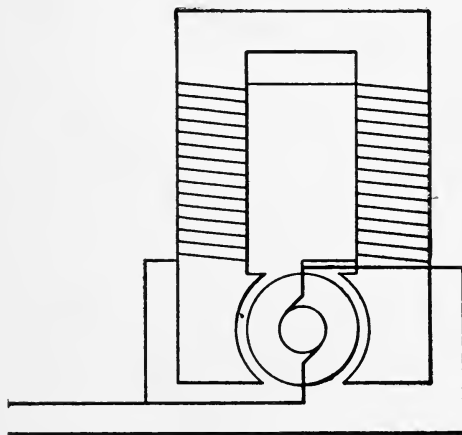

Figure 45

dom if ever equipped with an automatic regulator and instead hand regulation is used. The drop of potential at the brushes is equal to the current multiplied by the resistance of the armature. In a poorly con-

structured armature this is considerable so that such a machine needs constant watching. An appreciable drop in potential is of course accompanied by a weakened current through the fields which in turn allows a further falling off in potential.

The characteristic curve of a shunt dynamo is given in Figure 46. If the potential of such a dynamo falls off noticeably the fields begin to weaken and thus increase the falling off in proportion. A shunt dynamo if short circuited will for a very short time increase its current enormously and will then lose its pressure, the short circuit robbing the fields of all current. The

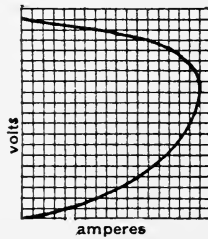

Figure 46

curve in Figure 46 shows the effect of an overload which is nearly or fully equivalent to a short circuit. After the maximum current has been reached the pressure falls off so much that the current also decreases and both current and E.M.F. finally return to 0.

As all armatures have some resistance it follows that the potential at the brushes of any shunt dynamo must fall as the current increases. To compensate for this a special winding through which the whole dynamo current flows is put upon the fields in addition to the shunt winding. As the drop in potential is

always exactly in proportion to the current flowing, it is evident that if this current be made to circulate the proper number of times around the fields it will increase their strength so that the E.M.F. of the dynamo will be raised just enough to make up for the loss due to its armature resistance and the E.M.F. remain very nearly constant. (See Figure 47.) If the current be made to circulate a greater number of times the E.M.F. of the armature will go higher as the current increases. It is therefore possible to

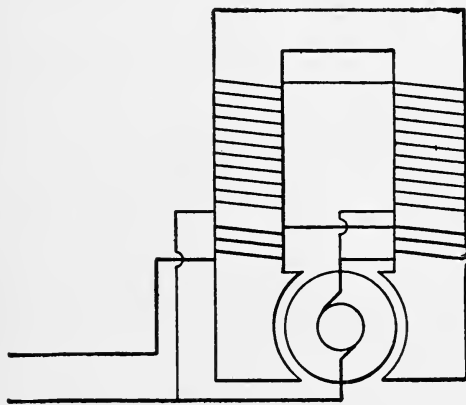

Figure 47

arrange such dynamos to keep the pressure constant even at points far away from the machine, but in such cases it will go undesirably high at the dynamo terminals.

The characteristic curve of a compound wound dynamo is a combination of the curves of a series and shunt machine and shown in Figure 48. If such a dynamo is short circuited the shunt fields will immediately lose their magnetism but the power of the series coils will be momentarily increased as there will

be for a very short time a great flow of current, due to the fact that an instant of time is necessary before the magnetism of the fields passes away. If the series fields are very strong compared to their own and the armature resistance they will energize the fields on their own account and the armature will burn out. If it is very weak relatively to those two factors, little harm will be done if the armature has withstood the momentary rush of current which could last only long enough for the shunt fields to die down.

So far we have looked upon all machines as having but two poles. Such machines are known as bi-polar.

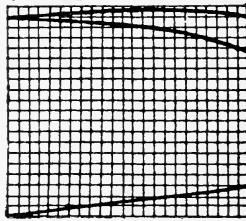

Figure 48

Most of the larger machines are, however, multipolar, i. e., equipped with more than two poles. The magnetic circuits and arrangement of pole pieces in a 4 pole machine are shown in Figure 49. With such machines there is usually a set of brushes for each set of poles. The neutral point will be about midway between two pole pieces. If the brushes are moved a quarter revolution forward or back the directions of current will be reversed. Armatures for such machines may be wound just as for bi-polar fields but a form of winding as indicated in Figure 50 is preferable.

Figure 50 is a diagrammatic view of the simplest form of multipolar armature winding. The wires are laid in slots on the outer circumference of the armature and are shown as though the armature were cut

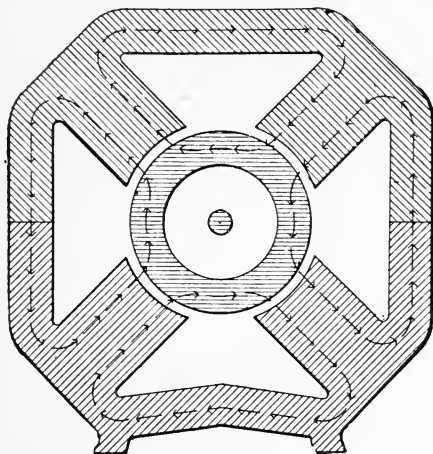

Figure 49

in two and the wires laid out flat. W, W represents the commutator sections and N, S, the poles as in Figure 49.

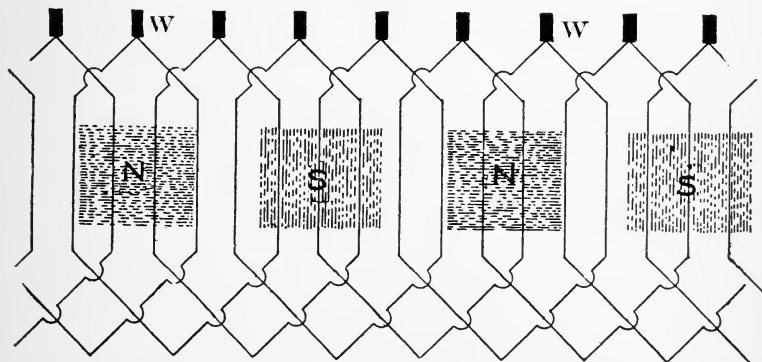

Figure 50

A view of a finished armature is given in Figure 51. Alternating currents to be available for lighting purposes must have quite a high frequency; 60 cycles

per second or 7200 alternations per minute being about the lowest frequency that can be used for arc or incandescent lighting without causing annoyances through flickerings in light. If such frequencies were to be produced by a bi-polar machine it would have to operate at a speed of 3600 revolutions per minute. As these machines also generally operate at very high pressure there would also be, with drum armatures, great danger from wires between which great difference of potential exists crossing each other. To obviate the above troubles alternators are usually made

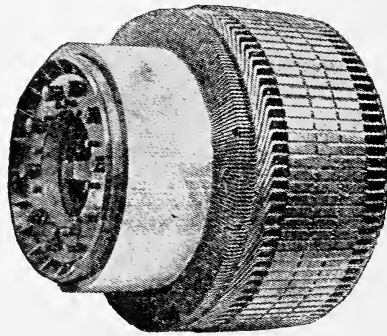

Figure 51

multipolar, both, fields as well as armature, consisting of a number of sections.

The alternating current dynamo may have its armature stationary and the fields revolving; it may have the fields stationary and the armature revolving or the fields and armature may both be stationary. In the latter case it is described as belonging to the inductor type.

An alternating current cannot be used as such to excite the field and consequently many dynamos are

separately excited by an outside dynamo. Some alternators, however, are provided with commutators which rectify the current and make it available.

Figure 52 shows the general layout of an alternating current dynamo with revolving fields and stationary armature. The dynamo is excited by direct current from a shunt dynamo, the current entering at D.C. and passing around the fields. The strength of

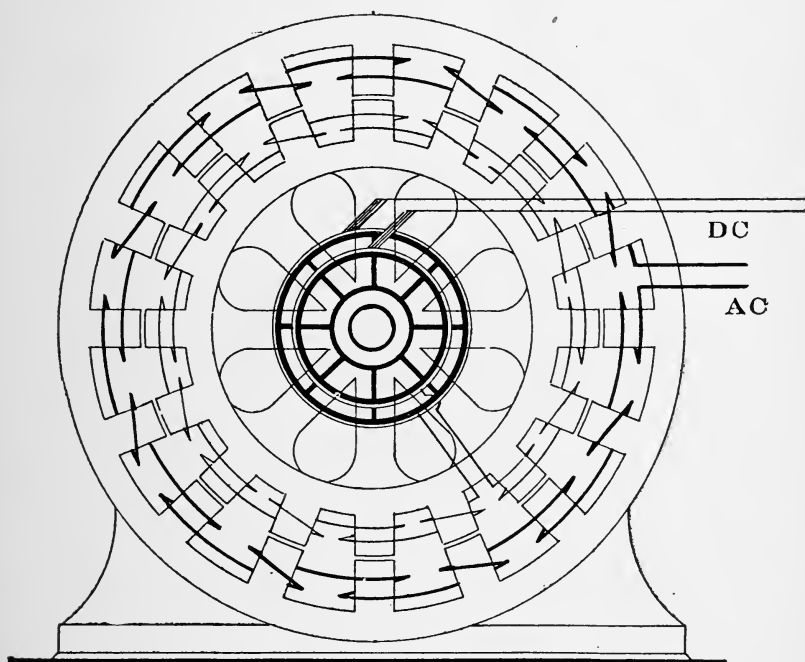

Figure 52

this current can be regulated and through it the E.M.F. of the dynamo.

Every time one of the armature poles passes from under one of the stationary poles to the next one there is a reversal in direction of the current.

If supplying a variable load the E.M.F. of the dynamo will be constantly fluctuating, the drop increas-

ing as the load increases and with this machine there is only hand regulation.

In order to avoid the necessity of constant attendance and hand regulation alternators are sometimes compound wound just as direct current machines. The field of such a machine consists of a steady current from the D.C. dynamo supplemented by a pulsating current from the generator itself.

In order that the generator current may be used it

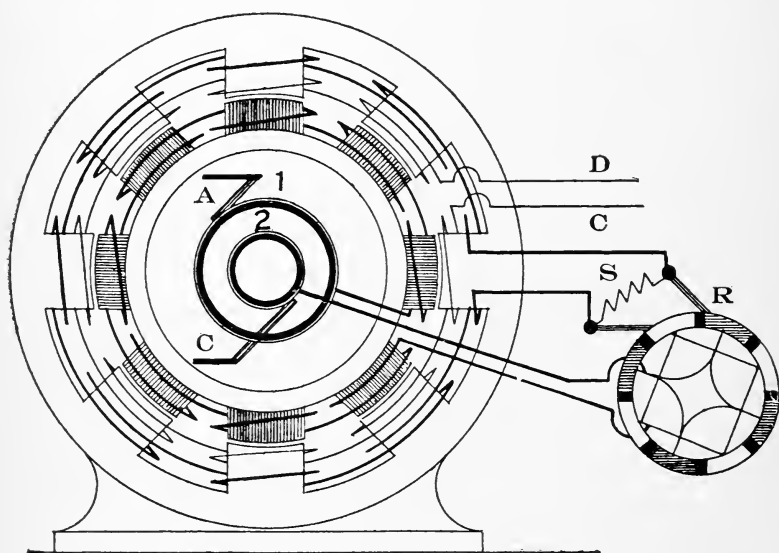

Figure 53

must be rectified so that, although it is variable in strength, the pulsations all pass through the fields in the same direction. For this purpose the rectifier R, Figure 53, is provided. This rectifier is fastened to the same shaft as the armature and revolves with it. All of the white sections of R are joined together by the wires shown as forming a square and the shaded by the wires shown as curved lines. The shaded sec-

tions connect direct to collector ring 2 and the white to the wire coming from the armature, as shown. The brushes shown bearing upon the rectifier are adjustable and are to be set so that at the moment when the alternating current is passing through the zero part of its waves, the connections are changed, i. e., one brush changes from a shaded segment to a clear one and the other vice versa. By this arrangement the current passing through the fields of the generator (stationary in this case) remains always in the same direction although that in the line is alternating. The main current can readily be traced, beginning at A, collector ring 1, armature, clear sections of rectifier, fields, shaded portion of R to collector ring 2 and the line, finally returning to A. The direct current field circuit is shown at D C.

The rectifying arrangement works quite satisfactorily as long as the load is of constant inductance. This is, however, only the case so long as merely incandescent lights are in circuit. When motors or arc lights are operated the current does not always coincide in phase with the normal adjustment of armature and rectifier and begins either to lag or lead, that is, the zero part of the wave occurs a little later or earlier and therefore the change of rectifier segments is made at a time when there is considerable current flowing, which results in severe sparking unless the brushes are constantly being shifted. For this reason the rectifier is not being much used at present.

It will be seen that by shifting the brushes the full width of a segment the direction of the current around the fields can be reversed. A variable shunt S can be

arranged by means of which more or less of the rectified current can be diverted from the field circuit.

In actual practice the generating coils of alternators are not wound upon projecting coils but laid into slots as indicated in Figure 54. Sometimes each slot contains only one wire; sometimes there are many. The number of slots per pole also varies. For two and three phase machines two or three windings are arranged either upon the rotating or stationary part. In Figure 54 there are three slots per pole and this armature is designed for three phase currents. The

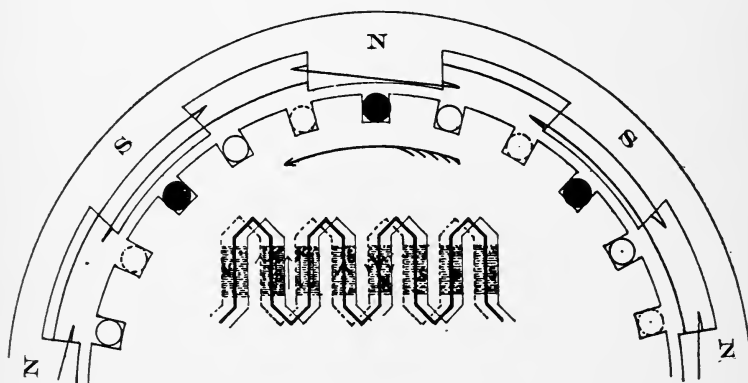

Figure 54

positions of the wires for one of the phases is indicated by the black circles. As these sweep around under the pole pieces the currents induced in each wire are in a different direction and to make all of them generate in series they are connected on the two sides of the armature as shown by the heavy black lines, where the arrows indicate direction of induced currents. The other two phases are wound into the empty slots in the same manner, and it can be seen that while the phase represented by the black circles

is at a maximum, being directly in the strongest part of the field, that at the right of it is increasing and the one at the left decreasing. These wires are connected to collector rings in such a manner that in the outside circuit they are in opposite directions, one wire always forming the return for the other two. A partial diagram of the winding is shown in the center of the figure.

CHAPTER VI

PRINCIPLES OF ELECTRIC MOTORS—DIRECT CURRENT

The reader will, no doubt, have noticed that there is no great difference between a dynamo and a motor and that there are about as many different types of one as of the other. As a matter of fact, any dynamo can be used as a motor and any motor as a dynamo, although as a rule less care is bestowed upon the manufacture of motors and most of them would operate at very low efficiency if installed as generators.

In the shunt dynamo we apply power to revolve the armature in the fields and the power required is proportional to the current flowing. If the armature is on open circuit we require no more power than is necessary to overcome the friction. It is, therefore, the reaction of the current in the armature against the fields which requires the power to overcome it. It follows from this that if we take the belt from a dynamo and arrange for an equal current from some other source to flow through the armature in the same direction we must obtain motion, but in a direction opposite to that in which the armature was revolved when generating.

Let us look at this a little more in detail. Figure 55 shows the armature and fields of a motor. Cur-

rent is flowing into the armature through the brushes. We have seen that the two halves of such an armature are in parallel and that the current magnetizes the armature, setting up poles as indicated by N and S. Arranged as shown in the figure, the S pole of the fields will attract the N pole of the armature and repel the S pole. This will cause the armature to move to the right and were it not for the commutator it would move only until the poles of armature and fields had aligned themselves. But as the armature moves the brushes change connections coil by coil and the

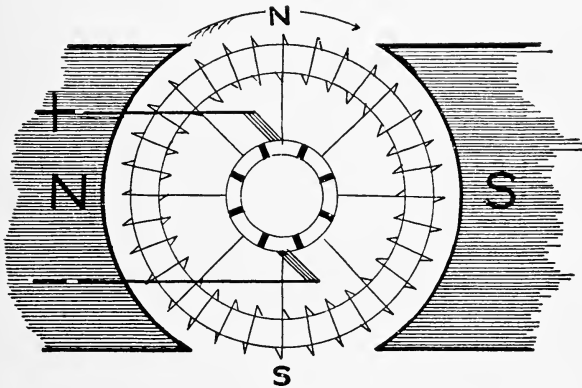

Figure 55

N and S poles of the armature remain always in the same position, thus keeping the armature always in motion in a vain endeavor to align itself and come to rest. Should we change direction of current either in field or armature, the motion would be in the opposite direction. If current through both fields and armature is reversed motion will continue in the same direction. The pull of the armature is governed by the current flowing in it and the strength of the fields.

Since the motor is the exact counterpart of a dy-

namo and its armature operates in a field precisely similar to that of a dynamo, it follows further that it must generate an E.M.F. just like a dynamo, and so it does, and this E.M.F. is always opposed to that of the dynamo from which the motor receives its current. This E.M.F. is known as the "counter E.M.F." of the motor and varies with the strength of field and speed of armature, or, in short, with the rate of cutting lines of force just as the E.M.F. of the dynamo does. The current which flows from the dynamo to the motor varies as the difference between the E.M.F. of the dynamo and the counter E.M.F. of the motor. Thus, if the voltage of the dynamo be 110 and the counter E.M.F. of the motor 105, the current flow through the motor will be due only to the five volts. The torque or pull of a *shunt* motor will depend upon the current, and consequently as a greater load comes on the motor, it must slow up until its counter E.M.F. is sufficiently reduced to allow the requisite current to flow.

If the armature of a motor have a very high resistance, it follows that its counter E.M.F. must be much lower than the E.M.F. of the dynamo in order that the necessary current may be forced through it. If with such an armature an additional load is thrown on, it must, of course, slack off in speed considerably in order to lower its counter E.M.F. sufficiently to draw the necessary current. The lower the resistance of the armature, therefore, the nearer constant the speed of the motor. This applies also to the resistance of the line. This fact is often made use of in regulating the speed of motors, an artificial, variable re-

sistance, known as a rheostat being cut into the circuit to control the speed.

So long as the motor is at rest, it has of course no counter E.M.F. If, at such a time the dynamo current were turned on, the armature of the motor would, up to the time that it acquired its proper speed and developed a counter E.M.F., present a circuit of very low resistance and be subject to an enormous current flow, which would speedily cause it to burn out. To prevent this a rheostat is always cut into the arma-

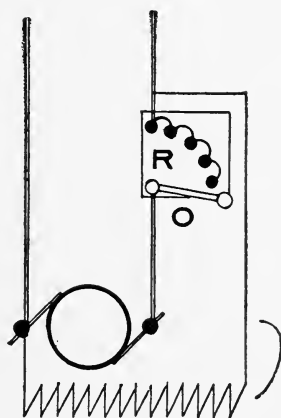

Figure 56

ture circuit. Figure 56 shows diagrammatically the circuits of a simple shunt motor. When the motor is to be started, the arm O of rheostat R is gradually moved, cutting out resistance.

The speed of a motor can be made to vary, first, by adding resistance in the armature circuit. This we have seen will tend to slow it down. Second, by increasing the strength of the field it can also be made to run slower. With a stronger field not so much armature speed is necessary to develop a given counter

E.M.F. and as this can never exceed the E.M.F. of the dynamo it follows that the motor must slow up. Conversely, by weakening the fields we can increase the speed of the motor, but if the fields are weakened too much, the armature may not be able to do the work and the counter E.M.F. fall so much below that of the dynamo that the armature will burn out.

The effect of a wrong position of the brushes is evidently quite different with motors than with dynamos. Suppose the brushes, Figure 55, to be moved $\frac{1}{4}$ turn in the direction of motion. This will throw the N and S poles of the armature in perfect line with the polarity of the fields, and in this case the armature would have to come to rest. There would be no counter E.M.F. and the rush of current would burn up the armature wires. Again, suppose the brushes to be moved one-half revolution forward or backward, the direction of motion will be reversed.

The magnetism of the N. pole of armature, of course, repels the magnetism of the N. pole of the field just as it does in a dynamo. Hence with an increase of current through the armature which always follows increase of load, the neutral line is shifted in the opposite direction in which the armature revolves and, to avoid sparking, the brushes must be shifted just in the opposite way to those of the dynamo. The same considerations that apply to short circuiting coils in an active part of the field of a dynamo apply to motors. The position of least sparking at the brushes is not, however, the position of greatest torque. The greatest pull is obtained when the brushes are set somewhat back of the neutral. If the brushes are

shifted in either direction far from the neutral line, some of the coils will not be generating any counter E.M.F. just as in the dynamo, and, consequently, if the motor is running empty, it will speed up. If the motor is loaded, the armature will not be able to pull the load and slow down and very likely burn up.

The maximum speed of any motor is that at which its counter E.M.F. most nearly equals the E.M.F. of the circuit. This speed can be approximately attained when the motor is doing no work.

The losses in the motor are due to the same causes as those in the dynamo. A certain amount is due to friction. There is a loss of potential due to the resistance of the line and a further loss due to the armature resistance. This in the armature, if excessive, will manifest itself by much heating.

If the fields are wound with a few turns of large wire instead of many turns of fine wire an unnecessarily large current will be required for magnetization. If a poor quality of iron is used in the fields, or if the air gap between pole-pieces and armature is too great, the magnetic circuit will be of low conductivity (see chapter on magnetism) and require unnecessary power to generate.

CHAPTER VII

TYPES OF MOTORS—DIRECT CURRENT

There are as many different types of motors as there are of dynamos. Any dynamo may be used as a motor and any motor as a dynamo, as we have seen in another chapter. It is merely a question of applying current properly.

In the matter of regulation, however, there is considerable difference. We shall begin our study with the oldest and now almost obsolete form—the constant current series motor. This motor is made only in small units and used only on arc light circuits. The amperage of an arc light circuit does not usually exceed ten amperes. To obtain even 5 H. P. with ten amperes would require a voltage of about 400 volts, hence it can readily be seen that such motors are not commercially practicable except in small units and then only when no constant potential circuit is available.

The torque or pull of any series motor, if the fields are not oversaturated, is proportional to the square of the current. Doubling the current doubles the strength of fields, and as the same current passes through the armature its strength is also doubled, hence the power of the couple is quadrupled.

We have seen in a previous chapter that the speed limit of any motor armature is that speed at which the counter E.M.F. is equal to the E.M.F. existing at its terminals. These two can of course only be equal when no current is flowing, i. e., when the motor is doing no work. As we are here dealing with a current which is kept at a certain value by the dynamo, we need take no precautions to keep the current from damaging the motor. If now such a motor be started with a load it will at once develop its full torque or pulling power, the maximum current being instantly available in fields and armature. The torque will also be constant since field and armature are of constant resistance. The counter E.M.F. of the motor has no effect upon the circuit except to require the generator to work at a higher pressure. The speed of such a motor will vary as the load put upon it. If the load be removed from such a motor it will increase its speed and oppose the dynamo E.M.F.; this in turn will be increased and again the motor speed will be increased in a vain endeavor to build up an E.M.F. equal to that of the dynamo. If this racing of the motor is not checked by an increase of load or a regulator of some kind it will continue to speed up until it flies to pieces. The speed regulation of this motor is usually accomplished by reducing the field strength as the load decreases and increasing it as the load increases. The methods employed are similar to those illustrated in Figures 40 and 41.

We may next consider a similar motor on a constant potential circuit. The torque in this case is proportional to the square of the current as above. But in

this case the generator is without control over the current. If current is turned on suddenly before the armature is in motion there is only the ohmic resistance of the line, fields and armature to prevent it from rising to an enormous value. In well designed installations these are all low and the result would be a burned out armature. Hence the resistance R , Figure 57, is provided. This motor loaded down will act as has been described under Principle of Motors, the arma-

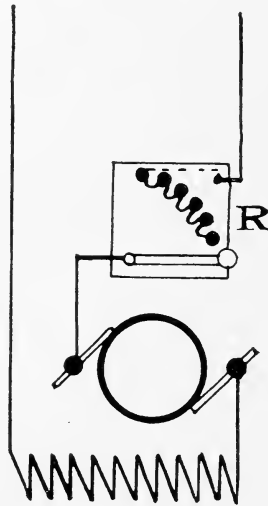

Figure 57

ture tending to run at a speed at which it develops a counter E.M.F. equal to the E.M.F. existing at its terminals. With a heavy load the motor must slow down considerably to permit the necessary current for doing the work to pass. As the load is removed the current flowing becomes less because the motor speeds up and the counter E.M.F. begins to rise. This in turn weakens the fields. Weakening of the fields lessens the counter E.M.F. of the motor and consequently

it speeds up to make up for this. As the motor speeds up more and more the fields become gradually weaker and weaker, thus calling for still more speed in an endeavor to bring the counter E.M.F. up to the initial E.M.F. of the dynamo. This speeding up of a series motor without load will continue until the armature flies to pieces. For this reason such motors are as a rule used only where an attendant can be kept constantly with them.

As a rule this motor is used only in street railway work and on cranes, etc. In this case an attendant is necessary anyway. The motor because of its great starting power is best suited for this work, and any other kind of motor would moreover be entirely unsuitable, because very often the current is suddenly stopped or put on because of the trolley wheel leaving the trolley. With this type of motor there can be no current through the armature unless there is the same current through the fields. Consequently every rush of current (the armature being in motion, as it always is when the wheel for an instant leaves the trolley) is met by the proper counter E.M.F., which prevents undue current flow, and there is no need of regulation unless the speed of the armature has been much reduced during the time current flow was interrupted.

The motor most in use for general work is known as the shunt motor. The fields and armature of this motor are entirely independent of each other. In operating this motor it is necessary to see that full current is in the fields before any current is allowed to pass into the armature. The armature current

must then be turned on gradually so as to give the armature time to get in motion and develop the necessary counter E.M.F. before the full current is turned on. This is accomplished by means of the rheostat R shown in Figure 56. The speed of this motor is nearly constant under variable load within proper limits if it has been well designed and installed with low resistance in armature and line. It cannot be used in connection with street car work, principally on account of the inductance of its fields. The fields of a shunt motor always contain a great many turns of wire, and it requires some time for the current to attain its full value in them. If the current were cut off from such a motor for, say, a second and then applied again, as often happens in connection with trolley service, the fields would in that second have lost their magnetism and upon the connection being re-established the motor would be running without fields and, of course, without its proper counter E.M.F. This would invite a very strong flow of current through the armature before the fields have time to build up, and furthermore a good armature without counter E.M.F. would offer almost no resistance and be equivalent to a short circuit and this would entirely prevent the fields from getting current so that either a fuse or circuit breaker would go out or the armature would burn out. To prevent accidents of this kind rheostats with overload and underload switches have been devised which entirely disconnect the motor if the current fails.

The compound motor varies from the shunt motor just as the compound dyanmo does from the shunt

dynamo. A compound wound motor may, however, be used in two ways. If the current in the series winding is in the same direction as that in the shunt winding the fields will be strengthened as the load is increased. This will enable the armature to develop its counter E.M.F. with a lesser number of revolutions and therefore it will slow up. The power of a compound motor so connected will increase as the load is increased but the speed will decrease.

If the current in the series fields flows in the opposite direction to that in the shunt fields the magnetism in the fields will be lessened as the load increases. This will force the armature to move at a higher rate of speed in order to develop an E.M.F. equal to the E.M.F. at its terminals. If the series fields are properly proportioned to the shunt fields and the resistance of armature and line, the motor will run at a uniform speed with any load within its capacity. It will be noted, however, that the current through the armature with such a motor increases as the load increases much more rapidly than with an ordinary motor since it must make up for the deficiency created in the fields by the opposing magnetism. The capacity of two identical motors, one shunt wound and the other "differential," as this winding is termed, is therefore not equal, the differential motor having a much smaller capacity.

As the differential motor uses power to neutralize power, i. e., the current in the series fields acts against that in the shunt fields, its efficiency is lower than that of any other direct current motor and its use in general is not to be recommended except where great constancy of speed is absolutely necessary.

CHAPTER VIII

PRINCIPLES OF ALTERNATING CURRENT MOTORS

Many of the types of small direct current motors may be run on alternating current circuits. That this is true is readily apparent when it is recalled that changing the direction of flow of current in a direct current motor (both fields and armature) does not reverse its direction of rotation. When current flows through the motor in a positive direction, for instance, there is a certain attraction between those poles set up by the field current and those poles set up by the armature winding. If the direction of flow of current is reversed each of these sets of poles is reversed and the same attraction exists as before.

Every coil of wire wound on an iron core, as in the case of a field magnet, has a certain inductance, which, when an alternating current is sent through it, acts as a resistance and tends to cut down the current flow. It is due to this fact that the majority of direct current motors, especially the larger sizes, cannot be used on alternating current circuits. If a direct current motor were constructed without iron either in the fields or armature it would operate on alternating current as well as on direct current. This characteristic is taken advantage of in some forms of

integrating watt-meters which are suitable for use on either direct or alternating current circuits.

If two identical alternating current generators were run, one as a generator supplying current to the other as a motor, the one running as a motor would run in exact synchronism and at exactly the same speed as the one running as a generator, for every change in the force producing power in the generator would be reproduced in the motor. This can be more readily understood by a study of the effects in a simple case. Suppose two bi-polar machines each have an armature consisting of a simple loop the ends of which are

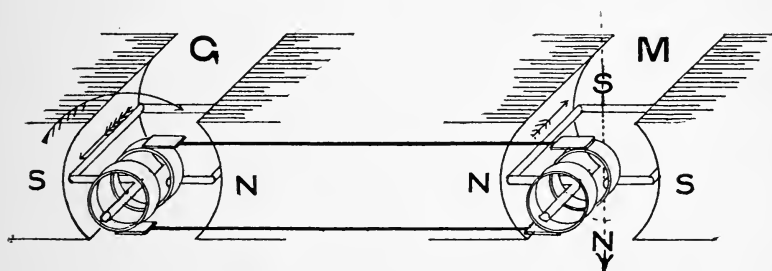

Figure 58

connected to two collector rings, as shown in Figure 58. The fields of both the generator and the motor must be supplied by direct current from some outside source. If the armature of the generator *G* is revolved to the right, as indicated by the arrow, current would be induced in the moving coil in the direction shown by the other arrow. This current flowing in the coil of the motor *M* would set up poles, as indicated by the dotted line *S N*, and these poles would be acted upon by the polarity of the fields, which is permanent, as shown. A north pole *N* will attract a south pole *S* and repel another north pole. This re-

sults in motion and the armature of the motor is revolved toward the left.

The successive steps for a half revolution are illustrated by the figures in Figure 59, where the figure at the left represents the various positions of the generator coil, 1, 2, 3, 4, 1', as it makes a half revolution. The several figures at the right show the resulting condition and corresponding position assumed by the motor armature. 1 represents the position of the armature, as shown in Figure 58. At this point the generator coil is generating its maximum current. This current flowing through the coil of the motor

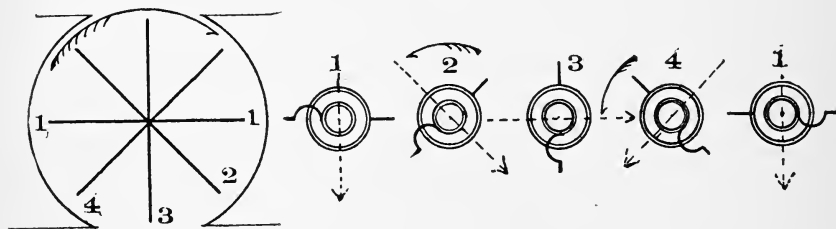

Figure 59

produces a field of force with a polarity, as shown in the head of the arrow, indicating an N pole, and as the generator armature is requiring at this point the greatest expenditure of energy to turn it so is the motor armature yielding its greatest turning effort.

When the generator armature has revolved to point 2 the conditions in the motor armature are as shown in 2. There is the same tendency to turn the motor armature as before, but as the current in the generator armature is decreasing so is the tendency to turn in the motor armature likewise decreasing. As point 3 is passed the direction of the current produced by

the generator armature is reversed and also the polarity of the motor armature, and at point 4 the conditions in the motor armature are as shown at 4. It will be noticed that the current in the motor armature is now flowing in the opposite direction, with the result that the relation between the armature and field polarities are repeated, and the motor armature will continue to revolve in synchronism with and at exactly the same speed as the generator armature.

If the single coil generator just described is in operation and connection made to the motor armature while this armature is at rest, it will be quite evident that the motor armature will not revolve, for, when it assumes the position shown in 3, Figure 59, it will be on a dead center and there will be absolutely no turning moment.

In order that the motor armature may continue to revolve it must have acquired some momentum to carry it over the dead center and it must also move at such a speed that it will always be at or near the dead centers when the dynamo current reverses. If it is not its movement will be opposed by the reaction between the poles of its armature and fields and come to rest. For this reason it is necessary to bring single-phase synchronous motors up to synchronous speed by some outside means before connecting it to the supply current.

Some polyphase synchronous motors are so designed that they will bring themselves up to speed if started under no load.

Owing to the fact that synchronous motors are not self starting and that some outside means must be

employed to bring them up to synchronous speed and due to the further necessity of a direct current field excitation they are seldom used for ordinary commercial work, their use being confined to large units in such places where they can be used under the above conditions.

If the field excitation of a synchronous motor is varied the power factor is also altered and it is possible by varying the exciting current to produce a leading "current," this causing the motor to have the same effect on the line current as would be caused by the introduction of a condenser. This characteristic is sometimes taken advantage of to increase the power factor on lines where it is low.

For the ordinary purposes for which motors are used neither of the motors just described is suitable. To be commercially practical a motor must be self starting and must be capable of starting under a load. It must require current from one source only, i. e., must be self-exciting. The "induction" motor fulfills these requirements, and is the form of motor in most common use on alternating current circuits.

The principles underlying the operation of a poly-phase induction motor can be gathered from a study of Figure 60. In this figure the heavy black lined circles represent the wires of one phase, A, and the light those of the other, B, of a two-phase motor. These windings are placed in the slots of the stator as shown at the top of the figure and the small circle C represents one of the bars of a squirrel cage armature, as shown in Figure 62. This circle also marks in the different sections of the drawing 1, 2, 3, etc.

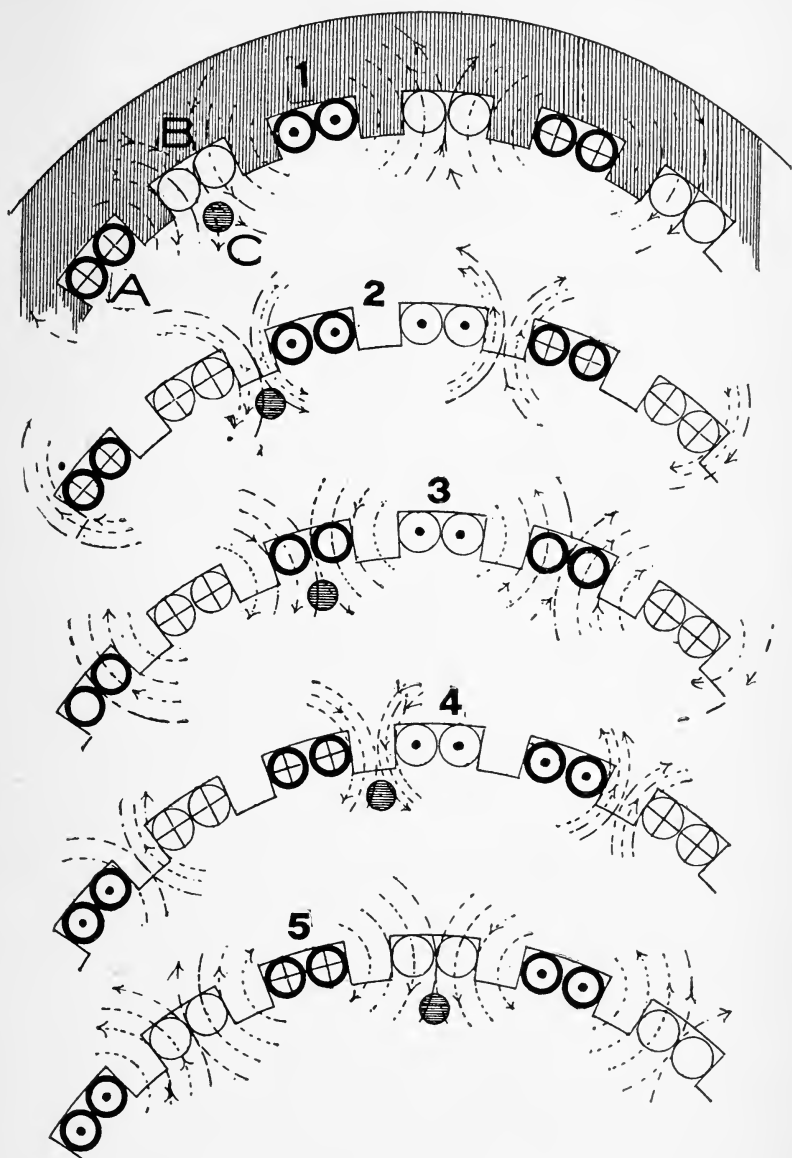

Figure 60

the position of a steadily advancing pole, in this case a north pole.

The wires A and B are traversed by two independ-

ent alternating currents which are, however, always in the phase relation illustrated in Figure 61 and indicated as to direction by a cross for positive and a dot for negative. In Figure 61 that portion of the currents represented by the sine curves above the base line may be taken as positive and those below it as negative.

To begin let us assume that the current in A is at a maximum, as shown under 1 in Figure 61; at the same instant the current in B is zero; under these conditions B will not be producing any lines of force

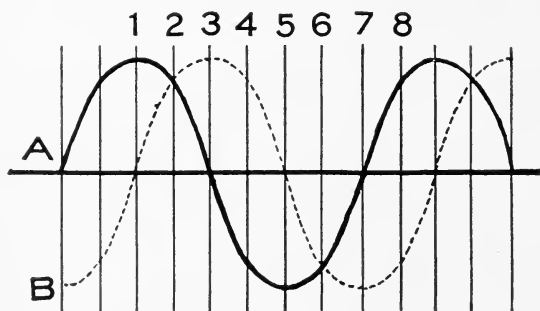

Figure 61

and A will be producing a magnetic field, as shown in 1 in Figure 60, the lines of force encircling the wire in which the current is positive (flowing away from the observer) in the direction in which the hands of a clock move. This produces a north pole at the wire C. A moment later the two currents assume the phase relation shown under 2, Figure 61, and the field becomes now as indicated at 2, Figure 60. The currents in both sets of wires now being in the same direction the lines of force expand and encircle both of them and the north pole is moved further to the

right. In another short interval A sinks to zero and B arrives at its maximum, as shown under 3, Figure 61. This in turn produces the field conditions, as shown at 3, Figure 60. As the two currents continue to rise and fall always maintaining the same phase relation (90 degrees apart), the field continues to change with them, as shown further in 4 and 5.

It will be noticed that all of the poles set up by the different convolutions are moving steadily from left to right, and it can also be seen that if we should reverse the two phases the poles would shift in the opposite direction.

If, while this shifting of poles is going on, the wire C should remain stationary it would cut the lines of force rapidly moving by it just as it would in any dynamo in which the lines of force were stationary and the wire moving. In this way currents would be induced in it. These currents would be in such a direction that the lines of force created by them would oppose the lines of force creating them. This opposition between the wire C and the field would result in motion if C were free to move. If C were to move at the same rate of speed as the revolving field it would cut no lines of force and no currents would be induced in it. It can in practice never move at this speed because it would then have no torque.

It can be seen from the above that the difference in speed between the revolving field and the wire C, or of an armature carrying many wires like C, must depend upon the load, and the greater the load the greater must be the difference in speed between the two. In other words, in order to carry a heavy load

such an armature must slack up in speed sufficient to allow of induction enough so that the reaction between the two currents may be sufficient to move the load. This difference in speed is spoken of as the "slip." If the load is too heavy the motor will simply come to rest and burn out.

It can also be seen that, if instead of a squirrel cage armature or rotor we provide one with a regular armature winding the induced currents can be brought outside of the machine and be controlled by resist-

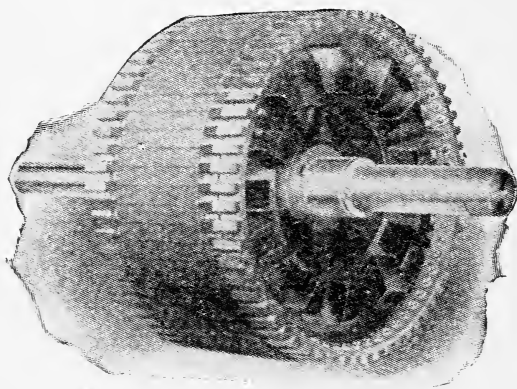

Figure 62

ance like those of any dynamo or motor armature. This is often made use of in large motors.

The rotor of an induction motor acts like the secondary of a transformer and if it is at rest while currents are traversing the stator, the effect is the same as though a transformer were short circuited. For this reason these motors require enormous starting current for a short time, sometimes five or six times the running current.

In Figure 62 is shown the armature of an induction motor. The armature consists of a laminated iron

core with partially closed slots through the outer edge. Insulated copper bars inserted in these slots are bolted to rings on each end of the armature and are thus short circuited. This is called the "squirrel cage" type of armature owing to its similarity to the ordinary squirrel cage. The field is also formed of laminated iron cores with slots across its face into which the field windings are placed.

In some designs of induction motors the element which has here been called the "field" is made the revolving element, the "armature" winding being placed on the stationary part of the machine. The conditions, so far as the operation is concerned, remain the same whether the armature or field revolves but certain peculiarities in the design of the larger size motors, especially, make it preferable to have the field revolve.

The two terms "armature" and "field" have a rather indefinite meaning when applied to alternate current motors. The field is generally considered as that element which receives current from the line while the armature is that part in which current is induced. The more common term applied to these parts is "rotor" for the revolving element and "stator" for the stationary element, although owing to their similarity with a transformer the field is sometimes called the primary element and the armature the secondary element.

CHAPTER IX

TYPES OF MOTORS—ALTERNATING CURRENT

Single phase motors may be made self starting in a manner illustrated in Figure 63. This figure shows a diagram of the connections of a split phase motor. There are two sets of field windings and each has a different reactance, that is to say, one will permit a more rapid rise of current strength than the other.

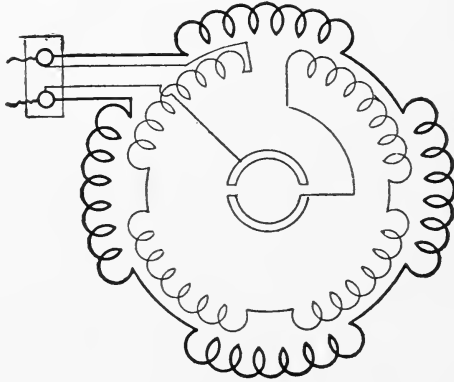

Figure 63

This action is as follows. The two semicircles in the center of Figure 63 surround the armature shaft. There is also a circular piece which revolves with the armature and which normally while at rest closes the circuit through the fine wire winding at the center. When current is turned on there is a flow through the

heavy winding and also through the fine, but there is considerable difference in phase between these currents and they set up a field, as already explained, for two phase motors. This causes the motor to start as a two phase motor and when it has attained its proper speed the circuit through the semicircle is opened by centrifugal force which causes the outer ring to spread out. The motor now runs as a single phase induction motor.

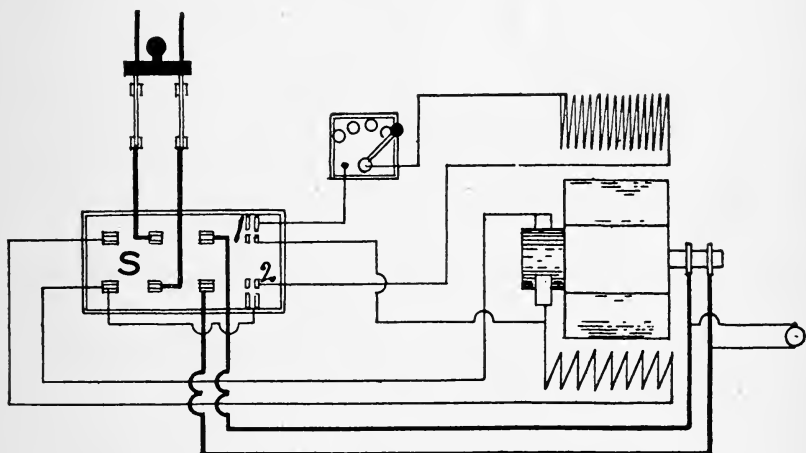

Figure 64

Another form of motor is shown in Figure 64. The armature contains a direct as well as alternating current winding. The motor is started by throwing the switch S (blades not shown) to the left. This sends an alternating current through the fields and armature and starts the motor. After it has come to speed the switch is thrown to the right; this sends the current through the alternating current side of the armature and also closes the direct current side through shunt fields and rheostat (the switch closes the connections

at 1 and 2). The motor now is synchronous with separately excited fields, the field excitation being furnished by the D. C. side of the armature.

The three phase motors up to a capacity of 5 H. P. are not usually equipped with starting devices. Such motors are self starting but require enormous currents when starting with load. Sometimes these currents are 5 or 6 times the running current. In order to allow such currents to be used at starting and still have adequate fuse protection when running the method shown in Figure 65 is generally employed. The

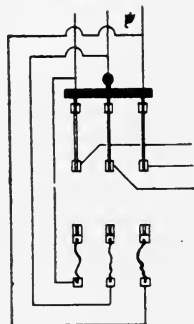

Figure 65

switch is thrown up to start and the current does not pass through the fuses. After the motor is running at its normal speed the switch is thrown downward, thus forcing the current to pass through the fuses and protecting the motor. As an extra safeguard the switch in its first position is sometimes forced against a spring which would throw it out of connection if left there, thus assuring that the attendant will remain with it until the motor is running so he can throw it to the running position.

Polyphase motors are essentially constant speed motors. Any regulation of their speed is quite uneconomical. They are all self starting and all subject to the same heavy rush of current at starting, as noted

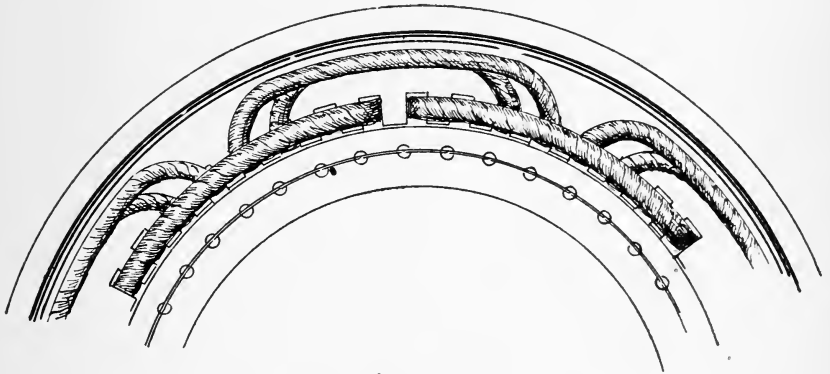

Figure 66

above. In the smaller sizes only the stator carries windings unless for some special reason the rotor is also wound. The general appearance of the stator

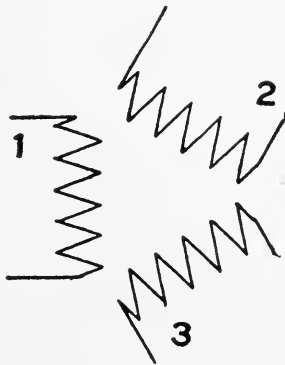

Figure 67

winding is shown in Figure 66. This is a 3-phase winding and the windings interlace all the way around. Diagrammatically such windings are usually represented as in Figure 67.

The windings of the three phases are shown in Figure 67. If we connect adjacent ends together we shall have what is known as the delta or mesh winding. If instead we connect the ends 1, 2, 3 together, we ob-

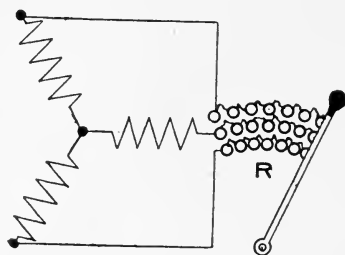

Figure 68

tain the Y or star winding. If a motor connected up in Y be changed to delta it will require much more current. If connected from delta to Y it will require less current. Of course, in both cases the heating will

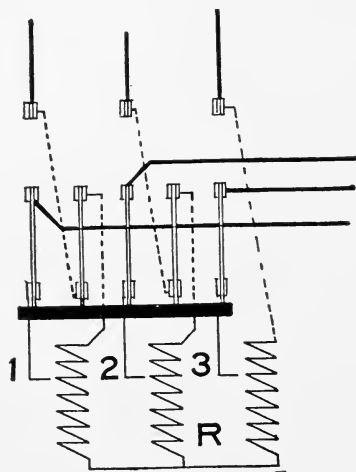

Figure 69

change with changes in the currents used, so that the change in connections must not be recklessly made.

There are two methods of starting induction motors in general use. One of these consists in inserting

resistances in the rotor circuit, as illustrated in Figure 68, at R. This is commonly used only with the larger motors. This resistance may be so proportioned that the starting power of the motor will be just as great with it in circuit as without it, and where great starting power is necessary this is a very useful method.

For the smaller and cheaper motors above 5 H. P., the method shown in Figure 69 is mostly used. While the switch is in the position shown the current must pass through the auto transformer R. The amount of reactance can be adjusted by connecting the wires, 1, 2, 3, at different points on R. The more reactance there is placed in the circuit the slower will be the starting of the motor. When the motor has attained sufficient speed the switch is thrown up and the current at full voltage goes direct into the motor.

CHAPTER X

DYNAMO OPERATION—DIRECT CURRENT

The dynamo room should be so situated that it is not exposed to moisture or the flyings of dirt and combustible material. There is nothing that will help induce an engineer to keep appliances in good working order more than a well ventilated and lighted room.

The larger dynamos are now generally direct connected, and should be placed upon foundations entirely separate from those of the building. This precaution is due principally to the vibrations caused by the engine. Where dynamos are belt driven there is very little vibration, unless the machine is entirely too heavy for the flooring upon which it is placed.

Whatever the power may be, whether steam, water, gas or gasolene, it is of the utmost importance to see that the prime mover operates as steadily as possible. The slightest fluctuation in speed will show in connection with incandescent lights. For this reason it is preferable to have the engines used for the lighting entirely separate from all other work that may be going on. This, of course, does not apply to factories, where only an indifferent light is required, as much as for central stations, where power is being sold.

If belt driving is necessary the machinery should be arranged that the belting may run as near horizontal as possible and the direction of rotation should



Figure 70

be such that the belt will pull on the under side. This allows the slack of the belt to hang downward on the

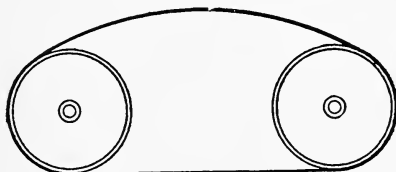

Figure 71

upper side and increases the arc of contact, as illustrated in Figure 70, whereas a belt operating as that

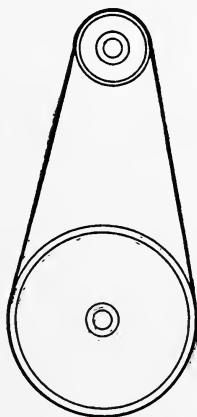

Figure 72

shown in Figure 71, by its slack decreases its arc of contact with the pulleys. Whenever it is necessary to arrange belting as in Figure 72, it becomes necessary

to keep the belts very tight. This is apt to result in hot bearings and also increases the amount of power necessary to operate.

It is best to choose belting that is considerably heavier than would be absolutely necessary to do the work. In order to obtain a certain amount of work from a belt there must be a certain pressure exerted by the belt upon the pulleys. This can be obtained by stretching a small belt very tight, but is far better obtained with a much larger belt operating with con-

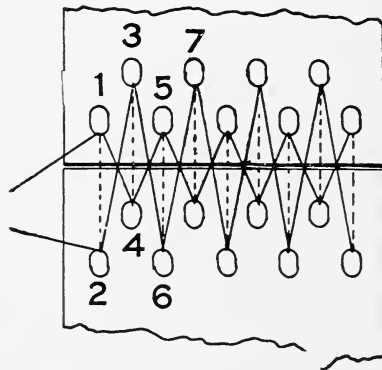

Figure 73

siderable slack. Such a belt will last much longer and will need very little attention, while the smaller will need continually to be tightened. The smoothest side of the belt should be run next to the pulley, as it makes the most perfect contact. The face of the pulley should be smooth, as all roughness tends to wear the belt and does not add a bit to the adhesion. Wherever practicable it is best to have belts made up endless; especially where the speed is quite high. With slow speed belting the lacing will not cause much annoyance, if it is well done.

A good method of lacing is shown in Figure 73. The holes should be made rather oblong, as shown, as in this way we avoid cutting away so much leather. On no account should any laces be run crosswise of the belt on the side next to the pulley.

In placing belts it is always best to put the belt upon the smaller pulley first. Never allow oil to come in contact with rubber belting. Use only tallow or castor oil on leather belting. Grease can be removed from leather belts by the use of turpentine.

The generator or motor should always be provided with a sliding frame, so that it can be adjusted to suit the belt from time to time. If the belt is properly arranged, there will be some lateral play possible at the generator shaft; this is essential to smooth running and helps to secure even distribution of the lubrication.

The tension on all belts that are run tight should be relieved when the belt is not in use.

Double belts should not be used on pulleys of less than three feet diameter.

The proportion between two pulleys close together should not be greater than 6 to 1.

If one is limited to a certain width of belt the power can be increased by increasing the diameter of both pulleys in the same ratio. This will not affect the speed of the machinery, but will increase the speed of the belt and hence its power in the same ratio that the speed is increased.

The width of a single belt can be found from the following formula:

$$W = 1200 \times \text{H.P.} \div V$$

where W is the width of the belt in inches and V the velocity of belt in feet per minute. For double belts, use 800 instead of 1200. This formula will give belts of ample size and, if necessary, much smaller belts can be forced to do the work.

STARTING-ARC DYNAMO

Before attempting to start the dynamo the circuit should be tested out to see that it is complete. If this is found in order, the belts should be examined for tightness; the bearings should be well oiled; all iron tools, etc., should be removed from proximity to the machine lest they be attracted by the magnetism that will be developed and cause injury. It will also be well for the operator to leave his watch, unless it is shielded against magnetism, as far as convenient from the dynamo. Many watches are brought to complete standstill by being brought too close to the fields of a powerful dynamo.

These things all being in order, the dynamo may now be set in motion, and it should now be so shifted on the sides that the armature has considerable lateral play. This indicates that the belt is in proper position and also helps to distribute the oil and keep the bearings cool.

If the machine operates at very high voltage, an insulated wooden platform should surround it on all sides, and this platform should be so placed and of such dimensions that no one can touch the machine without standing upon this platform. This platform will be of no use unless it is kept perfectly dry, and to assist to this end should be well filled with shellac.

It will also be well for the operator, especially if he be a novice, to provide himself with rubber gloves, and these also to be effective must be kept dry inside and out. As a further precaution, the operator should make it a rule while working on pressures above 220 volts, to touch bare metal parts with one hand at a time only. If this precaution is observed and if the body is kept well insulated from the ground there will be but little or no trouble experienced from shocks.

If the frame of the machine is grounded it will help to make things safer for the attendant, but will place a greater strain on the insulation. It will then be impossible for any one to obtain a shock by coming in contact with the frame, but greater care must then be exercised to avoid touching bare live parts and the frame at the same time.

Under no circumstances must one ever touch high potential wires while standing upon wet ground, boards, cement, metal connected to earth or upon anything that is not known to be a good insulator.

The regulator should now be examined to see that it is in proper working order and runs smoothly. Next place the brushes in position so that they bear properly upon the commutator. Before doing so, note that the armature is running in the direction called for by the position of the brushes. If it is not, one or the other must be changed about.

The plugs may now be inserted into the proper holes on the board. If there is sufficient residual magnetism in the fields the machine will begin to generate and, by noting the ammeter, the rise in current can be observed. If the residual magnetism is weak or en-

tirely absent, as sometimes occurs in new machines, or such as have been idle for a long time, it may not build up with all of the lights in the circuit. In such a case it is best to start the machine with one or two lights in circuit and when the current has attained to its full value to open the circuit and force current through the other lamps.

If there is no residual magnetism whatever, even this expedient will not suffice to start generation and current from some outside source, either from another generator or from a battery, must be caused to flow around the fields. Only a very small amount of current is required for this purpose.

It is most important, however, that the current from such a battery flow around the fields in the same direction as the current from the armature would flow. If this is wrong in the first trial, it is but necessary to reverse the battery connections. Sometimes a machine can be started generating by striking the metal of the fields with a hammer in a gentle way.

When the machine is fully started, the next point of importance is to see that the polarity is correct. Unless the current enters the arc lamps at the proper terminal, the lower carbon will be consumed at the fastest rate and will, in a short time, burn down to the carbon holders, which will in turn be speedily destroyed. If the polarity of the machine is wrong, it can be corrected by changing plugs, as explained under switching, or the polarity of the fields be reversed, or the leads to the armature changed, as indicated, in chapter on current generation.

Other methods of determining the polarity are given

elsewhere, but the only one generally used in a case like this is that of observing the arc lamps. The positive carbon will heat to a greater extent than the negative and consequently will remain warm longer and also, if the lamp is burning right, the brightest light will be thrown downward, while if the other way a bright light and strong shadows will be thrown against the ceiling.

If there are more lights on a circuit than one machine can handle, two may be connected in series as shown in Figure 74. In such a case the regulator of

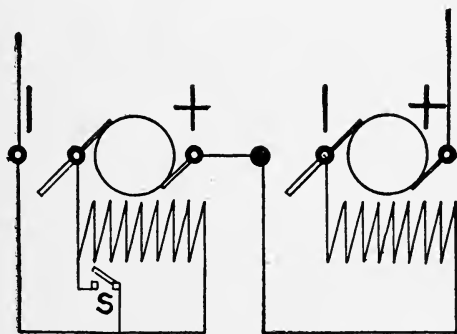

Figure 74

one machine is generally cut out and the brushes set for the highest potential at which this machine will operate well. The regulator on the extra machine is then depended upon to take care of the variations in the number of lamps cut into the circuit.

An expedient sometimes resorted to when a number of circuits are run from one machine as illustrated in Figure 75 and when there is an open circuit in one of them, is to cut out the bad line for a time by the plugs indicated by dotted lines at P, until the lights in the other circuit are burning full, then suddenly with-

draw the plug. This throws the whole accumulated force of the machine into the bad line, and if there is any possibility whatever the current will jump the bad place and often times operate the circuit successfully thereafter. This practice is known as "jumping in," and should never be resorted to when any other method is available, as it may ruin the dynamo or cause fire or a breakdown of the insulation somewhere along the line.

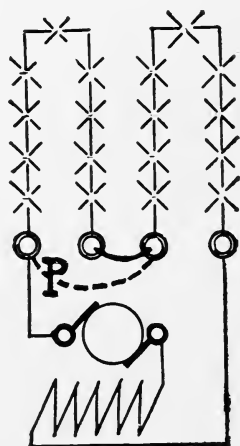

Figure 75

To shut down the dynamo we close the switch shown at S, Figure 74. This shunts the current around the fields, and leaves them without magnetism, thus causing the current to sink to zero. On no account except that of extreme emergency must a series circuit operating at high potential be broken suddenly. Such an interruption causes an enormous rise of potential for a very brief interval, which very often breaks down the insulation of the machine. The arc which follows the plug when it is suddenly withdrawn, is also often dan-

gerous to the operator. If, however, such a circuit must be opened it should be done with a rapid motion and the operator should station himself so that the end of the plug or wire cannot strike him.

STARTING SHUNT DYNAMO

In latter day practice it is very seldom that a shunt dynamo is used with variable potential or constant

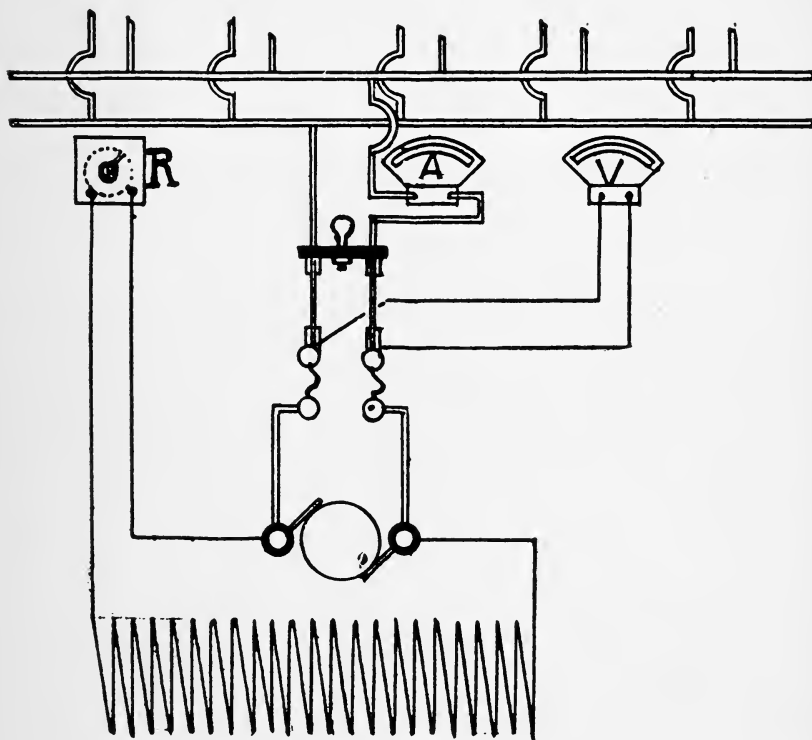

Figure 76

current systems. Such machines are limited to constant potential work and variable currents. The connections of a shunt dynamo and switchboard are shown in Figure 76. The same general considerations that apply to arc machines also apply here.

To start the generation, we first disconnect the machine entirely from the circuit. This is not always necessary, as many machines will build up successfully with the whole load connected. Nevertheless, however, it is safer to disconnect the load. When the machine has been set in motion, we observe the voltmeter and by means of the rheostat *R* regulate the current through the fields, so that the voltage gradually approaches its proper value and remains stationary. When this point has been reached the main switch can be closed and the lights will burn.

Unlike the series arc machine the shunt machine can do nothing while there is a short circuit on the line. There being no regulator the current immediately rises to its highest possible value and the pressure of the dynamo sinks to zero approximately. This machine cannot be started while it is connected to a short circuit, because all of the current generated will flow through this "short," which acts as a shunt to the fields. The "short" coming on while the machine is working will cause a momentary rise in current strength; it will also act as a shunt to the fields and deprive them of all current, thus finally reducing the E.M.F. of the machine until no more current is generated. If the armature is wound so as to stand this current for a fraction of a second, it will do no harm to the dynamo.

In large installations it is customary to operate a number of dynamos in parallel. During the day, when the load is light, it will be taken care of by one of the dynamos and as the load increases more machines will be connected to the board to help out the

first one. If we have nothing but plain shunt machines, it is not advisable to attempt operation in parallel. It is practically impossible to keep two shunt machines at the same potential, and the one having the higher voltage will take the greater part of the load and also, when the difference amounts to as much as a few volts, run the other as a motor. This accident occurs frequently, and generally with so little disturbance that the attendants know nothing about it unless they happen to observe the belting or ammeters.

When a number of plain shunt machines are to work on the same installation, it is best to divide the system and give each machine a share of it. If this cannot be done, the voltage of the two machines must be constantly watched and adjusted by means of the rheostat.

For operation in parallel it is customary to provide compound dynamos. The arrangement of the wiring on such machines is such that when one machine takes more than its share of current it strengthens the fields of the other and thereby causes the potential of the other to rise until it draws its share of current. Compound machines when properly designed and driven by good engines, can be operated together with perfect freedom, no matter what the difference in capacity of the machines may be.

The connection and operation of two or more compound machines can best be understood if we refer to Figure 77, which shows the machine and switchboard connections of two such machines. It is essential to see that the ammeters A are cut in, as shown in the

diagram. If they are cut into the same side as the compound winding, the indications will be very unreliable, since the current from this side of the machine has two paths through which it may flow to the board; one through the fields of the other machine and one through the main of its own dynamo. The equalizer

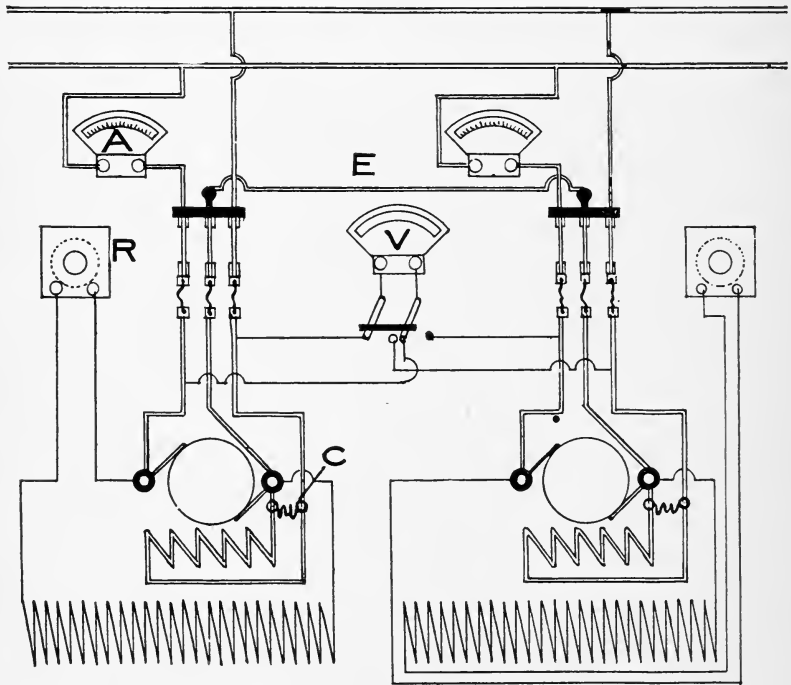

Figure 77

wire **E** should be of ample size, the lower the resistance of this wire the closer will be the regulation of the two machines. The main switches of the dynamos should be so arranged that the equalizer will be connected slightly before the other two wires are and on no account later. In order that such dynamos may work at their best, they should be run at exactly the

proper speed. If this is not the case, the relation between the shunt and compound winding will be disturbed. If, for instance, the machine is run above its intended speed, the magnetization of the fields will have to be below the usual point of saturation, and in this case the magnetization due to the series current will be greater than it should be and the rise in voltage higher than intended. If, on the other hand, the speed is much below normal, more resistance will have to be cut out of the field circuit, and thus the fields may be saturated by the shunt winding alone, so that the series current will have far less effect than it was intended to have, and the rise in voltage as the load increases will not be sufficient.

Many machines are provided with resistances placed in parallel with the series fields, and by means of these the series fields can be strengthened or weakened and in a measure adjusted to make up for variations in speed if they are unavoidable. The location of such resistances is indicated at C.

It will be well also to observe whether the series current circulates around the fields in the same direction as that in the shunt winding. If it does not, the series winding will have the opposite effect of that intended, and there will be trouble and sparking at the brushes and a large falling off in pressure as the load is increased.

To start a plant of compound dynamos we begin with a single machine. When this has been brought up to speed and is running smoothly, we close the circuit through the fields by means of the rheostat R and adjust this resistance until the dynamo gives the re-

quired voltage. It is better always to see that R is high at the start and gradually cut resistance out of it than to start with the resistance in R low. After the voltage is about up to its normal, we close the main switch. This, if there are many lights or motors using current, will result in a modification of the pressure and we must again adjust R until finally it comes to a steady value at what it should be.

If a load heavier than one machine can carry is likely to be found at the start, some of it had best be disconnected or circuit breaker or fuses may go out and cause delay.

After the first machine is started the second is brought up to speed in the same way and the voltage brought up as near as possible to that of the first machine when the main switch may also be thrown in. When this is done, it will be necessary for the attendant to observe the ammeters of both machines carefully and quickly adjust the rheostats so that each machine will receive its proper share of the current. It must be borne in mind that the machine with the higher voltage will take the greater part of the load, and if sufficient difference of potential develops between them it will run the other as a motor.

Before a newly set up machine is thrown in with another, it should be tested for polarity. In order that they may operate properly, similar poles of all machines must connect to the same bus bars. Two simple methods of testing for polarity are illustrated in Figure 78. At the left two lamps of the voltage of the machines are connected between the dynamos to be started and the bus bars, as shown. When the dy-

namo to be thrown in is up to voltage, the pressures of the bus bars and this dynamo must balance, and there can be no noticeable current flowing through the lamps. If, however, the polarity of the new dynamo is different from that of the others, the voltage of the system will be double that of one dynamo and the lamps will burn at full candle power. If the lamps

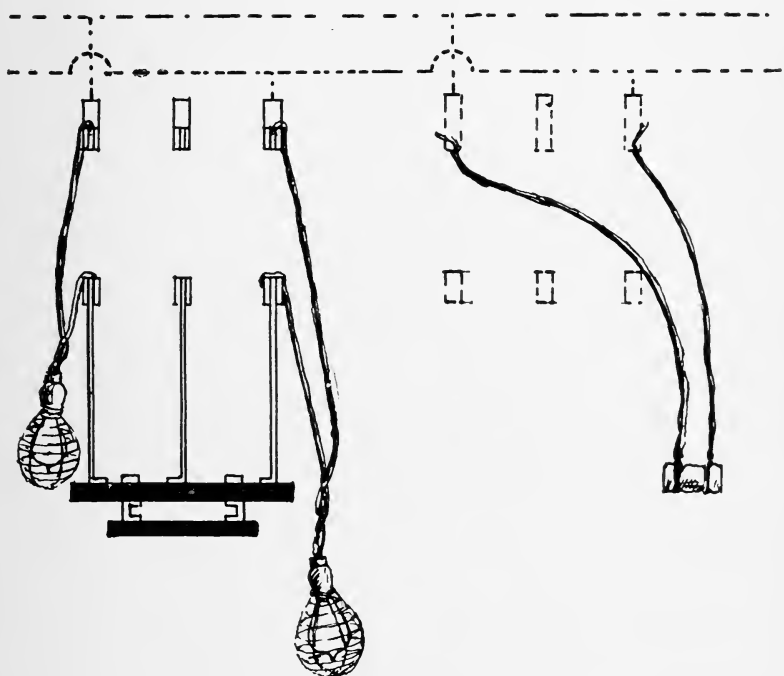

Figure 78

are dark, the polarities of the dynamos are correct for parallel operation.

In lieu of the lamps the test can be made by inserting one wire from each pole of the dynamo into a cup of water and noting the bubbles that form. If the polarity is correct the bubbles will form at the same pole of the switch on both machines. To avoid making

short circuits with this test, the bare ends of the two wires may be wrapped about a piece of wood about an inch long and the whole immersed in the water. Connect the same wires, one at a time, to the same poles of both switches and see that the bubbles come from the same wire.

A switch board arrangement often used with either shunt or compound machines, when engines regulate poorly, or in machine shops and other places where trouble from grounds or short circuits on large motor units are frequent occurrences, is shown in Figure

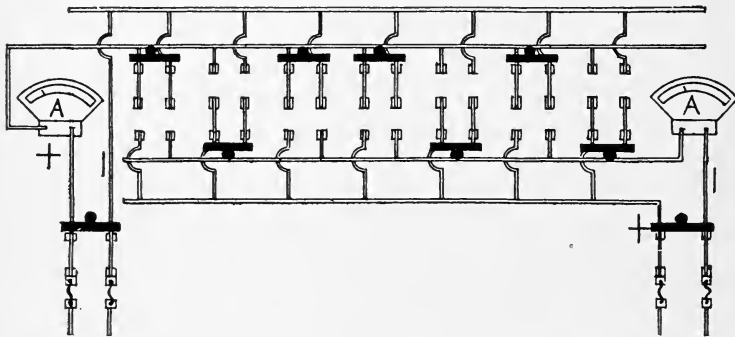

Figure 79

79. In many machine shops, for instance, the capacity of the motors connected is four or five times as great as that of the generators. The assumption is that only a small part of the motors will ever be operating at the same time. When, however, the motor load exceeds the capacity of the generator, as it sometimes does, the generator fuses blow and place the whole installation in idleness. This is also likely to occur in case of trouble on a single large motor, such as are used for metal saws, etc. For the above reasons it is preferable to divide the plant into sections, as

shown. It will be noticed that any or all of the load may be thrown onto either set of machines by means of the throw over switches in the center row. Any desirable division of the load can thus be made. Office lights, for instance, can be separated from the large motors that are constantly disturbing the equilibrium of the lines.

In transferring motors from one machine to the other it is necessary to allow time enough for the automatic release to operate before the switch is closed on either set of bus bars, otherwise the motor is likely to be subject to a severe rush of current if its speed has fallen off much in the interval. If the motor is running light and has great momentum, the switch can be thrown over quickly without much fear of disturbance.

Shunt or compound dynamos if running singly, and if not supplying motors, may be shut down by simply shutting off the engine and letting them come to rest. If, however, there are motors connected to the dynamo, these must be disconnected before the voltage of the dynamo is allowed to go down. A motor heavily loaded may stop entirely when the E.M.F. at its terminals drop off, say twenty-five per cent. It will then be without counter E.M.F., and the armature will form a dead "short" which will blow fuses. The automatic release on the rheostat must not be relied upon in a case like this.

If there are several dynamos operating in parallel and one is to be shut down, it must be disconnected from the switchboard while nearly at full pressure. The pressure may be reduced only sufficient to trans-

fer the greater part of the load upon the machine which is to remain in service. If it is reduced more than this, the dynamo will be run as a motor by the other machine.

COMPENSATORS

Compensators, equalizers, or balancing coils are used in connection with high voltage generators to allow of the operation of lights or other devices at half the voltage of the dynamo. They also come in

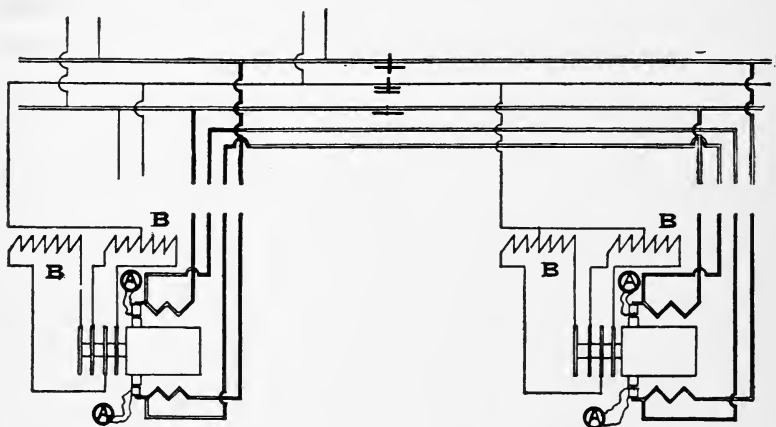

Figure 80

convenient for the operation of variable speed motors since they make two voltages available.

Figure 80 shows the connections of the system used by the Westinghouse Co. The armature of the dynamo is connected so that it can produce both alternating and direct currents. The main current is direct and there is just A. C. capacity enough provided to take care of the unbalanced portion of the load, which is usually estimated never to exceed 25 per cent of the capacity of the generators.

All full voltage apparatus is connected to the + and — buses, and the half voltage equally distributed from the neutral and the two outside wires, so that the load will always be balanced as near as possible. The balancing coils B have the appearance of transformers, but carry no secondary winding. Their object is merely to provide a point at which only half of the voltage of the generator shall exist. Once properly connected they require no further attention except

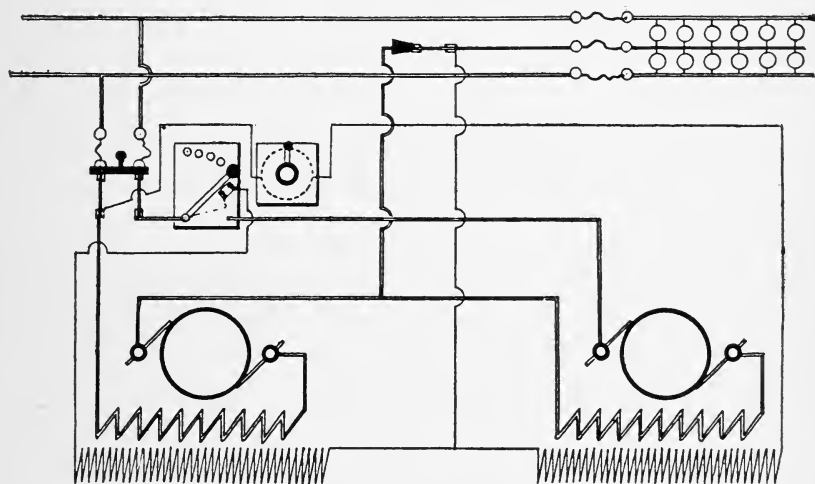

Figure 81

to see that the load is not unbalanced beyond their capacity.

As more or less of the load may come on either side of the dynamo the compound winding is divided between both sides of the generator, which makes it necessary to run two equalizer wires, as shown. An ammeter for each dynamo lead should also be provided. Volt meter and shunt field connections are not shown in this figure, as they are the same as with ordinary generators.

The connections of a balancing set as arranged by the Western Electric Co. are shown in Figure 81. Here two differentially wound motors are connected to the same shaft, so that they must run at the same speed. So long as the same number of lights are burning on both sides of the neutral wire the current through both motors is the same, and they perform no work, but keep in motion.

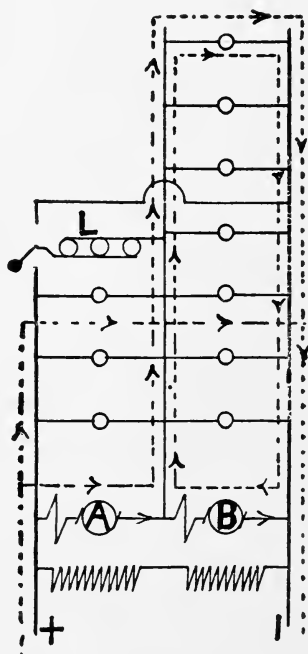

Figure 82

The action of the set can best be comprehended from observation of the elementary diagram, Figure 82. With the load unbalanced as shown, current from the generator will pass through motor A and supply some of the excess load on the opposite side. As this current is in opposition to the shunt fields, it will weaken the motor fields and hence speed it up. This speeding

up will also affect the other motor, the fields of which are not weakened, and hence cause it to act as a generator, thus helping to supply some of the excess load. If the excess load appears upon the other side the conditions will be reversed. Either motor may act as a generator or motor, as conditions require.

The field rheostat is used to equalize the voltage of the two machines and should be placed in the stronger field. Very often the coil on the starting box serves to unbalance the fields and must then be arranged on the opposite side from the field rheostat.

In old installations the capacity of compensators is sometimes overtaxed by the addition of too many lights or motors. In such a case an artificial balancing load is often added, as shown at L. The lamps there shown may be connected to either side of the system, as the case may require.

Storage batteries, as shown in Figure 128, can also be used for purposes of balancing as above.

CHAPTER XI

OPERATION OF ALTERNATORS

The operation of a single phase alternator working alone is not much different from that of a direct current machine. Such machines may be compound wound, as illustrated in Figure 53, in which case that part of the current which circulates around the fields must be made to circulate always in the same direction, as in direct current machines. This is accomplished by means of the rectifier shown in Figure 53. Each of the sections of the rectifier are in connection with one of the collector rings and subject to changes in the direction of current in the same way as the collector rings. The rectifier is mounted upon the same shaft as the armature and moves with it in such a manner that whenever the current in the armature falls to zero the change of brushes from one section to the other occurs.

So long as the brushes are set in this position there is no sparking, but since there is considerable variation in the inductance of an alternating circuit the current is not always at 0 when it should be and, therefore, at times there is very severe sparking. Compound wound alternators are, therefore, not much used at present.

Some generators have two brushes in each lead of the rectifier. The trailing brush is set permanently and the leading brushes alone are changed with changes in the inductance of the load. All alternators

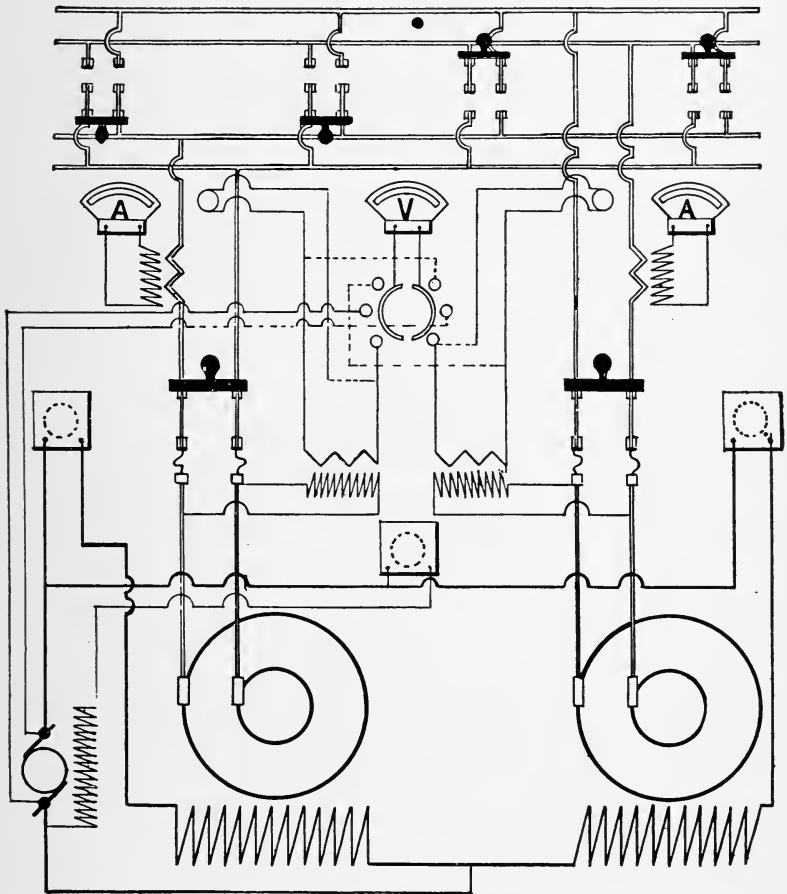

Figure 83

are separately excited by means of a direct current dynamo and the first step, therefore, is to bring this exciter in running order. This is done in the same manner as with shunt dynamos previously explained.

Figure 83 shows two alternators connected to a

switchboard. The instruments are operated through suitable transformers, as is customary with high tension installations. Both machines are excited by the same dynamo, but each, of course, has its own field rheostat, and there is a third rheostat for the exciter. The operation of alternators in parallel, though practical, is somewhat difficult, and requires close attention on the part of attendants; it is therefore often avoided, and the switchboard shown is divided so that each machine can take care of part of the load without being connected to the other. By means of the over-throw switches any or all of the lights or motors may be connected to either of the machines. Transfer from one machine to the other may be made at any time without shutting down motors, provided, of course, the machine will not be overloaded thereby. If a very large motor, however, happens to be heavily loaded, it is best to shut it down and start it again after transferring.

In order to operate alternators in parallel, several precautions are necessary:

They must all run very closely at the same speed and the fluctuations in speed must vary in about the same degree and occur at the same time.

The E.M.F.s of the machines must be the same and they must be synchronized, i. e., they must pass through their respective maximum and minimum values at the same time. In order to get a clearer understanding of this refer to Figure 84. This figure shows two series of sine curves, which represent the currents of two machines. Both machines are working at the same E.M.F., but the one represented by the lower part

of the figure moves through eight cycles in the same length of time that the upper passes through seven. Beginning at the left the polarities of the dynamos are exactly opposite at the same time and there can, therefore, be no cross currents between them. Gradually the lower machine gains on the other until at the center of the figure one is positive and the other negative; at this point they are working in series instead of parallel, which is equivalent to a dead short circuit, so that all of the current circulates between the two machines and none of it goes out to the line. Con-

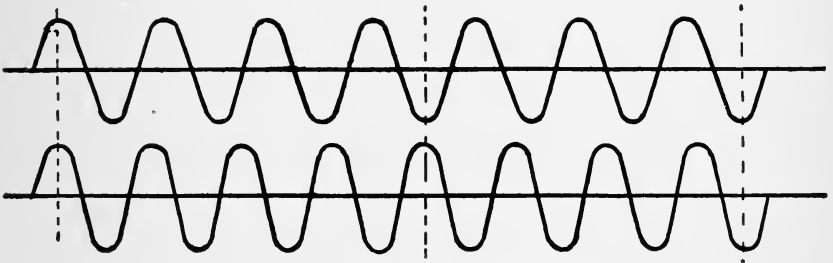

Figure 84

tinuing still farther at the right, they are again opposed to each other and working in parallel. It will be seen at once that two dynamos working in this manner cannot be coupled together without causing serious damage to both of them.

In order to attain smooth and economical operation it is necessary that both machines keep together in speed at all times. If they are nearly so a slight current from the leading machine passing into the lagging one will help operate it and thus speed it up to keep pace with the other, but the less of such a current is necessary the better it is.

If such dynamos are operated from a common shaft it will be well to leave the belt of one of them slack so that the other can easily force it into synchronism. If they are operated by separate steam engines, the piston strokes of the engines should be synchronized. Referring to Figure 85, it can be seen that the engine receives nearly if not all of its power during the time that the crank pin is moving from 1 to 2 and from 3 to 4. During the time it is moving from 2 to 3 and 4 to 1 the steam is not only shut off, but some of it actually forms a cushion, which checks the motion. While these differences in speed caused in this way are not

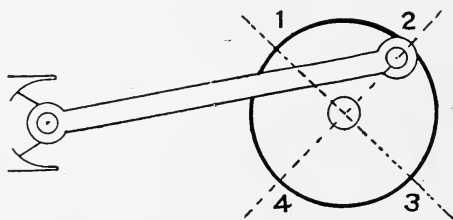

Figure 85

perceptible to the eye, they are sufficiently great to cause very damaging cross currents to circulate between the dynamos.

There are some specially designed machines that do not require such close synchronization. Such machines are provided for operation in connection with gas engines. These engines often miss fire and drop the whole load for an instant, and it is no unusual thing to see the ammeters of such machines swinging from zero to the maximum.

In operating two alternators in parallel we begin by starting the first one, bringing it up to its proper voltage and speed and giving it about the load it

should carry. The other machine is next started and if it has not been tried before the first step is to test it for polarity, i. e., to see that similar poles of both machines connect to the same bus bars. The simplest method of doing this is shown in Figure 86, but this method must not be used with high tension work. If the polarity of the second machine is right, the lamps shown at L will all be bright and dark at the same time. If the machines should accidentally be in phase with each other, the lamps would be dark continually,

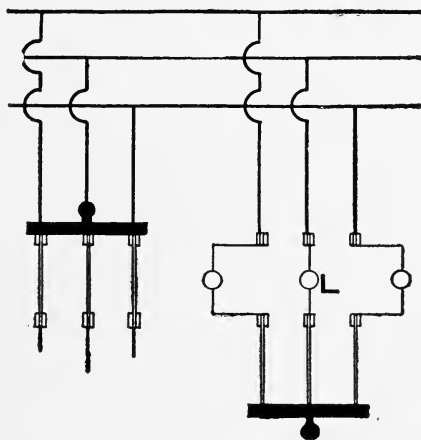

Figure 86

but as this will probably never occur they will alternate between light and dark with more or less rapidity. If the lamps do not go up and down together, two of the leading wires from one of the machines must be changed until the lamps are operating together. Lamps used for this purpose must be capable of standing double the pressure of the system since the only time at which they will be bright is when the dynamos are coupled in series and at double voltage.

The polarity of the machines being in order, the next step is to bring them in synchronism. There are different methods of doing this, illustrated further on, so we shall give here one of the simplest methods, but one that is suitable for low voltages only. In Figure 87 one synchronizing lamp is provided for each dy-

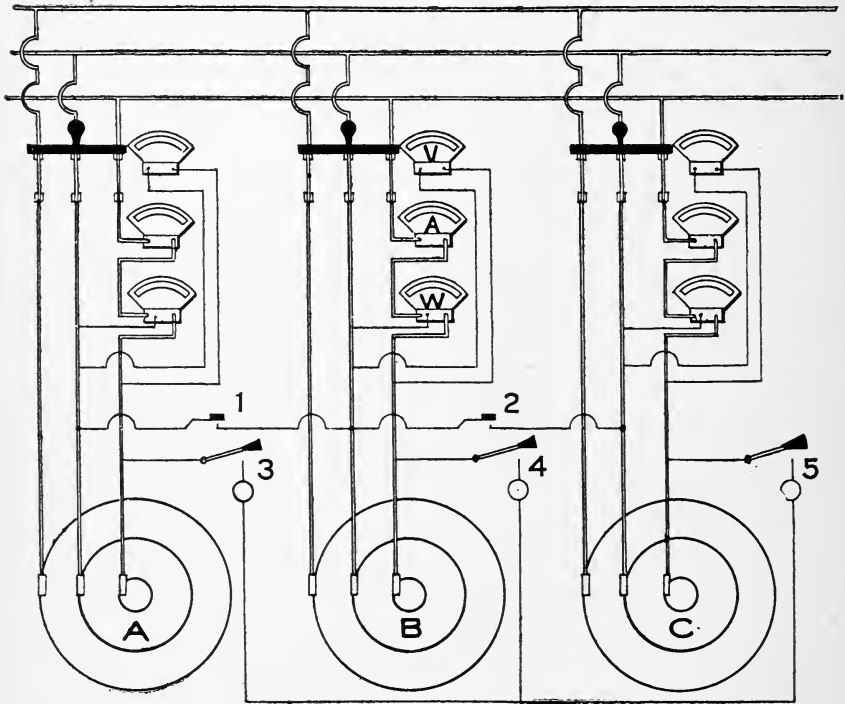

Figure 87

namo, as shown. Suppose dynamo A to be running and that B is to be put in parallel with it. By closing the switches 1, 3 and 4, circuit is established through the two lamps and similar phase wires on the two machines and the lamps are connected to two similar wires. If the voltage of the two wires is the same and the maxima occur at the same time the lamps will be

dark and remain dark as long as the above condition prevails. But if one machine moves faster than the other, the same effect described before will be noticed on the lamps, viz: they will alternately light up and become dark. The nearer synchronism the two machines are the longer will be the periods of light and darkness. The new machine must now be regulated so as to bring it nearly to the same speed as the other, and at about the middle of one of the dark periods when they are of several seconds duration the switch may be thrown in and the dynamos allowed to work together.

It is not possible to divide the load between alternators by simply raising the voltage of one machine, as is done with direct current machines. In order to increase the current in one of the machines, the engine driving it must be made to do more work by giving it more steam, and a governor by which this can be done must be provided. Giving an engine more steam will cause it to speed up a little and thus create a slight cross current, which will help drive the other. If a very great load is to be shifted from one dynamo to another, it is best to speed up the dynamo as above and also to increase its voltage a little, and to perform both operations by small steps, a little increase in power, then a little increase in pressure, a little more power and a little more pressure, etc.

The currents circulating between two machines differing only in voltage are wattless and do nothing but heat the wires. In order to get the best distribution of load an indicating watt meter should be placed in the circuit of each machine and the watts of both of

them kept in proportion to the capacity of the machines. If such instruments are not at hand there must be an ammeter for each, and there should be a main line ammeter which measure the total current. If the sum of the machine currents is greater than the total line current, it is an indication of cross currents flowing between the machines. The dynamos must be so adjusted that the sum of the dynamo currents becomes a minimum. When this is the case the cross currents are at their lowest value.

The rheostats of the different machines should be worked in such a manner that the voltage of the line is not affected more than absolutely necessary while distributing the load. This is done by working the several rheostats a little at a time; increasing one and decreasing another, thus trying out how best the load can be distributed without changing the voltage of the system. If there is a power factor meter for each machine, they should be made to read alike and this will indicate that the machines are working properly.

Some of the larger systems using alternating currents have two systems of bus bars that may be used in parallel or may be separated when occasion requires. When such are to be connected in parallel there are two groups of generators to be synchronized instead of single machines. This is generally accomplished by taking one or more generators out of service of the group which is running at the higher speed. This forces the total load on one engine less and thereby causes the whole group to run slower. When thus the two groups are in synchronism they may be coupled together.

Rotary converters are operated in the same manner as alternators. They must be first brought up to speed by means of some outside source of power, usually an induction motor, or from the direct current side, and then synchronized. If there are several such converters, the load must be divided between them by strengthening the field of the one that is to take more current.

By proper manipulation of the excitation the power factor of a given load can also be materially affected and occasional attempts to improve it will do no harm.

The power factor of a line indicates the ratio of the true power transmitted to the apparent power. To find the real power being delivered by an alternating current system, we must multiply the product of the volts and amperes by the power factor. The power factor of a system supplying incandescent lights only is ordinarily about .95 while with induction motors it is often as low as .70, especially if the motors are not used at proper load. Whenever the power factor is low, the system is operating at poor efficiency.

Long distance transmission lines are frequently designed for very great losses at full load. In such a case the voltage will be too low for satisfactory operation when the full load is being used and if, to overcome this, the pressure of the dynamo is raised it will be too high on circuits that are not heavily loaded. In order to obtain satisfactory operation under such circumstances some means must be provided whereby the pressure on different branch circuits can be regulated without changing the voltage of the dynamo.

The Stillwell regulator is the best known of these,

and is typical of all the others. Each regulator must be provided with two windings and is really a transformer, the primary circuit of which is connected across the mains and the secondary in series with the main current. In Figure 88 S is a double throw switch, by means of which the primary coils Y can be connected so as to raise or lower the voltage of the line. By means of the handle C as much of the secondary winding can be inserted into the main circuit as may be found necessary, and this may assist or oppose the main line voltage. The inductance L is provided to

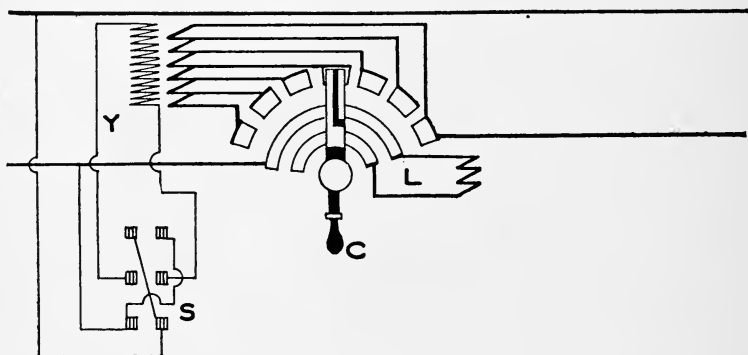

Figure 88

prevent serious short circuiting of any of the secondary coils while the contacts of C are moved from one segment to another. It will be seen that C is split and that therefore during the time that it bridges two segments the currents induced in the coil between them must pass through L.

SYNCHRONIZERS

To connect a direct current generator in parallel with a generator already running the voltage of the

generator to be connected must be adjusted to correspond with the voltage of the generator which is running, or with the bus bars to which the generator is connected. When their voltages are alike the generator circuit may be closed.

When alternating current generators are connected in parallel, the generator to be connected must not only correspond in voltage, but it must also be in "synchronism" with the other generators feeding into the bus bars. Two alternating currents are in synchronism when their phases coincide, or when all changes in their E.M.F.'s exactly correspond. Both must reach a positive maximum value at exactly the same time. If two generators were connected together when their E.M.F.'s were 180° out of phase, or when the E.M.F. of one machine was at a positive and the other at a negative maximum for instance, a direct short circuit would occur. The conditions would then be very similar to those existing where a direct current generator with its polarity reversed was thrown in parallel with another machine. The positive of one machine would then be connected directly to the negative of the remaining machine and a severe short circuit would result.

Where the currents of two alternators are only slightly out of phase, the incoming machine will be brought into step with those already running, but a considerable strain will be imposed on all the machines and considerable current will flow between them. In order to ascertain when two alternators are in synchronism, synchronizers are used. The simplest form of synchronizer consists of two incandescent lamps con-

nected in series between the machines as shown by broken lines in Figure 89.

If the brushes bearing on the same collector rings are to be connected together, or to the same bus bar, it is evident that when the two machines are in phase, or synchronism, the two brushes will at any moment be at the same potential and of the same polarity. The E.M.F.'s of the two generators being directly opposed the lamps connected between them will not burn. This

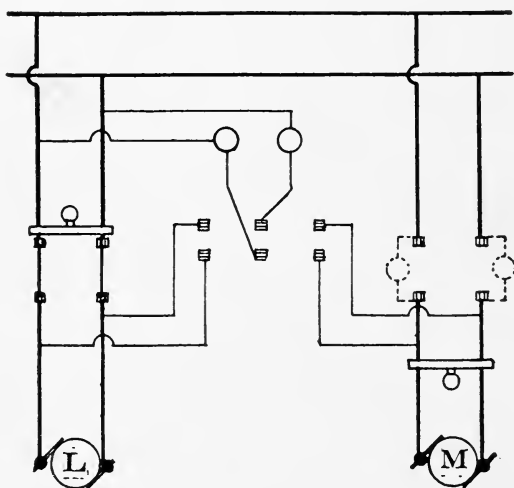

Figure 89

is called synchronizing "dark," due to the fact that the lamps remain dark when the generators are in step. Suppose the currents in the two generators were 180° out of phase. When one of the collecting rings of machine L is positive, the corresponding ring of machine M is negative and the two machines are then generating in series. The two lamps will, therefore, burn at full candle power, the combined E.M.F.'s of the two generators being now impressed on the lamps. Two lamps of the same voltage as the generators or one

lamp of a voltage suitable for the combined voltage of the two generators may be used.

If the two generators continued to run under the same conditions as those just described, and did not change in speed, the two lamps would continue to burn at full candle power; but if one of the machines runs at a slightly slower speed, the positive maximum values of the E.M.F. of this machine would occur just a little later than that of the other, finally falling back to a point where the two generators come again in synchronism, at which point the lamps would be dark. As long as the generators are varying in speed, the lamps will alternately light up and go out, this change occurring more rapidly as the difference in their speed increases and gradually dying out as they approach uniformity. As they approach synchronism the intervals between the time of light and dark will grow longer and when a point is reached where the lamps stay dark for a considerable time, the main switch may be thrown in and the machines run together.

In synchronizing alternators, it is safer to close the main switches just before the point of synchronism is reached than after, as some little time is required to throw in the main switches.

In order that the lamps may be used with either machine and without leaving them continually in connection with either of the machines they may be arranged as shown in the center of the figure. The over-throw switch must be thrown towards the incoming machine.

The use of synchronizing lamps, as shown in Figure

89, is limited to low voltages. Transformers may be connected in the generator circuit, as shown in Figure 90. This arrangement allows the use of ordinary voltage lamps, irrespective of the voltage of the generators. If the transformers are so connected that their secondaries oppose each other when the generators are in step the darkness of the lamp will indicate the point of synchronism. If either one of the primaries or secondaries of the transformers are reversed the transformer secondaries will be in series and assist each other and the point of synchronism will be indi-

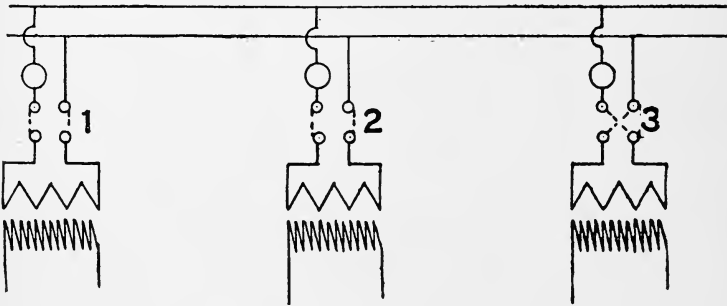

Figure 90

cated by the lamp burning at full brightness. This is known as synchronizing "bright." Either method may be used and both have their advantages and disadvantages.

If both of the plugs used make the same connection as indicated at 1 and 2, the lamps will be dark at synchronism; if one of the plugs reverses connections, as at 3, the lamps will be bright at synchronism. When the machines are running together the synchronizing bus is entirely disconnected. When synchronizing bright, the eye becomes more or less fatigued by constantly watching the lamp and the point of full bright-

ness may be misjudged. On the other hand an incandescent lamp requires considerable voltage before the filament becomes visible and darkness does not necessarily denote that no current is flowing, or the filament may be broken during the time of synchronizing. To overcome these objections mechanical syn-

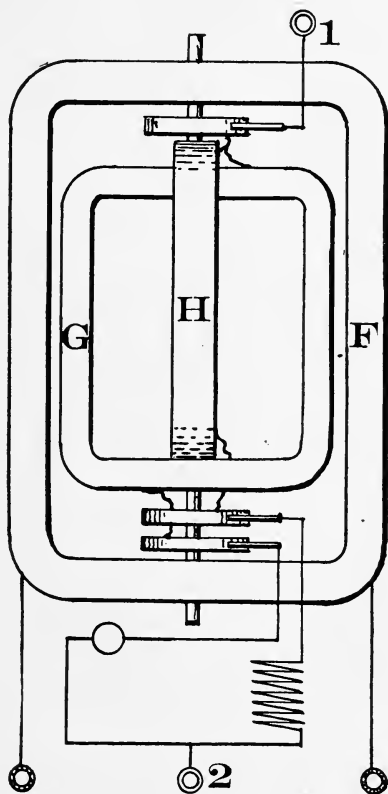

Figure 91

chronizers have been devised and are now generally used, which will not only accurately indicate the exact point of synchrony but will also show which machine is running too fast or too slow.

The Lincoln synchroscope is a device designed for this purpose. The principle of its operation may be

understood by reference to Figure 91, where F represents a stationary field supplied with current through the two lower binding posts on the instrument to one of the generators. The two coils G and H at right angles to each other, are mounted on a shaft and are free to revolve about their common axis. The windings of the movable coils are brought to a common junction and carried to a slip ring mounted on the shaft, connection being made from this point to a binding post at the top of the instrument. The remaining ends of the coils are carried to two other slip rings. Connected in series with one of the coils is a non-inductive resistance (incandescent lamp) and in series with the other coil an inductive resistance or choke coil. From these resistances the connections are brought to a common point and carried to the remaining binding post.

Connection is made from the binding posts 1 and 2 to one of the machines to be synchronized and from the other binding posts to the remaining machine. When an alternating current is passed through the movable coils, there will be a phase difference of 90° between the current in coil G and that in coil H, and a rotating magnetic field will result. This rotating field acting in conjunction with the rapidly reversing field of coil F will cause the movable coil to revolve. A pointer attached to the shaft of this coil indicates the direction and extent of the movement.

As long as the two generators vary in speed the pointer will continue to revolve, turning at a greater rate with a greater difference in speed and slower as the generators approach synchronism. Should the

machine which was running faster, decrease in speed and run slower than the other machine, the pointer would revolve at a slower rate and finally run in the reverse direction. When the machines are running at exactly the same speed, the pointer will come to rest. If the machines are in phase the pointer will come to rest in an upright position; if out of phase, the position of the pointer will indicate the difference in phase between the currents in the two machines.

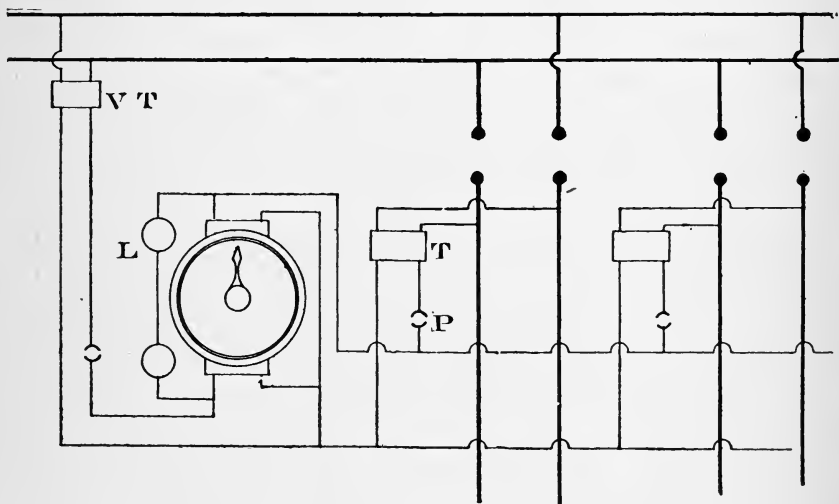

Figure 92

Synchronizing lamps are often used in connection with synchronizers. If the difference in speed between two generators is great, the instruments do not always indicate right, and for this reason the synchronization is started with the lamps and finished off with the instrument. In connecting up a synchroscope it should always be checked with lamps to see that it indicates right. If it does not, some of the wires must be changed until it does.

Figure 92 shows the switchboard connections of the Westinghouse synchroscope arranged for high potential. V T are the voltage transformers, one for each machine, P the plug receptacles and L the synchronizing lamps.

The power factor meter is similar in principle to the synchroscope and the switchboard connections for two phase are shown in Figure 93, and for three phase in Figure 94. If necessary a voltage transformer is cut into the circuit, as indicated by dotted lines.

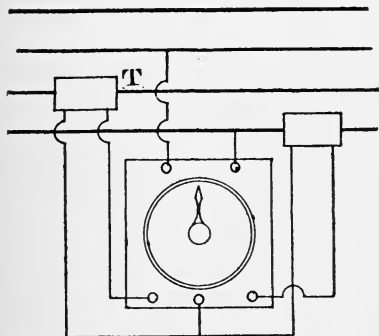

Figure 93

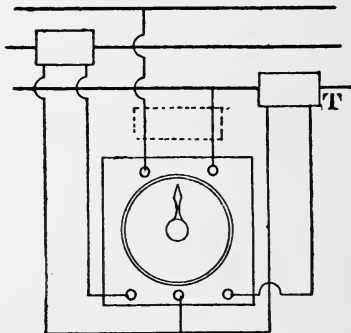

Figure 94

lamps cross connected between the three phases as shown in Figure 95 can also be used for synchronizing in connection with three phase circuits.

Let the two halves of the figure at the right and left each represent a dynamo, both of which are to be operated together. If both are running at the same speed they will be in synchronism and whatever relation as to brilliancy between the different lamps may exist at any moment will exist at all times, i. e., the lights will work in unison either up or down. If, however, one of the machines is moving faster there

will be a steady change in all of the lights. To get a clearer view of this let the machine at the right be moving twice as fast as the one at the left. The E.M.F.s of the two machines will then at any time be represented by the length of the line measured from A, B, C, either up or down until it intersects the sine curves.

To find the brilliancy of any of the lamps A B C we must note the difference of potential between the

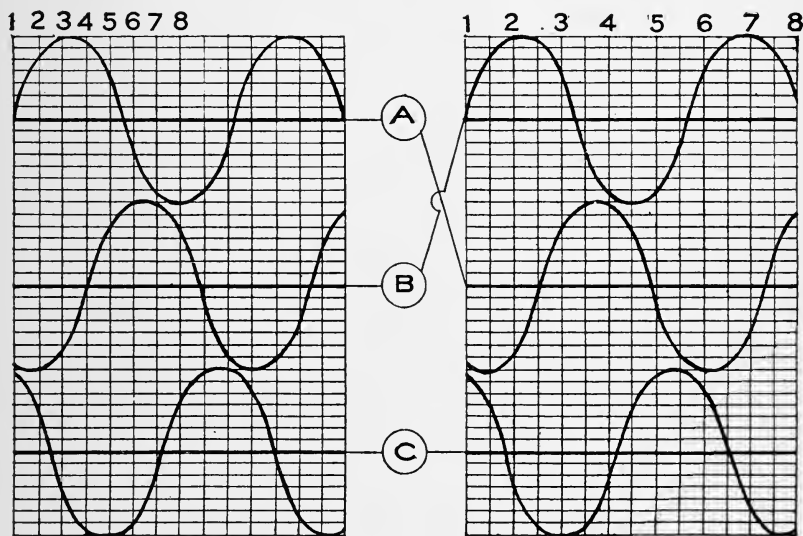

Figure 95

phases to which it is connected. If both E.M.F.s are above the horizontal line they must be subtracted, the lesser from the greater, if one is above and the other below the values must be added, since they represent opposite polarities. Following this out we obtain the table below in which the numbers stand for relative brilliancy, 0 representing darkness and 14 the highest obtainable voltage which is double that of one dynamo.

The numbers 1, 1, 2, 2, etc., indicate the advance in speed of one machine over the other, that at the right moving twice as fast as the other.

TABLE A

	1-1	2-2	3-3	4-4	5-5	6-6	7-7	8-8
A	6	11	2	0	5	4	2	13
B	6	14	9	6	11	3	0	3
C	0	6	4	5	13	11	3	11

With conditions as above the lamps will light up in the order A, B, C. If the machine at the left moves faster than the other the lamps will light up in the order C, B, A and thus give an indication as to whether the incoming machine is running too fast or too slow.

CHAPTER XII

MOTOR OPERATION

We have already seen that the ordinary direct current motor requires some resistance in the circuit at starting to prevent an excessive rush of current during the time the armature is developing the necessary counter E.M.F.

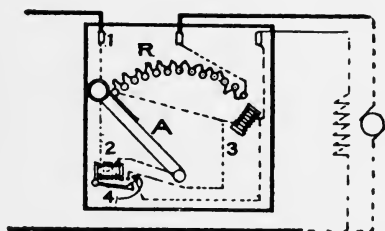

Figure 96

One of the best rheostats for this purpose used in connection with shunt or compound motors is illustrated in Figure 96. This rheostat is equipped with "overload" and "no voltage" releases. Both of these are necessary to protect the motor properly but it is possible to operate motors without them as the ordinary fuse, if of proper size, will take care of the motor. An overload will cause excessive current to pass through the armature and a drop in voltage will do the same thing especially if it is sufficient to cause

the motor to come to rest, in which case the armature becomes a short circuit and will rapidly burn out.

Referring to the diagram, current enters at 1 and passes through magnet 2 and the arm A of the rheostat. Here the circuit is open until the arm is moved to the right; when the arm touches the first point of R current begins to flow through all of the resistance and the armature and at the same time through the fields. It is important that the connections be so made that the field is fully excited before the armature receives much current as the current will flow through the armature much more rapidly than through the fields. It will be seen that the field current passes through magnet 3 and when the arm is finally brought to the last point this magnet engages an iron armature on the arm A and thus holds it at that point as long as current flows through the magnet. Should the voltage of the circuit drop off considerably the magnet will be unable to hold the arm and a strong spring attached to it will force it back to the off position. Should the motor be overloaded the armature of magnet 2 will be drawn up and close the circuit at 4; this will shunt the current around magnet 3 and cause it to release the arm which will then fly back. If desired, push buttons or switches can be attached to this shunt circuit in the same manner at different places, so that the motor can be stopped from any of these points.

Attention is called to the manner of connecting up this rheostat; it will be noticed that the field circuit is never entirely opened. This is an important feature as it prevents much of the destructive sparking

which always occurs when a circuit containing electromagnets is opened. It also saves the insulation of the motor from many very severe strains as a very high E.M.F. is developed for an instant when the field circuit is broken. With this connection this is avoided and the field discharge passes through the armature which acts as generator through this circuit until it comes to rest. If the switch on a motor provided with a rheostat as shown is suddenly opened the arm of the rheostat will not fly back at once but will be held in place by the current generated by the armature for a few moments until it comes nearly to rest.

The rheostat should always be located so that the action of the motor can be observed from this place; if belting, etc., connected to the motor can be seen from the rheostat it will answer the purpose.

The first step in starting a motor is to close the main switch; next move the arm of the starting box slowly and note whether the armature begins to move. If it does not do so it is not safe to continue movement of the arm, but instead it should be returned and the cause of the trouble located. (See Motor Troubles.)

Ordinarily not more than 30 seconds should be consumed in moving the arm from starting position to position of rest. If more time is taken the rheostat coils are likely to burn out. This of course depends very much upon the load the motor may be carrying when starting. If the arm is moved over too fast the armature is likely to burn out. This also depends greatly upon the load it may be carrying at the time. During the time of starting and immediately afterward the condition of the brushes should be noted and

they should be adjusted to point of least sparking. Good modern motors should not spark at all. Motors equipped with starting boxes like the above will generally take care of themselves if for any reason the current should fail. If the starting box is not automatic the switch of the motor should be opened at once in case the current fails; a sudden coming on of the current would either blow fuses or burn out the armature. Motors with such starters should also be disconnected from the service before the generators are shut down at noon or evening. This may be done either by the attendant at the motor or by the man in charge of the switchboard. In all larger, well managed installations it is customary to have certain men detailed to stop and start all motors at the proper time.

Series motors, such as are used on street railways, cranes, etc., unless specially wound or used in connection with a very steady load require constant attention and cannot be operated unless an attendant is always at hand.

ALTERNATING CURRENT MOTORS

Alternating current motors fall into three general classes: Single phase induction motors; polyphase induction motors; synchronous motors. The single phase induction motor requires some artificial means of starting, as illustrated in Figure 63. The direction of rotation can be varied by reversing the connections of either one of the two windings.

The smaller of these motors require no starting boxes. At starting they draw a very heavy current,

usually from 5 to 6 times the running current, but this soon ceases.

With the larger motors up to 5 H.P. the switching arrangement shown in Figure 65 may be used. This switch is shown three phase but may be used equally well with single phase. The switch is thrown to the up position and held there until the motor has gained considerable speed and the heaviest rush of current is over; it is then thrown downward and the motor continues to run but now under protection of the fuses. This throwing over of the switch must be quickly done so that the motor will not lose much speed in the interval during which it is without current.

If an induction motor is overloaded it will often come completely to rest and burn out.

The motor most commonly used for power purposes is the 3 phase motor. Two phase systems are not much used. This motor is self starting and requires no help in this respect. But like the single phase motor the currents required at starting are very much greater than the running current. It is therefore customary to use the same starting devices as with single phase motors, but as this type of motor is used in much larger units than the single phase better starting devices are furnished.

Figure 69 shows a diagram of an auto starter used with 3 phase motor. So long as the switch is in the position shown the current must pass through the reactances 1, 2, 3, and these prevent the heavy rush of current which would take place otherwise. After the motor has attained nearly its running speed the

switch is thrown up and the motor receives the full line pressure.

It is always best to arrange such motors so they can be started without load.

With larger sizes of induction motors the rotor is often wound. In such cases a resistance may be placed in the motor circuit and operated as with direct current motors. The resistance may be fully cut out when the motor attains full speed (See Figure 68.)

Three phase motors may be reversed in direction by changing the relative position of any two wires leading into the motor.

With all induction motors the efficiency is quite low unless the rotor is made with a very small air gap between it and the stator. A very small amount of wear will therefore be likely to bring both in touch and ruin the motor. For this reason great care in the application of belts must be used; too tight a belt will soon wear the journals and allow the rotor to come in contact with the stator.

A three phase motor will not start unless all of the wires are delivering current, but it will continue to run if one or two of the phases are out of circuit. Under these conditions, however, it will draw very heavy currents and very likely burn out.

Polyphase synchronous motors, if there is no other way, may be started by allowing current to flow in the armature while the field circuit is open. This method gives rise to much trouble and is not to be recommended. Such motors should be brought up to speed and started like alternators running in parallel. (See Synchronizers and Operation of Alternators.)

CHAPTER XIII

TRANSFORMERS

The losses of energy in an electric circuit are proportional to the current flowing. The power transmitted is proportional to the product of the current and pressure-amperes and volts. Bearing these two facts in mind, we can easily see that to reduce losses to a minimum we should work with a minimum current, but as we decrease the current we must increase the voltage in the same ratio. To transmit a given amount of power, if we divide the current by 2, we must multiply the volts by 2.

High electrical pressure, it is well known, is quite dangerous, not only to human life, but there is also considerable fire hazard with it and it is furthermore impracticable to use it in many places where, for instance, insulation is difficult. This fact again makes it desirable to avoid the use of high pressures where it is likely that inexperienced humanity may come in contact with it.

In the electric transformer we have the means of using electrical pressure at a low potential, if necessary, inside of buildings, increasing that pressure to a great extent out of doors and reducing it again to a safe potential when we enter the premises where power is to be used.

Since we can raise the pressure to a great extent on that part of the line which is pretty well out of reach of most people, we need but a correspondingly small current and can, therefore, get along with correspondingly small wires.

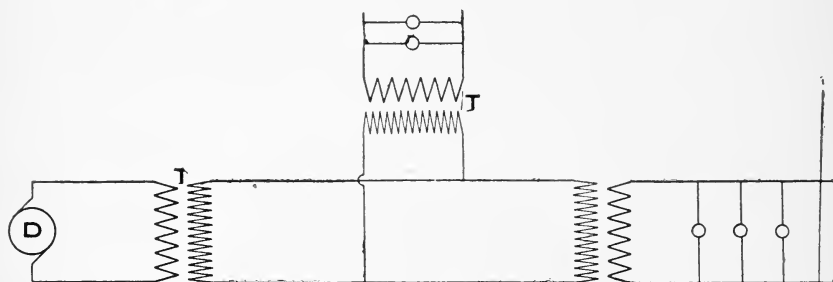

Figure 97

An illustration of such an installation is diagrammatically shown in Figure 97. The transformer T nearest the dynamo is known as a “step up” and the other as a “step down” transformer. A step up

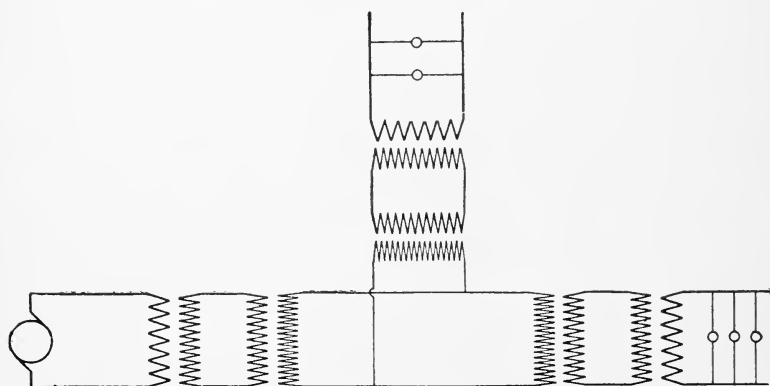

Figure 98

transformer is not always used, very often the full line potential, is generate direct by the dynamo. On the other hand, in many cases a double transformation is required as illustrated in Figure 98. This only as

a safeguard, however, as it has no operating advantages; it merely reduces the liability of breakdown in the insulation.

A complete comprehension of the transformer requires a knowledge of the phenomena of electrical induction and inductance and without this knowledge one cannot intelligently operate or test transformers. The term "electrical induction" describes the inducing of one current by another. We are already somewhat familiar with the phenomenon of lines of force cutting wires, but it will do no harm to touch upon this subject again.

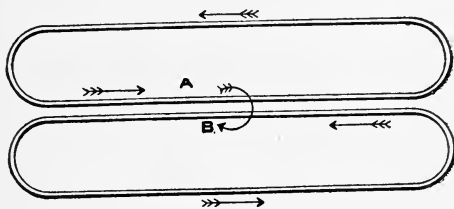

Figure 99

Referring to Figure 99, if a current is started in one of the closed circuits, A, for instance, it will set up lines of force encircling the wire as indicated by the arrow, B. These lines of force we know require power to create and oppose the current which is creating them. So long, however, as their only chance of action is on the same conductor in which the current which gives rise to them flows, their only effect is to retard or check the current flow as long as they are increasing in number. After they have attained a steady value, they no longer retard the current, in fact have no further effect on it until they begin to decrease in number again. If, however, these lines of

force are in position to "cut," i. e., to encircle another closed conductor, they at once give rise to currents in it and these currents since they are created by a force which opposed the original current or force must, of course, be in opposition to it. Thus it is that whenever two closed conductors are laid side by side and a current is set up in either of them, another current opposing the first will be set up in the other circuit. Thus the first current is said to induce the other and is spoken of as an inducting or primary current, while the other is known as the induced, or secondary current. The phenomenon above referred to is that of electrical induction and every change in current strength and direction in one such conductor will be followed by a corresponding change in the other.

We have seen how an electric current induces another current in a neighboring conductor if that conductor is part of a separate coil. Similar induction also takes place in wires belonging to the same coil, as these are also cut by the same lines of force and as this opposes the original current, it gives rise to what is known as the counter E.M.F. of self-induction, or self induction, or inductance.

We have now a clear view of these two phenomena; that the primary coil tends to induce currents in the secondary coil and also opposes itself. We have also seen in previous chapters that both of these effects are largely increased if the wires are wound upon an iron core having high magnetic conductivity. With every good transformer there is a magnetic circuit of very high conductivity, so that the self induction of the primary circuit is very great. In fact, it is the aim

of all builders to make it so great that very little current will flow while only the primary coil is connected.

Now let us examine the effect of the secondary coil. We know that the primary coil induces currents in it which flow in opposition to those in the primary. Furthermore, it is evident these currents must react upon the primary in just the reverse direction that the primary currents react upon themselves, in other words, they tend to lessen the self induction of the primary coil and bring about a greater current flow in it. The secondary coil also, of course, reacts upon itself, but this reaction is again balanced by the greater action of the primary. Thus the whole current flow in a well designed transformer is governed by the secondary coil. If it is an open circuit, no current flows; if one light is turned on, there is some flow; if more are turned on, the current is in proportion, all of course within the range of the carrying capacity of the wires. This interaction of the two currents is called "mutual induction" and it is this interaction which makes the transformer so useful and efficient.

In practice the electric transformer consists of an iron core upon which two separate coils of wire are wound.

These two coils must be insulated from each other, but should otherwise be as close together as proper regard for safety will permit. One of the coils of wire is usually subject to much higher pressure than the other and there is always danger of the insulation between them breaking down. Many fires and some loss of life have been caused by this.

In Figure 100 there is shown a diagrammatic illustration of a transformer having a ratio of 10 to 2; by this is meant that the number of turns of wire in one coil is 5 times as great as in the other; with this ratio the voltage in the coil having the most turns will be 5 times as great as in the other, while in the other the current will be 5 times as great as in the first. In both coils the power will be the same, if they are properly designed; if we neglect the losses due to heating hysteresis, etc., which, however, in large well-designed transformers, should not be over two or

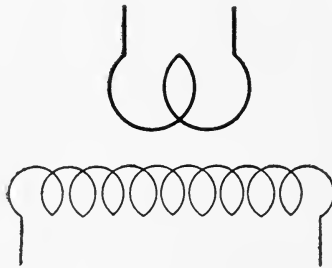

Figure 100

three per cent and if they are operated on full load even less.

In order to see more clearly that the power in both coils is the same, we must bear in mind that the secondary coil can deliver no more power than it receives from the primary and (supposing a transformer of 100 per cent efficiency) the primary coil must be of such self induction that no current whatever will flow as long as the secondary coil is on open circuit. Hence the primary can deliver only enough power to provide what the secondary is taking and the power in the coils must be always the same.

The losses in the transformer are due: First, to the ohmic resistance of the coils; second, to inefficiency of the magnetic circuit provided by the iron core; third, to eddy or foucault currents generated in the iron core and also in the copper wires themselves (this is very small), and fourth, to hysteresis.

As transformers grow old, they are very apt to lose in efficiency, although some makers have recently produced iron which it is claimed does not deteriorate with age.

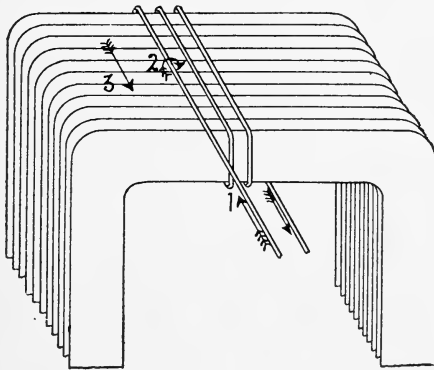

Figure 101

The losses due to ohmic resistance can be reduced by using larger wire of higher conductivity. The losses due to foucault currents are kept at a minimum by “laminating” the iron core of the transformer. Since foucault currents are induced by lines of force which act at right angles to the inducing current, they must flow in the same general directions as the currents which produce them, hence, to introduce as much resistance as possible into their circuit (which is the iron core) it is built up of thin washers insulated from each other, sometimes by thin paper, often by merely

the oxidization on the sides of the plates. The relative position of wire and plates is shown in Figure 101; arrow 1 shows direction of inducing current, arrow 2, direction of lines of force and arrow 3, direction foucault currents would take if the insulation between the laminations did not prevent them.

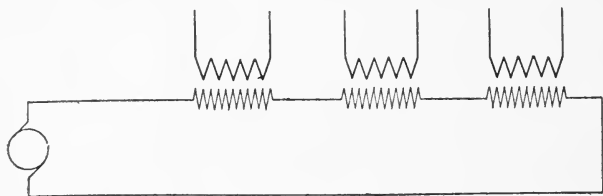

Figure 102

Transformers are connected in series sometimes, as shown in Figure 102. As a rule transformers connected this way are small, each supplying only a few lights.

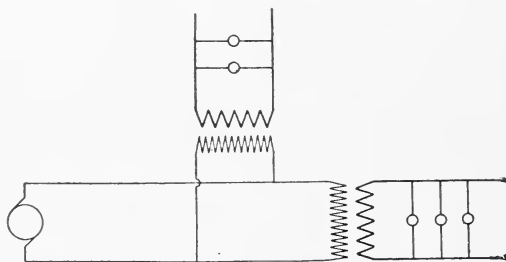

Figure 103

The majority of transformers are connected in parallel, as illustrated in Figures 103, 104 and 105.

Figure 103 is the simplest and requires no other testing than to determine which is the primary wire. This is usually easily determined by simply noting the size of the two pairs of wires which project from the transformer, the smaller being the primary. Should

these wires be identical in size, the resistances of the two coils should be measured. This can be done with a wheatstone bridge or with a voltmeter, the volt-

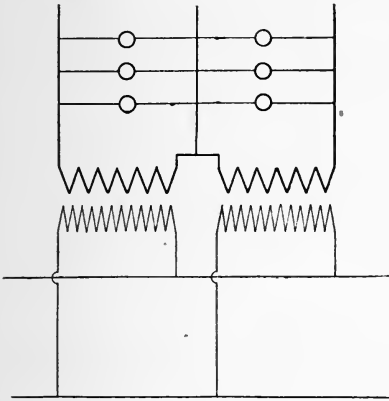

Figure 104

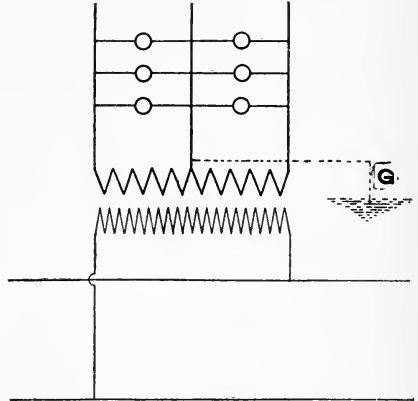

Figure 105

meter test being made as shown in diagram, Figure 106. Use a low potential circuit and direct cur-

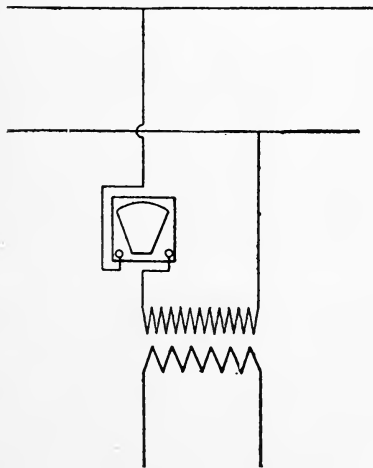

Figure 106

rent if possible and allow no one to come in contact with the ends of the coils as a very high potential may be generated in one of them.

The coil having the higher resistance will show the lowest reading on voltmeter and may be set down as the primary in case of a step down transformer and secondary in case of a step up transformer.

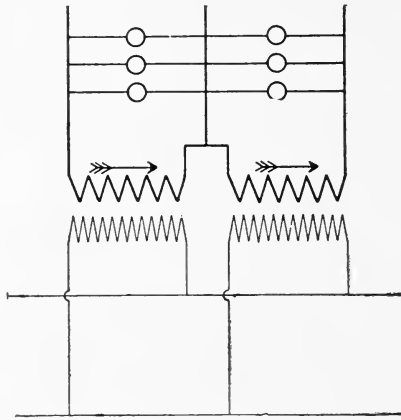

Figure 107

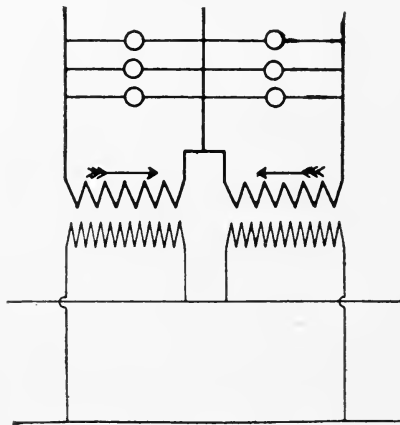

Figure 108

Transformers are often connected so that their secondaries may operate on the 3-wire system. Figures 107 and 108 show the right and wrong connections. Both methods will operate the lights, but with the wrong method the neutral or middle wire will be called

upon to carry double current and the loss in the wires will probably be excessive. With the right method, both transformers will use only as much current as one would use, but they will have double voltage, 2 lights being in series. This method makes possible a great saving in wire. One can easily determine whether such a bank of transformers is connected right or wrong by connecting two lamps across the two outside wires without connecting to the neutral. If the lamps

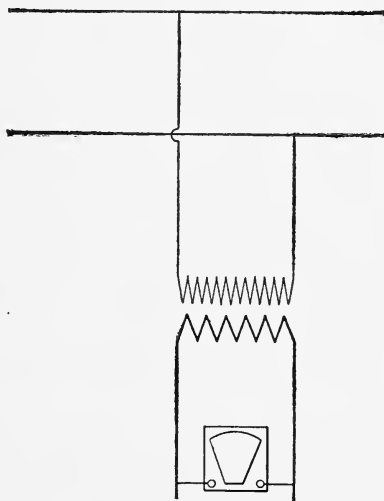

Figure 109

burn properly the transformers are O K.; if they are connected wrong the lights will not burn at all.

When transformers are banked either in parallel or in series it is necessary that their polarity be known. With transformers of the same make, it is safe enough to assume that all are of the same polarity and to connect them accordingly. If, however, transformers of different make are to be run together, they should be tested and marked beforehand. To do this make con-

nections to some direct current as shown in Figure 109. A direct current applied to a transformer will cause one impulse to be given to the voltmeter or galvanometer shown in the secondary. On each transformer mark that wire of the primary which gives a certain deflection on the voltmeter and in banking these transformers, see that these marked wires all connect to the same primary wire for parallel working. For this test a voltmeter whose deflections depend upon the direction of current must be chosen.

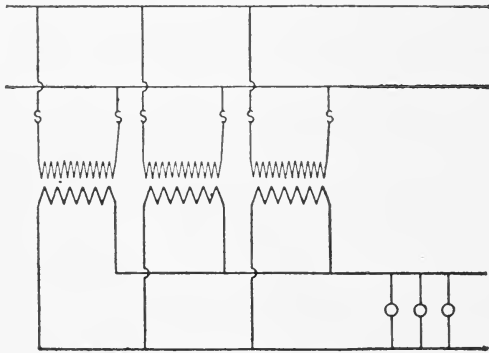

Figure 110

In Figure 110 another system of banking transformers is shown that often leads to trouble. If the primary fuse in one transformer “blows,” it is evident that current from the other transformers will circulate in the secondary and thus add the transformer to the load in lights they have to carry, thus shortly causing other fuses to blow. Small transformers are far less efficient than large ones and this connection should not be used when it can be avoided.

Transformers to operate with a given voltage and frequency must be designed for this. If a higher

frequency is employed than the transformer is designed for, its self-induction will be too great to permit current flow. If the frequency is less than called for by the transformer, it will generate excessive volt-

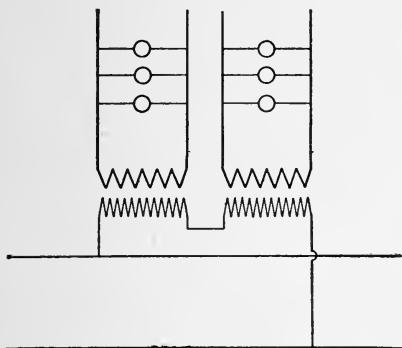

Figure 111

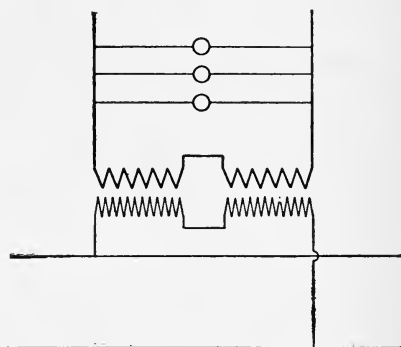

Figure 112

age and overheat the transformer unless fuses are blown.

Two transformers of the proper frequency, but only one-half the voltage of the circuit may be operated in series in either of the ways shown in Figures 111 and 112.

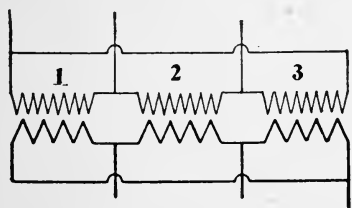

Figure 113

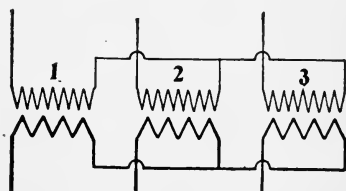

Figure 114

Figures 113 and 114 shows methods of connecting three-phase transformers. Figure 113 shows what is termed the delta connection and Figure 114 the Y or star connection. The delta connection has the advantage that the burning out of one transformer does

not seriously affect the operation of the other two, and even when two transformers fail the third will still operate on one phase. This is not the case with the star connection, one transformer failing seriously hampers the whole group.

Figure 115 is drawn to illustrate the voltage or current relations existing between star and delta connected transformers. S represents the star, and D the

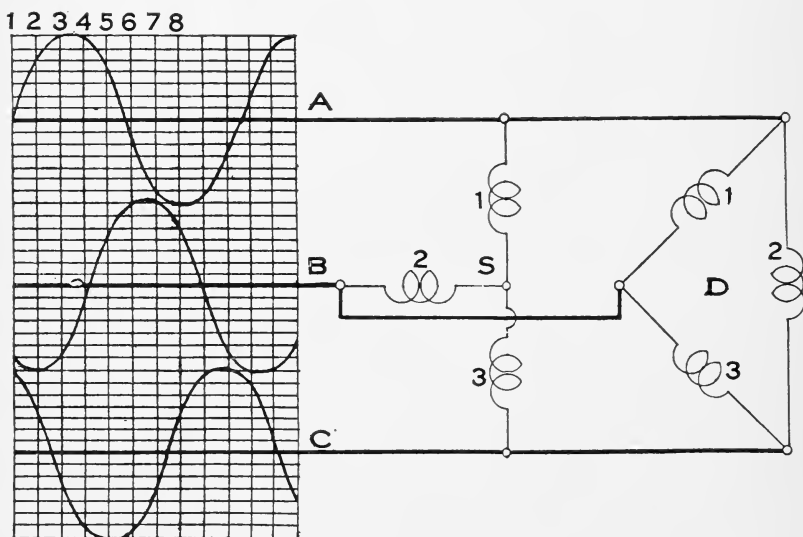

Figure 115

delta connection. Suppose the current be as shown by the curves under 1 at the left. At this instant phase A is at zero, and B is negative and equal to C positive. This leaves S1 without current for an instant and S2 and 3 in series taking the voltage of two phases. Between 3 and 4 A has risen to its maximum positive and B and C are negative and equal. The total current now passes through S1 and divides equally on the return through S2 and 3. At 5 A and

B are both positive and C is at a maximum negative, thus taking all of the current coming through S1 and 2 through S3. The above relation of the current in the different phases will hold for all intermediate positions and it can be seen that at no time is any one transformer coil subject to more than the current of one phase.

If we take up the delta connection in the same way we shall notice that at 1 coil D3 is subject singly to the pressure of two phases. There being no pressure at A, at this point current is also passing through D1 and 2 in series.

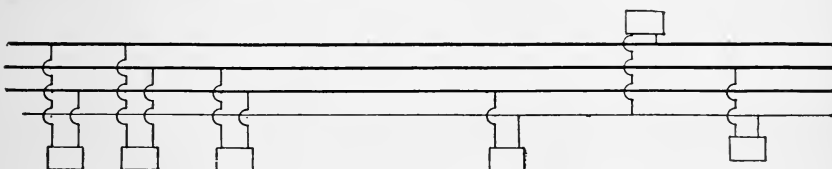

Figure 116

A complete investigation of this shows that with a given circuit for star connection the individual transformers are subject to only .58 of the voltage between the phases necessary, or for transformers to be used with the delta connection. If the same transformers used for star are connected delta, the current required for the delivery of a certain amount of power will be 1.73 times as great for the delta connection as for the star. While many transformers are so built as to be serviceable on either connection, it will not be safe to assume that all of them are and the operator should first inform himself on this point.

Figure 116 shows the methods of connecting up distributed transformers on three-phase circuits. The

three heavy lines denote the three-phase wires which carry the main current and the light line denotes a fourth wire used for balancing. This wire may be run all the way from the generators or may run only between the different transformers. This wire is necessary when a number of transformers located some distance apart are to be connected star, but is not needed for delta connection. It is also not generally used where a bank of transformers are feeding a lot of motors or a big installation of lights. Whether the transformers are connected star or delta, or whether they are located close together or long distance

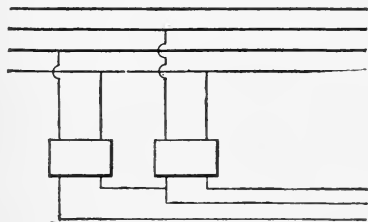

Figure 117

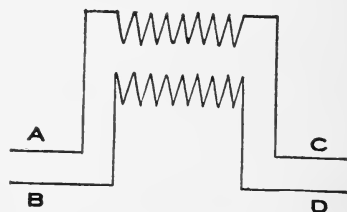

Figure 118

apart, it is always important to arrange so that the load may be as evenly as possible divided between the different phases.

In some instances, to save the cost of one transformer, three-phase transformers are connected as shown in Figure 117. Many transformers are wound so they can be used with different voltages and current. The manner in which this is effected is illustrated in Figure 118. If the ends A B and C D are joined the transformer-windings are fitted for but half the voltage but double the current as could be used if C were joined to B. This latter connection places windings

in series, while the former places them in parallel. In connecting two such coils in series care must be taken that current passes through both in the proper direction, if the connection should be made A C D B one-half of the transformer would oppose the other.

As it often happens that the insulation between the primary and secondary wires gives way and thus great danger to life and property results, it is advisable to ground transformers, as illustrated in Figure 105, the ground wire C being connected to some neutral point on transformer. The shells of all transformers should be grounded.

The principal losses in a transformer are the core losses, due to inefficiency of magnetic circuit, and the copper losses due to the ohmic resistance of the copper.

The efficiency of a transformer can be determined by measuring the power supplied to the primary by a watt-meter and dividing the power obtained from the secondary by it.

The core losses can be determined by measuring the current flowing in the primary while the secondary is open and noting the percentage of this current to the maximum current.

The copper losses are found by short circuiting the secondary winding and applying voltage enough to the primary to cause the full load current in the secondary. The greater the copper resistance, the more power must be supplied to the primaries. This power must also be measured with a wattmeter. Volt and ammeter measurements cannot be used with alternat-

ing currents. This method is due to Dr. Sumpner, and connections are shown in Figure 119.

Every transformer before being connected should be tested for insulation between the two coils and each coil for insulation from the shell, as well as for continuity. These tests can all be made with a wheatstone bridge.

As high potential is nearly always used in connection with transformers, great care is necessary in

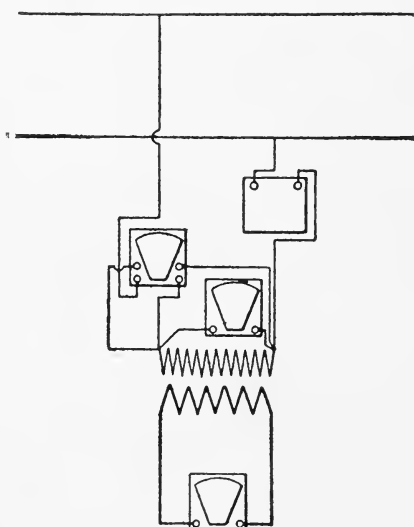

Figure 119

handling them. The following rules should be carefully observed:

Do not handle more than one wire at a time, and touch it only with one hand at a time.

Wear rubber gloves and do not let them be moist.

Keep yourself insulated from the ground and from all other wires.

Do not place fuses in circuit until all connections have been made.

Use enclosed fuses; a small rubber tube over the fuse wires is better than nothing.

If working on a line that is "dead," treat it as though alive. It may be "thrown in" at any moment.

Take no chances, protect yourself by short circuiting and grounding the line.

Be very careful not to part wires, keeping one end in each hand; you will cut yourself into the circuit.

With old transformers especially, and with all transformers that are not grounded, treat the secondaries as you would the primaries.

CHAPTER XIV

BATTERIES—PRIMARY BATTERIES

The term, battery, is applied to a number of cells grouped together either in series or in parallel. It should never be applied to a single cell. Batteries may be grouped according to any of the methods shown in



Figure 120

Figure 120. For all ordinary work, the method at the top is employed. The voltage of this arrangement is four times as great as that of a single cell.

If the same number of cells be grouped as in the center of the figure, the voltage will be but two times

that of one cell, but the current obtainable will be twice that of the above. With the arrangement at the bottom, the voltage will be equal to that of one cell, and the current obtainable four times as great as that from the first figure. The voltage of a number of cells in series is equal to the voltage of one cell multiplied by the number of cells.

The voltage obtainable from any cell is independent of its size or of the distance apart of the plates. In any given cell, however, the current obtainable is proportional to the size of the plates opposed to each other in the solution, and inversely as their distance apart. The distance apart of the plates affects the current only, as it increases the resistance.

The fall of potential when current is flowing is proportional to the product of the resistance of the battery or cell and the current in amperes. If the battery has a high internal resistance therefor, the drop in voltage will be quite great when much current is taken from it.

A battery is placed to the best advantage when the cells are so arranged that their resistance is nearest equal to that of the line through which they are working. If the resistance of the line or instruments is greater than that of the battery all of the cells should be placed in series; if the external resistance is less than that of the battery, the cells should be arranged in multiple until their resistance becomes as low as that of the line.

The resistance of a number of cells in series is equal to the resistance of one cell multiplied by the total number of cells.

The resistance of a number of cells in parallel is equal to the total resistance of one of the series groups divided by the number of sets in parallel.

Primary batteries are divided into two classes; one of these is suitable for continuous work only, and will rapidly deteriorate unless kept at work. The other will very quickly run down when kept in continuous use.

The best known of the continuous current type is the "gravity cell." In this cell the positive pole con-

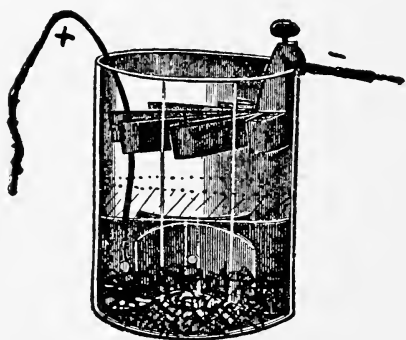

Figure 121

sists of copper located at the bottom of the jar as shown in Figure 121, and the negative of zinc arranged at the top, as shown. Both of the elements are immersed in a solution of sulphate of copper commonly spoken of as "blue stone." This type is suitable only for such work as telegraphy, where very small currents are used. The internal resistance of this cell is very high.

The open circuit batteries are far more in use and exist in many forms and include nearly all of the different makes of dry batteries. Aside from dry bat-

teries, the most notable kind is the Leclanche. In this cell the positive pole is of carbon immersed in a solution of sal-ammoniac, and the negative pole is a piece of zinc immersed in the same liquid, but insulated from the carbon. This cell as well as the different kinds of dry batteries, are capable of delivering a strong current for a short time. If left in circuit, however, in a few minutes they will run down so that no current can be obtained. No matter, however, how badly such a cell may be run down in time it will often recuperate. These cells are universally used for bell and telephone work and consume no energy when not in use.

If the following directions are carefully observed little trouble will be experienced.

Leclanche and similar open circuit batteries.

Use no more salomoniac than will readily dissolve. Five or six ounces is the quantity required for ordinary cells.

Do not fill jar more than three-fourths full of water and keep it in a cool place to prevent evaporation.

See that water does not freeze.

Remove such zincs as become coated with crystals. They are impure and introduce very high resistance in the circuit.

Remove carbons and let them dry out occasionally.

Do not allow battery to be in use very long at one time.

Do not allow it to become short circuited.

If battery has been short circuited disconnect it and it will often pick up again.

CLOSED CIRCUIT BATTERY—GRAVITY CELL

Fill jar nearly full of water and throw in sufficient sulphate of copper (blue vitriol) to give a slight blue color to about half of the water. The blue part of the solution will be the heavier and will settle at the bottom. Enough should be provided so that the dividing line will be maintained about half way between the zinc and the copper.

To start the action of this battery it may be short circuited for a while; it must never be left on open circuit for any great length of time.

ACCUMULATORS OR STORAGE BATTERIES

Storage batteries are used in connection with isolated or central stations, to supply current when the dynamos are not running, as well as at the hours of heaviest load when perhaps the capacity of the dynamos may not be fully equal to the demands made upon them.

It must be borne in mind that it is not customary to provide dynamo capacity for all of the lights and power connected to the system, the assumption being that seldom more than 25 to 50 per cent of the connected load will be used at any one time. If a suitable storage battery is connected to the system, the dynamo capacity may be even less, for the battery can be charged during the slack hours when but very little current is being used for other purposes. Thus, if properly arranged, the dynamos and engines can be kept working at their full capacity and highest efficiency most of the time.

The plates of the cell are of lead (See Fig. 122) and there is always one more negative plate than there is of the positive. These plates are usually contained in glass or porcelain jars for the smaller sizes and for the larger portable batteries of hard rubber. The cells for very large permanent installations are often made up of heavy planking lined with lead.

The positive plate always contains the "formation" which may be either mechanically applied, or

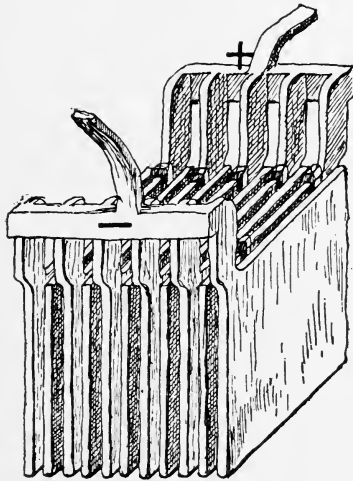

Figure 122

"formed" by the action of the charging current. Those batteries in which the active material is applied in the form of a paste are generally known as the Faure type, while those in which the active material is produced by charging and discharging are known as the Plante type.

The electrolyte used in connection with these batteries is always sulphuric acid diluted to a specific gravity, averaging about 1.20. The acid should be

pure and the water used should be distilled. The battery room should be well ventilated and all iron work should be covered with water proof paint. Wooden floors should not be used. Cement floors are best.

The cells should be well insulated and the specifications of the National Electrical Code should be followed in this respect.

The cells are connected with the positive pole of one to the negative of the other, just as an ordinary battery, and they may also be connected in multiple. Connection in multiple, however, has no advantage that can not much better be obtained by procuring larger cells and is, therefore, very seldom practiced.

The E.M.F. of a cell fully charged is about $2\frac{1}{2}$ volts, and should not be carried much beyond this. When the cell is overcharged oxygen and hydrogen gas are given off. The E.M.F. should not be allowed to fall below 1.8 volts under any circumstances and the nearer at full charge the battery can be kept the better it is. On no account should any battery ever be left standing without charge, and the electrolyte should never be applied unless everything is in readiness for immediate charging.

The connections from one cell to another had better be soldered or welded so as to leave no chance for loose connection.

As the water evaporates, it must be from time to time replenished. This is best done with a hose which may lead the water into the bottom of the jar where otherwise the heaviest part of the solution will concentrate.

In handling water and acid, never pour water into acid; always pour the acid into the water. Much heat is generated when the two are mixed.

Every cell should be tested quite frequently with voltmeter and hydrometer. The best indications of the condition of a cell are obtained by hydrometer tests.

If the voltage of one cell is much lower than that of the others, the cause will often be found to be a short circuit of some kind in the cell.

To charge storage batteries it is necessary that the current pass into the battery in the opposite direction that current flows from the battery when in use.

In most cases it is necessary to charge the battery to a higher potential than that at which the dynamo operates. This cannot be done unless a "booster" of some kind is employed. A "booster" is merely a generator through which the total current passing into the battery flows and in which a certain addition to the voltage of the circuit is made.

Figure 123 shows the connections of a compound dynamo used to supply current to the bus bars, and also to charge a storage battery. In this figure B is a belt driven booster, through which all current passing from the dynamo into the battery must pass and in which the pressure can be raised the desired amount. This booster is provided with fields like an ordinary dynamo, and the field strength can be adjusted. To charge, the double throw switch S is thrown upward and current now passes from the plus pole of the dynamo to switch S, then along wire C to the main cells of the battery and through the battery

ammeter, the booster the other pole of switch S and the minus pole of the dynamo.

To discharge, the switch is thrown downward and current now passes in the reverse direction to the bus

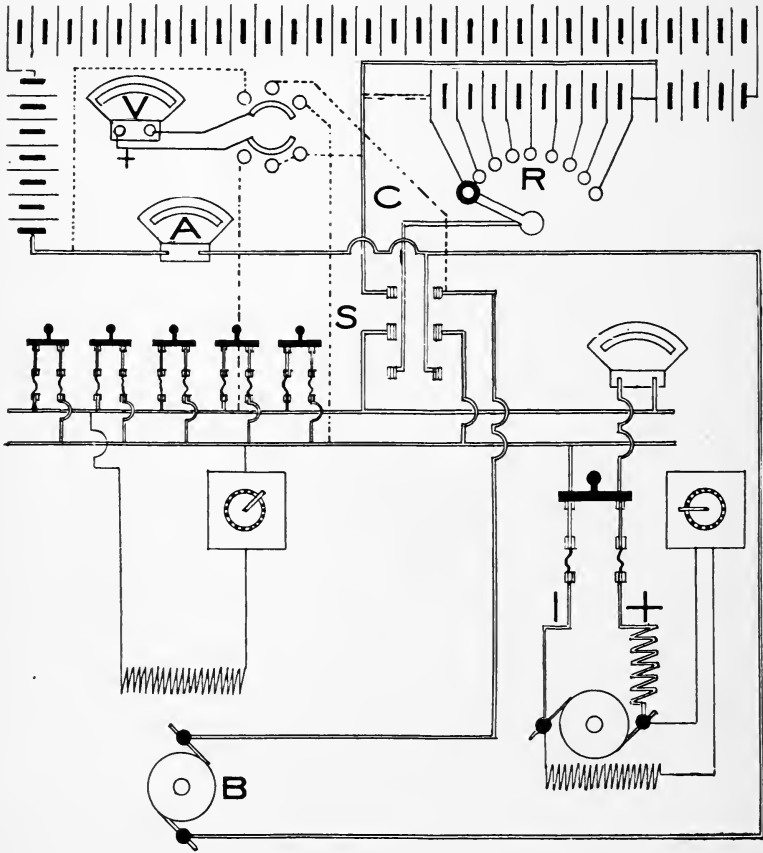

Figure 123

bars, leaving the booster out of circuit. The discharge current, however, must pass through the cells connected at R. In the above case, these are simple lead plates known as counter E.M.F. cells and oppose the flow of current so that by their aid the rate of dis-

charge can be controlled. As the battery discharges and its E.M.F. falls more and more of the cells are cut out. Very often the method of regulation is by means of end cells which are charged at the same time as the battery. In such a case the connections must be as indicated by dotted lines and wire C, as the E.M.F. of the battery falls, more and more of the end cells are cut into the circuit and their E.M.F. added to that of the battery

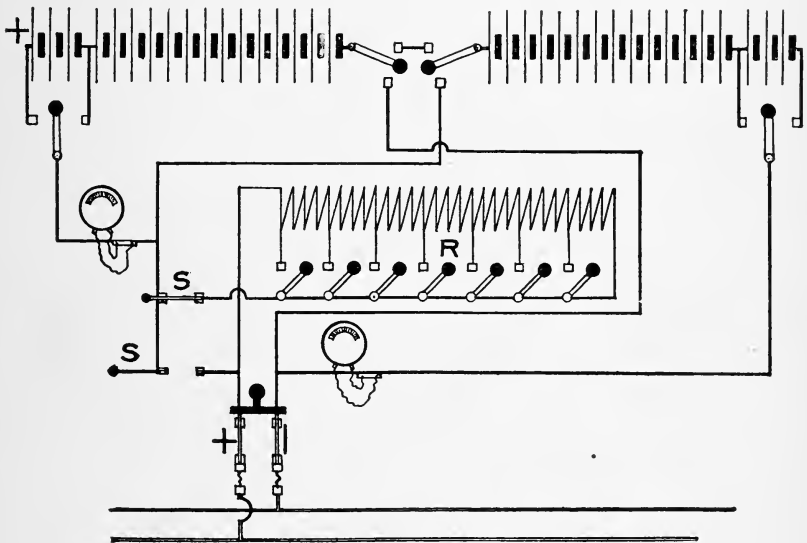

Figure 124

A method of arranging a storage battery so that it can be charged without the use of a booster is shown in Figure 124. This battery is arranged so it can be charged in parallel, and for this purpose is divided into two parts. When arranged for charge the two switches in the upper center are thrown downward and all of the end cells are cut into the circuit so they will be included in the charge. Current now passes

from the positive pole of the circuit through all of the resistance R , and the switch S to the two halves of the battery. As the counter E.M.F. of the battery develops resistance is cut out of the circuit by closing the switches connected to the resistance, beginning at the right, one at a time and as fast as it appears necessary. Closing the last of these switches at the left cuts out all resistance. Two ammeters are provided so the current in both sides can be watched.

Ordinarily this battery "floats" in the system and when arranged for work upper switch S is opened and lower switch S is closed. With this connection the battery will feed into the line whenever the pressure of the line falls below the normal and take current from the line when the pressure is normal or above. Double scale ammeters should be used. They will show whether the battery is receiving or sending current.

When storage batteries are to be charged from alternating current lines, the Cooper-Hewitt Mercury Rectifier may be used.

This mercury alternating current rectifier consists of a glass bulb fitted with four electrodes. Two of these are of graphite and two of mercury. The mercury electrode will not allow a negative current to pass through into the vapor in the bulb, but does not resist the flow of current from a positive source into itself, if that current has been once established. In order to start the flow of current from the positive electrodes P into the mercury electrode N it is necessary to establish a metallic circuit from P to N and when now this circuit is interrupted the current will continue to flow into the mercury from the vapor in the

bulb, so long as the current flow is not broken elsewhere. If for any reason the current flow ceases, it cannot again be started until the metallic circuit has again been established.

The operation of the rectifier can perhaps be best understood by reference to the Figure 125. In this

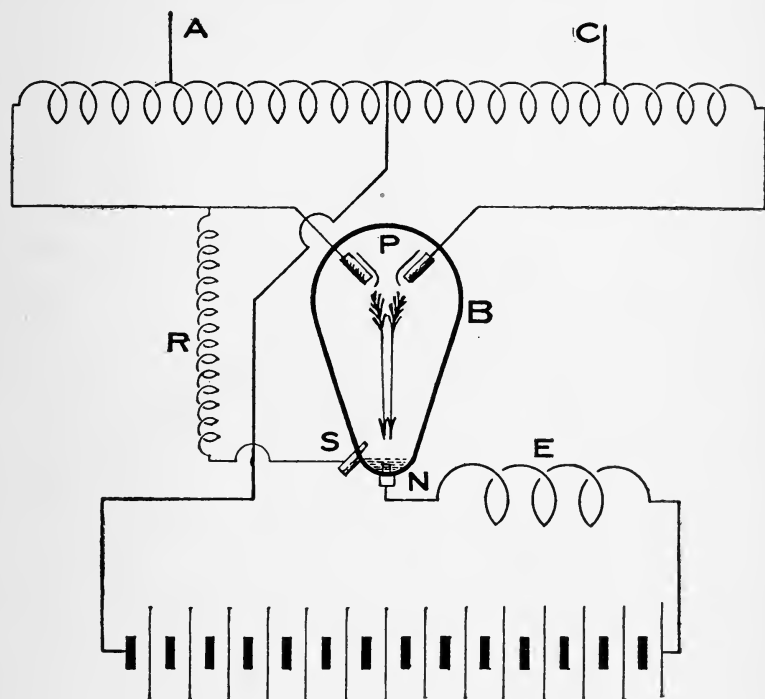

Figure 125

figure, A C is the source of the alternating current which is to be rectified for the purpose of charging the battery. The current passes from whichever side of A C may be positive to the positive electrodes P. So long as the bulb B remains in its upright position no current will flow from P into N. In order to start the flow it is necessary to tip the bulb a little to the

left so that the mercury in the bottom connects N and S. This starts current flow through the starting resistance R, and when the bulb is returned to the upright position the current continues; but not from S but from P. No current can pass from the mercury to the vapor, but there is no hindrance to current flow from the vapor to the mercury, provided it has been started. As the arc lamp maintains itself through the vapor formed by the arc, so the current there maintains itself when started through the vapor. Should, however, only for an instant the current flow be in-

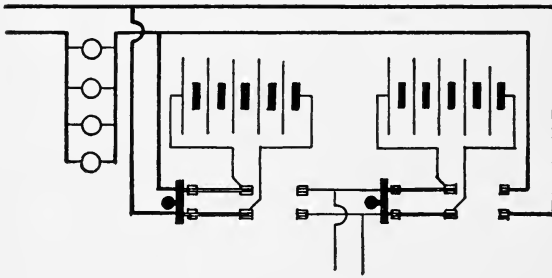

Figure 126

terrupted the bulb would have to be tilted again. It will be seen from the figure that each side of the A C has an electrode at P, and one of these is always positive and from whichever is positive the current flows into the mercury.

A reactance E is cut into the circuit which causes the current to continue after the E.M.F. has fallen to zero until the current at the other side has attained some value so that the flow is continuous.

Storage battery circuits are usually equipped with overload and underload circuit breakers, which pre-

vent charging at too great a rate and also a reversal of the battery current through the dynamo.

Small batteries for use in connection with bell or telephone work are best connected for charging as shown in Figure 126, one battery being connected to the work while the other is charging. This makes it impossible to bring the high voltage dynamo current in contact with the bell wiring which, as a rule, is not safe for such pressures. The rate of charge can be governed by using more or less lamps of different c. p. in the sockets indicated at the right of the figure.

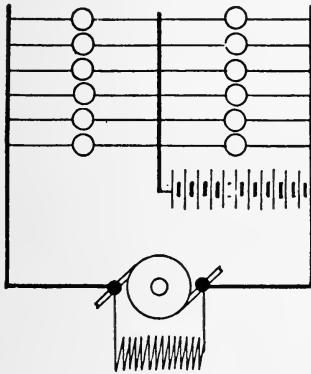

Figure 127

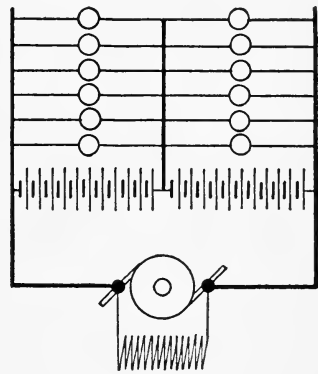

Figure 128

Figures 127 and 128 illustrate other uses for storage batteries. These figures show the elementary connections of batteries used in a manner similar to compensators. It is here made possible by their use to obtain two voltages from one dynamo.

There are so many different types of storage batteries and so many different sizes that it is impracticable to give detailed directions concerning their use. Directions pertaining to any particular battery had best be obtained from the maker.

CHAPTER XV

ARC LAMPS

If we take two suitable pieces of carbon and connect them to a source of electricity and then bring the ends together we shall, of course, obtain a current flow through them. If the contact between the two carbons is not very good, the current will make itself manifest by the heating of the small contact surface to redness. If we now slowly separate these points the current will continue to flow through the intervening air space, forming what is known as the electric or voltaic arc. Where the separation is small the current will be quite strong and a hissing or frying sound will be given out. An arc of this character is generally spoken of as a low tension, or short arc and requires about 25 volts, and, for successful operation, very hard carbons. This type of arc is at the present time very little used for lighting purposes.

If we continue to separate the carbon points the light becomes very unsteady and flickers considerably until at a certain point it begins to improve and we obtain the long, quiet arc. It will now be found that the carbons are separated about $\frac{1}{8}$ of an inch. By measuring the difference of potential across this arc we shall find from about 45 to 50 volts and this is the

proper voltage for open arcs. If we continue to increase the separation of the carbons, the arc will grow longer and become decidedly flaming until finally the separation becomes too great and the arc breaks.

The resistance of the arc is very nearly proportional to the cross section of the carbons and increases with an increased separation of the carbon points. The drop in voltage across the arc is not entirely proportional to this resistance, but is also due to a peculiarity of the arc which causes it to act as though a counter E.M.F. was set up in it.

The temperature of the arc is very high, about 3500° Centigrade, and there is nothing that can withstand it. By its help we can drill through the hardest steel or rock or the most effective insulation with equal ease so that, so far, it has been found impossible to construct anything that can resist it.

The light of a strong arc is very injurious to the eyes and has often caused considerable distress and even temporary blindness. This is especially the case where an arc of two or three hundred amperes is used, as for instance, in the drilling of iron beams, or in electric furnaces where upward of 10,000 amperes are sometimes used. Under all circumstances it is best to view the arc through darkened glasses, although the ordinary ten ampere arc will not injure the eye unless it is exposed to the light very long.

The length of the arc, or the space between the carbons, varies from 1/32 of an inch to one inch. After a lamp has burned for some time, the carbons will be found to have assumed the shape shown in Figure 129. It will be noticed that the upper, or positive,

carbon has been burned in the form of a crater while the lower carbon has been burned to a point. The crater formed in the upper carbon acts as a reflector and it is from this point that the greatest amount of light, or about 80 per cent of the total light of the arc, is emitted. For this reason the positive carbon always occupies the upper position unless, for special reasons, it is desired to throw the greater proportion of the light in an upward direction. It will also be found that the positive carbon burns away about twice as rapidly as the negative carbon. The rapid consump-



Figure 129

tion of the upper carbon is due to the volatilization of the carbon at the crater, considerable vapor being formed at this point which is carried across the arc and condensed on the negative carbon.

If, when the arc lamp is burning in its normal condition, the carbons are separated, it will be found that the upper carbon is heated for a greater distance back from the point than the negative carbon, and it will take longer to cool off. This fact, and the nature of the shadows cast, forms an easy and practical method of determining whether or not, to use the language of the lamp trimmer, the arc is burning right or is

burning "upside down." When the arc is burning with a long separation of the carbon points, the crater almost wholly disappears and the carbons become rounded off.

When arc lamps are used on alternating current circuits a voltage of about 28 is used and the current must be correspondingly increased. Each carbon becomes alternately positive and negative and the two carbons burn to points and are consumed at about the same rate, the difference in consumption between the upper and lower carbon being due to the fact that the heat from the lower carbon rises and increases the carbon consumption of the upper carbon slightly. The alternating current arc is much noisier than the direct current arc for all ordinary frequencies, but with very high frequencies this noise ceases. Many lamps cannot be operated on low frequencies such as 25 cycles per second. It is not practicable to operate any of them much below 25 cycles, as the interval during which the current practically ceases becomes of such length that the vapor between the carbon points cools off sufficiently to entirely interrupt the current.

Any arc light is affected by strong drafts of air. This will often literally blow out the arc and cause rapid feeding and short arcs which in turn bring about very rapid consumption of the carbons. A magnet applied to the arc also has the effect of blowing it out and this fact is often made use of in lightning arresters and in connection with some arc machines where the commutator design is such that severe sparking ensues.

While some of the light of the arc is emitted from

the arc itself, it is, especially in open arcs, but a very small proportion of the total light. Most of the light is given out from the carbon points and the quality of the carbon therefore has a great influence on the character of the light. If a poor carbon is used, the arc rotates about the carbon, this effect being more noticeable when large carbons are used. Impurities in the carbon will also cause the arc to constantly vary its position and more or less spluttering will occur, accompanied by a constant change in the color of the light.

As a rule, the best carbon is the one that has the greatest range from the point of hissing to the point of flaming. With any given carbon these two points vary with the length of the arc. If the arc runs too short we have the hissing sound, when the arc runs too long it is the flaming that annoys us. It is evident that if carbons can be found to burn without hissing or flaming over a long range, we need not be near so careful with the adjustment of the lamp. As this long range of carbons varies also with their purity, the test for range is also a good test for the light giving qualities of the carbon. As a rule, the greater the range of any carbon the more serviceable it is.

The test for range as usually carried out is made in the following manner: Insert the carbons to be tested in a hand feed lamp. Let them burn with a normal current until they have established the proper points. Now feed them together slowly until the hissing point is reached, and note the voltage across the arc (not the whole lamp). Next, separate the carbons slowly

until they begin to flame, and note this voltage. As has been stated before, the greater the range of voltage through which the carbons can be operated, the better they are. The hissing point is usually about 42 volts, and the flaming point about 62 volts.

To test the comparative life of carbons, it is necessary to observe the quantity consumed by a given current and voltage in a given time. This is best done by arranging that the same current, at the same voltage, shall pass through each arc lamp. Then by weighing, before and after burning, the exact amount of carbon consumed in a given time can be ascertained. The approximate useful life of a carbon can be easily determined by burning it for a stated time and observing the amount consumed. The length of the carbon available for burning (not the whole carbon), divided by the length consumed in a given time will give the approximate life of the carbon.

The resistance of carbons is of importance in two ways: first, it consumes energy and, second, some of the forced, high-resistance carbons do not easily strike an arc, i. e., do not volatilize readily enough. The resistance may be measured either with a Wheatstone bridge or with a voltmeter as explained in the chapter on testing. In order to reduce the resistance of the carbons, they are sometimes coated with copper. This will also prolong their life somewhat. Copper coated carbons are more generally used for outside lighting and should never be used on inside lamps unless the arc is entirely enclosed, as hot pieces of copper are thrown off. Another method of reducing the resistance of the carbons is to provide a wire or strip

of metal running through the length of the carbon rod. This scheme is made use of in the flaming arcs where long carbons of small cross section are used.

Cored carbons can be burned at a lower voltage and, if used in conjunction with solid negative carbons will, on direct current, give a very steady arc. The soft core being in the center of the carbon allows that part of the carbon to burn away faster and thus maintain the crater and the arc in one position. Metal electrodes are used in some forms of lamps, various advantages being claimed for them. They always form the negative electrode for, if used on the positive side they are very rapidly consumed.

While there is no definite relation between the size of the carbon and the current, it is evident that there are conditions which must limit us from either extreme. If a small carbon were used with a large current, considerable hissing would result, and the carbon would be rapidly consumed, while with a large carbon and a small current the arc would rotate around the carbon and the light would be very unsteady. The carbon points would not be heated to any great extent and the efficiency would be low. The size of the carbon rods and an outline of the general practice is given in the following table:

ENCLOSED ARC

Volts	Amp.	Upper	Lower
75-80	5	12 in. x $\frac{1}{2}$ in.	$\frac{1}{2}$ in. x $\frac{1}{2}$ in.
to 80	3	12 in. x $\frac{3}{8}$ in.	6 in. x $\frac{3}{8}$ in.

OPEN ARC

Volts	Amp.	Upper	Lower
45	9.6	11 in. x $\frac{5}{8}$ in.	8 in. x $\frac{1}{2}$ in.
to 50	6.8	12 in. x $\frac{7}{16}$ in.	7 in. x $\frac{7}{16}$ in.

HAND FEED

Volts	Amp.	Upper.	Lower
45	5-10	6 in. x $\frac{7}{16}$ in.	6 in. x $\frac{7}{16}$ in.
to 50	25-30	6 in. x $\frac{3}{4}$ in.	6 in. x $\frac{3}{4}$ in.

Arc lamps are generally rated according to candle power. This is a very much abused and misunderstood method of rating. It is evident from an examination of Figure 130 that the candlepower of the arc will depend upon the position from which the measurement of the candlepower is made. Figure 130 will give a general idea of the manner in which this candlepower varies in the case of the ordinary direct current arc. The greatest amount of light is given out at an angle of about 45° with the horizon. Directly above and below the lamp the candlepower is practically nothing, for, in these positions, shadows are cast by the lamp frame. The relative candlepowers at other positions are shown by the length of the radial lines from the center to the curve in the figure.

With alternating current arcs the carbons are al-

ternately positive and negative, and the distribution of light is somewhat different from that of the direct current lamp. The maximum candlepower for an arc consuming the same amount of current is less with an alternating current than with a direct current and

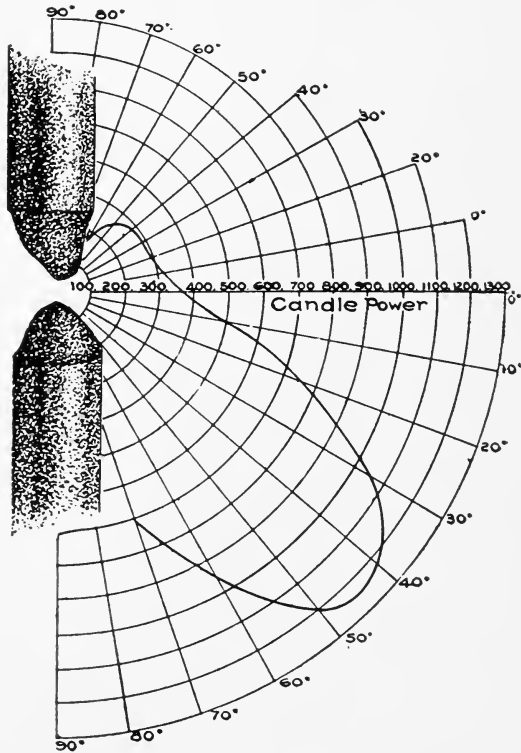

Figure 130

the maximum light is thrown out at different angles. Figure 131 shows the distribution of light from an open, alternating current arc. It will be seen that there are two points of maximum candlepower, one at 40° below the horizontal and the other at 40° above the horizontal.

It is evident from the foregoing description that, to compare the light given out by arc lamps it would be necessary to take into consideration the light given out at all angles above and below the horizontal. This is known as the mean spherical candlepower, and is obtained by taking candlepower readings around the half circle as shown in Figure 130 or Figure 131, and taking the mean. This is given as about one-third the

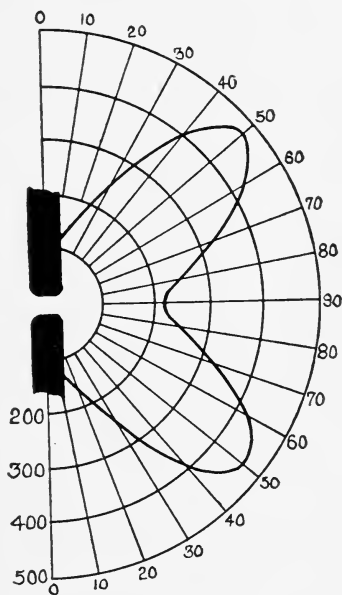

Figure 131

maximum candlepower. For a lamp with a maximum candlepower of 2,000, the mean spherical candlepower would be about 660. The accurate determination of the mean spherical candlepower is a rather difficult procedure and requires the use of special apparatus.

A better method of rating arc lamps now in general use is the wattage rating. The average wattage rating of the various standard lamps is as follows:

9.6 amps., 50 volts, 2000 nominal c. p., 480 watts.

6.8 amps., 50 volts, 1200 nominal c. p., 340 watts.

The proper placing of arc lamps for a given illumination will depend upon the amount of light required. According to many authorities, an expenditure of $\frac{1}{2}$ watt per square foot will give medium illumination such as is used in train sheds while the most brilliant illumination called for can be obtained with 2 watts per square foot. This corresponds to approximately the distances apart as given in the following table:

TABLE B

Medium Illumination			Brilliant Illumination	
Distance Apart	Height		Distance Apart	Height
22 feet	10 to 15 feet	(3 amp. enclosed arcs.)	12 feet	10 feet
30 feet	15 to 20 feet	(6 amp. enclosed arcs.)	21 feet	12 to 15 feet

The higher lamps are hung, the evener will be the illumination.

As a general rule, it is accepted that the distance apart of arc lamps should not be greater than six times their height above the floor. Actual practice, however, in many instances varies widely from this and often the distance apart is 10 or 15 times the height of the lamp, while in other cases only two or three times the height is taken as the distance apart.

With a direct current arc lamp the maximum light is given out at an angle of 45° below the horizontal and very little light is given out in an upward direction. It is evident that a circular area at a distance from the pole equal to the height of the lamp will be very brightly illuminated, and, as we move away from this position the illumination rapidly diminishes. The alternating current arc gives a different distribution of light, the maximum amount of light being given

out at angles of 40° above and below the horizontal. By the use of properly designed reflectors, the light which is given off in an upward direction may be so reflected as to greatly increase the illumination over an extended area and at the same time the bright band of light close to the lamp which is present in the case

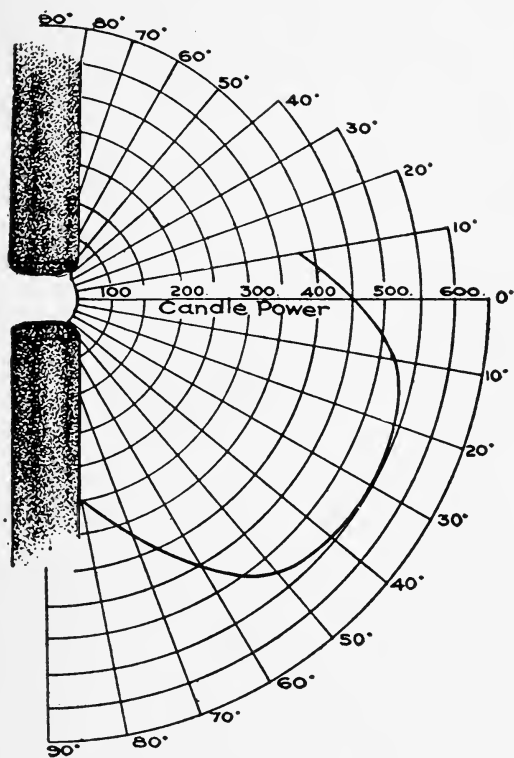

Figure 132

of a direct current lamp is done away with. (See Figure 132.) It is in a measure due to this better distribution of light that the alternating current has come into such general use.

In order to start any arc lamp it is necessary first to bring the carbons together, so that the current can

flow through them and then to separate them to a fixed distance so that the current will be forced to flow through the space separating the carbons and thus produce the arc. There are two general conditions under which this action may take place; one is that of a large number of lamps connected in series, the same current passing through each and the voltage being increased or decreased in proportion as the number of lamps is increased or decreased. The other is that of a single lamp being independently placed in circuit in multiple with other lamps or whatever other devices there may be connected. In the first case each lamp must be equipped with means whereby, should its carbons be burned out or the lamp mechanism otherwise deranged so that current does not flow through the carbons, the current will be automatically shunted around this lamp and continue to feed the balance of the lamps in the circuit, so that only the lamp that is out of order will be left dark.

With the other type of lamp this device is not necessary, because the lamp burns independently of all others and whenever it is out of order there are no other lamps dependent on this circuit for current. As, however, when the carbons are brought in contact the resistance of the lamp circuit is very low, there is likely to be an enormous rush of current through the lamp unless some means of checking it is provided. For this reason every lamp working on an independent circuit must be provided with a resistance cut in series with it which will keep the current from becoming too great while the lamp feeds or the carbons remain together.

In connection with alternating current lamps the same observations apply with the difference that here, instead of a resistance, a reactance is used. The magnet cores are always laminated to reduce the loss and heat due to foucault currents.

The open arc lamp has a number of objectionable features which are causing it to rapidly pass out of use. Owing to the fact that the arc is open this type of lamp is more or less of a hazard when used in proximity to inflammable material. Sparks of hot carbon are thrown off and, if copper coated carbons are used, hot copper is also thrown off. If the lamp is used for inside lighting, such as in a store, for instance, it is absolutely essential that some form of spark arrester be provided. An open arc operates satisfactorily only at from 45 to 50 volts, so that if it is desired to use a lamp of this kind on a 110-volt circuit, a resistance must be provided to reduce the voltage to this amount. This resistance will, of course, consume as much or more energy than the lamp itself, this energy being practically wasted. While two lamps could be operated in series on a 110-volt circuit, this method has not given the satisfaction desired. The open arc must be trimmed, or provided with new carbons, about every 8 to 16 hours, depending on the style of lamp used, and, if the arc is exposed to the weather, they are more or less affected by the wind, a strong wind often blowing the arc out.

All of these objectionable features are overcome in the "enclosed" arc where the carbons, or that part of them in the vicinity of the arc, are completely enclosed in a glass globe. Figure 133 shows the ordi-

nary method of enclosing the arc and, while there are many variations in detail both of the enclosing globe and the cap at the top, the principle of all of them is the same. The glass globe G either sets on an air tight base, or is entirely closed at the bottom. The top of the globe is closed by a cap which is provided in the center with an opening through which the upper



Figure 133

carbon descends. This cap is generally arranged to allow of some play sideways so that the carbon will not bind, should it be of slightly irregular shape, and the joints between the cap and the globe are ground smooth so as to exclude the air as much as possible.

When an arc is started in an enclosure of this kind whatever oxygen is present in the inside of the globe is soon consumed and the arc will then be surrounded

by a carbon gas. The absence of oxygen greatly lessens the consumption of carbon, and, with one trimming, the lamp will burn 100 to 150 hours depending on the size and length of carbon used. The presence of this gas also allows of the use of a higher voltage across the arc with a corresponding reduction in the current strength. A steadier light is also obtained.

Another peculiarity of the enclosed arc will be noticed in Figure 133, where it will be seen that the carbons do not burn to points but remain somewhat

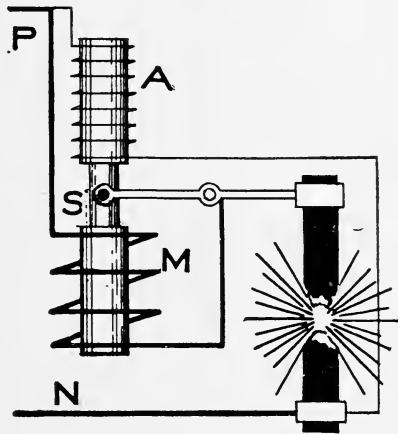

Figure 134

flattened. This results in a better distribution of the light. The enclosed arc requires a voltage of from 72 to 80 volts at the arc, the carbons being separated about $\frac{3}{8}$ of an inch, and is, therefore, much better suited for operation in multiple on 110 volt circuits. The arc being completely enclosed, makes the lamp safe for operation in most any location.

The general principles upon which arc lamps are constructed will be explained in connection with the following figures:

Figure 134 shows in simplified form the circuits of the ordinary differential arc lamp. The series coil M (shown by the heavy lines), is connected directly in series with the carbons, while the shunt coil A (shown by the light lines) is connected in shunt around the arc. These coils are so wound and connected that, when energized, they attract the core S in opposite directions, the series coil M tending to draw it down and the shunt coil A up. The movement of the core depends upon the difference between the attraction of the two coils, therefore it is known as the "differential" winding. Any movement of the core S is communicated by means of the lever arm to the upper carbon.

Normally, in this form of lamp, the carbons are in contact when the lamp is not burning. The operation of the lamp is as follows: Current entering at the positive binding post P has two paths by means of which it may get to the negative binding post N. One of these paths is through the high resistance winding A, and the other through the low resistance offered by the series coil M and the two carbons which are in contact. It is evident that the current will take the easier path through the coil M and this coil will then become energized and the core S will be drawn downward, the upper carbon at the same time being raised, separating the carbon points and producing the arc. As soon as the arc is formed more or less resistance, increasing with the length of the arc, is introduced into the circuit of the series coil and some current will now flow through the shunt coil A, energizing this coil and attracting the core S in an upward direction.

Obviously a point will soon be reached where the attraction of the two coils is equalized and the upper carbon will come to rest.

As the upper carbon burns away, and the length of the arc increases, the current through the series coil becomes gradually weaker and that in the shunt coil stronger, with the result that the core is drawn upward and the carbon points approach each other until a balance is again obtained. The mechanism through which the movement of the carbons is effected and the manner of connecting the various circuits differs in the several makes of lamps. Of these methods the following are in more common use.

In some lamps the carbons are carried by a train of clock gears, and this gearing is under control of the two magnets, operating somewhat in the manner described. In other forms of lamps the series magnet lifts the carbons direct and the office of the shunt magnet is simply to close a short circuit around the lifting magnet and thus to deenergize it so that the carbons may feed. This operation is sometimes reversed, the series magnet being short-circuited after the arc has been produced and the movement of the carbon effected by the shunt magnet. In still another style of lamp a small reversible motor is connected to the carbons in such a manner that it may either bring them together or separate them. The motor is provided with two field windings, which oppose each other, and whichever is the stronger determines the direction in which the motor revolves. In connection with any of these plans it is possible to arrange so that the carbons may be either together or separated

when the lamp is at rest. In the first case the first impulse of current separates the carbons, and in the other it must draw them together to start the arc.

The diagram of the connections of a lamp designed to burn on a series circuit with many others is shown in Figure 135. This lamp has the same differential winding as that previously described and in addition is provided with an automatic cut-out, C. It will be

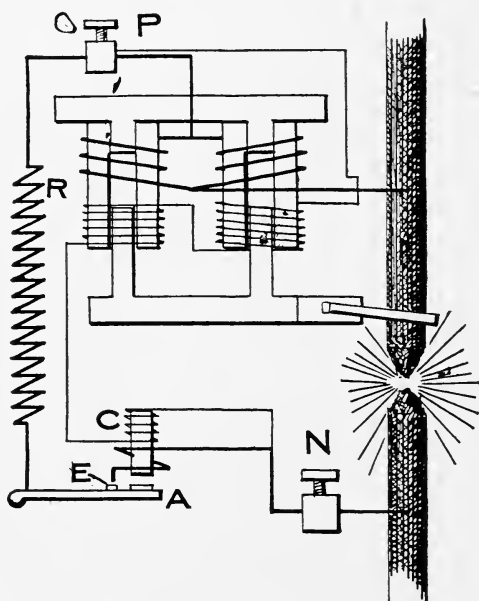

Figure 135

noticed that the magnet winding of this cut-out is in circuit with the shunt coil and the current through it, therefore, increases as the arc grows longer. If the carbons fail to feed, or if the arc grows very long, and in consequence is extinguished, the current flowing through this magnet winding becomes strong enough to cause the armature A to be raised and the circuit at E is closed. The main current now passes

from P, through R, to the armature A, point E, and to the negative terminal N. Thus the current is shunted around the lamp and all other lamps in the circuit are left burning as before. The purpose of R is to maintain some current in the shunt coil. This often starts the lamp again. This style of lamp is never extinguished by opening the circuit, but always by closing a short circuit around the lamp.

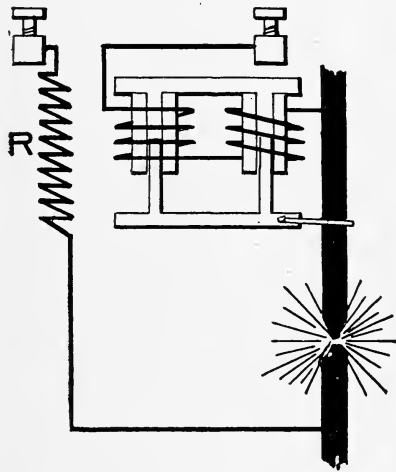

Figure 136

With arc lamps for use on series circuits it is essential for the successful operation of the lamp that both a shunt and series coil be provided. For lamps to be used on multiple circuits, or circuits where the voltage is constant, and where the current flow depends only on the resistance, the lamp will work successfully with either a shunt or series winding. Both windings are not necessary.

Figure 136 shows a type of lamp which is operated with a series winding only. In this case the current

strength varies with the distance apart of the carbons. When the current becomes stronger the magnets become more powerful and draw up the upper carbon, increasing the separation between the carbon points. As the current weakens, the carbons come closer together. This lamp is placed singly in circuit and is

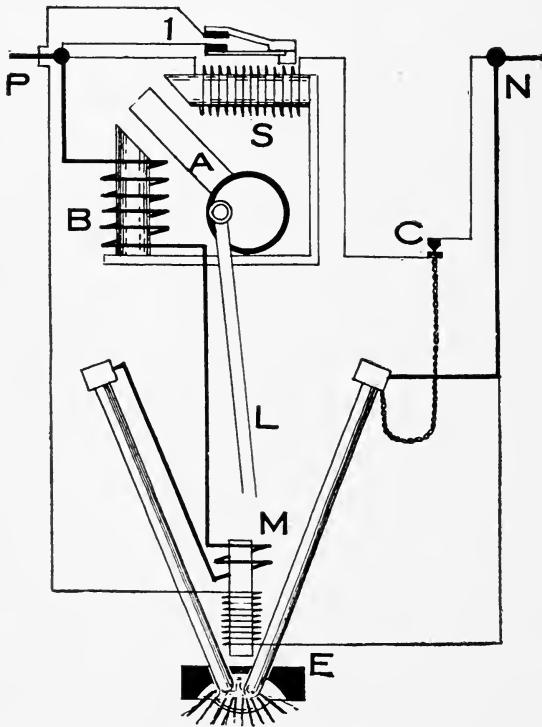

Figure 137

often used on alternating current circuits. *R* is a reactance which with alternating currents takes the place of the resistance used with direct currents and prevents excessive rise of the current strength when the lamp is started. It is evident that a lamp of this type could not be used on a series, constant current

circuit, for the current flowing through the series coil would never alter and would not be affected by the separation of the carbons. While a lamp controlled only by a shunt coil would operate on either a series or a multiple circuit their use on series circuits is not satisfactory, for when starting the carbons must be separated and the shunt coils of all the lamps are then thrown in series, this necessitating a considerable voltage to start them.

Figure 137 shows the circuits of the flaming arc lamp. In this lamp carbons, the cores of which consist of certain chemicals which give to the arc the peculiar color, are used. A much longer carbon is necessary with this form of lamp and the carbons are of small diameter. The operation of the lamp is as follows: When the lamp is not burning the carbons are separated and no current can pass through them until the shunt magnet S has become energized and pulls over the arm A. As it does so the lever L (by means of mechanism not shown) draws the carbons together and this allows current to flow through them. A very strong current now passes through the series magnet B, drawing the arm A away from the shunt magnet S. This action causes the carbons to be separated and establishes the arc. The resistance of the arc lessens the current flow and consequently weakens the series magnet so that the shunt magnet again comes into action and partially draws the arm A away from the series magnet. In this manner a point is soon found at which the arm comes to rest between the two magnets. As the arc burns away the shunt magnet becomes stronger and the series magnet weaker and in

consequence the carbons are brought closer together, i. e., the lamp feeds.

When the carbons have been fully consumed, the small chain shown at the right is drawn down to its limit and opens the shunt magnet circuit at C. This gives the series magnet full control over the arm A and it is drawn all the way over, thus separating the carbons and extinguishing the arc.

The magnet M answers a double purpose. The series winding causes a slight magnetization which tends to force the arc downward away from the economizer E. So long as current passes through the winding of the shunt magnet S the small spring carrying contact is held down and the fine wire circuit around magnet M is open. When, however, the shunt magnet circuit is opened, as by the stretching of the chain, the spring closes the circuit and this causes a strong magnetization to be set up in M which completely extinguishes the arc. This fine wire winding is used only where the arc is operated at high pressure and is not needed on 110 volt circuits.

The operation of this lamp on alternating current circuits is somewhat different from that just described. The carbons rest in contact when the lamp is not burning and, instead of being controlled by the arm A, a small rotor which is under the influence of two opposing magnets is employed. When current is turned on the series magnet controls the rotor and causes it to raise the carbons and strike the arc. When the arc is started the shunt magnet increases in strength and causes the rotor to slow down. As the length of the arc continues to increase the shunt field

becomes strong enough to finally reverse the rotor and feed the carbons together. The method of opening the circuit when the carbons are burned out is about the same as with the direct current lamp. There is no fine wire winding on the blow-out magnet.

OPERATION

The proper care and management of arc lamps requires first of all, that the operator be thoroughly familiar with the principles of operation and all the details of construction of the lamps under his care. It is well, therefore, for the operator to begin by removing the jacket and carefully examine all parts of the lamp so as to thoroughly grasp the purpose and manner of operation of each part. It is also of advantage, if one can safely do so, to watch the operation of the lamp while it is burning.

Lamps are usually trimmed in the following manner: Lower the lamp; remove globe; take out lower carbon; let down upper carbon rod and thoroughly clean it with crocus cloth. The successful operation of the lamp depends to a great extent on the condition of this rod. It must be clean, so that the clutch will firmly grip it. It must not, by any means, be greasy. If the rod becomes dirty it will soon be pitted by the current which passes to it from the contacts inside the lamp and pitting once started rapidly increases. Remove upper carbon and place it in the lower holder. The length of the lower carbon should be measured. A handy manner of doing this is to prepare a gauge of proper length or file a notch in the pliers at the proper point. If the lower carbon is

either too long or too short and the lamp is burned until the upper carbon is entirely consumed, one of the carbon holders will be burned. Place upper carbon in position and align it with the lower by turning it freely about to see that it centers in all positions; raise and lower the upper carbon several times to see that it works freely; clean and replace the globe and raise lamp to its normal position. If circuit is alive test lamp to see that it burns.

It is possible for a good trimmer to take care of 100 or more arc lamps per day, if they are close together. Where they are far apart and conditions are more difficult, 50 lamps will be sufficient.

If the lamp is of the enclosed type, where the lamp clutch feeds the carbon direct, it is necessary to examine the upper carbon to see that it is straight and smooth. Any burs or projections should be removed and the carbon should be raised and lowered to see that it moves freely through the clutch and gas cap.

The care of globes is also of great importance where enclosed arcs are used. Impurities in the carbon are thrown off in the form of a powder, and if this is not removed the useful light of the lamp will be greatly reduced. It is good practice to occasionally return the globe to the shop where they can be thoroughly cleaned. The gas cap must also receive careful attention, for if this does not fit tightly, the operation of the lamp will not be satisfactory.

The following are the principle points to be observed in the handling of arc lamps:

Be sure that the voltage is right for lamps connected

in multiple and the current for lamps connected in series.

Never switch a multiple lamp by shunting the current around it; always open the circuit.

Never open the circuit of a series lamp; always shunt the current around them.

Never try to burn a multiple lamp without an additional resistance in the circuit.

Never place a resistance in the circuit of a series lamp.

Never handle high tension lamps without insulating yourself from the ground.

It is inadvisable to touch the wires on opposite sides of the lamp at the same time. To be safe in this respect confine yourself to working with one hand at a time.

Keep all parts of the lamp clean, especially the rod and the globe.

Provide spark arresters for all open arc lamps where there is inflammable material.

Never leave a lamp without globes where the wind can strike it. The arc will be continually blown out and consume carbons very fast.

If an arc casts shadows or throws considerable light upward, it is an indication that it is burning upside down. To make sure that the lamp is burning upside down, separate the carbons; the one that is red farther from the point is the positive.

A green light coming from the lamp indicates that the carbon holders are being consumed. This will generally occur if the lamp is left burning upside down for a considerable length of time, or if the carbons are not of the proper length.

TESTING

For the testing of an arc lamp practically all that is needed is a reliable voltmeter and ammeter. If series lamps are being tested, it is essential that the machine furnishing current to the testing circuit be in good condition and regulated properly. If a multiple lamp is being tested the voltage of the supply circuit should be constant. The lamp should be located away from draughts of air and with series arcs special precautions must be taken to see that the place upon which the operator stands is well insulated and that under no circumstances can contact be made with the lamp and a ground at the same time. This is of great importance where tests are made on a regular circuit which is in use.

Current and voltage tests can be made and the lamp accurately adjusted to the current and voltage for which it is designed. Detailed instructions are generally given by the manufacturers for the adjustment of each particular type of lamp. These adjustments are generally obtained by altering the connections on the variable resistance or by changing the tension on the springs. Voltage readings should be taken as the lamp feeds and the cut-out if a series lamp, should also be tested to see that the lamp cuts out at the proper voltage. This test is made by slowly separating the carbons until the arc breaks. One of the most common causes of trouble will be found in the cut-out and this should be thoroughly cleaned and tested. A defective cut-out generally results in burned out coils.

SERIES ARC SWITCHBOARDS

The switching of series arc light circuits is a problem altogether different from any other. At the present time, very few new systems of this kind are installed, but there are still quite a number of old installations that must be reckoned with.

Figure 138 shows diagrammatically the well known Thomson-Houston switchboard. In this system there

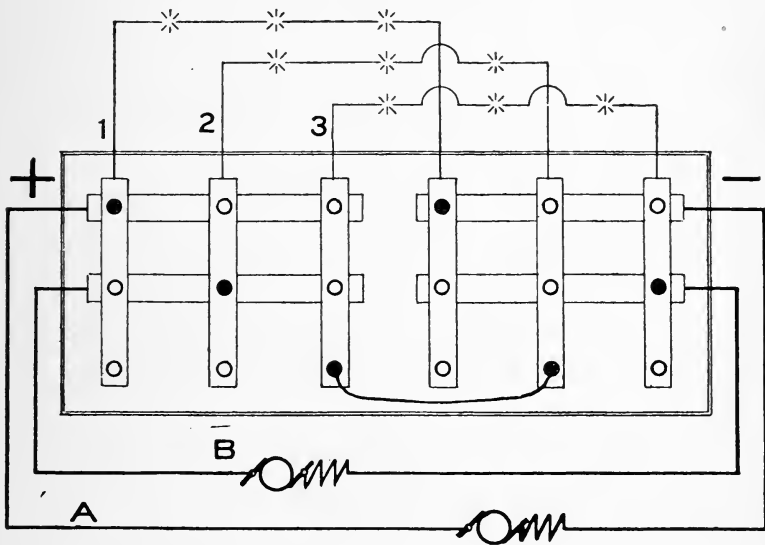

Figure 138

are two horizontal rows of holes, one at the right and one at the left for each machine. There are also two vertical bars containing holes for each circuit on the board. The board may be built for any number of circuits or machines. The lower row of holes is extra and is provided to facilitate connecting several or all of the machines or circuits in series.

The machines are connected to the circuits by means

of plugs which pass through from the front of the board and connect the horizontal bars to the vertical at whatever point a plug may be inserted. If a plug be inserted where the positive side of machine A connects to circuit 1 and another where circuit 1 feeds into the negative side of the same circuit, machine A will be in position to operate this circuit. The position of plugs is indicated by the black circles and by tracing out the circuits it will be seen that machine B is supplying circuits 2 and 3. All of the positive leads of the machines go to one side of the board and the positives of the circuit must be connected to the same side. Whenever it is desired to run several circuits from one machine the negative of the first circuit must be connected to the positive of the next.

If circuit 3 is to be disconnected from machine B, insert plug where circuit 2 crosses bar of machine B, at the right of board. This will put out the light of 3 and the plugs may now be withdrawn.

Another style of switchboard for the same purpose is shown in Figure 139. Here the connections from machine to circuit and from circuit to circuit are made by flexible cables, which carry suitable plugs at each end. In this diagram machine A is supplying circuit 1 and machine B circuits 3 and 4. Three holes are provided at the terminals of each circuit and machine to allow of the use of auxiliary plugs in switching. If circuit 2 is to be added to machine A, auxiliary plugs are used as shown by dotted lines. The main cable C from minus side of circuit 1 may now be withdrawn. This will force current through circuit 2 and the permanent plugs may now be placed

in the center of the holes. If circuit 2 should contain many lights or be open, a long flash would accompany the withdrawal of the plug.

To disconnect circuit 3 from machine B insert auxiliary plug, as indicated by broken line and withdraw cables D and E.

When it is desired to dispense with one of the machines and let the other do all of the work, the transfer can be made without disturbing the lights by first

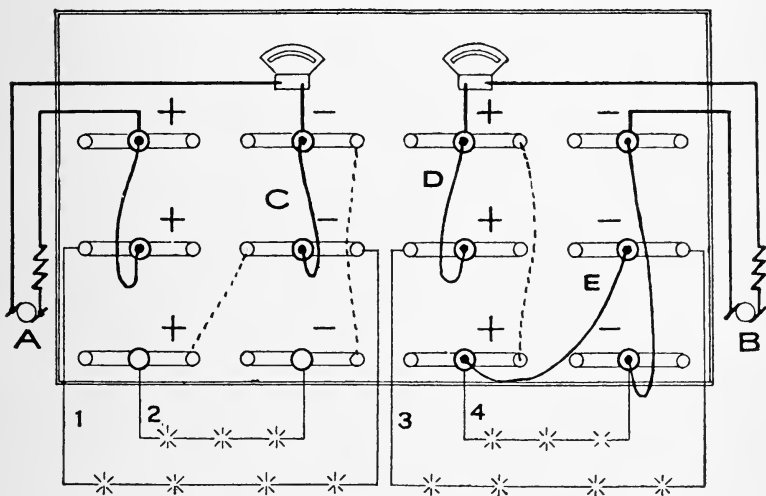

Figure 139

connecting the two machines in series on all of the circuits in use. When this is done, short circuit the fields of the machine A that is to be cut out, and then short circuit the whole machine and disconnect it.

Switching arc circuits is somewhat confusing to one who is not familiar with it, and it is advisable for any beginner to study out the best methods for the particular board with which he has to work. He should

have the whole system in his head so as to avoid the necessity of studying over the problem when circuits are to be changed in a hurry.

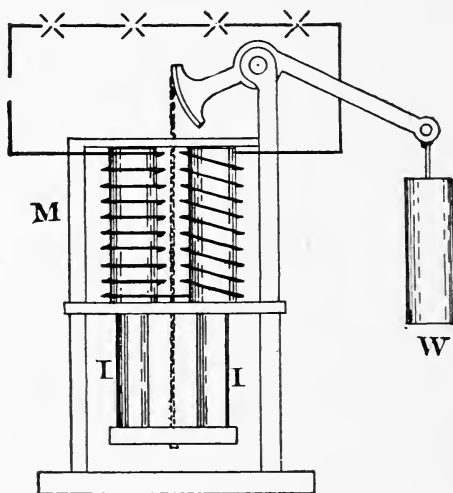

Figure 140

Figures 140 and 141 show methods of controlling alternating current arcs operating in series. In Fig-

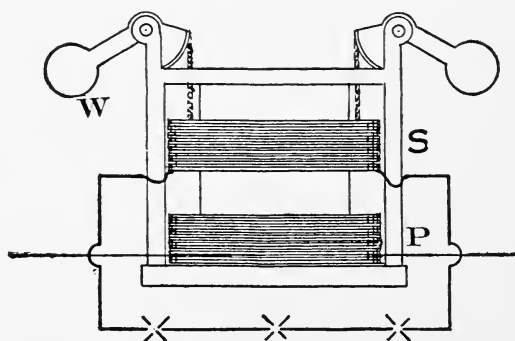

Figure 141

ure 140 the weight *W* balances the two cores of the coils *M*. When a current passes through these coils they draw in the cores and in so doing increase the

reactance of the circuit. This in turn cuts down the current. In the above manner the device automatically regulates the current and keeps it very close to its predetermined value. This device is used only for constant current arc lamps.

A somewhat different principle is employed in Figure 141. In this figure P is the primary coil of a series transformer and the current from the gen-

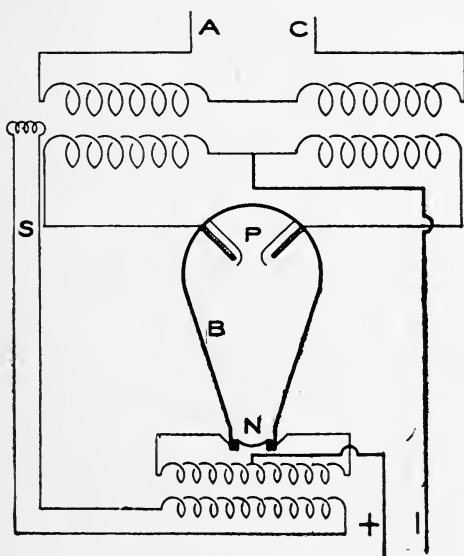

Figure 142

erator always passes through it. This current induces secondary currents in the coil S. This coil is balanced by the weights W, and is free to move up or down. If the current in the secondary increases beyond a predetermined amount, the repulsion between the two coils is increased and the upper one rises. This lessens the induction and cuts down the current. If the current becomes weak, the operation is reversed.

Where it is desired to use direct current arc lamps from alternating current circuits, the Cooper-Hewitt Mercury Rectifier is often used. A diagram of the connections of this device is shown in Figure 142. The principle upon which this is based is outlined in another chapter and need not be repeated here. It is well known that the current can pass from the positive electrodes P into the negative or mercury electrodes N when once established, but cannot pass from the negative electrode to the positive.

In order to start the operation, the glass bulb is tilted a little so that the mercury of the two lower electrodes unites; this starts current from the starting transformer S and when the bulb is returned to its normal position the current breaks, causing an arc. This allows current from whichever of the upper electrodes is positive at the time, to pass into the negative and feed the arc lamps. As the polarity of the upper electrodes unites; this starts current from the starting negative ceases and that from the one that is now positive begins.

A reactance which will cause the current from the first pole to overlap that of the succeeding one must be provided, or the current will cease entirely should it ever go to zero.

CHAPTER XVI

INCANDESCENT LAMPS

For the illumination of small spaces such as offices, residences, etc., the incandescent lamp is without doubt the most useful and economical. This is principally due to the even distribution of light which the small units make possible, and to the readiness with which the lamps may be adapted to numerous lighting schemes.

Originally all commercial incandescent lamps were made with carbon filaments, but within the last few years new types of filaments have been developed and these are, to a great extent, replacing the carbon filament.

In the carbon filament lamp a filament or thread is formed of some material rich in carbon, fibers of bamboo being originally used for this purpose. At the present time practically all carbon filaments are made by forcing a cellulose compound through suitable dies, the filament being hardened, cut to the proper length and placed on forms. It is then entirely surrounded by carbon in some form, so as to exclude all air and heated for several hours in a furnace.

After it is cooled the filament is removed from the form and connected to the leading in wires. The

substance of which the leading in wires is composed must expand and contract at the same rate as the glass surrounding it, otherwise the glass would be broken or a space would be left where the air could enter the lamp. This substance must also be of such a nature as to withstand the high temperature at which the glass is fused and the heat of the filament. Platinum is about the only material that fulfills these conditions and is used for this purpose.

The filament is now subjected to what is known as the "flashing" process, being placed in a chamber filled with a hydrocarbon vapor and current passed through the filament until it is heated to a low degree of incandescence. Any irregular portions of the filament will be heated to a higher temperature and carbon will be deposited to a greater extent at these points. When all parts are uniform and the filament is of the proper resistance, the process is stopped. In good lamps heated to a dull red, the filament should appear uniform throughout. If there are bright spots the filament will quickly burn out at one of these places.

After flashing the filament appears gray in color, with a hard outer surface which increases the useful life of the lamp and adds to its efficiency.

The filament is now placed in the glass globe and the air is then exhausted by mechanical or chemical means. A good vacuum is of great importance. The presence of oxygen hastens the deterioration of the filament. The presence of any gas inside the lamp increases the loss of heat in the filament and therefore reduces its efficiency. This also increases the de-

terioration of the filament through friction between the filament and the gas. In a poor vacuum vibration of the filament will cease quickly.

Incandescent lamps are rated according to their candlepower, the sixteen-candlepower lamp being the size most generally used. The lamp is also made in various sizes from 2 to 50-candlepower.

The light given out by an incandescent lamp bears a certain definite relation to the temperature of the filament, being greater as the temperature of the filament is increased. The current taken by the lamp depends upon the resistance offered by the hot carbon filament. It can readily be seen that we might have two incandescent lamps, each giving out a light equivalent to 16-candlepower, but one taking considerable more current than the other, as, for instance where one lamp has a short filament of small cross section and the other a long filament of larger section. It is evident that to intelligently compare lamps, the relation between the amount of energy consumed and the amount of light given out by the lamp must be known. This is termed the "efficiency" of the lamp, and is obtained by dividing the total watts consumed by the lamp by the candlepower.

Total Watts

Candlepower

If a lamp consumes 56 watts and gives a candlepower of 16, the efficiency is $56 \div 16 = 3.5$ watts per candle.

It may be noted that the term "efficiency" is somewhat of a misnomer as here used. A 16-candlepower

lamp consuming 50 watts, has an efficiency of 3.1, the efficiency in this case as expressed numerically being less than in the case previously stated, while, as a matter of fact, the real efficiency of the lamp is higher as it consumes fewer watts per candle. Nevertheless, the term has come into general use and when expressed in a certain number of watts per candle conveys the actual comparative rating of the lamp. Low candlepower lamps are generally less efficient than the standard sizes and the 220-volt lamps are less efficient than those of 110. Table I shows the wattage and current for lamps in general use.

The efficiency in lamps of the same type of filament depends upon the temperature of the filament. The higher the temperature the brighter the filament and the less the number of watts per candle. A temperature of about 2500° F., is maintained in the carbon filament. After a lamp has been in use for some time the filament gradually disintegrates, the carbon which is thrown off by the filament depositing on the inside of the glass globe. The light emitted from the lamp is thereby greatly reduced and the watts per candle increased. The disintegration of the filament is more rapid the higher the temperature.

TABLE I.
RATING OF INCANDESCENT LAMPS.

Carbon Lamps, 110 Volts.		
C. P.	Watts	Amperes
2	13	.11
4	18	.16
6	24	.22
8	30	.27
10	35	.32
12	40	.36
16	56	.51
20	70	.64
24	84	.76
32	112	1.00
50	175	1.60
Carbon Lamps, 220 Volts.		
C. P.	Watts	Amperes
8	36	.16
10	45	.20
16	64	.29
20	76	.35
24	90	.41
32	122	.55
50	190	.86
Gem Lamps, 110 Volts.		
C. P.	Watts	Amperes
20	50	.45
40	100	.91
50	125	1.14
75	187	1.70
100	250	2.27
Tantalum Lamps, 110 Volts.		
C. P.	Watts	Amperes
20	40	.36
40	80	.73
Tungsten Lamps, 110 Volts.		
C. P.	Watts	Amperes
32	40	.36
48	60	.55

It is evident from the foregoing that there are two main factors effecting the usefulness of an incandescent lamp. By increasing the efficiency we shorten the life and by decreasing the efficiency we increase the life of the lamp. A lamp taking 3.5 watts per candle has a useful life of about 800 hours. By burning the lamp at 4 watts per candle the life of the lamp would be extended to about 1,800 hours.

The cost of current will generally determine the proper lamp to use. When the cost of current is low, a low efficiency lamp may be used, and when the cost of current is high, a high efficiency lamp should be used. A point to be considered in the use of high efficiency lamps is the pressure or voltage at which the lamp is burned. For economical and satisfactory operation, the pressure must be maintained practically

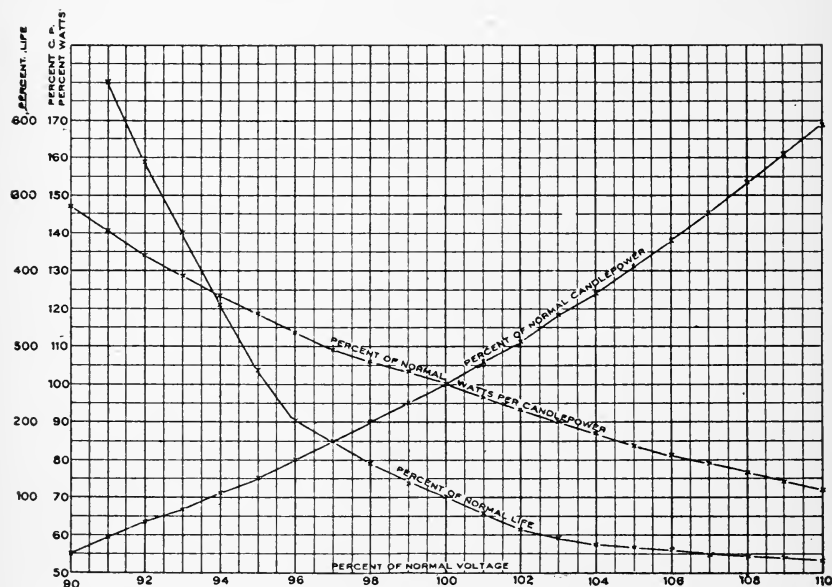

Figure 143

uniform. With the filament already at a high temperature even a slight increase in voltage will produce a considerable increase in the temperature of the filament and a corresponding decrease in the life. This is not of so much importance where low efficiency lamps are used as a slight increase in the voltage does not produce such an excessive rise in the temperature of the filament.

The manner in which the candlepower, watts per candle, and the life of 3.5 watt carbon lamps vary where burned at voltages greater or less than their normal voltage is shown in Table II, which table is given by the Westinghouse Co. and represents the average of a number of tests. The values given in the table are plotted on the curves in Figure 143. It will be noted that an increase of 3 per cent in the voltage reduces the life of the lamp to one-half, while an increase of 6 per cent decreases the life to one-third.

TABLE II.

INCANDESCENT CARBON LAMPS.

Effect of Variation of Voltage on Candle Power, Efficiency and Life.

Volts	Candle Power	Watts per Candle	Life
Per cent.	Per cent.	Per cent.	Per cent.
110	169	72	15
109	161	74	18
108	153	76.5	21
107	145	79	24.5
106	138	81.5	29
105	131	84	34
104	124	87	40
103	118	90	48
102	111	93	60
101	106	96.5	80
100	100	100	100
99	95	103	120
98	90	106	147
97	85	109.5	175
96	80	113.5	200
95	75	118.5	270
94	71	123.5	355
93	67	128	450
92	63	134	545
91	59	140.5	650
90	55	147.5	760

As an illustration of the use of the table assume the case of a 16-C. P., 110-volt lamp consuming 3.5 watts per candle and having a life of 800 hours. If a lamp of this rating was burned on a circuit where the

voltage was 120, or 109 per cent of its normal voltage, the candlepower would be increased to 161 per cent of the normal or 25.8 C. P.; the watts per candle would be reduced to 74 per cent, or about 2.59; the life would be decreased to 18 per cent, or 144 hours.

If a 16-C. P., 3.5 watt lamp, designed for use on an 115-volt circuit, was burned on a circuit at 110 volts or 95.5 per cent of the normal, the candlepower would be decreased to 77.5 per cent or 12.4; the watts per candle to 116 per cent, or about 4; the life increased to 237 per cent, or about 1,880 hours.

It is an inexcusable, though very natural, mistake to suppose that there is any economy in burning lamps after their candlepower has been greatly reduced. As a rule, if a lamp be burned about 1,000 or 1,200 hours the candlepower will have fallen to one-half of its initial value, while the current consumption will remain about the same. Consider the following example: A 50-watt lamp burning 600 hours will consume 30,000 watts, which at ten cents per kilowatt will cost \$3.00. The cost of the lamp will not be more than 20 cents. If now the lamp be burned for 600 hours more, it will give out about 8 candlepower and the cost of the current consumed will be another \$3.00, whereas the cost of a new lamp of 8 candlepower, which would give its equivalent in light, would cut the cost of current down to one-half or \$1.50 and the cost of the new lamp would be only 20 cents. It will be seen that the user, who is trying to save something by getting along with a dim light, is losing half his light to save 20 cents, and at the same time paying out \$1.30 more than would be required to obtain the same

illumination with a new lamp of the same candlepower as the old one is actually giving him.

The useful life of a lamp is determined by the number of hours the lamp will burn before the candlepower has dropped to 80 per cent of its original value. This is known as the "smashing point," and it is seldom economical to burn the lamp after this point has been reached.

When lamps become old and dim, the candlepower can be increased by increasing the voltage, but this is poor practice for, of necessity, the voltage on whatever new lamps may be in circuit is also increased and this does more harm in shortening the life of these lamps than good in saving the old.

The efficiency and the life of incandescent lamps are two factors which do not harmonize. The higher the efficiency of a carbon filament lamp the shorter its life. This makes it advisable to carefully consider which is the most economical lamp to use. The two main considerations in determining the most economical lamp are the cost of current and the cost of lamp renewals. Tables III and IV are prepared to facilitate calculation in this regard. The most economical lamp to use is that in which the cost of energy and the cost of renewals is a minimum. If the cost of power is high, a lamp of high efficiency, even though its life be short, is generally more economical; while if power is very cheap, a lamp of low efficiency is generally advisable.

TABLES

In Table III, the cost of current per kilowatt is given at the top of the columns, and the watts per

candlepower of the lamp in the left-hand vertical column. Wherever two columns cross will be found the cost per candlepower for 1,000 hours for the lamp of an efficiency as indicated in the left-hand column, and at the cost per kilowatt as shown at the top of the column. As an example: Take a lamp of an efficiency of 3.1 watts per candle, with current costing 10 cents per kilowatt. Where these two columns intersect in the table will be found the value, .310; showing that the cost per candlepower per 1,000 hours at this efficiency and rate will be 31 cents.

To ascertain the cost of current consumed by a lamp of any candlepower per 1,000 hours, the cost as found in the table must be multiplied by the candlepower of the lamp. For instance: a 16-candlepower lamp at the rating shown above, would cost $16 \times .31 = \$4.96$ for 1,000 hours burning.

Table IV deals with the cost of lamp renewals. In the upper horizontal row is given the life of the lamp in hours, and at the left hand vertical column the cost of the lamp in cents per candlepower. Wherever the two columns cross will be found the cost of lamp renewals per 1,000 hours.

Example: Suppose a 16-candlepower lamp costs 19 cents (1.2 cents per candle) and has a life of 600 hours. In the row at the right of 1.2, and in the column headed 600 will be found the value, .02, which is the cost of the lamp renewals per candlepower for 1,000 hours. For a 16-candlepower lamp, the cost would be $16 \times .02 = \$0.32$. The total cost of the lamp for 1,000 hours, including both cost of current and renewals, is $\$4.96 + \$0.32 = \$5.28$.

TABLE III.
COST OF RENEWALS PER CANDLEPOWER PER 1000 HOURS.

		Life of Lamp in Hours.																					
		1200	1150	1100	1050	1000	950	900	850	800	750	700	650	600	550	500	450	400	350	300	250	200	150
.5	.004	.004	.004	.004	.005	.005	.005	.006	.006	.006	.007	.007	.008	.008	.009	.01	.011	.012	.014	.017	.02	.025	.033
.6	.005	.005	.005	.006	.006	.007	.007	.007	.007	.008	.008	.009	.010	.010	.011	.012	.013	.015	.017	.02	.024	.03	.04
.7	.006	.006	.006	.007	.007	.008	.008	.008	.009	.009	.01	.011	.011	.012	.013	.014	.016	.018	.02	.023	.028	.035	.047
.8	.007	.007	.007	.008	.008	.009	.009	.01	.011	.011	.012	.013	.013	.015	.016	.018	.02	.023	.027	.032	.04	.053	
.9	.007	.008	.008	.009	.009	.01	.011	.011	.012	.013	.014	.015	.016	.018	.02	.022	.026	.03	.036	.045	.06		
1.0	.008	.009	.009	.010	.01	.011	.012	.012	.013	.014	.015	.017	.018	.02	.022	.025	.029	.033	.04	.05	.067		
1.1	.009	.010	.010	.010	.011	.012	.012	.013	.014	.015	.016	.017	.018	.02	.022	.024	.027	.031	.037	.044	.055	.073	
1.2	.010	.010	.011	.011	.012	.013	.013	.014	.015	.016	.017	.018	.02	.022	.024	.027	.03	.034	.04	.048	.06	.08	
1.3	.011	.011	.012	.012	.013	.014	.014	.015	.016	.017	.019	.02	.022	.024	.026	.029	.032	.037	.043	.052	.065	.087	
1.4	.012	.012	.013	.013	.014	.015	.016	.016	.017	.019	.02	.022	.023	.025	.028	.031	.035	.04	.047	.056	.07	.093	
1.5	.012	.013	.014	.014	.015	.016	.017	.018	.019	.02	.021	.023	.025	.027	.03	.033	.037	.043	.05	.06	.075	.10	
1.6	.013	.014	.015	.015	.016	.017	.018	.019	.02	.021	.023	.025	.027	.029	.032	.036	.04	.046	.053	.064	.08	.107	
1.7	.014	.015	.015	.016	.017	.018	.019	.02	.021	.023	.024	.026	.028	.031	.034	.038	.042	.049	.057	.068	.085	.113	
1.8	.015	.016	.016	.017	.018	.019	.02	.021	.022	.024	.025	.028	.03	.033	.036	.04	.045	.051	.06	.072	.09	.12	
1.9	.016	.016	.017	.018	.019	.02	.021	.022	.024	.025	.027	.029	.032	.035	.038	.042	.047	.054	.063	.076	.095	.127	
2.0	.017	.017	.018	.019	.02	.021	.022	.024	.025	.027	.029	.03	.033	.036	.04	.044	.05	.057	.067	.08	.10	.133	
2.2	.018	.019	.020	.021	.022	.023	.024	.026	.027	.03	.031	.034	.037	.04	.044	.049	.055	.063	.073	.088	.11	.146	
2.4	.020	.021	.022	.023	.024	.025	.027	.028	.03	.032	.034	.037	.04	.044	.048	.053	.06	.069	.08	.096	.12	.16	
2.6	.022	.023	.024	.025	.026	.027	.029	.031	.032	.035	.037	.04	.043	.047	.052	.058	.065	.074	.087	.104	.13	.173	
2.8	.023	.024	.025	.027	.028	.029	.031	.033	.035	.037	.041	.043	.047	.051	.056	.062	.07	.08	.093	.112	.14	.186	
3.0	.025	.026	.027	.029	.03	.032	.033	.035	.037	.04	.043	.046	.05	.055	.06	.067	.075	.086	.10	.12	.15	.20	
3.5	.029	.030	.032	.033	.035	.037	.039	.041	.044	.047	.05	.054	.058	.064	.07	.078	.087	.10	.117	.14	.175	.233	
4.0	.033	.035	.036	.038	.040	.042	.044	.047	.05	.053	.057	.062	.067	.073	.08	.089	.10	.114	.133	.16	.20	.266	
4.5	.037	.039	.041	.043	.045	.047	.05	.053	.056	.06	.064	.069	.075	.082	.09	.10	.112	.129	.15	.18	.225	.30	
5.0	.041	.043	.045	.048	.05	.053	.056	.059	.062	.067	.071	.077	.083	.091	.10	.111	.125	.143	.166	.20	.25	.333	
5.5	.046	.048	.050	.052	.055	.058	.061	.065	.069	.073	.079	.085	.092	.10	.11	.122	.137	.157	.183	.22	.275	.366	
6.0	.050	.052	.055	.057	.06	.063	.067	.071	.075	.08	.086	.092	.10	.109	.12	.133	.15	.171	.20	.24	.30	.40	
6.5	.054	.056	.059	.062	.065	.068	.072	.076	.081	.087	.093	.10	.106	.118	.13	.144	.162	.186	.216	.26	.325	.433	

COST OF LAMP PER CANDLEPOWER—CENTS.

TABLE IV.
COST OF CURRENT PER CANDLEPOWER PER 1000 HOURS.

		Price per Kilowatt in Cents.																	
		2	2½	3	3½	4	4½	5	6	7	8	9	10	11	12	14	16	18	20
1.	.020	.025	.030	.035	.040	.045	.050	.060	.070	.080	.090	.100	.110	.120	.140	.160	.180	.200	
1.25	.025	.031	.037	.048	.050	.056	.062	.075	.087	.100	.112	.125	.137	.150	.175	.200	.225	.250	
1.5	.030	.037	.045	.052	.060	.067	.075	.090	.105	.120	.135	.150	.165	.180	.210	.240	.270	.300	
1.75	.035	.044	.052	.061	.070	.079	.088	.105	.122	.140	.158	.175	.192	.210	.245	.280	.315	.350	
2.	.040	.050	.060	.070	.080	.090	.100	.120	.140	.160	.180	.200	.220	.240	.280	.320	.360	.400	
2.25	.045	.055	.067	.075	.090	.100	.112	.135	.152	.180	.202	.225	.247	.270	.315	.360	.405	.450	
2.5	.050	.062	.075	.087	.100	.112	.125	.150	.175	.200	.225	.250	.275	.300	.350	.400	.450	.500	
2.65	.053	.066	.079	.093	.106	.119	.132	.159	.185	.212	.238	.265	.292	.318	.371	.424	.478	.530	
2.8	.056	.070	.084	.098	.112	.126	.140	.168	.196	.224	.252	.280	.308	.336	.392	.448	.504	.560	
3.	.060	.075	.090	.105	.120	.135	.150	.180	.210	.240	.270	.300	.330	.360	.420	.480	.540	.600	
3.1	.062	.077	.093	.108	.124	.139	.155	.186	.217	.248	.279	.310	.341	.372	.434	.496	.558	.620	
3.5	.070	.087	.105	.122	.140	.157	.175	.210	.245	.280	.315	.350	.385	.420	.490	.560	.630	.700	
4.0	.080	.100	.120	.140	.160	.180	.200	.240	.280	.320	.360	.400	.440	.480	.560	.640	.720	.800	
4.5	.090	.110	.135	.150	.180	.200	.225	.270	.305	.360	.405	.450	.495	.540	.630	.720	.810	.900	
5.0	.100	.125	.150	.175	.200	.225	.250	.300	.350	.400	.450	.500	.550	.600	.700	.800	.900	1.00	
5.5	.110	.137	.165	.193	.220	.248	.275	.330	.385	.440	.495	.550	.605	.660	.770	.880	.990	1.10	
6.0	.120	.150	.180	.210	.240	.270	.300	.360	.420	.480	.540	.600	.660	.720	.840	.960	1.08	1.20	
6.5	.130	.162	.195	.227	.260	.292	.325	.380	.455	.520	.595	.650	.715	.780	.910	1.04	1.17	1.30	

Watts per Candlepower.

To find the most economical lamp where the cost of current is fixed, it is only necessary to try out several cases and select the one where the sum of the two fac-

tors is a minimum. In comparing lamps of either the same or different candlepowers, it is not necessary to multiply the values found in the tables by the candlepower of the lamp. On the other hand, where the actual cost per 1,000 hours is desired, the values found in the tables must be multiplied by the candlepower of the lamp in question.

As an example showing the method in which the table is used the two following lamps will be compared:

Sixteen-candlepower carbon lamp of an efficiency of 3.5 watts per candle, life of the lamp 1,150 hours, cost of the lamp 16 cents (1 cent per candle).

Thirty-two-candlepower Tungsten lamp of an efficiency of 1.25 watts per candle, life of lamp 1,000 hours, cost \$1.20 (3.7 cents per candle).

Cost of current, 10 cents per kilowatt.

For the carbon lamp:

Table III gives.....	.35
Table IV gives.....	.009

Total.....	.359

For the Tungsten lamp:

Table III gives.....	.125
Table IV gives.....	.035

Total.....	.160

The result shows that for the values taken the cost of the Tungsten lamp will be less than one-half that of the carbon lamp.

It will be noted that in using the tables, the cost per candlepower of the Tungsten lamp is 3.7 cents is not given in the table, and the value 3.5 is taken. If greater accuracy is desired, the values may be interpolated. For instance: in the case given, the value from Table IV would be .037, giving a total of .162 in place of .160.

Are lamps, Nernst lamps, or, in fact, any lamps where the candlepower, efficiency and cost are known may be compared; either two lamps of the same type, or lamps of different types.

METALLIZED FILAMENT LAMP

In the past few years a number of new types of incandescent lamps have been developed. The quality of the light, the life of the lamp, its regulation and its efficiency have all been greatly improved. The first of these lamps to come into general use is known as the metallized filament lamp. The filament of this lamp is of carbon, which is put through various processes, one of which is the heating of the filament to a very high degree in an electric furnace. Practically all the impurities are driven out by this process and a greatly increased efficiency is obtained, and the filament gives out a much better quality of light.

One of the peculiar results effected by the treatment of the filament, and the one from which it gets its name, is that the electrical characteristics of the carbon is considerably changed. The ordinary carbon filament has a negative temperature coefficient; in other words, its resistance lowers with an increase in

temperature and increases with a lowering temperature. On a system where the voltage regulation is poor, the effect of the negative temperature coefficient is, so far as the light is concerned, cumulative, the increase in voltage causing, in itself, more current to flow through the lamp, increasing its candlepower. The increase in current increases the temperature of the filament and lowers its resistance, this causing a still further increase in the candlepower.

The metallized filament has a positive temperature coefficient, similar to metals. Its resistance increases as its temperature increases. The regulation of the lamp is therefore much better than that of the carbon lamp, an increase in voltage causing an increase in the resistance of the filament and a corresponding tendency to check the current rise. This lamp has an efficiency of 2.5 watts per candle, or 40 watts for a 16-candlepower lamp.

TANTALUM LAMP

The Tantalum lamp is another recent development in the field of incandescent lighting. This lamp takes its name from the metal from which the filament is constructed. Tantalum is one of the rare metals and not only has a greater strength than steel, but is capable of withstanding a very high temperature. Due to these characteristics the metal is very well suited for use as a filament.

As all metals are of comparatively low resistance a filament of unusual length must be employed to obtain the proper resistance. The Tantalum lamp has

an efficiency of 2 watts per candle and gives a very white light resembling daylight. It is not recommended for use on alternating current circuits.

TUNGSTEN LAMPS

Shortly after the introduction of the tantalum lamp a still greater advance was made by the bringing out of the Tungsten lamp. Tungsten, another of the rare metals, is in its electrical behavior similar to tantalum but for use as a filament it surpasses tantalum, owing to the fact that its melting point is considerably higher. The filament can be burned at a very high temperature and has an efficiency of 1.25 watts per candle. The filament being of metal has a comparatively low resistance and, as with tantalum, must be unusually long to obtain the proper resistance for use on the common voltages.

The current required for producing equal candlepower with Tungsten lamps is approximately one-third of that required by carbon lamps, and approximately one-half of that required by the metallized filament lamps. The cost of operating Tungsten lamps is, therefore, much less than the cost of operating other lamps.

The light given by the Tungsten lamp is much whiter and more pleasing in character than that given by other lamps. As its quality corresponds more nearly to sunlight than any other artificial illuminant it is especially desirable for use in show rooms, stores, etc. The loss in candlepower after the lamp is in use for some time amounts to about one-fourth that of the

carbon lamp. The lamp also has a much longer life than the carbon lamp. In regulation the Tungsten lamp is greatly superior to the carbon lamp and an excessive voltage which would ruin a carbon lamp does not seriously affect the Tungsten lamp.

Tungsten being quite brittle and the filament of necessity being of small cross section, the lamp must be carefully handled. The lamp should be cleaned while hot, as the filament is then stronger than when cold. It is also advisable to control the lamp from switches, thus avoiding the jarring caused by turning on at the socket. It has been customary to burn the lamp with the filament hanging downward in a vertical direction this being necessitated by the sagging of the filament, but lamps are now made to burn with the lamp hanging in any direction. The filament after having burned for some time shrinks considerably and this must be provided for in the manufacture.

With Tungsten lamps designed for use on low voltage, the filaments are made of a much shorter length and are less liable to breakage. This class of lamp may be burned in series on the ordinary circuits of 110 or 220 volts, or suitable transformers are now made so that on alternating current systems these low voltage lamps may be wired up in multiple.

The filaments of both tantalum and tungsten can often be welded when broken, by shaking the lamp when connected in circuit, until the broken ends come together. As this operation generally has the effect of shortening the filament and lessening its resistance it brings with it an increase in candlepower.

ILLUMINATION

Light, so far as its practical use is concerned, depends upon its value as a means of discrimination both as to form and color. The amount of light which is useful for this purpose is known as the illumination, and depends upon the quality and strength of the light giving source, and its distance from the object to be illuminated.

The unit of illumination is the candle foot, being the amount of light received by a surface placed at a distance of one foot from a light of one standard candlepower. The illumination on any surface is in-

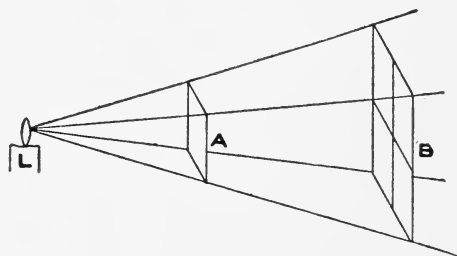

Figure 144

versely proportional to the square of its distance from the source of light. This is plainly shown in Figure 144. If the surface A is so located that all points on it are at a distance of one foot from the one candlepower light L, the intensity of the light on this surface will be one candle foot. The surface B, located at a distance of two feet from the light L is illuminated over a surface four times that of surface A and the illumination is, therefore, decreased to one-fourth; or in the inverse ratio of the square of the distances from the source of light.

A 16-candlepower lamp would produce an illumi-

nation of one candle foot on a surface located four feet away from the lamp, and this is considered sufficient for all ordinary purposes, but for brilliant illumination much greater intensities are often used. Table V gives, for different classes of lighting, the amount of illumination in candle feet and the corresponding area in square feet for each 16-candlepower lamp, to produce this illumination.

TABLE V.

		Square feet per lamp, lamps four feet above object.
Halls	1 to 3 candle feet	60 to 20
Reading	1 to 3 candle feet	60 to 20
Desk	2 to 4 candle feet	30 to 15
Book keeping.....	2 to 4 candle feet	30 to 15
Clothing stores.....	4 to 6 candle feet	15 to 10
Drafting, engraving.....	5 to 10 candle feet	12 to 6

In using this table the color of the walls must be taken into consideration. With dark walls, the greatest number of candle feet should be used.

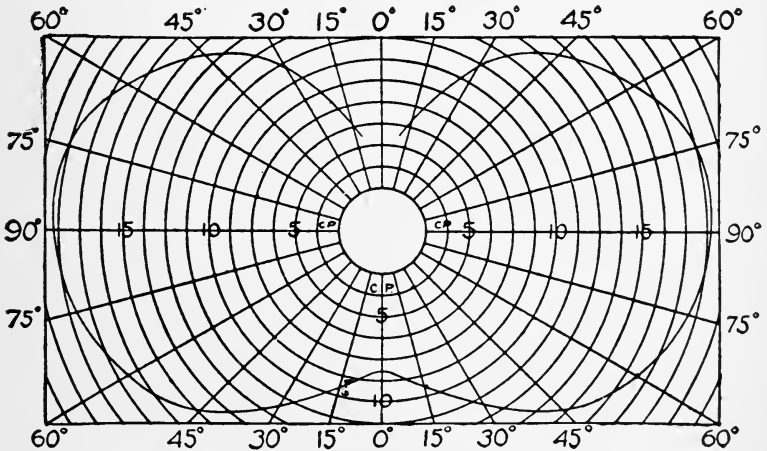

Figure 145

With an incandescent lamp the light is not given out uniformly in all directions. The distribution of

light from a 20-candlepower metallized filament lamp is shown in Figure 145, where the candlepower taken at various angles in a vertical plane are plotted. The concentric circles represent the candlepower marked on them

The curve of light distribution varies in the several types of lamps, and is greatly affected by the shape of the filament. It will be seen from the curve, Figure 145, that a considerable amount of light is given out

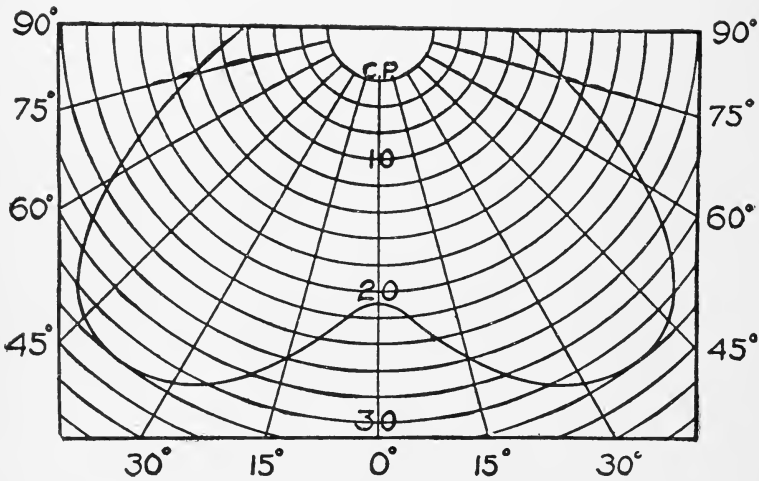

Figure 146

in a horizontal direction while, as a general rule, the greatest light is desired below the lamp. By the use of suitable reflectors almost any distribution of the light desired may be obtained and the effect, so far as the candlepower at points below the lamp is concerned, is clearly shown by the curve, Figure 146. Here the maximum light is given off at an angle of 40° and the lamp is much more useful for ordinary purposes.

The amount of illumination at any given point over an area will depend upon the candlepower of the lamp, the distance from the lamp and the angle that the surface makes with the line of the direction of the light. The first two factors have been explained and the last one will be readily understood from every day experience, it being well known that the greatest amount of illumination, in reading, for instance, is obtained when the paper or book is so held that the light strikes it at right angles. The curve, Figure 147, represents the illumination at various points at different distances from the source of light. If two similar lamps are placed 16 feet apart, the resultant illumina-

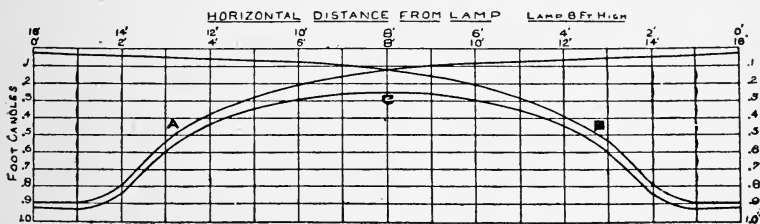

Figure 147

tion will be equal to the sum of the two curves A and B or as shown by curve C.

To lay out a curve of this kind it is necessary to know first the curve of the distribution of the particular lamp used. It is also necessary to know the proportion of light reflected at right angles to the surface, where the light strikes the surface at an angle.

That the color of the walls and ceiling of a room has a great effect on the amount of useful light is shown from Table VI, which gives the coefficient of reflection for various colors. As the light reflected from the walls and ceilings is but a small proportion

of the total light, the values shown are only useful in comparing the several wall colors. The size of the room and the use of reflectors will also greatly modify the effect of the wall coloring.

TABLE VI

Color of Wall.	Coefficient of Reflection
White paper.....	.70
Chrome yellow.....	.62
Orange paper.....	.50
Plain deal (clean).....	.45
Yellow paper.....	.40
Yellow painted wall (clean).....	.40
Light pink paper.....	.36
Plain deal (dirty).....	.20
Yellow painted wall (dirty).....	.20
Emerald Green Paper.....	.18
Dark brown paper.....	.13
Vermilion paper.....	.12
Blue green paper.....	.12
Cobalt blue paper.....	.12
Deep chocolate paper.....	.04

Good illumination requires that the light be of sufficient strength to plainly discern the object illuminated. The light must be uniform. A flickering or streaky light is very bad on the eyes. The light should not be exceedingly strong, as a strong light is very injurious to the eye; nor should the light be too dim, as the eye strain is considerably increased. The lights should always be so arranged that the direct rays of light do not fall on the eye.

CHAPTER XVII

NERNST LAMP

Figure 148 shows a diagram of the Nernst Lamp. The glower G (which emits the light) is composed of an oxide which when cold is of quite high resistance, but this resistance is lowered as the temperature rises.

When the switch is closed the current passes

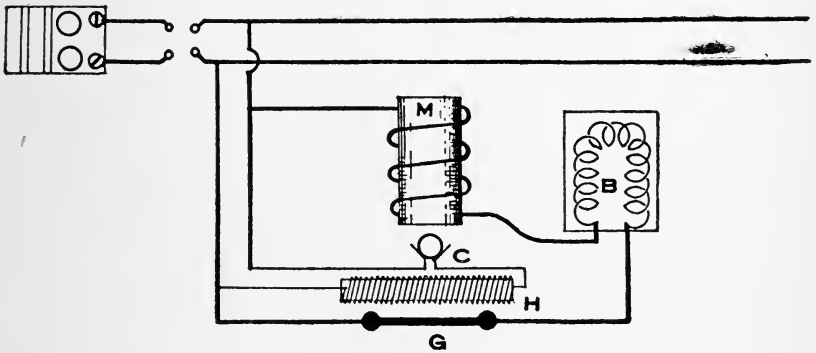

Figure 148

through the fine wire of the heater H which soon heats the glower so that current begins to flow through it. When this current attains approximately its normal value the magnet M attracts the cut-out C and in so doing opens the heater circuit and prevents further consumption of energy. B is a fine iron wire resistance which serves to steady the current. The resist-

ance of the iron wire increases as the current increases and thus exerts a steadying effect.

This lamp gives out a very serviceable white light and is of much higher efficiency than the ordinary carbon filament incandescent lamp. A glower that consumes about 88 watts is supposed to yield about 60 candlepower.

The starting current is always about 20 per cent in excess of the normal operating current.

These lamps can be had in a great variety of sizes, either for 110 or 220 volts, and for either direct or alternating current. On alternating currents the life of the lamp is, however, much longer than on direct current circuits.

As the glowers are always located at the bottom of the frame the distribution of the light is very good and reflectors are not needed.

COOPER-HEWITT LAMP

Figure 149 shows a diagram of the connections of the Cooper-Hewitt Lamp for direct currents. These lamps each contain a small quantity of mercury through which the current must be established for a short time and then broken. This is accomplished by tilting the tube slowly so that the mercury in it running from the high to the low side forms a continuous stream and allows the current to start. After the current is started the mercury continues to run to the low end and finally breaks the circuit; but the current now continues to flow and produces a greenish light of very high actinic quality. The lamp is extremely well suited for photographic purposes. Great care

must be exercised that the lamp is connected properly with reference to polarities. Current passing through it in the wrong direction will quickly ruin the lamp. The circuit can readily be traced in the figure. When the main switch is closed and before the lamps are tilted the current passes through the resistances R and the contacts M . When one of the lamps is tilted and current established through it the magnet is energized and attracts the armature M , thus cutting out the

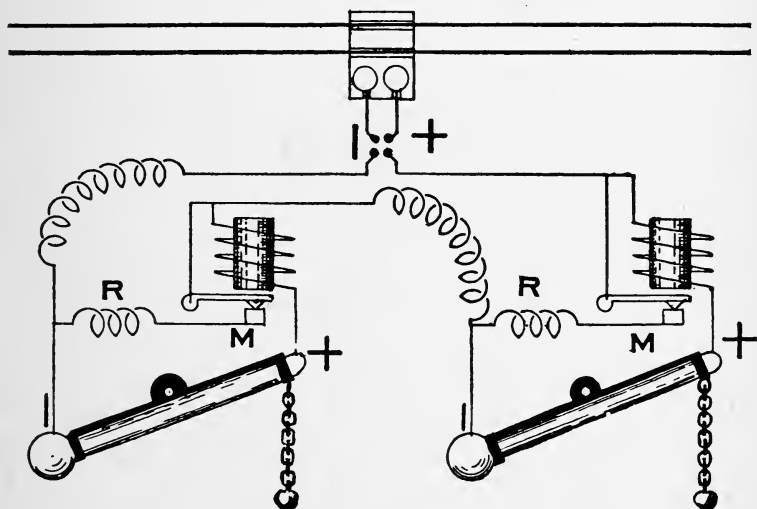

- Figure 149

path through the small resistance in parallel with the lamp. Should one lamp fail to work, the current through the magnet would cease and the armature fall thus closing the circuit so that the other lamps may remain in use. The main switch should never be left closed while the lamps are not in use as current would be continuously flowing.

The lamps must not be used with the negative electrode tilted too high up.

The current should never be allowed to exceed 4 amperes and should normally not exceed $3\frac{1}{2}$. The resistances *R* are adjustable and should be set for this current value.

These lamps are sometimes arranged to be started by a high induced E.M.F., an induction coil is arranged to send a momentary kick of current through the tube which starts the lamp. Sometimes, also, two lamps are mounted on one frame and started together. In such a case the shunt circuit around the lamps may be omitted. The life of the tubes is said to be about 1600 hours.

CHAPTER XVIII

INSTRUMENTS FOR TESTING

Probably the easiest and simplest way of testing is by "tasting." This is done by placing the two ends of the wire being tested on the tongue. The passage of current from one wire to the other over the tongue decomposes the saliva on the tongue and leaves a salty taste. This salty taste is an indication of current flowing. If there are several cells of battery connected to the line one wire may be held in the hand and the other placed on the tongue or, if one terminal of the batteries is grounded, a person standing on wet or moist ground can taste the current by placing one wire on the tongue.

Obviously this test is very limited, being used as a rule only in bell work to ascertain if current is obtainable at a certain point. Some care must be exercised, in using a test of this kind, not to allow the wires to come together on the tongue, as a considerable spark is obtained when a circuit containing magnets is broken.

Another test in which the chemical effect of the current may be used to determine both the presence of, and the direction of, flow of current consists in holding the two ends of wire being tested in a cup of water or

a solution of water and salt or water and acid. The presence of the current will be indicated by the formation of hydrogen bubbles on one of the terminals and owing to the fact that the bubbles form on the negative terminal the direction of flow of the current can be ascertained.

The chemical effect of the current is also made use of to determine the amount of current flowing. The Edison chemical meter, which is now almost out of use, consists of two plates of zinc suspended in a solution of water and acid and so connected to the main circuit as to allow a certain definite proportion of the main current to flow between the plates. The amount of zinc deposited on the negative plate measures the amount of current that has passed through the meter.

The heating effect of the electric current is sometimes made use of in testing, the mere fact of a conductor being hotter than the surrounding atmosphere generally indicating the presence of current and roughly the amount.

By making use of the magnetic properties of the current several more convenient and satisfactory methods of testing are available. Probably the simplest of any of these methods consists of the ordinary vibrating electric bell, such as is used for call bells, etc., or a telegraph instrument. The use of a telegraph instrument has some advantages over the bell in that it is more sensitive to small currents and, by varying the adjustment of the spring on the sounder the comparative strength of the current may be roughly determined.

One of the oldest testing instruments is the com-

pass. This in its simplest form consists of a piece of magnetized steel pivoted or suspended so that it can turn about its central point. The compass needle being magnetized sets up a field of force in which the lines of force emanate from the north pole, and encircling the needle enter at the south pole. As the earth itself is surrounded by lines of force extending from the north pole to the south pole, the compass needle being free to move tends to set itself in a north and south position. A wire carrying current is surrounded by a field of force as has been explained in previous chapters. When a compass is brought into the field of force the needle assumes a position due to the result-

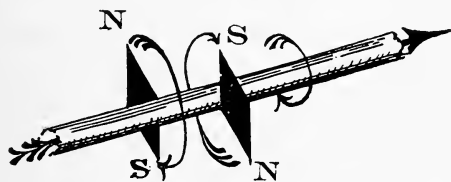

Figure 150

ant field. By means of Ampere's rule, which is given below, the direction of the current flow can be easily determined.

Ampere's rule: If a person swims with the current and looks at a north seeking pole it will be deflected to the left. The relation existing between a wire carrying current in a certain direction and a compass needle held either above or below it is shown in Figure 150. The direction in which the needle tends to point is reversed by changing it from above to below the wire or vice versa.

The expansion of a wire due to the heating effect of the current flowing in it is made use of to indicate the

amount of current flow in the so-called "hot wire" instruments.

A wire of some length is rigidly fastened at one end, the other end being attached to a spring. A pointer is attached to the wire at the point where it and the spring connect. On sending a current through the wire it becomes slightly heated and expands, the amount of expansion being indicated by the position of the pointer on a suitably graduated scale. Neces-

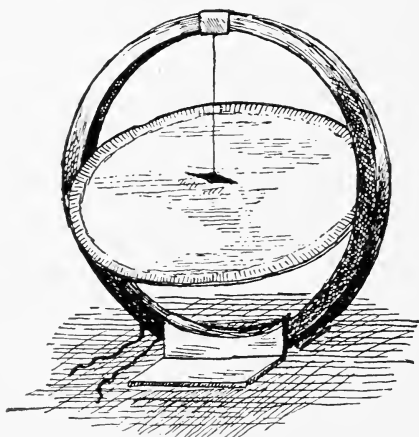

Figure 151

sarily the resistance of the instrument is quite low. Instruments of this kind are "dead beat" and are unaffected by external fields. They can be used on either direct or alternating current.

Practically all measuring instruments in use at the present time operate on the principle previously described in connection with the compass needle.

In Figure 151 is shown a tangent galvanometer. The wire is wound on the outside of the large ring and may consist of a number of turns of small wire or a few turns of large wire, or, as is sometimes the case,

two separate windings may be used, one of fine wire and one of large wire. In the center of the ring is placed a compass needle. The length of this needle is small as compared with the diameter of the ring so that whatever position it may assume, the needle is always in a practically uniform field. A light pointer attached to the needle moves over a graduated scale.

When the galvanometer is used it is placed in such a position that the coil lies parallel with the lines of force of the earth's field, i. e., points north and south. The current flowing in the coil is proportional to the tangent of the angle of deflection of the needle and it

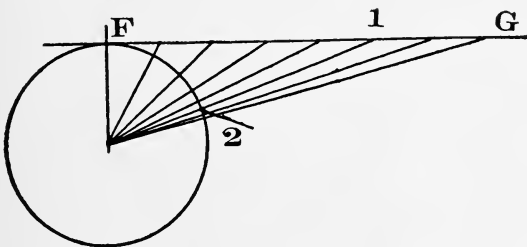

Figure 152

is from this fact that the instrument derives its name.

The meaning of the tangent is explained by Figure 152. The tangent of an angle is the length of the line from F to where a line drawn from the center of the circle through the angle in question intersects the line F G. Thus a current deflecting the needle to the point 2 on the circle is proportional to the length of the line F 1 and not to the space between F 2. This type of galvanometer is used only in the laboratory or testing room.

Where it is desired to measure very small currents, as where very high resistances are to be measured, a

galvanometer more sensitive than the tangent galvanometer must be used. The mirror galvanometer is often used for this purpose.

Figure 153 shows the principle of the D'Arsonval galvanometer. The field of this instrument consists of two permanent magnets between the poles of which is suspended a coil of fine wire. This coil is suspended

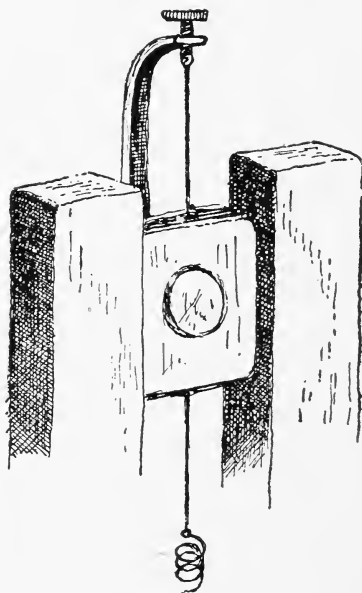

Figure 153

by a wire from the screw shown at the top of the instrument in the illustration. The current being measured passes down through this suspension wire, through the wire of the coil and out by means of a spiral spring which is connected to the lower end of the coil. A very light mirror attached to the movable coil serves as a means to determine the extent of the deflection. Either of two methods may be employed. A

lamp and a graduated scale are so arranged that a beam of light coming through a slit in a hood over the lamp falls on the mirror and is reflected on the scale. A telescope may be used in place of the lamp. The telescope is focused so that the scale is visible in the mirror. The slightest movement of the mirror can then be accurately read through the telescope.

Practically all of the instruments just described are made use of only in the laboratory and are not suitable for ordinary switchboard and testing purposes. To be of commercial use an instrument must not be seriously affected by the earth's magnetism nor by the presence of large masses of metal or strong magnetic fields such as are apt to be found in a dynamo room for instance. The instrument must be portable, and the accuracy of the indications must not change unduly with continued use. The instrument must also be easily read and unnecessary calculations avoided.

Commercial instruments are divided into three general classes, those for use on direct current, those for use on alternating current only, and those for use on either direct or alternating current. In each of these three classes instruments are designed for special purposes, such as the measurement of voltages, measurement of current strength and measurement of electrical power. Although the principles upon which these various instruments operate are the same, still there are some differences in their construction depending on the purposes to which the instruments are to be put, as will be described further on.

Almost any of the galvanometers previously described could be used for the measurement of direct

current voltages, but, for the reasons already assigned, most of them are impracticable for general use.

In Figure 154 is shown the well known Weston instrument. A permanent magnet *M*, constructed of a specially prepared steel having the property of retaining its magnetism for an indefinite time, is fitted with soft iron pole pieces. In the space between the pole pieces, held in place by a non-magnetic metal such as brass, is a soft iron core. A coil of fine copper wire wound on a copper form is movable in the air gap between the inner core and the pole pieces. In order

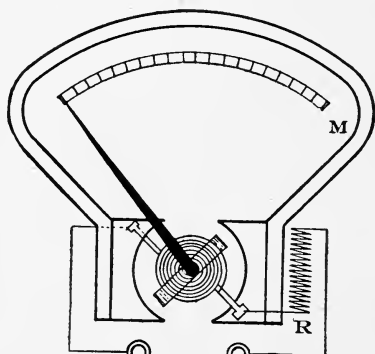

Figure 154

that the resistance to turning due to friction be reduced to a minimum the coil rests in jewel bearings. Two flat spiral springs, one above the coil and one below it, serve the double purpose of providing a torque against which the coil must act and also carry the current to the movable coil. A light pointer fastened to the shaft upon which the coil revolves moves over a scale graduated in divisions suitable to the purpose to which the instrument is put.

Copper wire being used in the winding of the coil some resistance must be connected in series with this

coil where the instrument is to be used, to measure comparatively high voltages. This resistance is usually inserted in the instrument and consists of a resistance wire having a very low temperature coefficient, or, in other words, a wire of such composition that its resistance will be but little affected by changes in its temperature. The importance of using a wire of this kind can readily be seen, for, should an instrument which had been calibrated at a temperature of 70° be used in a room at a temperature of about 100° , the decrease in current flowing through the instrument due to the increase in resistance in the heated wire would seriously affect the accuracy of the instrument.

The amount of resistance connected in series with the coil varies and depends on the voltages which it is intended the instrument should measure. In voltmeters for use on 500 and 600 volt circuits, this resistance is equal to about 65,000 or 75,000 ohms, thus allowing a current of about .007 ampere to pass through the instrument.

Current enters the instrument through the binding posts and passes through the resistance R , spiral springs and the coil. The magnetic field produced by the current flowing around the coil acts in conjunction with the field of the permanent magnet and tends to revolve the coil in a manner similar to that of the armature of a motor. As a matter of fact, this meter is simply a motor having a permanent field, and an armature that can make only a partial revolution. The amount of deflection will be proportional to the current flowing through the wire of the coil, and as the coil always moves in a practically uniform field a uni-

form scale will result. The movement of the coil is restrained by the spiral springs

This instrument is what is termed "dead beat," that is, the tendency of the pointer to swing backward and forward on deflection is reduced to a minimum. The movable coil is wound on a copper frame. When on deflection of the instrument this frame moves across the field of the permanent magnet, it cuts through lines of force and a current is produced in the closed circuit of the copper frame, this action tending to restrain the movement of the coil.

Figure 155 shows a type of instrument similar to the one just described but varying in some details. M

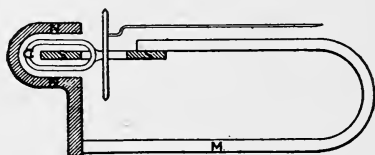

Figure 155

is a permanent magnet fitted with pole pieces of the shape shown in the figure, the pole S, S being shaped like an iron washer. A coil, C, is attached to a shaft which turns in jeweled bearings. A pointer attached to the shaft moves over a suitable scale. Current passing through the coil C causes it to revolve around the pole piece S, S. The instrument is made "dead beat" by the short circuiting of the copper frame on which the coil is wound.

A type of induction meter which is used only on alternating current circuits is shown in Figure 156. A copper or aluminum disc fastened to a shaft, rotates in jewel bearings. Projecting over the disc on one

side and so arranged that the disc rotates between its pole pieces is a laminated magnet C, on which is wound a coil of wire. Another coil C' is placed so that its

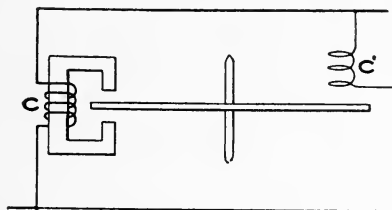

Figure 156

field cuts the disc. Both coils are connected in parallel. Owing to the fact that with an alternating current flowing through the instrument there will be a difference in phase in the current flowing in coil C and

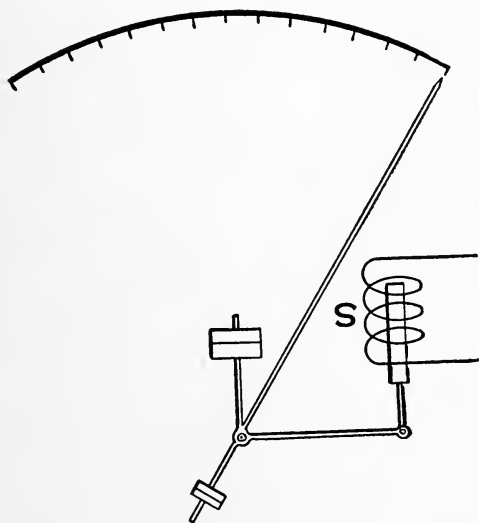

Figure 157

coil C', coil C' having no iron core, a torque is set up which tends to rotate the disc, the amount of deflection being indicated by the pointer attached to the shaft.

Figure 157 shows in a simplified form an instrument which can be used for the measurement of either direct or alternating currents. The current to be measured is carried through a solenoid S. In the center of the solenoid is suspended a soft iron core, which is free to move up or down, the motion of the core being registered by the pointer attached to the supporting arm. A counterweight serves to balance the iron core.

When current flows through the solenoid the iron core is drawn down into it, the amount of current flowing being indicated by the pointer.

The principle upon which this instrument operates is made use of in a number of different instruments. As the action of the solenoid is the same when either direct or alternating current is used, this instrument may be used on circuits of either system.

Instruments of the design just described have the objection that when used on direct current, with an increase in current strength, the instrument will indicate lower than it should, while with a decreasing current it will indicate higher. This is due to "hysteresis" in the iron core, and if the core contains any great quantity of iron, makes the instrument valueless as a voltmeter. With direct current more accurate results may be obtained by first increasing the current, then decreasing it and taking an average of the readings. On alternating current systems, this objection does not exist, but in this case the iron core must be laminated to avoid the generation of eddy currents.

The Weston instrument having a permanent magnet field cannot be used for alternating current meas-

urement. Figure 158 shows the construction of the instrument designed for use on alternating current circuits. An outer coil C is wound on a circular form. Inside of this coil, mounted on jewel bearings, is a movable coil C'. Two spiral springs convey the current to the movable coil and restrain its motion. The two coils are connected in series. When current flows through the coils, the movable coil tends to take up a position parallel with the stationary coil. When used on alternating currents, the polarity of each coil reverses at the same time, so that the effect is the same

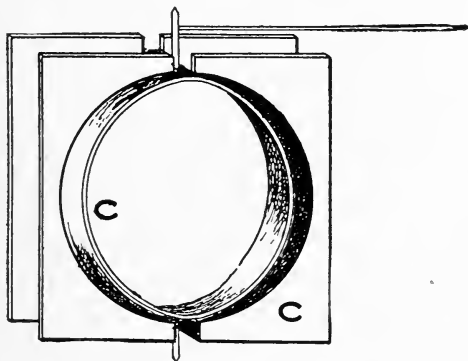

Figure 158

as though direct current was used. The instrument is damped by a metal vane moving in a partly closed air chamber.

The difference between a voltmeter and an ammeter is merely a difference in winding. A voltmeter is wound with a very fine wire and registers the difference in pressure between two wires. The finer the wire or the greater the number of turns, the more economical is the instrument in operation. It needs only to produce magnetism enough to deflect the pointer sufficient to admit of accurate calibration.

If in any circuit the pressure is greater than the range of any accessible meter, several of them may be connected in series and the readings of all of them added. It is also possible to measure the voltage between two wires in the manner shown in Figure 159. The voltmeter here measures the difference of potential around one lamp and if all lamps are exactly the same this need be but multiplied by the number of lamps in series to obtain the voltage over the whole group. If more accurate results are desired, the voltage around each lamp may be taken and all of them added. Should, however, the lamp at the voltmeter break

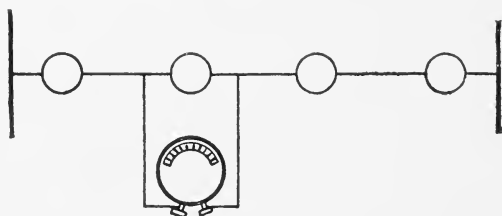

Figure 159

while the meter is connected around it, the voltmeter might be quickly burned out.

There are two classes of commercial ammeters. One of these, not extensively used, is cut in series with the line and all of the current passes through it. Such ammeters have very few turns of wire and are seldom used on heavy currents. The kind in most extensive use at present is known as the "shunt" ammeter. This type of ammeter takes only a small fraction of the current, the bulk of it passing through the "shunt." Such a shunt is shown in Figure 160 and the manner of attaching the cords leading to the ammeter is also shown. The shunt must be designed for

the particular instrument with which it is to work. Nothing must be allowed to disturb the relative resistance of shunt and instrument and the cord sent with them should always be used full length, or the readings will be inaccurate.

The measuring capacity of any ammeter may be increased by providing a suitable shunt. If the resistance of the shunt is made $1/9$ th that of the ammeter, the readings must be multiplied by 10 to obtain the flow of current, if $1/99$ th by 100, or $1/999$ th by 1000.

If the capacity of one ammeter is insufficient to measure the current, several of them may be con-

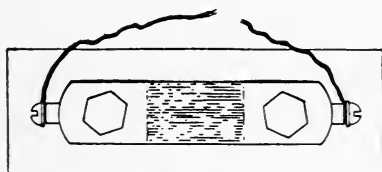

Figure 160

nected in parallel. but each must be provided with its own shunt.

Two ammeters must never be connected to one shunt.

WHEATSTONE BRIDGE

For the measurement of resistances ordinarily met with the Wheatstone bridge is generally used. The principle of its operation, if thoroughly understood, will greatly assist in comprehending its uses.

In Figure 161, a battery is connected in series with a resistance AB. If the battery has a difference of potential of one volt, and AB has a resistance of 10 ohms (the balance of the circuit being considered as

having no resistance) a voltmeter connected across from A to B would indicate one volt difference of potential. If the voltmeter is connected between A and C, the resistance between A and C being 5 ohms, the voltmeter will show $\frac{1}{2}$ volt. According to Ohm's law $E = IR$. I , the current, being constant, the voltage between any two points must be proportional to the resistance between these two points. If the resistance between A and D is one ohm, the voltmeter connected between A and D would indicate $\frac{1}{10}$ volt, while if the voltmeter was connected between B and D it would indicate $\frac{9}{10}$ volt. The resistance of the wire A B

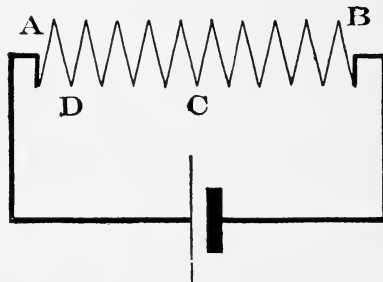

Figure 161

might be 20 or 30 ohms, or the battery might have a voltage of 10 or 20 volts, the drop over any two points on the resistance would, nevertheless, be proportional to their resistances.

In Figure 162, two resistances are connected in parallel with each other, and in series with the battery. If the voltage of the battery is one volt, that difference of potential will be shown by a voltmeter connected across A and B. The difference of potential between A and any point in the resistance A C B will be proportional to the resistance over which the voltage is measured. The same is true of resistance A D B so

that for every point in wire A C B there is a corresponding point in resistance A D B of the same difference of potential. Suppose C and D to be two points of equal potential, then there would be no current flow over a wire connecting these two points, and a galvanometer placed in this wire would indicate nothing. The resistance of A C will then be to the resistance of B C as the resistance of A D is to the resistance of D B. or calling these resistances b , x , a and r respect-

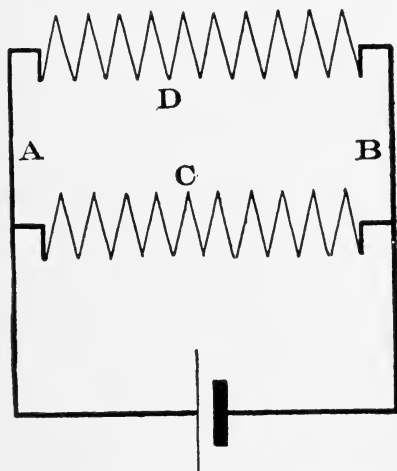

Figure 162

ively we have the proportion $a \div r = b \div x$. This expression may be written

$$\frac{a}{r} = \frac{b}{x}, \text{ then } x = \frac{b}{a} r$$

A diagram of the connections of the Wheatstone bridge is shown in Figure 163, a and b are the proportional arms, while r is the known resistance and x the unknown, or the resistance to be measured. The battery is connected across A and B while the galva-

nometer is connected between C and D. Both battery and galvanometer circuits are provided with keys and are normally open.

In the type of bridge shown, the resistances are connected between brass strips, brass plugs inserted in the holes between the strips short circuiting those resistances which are not used. In each of the proportional arms a and b one plug is always left out.

To measure an unknown resistance, proceed as follows: Connect the resistance to be measured across the terminals at X. Leave unplugged one resistance

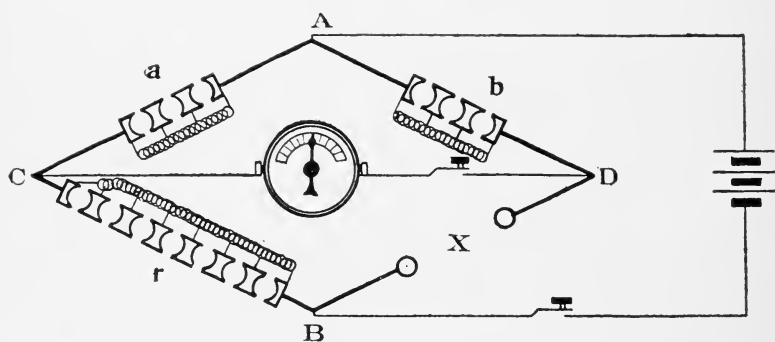

Figure 163

in each of the arms a and b. If it is known that the resistance of the apparatus being measured is not less than the smallest resistance in r or greater than the greatest resistance in r, make the unplugged holes in a and b of equal resistance, say 10 and 10, and remove one of the plugs in the arm r. Now press down the battery key and then the galvanometer key and note the direction of the deflection of the galvanometer needle. Now either replace or remove some of the plugs in r and proceed as before, and note the deflection. If the deflection is in the opposite direction the

value of the unknown resistance must lay somewhere between these two, and if the deflection is in the same direction as before, note the extent of the deflection, if greater too much resistance has been plugged in and if less, too little. Repeat these operations until no deflection is obtained. The total amount of the unplugged resistance in r will then be equal to the resistance being measured, for

$$x = \frac{b}{a} r, \text{ where } \frac{b}{a} = \frac{10}{1}$$

If the resistance or the apparatus being measured is such as not to come within the limits of the resistance in arm r , the unplugged resistance in one of the proportional arms a and b must be varied. If x is large

as compared with r , then from the formula $x = \frac{b}{a} r$

we see that b must be made greater than a . If 10 ohms is unplugged in the a arm and 100 ohms in the b arm, then the unknown resistance x will be 100/10, or ten times the resistance in r . On the other hand, if x is

small as compared with r , then $\frac{b}{a}$ must be small. With

ten ohms unplugged in b and 100 ohms in a , x would be 10/100, or 1/10 of r .

When balance is obtained, the position of the battery and galvanometer could be reversed without changing

the indication of the galvanometer. In using the bridge the battery key should always be depressed first, for in measuring a resistance containing inductance or capacity such as a long lead covered cable or a circuit containing magnets, if the galvanometer key is depressed first and the battery key afterward, a deflection might be obtained on the galvanometer even with the resistances balanced, this being due to the

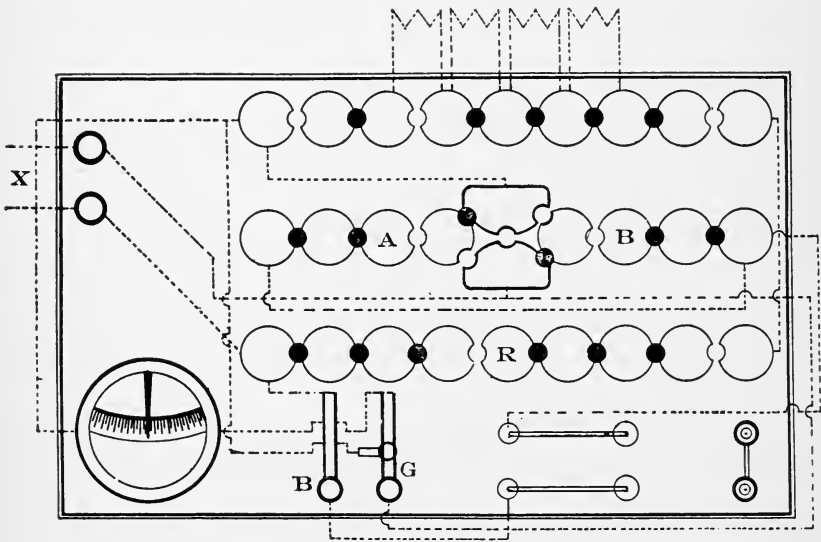

Figure 164

fact that inductance or capacity in the circuit tend to momentarily hold back the current so that it requires some time to come to its full value.

One form of Wheatstone bridge known as the Queen Acme testing set, which is in very common use, is shown in Figure 164 with a diagram of connections shown in Figure 165. A galvanometer and battery form a part of this set so that the instrument is complete in itself. A number of round brass blocks

mounted on a hard rubber base form the terminals of the various resistance coils, as shown in Figure 164. Brass plugs inserted in the openings between these blocks short circuit the resistance coils so that only those coils are in use on which the plugs are removed. The middle row of blocks form the two proportional arms corresponding to A and B, Figure 165, while the upper and lower arms form the resistance R.

The resistance to be measured is connected between

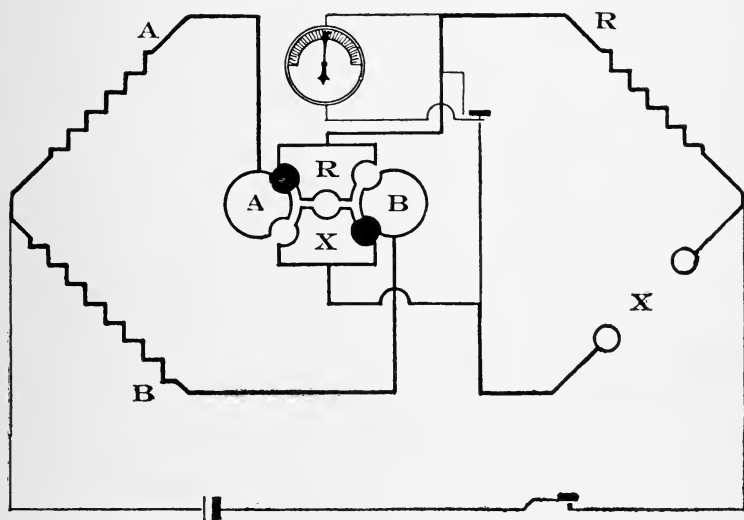

Figure 165

the posts marked X. The battery circuit is normally open, being closed by the key B. The galvanometer key is also normally open, being closed by the key marked G. When this latter key is released it makes contact with the point shown above the key, this short-circuiting the galvanometer winding. This action tends to stop the swinging of the needle and makes it come to rest quickly. Six chloride of silver cells are provided in a sealed metal case. Connection is made

to the cells by means of small plugs fitting over pins which are connected to the separate cells. By this means the battery strength can be varied for various tests.

The galvanometer is of the permanent magnet type, having a movable coil.

One particular feature of this bridge is the method of reversing the proportional arms A and B. This is more clearly shown by reference to the diagram, Figure 165, which shows a simplified diagram of the connections of the bridge. The two proportional arms are provided with different resistances, A having 1, 10, and 100, while B has 10, 100, and 1,000. With the plugs inserted between A and R and B and X arm A is placed in series with R and arm B with X. The resistance of X will now be

$$X = \frac{B}{A} R$$

With the plugs placed in the other two holes, between R and B and A and X the above arrangement is reversed or

$$X = \frac{A}{B} R$$

With the lowest resistance in A, 1 ohm, and the highest resistance in B, 1000 ohms X will be 1000 times R for the first position and 1/1000 of R for the second position, so that for measurement of high resistances the plugs should be placed as shown in the

diagram, while for measurement of low resistances the plugs should be placed in the opposite holes. With a single plug inserted between R and X, the instrument may be used as a straight resistance box, the connection being made between the posts X.

MAGNETO

The magneto is used for testing purposes where an approximate determination of the insulation resistance or a test as to continuity of a conductor is desired. This piece of apparatus is a simple form of alternating current dynamo. The fields are formed by permanent steel magnets, while the armature is made of soft iron, the wires being wound through two slots running parallel with the axle. The armature winding consists of one coil of a considerable number of turns of fine wire. One end of this coil is directly connected to the metal frame of the magneto, while the other end is connected to an insulated pin running through one end of the shaft.

By means of a crank connected to a gear wheel working in a pinion on the end of the armature shaft, the armature is turned at a high speed. As the armature revolves an alternating current is generated flowing in one direction during half a revolution of the armature and in the reverse direction during the balance of the revolution

A polarized bell is connected in series with the magneto armature. A ring may be obtained with the ordinary testing magneto through a resistance of from 25,000 to 50,000 ohms, the capacity of the magneto depending on the strength of the permanent magnet,

number of turns of wire on the armature and the speed at which the armature is revolved.

In testing lead covered wires or cables, a ring is sometimes obtained even when the line which is under test is clear. This effect is due to the lead covering of the cable which causes it to act as a condenser, becoming charged as current from the magneto flows into the wire and then discharges back through the bell magnets. The same effect may be produced in testing lines installed in iron pipe. In this case the action is as follows: When current from the magneto flows into the wire lines of force are produced in the space around the wire, these lines of force being greatly increased by the presence of the iron pipe. As the current ceases to flow into the pipe these lines of force close in on the wire and produce a current in the opposite direction to the original current.

These effects are generally obtained on long runs of wire only so that for the ordinary test the magneto will indicate correctly.

TELEPHONE RECEIVER

One of the most convenient devices for ordinary testing purposes consists of a telephone receiver connected in series with a few cells of dry battery. An outfit of this kind is easy to make, and has the advantage of being small and easy to carry about. The outfit generally consists of what is known as a "watch case" receiver connected to two small cells of dry battery. Flexible cords of suitable length are provided with clips at the ends. A permanent connection can be made with one terminal and the other used for

testing. The outfit is very light and can be easily carried in the pocket.

This apparatus has several advantages over the magneto. A test can be made in much less time as the necessity of turning the magneto is avoided. The telephone receiver being more sensitive than the magneto bell, the approximate resistance can be more readily ascertained. In fact, with a little practice one may become so accustomed to the "click" as to be able to determine very closely the insulation resistance. In using the apparatus in this way, contact should be made by simply "tapping" the wire which is being tested. The connection should never be left on for any great length of time, as the battery will weaken and the click will be reduced.

In testing for insulation resistance with a magneto, or in fact, any of the common methods in use for this purpose, the condition of perfect insulation is shown by no indication on the testing apparatus; for instance, no ring with the magneto. The same indication would be obtained if the apparatus was defective, or if the wires connected to the apparatus were broken so that one is never certain when no ring is obtained on the magneto bell that the wire being tested is clear.

With the battery and receiver a click will be obtained on nearly all tests, even though the insulation resistance is very high so that one can always be sure that the apparatus is working properly.

In testing a lead covered cable or wires in conduit, the condenser effect due to the lead covering will cause a click even where the wire which is being tested is

clear. This may be overcome by making a succession of contacts, the first contacts charging the lead covering and the succeeding contacts indicating the condition of the wire.

In making up an apparatus of this kind, it is well to have some means of opening the battery circuit when not in use, so that the battery will not short in case the ends of the flexible cords should come together.

CHAPTER XIX

TESTING DYNAMOS AND MOTORS

The usual tests to be made on dynamos are :

Insulation resistance.

Rise of temperature.

Regulation.

Efficiency.

The insulation resistance is easily measured by a voltmeter attached to a circuit, as shown in Figure 166.

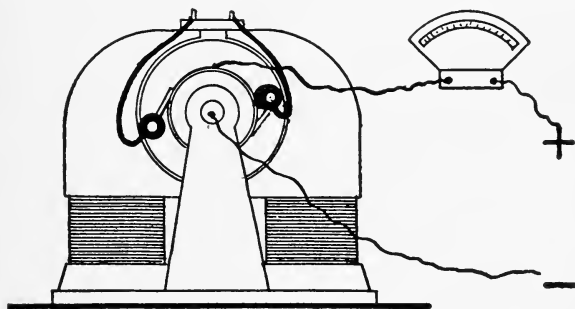

Figure 166

If there is any indication of current, the insulation is defective. The voltage used for this test should be equal to that for which the dynamo is intended. Very often such an indication is due to dampness and the machine may be cleared up by running it for a while with a strong current that will cause the wiring to heat up considerably. This must not be attempted if the voltmeter indicates a serious defect.

The formula for use in connection with a voltmeter when the exact amount of the resistance is desired to be known, is:

$$X = R \frac{V - V'}{V}$$

Where V is the full voltage of battery or other source of current and V' the reduced reading obtained through the voltmeter and the resistance to be measured, and R the resistance of the voltmeter.

To determine the temperature rise, the machine must be run for some time with the full current for which it is designed. Small machines often attain their maximum temperature in five or six hours, larger ones must be run longer. It is always advisable to continue the test as long as there is any noticeable increase in temperature from time to time. The test is made by placing a suitable thermometer upon the frame of the machine and covering it with waste so as to eliminate the cooling influence of the air. As an undue rise of temperature causes the most harm to the windings, it is to these that the thermometer should be applied and in such a location that the highest temperature produced in any accessible place will be recorded.

Roughly a temperature rise of about 60 degrees above the surrounding atmosphere may be allowed but if the machine is to operate in a very hot room, a lesser allowance must be made. Very few insulations will stand a temperature higher than 150.

To test the regulation of a machine it should be

run with loads varying from 0 to the full load. The greater the drop in voltage within these limits, the poorer is the regulation of the machine. If a compound wound machine is to be tested in this manner, the compound winding must be short circuited so that it will have no effect upon the voltage. After the foregoing test has been made, the compound winding may be placed in service and another test made to determine the regulation with this winding in action.

While this test is being made the action of the commutator may also be noted. A change in load, of course, brings with it a necessary change in the position of the brushes. This should not be very much, however, as the machine will be troublesome to handle.

The regulation test with motors is simply a test for variation in speed with changes in load. The load may be placed upon the motor by means of the Prony brake arrangement, shown in Figure 168, or by arranging to have the motor drive a dynamo as illustrated in Figure 167. In this test the change in voltage of the line supplying power should be taken into consideration. If there is much resistance in this line there will be considerable drop in voltage and this will cause a slackening off in speed.

A well designed shunt motor at the terminals of which a constant E.M.F. is maintained should not drop off more than 10 per cent in speed from no load to full load.

Figure 167 shows the connections for testing dynamos and motors without the expenditure of much energy. The motor M drives the generator G and the

current from it is pumped back into the line. The actual energy absorbed and lost in the test is only that which is taken up to overcome the friction and the losses in the two machines. This arrangement for obtaining a load can be used for any of the tests previ-

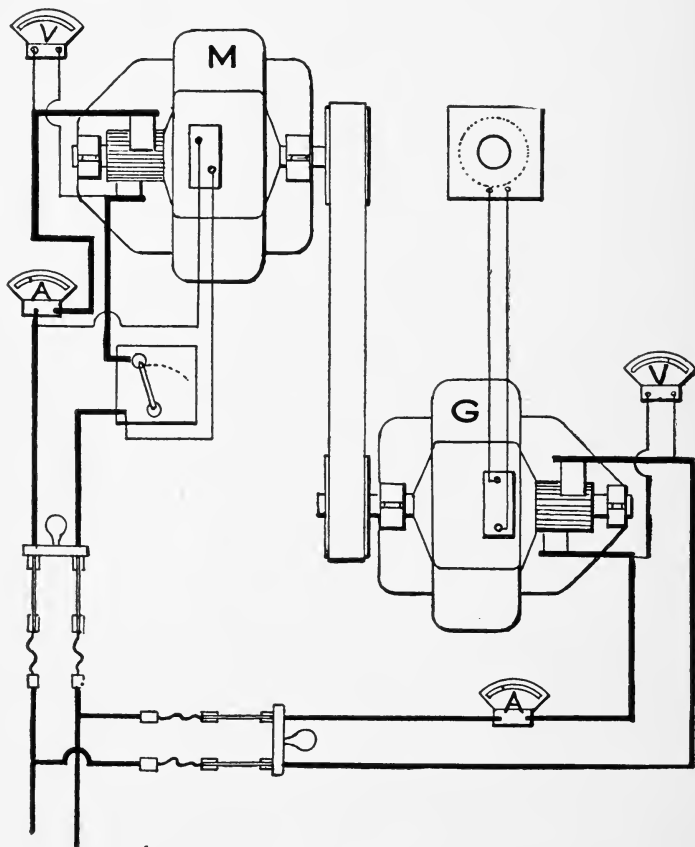

Figure 167

ously described. The power consumed by the two is found by multiplying the volts and amperes used by the motor.

The power delivered back to the line is equal to the product of the volts and amperes in the generator cir-

cuit. Roughly the efficiency of the two is the load on the dynamo divided by the power delivered to the motor.

In order to obtain the efficiency of the generator, we must first have the efficiency of the motor. If the two machines are similar, either motors or generators it will probably be accurate enough to assume that half the loss occurs in each machine.

If such is the case, we must take the square root of the combined efficiency to obtain the efficiency of the

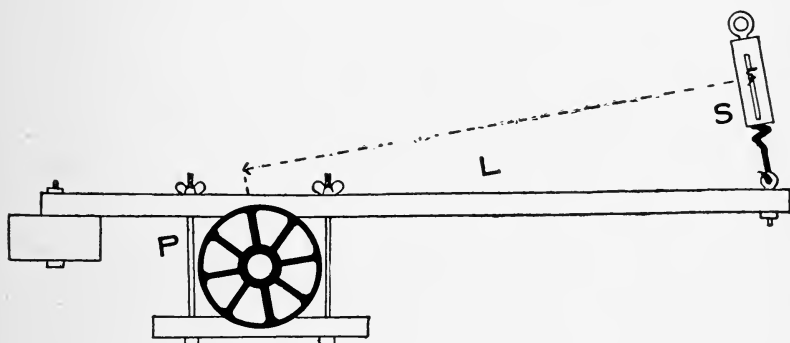

Figure 168

single machines. Thus, if the efficiency of the two machines is .81, the efficiency of either machine singly will be .90.

The efficiency of a motor may be tested by means of the well known Prony brake shown in Figure 168. In this figure P is a pulley attached to the shaft of the motor. The lever L is fastened to the pulley by means of the block and the thumb screws. When the motor is in motion the screws must be so tightened that they will allow of rotation of the armature shaft sufficient so that the motor may be taking the current at which it is to be tested. The spring scales

are provided to measure the force with which the motor acts upon the lever.

In order to learn the power delivered by the motor we must know the length of the lever from the center of the pulley to the scale. The number of pounds registered on the scales and the speed of the pulley in revolutions per minute. The product of these factors divided by 33,000 will give us the H. P. delivered by the motor.

The products of the volts and amperes maintained at the terminals of the motor while the foregoing observations were made will give us the H. P. consumed by the motor and the H. P. delivered divided by the H. P. consumed will give us the efficiency of the motor.

In connection with alternating current motors the volts and amperes at the terminals of the motor must be multiplied by the power factor. The power factor, however, varies with the load on the motor and other line conditions and will generally have to be guessed at unless a power factor indicator is at hand.

The above test is usually made at full load. If the losses at no load are required we need but take the produce of the volts and amperes when the motor is running empty.

The loss in the fields of a dynamo or motor may be made exceedingly small or may take up nearly the whole output of the machine. From time to time cheap motors are brought out that require almost as much energy to excite their fields as is required to do the work. A test of the field losses can readily be made by measuring the current flowing in them. This

should not be much over 5 per cent of the capacity of the motor for medium sizes.

CIRCUIT TESTING

Figure 169 can be used to illustrate the principles which underlie the testing for trouble on series arc or incandescent circuits. The principal troubles encountered on such circuits are due, either to an open circuit, or to one or more grounds. If more than one ground exists and if those grounds are "good," they will cut out a number of lamps and for that part of the circuit amount to the same thing as though a short circuit existed on a multiple circuit. If, for in-

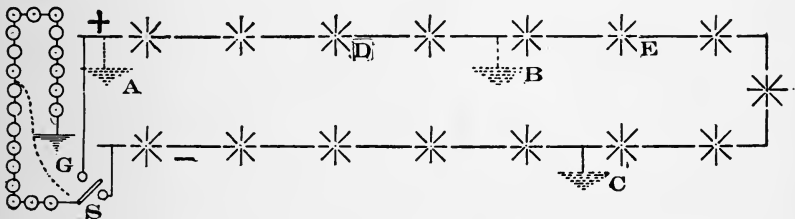

Figure 169

stance, two good grounds exist as shown at B and C, they will have the effect of cutting out the lamps shown at the right, the current passing through the low resistance of the ground rather than through the lamps.

Sometimes, however, such grounds are not very good and then they merely rob the lights of part of the current; at other times such grounds are intermittent and due to wires swinging against wet trees or buildings, or the jarring of railroads, etc., which cause bare parts of the wires to come in contact with

grounded parts of structures. So long as there is but one ground on a system no harm can result because this can establish no circuit through which current can flow. But when the second ground appears, there is sure to be trouble, and furthermore the existence of one ground makes the appearance of a second far more likely because the resistance from pole to pole through the ground is thereby reduced one-half.

If one ground exists, the repair man or operator, if in connection with the ground will, when he touches the wire, at once establish the second ground and cause more or less current flow through his body. It is, therefore, of the utmost importance from every point of view to detect grounds as soon as they come on to a system. For this purpose every plant should be equipped with a ground detector as elsewhere described and frequent tests should be made with it.

If a ground has been noted on the line, the best way to locate it is the following: Cut off the current, leave the circuit open, and place a temporary ground on one of the wires at the station; then go out along the line and at some convenient place open the circuit of that wire on which the temporary ground is placed. Insert into the circuit any of the testing instruments previously described. So long as an indication is obtained it shows that you have cut into the circuit between the two grounds; when no further indication can be obtained the ground has been passed; thus, suppose the ground to be located is at B, Figure 169, and the temporary ground at A; if the testing set is introduced at D, there will be an indication of current,

while when it is placed at E there can be none. If the line has been closely watched, it is very unlikely that more than one ground will come on suddenly but in case of an old line that has been neglected and in the event of a heavy rainstorm, it may be possible that several grounds appear together. If the conditions make this appear as likely, it will be well to cut the line into sections and see which parts are clear as the above test will be very confusing if more than one ground should exist at the same time.

If the line cannot be cut dead long enough to locate the ground, there are two ways in which the ground can be located. One method which may be used if the ground on the line is good and if there is no danger from fire, consists in putting a second ground onto the system and noting which lamps are thereby cut out of the circuit. Thus, if as in Figure 169 the ground to be located exists at B and a test ground is put on at A, all of the lamps between A and B will be cut out and will show that the ground is somewhere between the two lamps, on either side of B.

In place of the foregoing, connections may be made as shown in Figure 169, at the left. Here the little circles represent a series of 100-volt incandescent lamps (each lamp requires twice the voltage of one of the arcs), which by means of the throw over switch S may be connected to either side of the circuit. G is a ground permanently connected at the last lamp in the series. These lamps as connected virtually measure the difference of potential which exists between the point on the line at which the ground is located and the location of the ground at the lamps. If, with

a ground located at B, connection is made by the throw over switch to the positive wire, there will be only the difference of potential due to four lamps which will cause the incandescent lights to burn, while if connection is made to the negative wire there will be a difference of potential equal to eleven arc lamps which will manifest itself on the incandescent lights. By means of the flexible wire shown in dotted lines, some of the lamps can be cut out until those remaining in circuit burn at full candlepower. If the voltage of the incandescent lamps is as indicated above, twice that of the arcs, then for every incandescent lamp burning at its proper candlepower, there will be two arc lamps between the station ground and the one on the line; in the case as shown in diagram, if connection is made to the upper wire, two incandescent lamps will burn properly while with connections made to the lower wire, five will burn.

To locate open circuits it is also of advantage to place a ground on one side of the line, at the station as at A. Now go out on the line and test back to this ground, of course, grounding the instrument you have. As long as you are located between the open place and the station, you will get an indication; when this place is passed no further indication can be obtained.

In connecting up arc lamps, it is best to begin at one end of the circuit, determine whether this is to be positive or negative, and connect the first lamp accordingly. Now ground that end of the circuit and proceed to the next lamp on that leg. If the wires are run overhead, there will be no difficulty in tracing the wires, but if they are underground there will be two

ends visible, and it must be determined which of these is to go to the positive and negative poles of the lamp. By grounding the end from which the start was made it will be easy to test back and find the leg which comes from the lamp first connected.

The finding of grounds on multiple circuits is a much simpler matter. Such systems are always subdivided into branch circuits so that no great amount of wiring is ever dependent upon a single fuse, and by these fuses any part of the wiring can be readily separated from the rest. A ground having been discovered on such a system, it becomes necessary to disconnect different centers until the one containing the ground is found. When so much is accomplished the branch circuits are next disconnected until the proper one is found. After this, if the wiring is open, an inspection will reveal the exact location, if the wiring is concealed it may further be necessary to disconnect parts of the circuit until at last the section containing the trouble is found.

With multiple circuits a broken wire always indicates very nearly its exact location, so that it can easily be found by inspection. If, for instance, in Figure 170, the wire is broken at E, the seven lights at the right will not burn, while those at the left will not be interfered with; if only the wire at F is broken only one light will be out.

A new system of incandescent lighting is best tested circuit by circuit. By testing for ground over a whole installation at once, there is always the chance that some of the fuses may not make proper connection (especially with cartridge and plug fuses) there

is also a likelihood that some of the switches may be left open; either of these conditions would make the test very unreliable. When each circuit is tested by itself the testing instrument can be connected to the binding posts of the cut-out, or at any socket in the circuit, wherever it is most convenient to obtain a ground connection for the instrument. Unless lamps are installed in the sockets each leg must be separately tested, and if switches do not indicate whether on or off, the test should be made with the switch in two positions, one of which is sure to be on. With most snap switches it is, however, easy to determine by the

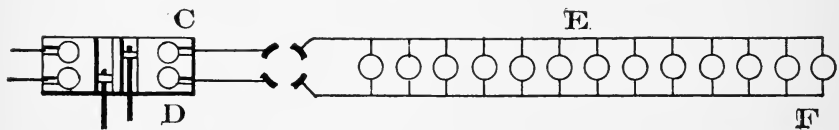

Figure 170

sound of the snap whether the switch is closed or open.

The next test to be made is for short circuit. If a good instrument is connected at C and D and a short circuit exists, it will at once cause an indication. If there is no such indication, we may proceed to test for continuity. For this purpose the testing instrument may be left at the cut-out and connection made at each socket with a screw driver or anything else by which the opposite poles can be brought together so as to obtain an indication on the test instrument. Where plug cut-outs are used, a lamp screwed into one of the receptacles of the cut-out is about the only test instrument needed except when testing for grounds.

In connection with three wire circuits, it is custom-

ary to run the neutral wire in the center, but one must not always rely upon this being the case. It is very important to have these wires properly connected, as a wrong connection will result very likely in the destruction of a large number of lamps, and possibly in causing a fire. If the neutral wire on the system is grounded there are two ways by which it can be found. The simplest method, requiring only one lamp, is to connect this lamp to ground and to the wires one by one, when connected to either of the outside wires the lamp will burn at full candlepower, while when connected to the neutral it will not burn at all. The other method requires two lamps but no ground connection, and on this account is the most used. Connect two incandescent lamps of the proper voltage in series and try the wires, two at a time; when the positive and negative wires are found, the lamps will burn brightly, while in connection with the neutral they will be at less than half candlepower. This test is also often made by touching the wires with the fingers where the voltage is not over 220 and determining by the severity of the shock which are the two outside and which the neutral wire.

If it is desired to learn which is the positive or negative wire, the test can be made by inserting ends of wire connected to the two poles of the circuit through some water contained in a small cup (non-conducting material preferred). The negative pole will be indicated by the formation of small bubbles of hydrogen gas near the wire. If a metal cup is used for this test, there is, of course, danger of a short circuit if the wires come in contact with the metal.

In Figure 171 we explain the testing out for the connection of a pair of three-way switches. It is assumed that the wires are run in conduit and nothing but the ends of the wires in the three junction boxes are visible. The switches are to be located at 1 and 2 and the lamp to be controlled by them at 3. First find which are the feed wires, in this case 4, and bend them out of the way; now at each of the switch outlets take any two of the three wires and twist the bared ends together and proceed to the light outlets, and by testing find the two short circuits thus made and permanently connect these two sets of wires together. Con-

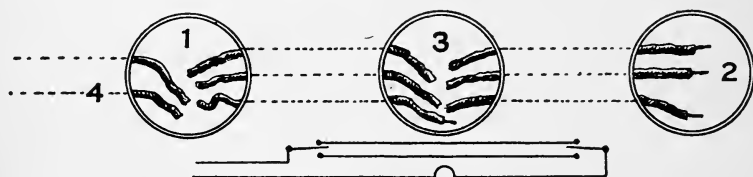

Figure 171

nect the lamp to the remaining pair at this outlet and at 1 connect the single wire coming from 3 to one of the feed wires. The remaining feed wire now goes to that pole of the switch which is in direct connection with the line, and the other two are connected to the other binding posts. The other switch outlet is, of course, connected in the same way.

Figure 172 will help to illustrate the method of testing out a circuit of incandescent lighting for the purpose of making the final connections. We begin by placing some testing instrument and battery at the cut-out and connecting it to the circuit as at T. Now proceed to one of the outlets and baring the ends of wires found there, bring the different ends temporar-

ily together until two wires are found that cause an indication on the testing instrument. The most convenient instrument for this purpose is an ordinary call bell and battery, as it can be heard throughout different rooms. After the wires coming from the cut-out have been found, ends at other outlets may be temporarily connected together as, for example, at L and we now again try different wires in connection with the pair found until a ring is obtained which in-

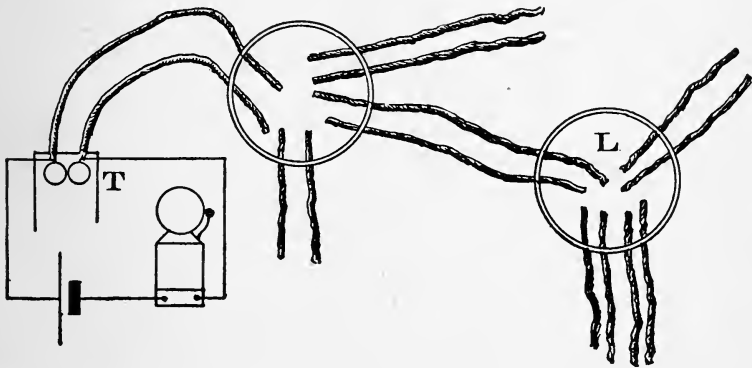

Figure 172

icates that we have found the wires thus connected together. In this manner by proceeding from outlet to outlet the meaning of every wire can be determined and connections made as required. As a precaution, before beginning to test out in this manner, it will be well to separate all wire so there may be no accidental short circuits, which would cause confusion.

Three tests should be made on every fixture before it is installed, and for these tests sensitive instruments should be used, or a voltmeter and the pressure of the lighting system. The first test may be for short circuit in the wiring and for this purpose connections

are made as shown in Figure 173. If this test shows clear the connections may be left as they are and a test for continuity made by inserting a screw driver or other piece of metal into each socket so as to complete the circuit through the voltmeter and cause an indication. If all sockets are found perfect, the test for contact with the metal of the fixture may be made by disconnecting one of the wires, say 3, and bringing it in contact with the metal of the fixture while the

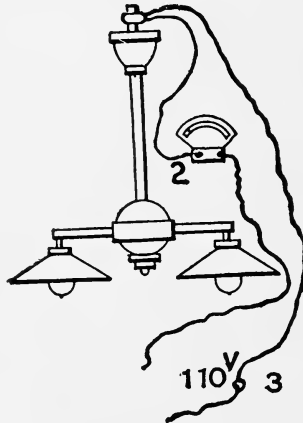

Figure 173

disconnected fixture wire is connected to the other wire of the voltmeter at 2.

A circuit can be tested for loss in the following manner: With a voltmeter measure the voltage at the supply end of the line, and also at the center of distribution or at the motor, as the case may be. The reading will always be greater at the supply end and the difference between the two will be the loss in voltage. In order to find the percentage of loss in the line, we divide the volts lost by the volts at the supply end.

The loss varies with the current and is inversely

proportional to it. In order, therefore, that the test may be of value, it must be arranged that at the time of test the average current be in use or if this is not practicable, the current flowing at the time of test must be known. The average loss will be in the same proportion to the loss indicated as the average current is to the current flowing at time of test. This current multiplied by the volts at the supply end of the line, will give the total watts delivered at this point, and this multiplied by the percentage of loss will give the total watts lost.

Instead of making the above test with a voltmeter, it can be calculated if the size of the wire used is known. The loss in voltage is equal to the current multiplied by the resistance, and, therefore, if the resistance is known, we need but multiply with the amperes to find the loss in volts. In the table below the loss in volts per 100-ampere feet (length of run, one leg, X current) is given to facilitate these calculations. The loss in volts is the same, no matter what the voltage of the system may be but, of course, the percentage of loss which the actual loss represents differs with the voltage of the system; thus, a loss of $5\frac{1}{2}$ volts corresponds to a loss of 5 per cent at 110 volts, but only $2\frac{1}{2}$ at 220.

B. S. gage.	Loss in volts per 100 amp. ft.
14	.53
12	.33
10	.21
8	.13
6	.08

4052
304
203
1026
002
00016
000013
000001

To find the loss in any line by the use of this table; multiply the current by the length of one leg of the line and divide by 100. Use the product so obtained to multiply the loss given in the table, the result will be the total loss in volts in the line.

If the size of wire in any installation is not known, the best and simplest manner wherever practicable to determine it is with a wire gage. Such a gage is, however, not always at hand and in connection with wires already installed, often cannot be used without cutting into the insulation.

Below is given a table by which the gage number of wires can be quite approximately determined from outside measurements. Although these measurements are not perfectly correct, they will not be found sufficiently inaccurate so that any very great errors will be caused thereby.

The circular mils contained in any wire can be found by multiplying the diameter of the wire expressed in thousands of an inch by itself. If the wire in question is stranded, the square of the diameter must be multiplied by .75, this will give quite approximate results although not quite accurate.

TABLE SHOWING OUTSIDE DIAMETERS OF WIRES IN 64ths

B. & S.	Rubber Covered Wires.				Weatherproof Wires.	
	Single Braid.		Double Braid.		Solid	Stranded
	Solid	Stranded	Solid	Stranded		
8	18-64	22-64	22-64	23-64	17-64	18-64
6	22-64	24-64	26-64	28-64	20-64	22-64
4	25-64	27-64	29-64	31-64	25-64	28-64
3	27-64	30-64	31-64	34-64	27-64	30-64
2	29-64	32-64	33-64	37-64	30-64	33-64
1	33-64	37-64	37-64	42-64	32-64	35-64
0	36-64	40-64	40-64	45-64	36-64	39-64
000	38-64	43-64	43-64	48-64	39-64	43-64
0000	41-64	48-64	46-64	55-64	47-64	51-64
250,000	47-64	52-64	54-64	57-64	50-64	55-64
300,000	59-64	58-64
400,000	61-64	62-64
500,000	66-64	73-64
600,000	73-64	80-64
700,000	79-64	85-64
800,000	83-64	94-64
900,000	89-64	100-64
1,000,000	94-64	103-64
1,250,000	97-64	108-64
1,500,000	107-64
	113-64

TESTING FOR, AND PREVENTION OF ELECTROLYSIS

The damage due to currents of electricity passing from the grounded part of the structure and rails of any system of distribution, such as a street railway line for instance, depends entirely upon the relative resistance of the metallic return circuit afforded by the structure and whatever auxiliaries may have been

provided and the resistance of the earth in the vicinity of the structure.

There are but two ways in which this action can be lessened or prevented, the insulation of gas and water pipes being considered impracticable. One of these methods consists in providing a metallic return circuit of very low resistance so that only a very small amount of current will escape from it. With this method the amount of copper required is large and varies with the conductivity of the earth return in different places. At best it can only mitigate the evil since no amount of copper can ever entirely prevent it.

The other method consists in bonding all pipes and other metallic bodies that are underground in the vicinity of the structure to the structure in such a way that current can pass to and from them without doing any damage. This latter method, of course, involves also the bonding of all pipes at all joints. If this is not done, it will aggravate the trouble rather than lessen it, since the various bonds might conduct a large quantity of current to a certain pipe which might be a very good conductor with exception of one joint, for instance, and at this joint the greater part of the current would pass from the pipe to earth and back again, thus rapidly causing serious damage. All of the damage occurs where the current leaves the pipes, and if it is not possible to make the piping a part of the return system as above described, the next best thing will be to protect those points where the current leaves the pipes.

To determine how this can best be done, comprehensive tests should be made. With a voltmeter which

will indicate the direction of the current, readings should be taken at a number of places, the more the better, from the structure or rails to accessible parts of gas and water pipes near the structure. The pressure and direction of current should be noted so that complete map of the system can be made from it. This being done, a map of the piping along the line of the railway should be provided, and the two combined in such a way as to show the exact relative position of pipes and leaks. In addition to this careful tests of the bonding of the structure should be made, and any bad spots marked upon the map. The map will now reveal quite approximately the relations existing between the structure and the earth, pipes, etc. The current flowing between structure and piping cannot be measured, but may be estimated.

If high pressure towards a pipe is found to exist and at the same time the pipe is very close to the rails, it would indicate a large current. The same pressure with the pipes farther away would suppose a smaller current. Again the high pressure might be caused by one or a few bad bonds. If the structure is perfect, and the pipe lines are also in about the same condition throughout the route, a maximum pressure from the rails to pipes will be found at the far end, and this will gradually decrease toward the middle and will from there on be in the opposite direction, from pipes to rails toward the power house. No attention need be paid to current passing from the rails. The endeavor must be to intercept the current where it leaves the pipes, especially where large currents are indicated. Unless the pipe line can be bonded through-

out, nothing that would lessen the resistance between structure and pipes should be installed, because this would increase the current. It would, therefore, seem to be advisable to connect suitable ground plates to the pipes where current leaves them, so that the electrolytic action would take place on these instead of on the pipes. If, however, the pipes are very close to the rails, the bonding to the structure would not affect the total resistance of the earth return much, and would, therefore, be preferable. In many places currents will be at different times found to be in different directions, so that all tests should be made to extend over some time.

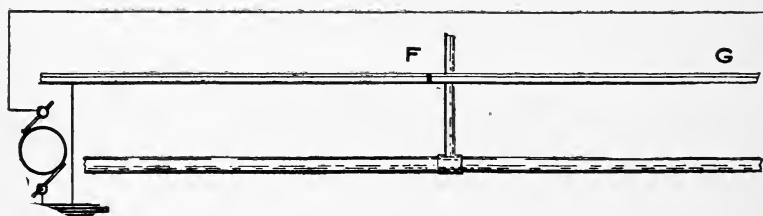

Figure 174

With conditions as shown in Figure 174, where the bad bond is indicated near the pipe, a train using current at G would cause current to flow from the rail to the pipe at the far end and from pipe to rail at the left of the bad bond. A train using current at F would cause a flow of current in the opposite direction. So long as the pipe is near the rails, it will always receive some current.

Tests should be made during that part of the day when the load is most evenly distributed. This will be at the busiest time. The pressure will vary with the currents used in the vicinity at time of testing. The

voltmeter used in testing is connected from the rails to the pipe. It is preferable to have a double scale voltmeter, which will also indicate the polarity, but this is not essential. If no reading is obtained at a certain place, with the wires connected one way, they may easily be reversed and the polarity noted on the map.

In Figure 175 a common method of testing bonds is illustrated. An ordinary milli-voltmeter is used and about 50 feet of No. 20 wire are inserted in each of the leads, as indicated in the diagram. This will give a resistance of about $\frac{1}{2}$ ohm. The two wires nearest

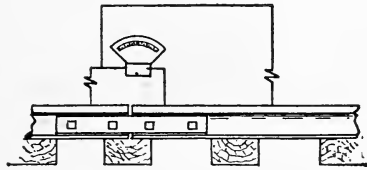

Figure 175

the voltmeter in the diagram are permanently fastened to bridge the bond, and the other wire is moved back and forth on the adjoining rail until a spot is found at which the voltmeter gives no indication while current is flowing. The resistance of the bond is now equal to the resistance of the length of rail between the other two wires. If any bond shows up much worse than the others, it should be attended to.

PHOTOMETRY

To measure the efficiency and the candlepower of different electric lights is a simple matter and much more attention should be given to such measurements than is usually accorded them by operators in charge

of illuminating stations. Thousands of dollars worth of fuel is wasted annually because owners and operators do not understand the loss of energy caused by continuing lamps of low efficiency in service.

There are two very simple methods of measuring candlepower; one of these is known as Rumford's, and is illustrated in Figure 176. A suitable pencil is set up about 2 inches from a wall of light color or a similar screen. A standard lamp is set up a convenient distance from this pencil, so as to cause a shadow from it to fall upon the screen. The lamp to be tested is

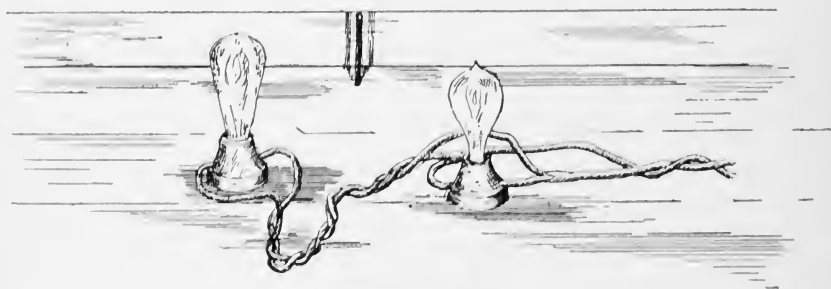

Figure 176

then set up in such a manner as also to cause the pencil to cast a shadow upon the same screen but at a different angle from the other. It will be noted that each lamp illuminates the shadow made by the other and that when the intensity of the two lights at the screen is equal, the shadows will be of equal darkness. The lamps must be adjusted at such distances from the screen that both shadows are equal. The candlepower of the two lamps is now proportional to the squares of the distance that each is from the screen. If one is 32 inches from the screen while the other is 23, the candlepower of the farther lamp is to that of

the nearer as 1024 is to 529, or nearly twice as great. In order to make this test as sensitive as possible it is best to move one of the lamps backward and forward in such a way as to be sure that it is a little too far in one position and then a little too close in the other and then place it finally in an intermediate position.

To measure the power consumed by each of the lamps an ammeter and a voltmeter are necessary. If connected as in Figure 176 the voltage of both lamps will be the same. The current consumed by each lamp can be gotten by removing one lamp at a time from the circuit, thus requiring only one ammeter. The efficiency of the lamp is usually expressed in watts per

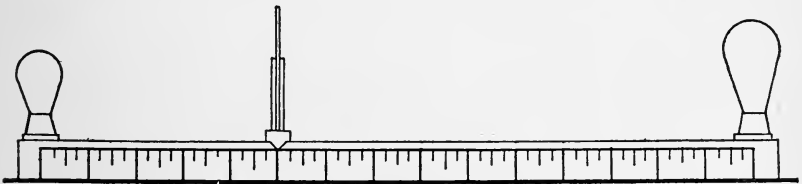

Figure 177

candlepower. If a certain lamp yielding 20 candlepower is taking 58 watts, there will be 2.9 watts per candlepower.

If lamps are to be tested for use on a certain circuit, the voltage of that circuit must be applied to them. The efficiency and candlepower of incandescent lights varies greatly with different voltages.

Another method, known as Bunsen's, is shown in Figure 177. A piece of blotting paper is soaked at a convenient place with oil or grease, so as to form a small spot. The paper is then placed between two lights and moved to such a position that the grease spot does not show. When this position is found, the

illumination on both sides is equal and the candlepower of the two lamps are as the square of their distance from the paper.

The illumination obtainable from a lamp varies greatly with the angle at which the light is taken, and also varies with the shape of the filament. It is further often purposely modified by the use of reflectors. In the illumination of desks, halls, etc., it is often important to know how a certain lamp or reflector distributes the light. For this purpose photometric measurements must be made at different positions under

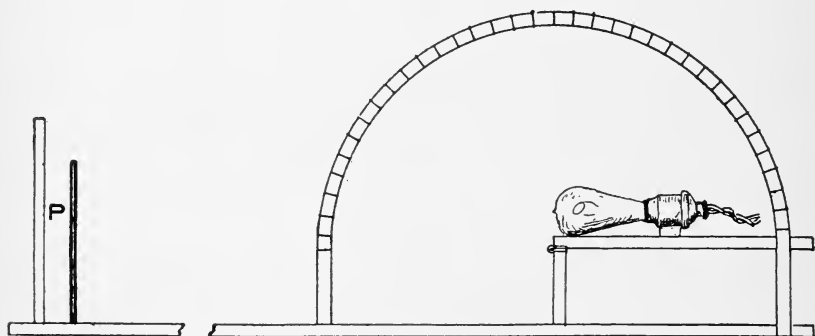

Figure 178

the lamp. This can easiest be done by an arrangement outlined in Figure 178. The lamp is fastened to a strip of wood hinged at one end so that it can be placed in different positions from horizontal to vertical through a range of nearly 180 degrees. In the position shown the light which strikes the pencil or grease spot P comes from the tip of the lamp, and is the same as would be found directly under the lamp if it were hanging. If the lamp is gradually raised and the candlepower taken at the different positions we can obtain a curve of the illumination throughout

one whole side of the lamp. At each change of position the candlepower must be measured and marked off on the radial line in Figure 179 that corresponds with the position of the lamp. When all of these have been marked, a curve may be drawn combining them which will represent the variation in candlepower. Such a curve representing half of the illumination from one lamp is shown in Figure 179. For this test

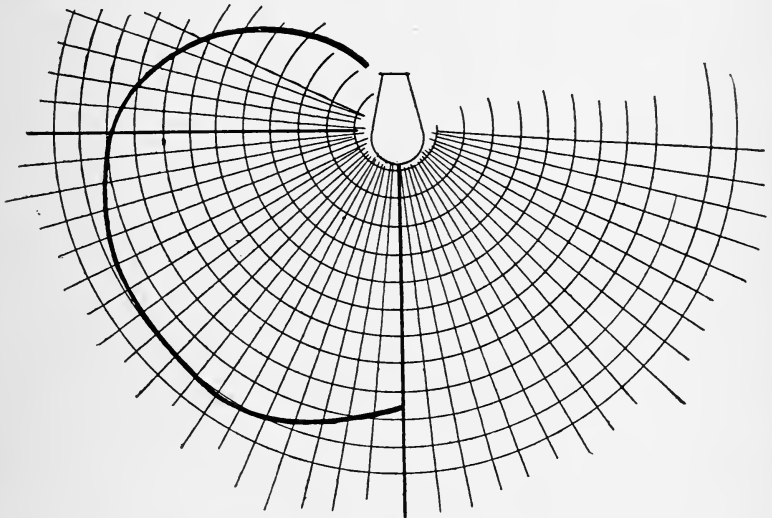

Figure 179

the board upon which the lamp lies should be painted black, so there may be no reflection.

When comparative tests are made care should be taken that the filaments of the lamps tested are about alike. An accurate comparison of different lamps requires the taking of complete curves as in Figure 145. These will give the average candlepower if properly figured up (add all of the measurements and divide by their sum) and also indicate whether the lamp is suited for the place where it is to be used.

The candlepower of arc lamps is often measured by means of the dispersion photometer first suggested by Prof. Ayrton. The principle of the arrangement is shown in Figure 180. The light from the arc is allowed to pass through a dispersion lens which spreads it out over a greater area and thus lessens its intensity.

Since the intensity of light varies as the square of the distance it follows that, using a dispersed light, we may consider the distance of the lamp from the screen as proportional to the square root of the area

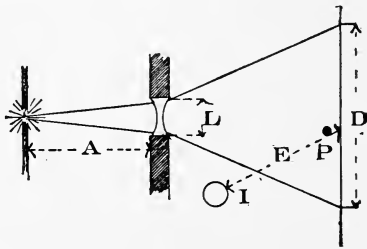

Figure 180

illuminated by the dispersed light. The lens limits the quantity of light, and as it is circular we may take the diameter of the circle illuminated as the square root of the area. The intensity of the light is then the same as though the distance from the arc to the screen were equal to D divided by L and multiplied by A ; D being the diameter of the circle of dispersed light, L the diameter of the lens and A the distance from the arc to the lens. When the shadows cast by the arc and the standard lamp at the pencil P are equal, the candlepower of the arc is as much

greater as that of the standard I as $\left(A \times \frac{D}{L} \right)^2$

is greater than E^2 .

Numerical example: Let A equal 24 inches, L equal 2 inches, D 18 and E 12; we have then 24×18 divided by 2 equals 216; this squared equals 46656, and this divided by 12^2 or 144 equals 324, which is the relative candlepower of the arc over the standard.

CHAPTER XX

DYNAMO AND MOTOR TROUBLES

DYNAMO TROUBLES

In this chapter the usual troubles occurring in dynamos are enumerated in the order in which it is most likely they occur. As a rule, time will be saved by testing for causes in the order in which they are listed.

FAILURE TO GENERATE

Cause 1. Poor contact of brushes. This in turn may be due to dirty commutator, ragged brushes, insufficient tension on brushes, improper position of brushes. A rough commutator, if the dynamo is operating at high speed, may prevent contact even though at rest the connection may appear to be perfect.

Cause 2. Open circuit in the fields. In arc dynamos, this open circuit may be out in the line somewhere. Poor contact of brushes in series machines is equivalent to an open circuit.

Cause 3. Lack of residual magnetism. Test pole pieces with pliers or small piece of iron or steel; if there is no attraction, magnetize fields from a battery or from switchboard, if accessible. If magnetizing with one polarity does not start generation, try magnetizing in opposite direction. Sometimes generation

can be started by striking the pole pieces lightly with a hammer. Series dynamos can sometimes be started by short circuiting the brushes for a fraction of a second by fastening a wire to one of the brushes or terminals and wiping the other end across the other brush for the shortest possible length of time.

Cause 4. With shunt dynamos a short circuit connected to the dynamo will prevent generation entirely. With compound dynamos it may do so only to a certain extent. There will be some magnetism due to the series fields, but none due to the shunt. Disconnect everything from the dynamo except voltmeter.

Cause 5. Wrong connection of half of the fields; one opposing the other. This can be tested for with a compass. If the fields are right, each will attract a different end of the needle. Do not bring needle too close to either pole piece, or it may be reversed in polarity. By short circuiting first one and then the other it can also be determined whether both field coils are acting in the same direction. The needle must be attracted the same way, no matter which coil is cut out.

SPARKING OF BRUSHES

Cause 1. Wrong position of brushes. The brushes should be at the neutral point, and this can be found by moving back and forth until the point of least sparking is found. With increase of load the brushes must be shifted in the direction of rotation of the armature. When load decreases, the shifting must be in the opposite direction. The more modern dynamos require very little shifting with changes in load. In

connection with series arc dynamos the sparking at the brushes is unavoidable and special appliances are usually provided to take care of it.

Cause 2. Rough commutator, ragged brushes, or dirt on commutator.

Cause 3. Insufficient tension allowing the brush to leave the commutator.

Cause 4. Brush either too narrow or too wide. If too narrow it may leave one commutator section before making proper connection with the next. If too wide, it will short circuit several of the coils and the breaking of this current will manifest itself by sparking.

Cause 5. Brushes not correctly spaced. In two pole machines they should be diametrically opposite each other. Except in some special machines they should always be equally spaced.

Cause 6. Changes in load with some dynamos.

Cause 7. In compound d. c. machines wrong connection of series coils will cause sparking. In compound alternators a wrong setting of the commutator will cause sparking. If the load is inductive and changing, there must be a constant shifting with changes in load to prevent sparking.

Cause 8. Open circuit in armature. If this is the cause of sparking the sparks occur only at one place on the commutator and an inspection should reveal the location of the break. For exhaustive treatise on armature testing and repairing, see "Practical Armature and Magnet Wiring."

HEATING OF ARMATURE

Cause 1. Overload. Compare capacity of machine with load. The heating increases as the square of the current.

If several machines are operating in parallel, one may be running the other as a motor. With compound machines the ammeter may be cut into the same side as the equalizer and the reading may be altogether unreliable.

Cause 2. Short circuit in armature coil. This will speedily show itself by burning out. A strong odor of overheated shellac will be the first indication of trouble.

Cause 3. Defective construction; wires too small; Foucault currents; hysteresis.

Cause 4. Poor ventilation. Some types are arranged so they can be either enclosed or opened at the ends.

INABILITY TO REGULATE VOLTAGE

Cause 1. Speed too low so that even with all resistance cut out of the regulator the resistance of the field circuit is too high to allow sufficient current to flow. Fields must be either rewound or connected in parallel, and a new suitable rheostat provided.

Cause 2. Speed too high so that even with all resistance in circuit the voltage is above that desired. To remedy this additional resistance must be provided unless, of course, the speed can be made correct.

FIELDS RUNNING HOT

Cause 1. Voltage at which machine operates much higher than intended.

Cause 2. Fields connected in parallel where they were intended to be in series.

Cause 3. Part of field cut out either by "ground" or improper connection of wires in coil. If this is the cause, one of the fields will be abnormally hot and the other cool.

SHOCKS OBTAINED FROM TOUCHING MACHINE

This is always due to either static electricity or grounding of some live part of the system on the frame of the machine. Static electricity is caused by the belting and can be remedied by providing arrester, or the shafting may be grounded.

To locate ground separate armature and fields and test for location. After this, the exact location can be found only by inspection and may require unwinding of coils.

SHAFT AND BEARINGS RUNNING HOT

Improper oiling. Box too tight. Rough bearing surface. Bent shaft. Excessive belt tension. End thrust due to improper leveling or armature not being centered and in consequence possessing a tendency to be 'sucked in,' thus pressing heavily on one of the collars.

MOTOR TROUBLES

Fuses blow at starting.

Cause 1. Fuse may be too small, or contacts may be dirty or loose.

Cause 2. Motor may be overloaded, or stuck fast in some way.

Cause 3. Rheostat may be manipulated too fast. As a rule from 20 to 30 seconds should be consumed in the starting of the average motors.

Cause 4. Wrong position of brushes. Brushes should be at diametrically opposite points.

Cause 5. The voltage supply may be higher than the motor is designed for. If alternating the frequency of the supply may be lower than the motor requires. If the frequency is higher, not enough current can be obtained.

Cause 6. There may be a short circuit in the armature or in the field. A short circuit may be caused by two grounds in a two-wire system, or by one ground in three-wire system with grounded neutral.

Cause 7. The motor may be improperly connected.

Cause 8. The field circuit may be open, thus preventing the armature from generating the necessary counter E.M.F.

Cause 9. Light fields, due perhaps to grounded wires or short circuit of part of the coils. This will be indicated by part of the field running hotter than the rest.

FAILURE TO START

Fuses do not blow.

Cause 1. Dead line. Test for current at switch.

Cause 2. Open circuit in armature or fields, if series motor. In armature only if shunt or compound motor.

Cause 3. Poor contact of brushes or insufficient tension.

If alternating, frequency of supply may be too high. Synchronous motors must be started independently of the current.

SPARKING OF BRUSHES

See "Dynamo Troubles."

Sparking of motor commutator is often much more troublesome than with dynamos, because the load changes are more frequent and sudden. Since compound motors are wound with series fields opposing or helping the shunt fields, frequently the sparking may be due to wrong connection of the fields

RACING OF MOTOR

Cause 1. Series motors require constant regulation if connected to variable load. If the load is light, motor will speed up.

Cause 2. Light fields due to improper winding, grounds, short circuit or improper connection will cause any motor to speed up unless heavily loaded. Fields intended to be in parallel may be in series. Part of the field winding may be connected to oppose the rest. The compound coils may be in opposition to the shunt coils. In such a case the speed of motor will increase with increase in load until if overloaded the fields will become so light that finally fuses will blow. Strength of field cannot be altered by adding or removing wire. It must be rewound with larger wire, if field is too light, and with smaller if field is too strong.

MOTOR NOT UP TO SPEED

Cause 1. If series motor, it may be overloaded.

Cause 2. The line supplying current may be so long and the wire so small that with a heavy load the speed of motor falls off considerably. This condition would not affect a motor running light.

Cause 3. Fields may be too strong. Fields intended to be run in series may be in parallel. In such a case they will likely run hot.

FIELDS OR ARMATURE RUNNING HOT

See "Dynamo Troubles."

MOTOR RUNNING IN WRONG DIRECTION

Remedy by reversing connections of fields or armature. If both are reversed, it will have no effect. As long as fields and armature polarity remain in the same relation to each other, the polarity of the supply line is immaterial.

Multipolar motors and also some bi-polars can be reversed by shifting the brushes so that the negative brush takes place of the positive. Three-phase motors are reversed by changing any two of the wires. Two-phase motors are reversed by reversing the wires of one of the phases.

HEATING OF MOTOR

Cause 1. Overload.

Cause 2. Voltage too high.

See, also, "Heating," under Dynamo Troubles.

With induction motors one of the phases may be

out. A three-phase motor will continue to run on one phase, but will not start. If such a motor is overloaded, it will come to rest and burn out.

The above includes all of the common troubles encountered on ordinary motor circuits. Motors are, however, used in so many complicated systems of wiring, as, for instance, in connection with printing presses where multi voltage control is often used and where motors must be reversible and capable of being started or stopped from different places, that the only way for an operator to fit himself to deal with troubles on such systems is to thoroughly acquaint himself with the details of the wiring. He should draw out an accurate diagram of the connections showing the location of every wire and learn exactly what its purpose is and study this diagram patiently, trying out what effect a short circuit at one place or a broken or a misplaced wire at another would have.

By preparing himself in this manner a repairman can do in a few minutes what might otherwise require hours for, and where the loss due to an idle machine is figured at from ten dollars per hour upward, speed in locating trouble is of the utmost value.

CHAPTER XXI

RECORDING WATTMETERS

To obtain a record of the amount of electrical energy consumed on a circuit in a given time, it is necessary that some suitable form of instrument be so connected in the circuit that a continuous record of the amount of energy passing over the circuit is recorded. The chemical meter, a diagram of which is shown in Figure 182, was originally used for this purpose. This meter consists of zinc plates suspended in a conducting solution, so arranged that a part of the total current used on the circuit passes between these plates. At certain intervals the plates were removed and weighed, the amount of metal deposited on one of the plates showing the amount of current used during the interval.

This meter was in reality a current meter, as it did not take into account the variations in voltage on the line except, of course, as these might affect the current. To reduce the reading to watts it was necessary to estimate the average voltage during the period which the meter was in use. Considerable work was entailed in the "reading" of these meters, as it was necessary for the meter man to carry with him enough plates to replace those removed and to carry back to

the laboratory for weighing all the plates removed. This type of meter had other disadvantages among which was the inability of the consumer to check the readings, and the fact that the meter could not be used on alternating currents; and they are now entirely replaced by the mechanical meters.

It was customary when the chemical meter was in use, to show in the monthly statements sent to con-

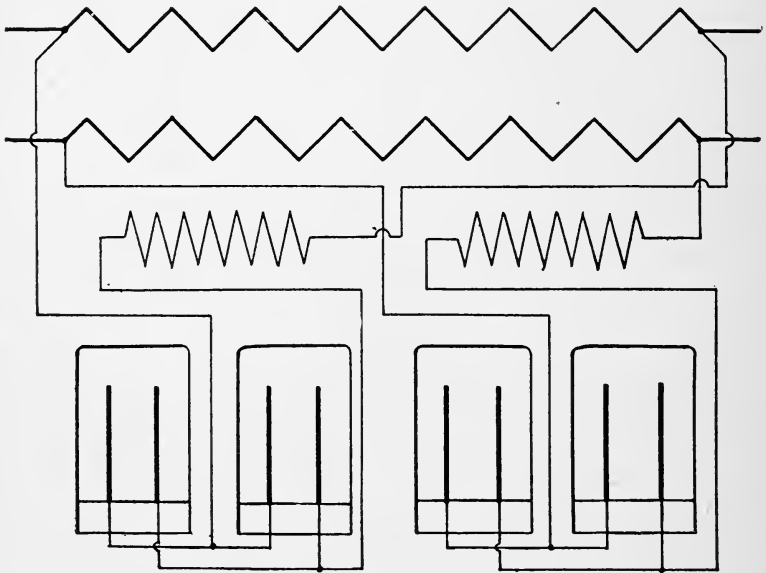

Figure 182

sumers the number of lamp hours or the number of ampere hours used during the period. The first mechanical meters were simply recording ammeters and registered the amount of ampere hours or lamp hours. At the present time the wattmeter is used almost exclusively.

The "watt" is the unit of electrical power and is the basis of all wattmeter readings. A kilowatt or

K. W. is 1,000 watts. An electrical horsepower is equivalent to 746 watts. For approximate calculations, a horsepower is considered as equivalent to 750 watts or $\frac{3}{4}$ of a kilowatt; likewise a kilowatt is equal to $\frac{4}{3}$ of a horsepower. A current of one ampere flowing through a resistance of one ohm will produce one watt, the E.M.F. being in this case, according to Ohm's law, one volt.

$$E^2$$

Expressed in symbols $W = IE$, $W = I^2R$, $W = \frac{E^2}{R}$.

An incandescent lamp taking $\frac{1}{2}$ ampere at 110 volts, takes $\frac{1}{2} \times 110 = 55$ watts. The same lamp, when burning, has a resistance of 220 ohms. The wattage is, therefore, according to the formula, $W = I^2R$, $(\frac{1}{2})^2 \times 220 = 55$ watts.

While the "watt" expresses the rate at which power in an electrical circuit is used, it does not express the amount of work performed. To correctly indicate the actual work done, the length of time during which the power is acting must be taken into consideration. The unit of electrical work is the "watt hour," meaning that one watt is used for one hour.

The distinction between a watt and a watt hour is similar to the distinction between the speed at which a train moves and the distance which it covers. To find the distance covered by the train we must multiply the speed (miles per hour) by the number of or fraction of an hour that the train moves at this speed. In the same way to get the actual power consumed in

a circuit, we must multiply the watts consumed by the length of time.

An incandescent lamp taking 55 watts will, in one hour, require 55 watt-hours of energy. Ten such lamps operated for one hour would require 550 watt-hours; or one such lamp operating for 10 hours would require 550 watt-hours. In a like manner, a horse-

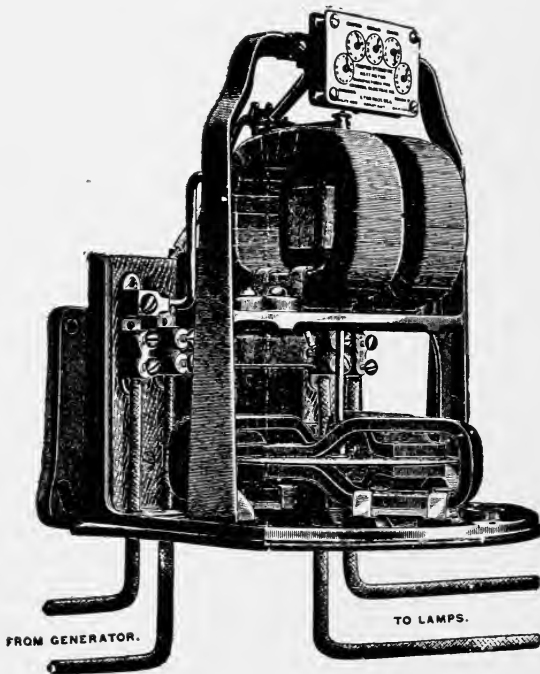

Figure 183

power (746 watts) in use for one hour will require 746 watt-hours. The watt-hour is too small a unit for commercial purposes and the kilowatt hour, or 1,000 watt-hours, is generally used.

While it will be seen that there is a decided difference between the terms "watt" and "watt-hour," still it will be found that the two are frequently used synonymously, kilowatt-hours often being referred to

as kilowatts. The connection in which the term is used will determine the meaning. For instance, a monthly statement referring to so many kilowatts must, obviously, mean kilowatt-hours.

The recording wattmeter, sometimes called integrating wattmeter, owing to the fact that it indicates the total watts used, consists of a small motor operated by the current to be measured. Figure 183 shows a view of the Thompson recording wattmeter and Figure 184 a diagram of the connections. The upright shaft

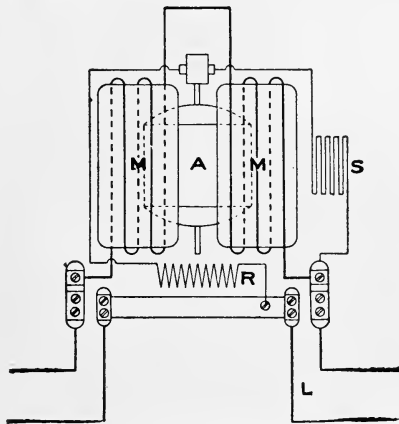

Figure 184

in the center of the meter supports the armature A, Figure 184. To reduce the friction to the smallest possible amount this shaft rests on jewel bearings.

The coils of armature A are composed of fine wire which terminates in a silver commutator. Brushes, lightly bearing on this commutator, convey the necessary current to the armature. The armature, which is connected in series with a non-inductive resistance R, and the auxiliary shunt field S, is connected directly across the mains. The two field coils M M are wound

with a rather heavy wire and connected directly in series with one of the mains. At the lower end of the shaft is a copper disk, shown in Figure 183, which rotates freely between the permanent magnets. A clock-work geared to the upper end of the shaft records the revolutions of the armature. The scheme of connection is plainly shown in Figure 184.

The armature and the shunt field S are always in circuit, but as their resistance is very high the current is small. The tendency to turn, due to the current in the armature, is only affected by the voltage across the mains. If the two field coils were replaced by permanent magnets we would have in reality an instrument which would, with a suitable arrangement of springs and a pointer, serve as a voltmeter and would only be affected by changes in voltage across the mains. The two coils M M, which are connected in series with one of the mains, form the field in which the armature rotates. The greater the strength of this field, the greater the speed of the armature. It will therefore be seen that the effort which revolves the armature is the result of the current in the coils M M and the E.M.F. in the armature, the combination of these two being $I \times E$ or watts.

In order that the speed of the armature may be in exact proportion to the watts used, a copper or aluminum disk attached to the armature shaft is arranged to rotate, without touching, between a pair of permanent magnets. A current is generated in this disk, in a manner similar to that in which current is generated in the armature of a dynamo, and tends to retard the disk. The effect of this retardation is such that the

rate at which the armature revolves is in exact proportion to the wattage used on the circuit.

Although every effort is made to reduce the friction to the smallest extent possible, by providing jewel bearings and by making the armature, shaft and disk of very little weight, still it is impossible to entirely do away with it. Some energy, although a very small amount, is also required to operate the clockwork of the registering mechanism. The shunt field *S*, connected in series with the armature circuit, is so arranged that it tends to start the armature and overcome the friction of the revolving element. The meter will, therefore, register on light loads and register more accurately at all other loads. As the torque exerted by the shunt field is the result of the current in it and that in the armature, it is evident that a change in the voltage across the mains will also affect the starting torque, the variation being proportional to the square of the E.M.F. The shunt field should therefore be adjusted for the voltage of the circuit on which it is to be used.

It will be noted that the connection for the shunt field is made on the load side *L* of the meter. With this connection the meter will register the amount of current used in the armature circuit. On the other hand, if the connection for the shunt field circuit was made on the generator side of the meter it would receive a slightly higher pressure and take into account the loss in the main coils *M M*. The loss in either case is very small.

Meters of the Thompson type may be used with either direct or alternating current circuits as there

is no iron used in their construction and the inductance is therefore small. Where used on alternating current circuits the reversals of the current in both the armature and fields occur at the same time and the meter will continue to revolve in the one direction, for, it is well known, changing the direction of current in a shunt motor does not change the direction of rotation of the armature. If, however, the meter is fed from the wrong side it will run backward. This can readily be understood by referring to Figure 184. As long as the polarity of the supply circuit is not reversed the armature current remains in the same direction but the direction of the current through the fields depends upon from which side the meter is fed.

For the measurement of power on alternating current circuits meters of the induction type possess a number of advantages and are used almost exclusively. These meters are used on alternating current circuits only, the rotation of the revolving element being obtained by the joint action of a set of series coils and a shunt coil inducing current in a metal disk. The reaction of this induced current causes the armature to revolve in much the same way as that of an ordinary induction motor. As the same disk is acted upon by both the coils which produce the rotation and the permanent magnet which retards the rotation the weight and consequently the friction may be kept down to a minimum. The use of a commutator and its brushes are unnecessary as there is no winding on the revolving element.

Figure 185 shows a view of the Guttman wattmeter with the dials and magnets removed. The aluminum

armature which is slotted in spiral lines weighs about $\frac{3}{4}$ of an ounce and rests on a jewel bearing. At the top of the spindle is a worm whereby the motion of the revolving element is transmitted to the recording train. The two series coils, shown directly at the left of the spindle, are mounted on aluminum frames. The

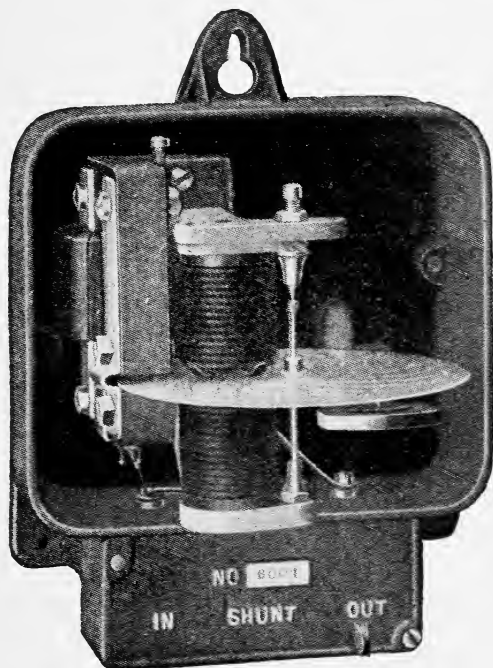

Figure 185

coils are wound with heavy wire and consume from two to four watts, depending on the size of the meter.

The shunt coil of the meter is wound upon a laminated iron core having two air gaps, through one of which the disk rotates. On the lower part of this laminated core a heavy band of copper partially surrounds the iron laminations. An adjustable piece of

wire is connected to the two ends of the copper band and completes an electrical circuit.

In order that the meter may register accurately on inductive loads it is necessary that the current in the shunt field lag behind that of the series field by an angle of 90° . This will be clearly understood by considering the conditions which would exist were the two currents in exact phase. If such was the case the instrument would become a recording volt-ampere meter and would take into account only the amperes as they would be indicated by an ammeter. On an inductive load the product of the volts and amperes does not represent the wattage and to obtain the true value of the watts the power factor must be considered.

The greatest torque or turning moment must be exerted on the revolving element of the meter when the load is non-inductive, for then the power factor is 1 and the product of the volts and amperes represents the true power. On the other hand the least torque should be in effect when the load is all inductive or when the power factor is 0, for then there is no true energy represented.

In order that the current in the shunt coil may lag 90° behind the impressed E.M.F. this coil is wound on the iron core to give this circuit the greatest possible inductance, but as this inductance alone cannot produce a difference of phase of 90° other means must be resorted to. This is accomplished by means of the copper band referred to above, which, forming a closed circuit around this iron core, has a current induced in it, and this current reacting upon the field produced by the shunt coil gives the effect desired.

INSTALLATION OF METERS

The manner in which a meter is connected into the circuit depends upon the wiring system, and the current and voltage used. Although the structural features of the various makes of meters differ the general scheme of connecting them into the circuit is similar.

Figure 184 shows the Thompson meter as used on a two-wire circuit. Both mains are carried to the meter, one of them being connected to the series coil and the

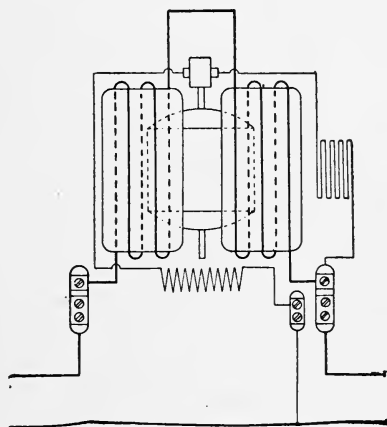

Figure 186

other passing through the meter by the bus bar connection. The shunt armature circuit is, however, connected to this bar.

With large mains only one wire is carried through the meter, this being connected to the series coils. A tap taken off the other main connects to the shunt coil as shown in Figure 186. As this shunt tap carries only current for the shunt field of the meter it may be of small wire, generally No. 14 B. & S. gauge.

When a meter is connected in a three-wire circuit

both outside mains are carried through the meter, one through each of the series coils. The shunt field is connected by means of a wire tap to the neutral main. The Thompson three-wire meter is shown in Figure 187. In some types of three-wire meters no neutral tap is used, the shunt circuit being connected directly across the outside mains. This connection has an advantage in that it does away with the running of one wire to the meter and, as the shunt field connection is

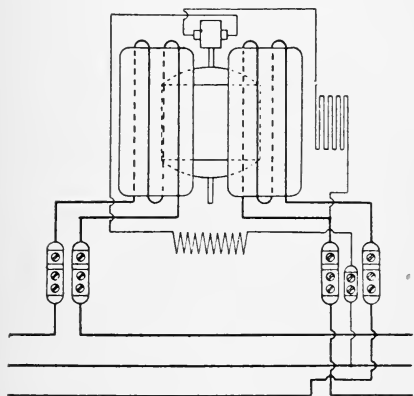

Figure 187

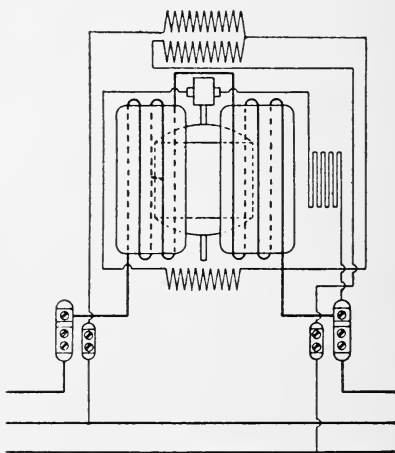

Figure 188

inaccessible the possibility of tampering with the meter is reduced. It has, however, the disadvantage in that an added resistance must be placed in series with the shunt field when used on direct current circuits with the consequent increase in the power consumed by the meter.

Figure 188 shows the connections for a meter on a balanced three phase circuit. One main is carried through the series coil of the meter and two taps from the other two main wires are carried to a common con-

nection through an inductive resistance and connect to the shunt field circuit.

On alternating current circuits of large capacity it is not advisable, for several reasons, to carry the

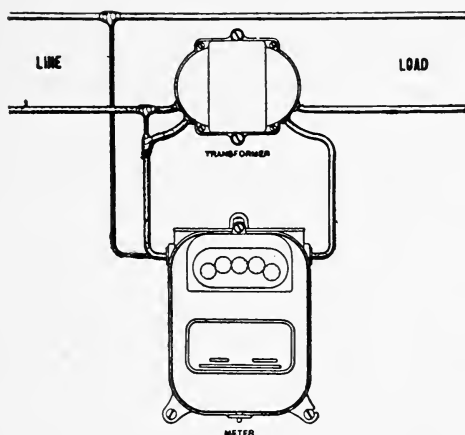

Figure 189

mains through the meter. A small current transformer is connected in series with one of the mains, the secondary of the transformer being connected to

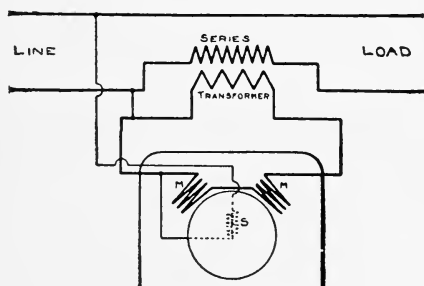

Figure 190

the meter as shown in Figures 189 and 190. If the meter is used on a primary circuit or on any circuit where the voltage is high a small potential transformer may be connected across the mains and the shunt field con

nected directly to the secondary as shown in Figures 191 and 192. Various other combinations of both current and potential transformers are made use of; as, for instance, on a three-wire circuit of large capacity. In this case two current transformers are used, one on each main, the secondaries being connected to the series coils of the meter.

Detailed instructions are generally sent out for the installation of individual meters but there are a few

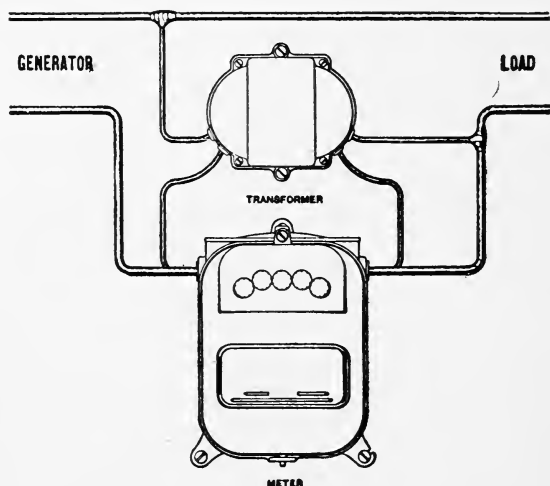

Figure 191

general directions which apply to all. A meter is a somewhat delicate instrument and, although built to withstand ordinary usage, efficient operation demands careful and intelligent handling. As has been stated, the revolving element of recording wattmeters rests on jewel bearings. A slight jar is often all that is necessary to injure or break the jewel. For this reason some means is always provided to remove the revolving element from contact with the jewel when the

meter is to be carried about or during transportation, and the moving element should never be placed in contact with the jewel until the meter is ready to be started.

When a meter is unpacked it should be carefully cleaned and examined. Some care should be exercised in the choice of location for setting the meter. To obtain the most efficient operation it should not be placed where it will be subject to any vibration, neither should it be placed in an extremely hot or cold place or where subject to great extremes of temperature.

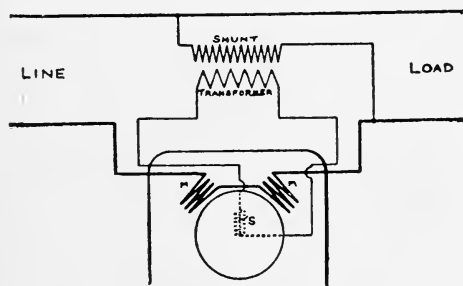

Figure 192

Locations where dust, moisture, or inflammable or corrosive vapors are present should also be avoided.

The meter should be installed in a readily accessible location and should be fastened to a solid upright support. A hole for a supporting screw is generally provided at the top of the meter and a screw (never use a nail) should be inserted at this point first. The meter should then be leveled. A small spirit level may be used for this purpose or, where the meter has a disk, a small weight of some non-magnetic substance such as brass may be placed near the outer

edge of the disk. If the meter is not level the weight and disk will revolve to the lowest point.

Place the weight on the front or back upper surface of the disk. If the disk rotates to the right or left that part of the meter toward which it rotates is low and the bottom of the meter should be moved in that direction. When the meter is level from right to left the disk and weight will not move when the weight is placed at the center of the disk at the front or back.

Now place the weight on either side of the disk and note if the disk rotates to the front or back. If to the rear the back part of the meter is too low and the meter should be moved out at the top. If the disk rotates to the front that part of the meter is too low and should be moved out at the bottom. When a perfectly level position has been obtained the weight will not move if placed on any part of the disk. It is well to check back after the last leveling as the first position may have been altered. All the screws should now be set up.

The wires may now be connected to the meter, being careful to follow the wiring scheme applying to the particular meter. The wires should be thoroughly cleaned and the binding posts tightly set up to avoid any heating at these points. Now place the revolving element on its jewel if this has not already been done and turn on the current and note if the meter revolves in the proper direction. The meter case may now be placed on the frame, paying special attention to see that the case closely fits into place and no opening is left at the edges.

TESTING

A recording wattmeter is so designed that with a given wattage passing through the meter a definite number of revolutions of the armature will result. For instance, on a certain type of meter it takes 18 seconds to complete one revolution of the armature on 100 watts, or 1800 seconds for one revolution on 1 watt. This is the equivalent of $1/1800$ of one revolution for one second on one watt. On this type of meter the armature would require 1800 seconds to make one revolution while only one watt is passing through the meter and this is taken as the testing constant of the meter. To determine the wattage at any load multi-

revolutions

ply the revolutions per second, or $\frac{\text{revolutions}}{\text{seconds}}$, by the

constant. As an example: Suppose the meter made

one revolution in one second, $\frac{1}{1} \times 1800 = 1800$ watts

passing through the meter.

In order that the same type of meter may be used on circuits of different voltages it is customary to introduce a resistance in series with the shunt circuit; so that no matter what voltage may be used on the meter the armature circuit will always have impressed upon it the same voltage. The number of revolutions of the armature will then be the same even though the voltage on the meter and correspondingly the wattage, has been increased. To make this meter indicate cor-

rectly the train gear is altered to indicate correct readings. For instance, with a certain meter designed for use on a 110 volt circuit it requires 2000 revolutions of the armature to register 1000 watts. If the same meter was used on a 220 volt circuit, with a resistance in series with the shunt circuit so that the shunt circuit would only receive 110 volts, the true wattage would be registered by arranging the gearing so that one revolution of the armature would produce twice the movement of the pointer on the dial. The testing constant would also be doubled.

As meters of large capacity require a larger wire for the winding of the series coils, and as it is not advisable to run the meter at too high a speed, the field due to the series winding is cut down and fewer revolutions of the armature will result with a given load. In this case the train ratio and the testing constant are increased.

Below are given the testing formulas for calibrating recording wattmeters.

FORT WAYNE

$$\frac{\text{Rev.} \times 100 \times \text{Constant}}{\text{Seconds}} = \text{Watts}$$

See Instruction Book for Constants.

WESTINGHOUSE

$$\frac{\text{Rev.} \times \text{Constant}}{\text{Seconds}} = \text{Watts}$$

Constant = $1.2 \times (\text{Amp.} \times \text{Volts as marked on dial})$.

On types B and C, Constant = $2.4 \times \text{Amp.} \times \text{Volts as marked on dial}$.

GENERAL ELECTRIC, DUNCAN AND SCHEEFER

$$\frac{\text{Rev.} \times 3600 \times \text{Constant}}{\text{Seconds}} = \text{Watts}$$

G. E. Non-Direct Reading, Constant on dial.

G. E. Direct Reading, Constant found on disk.

Duncan, Constant on dial. (Fort Wayne Induction type.)

Duncan, Constant on disk (Direct current and S. & H. Induction type).

Scheefer Non-Direct Reading, Constant on dial.

STANLEY

$$\frac{\text{Rev.} \times 100 \times \text{Constant}}{\text{Seconds}} = \text{Watts}$$

Constant = Seconds required for meter to make revolution on 100 watts.

Constant stamped on case.

GUTTMAN

$$\frac{\text{Rev.} \times \text{Constant}}{\text{Seconds}} = \text{Watts}$$

3600

$$\text{Constant} = \frac{\text{Train ratio as found on meter}}{\text{---}}$$

SANGAMO

$$\frac{\text{Rev.} \times \text{Constant}}{\text{Seconds}} = \text{Watts}$$

Constant found on back of meter.

Any of these formulas may be rearranged for convenience in testing.

$$(1) \quad \text{Watts} = \frac{\text{Revolutions} \times \text{Constant}}{\text{Seconds}}$$

$$(2) \quad \text{Revolutions} = \frac{\text{Watts} \times \text{Seconds}}{\text{Constant}}$$

$$(3) \quad \text{Seconds} = \frac{\text{Revolutions} \times \text{Constant}}{\text{Watts}}$$

$$(4) \quad \text{Constant} = \frac{\text{Watts} \times \text{Seconds}}{\text{Revolutions}}$$

$$\text{Error} = \frac{\text{Observed secs.} - \text{Secs.}}{\text{Secs.}}$$

The testing of a wattmeter can be accomplished in several ways, the choice of method depending on the

accuracy desired and the apparatus at hand. One of the simplest methods is that of turning on a number of 16 candlepower lamps and then counting the number of revolutions of the meter disk in a given time. The load is estimated and the meter checked up by using the formula of the type of meter under test. As an example: Suppose ten 16 candlepower lamps, taking 50 watts each, are turned on. The time required for one revolution according to formula (3) would be

$$\text{Seconds} = \frac{1 \times 1800}{500} = 3.6 \text{ seconds.}$$

If the meter made

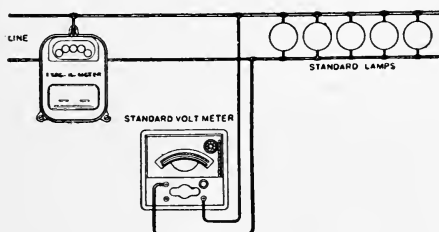

Diagram No. 1

Figure 193

exactly ten revolutions in 36 seconds it would be registering correctly. At best this method is only approximate as the wattage of the lamps must be estimated and this will vary considerably with different makes of lamps and lamps of different ages.

To make this test more accurate a number of lamps may be prepared by ascertaining the watts consumed by each at several different voltages such as will be met with on the tests. These voltages and the corresponding wattages should be marked on labels on the lamps. When a meter test is made a reading should

be taken of the voltage with a portable voltmeter and the exact load can then be determined. See Figure 193.

A regular service meter accurately calibrated in the shop or laboratory may be used in checking up other meters by connecting it in circuit as shown in Figure 194. With the connection shown the voltage impressed on the shunt coils of the two meters is equalized and the inaccuracy which would result were the meters connected side by side, where the shunt coil of one meter would be subjected to the reduced voltage caused

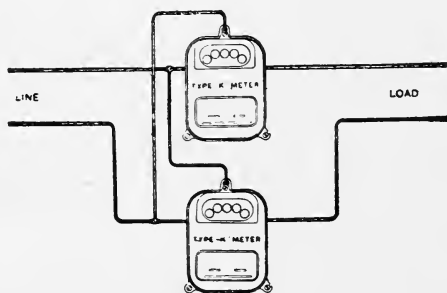

Diagram No. 2

Figure 194

by the drop in the series field of the other meter, is avoided. If the two meters are of the same type and capacity the two revolving elements will rotate in unison when the meter being tested is correct. If the meters are of different capacity this must be taken into account.

The most accurate test and the one more generally used is shown in Figure 195. Figure 195 shows corrections for a standard wattmeter. The wattmeter is sometimes replaced by a voltmeter and ammeter. On direct current circuits either method may be used, but the wattmeter is more convenient and accurate. For

alternating currents the reading obtained by multiplying together the amperes and volts does not represent the true wattage of the circuit unless the load is non-inductive. For inductive loads a wattmeter must be used, but it is well to take both the wattmeter and the volt-ampere readings so that the power-factor may be known.

Figure 196 shows connections for testing a three wire meter using one standard wattmeter. The load must first be balanced and the neutral fuse then opened.

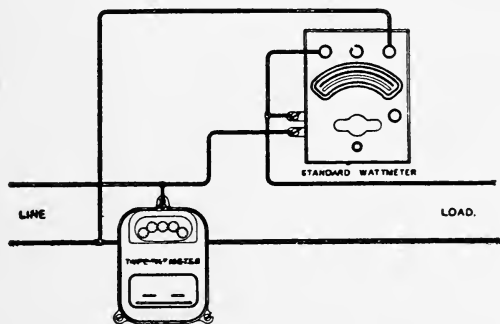

Figure 195

This method is objectionable where the shunt coil of the meter under test is connected directly across the mains as the shunt coil of the standard wattmeter is subject to the variation in voltage between the neutral and the outside wires. To overcome this objection a multiplier may be used in series with the shunt coil of the standard meter and connection can then be made directly across the outside mains. If the shunt circuit of the meter under test is connected between one of the outside mains and the neutral wire a test may be made by using one standard wattmeter and connecting

up only one series coil of the meter under test at a time, or both series coils may be connected in series.

The most accurate method of testing three-wire meters is by use of two standard wattmeters con-

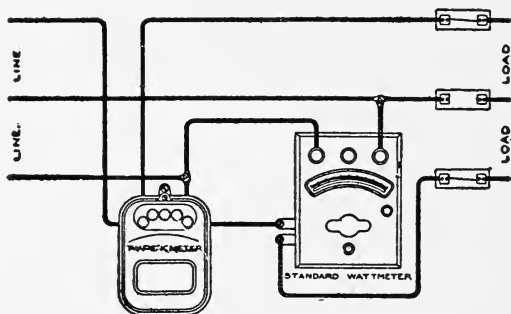

Figure 196

nected as shown in Figure 197. The sum of the standard meter readings should equal the reading of the meter being tested. In this case it is not necessary to balance the load.

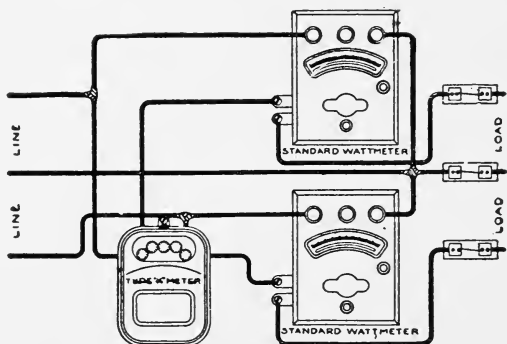

Figure 197

It is of great importance for accurate testing that a good stop watch be employed, although for approximate tests the second hand of the ordinary watch serves the purpose quite well. The longer the time of the test, using the latter method, the less the error.

When the apparatus is set up ready for the test, a small load, about 10 per cent of the full load capacity of the meter, is turned on. The number of revolutions made by the revolving element and the time over which the count is made are noted. By means of formula 1 the watts as indicated by the meter under test are compared with the wattage of the standard meter. The per cent of standard watts will be

$$\frac{\text{Meter watts} \times 100}{\text{Standard watts}}$$

Example: Suppose the revolving element made 13 revolutions in 90 seconds, the testing constant of the meter being 1800. Watts =

13 \times 1800

$$\frac{13 \times 1800}{90} = 260 \text{ watts.}$$

If the standard meter indicated 250 watts the percentage of standard watts

would be

$$\frac{260 \times 100}{250} = 104 \text{ per cent, or 4 per cent fast.}$$

fast.

A method frequently used, and one by which the percentage error may be taken direct from a previously prepared table, is as follows: Ascertain the watts of the connected load from the reading of the standard wattmeter. From the following formula determine the number of revolutions the meter under test should

$$\text{make in one minute. } \frac{\text{Watts of load} \times 60}{\text{Testing constant of meter}} =$$

Revolutions per minute. Now note the number of seconds required by the meter under test to complete this number of revolutions. If the number of revolutions are completed in exactly 60 seconds, the meter is correct; if not, the meter is fast or slow. Example: On a load of 150 watts it is found that exactly 5 revolutions are completed in one minute or 60 seconds. Testing constant of meter is 1800. According to formula 2

$$150 \times 60$$

Revolutions = $\frac{\quad}{1800} = 5$. If this meter had com-

pleted 5 revolutions in 55 seconds it would be $\frac{60 \times 100}{55}$

= 109.09 per cent, or 9.09 per cent fast. If five revolutions had been completed in 67.8 seconds, it would

be $\frac{60 \times 100}{67.8} = 88.5$ per cent, or 11.5 per cent slow.

The following table gives the per cent of error for time in fifths of a second.

PER CENT ERROR TABLE FOR FIFTHS OF A SECOND.

Time in Seconds	Per Cent Fast	Time in Seconds	Per Cent Fast	Time in Seconds	Per Cent Slow	Time in Seconds	Per Cent Slow
40.20	49.25	50.20	19.52	60.20	0.33	70.20	14.52
.40	48.51	.40	19.05	.40	0.67	.40	14.77
.60	47.78	.60	18.58	.60	0.99	.60	15.01
.80	47.06	.80	18.11	.80	1.31	.80	15.25
41.00	46.34	51.00	17.65	61.00	1.63	71.00	15.50
.20	45.63	.20	17.19	.20	1.96	.20	15.73
.40	44.93	.40	16.73	.40	2.27	.40	15.96
.60	44.23	.60	16.28	.60	2.59	.60	16.20
.80	43.54	.80	15.83	.80	2.91	.80	16.43
42.00	42.86	52.00	15.38	62.00	3.22	72.00	16.66
.20	42.18	.20	14.94	.20	3.53	.20	16.89
.40	41.51	.40	14.50	.40	3.84	.40	17.12
.60	40.85	.60	14.07	.60	4.15	.60	17.35
.80	40.19	.80	13.64	.80	4.45	.80	17.58
43.00	39.53	53.00	13.21	63.00	4.76	73.00	17.81
.20	38.89	.20	12.78	.20	5.06	.20	18.03
.40	38.25	.40	12.36	.40	5.36	.40	18.25
.60	37.61	.60	11.94	.60	5.66	.60	18.47
.80	36.98	.80	11.52	.80	5.95	.80	18.70
44.00	36.36	54.00	11.11	64.00	6.25	74.00	18.92
.20	35.75	.20	10.70	.20	6.54	.20	19.14
.40	35.14	.40	10.29	.40	6.83	.40	19.35
.60	34.53	.60	9.89	.60	7.12	.60	19.57
.80	33.93	.80	9.49	.80	7.40	.80	19.79
45.00	33.33	55.00	9.09	65.00	7.69	75.00	20.00
.20	32.74	.20	8.69	.20	7.97	.20	20.21
.40	32.16	.40	8.30	.40	8.25	.40	20.42
.60	31.58	.60	7.91	.60	8.53	.60	20.63
.80	31.00	.80	7.53	.80	8.81	.80	20.84
46.00	30.43	56.00	7.14	66.00	9.09	76.00	21.05
.20	29.87	.20	6.76	.20	9.36	.20	21.26
.40	29.31	.40	6.38	.40	9.63	.40	21.47
.60	28.76	.60	6.01	.60	9.90	.60	21.68
.80	28.21	.80	5.63	.80	10.17	.80	21.88
47.00	27.66	57.00	5.26	67.00	10.44	77.00	22.08
.20	27.12	.20	4.89	.20	10.71	.20	22.28
.40	26.58	.40	4.53	.40	10.97	.40	22.38
.60	26.05	.60	4.17	.60	11.24	.60	22.68
.80	25.52	.80	3.81	.80	11.50	.80	22.88
48.00	25.00	58.00	3.45	68.00	11.76	78.00	23.08
.20	24.40	.20	3.09	.20	12.02	.20	23.28
.40	23.96	.40	2.74	.40	12.28	.40	23.47
.60	23.45	.60	2.39	.60	12.53	.60	23.66
.80	23.15	.80	2.04	.80	12.79	.80	23.86
49.00	22.45	59.00	1.69	69.00	13.04	79.00	24.05
.20	21.95	.20	1.35	.20	13.29	.20	24.24
.40	21.46	.40	1.01	.40	13.54	.40	24.43
.60	20.97	.60	0.67	.60	13.79	.60	24.63
.80	20.48	.80	0.33	.80	14.04	.80	24.82
50.00	20.00	60.00	0.00	70.00	14.28	80.00	25.00

The per cent of full load on which tests should be made will vary with the class of work on which the meter is used. Where the load connected to the meter is such that it will be used uniformly over the range of

the meter tests should be made at 10 per cent, 20 per cent, 30 per cent, etc., (10 per cent intervals) over the full range of the meter. On the other hand, if the load is such that only the full load connected to the meter is used, such as on an electric sign, more tests should be made at the full load capacity. On the ordinary residence load a test at 4 per cent and 100 per cent of full load will generally suffice.

Meters carrying large loads should be tested every 30 days. If the meter is placed where there is much jarring it will tend to run fast.

All meters have a tendency to gain in speed because of the gradual weakening of the controlling magnets.

Commutator troubles are the greatest source of inaccuracies of meters. Some operators insert small fuses in armature circuit. This is especially useful when there is danger from lightning.

READING OF METERS

As has been previously stated, the basis of all recording wattmeter readings is the kilo-watt hour, the equivalent of one kilowatt used for one hour. It is not necessary that exactly a kilowatt of current be used, or that the current be used for the exact period of one hour, but that the product of the watts and the hours shall equal 1000 watt-hours. For instance: A 16 candlepower lamp taking 50 watts and burning for 20 hours represents one kilo-watt hour. Twenty of these 50 watt lamps burning for a period of one hour also represent one kilo-watt hour.

Meter readings are indicated by the positions of pointers which move over a number of dials as shown

in Figure 198, the difference between any two readings representing the amount of power used during the interval between these readings. The pointers shown on the dials in Figure 198 are so connected by means of clockwork that a total revolution of any pointer represents $1/10$ th of a revolution of the pointer to the left of it. It will also be noted that each dial reads in opposite directions to the one next to it.

At the top of the individual dials the value of the reading of that dial is shown. Where the figures given are followed by the letter "s" it signifies that each division of the dial represents the amount of current indicated by the figure at the top. For instance, in Figure 200 each division of the dial at the right represents $1/10$ th of one kilowatt and a total revolution of the dial $10/10$ ths or 1 kilowatt. In a like manner, each division of the second dial from the right represents 1 kilowatt and a total revolution of the pointer on this dial, 10 kilowatts.

If the figure given at the top of the dial is not followed by the letter "s", or as shown in Figure 199, each division of the dial represents $1/10$ th of the amount shown at the top of the dial, the dial at the right of Figure 199 indicating $9/10$ ths of 10 kilowatts or 9 kilowatts.

The reading of a meter should always be from right (lowest dial) to left, each reading of the dial at the left being used as a check on the reading of the dial at the right. The following examples will make clear the manner of reading meters:

In Figure 198 the right hand pointer registers $9/10$ ths of 1000 watt hours or 900 watt hours; the

pointer next to it registers 8 (it cannot have passed the figure 9 as the pointer on the dial at the left of it has not made a complete revolution); the middle dial

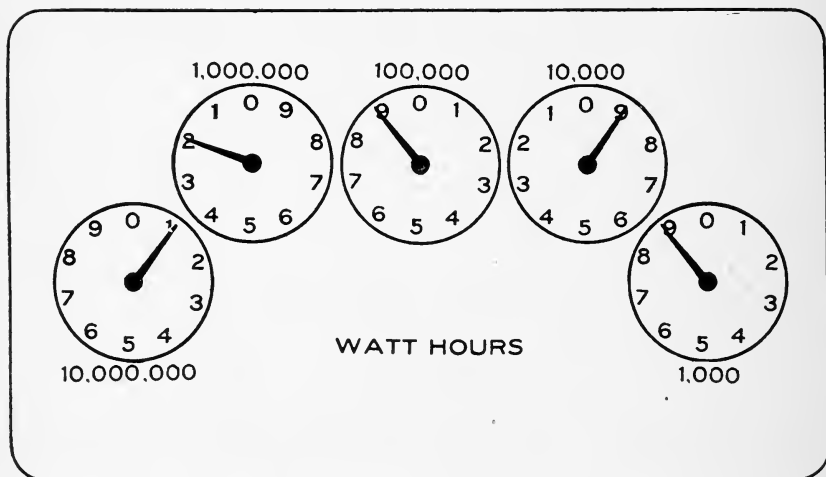

Figure 198

also registers 8; as the middle pointer has not passed the 0, the 4th dial must be read 1; the last dial also

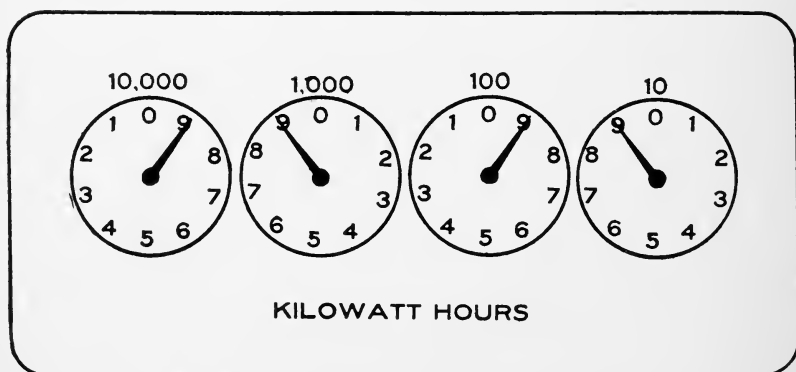

Figure 199

indicates 1, making the total reading 1,188,900 watt hours.

In Figure 199 the readings on the meter dial are

shown in kilowatt hours. The first pointer at the right reads 9; as this pointer has not passed the 0 mark, the dial to the left must be read 8; each of the remaining

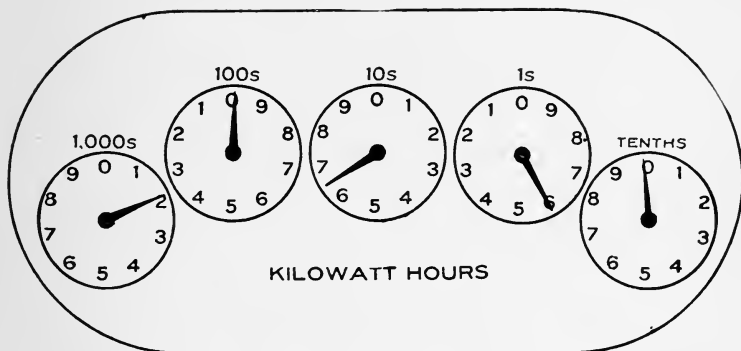

Figure 200

dials also reads 8, the total reading being 8889 kilowatt hours.

In Figure 200 the readings are also given in kilowatt hours. The pointer on the first dial at the right

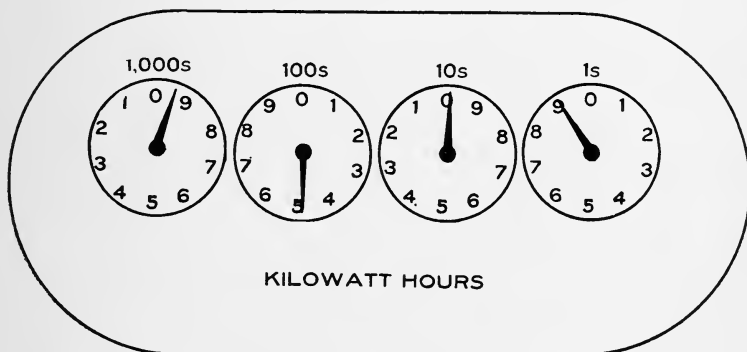

Figure 201

has not passed the 0 mark so this dial must be read 9/10ths of a kilowatt hour or .9; the second dial reads 5; the middle dial 6; the fourth dial 9 and the last dial 1, making the total reading 1965.9 kilowatt hours.

In Figure 201 the dial at the right indicates 9 kilo-

watt hours; the second dial 9; the third 4, and the fourth 9, making a total reading of 9499 kilowatt hours.

On some types of meters a multiplier is used. This is generally given on the meter dial and the readings as indicated by the pointers should be multiplied by this number to obtain the correct reading of the meter.

DISCOUNT METER

Figure 202 shows a diagram of what is known as the Wright discount or demand meter. This meter is

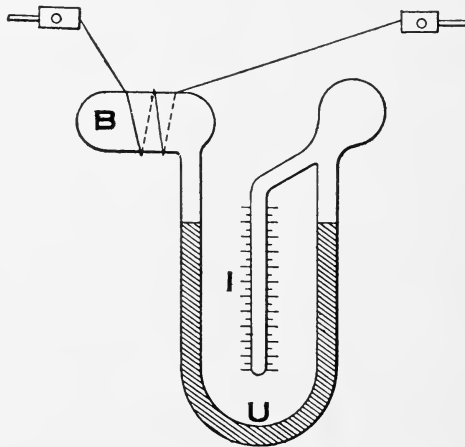
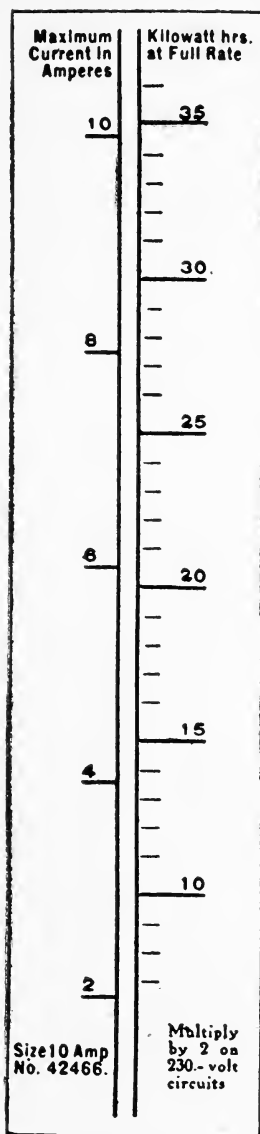

Figure 202

used on circuits where it is desired to know the maximum current which has passed through the circuit. In the diagram, B is a glass bulb connected to a tube U which is partly filled with a liquid. Around bulb B is wound a resistance wire which carries the main current. When current flows in this wire heat is generated and the air in the bulb is expanded, thus forcing the liquid around tube U until it reaches the point where tube U and I join, when it will flow into



SCALE OF DISCOUNT METER

Figure 203

tube I. The amount of liquid in tube I will depend upon the maximum current which has passed through the resistance wire on bulb B. The meter is not af-

ected by momentary increases in current. If the maximum current lasts five minutes, 80 per cent will register; ten minutes, 95 per cent will register; thirty minutes, 100 per cent will register. Figure 203 shows the scale of this meter. The left-hand scale shows the maximum current used in amperes and the right-hand scale the kilowatt hours for which the customer must pay full rate.

As a discount meter, this meter is connected in series with one of the mains connecting to the ordinary recording wattmeter. On three-wire circuits a discount meter must be connected in each main, this requiring two meters. As the scale is computed for 115 volt circuits, when the meter is used on a 230 volt circuit the reading must be doubled, as indicated at the bottom of the scale.

The recording wattmeter registers the total consumption of energy and the discount meter the proportion of it to be charged at full rate. The excess of the recording wattmeter reading over the discount meter reading is subject to the lower rates as specified by the lighting company. In case the wattmeter reading is less than the discount meter reading only the consumption as shown by the recording wattmeter is charged at the full rate.

The discount meter shows the full rate portion of the bill for one month of 30 days. When computing a bill for a greater or less time the reading should be proportioned according to the time. After each monthly reading the meter is opened and the tube tipped up until all the liquid flows out. If there is current in the meter, the liquid will flow back again

when the tube is turned down ; otherwise the tube will remain empty until current is used.

The purpose for which this discount meter is used is to obtain a more equitable basis for the charge for current. As practically all users of current, for lighting for instance, use the maximum amount of current at the same time, the cost to the lighting companies of both the generation of this current and transmission of it to the consumer is a maximum at this time. They must have sufficient generating apparatus and transmission lines to supply the demand and the line losses at this time are considerably greater. This extra equipment must be maintained for the short interval during which this extra demand is made, or at the peak of the load.

It is assumed that a consumer will use the maximum amount of current for one hour each day during the thirty days of the month, and the kilowatt hours to be paid for at full rate are computed on this basis. Suppose a current of ten amperes was indicated by the maximum meter as the greatest amount of current used during the month. Ten amperes at 115 volts amounts to 1150 watts, and this amount used for one hour a day for 30 days represents $30 \times 1150 = 34,500$ watt-hours or 34.5 kilowatt-hours as the amount of current to be paid for at the full rate. An examination of the meter scale as shown in Figure 22 will show that a current of ten amperes is equivalent to 34.5 kilowatt-hours at the full rate.

CHAPTER XXII

LIFE AND FIRE HAZARD

Electricity may endanger life or seriously maim in two ways: By direct contact, causing severe shock and often instant death, and by burning through the medium of a flash or arc which may also prove destructive to the eyesight.

A shock may be obtained by touching wires of opposite polarity; by touching one wire and making connection to the ground, the other wire being grounded, or by cutting one's self into the circuit.

It is perfectly safe to touch any one bare wire provided one is perfectly insulated from the ground, and even if one is not insulated, if the wires are clear from the ground no harm will be done, but under no circumstances should one ever trust a system of wiring, a ground may come on at any moment and cause instant death. The general rule for handling live wires of high potential is, to use only one hand at a time and keep well insulated from the ground and from wires of opposite polarity.

While working on dead lines that are connected with stations over which the workman has no control and which may be connected up by mistake at any moment, it is a good plan to short circuit those wires and ground them. If now the station attendant should

throw in switches no harm would be done except to his fuses

Whenever it is necessary to cut wires carrying current, they should be merely cut into a little with the pliers (to cut clear through will burn the pliers) and then the wire may be broken, but under no circumstances should one bridge the cut with arms or hands. The breaking of the circuit will produce an enormous voltage for an instant which may be amply sufficient to cause death to any one holding the ends of a broken wire. If a high potential circuit is to be broken in this way it is best to work the wire in two with a stick.

The severity of a shock obtained from a circuit will depend upon the voltage of the circuit, the degree of contact the person makes with the wires, the condition of the body where it touches, whether moist or dry, and the quality of the ground which may be helping to make the circuit through the body. Thus it is by no means always safe to touch a live wire of 200 volts nor always fatal to receive a shock from 2000 volts.

Many people have been killed by the lower voltage and many have escaped unharmed from shocks obtained from the higher pressure.

The greatest danger to the eyesight and from burns is encountered while fusing up or throwing in switches on circuits carrying heavy currents. Many switches are built so that the handle is directly above the fuses. In case such a switch is thrown in while there is a short circuit on the line the operator's hands are likely to be burned very badly. It is best to cover the fuses with asbestos or to procure a stick with which the switch may be pushed in.

Where circuits are controlled by circuit breakers there should always be a switch which must be open until the breaker is set so that the hand may not interfere if the breaker should start to go out at once because of overload or short circuit.

To install fuses in a live circuit which cannot be disconnected by switches is always a matter attended with some risk. As a rule the nature of the "blow"

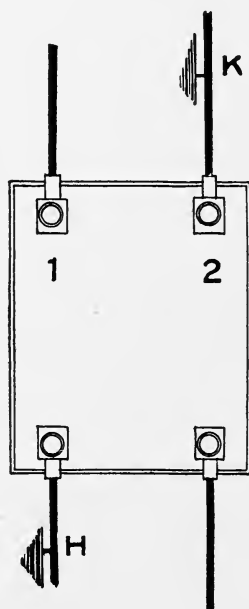

Figure 204

will give some idea as to whether it was caused by an overload or a short circuit. The current due to a short circuit will generally be many times greater than that of an overload owing to the fact that it requires some time for the fuse to heat. If there is indication that there is a short circuit, tests had better be made before attempting to install the proper fuses. A circuit supplying a large number of lights cannot be tested for

“short” in the ordinary manner because the lights establish a circuit of low resistance. If both fuses are out, the best way to test it is, by connecting a small fuse into the circuit, trying one side of the fuse block at a time. If there should happen to be two grounds, as at H and K, Figure 204, a fuse installed at 1 will not blow, but placed in 2 it will. If each side singly holds a small fuse without blowing, a fuse of the proper size may be safely installed on one side. When this is done a piece of wire of suitable size may be fastened to one of the terminals on the opposite side and this wire used to bridge the other fuse gap. The wire should be of such a length that the workman need not endanger his eyes or hands while making connection. If the fuses in question are very large the first fuse may be covered with asbestos. If the first fuse does not blow when the circuit is completed with the wire (known as a “jumper”) the second may be installed, leaving the wire to carry the current until the fuse is in place.

The fire hazard of electric wiring consists in the possibility of overheating wires when carrying too much current; where circuits are broken an arc is always established which may communicate fire; where wires come in contact with wood moisture may cause a ground along which current may flow, eventually charring the wood and starting a fire; wires may come in contact with gas pipes and gradually, by making intermittent contact, eat holes into the pipe, allowing gas to escape which finally is fired by the spark.

Lamps and motors may also become so much over-

heated as to communicate fire to combustible material. Many fires are also caused by small sparks as from switches and sockets setting fire to gases or lint in factories.

An incandescent lamp ordinarily does not become very hot but when covered over with paper or cloth or when subject to an abnormal voltage it may easily cause fires. Many of them have done so.

CHAPTER XXIII

GROUND DETECTORS AND LIGHTNING ARRESTERS

As a rule all systems of wiring should be kept free from grounds. The exceptions to this rule are three-wire systems of such magnitude that it becomes practically impossible to do so, and in such cases the neutral wire is permanently grounded.

In some cases it may be advisable to install ground detectors that give continuous indications, but as such indicators introduce a permanent ground which under favorable circumstances becomes an aid in breaking down the insulation of the opposite polarity from the one to which it is attached, this is not generally desirable.

Either of the lamp systems of ground detectors here described can be made continuously indicating by permanently closing the switch which connects the lamps to ground and voltmeters may be used in place of the lamps.

Figure 205 is the simplest and cheapest of all ground detectors. Only two lamps and a push button are required. As long as the lamps are not connected to the ground, they burn in series at about half candlepower. If the switch is kept closed and a ground occurs on one side of the system, the lamp on that side

burns dull and the other becomes brighter. If the ground is very "good," the lamp on the side of the ground will be entirely extinguished and the other will be at full candlepower.

Figure 206 shows method of using voltmeter as

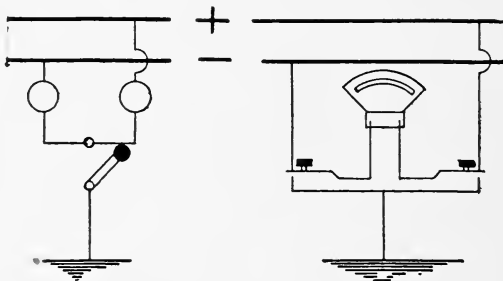

Figure 205

Figure 206

ground detector. The lamps shown above are not very sensitive and will not indicate a slight ground. Hence the voltmeter is preferable. As long as both buttons are in their normal position, the voltmeter measures the voltage of the system. By pressing down either

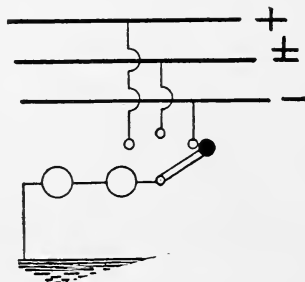

Figure 207

button, if a deflection is obtained, it indicates a ground on that side of the system to which the button belongs.

Figure 207 shows ground detector connections using lamps for an ordinary three-wire or three-phase system. Used in connection with the ordinary three-wire

system, no indication will be obtained while the switch is connected to the leg that is grounded. If one leg is grounded the lamps will be either at full or half candlepower, depending upon which leg the switch is placed.

With three-phase systems, also, no indication will be obtained as long as the switch is connected to the grounded leg. When it is connected to the other legs the lamps will burn bright.

Another ground detector for three-phase systems is shown in Figure 208.

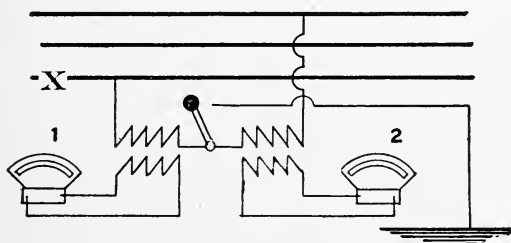

Figure 208

With this connection as long as the line is clear the two voltmeters show even pressure. With a ground coming on one side, say at X, voltmeter 1 will read lower and 2 higher; with a ground on the opposite side 2 will read low and 1 high. With a ground on the middle wire, both will read higher.

Ground detectors like the above are reliable only if one side of the system is clear. The ground on any side acts as a shunt to the lamp on that side and if such shunts exist on both sides, it is clear that the indications will be confusing. Tests should, therefore, be frequently made so as to be reasonably sure that a ground will be detected as soon as it comes on.

If a system is to have a thorough test, it must be disconnected and tested with a Wheatstone bridge or other method described elsewhere.

LIGHTNING ARRESTERS

A lightning discharge takes place only in obedience to an enormous pressure and is of very short duration. During this exceedingly short time the counter E.M.F. of magnets and other inductive arrangements is so

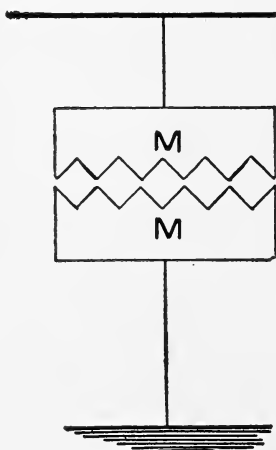

Figure 209

great that it is easier for the current to jump a small air gap than force its way over an ordinary transmission line.

The simplest form of lightning arrester is shown in Figure 209. When the discharge occurs, the current jumps the spark gap between the two metal plates M. If these are connected to a dynamo circuit carrying much current, the arc established by the lightning discharge will be maintained by the dynamo and the result will be a short circuit. This type of arrester can,

therefore, be used only in connection with circuits such as telegraph or telephone in which the currents are not of sufficient strength to maintain an arc.

A single plate of this kind is also useful if mounted closely to belts which give trouble from static charges.

The best known type of lightning arrester is that of Prof. Thomson. In this, the arc which is established by the discharge, is immediately blown out magnetically by the dynamo current. Entering at L, Figure

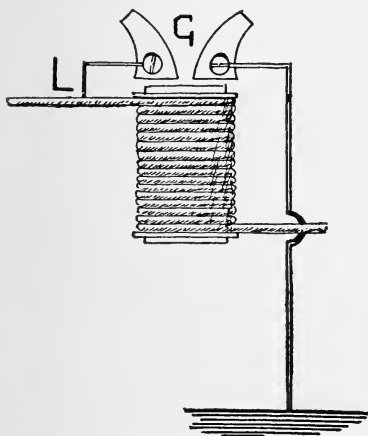

Figure 210

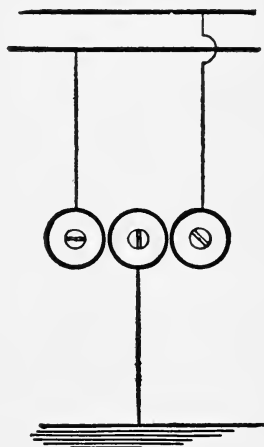

Figure 211

210, the lightning jumps the gap G and passes to ground. The magnetism existing in the coil forces the arc upward until it breaks. It is essential that this arrester be so connected that the side L is toward the outside lines.

Another form of lightning arrester is illustrated in Figure 211. This form is used with alternating current circuits only. It consists of three cylinders placed very close together as shown. These cylinders may be of non-arcing metal, and besides offer such a large sur-

face over which the arc spreads that it does not create a high enough temperature to maintain itself. Ordinarily only a very small spark is noticed.

For use with high voltages either of the foregoing forms may be connected in series. Each wire leading overhead to the outside should be protected. The ground wire for lightning arresters should be as straight as possible; should be of copper, never of iron and should not be run in proximity to iron.

INDEX

	Page
Accumulators	174
Acme testing set	262
Alternating current	44-68
Alternating current motors	86-148
Alternating current motors, types of	96
Alternators, operation of	124
Ammeters	255
Ampere	15
Ampere turns	26-28
Arc dynamo	60
Arc dynamo, starting of	106
Arc lamps	184
Arc lamps on alternating current circuits	187
Armature, heating of	301
Auto-starter	149
Balancing set	120
Batteries, primary	170
Battery rooms	176
Belts	102
Booster	177
Brush arc dynamo	60
Brushes, shifting of	53
Candlepower of arc	192
Candlepower, test for	291
Carbons for arc lamps	188
Charging storage batteries	177
Circuit testing	275
Circular millage of wires	286
Closed circuit batteries	172
Compass needle	245
Commutator	44
Compensator	120

Compound wound dynamo	65
Compound wound dynamos in parallel	114
Compound wound motors	84
Condensers	11
Conductivity of metals	12
Cooper Hewitt lamps	240
Coulomb	16
Counter—electromotive of motors	76
Cross currents	128
Delta connected transformers	163
Delta connected armature	100
Differential arc lamp	200
Differential wound motor	85
Direction of flow of current	8
Direction of flow of induced current	40
Discount meter	338
Distribution of light from incandescent lamps	235
Drum armatures	47
Dynamo-electric machines	39
Dynamos, operation of direct current	102
Dynamos, testing of	269
Dynamo troubles	298
Dynamos, types of	56
Efficiency of dynamos	270
Efficiency of incandescent lamps	219
Efficiency of motors	270
Efficiency of transformers	167
Equalizer wires	114
Enclosed arc	193
Electric current	7
Electric induction	153
Electrolysis, testing for	287
Electrolyte for storage batteries	175
Electromagnets, heating of	36
Electromagnets, winding of	35
Electro-magnetic induction	42
Electromotive force	7
Farad	16

Field magnet	39
Fixture testing	283
Flaming arc	205
Foucault currents	157
Galvanometer, tangent	246
Galvanometer, mirror	248
Gramme ring armature	47
Gravity cell	172
Ground detector	347
Grounding, dynamo frames	107
Grounding, transformers	167
Grounds, testing for	275-347
Henry	18
High potentials, handling of	168
Hysteresis	33
Illumination from arc lamps	194
Illumination from incandescent lamps	234
Incandescent lamps	217
Incandescent lamps, efficiency of with variation in voltage	223
Induced currents	10
Induction motors	90
Installation of meters	317
Instruments for testing	243
Insulation resistance, testing for with voltmeter	270
Insulators	12
Joule	17
Kilowatt	308
Laminating cores	33-157
Leclanche batteries	173
Life and fire hazard	342
Life of incandescent lamps	224
Lightning arresters	350
Lines of force	21-24
Loss, testing for	284
Magnets	265
Magnets, bar	20
Magnets, electro	23

Magnetic flux	25
Magnetism	19
Magnetomotive force	25
Maximum demand meter	338
Mirror galvanometer	248
Mercury arc lamp	240
Mercury arc rectifier	180
Mercury rectifier for arc lamps	215
Mesh winding, armature	100
Metallized filament lamp	230
Meter, discount	338
Meter, installing	317
Meter reading	334
Meter, testing of	323
Meter, three-phase	318
Meter, three-wire	318
Motor troubles	302
Motors, alternating current	148
Motors, direct current	74
Motors, operation of	145
Motors, testing of	269
Motors, three-phase	149
Motors, types of, direct current	80
Multiple arc	196
Mutual induction	155
Nernst lamps	239
Neutral point	53
No-voltage release	145
Ohm	14
Open circuit battery	172
Open circuit, test for	278
Operation of arc lamps	207
Overload release	145
Parallel circuits	11
Parallel operation of alternators	126
Parallel operation of direct current dynamos	112
Photometry	291
Polarity, testing for dynamos	109-116

Polarized magnet	32
Power factor	133
Primary battery	170
Prony brake	273
Racing of motors	304
Range of carbons	188
Rating of arc lamps	191
Rating of incandescent lamps	221
Reading of meters	334
Recording wattmeters	307
Rectifier, for alternating current dynamos	71-124
Rectifier, for arc lamps	215
Rectifier, mercury arc	180
Regulator, series arc	214
Resistance, magnetic	26
Reversing alternating current motors	150
Rheostat, field	51
Rheostat, starting	145
Ring armature	47
Rotary converter, operation of	133
Rotor	95
Series arc	196
Series arc switchboard	211
Series circuit	11
Series dynamo	56
Series motor	80
Series operation of arc machines	109
Shunt dynamo	63
Shunt dynamos in parallel	112
Shunt dynamos, starting of	111
Shunt for ammeter	256
Shunt motor	83
Slip of induction motor	94
Smashing point of incandescent lamps	225
Solenoid	30
Sparking of brushes	299-304
Squirrel cage armature	94
Star connected transformer	163

Star winding, armature	100
Starting box, automatic	145
Stator	95
Step-down transformer	152
Step-up transformer	152
Stillwell regulator	133
Storage batteries	174
Switchboard, charging storage batteries	178
Switchboard, series arc	211
Synchronizing alternators	126-130-134
Synchronous motors	89
Synchroscope, Lincoln	139
Tangent galvanometer	246
Tantalum lamp	231
Telephone receiver for testing	266
Testing, arc lamps	210
Testing, carbons	188
Testing, circuits	275
Testing, connections on interior wiring	282
Testing, dynamos and motors	269
Testing, electrolysis	289
Testing, fixtures	283
Testing, incandescent circuits	279
Testing, instruments for	243
Testing, for loss	284
Testing, meters	323
Testing, polarity	129-281
Testing, rail bonds	291
Testing, transformers	165
Thomson wattmeters	311
Thomson-Houston dynamo	62
Thomson-Houston arc switchboard	211
Three-phase transformer connections	164
Three-wire systems	184
Three-wire transformers	161
Transformers	151
Transformer connections	159
Transformers in parallel	162

Trimming arc lamps	207
Tungsten lamps	232
Two-wire meters	311
Volt	16
Volt, production of	41
Voltmeter	255
Watt	308
Watt-hour	309
Wattmeter, recording	307
Weston Instruments	250
Wheatstone bridge	257

THE AUTOMOBILE HAND-BOOK

OVER 100,000 SOLD

By ELLIOTT BROOKES, Assisted by Other Well-Known Experts

Revised and Enlarged 1911 Edition—The largest and most practical work published. Used by all up-to-date automobile schools as their every-day text-book. 16mo, over 650 pages and over 320 illustrations. Full Leather Limp, Round Corners, Red Edges. Price, \$2.00.

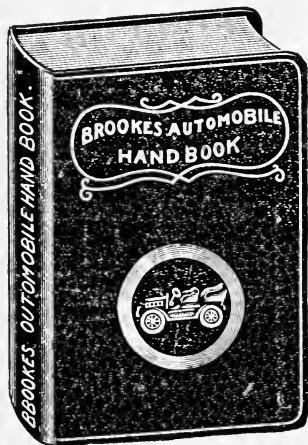

At the present time nearly all automobile troubles or breakdowns may, in almost every case, be traced to the lack of knowledge or carelessness of the owner or operator of the car, rather than to the car itself.

The automobile hand book is a work of practical information for the use of owners, operators and automobile mechanics, giving full and concise information on all questions relating to the construction, care and operation of gasoline and electric automobiles, including road troubles, motor troubles, carburetor troubles, ignition troubles, battery troubles, clutch troubles, starting troubles. With numerous tables, useful rules and formulæ, wiring diagrams and over 320 illustrations.

Special efforts have been put forth to treat the subjects of ignition, and ignition devices, in a manner befitting their importance. A large section has been devoted to these subjects, including batteries, primary and secondary, magnetos.

carburetors, spark plugs, and in fact all devices used in connection with the production of the spark. Power transmission is thoroughly discussed, and the various systems of transmitting the power from the motor to the driving axle are analyzed and compared.

The perusal of this work for a few minutes when troubles occur, will often not only save time, money, and worry, but give greater confidence in the car, with regard to its going qualities on the road, when properly and intelligently cared for.

A WORD TO THE WISE

The time is at hand when any person caring for and operating any kind of self-propelling vehicle in a public or private capacity, will have to undergo a rigid examination before a state board of examiners and secure a license before they can collect their salary or get employment.

Already New York State has enacted such a law and before long, with a positive certainty every state in the Union will pass such an ordinance for the protection of life and property.

Remember this is a brand new book from cover to cover, just from the press—1911 Edition—and must not be confounded with any former editions of this popular work.

Sent prepaid to any address upon receipt of price

FREDERICK J. DRAKE & CO., Publishers

1325 Michigan Avenue, . . . CHICAGO, U. S. A.

The Automobile Mechanician's Catechism

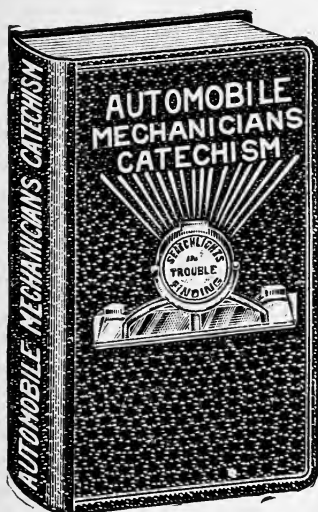

Over 400 Questions and Answers. Illustrated with three large folding charts with all parts fully and correctly numbered.

By
CALVIN F. SWINGLE, M. E.
Pocket Edition, 16mo. Full Leather, Round Corners, Red Edges, Stamped in Gold. Over 100 Pages.

Price, \$1.25

Adapted for use in the technical school, the work shop, or on the road. The questions asked and the answers given in this catechism will be found to be an indispensable guide to quicker and better work by the automobile student, no matter whether that work be in the school, the shop, on the road or before the examining board of engineers.

The subject matter is not made up of cuts and advertising eulogies from the catalogues of manufacturers and dealers, but consists of a plain, practical course of instruction, containing at the same time sufficient theory to enable the student to become thoroughly familiar with the basic principles controlling the design, construction and operation of modern automobiles of all types, whether gasoline, electric, or steam driven. The questions and answers have been carefully compiled, and they are presented in a clear and concise form, covering every detail of automobile work; a reliable instructor and assistant to the student and mechanic, while to the chauffeur the book is a most valuable guide and helper, giving correct method for handling the machine under all conditions of service, and what to do in case of breakdowns. The demand for skilled mechanics in the field of automobile work is constantly increasing, and especially so regarding the operation of the machines, quite a number of the states and larger cities already having rigid laws requiring chauffeurs to undergo a strict examination before a board of mechanical experts before being licensed as automobile chauffeurs or drivers.

Sent prepaid to any address upon receipt of price.

FREDERICK J. DRAKE & CO., Publishers
1325 Michigan Avenue - - CHICAGO, U. S. A.

Practical Armature and Magnet Winding

By HENRY C. HORSTMANN and VICTOR H. TOUSLEY

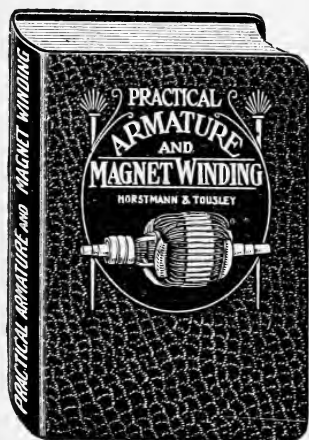

WHILE the subject of armature winding has, in the past, been more or less completely covered, most of these works have been either too technical in their composition or have required a fair degree of knowledge of the subject before they could be clearly understood. There has been a need of a book covering this matter which, while giving all that is necessary for an intelligent understanding, would, at the same time, present the matter in such a simple form that it could be readily grasped by those who had not had the benefit of a previous education along this line.

This book treats in a practical and concise manner this very important subject.

All practical armature windings are fully explained with special attention paid to details. All questions which are apt to arise in the minds of the students have been completely answered.

Numerous illustrations have been supplied, and these, taken in conjunction with the text, afford a ready means for either the study of the armature or for a book of reference.

It has been the aim of the authors to supply all the necessary information required by the subject and, at the same time, to give this information in as condensed and brief a form as is consistent with a clear understanding.

Various useful tables have been especially prepared for this work and these will not only reduce to a minimum the number of calculations required, but lessen the possibility of errors.

A chapter on the calculation of armatures gives complete information in detail for the design of an armature.

Sold by booksellers generally or sent postpaid to any address upon receipt of price.
16mo., Pocket Size, Full Persian Morocco Leather, Round
Corners, Red Edges - - - - - \$1.50

FREDERICK J. DRAKE & CO.
PUBLISHERS - - - - - CHICAGO, ILLINOIS

OPERATORS' WIRELESS TELEGRAPH AND TELEPHONE HAND-BOOK

By VICTOR H. LAUGHTER

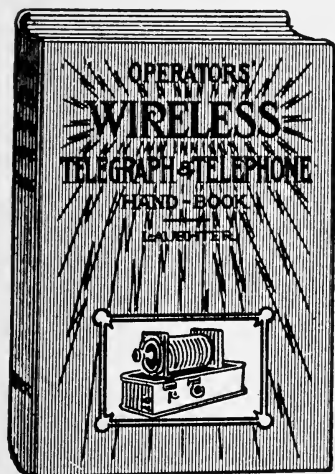

UP-TO-DATE and most complete treatise on the subject yet published. Gives the historical work of early investigators on up to the present day. Describes in detail the construction of an experimental wireless set. How to wind spark coil and dimensions of all size coils. The tuning of a wireless station is fully explained with points on the construction of the various instruments.

A special chapter on the study of wireless telegraphy is given and the rules of the Naval stations with all codes, abbreviations, etc., and other matter interesting to one who takes up this study.

The most difficult points have been explained in non-technical language and can be understood by the layman. Wireless telephony is given several chapters and all the systems in use are shown with photographs and drawings.

By some practical work and a close study of this treatise one can soon master all the details of wireless telegraphy.

Sold by booksellers generally or sent postpaid to any address upon receipt of price.
12mo., Cloth, 210 Pages, Fully Illustrated, and with Six additional Full-Page Halftone Illustrations Showing the Installation of "Wireless" on the U. S. War Ships and Ocean Liners \$1.00

FREDERICK J. DRAKE & CO.

PUBLISHERS CHICAGO, ILLINOIS

MODERN ELECTRICAL CONSTRUCTION

By HORSTMANN and TOUSLEY

THIS book treats almost entirely of practical electrical work. It uses the "Rules and Requirements of the National Board of Fire Underwriters" as a text, and explains by numerous cuts and detailed explanations just how the best class of electrical work is installed.

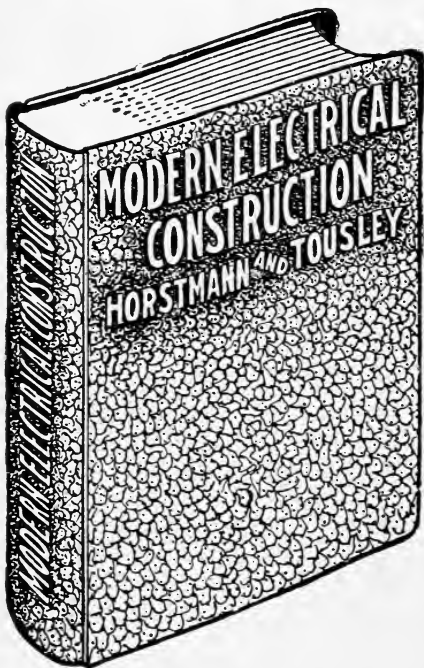

It is a perfect guide for the beginning electrician and gives him all the *theory needed* in practical work in addition to full practical instructions. For the journeyman electrician it is no less valuable, because it elaborates and explains safety rules in vogue throughout the United States. It is also of especial value to electrical inspectors, as it points out many of the tricks practiced by unscrupulous persons in the trade.

The book also contains a number of tables giving dimensions and trade numbers of screws, nails, insulators and other material

in general use, which will be found of great value in practice. There is also given a method by which the diameter of conduit necessary for any number of wires of any size can be at once determined. The motto of the authors, "To omit nothing that *is needed* and include nothing that is *not needed*," that has made "Wiring diagrams and Descriptions" so successful, has been followed in this work. No book of greater value to the man who does the work has ever been published. 16mo, 250 pages, 100 diagrams. Full leather, limp.

Price, net, \$1.50

Sent postpaid to any address in the world upon receipt of price

FREDERICK J. DRAKE & CO.

PUBLISHERS

CHICAGO,

ILLINOIS.

A BOOK EVERY ENGINEER AND ELECTRICIAN SHOULD HAVE IN HIS POCKET. A COMPLETE ELECTRICAL REFERENCE LIBRARY IN ITSELF

NEW EDITION

The Handy Vest-Pocket ELECTRICAL DICTIONARY

BY WM. L. WEBER, M.E.

ILLUSTRATED

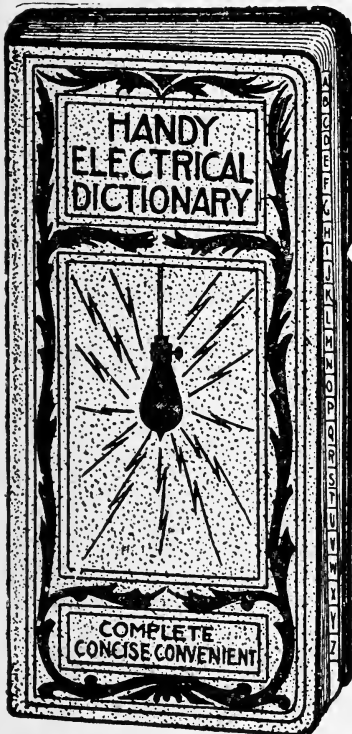

CONTAINS upwards of 4,800 words, terms and phrases employed in the electrical profession, with their definitions given in the most concise, lucid and comprehensive manner.

The practical business advantage and the educational benefit derived from the ability to at once understand the meaning of some term involving the description, action or functions of a machine or apparatus, or the physical nature and cause of certain phenomena, cannot be overestimated, and will not be, by the thoughtful assiduous and ambitious electrician, because he knows that a thorough understanding, on the spot, and in the presence of any phenomena, effected by the aid of his little vest-pocket book of reference, is far more valuable and lasting in its impression upon the mind, than any memorandum which he might make at the time, with a view to the future consultation of some voluminous standard textbook, and which is more frequently neglected or forgotten than done.

The book is of convenient size for carrying in the vest pocket, being only 2½ inches by 5½ inches, and ¼ inch thick; 224 pages, illustrated, and bound in two different styles:

New Edition. Cloth, Red Edges, Indexed . . . 25c

New Edition. Full Leather, Gold Edges, Indexed, 50c

Sold by booksellers generally or sent postpaid to any address upon receipt of price.

FREDERICK J. DRAKE & CO.

PUBLISHERS

CHICAGO. : : : : ILLINOIS.

THIS NEW EDITION contains in addition four complete chapters on The Steam Turbine and Mechanical Stokers which is not included in other Engineering Works.

The 20th Century Hand Book

FOR

Engineers and Electricians

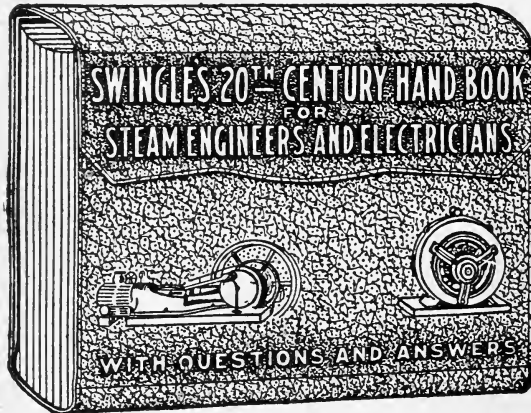

A COMPENDIUM of useful knowledge appertaining to the care and management of Steam Engines, Boilers and Dynamos. Thoroughly practical with full instructions in regard to making evaporation tests on boilers. The adjustment of the slide valve, corliss valves, etc., fully described and illustrated, together with the application of the indicator and diagram analysis. The subject of hydraulics for engineers is made a

special feature, and all problems are solved in plain figures, thus enabling the man of limited education to comprehend their meaning.

By C. F. SWINGLE, M.E.

Formerly Chief Engineer of the Pullman Car Works. Late Chief Engineer of the Illinois Car and Equipment Co., Chicago.

ELECTRICAL DIVISION

The electrical part of this valuable volume was written by a practical engineer for engineers, and is a clear and comprehensive treatise on the principles, construction and operation of Dynamos, Motors, Lamps, Storage Batteries, Indicators and Measuring Instruments, as well as an explanation of the principles governing the generation of alternating currents, and a description of alternating current instruments and machinery. No better or more complete electrical part of a steam engineer's book was ever written for the man in the engine room of an electric lighting plant.

SWINGLE'S 20th CENTURY HAND BOOK FOR ENGINEERS AND ELECTRICIANS

Over 300 illustrations; handsomely bound in full leather pocket book style; size 5 x 8 1/4 x 1 inch thick. PRICE NET **\$3.00**

Sold by booksellers generally or sent postpaid to any address upon receipt of price.

FREDERICK J. DRAKE & CO.

PUBLISHERS

CHICAGO, : : : : ILLINOIS.

THE MOST IMPORTANT BOOK ON ELECTRICAL CONSTRUCTION
WORK FOR ELECTRICAL WORKERS EVER PUBLISHED.

REVISED AND ENLARGED EDITION

MODERN WIRING DIAGRAMS AND DESCRIPTIONS

A Hand Book of practical diagrams and
information for Electrical Workers.

By HENRY C. HORSTMANN and
VICTOR H. TOUSLEY
Expert Electricians.

**This grand little volume not only tells
you how to do it, but it shows you.**

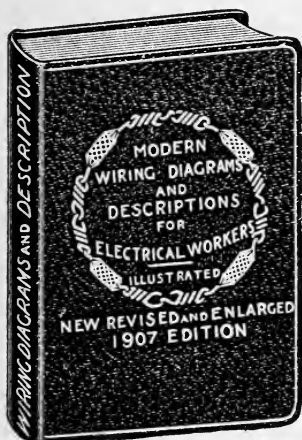

The book contains no pictures of bells, batteries or other fittings; you can see those anywhere.

It contains no Fire Underwriters' rules; you can get those free anywhere.

It contains no elementary considerations; you are supposed to know what an **ampere**, a **volt** or a "short circuit" is. And it contains no historical matter.

All of these have been omitted to make room for "**diagrams and descriptions**" of just such a character as **workers** need. We claim to give all that ordinary electrical workers need and nothing that they do not need.

It shows you how to wire for call and alarm bells.

For burglar and fire alarm.

How to run bells from dynamo current.

How to install and manage batteries.

How to test batteries.

How to test circuits.

How to wire for annunciators; for telegraph and gas lighting.

It tells how to locate "trouble" and "ring out" circuits.

It tells about meters and transformers.

It contains 30 diagrams of electric lighting circuits alone.

It explains dynamos and motors; alternating and direct currents.

It gives ten diagrams of ground detectors alone.

It gives "**Compensator**" and storage battery installation.

It gives simple and explicit explanation of the "**Wheatstone**" Bridge and its uses as well as volt-meter and other testing.

It gives a new and simple wiring table covering all voltages and all losses or distances.

16mo., 160 pages, 200 illustrations; full leather binding, round corners, red edges. Size 4x6, pocket edition. PRICE

\$1.50

Sold by booksellers generally or sent postpaid to any address upon receipt of price.

FREDERICK J. DRAKE & CO., Publishers
CHICAGO, ILL.

DYNAMO TENDING

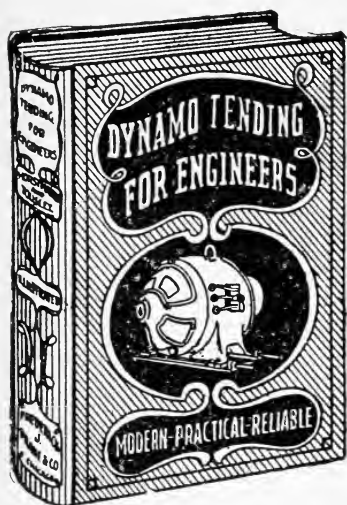

for ENGINEERS

Or, ELECTRICITY
FOR STEAM ENGINEERS

By HENRY C. HORSTMANN and
VICTOR H. TOUSLEY,
Authors of "Modern Wiring Diagrams and
Descriptions for Electrical Workers."

This excellent treatise is written by engineers for engineers, and is a clear and comprehensive treatise on the principles, construction and operation of Dynamos, Motors, Lamps, Storage Batteries, Indicators and Measuring Instruments, as well as full explanations of the principles governing the generation of alternating currents and a descrip-

tion of alternating current instruments and machinery. There are perhaps but few engineers who have not in the course of their labors come in contact with the electrical apparatus such as pertains to light and power distribution and generation. At the present rate of increase in the use of Electricity it is but a question of time when every steam installation will have in connecton with it an electrical generator, even in such buildings where light and power are supplied by some central station. It is essential that the man in charge of Engines, Boilers, Elevators, etc., be familiar with electrical matters, and it cannot well be other than an advantage to him and his employers. It is with a view to assisting engineers and others to obtain such knowledge as will enable them to intelligently manage such electrical apparatus as will ordinarily come under their control that this book has been written. The authors have had the co-operation of the best authorities, each in his chosen field, and the information given is just such as a steam engineer should know,

To further this information, and to more carefully explain the text, nearly 100 illustrations are used, which, with perhaps a very few exceptions, have been especially made for this book. There are many tables covering all sorts of electrical matters, so that immediate reference can be made without resorting to figuring. It covers the subject thoroughly, but so simply that any one can understand it fully. Any one making a pretense to electrical engineering needs this book. Nothing keeps a man down like the lack of training; nothing lifts him up as quickly or as surely as a thorough, practical knowledge of the work he has to do. This book was written for the man without an opportunity. No matter what he is, or what work he has to do, it gives him just such information and training as are required to attain success. It teaches just what the steam engineer should know in his engine room about electricity.

12mo, Cloth, 100 Illustrations. Size $5\frac{1}{2} \times 7\frac{3}{4}$. PRICE NET \$1.50
Sold by booksellers generally, or sent, all charges paid, upon receipt of price

FREDERICK J. DRAKE & CO., Publishers
CHICAGO, ILL.

One copy del. to Cat. Div.

DEC 27 1910





LIBRARY OF CONGRESS



0 021 225 294 3