

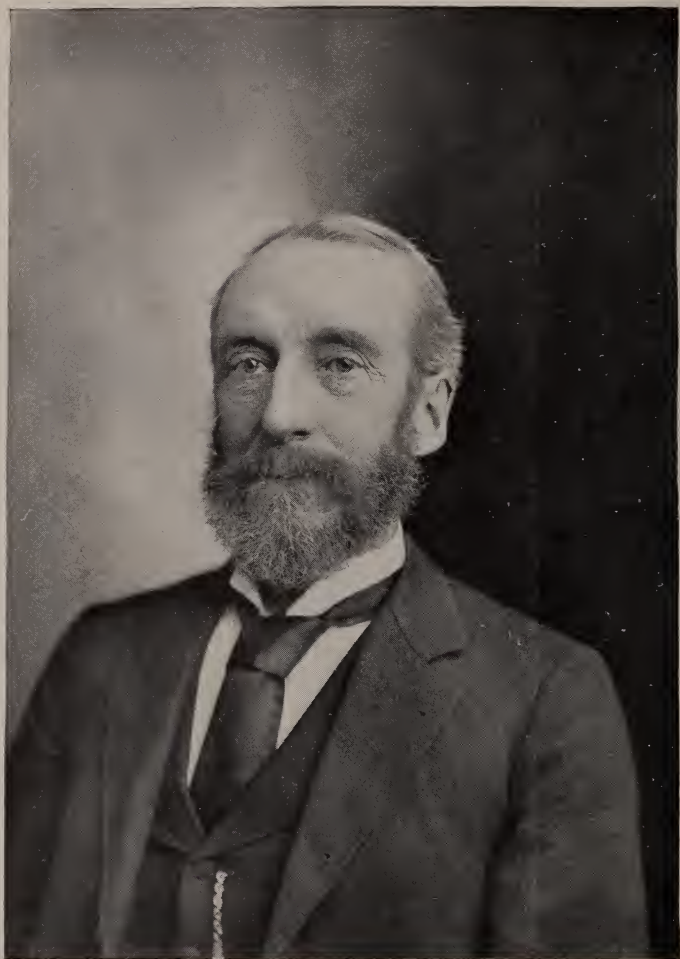





**ELECTRICITY FOR
EVERYBODY.**



Philip Atkinson.

ELECTRICITY FOR EVERYBODY;

ITS NATURE AND USES EXPLAINED.

BY

PHILIP ATKINSON, A. M., PH. D.

AUTHOR OF "ELEMENTS OF STATIC ELECTRICITY,"

"THE ELEMENTS OF ELECTRIC LIGHTING,"

"THE ELEMENTS OF DYNAMIC ELECTRICITY AND MAGNETISM,"

"THE ELECTRIC TRANSFORMATION OF POWER."

Revised and Enlarged



NEW YORK
THE CENTURY CO.
1907

Q-27
A89

LIBRARY of CONGRESS
Two Copies Received
JUN 3 1907
Copyright Entry
June 3, 1907
CLASS *a* Xxc., No.
178395
COPY B.

Copyright, 1895, 1897, 1907
by THE CENTURY CO.



INTRODUCTION.

The object of this book is to meet the public demand for information in regard to the nature and uses of electricity, and the various kinds of apparatus by which it is generated and employed. This information has been given in the simplest form consistent with clearness, fullness, and strict scientific accuracy, and with as little detail as possible; the constant aim of the writer being to make each topic so plain, that any person having no previous knowledge of electricity or kindred sciences, who gives the book a careful perusal, can obtain a good general knowledge of electric science in all its principal details; the style throughout being adapted, as far as possible, to the requirements of the general reader rather than to those of the student.

All mathematical demonstrations have been omitted, and all unnecessary technicality avoided; such technical terms as are strictly required being fully explained. Only the latest and most approved apparatus and methods have been described, matter of a merely historical character being omitted, or receiving only a passing notice. The principal electric units and instruments for electric measurement have been briefly described in connection with other matter, to avoid the wearisome detail of a full description in a separate chapter.

PHILIP ATKINSON.

CHICAGO, May 6, 1895.

PUBLISHERS' NOTE
TO THE THIRD EDITION.

THE continued popularity of this book after the death of its author has led the publishers to prepare a new edition. This edition brings the work up to date and includes a chapter on "Wireless Telegraphy."

The work of revision has been done by a well-known expert who is a professor in one of the leading technical colleges.

CONTENTS.

CHAPTER I.

PAGE

THE NATURE OF ELECTRICITY AND ELECTRIC TRANSMISSION	1
Nature of Electricity.—Energy.—Conservation of Energy.—Molecular Energy.—Ether.—Electric Transmission.—The Electric Current and Circuit.—Opening and Closing Electric Circuit.—Electric Induction.—Dielectrics.—Natural Electric Distribution.—Measurement of Electric Pressure and Current Volume.—Voltmeter.—Ammeter.—Electric Units.	

CHAPTER II.

STATIC ELECTRICITY	20
Elementary Principles.—Frictional Electric Generator.—The Leyden Jar.—Influence Machines.—The Atkinson Töpler-Holtz Machine.—Spark Discharge.—Four-Plate Machine.—Static Induced Current.—Brush Discharge.—Report.—Direction of Rotation.—The Wimshurst Machine.—Uses of Influence Machines.—Vacuum Tubes.—Lightning.—Return Stroke.—Thunder.—Lightning-Rods.—The Aurora.—Cause of the Aurora.	

CHAPTER III.

ELECTRIC BATTERIES	57
Elementary Principles.—Polarization.—The Smee Cell.—Zinc-Carbon Cells.—The Law Cell.—The Samson Cell.—The Leclanché Cells.—Potassium-Bichromate Cells.—The Grenet Cell.—Amalgamation of the Zinc.—The Edison-Lalande Cell.—Dry Cells.—Two-Fluid Cells.—The Daniell Cell.—Gravity Cells.—Bunsen and Grove Cells.—Battery Connections.—Comparison between Large and Small Cells.—Storage Bat-	

teries.—The Planté Cell.—The Faure Cell.—The American Cell.—The Chloride Accumulator.—Electric Pressure and Rate of Discharge.—Electrolysis.—Electrolysis in Medical Practice. Electric Caутery.

CHAPTER IV.

MAGNETISM	93
Elementary Principles.—Magnetic Lines of Force.—The Earth's Magnetism.—Agonic Line.—Steel Magnets.—Portative Force.—Effect of Breaking a Magnet.—Consequent Poles.—Magnetic Attraction and Repulsion.—Electromagnetism.—Deflection of the Magnetic Needle by the Electric Current.—Electromagnets.—Magnet Core.—Solenoids.—Ampère's Theory of Magnetism.—Magnetism Generating Electricity.—Induction Coils.—Electric Bells.	

CHAPTER V.

DYNAMOS	114
Evolution of the Dynamo.—Direct Current Dynamos.—Series Wound Dynamo.—Shunt Wound Dynamo.—Compound Wound Dynamo.—Constant Current and Constant Potential.—Armature Construction.—Construction of Brushes and Commutator.—Bipolar Dynamo.—Multipolar Dynamos.—Alternating Current Dynamos.—Transformers.	

CHAPTER VI.

ELECTRIC MOTORS.....	140
Principles of Construction.—Counter Electric Pressure.—Relative Size of Dynamos and Motors.—Electric Distribution of Power.—Niagara Falls Electric Power Station.—Loss of Power in Electric Transmission.—Stationary Motors.—Rheostats.—Reversal of Rotation.—Alternating Current Motors.—Two Phase Motors.—Single Phase Motors.—Railway Motors.—Electric Railways.—Running Cars by Storage Batteries.—Lightning Arresters.—Recording Watt-Meter.	

CHAPTER VII.

ELECTRIC LIGHTING	165
Heat and Light by Electric Resistance.—Arc Lighting.—Double Carbon Lamp.—Cut-Out.—Incandescent Lighting.—Parallel System of Electric Distribution.—Three-Wire System.—Alternating Current Distribution.—Tesla's Discoveries.	

CHAPTER VIII.

HEAT AND ELECTRICITY	182
Electric Heating.—Dewey Heater.—Carpenter Heater.—Advantages of Electric Heating.—Electric Cooking.—Electric Ironing.—Electric Welding.—Electricity Generated by Heat.	

CHAPTER IX.

THE TELEGRAPH AND TELEPHONE	193
Simple Telegraph Equipment.—The Key.—The Sounder.—The Morse Alphabet.—The Relay.—Cut-Out and Lightning Arrester.—Repeaters.—Duplex Transmission.—The Neutral Relay.—Transmission by the Neutral Relay.—Condenser.—Transmitter.—The Polarized Relay.—Quadruplex Transmission.—Automatic Transmission.—Submarine Transmission. Reflecting Galvanometer.—Siphon Recorder.—Automatic Transmitters.—Cable Alphabet.—Static Charge.—Operation of Condenser.—The Telautograph.—The Telephone.—The Bell Receiver.—The Blake Transmitter.—Difference between Telegraphic and Telephonic Transmission.—Construction of Telephone Circuit.—Cross Talk.—The Long Distance Telephone.—The Solid Back Transmitter.	

CHAPTER X.

THE RÖNTGEN X-RAYS	227
Discovery of the Rays.—Generating Apparatus.—Comparative Permeability of Different Substances.—Fluorescence.—Fluorescent Screen.—The Fluoroscope.—Sciagraphs.—Nature of the Rays.—Practical Uses of the Rays.—X-Ray Illustrations.	

CHAPTER XI.

WIRELESS TELEGRAPHY	253
Invention of the Wireless Telegraph.—The Marconi Sending Apparatus.—The Coherer.—The Marconi Receiving Apparatus.—Self-Restoring Detectors.—The Telephone as a Receiving Instrument.—Interference Messages.—Tuned or a Syntonic Signalling.—Apparatus for Long Distance Transmission. Application of Wireless Telegraphy.	

**ELECTRICITY FOR
EVERYBODY.**

ELECTRICITY FOR EVERYBODY;

ITS NATURE AND USES EXPLAINED.



CHAPTER I.

THE NATURE OF ELECTRICITY AND ELECTRIC TRANSMISSION.

NATURE OF ELECTRICITY.—The prevailing popular opinion that no one knows what electricity is, which has been current for so many years, is no longer strictly true. The laws of electricity are as fully and clearly understood now as those of heat, light, and gravity; and in its application to the various purposes for which it is employed, calculations based on these laws can be made with the greatest accuracy.

Its nature is not so clearly understood as its laws, but this is equally true of heat, light, and gravity; and by comparing it with these natural phenomena, and especially with heat, to which it seems to be closely allied, we obtain indications in regard to its nature on which a well-founded theory may be based, the truth of which can hardly be doubted.

The theory prevalent forty years ago, that it is a fluid, or a combination of two fluids having opposite qualities,

like the oxygen and nitrogen of air, or the oxygen and hydrogen of water, has long since been abandoned, and no well-informed electrician ever speaks of it now as a fluid.

ENERGY.—When, not many years ago, it was discovered that the principle which we call *energy* is a universal property of matter, a great search-light was turned on the dark places of science, revealing in beautiful simplicity what before was hidden and mysterious; and electricity especially received the benefits of this illumination. This principle, formerly recognized only in its most prominent, active forms, as in the living animal, the growing plant, the operating-machine, the glowing fire, the shining lamp, was found to exist also in bodies apparently destitute of it, as a stone, a brick, a log, a block of ice, or any other body; energy being, in fact, inseparable from matter, and matter inseparable from energy.

CONSERVATION OF ENERGY.—A second fact of equal importance is that energy, like matter, can neither be created nor destroyed. As it is impossible to create a single grain of sand out of nothing, or to reduce it to nothing, so it is equally impossible either to create or reduce to nothing a single particle of energy. But energy, like matter, can be changed from one form to another, or from one place to another. As ice can be transformed into water, and water into steam, or coal burned into ashes, cinder, soot, and gas, without a particle of loss, so energy can be transformed without loss: as when the energy of falling water or expanding steam is transformed into mechanical energy for the operation of machinery,—the total sum recovered as useful work and wasted in overcoming friction and inertia, or as heat,

being equal to the original quantity; and the energy expended at the water-wheel or the engine reappearing in its modified form in the mill or the factory. This transformation of energy, without increase or decrease, is what is known scientifically as *the conservation of energy*, the great fundamental doctrine of modern science, on which all the calculations of the civil or electric engineer, with reference to power, are based.

MOLECULAR ENERGY.—Energy manifests itself either in masses of matter, or in those infinitely small particles called *molecules*, of which the masses are composed. Hence we have the two kinds — *mass energy* and *molecular energy*. Mass energy becomes manifest in such familiar forms as gravity, as when a weight falls, or is attracted to the earth; magnetic attraction, as when a magnet attracts iron; electric attraction, as when an electrified stick of hard-rubber or sealing-wax attracts bits of paper. Molecular energy becomes manifest by the movements of the molecules among themselves, of which we have familiar examples in the various kinds of chemical change by which new bodies are formed out of old ones, as soap out of alkali and grease, vinegar out of dilute alcohol. Heat is believed to be a certain mode of molecular motion, and the degree of intensity of this motion is expressed by the terms *hot*, *cool*, *cold*. In molten iron this motion has very high intensity, in ice very low intensity. Electricity is believed to be another mode of molecular motion, peculiar to itself, and different from that of heat. Just what that difference is, or what is the peculiar nature of the motion in each, has never been discovered. It is supposed to be in the form of undulations or vibrations,—the heat undulations having one form, the electric undulations another form; so that

while both kinds of motion are found in the same body at the same time, they do not interfere with each other.

When, therefore, the hand is placed on a hot body, that peculiar sensation which we feel, and call *heat*, is, according to this theory, simply the motion of the molecules; and, in like manner, when the hand is placed on a body through which a very strong electric current is flowing, the peculiar sensation, different from that of heat, which is felt, is molecular motion in another form; both produced by the same active principle which we call energy. And it is remarkable that the same effect is produced by contact with a body through which a sufficiently powerful electric current is flowing as by contact with a red-hot iron,—a burn being the result in each case, though the electrified body may be barely warm.

If any one doubts the possibility of a vibratory motion of the molecules in such solid bodies as the metals, he should remember that bodies of apparently the greatest solidity are full of invisible pores, revealed only by the microscope, and of an infinitely greater number beyond the power of the microscope to reveal; so that these infinitesimal molecules, which far exceed the ability of the most powerful microscope to reveal separately, can move freely in these internal spaces.

ETHER.—These spaces, and the similar spaces in all other matter in the world and the universe, whether it be solid, liquid, or gaseous, are believed to be filled with a fluid called *ether*, which is so thin that it is impossible to perceive it, and which extends into the vast regions of space, where it is supposed that even the thinnest air does not exist; and this ether is believed to be the medium by which electricity, and also light, is transmitted, and in part produced, by undulations, much in

the same manner as sound is produced and transmitted by undulations of the grosser air, but with infinitely greater speed and facility, since ether is infinitely thinner than air, or any other gaseous fluid. There is a mutual reaction between the vibratory motion of the molecules and the undulatory motion of the ether,—the vibrations producing the undulations, and the undulations, in turn, producing the vibrations; just as the vibratory strokes of the oar produce waves, which in turn produce vibrations in other oars resting in the water.

The necessity for such a medium becomes apparent when we consider that energy cannot exist without matter; so that if these small internal spaces, and the great spaces between the heavenly bodies, were an absolute vacuum, the transmission of energy, in any form, would be an impossibility. Hence the existence of the ether is now universally accepted as a fact of which there can be no reasonable doubt, and which accounts in a rational manner for natural phenomena, especially those pertaining to light and electricity, which could not otherwise be satisfactorily explained.

The conclusion, therefore, to which we come in regard to the nature of electricity is this: that electricity is a manifestation of energy, believed to consist in undulations of the ether, and vibrations of the grosser molecules of matter; or, briefly, that it is *a mode of molecular motion*.

We see, then, that it is neither energy nor matter, but, like heat, light, and sound, it is an effect produced by energy on matter. But as the effect cannot be separated from its cause, it is proper, and often convenient, to speak of it as *electric energy*, in the same sense as we speak of mechanical energy, vital energy, heat energy, or

energy in any other form in which it becomes manifest as associated with matter.

ELECTRIC TRANSMISSION.—Electricity is transmitted through different substances with different degrees of facility. Those through which it can be transmitted easily, as most of the metals, especially silver, copper, and iron, are called *conductors*; and those which resist its transmission so strongly that it will hardly pass through them at all, as hard-rubber, glass, and porcelain, are called *non-conductors*; and the two opposite qualities thus shown are distinguished by the terms *conductivity* and *resistance*. Non-conductors, when employed to confine electricity, or prevent its transmission, are called *insulators*, and this confinement is expressed by the term *insulation*: as, for instance, copper wire is said to be insulated when enveloped in cotton, silk, gutta-percha, or any other non-conductor by which an electric current flowing through it is confined, and its transmission to another conductor prevented, by this insulation.

It is not known why one substance permits the transmission of electricity, and another resists it; but this is equally true of the transmission of heat and light, and may be ascribed, in each case, to some peculiar arrangement of the molecules; so that transmission may result from harmony of molecular motion, and resistance from want of harmony: just as in the production and transmission of sound, the air-waves from one reed or string of an instrument may produce harmonic vibrations and a musical note in another reed or string occupying the proper relative position on the musical scale, or opposing waves may interfere and produce discord, or even silence. And it is very remarkable that the same substances show conductivity or resistance for electricity in about the

same degree as for heat,—indicating clearly a close affinity between the two, so that the same molecular arrangement affects each in about the same manner.

THE ELECTRIC CURRENT AND CIRCUIT.—The transmission of electricity is produced by what is called *electromotive force*, or *electric pressure*, which results from a greater accumulation of electric energy at one point than at another, producing a difference of the condition known as *electric potential* between them. The term *positive* expresses the condition of the point having the higher electric energy, and *negative* the relative condition of the other point; terms used in the same sense as *hot* and *cold* in the similar relative conditions of heat potential.

When two such points are connected by a conductor, electric energy flows from the positive point to the negative—that is, from higher to lower potential, producing what is called the *electric current*. This would immediately produce equality of potential between the points, and the flow would cease unless the difference of potential were maintained, which can be done by an electric generator, either a battery or a dynamo, both of which will be described hereafter.

This current, when employed for practical use, flows from the generator through a wire conductor to the place where it is used, and back through another wire to the generator; and this is what is known as the *electric circuit*. Either copper or iron wires are employed, according to the use for which the circuit is intended; or the earth may be made a part of the circuit, as in telegraph lines; or iron rails, as in electric railways.

The current is impelled through the circuit by the electric pressure at the generator, just as a current of steam is impelled through pipes by the generating pressure

at the steam-boiler, or of water by the hydrostatic pressure at the water-works. If electricity is a mode of molecular motion, as has been assumed, its transmission is simply the extension of this motion through the rows of molecules composing a wire or other conductor, by the vibrations and ether undulations, in much the same manner as vibrations are transmitted through a row of balls in contact, when produced by a blow at one end of the row,—the effect being seen in the bounding away of the ball at the opposite end; the electric vibrations and undulations traveling with infinitely greater velocity than the grosser mechanical vibrations, so that they traverse one of the great ocean telegraph cables in a fraction of a second, or the distance between the sun and the earth in eight minutes.

The *volume* of the current, with a given pressure, depends on the electric resistance of the circuit; and this resistance depends on the kind of wire, or other material, of which the circuit, or any part of it, is composed, and the length and cross-section of this wire, or other conductor. A copper wire, for instance, has much less resistance than an iron wire of the same length and cross-section, and will therefore carry a current of proportionally greater volume with the same pressure. If the length of this wire is increased, or one of the same length but smaller cross-section substituted for it, the volume of the current will be proportionally reduced. But if the length is reduced, or a wire of the same length but larger cross-section substituted for it, the volume of the current will be proportionally increased.

This resistance is very similar to the friction of water, steam, or gas flowing through a pipe: the shorter the pipe, or the greater its cross-section, the less will be

the friction and the greater the volume of current; and the longer the pipe, or the smaller its cross-section, the greater will be the friction and the less the volume of current. As the introduction of wool, cotton, or moss into such a pipe increases the friction, so the introduction of a wire or other conductor of high electric resistance into the circuit at any point produces a similar effect. Thus a coil of German-silver or other wire of high resistance, a strip of composite metal, or a rod or fine strip of carbon, may be made a part of the circuit at any point, either to regulate the volume of the current, prevent increase of current volume beyond the safety limit, or produce electric light or heat.

This whole matter of the relations of the electric current to electric pressure and resistance may be briefly summed up in the words of Ohm's celebrated law: *The volume of an electric current varies directly as the electric pressure by which the current is impelled, and inversely as the total resistance encountered.*

OPENING AND CLOSING ELECTRIC CIRCUIT.—The electric circuit is always arranged for the transmission or interruption of the current by making an opening in it at any

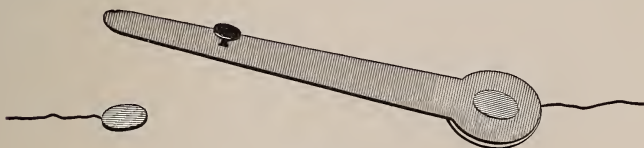

Fig. 1.

convenient point, which may be closed for the transmission of the current, or opened for its interruption, in various ways, as by a *switch*, or a spring operated by a *push-button*. The switch, in its simplest form, as shown in Fig. 1, is a strip of brass or copper which can be turned

on a hinge by an insulating handle, and forms part of the circuit, which can thus be opened or closed. They are made in a great variety of forms adapted to various uses, some of them of very elaborate construction, but all on



Fig. 2.

the same general principle. The push-button, shown in Fig. 2, is well known in connection with the electric bell: a brass spring which forms part of the circuit closing the open-

ing when pressed by an insulating button of hard-rubber, porcelain, or fiber,—the whole inclosed in a cap made in a great variety of ornamental designs.

When a circuit is arranged to be kept closed constantly by a switch when in use, as in electric lighting and many other kinds of electric work, it is known as a *closed circuit*; but when arranged to remain open most of the time, and be closed and opened alternately in rapid succession when in use, as in the ringing of electric bells, it is known as an *open circuit*.

ELECTRIC INDUCTION.—There is a certain kind of electric transmission which has received the name of induction, which occurs between an electrified body and other bodies in its vicinity, from which it is insulated. This body may be a conductor through which a current of electricity is flowing, or a body electrified in some other way, as by a charge from a glass-plate electric machine, or by friction, as when a rod of hard-rubber or a stick of

sealing-wax is rubbed, or by a natural charge, as that acquired by a thunder-cloud.

Induction can occur only when the electrified body is insulated, otherwise the transmission would be through a conductor, as already described : so that it is impossible to insulate against it, as this influence traverses not only the insulating substance by which the electrified body is immediately surrounded, but all other bodies within its range, whether conductors or non-conductors,—the resistance which it encounters in different bodies being in similar proportion to the resistance encountered in other transmission, though far less in degree.

Another very remarkable peculiarity of induction is this: that it produces in conductors which come within its influence an electric potential opposite to that in the body from which it proceeds,—positive potential in the one producing negative potential in the other, and negative producing positive. A positively electrified cloud, for instance, floating in the insulating air, produces negative potential in the earth beneath it; and a negatively electrified cloud, positive potential in the earth: so that a lightning-stroke would, in the first instance, be from the cloud to the earth, and, in the second, from the earth to the cloud.

From this we must infer that the electricity, in passing through the insulating medium by which it is immediately surrounded, undergoes a change, so that it repels electricity from surrounding bodies, when the potential of the electrified body is positive, or attracts it when negative, as exemplified in the case of the cloud and the earth; the tendency being to so balance the positive and negative between the electrified body and the bodies within its inductive influence, by making the positive potential of

the one equal to the negative potential of the other, that electric transmission between them, through a conductor, would produce perfect equilibrium.

This electric influence, traversing both conductors and non-conductors, is strong proof of the existence of a medium which permeates both, and indicates that the ether, already described, is that medium.

DIELECTRICS.—It should be remarked that non-conductors, or insulators, when referred to in connection with induction, are called *dielectrics*, a word intended to signify that electricity can pass through them in the manner described.

A curious effect of induction, which has a most important practical bearing, is that when wires traversed by electric currents are placed in each other's vicinity, as in telegraph and telephone lines, the inductive effect of each current is to reduce the strength of the current in any adjacent wire, when both currents flow in the same direction, or to increase it when they flow in opposite directions. The reason of this is that the flow of an electric current is always from positive potential to negative, so that the positive potential of each wire creates a limited degree of negative potential in the adjacent end of the other wire, and the negative potential at the opposite end of each creates a limited degree of positive potential in the adjacent end of the other; and this condition tends to produce a current flow in each in the opposite direction to that of the current which induces it, by which the strength of the original current is reduced when it flows in the same direction as the inducing current, but increased when it flows in the opposite direction.

The inductive influence is radiated equally in all directions from the electrified body, just as light is radiated

from a lamp, or heat from a stove; so that each body coming within this influence receives only so much of the limited quantity of electricity radiated as is contained in the rays which it intercepts. A body one foot distant receives four times as much as one two feet distant, because it intercepts four times as many of the diverging rays; or nine times as much as one three feet distant, because it intercepts nine times as many rays: from which we derive the law that induction varies *inversely* as the *square* of the distance—that is, the greater the distance, multiplied into itself, or squared, the less proportionally is the induction. Hence it will be seen that a wire will receive only a very small part of the inductive influence radiated equally all around from an adjacent wire one or two feet distant.

NATURAL ELECTRIC DISTRIBUTION.—When we speak of electrified bodies, the expression should be understood in the same relative sense as we speak of heated bodies, meaning thereby bodies whose temperature has been raised above the average temperature we are accustomed to find in such bodies. But as all bodies possess a certain natural quantity of heat in different degrees under varied conditions, so all bodies possess a certain natural quantity of electricity in different degrees under varied conditions; and we have an atmosphere of high or of low electric potential, just as we have an atmosphere of high or of low heat potential—that is, a hot or a cold atmosphere. And we find natural electric currents both in the earth and atmosphere, and areas of high or low electric potential, just as we find similar natural warm or cold areas, or currents of warm or cold air or water.

Familiar examples of such areas of high electric potential are seen in the aurora, and of electric currents in the

shooting rays which emanate from the auroral arch, and the earth currents which always accompany the auroral display and produce disturbance in telegraph lines. And, in the thunder-cloud and the inductively electrified earth beneath it, we have a familiar example of more limited electrified areas; and, in the vivid chain-lightning, of a transient electric current.

In the electric equilibrium which ordinarily prevails in all bodies by which we are surrounded, the presence of electricity is not perceived, just as, under similar conditions, the force of gravity is not perceived; and it is only when these conditions are disturbed, either by natural means, as in the aurora and the thunder-cloud, or by artificial, as in the battery and the dynamo, and a difference of electric potential produced, that we become conscious of the presence of electricity; just as we become conscious of the force of gravity in the falling weight, when a difference of gravity potential has been produced.

It cannot reasonably be doubted that this all-pervading force is an important element in the animal economy, and that our health and vigor, our physical and mental states, are largely dependent on electric conditions, internal and external. Intelligent physicians have come to recognize its importance in the treatment of disease, and to employ it as a valuable remedy. And as its physiological relations come to be more fully understood, its value as a remedial agent will doubtless be more fully appreciated.

Its influence in the vegetable economy is doubtless as great as in the animal, and the life and vigor of the growing plant are probably largely due to this influence; so that the field for electric experimental research may

yet be found full of important revelations both to the botanist and the physician.

MEASUREMENT OF ELECTRIC PRESSURE AND CURRENT VOLUME.—Electric pressure is measured by a meter, just as steam pressure is measured by a gauge; and current volume is measured by a similar meter differently applied. One of the most common instruments for the former purpose is shown in Fig. 3, and its internal construction in Fig. 4.

VOLT-METER.—A brass case, shown in Fig. 3, incloses a steel magnet of the same shape as the outside of the case, its two poles terminating in the narrow space in front, as shown in Fig. 4. These poles produce what is called a *magnetic field* within this space—that is, a space permeated by a strong magnetic influence; lines of magnetic energy, which is similar to electric energy, traversing it continually from pole to pole.

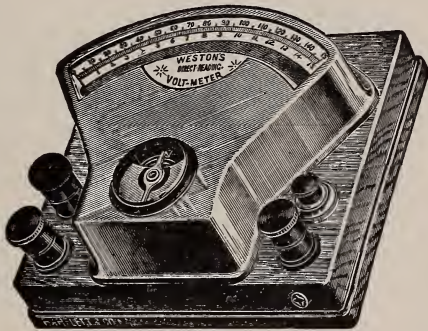

Fig. 3.

In order to make this field as strong as possible, and to distribute this influence just where it is wanted, two soft iron pole-pieces are attached to the poles, as shown, which inclose a circular space in which is mounted, in a fixed vertical position, a soft iron cylinder. The magnetic lines traverse the iron pole-pieces and cylinder much more easily than they would traverse a similar space filled with air, and produce strong magnetic in-

duction, which is similar to electric induction, in the narrow air-space between the cylinder and pole-pieces. Within this space a coil of fine insulated copper wire, wound on a light copper frame, is mounted, as shown,

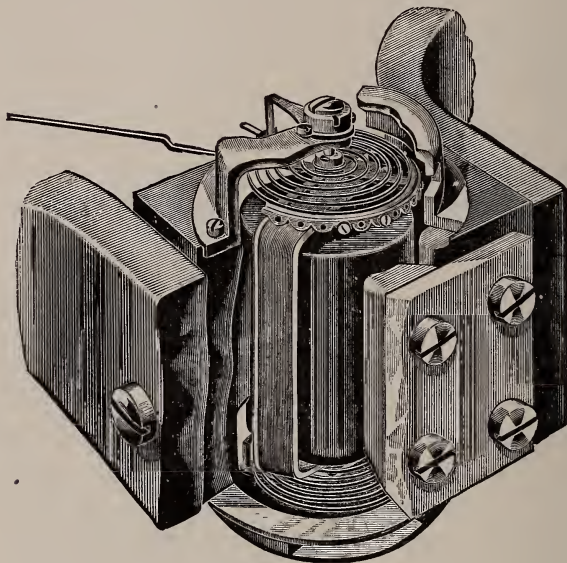

Fig. 4.

and has a limited rotary motion in opposition to the force of the two oppositely coiled flat spiral springs shown above and below, by which a light aluminum pointer, shown at the left above, is moved to the right over the graduated scale shown in Fig. 3.

This coil is connected, through the two springs, with the electric circuit at any point where it is desired to measure the electric pressure,—the connection being made by the binding-posts shown on opposite sides in Fig. 3; the instrument being always placed between the two

wires of the electric circuit, so that the current, or rather a very small fraction of it, must flow through the coil, across from the positive to the negative wire, and thus show the difference of potential which produces the electric pressure at that point.

When the circuit is closed for a moment by a contact key, and the current flows in this way, the coil tends to rotate into a position in which the current shall cross the greatest number of lines of magnetic force flowing from pole to pole; and this rotation being always in exact proportion to the electric pressure, in opposition to the force of the springs, is indicated on the scale shown in Fig. 3, in degrees, each of which represents the electric pressure unit known as the *volt*. Hence this instrument is called a *volt-meter*.

There are two scales shown, the outer one indicating volts, and the inner one twentieths of a volt, by degrees of corresponding width; and the current flows through a coil of wire of high resistance, not shown, which is made a part of the circuit through connections with each of the two binding-posts shown on the left,—this coil being tapped at different points, so as to include a long section and hence high resistance, for strong pressure, indicated in volts on the outer scale, when connection is made with the front binding-post; or a shorter section, and hence lower resistance, for weaker pressure, indicated in twentieths of a volt on the inner scale, when connection is made with the rear binding-post.

Back of the right binding-post is shown the contact key referred to above, by which the circuit can be closed when the instrument is in use. There is also a coil connected with this key, by which the instrument can be regulated, or *calibrated*, as this regulation is called.

AMMETER.—In Fig. 5 is shown an instrument of similar construction, but much simpler, by which the volume of the electric current is measured. This instrument has no resistance coil, and only one scale, and hence requires

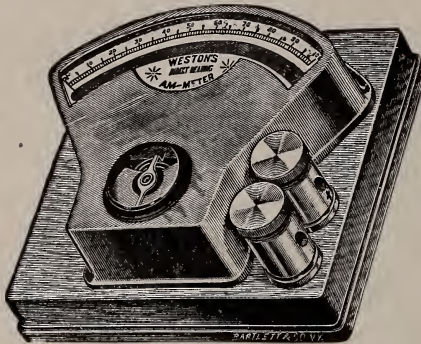

Fig. 5.

only the two binding-posts shown on the right. Its copper coil is of coarser wire, and therefore carries a current of greater volume; and the instrument is not connected with opposite circuit-wires, like the volt-meter, but directly

in the circuit, so that the whole current can flow through it, and therefore it shows current volume and not electric pressure. This is indicated in degrees on the scale, each of which represents the electric current unit known as the *ampere*. Hence this instrument is called an *ampere-meter*, or, briefly, an *ammeter*. The ammeter is often permanently connected with the electric circuit, but the volt-meter is usually connected only while making tests to ascertain the electric pressure. But volt-meters of special construction, known as *potential indicators*, are permanently connected.

ELECTRIC UNITS.—Electric units are as necessary in electric measurement as units of weight, money, length, or area, in our ordinary transactions; and, like the pound, the foot, the dollar, are the standards to which we constantly refer, and by which we form comparative estimates, and make electric calculations. The three princi-

pal electric units, and the only ones necessary to define at present, are the *volt*, the unit of electric pressure, the *ohm*, the unit of electric resistance, and the *ampere*, the unit of electric current strength.

The volt represents an electric pressure nearly equal to that of a Daniell battery cell, described in Chapter III.

The ohm represents the electric resistance which would be encountered by an electric current flowing through a column of pure mercury, at the temperature of 0° Centigrade, 106 centimeters in length, and 1 square millimeter in cross-section; or, to make this more intelligible to the ordinary reader, such a column, at the temperature of 32° Fahrenheit (or freezing-point), $41\frac{73}{100}$ inches in length, and about $\frac{155}{100000}$ of a square inch in cross-section. This would resemble the column of mercury in an ordinary thermometer, increased to $41\frac{73}{100}$ inches in length.

The ampere represents the volume of a current produced by a pressure of 1 volt flowing through a conductor having a resistance of 1 ohm.

CHAPTER II.

STATIC ELECTRICITY.

ELEMENTARY PRINCIPLES.—Static electricity does not differ in its nature from electricity in any other form; but is called *static* because it does not usually flow continuously in currents, as electricity in other forms, but is accumulated in condensers, from which it is discharged instantaneously; a striking example of which we have in the thunder-cloud. In this respect it may be compared to water accumulated in a lake or reservoir, while current electricity may be compared to water in a running stream.

It was under this form that electricity was first discovered, and for more than two thousand years remained undeveloped, without attracting any attention, except as a curious property supposed to belong to only one or two substances, and having no practical value whatever. Its first discovery was in connection with amber, which when rubbed was found to have the power of attracting light bodies. Hence this property was called electricity, a name derived from *elektron*, the Greek name for amber. It was subsequently discovered that this property could be developed by friction in jet also; and about the year 1600 it was found by Gilbert, an English scientist, in a large number of substances, prominent among which were sulphur, glass, and sealing-wax.

It was also found that while bodies electrified in this

way attracted unelectrified bodies, they repelled them after a moment's contact, or as soon as the attracted body acquired the same electric potential as the attracting body. This curious effect was extremely puzzling to scientists, and gave rise to different theories as to the nature of electricity to account for it. But the simple fact, fully verified by observation, that repulsion results from equality of electric potential between bodies, and attraction from difference of electric potential between them, accounts for both phenomena in a perfectly rational and satisfactory manner.

About the year 1750, Otto von Guericke, a German scientist, conceived the idea of generating electricity by the friction of the hands on a rotating globe of sulphur; and this was the first electric machine. Newton substituted a glass globe for the sulphur globe; and various other improvements followed, a glass cylinder being substituted for the globe, and afterward a glass plate for the cylinder,—the friction being produced by a pair of leather cushions instead of the hands. A condenser for collecting the electricity was also added, which at first was simply an insulated iron tube, for which an insulated cylinder or globe of brass was afterward substituted.

FRICTIONAL ELECTRIC GENERATOR.—The frictional electric machine thus gradually developed is shown in its latest improved form in Fig. 6, and is constructed with a circular glass plate mounted on insulating wooden or glass posts, and having a crank by which it can be rotated. On the right of this plate is a pair of *rubbers*, made of leather-faced cushions smeared with an amalgam of tin, lead, and mercury, made into a paste with lard. These are pressed against the plate by a pair of brass springs having a bolt and screw to adjust the pressure,

and are attached to an insulating glass post surmounted by a brass ball. On the left is a brass globe employed as a condenser, and known as the *prime conductor*, which is insulated on a glass post; and from a brass ball below

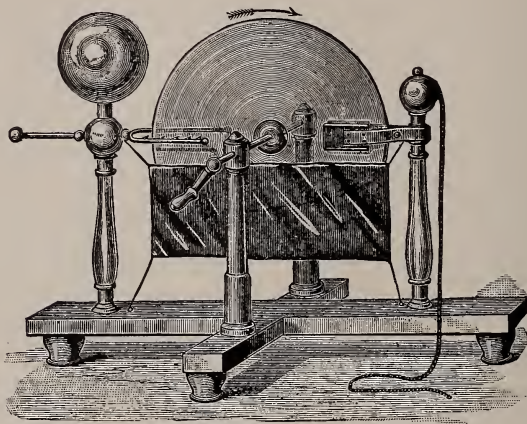

Fig. 6.

it a pair of brass *combs*, with sharp points for collecting the electricity, project to the right on opposite sides of the plate; a brass rod terminating in a ball projecting in the opposite direction, for convenience in connecting apparatus with the machine.

When the plate is rotated by the crank in the direction indicated by the arrow, a difference of electric potential between it and the rubbers and parts connected with them is produced by the friction; electric energy being transferred from the one to the other, so that the one becomes positive to exactly the same degree as the other becomes negative.

It is generally assumed that this transfer of energy is from the rubbers and connected parts to the plate, mak-

ing the plate positive and the rubbers negative; the supply of electric energy being obtained from the earth through the conducting chain shown on the right. But if the transfer is in the opposite direction, as may be the case, making the plate negative and the rubbers positive, then electric energy must pass to the earth through the chain.

The lower half of the plate is enveloped in an insulating silk bag, by which the electric charge, whether positive or negative, is confined to its surface; and when this charged surface comes round to the combs, the charge is transferred by them to the prime conductor; electric energy passing from this surface, if positive, or to it, if negative,—the charge thus acquired by the prime conductor being just as strong in the one case as in the other. By transferring the chain to the prime conductor, the relative electric potential of it and the rubbers is reversed.

Pointed combs are employed to collect the electricity, because a point, having no surface, has no electric resistance; so that electricity flows freely either to it or from it. But globes and balls are employed in this machine and elsewhere to confine the electricity by their surface resistance, because a globe, having neither angles nor edges, has the highest surface resistance, and electricity in the static form always collects on the surface of charged conductors, and in the current form tends to the surface, being repelled from the interior by the equality of potential in the charged body, and attracted outward by the difference of potential between this body and surrounding bodies, in accordance with the principle already given; so that its tendency is to escape through the air to surrounding bodies,—points, angles, and edges facilitating

this escape. Hence they should be avoided in the construction of electric generators and other electric apparatus, except where strictly required.

The quantity of electricity generated by this machine is comparatively small, and hence the machine is not adapted to any practical use, and is employed only to illustrate the principles of electricity; and even for this purpose it is now but little used, having been superseded by generators of static electricity of much higher electric efficiency; so that it has now little more than a historic value.

THE LEYDEN JAR.—Before describing these improved generators, it is important that the apparatus known as the *Leyden jar* should be described. This apparatus, which derives its name from the place of its discovery, is shown in Fig. 7, and consists of a glass jar coated inside and

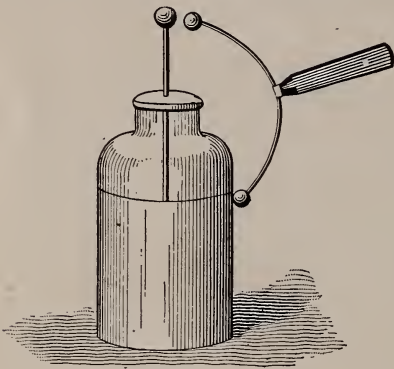

Fig. 7.

outside with tinfoil, or some other thin sheet-metal, except three or four inches at top, left uncoated for insulation between the coated surfaces. This jar is closed with an insulating cover, through which a brass rod extends to the inside coating, and terminates above in a ball.

When a charge of electricity is given to the inside coating through this rod, by an electric machine, the outside coating becomes oppositely charged by induction, when connected with the earth or with the oppositely charged part of the machine.

In this way a charge of very high electric energy may be accumulated, varying in proportion to the area of coated surface. This surface may be produced in a single jar, or in a number of jars connected together as a *Leyden*

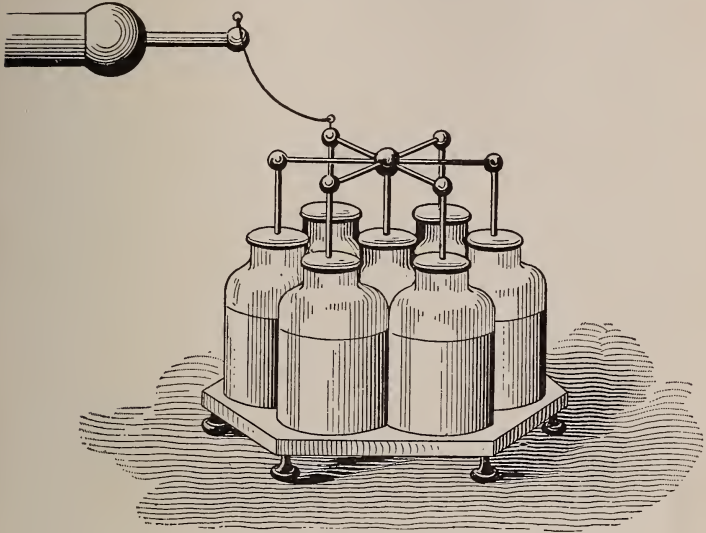

Fig. 8.

battery, as shown in Fig. 8, by connecting together all their inside coatings by conductors attached to the rods, and likewise all their outside coatings in any convenient manner, as by a sheet of tinfoil,—the two surfaces thus becoming practically the same as those of a single jar having the same area of coated surface.

The glass in such a jar must be of the best insulating quality, either green glass or flint, having no lead or other conducting substance in its composition. It is not essential that it should be in the form of a jar, except for convenience in use; a glass plate or cylinder coated in

the same way being capable of receiving a similar charge. It is also immaterial whether the coating is cemented to the surface, as is necessary with a flexible coating like tinfoil, or is merely kept in contact with it, as may be done with a rigid coating like sheet brass.

When a connection is made between the inner and outer coatings of a charged jar or battery, as may be done with a curved brass rod with an insulating handle, called a *discharger*, as shown in Fig. 7, there occurs an instantaneous transfer of electric energy from the coating positively charged to the one negatively charged, accompanied with a bright spark and a loud report, as this energy rushes through the resisting air between the knob of the jar and the knob of the discharger. The transfer is *from* the inside coating, if positively charged, or *to* it, if negatively; equality of potential between the coatings being thus restored, except a small *residual* charge which remains in the glass, and may be discharged in a similar manner after a few moments of rest,—several such residuals, of constantly decreasing energy, being often obtained in succession. This proves that the charge produces an electric strain in the insulating glass, requiring time for the glass to resume fully its original condition.

If the glass is thin at any point, it may not have sufficient strength to resist this strain when the jar is heavily charged, and a discharge producing a small perforation, in which the glass becomes pulverized, surrounded by a star-like fracture, is liable to occur, which destroys the jar for future use. A spontaneous discharge without perforation is also liable to occur over the uncoated surface, in case of an overcharge.

A jar may retain its charge for several hours in a dry

atmosphere, being meantime slowly discharged through the air. But it is quite impossible for either surface to be discharged, either instantly through a discharger, or slowly through the air, without producing an equal change of potential on the opposite surface, electricity always passing from the positive surface to the negative. Hence the charge on either surface, whether positive or negative, is said to be *bound* by the opposite charge.

The discharge from a small jar, no larger than a half pint, passed through the body, will produce a very severe shock; and a sufficient charge can be accumulated in a large battery, or a single jar having an equal area of coated surface, to kill a man; instances being on record of eminent scientists who were killed or injured in this way. But a full charge from a large battery may be passed harmlessly through the body if received through the point of a fine sewing-needle held in the hand; the discharge, in such case, being gradual and silent, instead of instantaneous, with spark and report, as when passed through the ball-tipped discharger,—forcibly illustrating the difference of electric resistance between a point and a globe or ball, as already explained.

INFLUENCE MACHINES.—In 1865 Dr. Holtz, a German scientist, invented a machine in which electricity was generated by the inductive influence of two glass plates on each other, after a small initial charge, generated by friction on a piece of hard-rubber, was given to one of them. This machine was a far more powerful generator than the frictional machine, as it could accumulate a much greater charge; and was constructed with a great deal of care, its construction including many important features which have since been extensively copied, producing a class of similar generators known as *influence* machines.

The principal defect in the Holtz machine was its lack of constancy and reliability as a generator under unfavorable atmospheric conditions, the initial charge being rapidly dissipated in a damp atmosphere, so that the machine would either entirely fail to generate, or would cease while in operation by a sudden change of atmospheric conditions.

THE ATKINSON TÖPLER-HOLTZ MACHINE.—To remedy this defect, Töpler, another German scientist, constructed, about the same time, a similar machine in which the initial charge was constantly sustained by frictional apparatus connected with the machine itself, making it self-exciting. This machine, to which some minor improvements were added by a mechanic named Voss, was further improved by the writer, to whom United States patents protecting these improvements were granted in 1883 and 1885. Its construction will be easily understood from Fig. 9.

Two glass plates, *A* and *B*, well coated with shellac, are mounted vertically on a wooden stand, within about a quarter of an inch of each other. *B*, whose diameter is about two or three inches greater than that of *A*, is supported on insulators in a fixed position, and known as the *stationary* plate; and *A* is attached to a central insulating hub, supported on a spindle which passes through a large hole in the center of *B*, and is attached to a post in the rear; so that this plate can be rotated by a driving wheel and belt, as shown, and is therefore called the *revolving* plate.

Both these plates are made of the best insulating sheet glass, and being on independent insulating supports, are entirely insulated from each other. All the insulators are made of hard-rubber, and the base and post of kiln-dried wood, which is also an insulator of medium quality.

On the rear of plate *B* are cemented two paper *inductors* *X* and *T*, under each of which is cemented a pair of tinfoil disks connected by a tinfoil strip, and each pair connected separately, by similar strips, with the brass wire

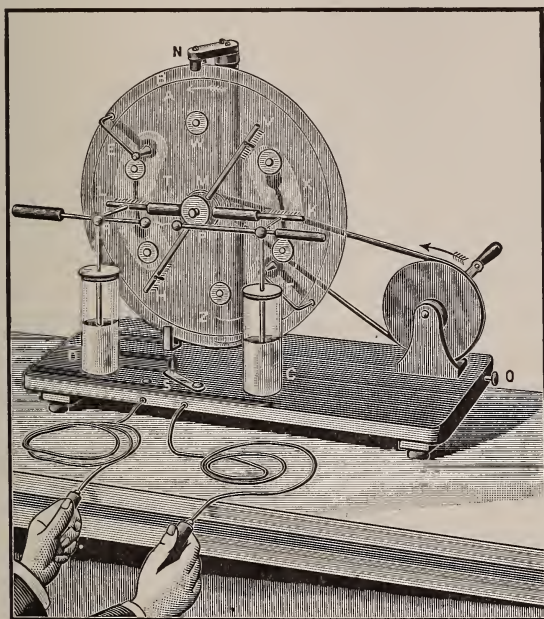

Fig. 9.

brushes E and *F*. And on the front of plate *A* are cemented six disks of sheet brass, called *carriers*, having raised centers which make contact with the brushes when the plate revolves, generating the initial charge.

Two brass combs, *K* and *L*, are supported opposite the inductors, in a horizontal position, by insulating rods attached to a central insulating disk *M*, and are connected by brass rods with the inside coating of two Leyden jars

C and *D*. And attached to the same disk, at an angle of 45 degrees with the horizontal combs, are two brass combs *V* and *H*, electrically connected with each other, through the disk *M*, by attachment to a brass center; and to each of these is attached a brass wire brush, which, like the other pair of brushes, makes contact with the carriers.

Attached to the knobs above the jars are two brass sliding-rods *P* and *R*, having insulating handles. These rods can be brought into contact or separated to any required extent, and are employed as dischargers.

The outer coatings of the jars are made of sheet brass, and connected, under the base, by copper wires, to the switch *S*, through which, when closed, an electric discharge can pass between the coatings, or by opening which it can be diverted through connecting sockets and flexible conducting-cords so as to pass through a person holding the terminal handles, or through any piece of apparatus connected with the terminals of these cords.

When the switch is closed, the sliding-rods separated, and the plate *A* rotated in the direction indicated by the arrows, a small initial charge is generated by the friction of the brushes on the carriers, electric energy being transferred either from the carriers to the inductors, or oppositely, during their momentary connection through the brushes. If inductor *X*, for instance, receives electric energy from carrier *Z*, then the potential of *X* becomes positive, and that of *Z* relatively negative, while these conditions are reversed between inductor *T* and carrier *W* by the friction produced at the same instant; *T* becoming negative, and *W* relatively positive, by the transfer of energy in the opposite direction.

As *Z* with its negative charge moves up past the comb

K, electric energy flows to it, through this comb, from the inside coating of jar *C*; and as *W*, at the same instant, moves down with its positive charge past the comb *L*, electric energy flows from it, through this comb, to the inside coating of jar *D*. Hence the inside coating of *C* becomes negative and that of *D* positive, and their outside coatings become oppositely charged by induction; electric energy being repelled from the outer coating of *D*, through the switch and its connections, to the outer coating of *C*, making that of *D* negative and that of *C* positive.

But each of these carriers has a residual charge left in it, after passing the insulated comb, which is increased by the influence of the inductor opposite which it passes; so that *Z* arrives at comb and brush *V* with a negative charge, and *W* at comb and brush *H* with an equal positive charge. But as combs *V* and *H* are connected together by conductors, there is an instant transfer of electric energy from *W* to *Z*, through these connected combs, and equality of potential is almost completely restored between them; so that *W* comes round to brush *F* and *Z* to brush *E* with only a very slight residual, and the previous process is again repeated.

Now as there are six carriers, each of which goes through this process at each full revolution of the plate, becoming alternately negative and positive at each half revolution, and contributing its quota to the opposite charges accumulating on the inductors and opposite coatings of the two jars, it is evident that at the end of the first revolution the initial charge will be six times as great as at first, and the inductive influence of the inductors and carriers on each other, which has meantime been accumulating in geometrical ratio, will be many

thousand times as great. And as the plate makes about five revolutions per second, at ordinary speed, the rate of increase of the inductive charge by continual multiplication into itself becomes enormously great, even at the end of the first second; so that the initial charge, at first imperceptible, spreads from the tinfoil to the paper inductors, and thence over the surface of the stationary plate; and, in like manner, from the carriers over the surface of the revolving plate, till the electric pressure, amounting to many thousand volts, equals the resistance of the insulating parts of the machine and the surrounding air,—opposite surfaces, and opposite halves of the same surface, in both plates, becoming oppositely charged. The charge spreads over the insulating surfaces with a crackling noise, and, in the dark, brushes of light may be seen streaming from or to the combs.

SPARK DISCHARGE.—When a sufficient charge has accumulated to overcome the electric resistance of the air between the sliding-rods, a discharge occurs, accompanied with a spark and report; electric energy being transferred from the positively charged inner coating of one jar to the negatively charged inner coating of the other, with corresponding restoration of equality of electric potential in all parts of the machine. If the transfer of electric energy during the accumulation of the charge is in the direction which has been assumed, as it usually is, then the discharge will be from the inside coating of *D* to that of *C*—that is, from *R* to *P*. But if the transfer is in the opposite direction, as frequently happens, then the discharge will be from *P* to *R*.

The reason why there should be a transfer of electric energy in any given direction rather than in the opposite direction during the accumulation of the charge, is not

entirely clear, but is partly accounted for by a difference of insulation of the parts. The upper parts of the plates, where brush *E* is attached, being better insulated than the lower parts, where brush *F* is attached, by their greater distance from the base and adjacent objects, is probably the reason why jar *D* usually acquires a higher charge than jar *C*, and a positive charge on its inside coating; the rotation of the upper part of plate *A* being toward jar *D*, and that of its lower part toward jar *C*, each jar receiving its charge from that part which rotates toward it.

The length of the spark, as measured by the distance between the knobs of the sliding-rods, which also measures the resistance of the air, varies as the electric pressure of the charge. By increasing this distance in proportion to the pressure, the highest pressure obtainable from a machine may be ascertained. This, as indicated by the spark, varies as the diameter of the plates and the insulating quality of the glass; the spark length ranging from $4\frac{1}{2}$ inches in machines with plates 14 and 16 inches in diameter, to $7\frac{1}{2}$ inches in machines with plates 25 and 28 inches in diameter.

The frequency of the spark, at a given rate of speed, must be taken in connection with its length as an indication of the full electric efficiency; and this varies as the number of plates of a given size in the machine and the area of coated surface in the Leyden jars.

FOUR-PLATE MACHINE.—Machines of this kind may be constructed with as many pairs of plates, combs, and brushes as can be conveniently combined together; four-plate machines being common, in which the relative positions of each pair of plates are reversed, as shown in the sectional view of such a machine in Fig. 10; the

two stationary plates, with their rear surfaces turned toward each other, being placed between the two revolving plates, which have their carrier-bearing surfaces

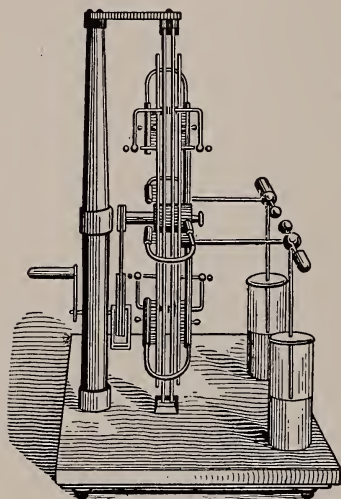

Fig. 10.

turned to the front and rear. This is, in fact, a double machine, with a single pair of Leyden jars and discharging-rods. Eight-plate machines may be constructed by a similar combination of two four-plate machines; but no increase of electric efficiency can be obtained by the mere multiplication of plates without a corresponding multiplication of combs, brushes, carriers, and inductors.

The frequency of the spark, with a given number of plates, varies as the area of coated surface in the Leyden jars: the smaller this area, the more frequent the spark, and the less proportionally is its energy; and the larger this area, the less frequent the spark, and the greater proportionally is its energy.

Electric pressure is not dependent on the number of plates, but on their diameter; being no greater in a four-plate or an eight-plate machine than in a two-plate having plates of the same diameter.

Length and frequency of spark are only rough indications of electric efficiency. No instrument has yet been invented for accurate measurement of the full electric efficiency of these machines; but approximately accurate

measurement of their electric pressure may be ascertained by an instrument known as the *electrometer*.

STATIC INDUCED CURRENT.—When a discharge occurs between the inner coatings of the jars through the sliding-rods, there is an equal discharge in the opposite direction, between the outer coatings, through the switch and its connections, which may be shown by a spark below, between the switch terminals, simultaneous with the spark above, when the switch is open so as to leave an air-space of half an inch or less between its terminals. This discharge may be changed to an intermittent, pulsating current, by having the sliding-rods separated very slightly and the switch open to the same limited degree, producing a succession of very rapid discharges, which gives the lower spark the appearance of being continuous. This current may be diverted through the conducting-cords, as already shown, by opening the switch fully; and the strength of the pulsations may be varied in the same proportion as their frequency, by varying the distance between the sliding-rods.

It is often employed for medical purposes, and may be made as mild and smooth as required for the most delicate case, by a very slight separation of the sliding-rods, producing a correspondingly rapid discharge, or as powerful as the strongest nerves can bear, by a wider separation, giving a correspondingly slow discharge, with proportionally greater accumulated energy. It may be transmitted through any part of the body included between suitable electrodes, for any medical purpose which, in the opinion of the physician, may be required, as for instance the production of muscular action in paralysis.

The direction of this current, when thus employed, is

often of great importance, the application of the positive electrode to the affected part giving relief, but the application of the negative electrode producing irritation.

BRUSH DISCHARGE.—A highly instructive and exceedingly interesting brush discharge may be produced between the sliding-rods, when they are separated three or four inches and the switch fully opened, which can be seen best in a darkened room at night. Brushes of light from the knobs radiate toward each other with a hissing sound: that from the positive side having a reddish color and much greater prominence than the other, branching into a variety of fantastic forms; while that from the negative side is less prominent and of a bluish color, and undoubtedly merely represents the concentration of the discharge from the opposite side,—the change of color indicating loss of energy in the discharge in overcoming the resistance of the air.

The cause of this brush discharge is the comparatively slow movement of electric energy between the outer coatings of the jars, through the partially insulating kiln-dried wood of the base, producing corresponding slowness of electric movement between the inner coatings through the air, during which there is time for radiation of the discharge toward the central point and its concentration on the opposite knob.

The spark, on the contrary, is the result of an instantaneous discharge of electric energy through the air, corresponding to a similar discharge through the closed switch; during which the narrow line of highly resisting air, through which this discharge occurs, is heated to incandescence. The white light of the spark is therefore due to the intensity of molecular motion produced in this narrow air-line during an exceedingly brief instant; and

the red and blue lights of the brush discharge to the much lower intensity of molecular motion diffused over a very much larger air-space, and occurring in a proportionally longer time: just as a small wire may be quickly heated to incandescence in the flame of a lamp, while the same quantity of heat, applied more slowly to a larger wire, would produce only a red heat; and, if applied near one end, this color would become darker toward the other end.

REPORT.—The report which always accompanies the static spark discharge is due to the instantaneous, violent molecular motion of the air in the line of discharge. This line of air is the medium by which the electric energy travels, and its motion is believed to be in the form of transverse vibrations, which produce undulations, or sound-waves, in the surrounding air, similar to those which would be produced by the instantaneous vibration of the string of a musical instrument instantaneously checked.

The old theory that this report is produced by a collapse of the air, such as occurs in the partial vacuum produced by an explosion, is inconsistent with the theory of electricity being a mode of molecular motion,—the motion, in this case, being that of the air itself; the slight expansion produced by the sudden heating of this narrow air-line, and the shrinkage from its comparatively slow cooling, being totally different from the instantaneous displacement and collapse of a large body of air, produced by an explosion of gunpowder, dynamite, or steam, and quite insufficient to produce the report.

DIRECTION OF ROTATION.—The rotation of the revolving plate, in this machine, must always be in the direction indicated by the arrow, so that the carriers, after receiv-

ing their initial charge from the insulated brushes, shall pass the insulated combs, and through them impart this charge to the jars, before passing the uninsulated combs and brushes by which the residual charges are discharged. Reversal of rotation would reverse this process, and the carriers, while passing the uninsulated combs and brushes, would lose the charge received from the insulated brushes, leaving only the residual charges to impart to the jars, which would be insufficient to charge the machine.

The brushes must touch only the raised centers of the carriers, and not the glass, to produce the best results.

THE WIMSHURST MACHINE.—This machine, named after its inventor, was first described in January, 1883, while the application for the writer's first patent on the machine just described was pending. It is constructed, as shown in Fig. 11, with two glass plates, of equal size, mounted vertically, about a quarter of an inch apart, on insulating hubs, on two standards supported on a wooden base. These plates are made to rotate in opposite directions by two belts, one of which is crossed, which are connected with two driving-wheels mounted on one shaft. Each plate has on its outer surface a number of carriers made of tinfoil strips, which radiate from near its center, and have small raised brass disks attached to them.

Two curved brass rods, *A B* and *C D*, are attached to the standards at the front and rear, in diagonal positions, as shown, and at right angles to each other, and each carries, at its extremities, two brass brushes, which make contact with the carrier disks and generate the initial charge.

Two pairs of insulated horizontal combs, *E* and *F*, each

pair connected with the inside coating of a Leyden jar, are mounted, as shown, so as to inclose opposite edges of the plates, extending toward their centers at the front and rear, with their teeth near the outer surface of each plate.

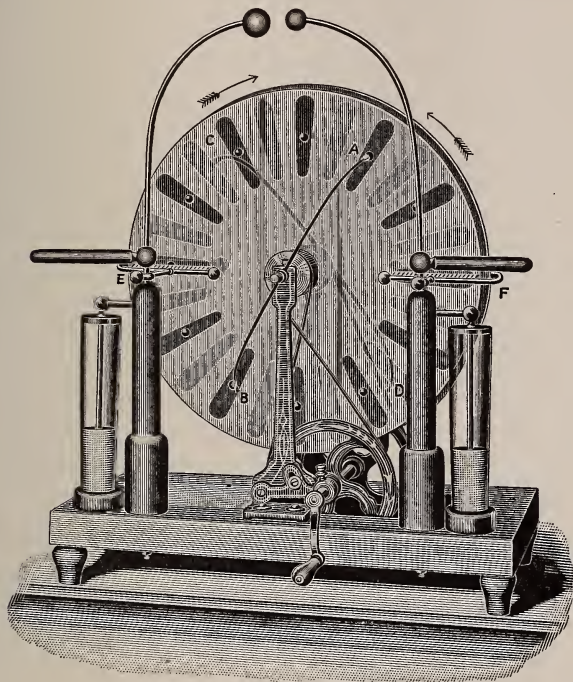

Fig. 11.

A curved discharging-rod is also connected with the inside coating of each jar, and extends upward over the plates, each rod terminating in a brass knob, one of which is much larger than the other. These knobs can be separated to any required distance, or brought into contact, by a rotary movement of the rods by the insulating

handles shown. The outer coatings of the Leyden jars are connected together under the base by copper wires.

When the front plate is rotated in the direction indicated by the arrow on the right, and the rear plate in the direction indicated by the arrow on the left, any opposite pair of carriers on the same plate, as *A* and *B*, become oppositely charged by the friction of the brushes. If *A*, for instance, becomes positive, then *B* becomes negative. But as the two plates act inductively on each other, these conditions are reversed on the rear surface of the rear plate, *C* becoming negative and *D* positive. But as carriers *A* and *C*, thus oppositely charged, rotate toward each other, and likewise *B* and *D*, and are followed by the other carriers, above and below, the charge is continually multiplied by induction, the upper front surface of the front plate becoming positive, and its lower front surface negative, while these relative conditions are reversed on the rear surface of the rear plate, and also on the opposite inner surface of each plate with reference to its outer surface.

As the upper front surface of the front plate moves downward past comb *E*, it imparts its positive charge to the inside coating of its connected jar, and as the lower rear surface of the rear plate moves upward past comb *E*, it also imparts its positive charge to the same coating. In like manner a negative charge is imparted to the inside coating of the jar connected with comb *F* from the lower front surface of the front plate and the upper rear surface of the rear plate, the outside coatings of the jars becoming oppositely charged by induction, by a transfer of electric energy through the connecting wire.

When the charge resulting from the difference of electric potential produced in this way becomes strong enough

to overcome the resistance of the air between the knobs of the discharging-rods, a discharge occurs in the manner already described in connection with the last machine.

The order in which the charge has been assumed to occur has been chosen arbitrarily, merely for convenience of description, and it is liable to occur in reverse order with the same direction of rotation and relative diagonal positions of the brushes. But no automatic reversal can occur while the machine is in operation, as often happens with the machine last described.

A reversal of rotation, with the brushes in the relative diagonal positions shown, would tend to produce equality of potential, instead of difference, in all the generating parts of the machine, and hence would not produce a charge. But if the relative diagonal positions of the brushes were reversed, then corresponding reversal of rotation would become necessary to produce a charge.

USES OF INFLUENCE MACHINES.—Influence machines are extensively used to illustrate the principles of electricity, and also for medical purposes; being employed not only to produce the static induced current for medical use, as already mentioned, but also to give an electric charge to a patient seated on an insulated platform.

This charge may be given by connecting the patient, by one of the electrodes, with the inside coating of one of the Leyden jars, while a ground connection near the platform is made by the electrode connected with the inside coating of the other jar. The charge thus received is distributed over the entire surface of the body, and its effect is to equalize the vital functions; quickening the pulse, if abnormally slow, or making it slower, if abnormally quick; acting as a sedative of abnormal nervous excitement, or increasing such excitement if ab-

normally low; and equalizing the bodily temperature in a similar manner. Patients afflicted with nervous diseases, such as *paralysis agitans* (St. Vitus's dance), may be relieved in this way; the same treatment is found to be beneficial for rheumatism also.

The electric energy may be concentrated on any part of the body of a patient thus insulated and connected, by applying the electrode used for the ground connection to the required part; sparks being drawn in this way through the clothing by means of a roller, ball, or point electrode, according to the nature and degree of electric concentration required.

By means of an electrode consisting of a single point, or a cluster of points, brought within close inductive distance of any part of the body, as the head or face, but not within sparking distance, a gentle breeze known as the *electric wind*, or *souffle*, may be produced, which has a very agreeable sedative effect; insulation of the patient receiving such treatment not being strictly necessary, though the effect is stronger with insulation, since there is no electric loss.

VACUUM TUBES.—Closed glass tubes in which a partial vacuum has been produced are an important means of showing the relatively lower electric resistance of rarefied air as compared with air at the ordinary density, and thereby illustrating important electric principles. The best tubes for this purpose are those invented by Crookes and Geissler. The air in the Crookes tubes is reduced to about $\frac{1}{1000000}$ of its ordinary density, and that in the Geissler tubes to about $\frac{3}{1000}$ of its ordinary density.

The general construction of the Geissler tubes, which are made in a great variety of forms, is shown in Fig. 12, and consists usually of a small glass tube, bent into any

convenient ornamental form, and inclosed within a larger one for security against breakage. Fine platinum wires are embedded in the glass, at each end of the larger tube, by which electricity can be transmitted through both tubes. When these wires are connected with the discharging-rods of an influence machine, a very beautiful discharge is transmitted, which fills the interior of the smaller tube, and is of a light reddish color terminating in a bluish color at its negative end, as in the brush discharge; various color-effects being produced by the composition of the glass, or by inclosed gases, liquids, or solids. The most brilliant effects are produced by an intermittent current, like the static induced current described on page 35, or the faradic, described on page 112.

This discharge, following the various convolutions of the smaller tube, may be three to six feet or more in length; and is easily transmitted this distance through air at the density maintained in the Geissler tubes; while a discharge through air at the ordinary density, with the same electric pressure, may

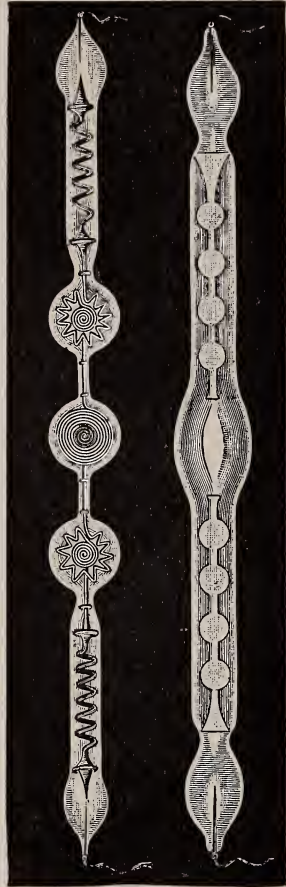

Fig. 12.

not exceed the same number of inches. But in the higher vacuum of the Crookes tubes, which are of somewhat similar construction, electric resistance increases with the vacuum, for the opposite reason—that is, from a want of sufficient air as the medium of transmission. And if it were possible to produce a perfect vacuum, devoid of everything except the ether, it is doubtful whether transmission through it, except by induction, would be possible.

The reddish color of the discharge in the Geissler tubes is due to the low resistance of the air and proportional diffusion of the charge and reduction of heat generated, as compared with the high resistance encountered by the discharge in air at the ordinary density, in which a narrow line of air is heated to incandescence.

LIGHTNING.—It is a most remarkable instance of the slow development of electric science in former times, that thunder and lightning were not recognized as electric phenomena till after their identity as such, and the means of proving it, were suggested by Franklin, and subsequently verified by himself and others; his celebrated kite experiment enabling him to obtain electric sparks from an insulated key connected with the wet kite-string, identical with those obtained from an electric machine, and to charge a Leyden jar with them.

The electric charge of the thunder-cloud is acquired, in much the same way as that of an influence machine, by an initial charge multiplied by induction. Evaporation has been suggested as the probable means by which this initial charge is generated, experiment proving that electricity can be generated in this way. It seems probable also that the friction of vapor-laden air with the earth's surface, and elevated objects, as trees, rocks, and build-

ings, with which it comes in contact when moving as a wind, should be an additional means of electric generation fully equal to that of evaporation, or perhaps superior to it.

The separate infinitesimal drops of water composing this vapor become separately electrified, the charge accumulating on their surfaces; and as these drops are condensed into larger drops, the extent of surface in proportion to volume is reduced, and the electric accumulation on this reduced surface proportionally increased. Two drops, for instance, condensed into one, have the same quantity of water and electricity as was contained in the two, but much less surface area on which this electric charge is accumulated, and hence proportionally higher electric surface potential. These drops continually attract smaller drops by their difference of potential, and thus condensation, with increase of potential, proceeds rapidly, and a thunder-cloud begins to form.

As this charged cloud is moved by the wind, it acts inductively on the earth's surface below it, and this surface acts inductively on it, the cloud becoming positive and the earth's surface negative; and thus the charge is inductively increased, in geometrical ratio, by continual multiplication into itself, in the same manner as the similar charge in influence machines is increased by the mutual induction of the plates; electric energy being continually attracted to the cloud from the surrounding air, and the same quantity repelled from the earth's surface below it. This accounts fully for the rapid formation of the thunder-cloud, and the enormous electric potential which it acquires.

When the difference of potential between the earth and the cloud becomes sufficient to overcome the resistance

of the air, the discharge which we call lightning occurs, usually from the cloud to the earth, taking the course of least resistance, which is usually between the cloud and some elevated object on the surface, preferably one which has a point or angle, or is a good electric conductor.

RETURN STROKE.—The charge is not evenly distributed in the cloud, electric energy tending to accumulate at the point where there is the highest induction, as between an elevated object and that part of the cloud nearest to it, making distant parts relatively negative; and when a discharge occurs, as above, this negative potential is instantly greatly increased, producing relatively positive potential in the earth below, which may result in such a difference of potential at this distant point as to cause a discharge from the earth to the cloud, termed the *return stroke*, shown theoretically in Fig. 13, which, like the downward stroke, follows the path of least resistance. Hence it is impossible to tell whether a stroke of lightning has occurred in a downward or an upward direction, the effect being the same in either case. This reaction may be such, even close at hand, as to produce sensible results, as when persons in the vicinity of an object struck by lightning feel the shock.

The concentration of electric energy at a given point, previous to the discharge, is shown in Fig. 13 by the arrows in the cloud and in the earth, and also by the branches in the cloud leading to the main line of discharge; and the diffusion of this energy in the cloud, which follows the return stroke, is shown by similar branches leading from the line of discharge.

The inductive influence of different thunder-clouds on

each other is the same as that between the cloud and the earth. There is always a difference of potential between them which attracts them toward each other, and this difference constantly increases as they approach each other, till the electric strain is sufficient to overcome the resistance of the intervening air, when a discharge occurs. Such a discharge between two clouds increases the difference of electric potential between each of them and other thunder-clouds in their vicinity, producing the series of discharges which often occur in rapid succession during a severe thunder-storm.

Lightning occurs in the same manner as the electric discharge of the machine, producing incandescence in a narrow line of air, often three to five miles or more in length, as measured by the known distance between mountain-peaks. When the line of discharge is visible, it is called *chain* lightning, illustrated by the two photographs of such discharges shown in Fig. 14; but when obscured by intervening clouds so that only the diffused or reflected illumination is seen, it is called *sheet* lightning; and when this illumination arises from distant clouds below the horizon, as often happens on warm summer evenings, it is called *heat* lightning. But these various appearances all have the same origin.

The crookedness observable in the line of discharge is doubtless due to the difference of resistance encountered at different points in the air, and the forked discharge to the mutual repulsion of air molecules charged to the same potential, and the attraction of the surrounding air, which is at a lower potential, similar effects being observable in the spark and brush discharges of the machine.

It should be observed that the line of discharge has no

sharp returning angles, such as are usually shown in artificial representations; also that the branches extend in various directions like the branches of a tree, so that those extending from the observer appear much fainter than those extending toward him, the appearance of being on a flat surface being the effect of perspective. The apparent vertical discharge, as shown in the lower photograph, is also probably the effect of perspective, the discharge having probably occurred in a horizontal direction, parallel with the earth's surface, and above the light cloud which partly obscures it, the water in the distance, which it seems to strike, merely terminating the horizontal view.

It is impossible to ascertain by observation the direction in which the electric energy moves in the line of discharge, as even the longest discharge occurs in an infinitesimally brief instant,—so brief that the entire line, which may be five miles or more in length, is seen at the same instant. We have a familiar illustration of this in a rapidly moving carriage-wheel, seen by a lightning-flash at night, which appears as if standing still, so that its separate spokes can be easily distinguished, which would be quite impossible if the flash occupied even the shortest perceptible period of time. Its apparent momentary duration is an optical illusion,—the impression made on the retina of the eye remaining for a moment after its cause has ceased; the flash revealing the wheel to the eye, and instantly ceasing, like the snapshot of a kodak, but infinitely quicker.

THUNDER.—The report which we call thunder is essentially the same as the report of the discharge in the machine or Leyden jar, and is produced in a similar manner,—not by the displacement and collapse of a

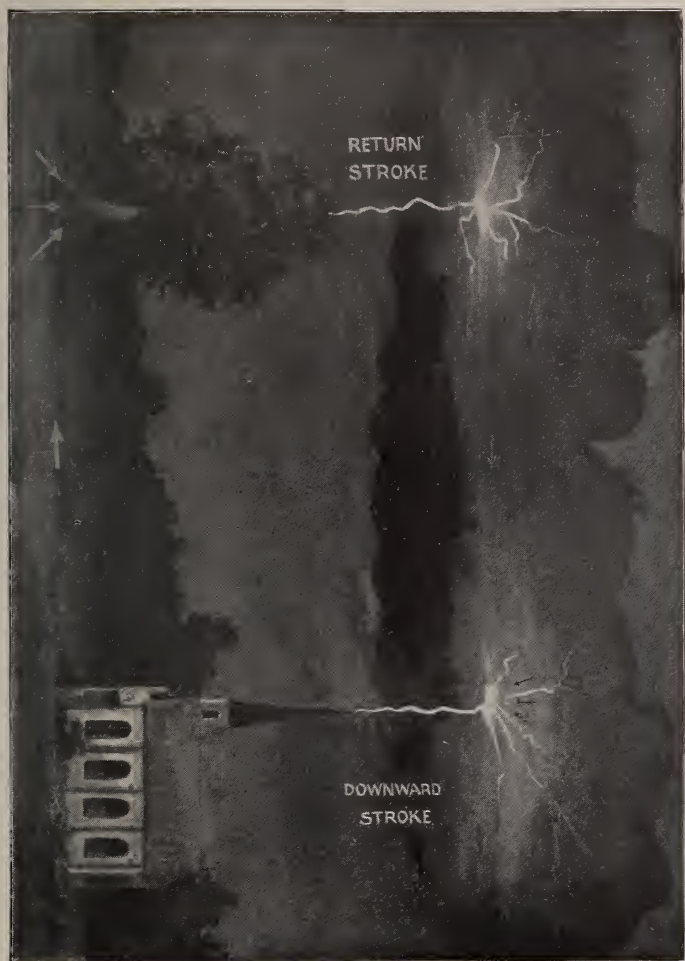

Fig. 13.



Fig. 14.

large body of air, as in an explosion, but by the instantaneous vibration of a long, narrow line of air. For the electric discharge indicated by the loudest thunder, even when close at hand, has no effect on window-glass, which would be shattered by the air displacement and collapse produced by an explosion giving a similar report.

The series of reports, decreasing in loudness, which usually follow each flash of lightning are attributed to a series of echoes between separate clouds, and also between the clouds and the earth, the latter being probably the loudest, since the under surface of a cloud becomes denser and more even than its upper surface, and hence, like the surface of the earth below it, better adapted to produce these echoes.

LIGHTNING-RODS.—The lightning-rod, proposed originally by Franklin, is undoubtedly a most efficient means of protecting buildings against lightning, when properly constructed; but when improperly constructed it is liable to become a fruitful source of danger.

Copper is the best material for a rod, since it has the highest electric conductivity of any of the base metals; its conductivity being more than six times that of iron, and nearly equal to that of silver, which is the highest. The rod should be large enough, in solid cross-section, to carry the heaviest electric discharge which can occur, without risk of being melted by its heat, or having any part of it enter the building. Its form and relative quantity of surface, about which many erroneous opinions have been promulgated, are of very little electric importance, since the charge is not confined to the surface, as was formerly supposed, but passes through its substance. Hence it may be solid or hollow, round, square, or flat,

and its surface smooth or corrugated, provided it has sufficient massiveness and conductivity.

It should be as free as possible from joints, which are liable to acquire high electric resistance from corrosion or imperfect construction, forming dangerous nodes from which electricity may escape into the building. Hence, wherever they are necessary, they should be so constructed as to have no higher resistance than the other parts; soldering or, better still, electric welding, being the only sure means of accomplishing this.

It should be attached to the building by conductors, not by insulators, as is often done, so that it may be in electric connection with every part, especially with masses of metal employed in construction, as gutters and cornices. And it should terminate above the roof in a sufficient number of points, sufficiently elevated to protect every part of the building; the space so protected being usually estimated to be that of a cone whose apex is the highest point of the rod, and the diameter of whose base is twice its height, there being no well-authenticated instance of damage by lightning within such a space. Hence, as many branches from the main rod as may be required by this rule should be erected on the roof, each having a main terminal point not so sharp as to be easily fused by a discharge, and connected with a circular cluster of sharper points a short distance below it. Chimneys especially should be protected in this way, both on account of their elevation and the conductivity of the soot and ascending column of hot air and steam. The lower terminal should extend down to permanently moist earth, and there have branches soldered or welded to masses of metal.

The protection afforded by the rod consists chiefly in

its ability to prevent a disruptive discharge, by a gradual, silent discharge through its points, as illustrated by the similar discharge of a Leyden battery, described on page 27, thus preventing the accumulation of a dangerous charge.

THE AURORA.—The electric appearance which has received the name of the *aurora*, from its resemblance to the morning dawn, originates in the vicinity of the polar

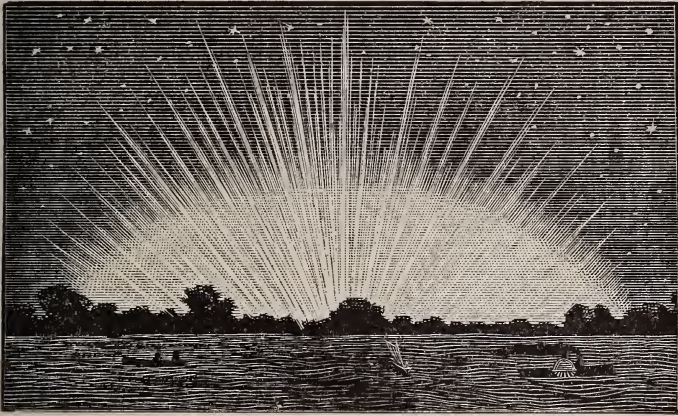

Fig. 15.

circles, and hence is called also the *aurora polaris*; the southern aurora being known as the *aurora australis*, and the northern as the *aurora borealis*. Observation has been chiefly confined to the latter, which occurs within an irregular geographical belt about thirty degrees wide, extending from about north latitude 40° to 70° ; though in some parts of the western hemisphere it is sometimes seen as far south as latitude 22° , and in some parts of the eastern hemisphere as far north as latitude 77° ; its position in both hemispheres varying with the season of

the year,—its southern limit being reached near the equinoxes, and its northern near the solstices. The center of this auroral belt is near the north magnetic pole, latitude $70^{\circ} 5' N.$, longitude $96^{\circ} 46' W.$ from Greenwich.

The general appearance of the aurora, shown in Fig. 15, is that of an arch of white light rising from the horizon, like the morning dawn, from which reddish streamers radiate upward, appearing and disappearing in rapid succession, in a series extending along the rim of the arch from one extremity to the other, often with an undulatory motion, the arch continually rising till the streamers sometimes reach the zenith. It assumes a variety of different aspects, often appearing either as a corona in the zenith, from which streamers radiate in opposite directions, or as curtains draped in curves, or as bands of reddish light spanning the heavens from east to west, or as concentric arches of white light rising from the horizon.

Its apparent vertical position is an optical illusion, the effect of perspective, its actual position being always parallel to the earth's surface, the arch being the visible part of a great circular belt of white light, from which red streamers radiate in opposite directions, as seen in the corona when part of this belt reaches our zenith. Observers in high northern latitudes, within this circular belt, see its inner rim toward the south, while observers in lower latitudes, outside of it, see its outer rim toward the north.

Its height is estimated to be about sixty-nine miles above the earth's surface: an estimate which may be accepted as correct, if the rarity of the atmosphere at this height is about the same as that of the Geissler tubes. But as the stratum of air in which it occurs is probably

many miles in thickness, the difference of atmospheric density between its upper and lower surfaces must vary considerably; so that this estimate, if correct, would represent only its average height.

CAUSE OF THE AURORA.—This brings us to the cause of the aurora. Its electric origin is now fully established by the effect produced, during its prevalence, on various electric apparatus, especially on that pertaining to the telegraph. This effect becomes manifest in currents in the telegraph lines, often strong enough to operate the instruments without the battery current, when both ends of the line are connected with the earth; or to produce such disturbance as to interrupt all telegraphic communication throughout the whole country, and across the ocean; heating the instruments, burning connecting wires, and igniting connected woodwork, and also lighting electric lamps,—such occurrences being known as *electric*, or *magnetic*, *storms*.

These currents are proved to be in the earth, and not in the atmosphere, for when the regular connection of the lines with the earth is interrupted, the disturbing currents instantly cease; and, of course, the battery currents also.

The continual prevalence of electric currents in the earth, from warm to colder regions, has been proved by experiments on telegraph lines; such currents having been observed to flow from east to west during the morning hours, when the temperature of eastern regions, warmed by the sun, is higher than that of adjacent western regions cooled during the night; and from west to east during the evening hours, when these relative conditions of temperature are reversed; the electric pressure varying as the relative difference of temperature. Well-

known laboratory experiments prove the same thing on a small scale, showing that electric currents are generated by difference of temperature, flowing from hot to cold parts of conductors; the electric pressure varying as this difference.

It is evident from this that electric earth-currents must flow from the torrid zone to the frigid zone, which, on account of the great difference of temperature, must be proportionally stronger than the east and west currents. These currents must flow across the temperate zones, and be strongest between adjacent regions having the greatest difference of temperature; the high temperature of the torrid zone and low temperature of the frigid zones being comparatively uniform. And as these currents converge toward the poles, like the meridians, they must produce the highest electric intensity in those parts of the temperate zones adjacent to the polar circles, which, as has been shown, are the regions where the aurora is most prevalent.

The prevalence of these earth-currents during the prevalence of the aurora, as has been shown, proves that there is a very intimate relation between them, which must be attributed to electric induction. A stratum of dense, highly insulating air, many miles in thickness, lies between the highly rarefied air stratum of the aurora and the earth's surface; and it is evident, from the nature of induction, as already explained, that electric currents in the earth, under this insulating air stratum, must produce opposite currents in the highly rarefied air above, where the electric resistance is about the same as that in the Geissler tubes.

These air-currents are shown in the streamers radiating from the auroral arch, which correspond in appearance and color to the discharge in the Geissler tubes; the

white light of the arch indicating the higher intensity of electric energy induced by the corresponding intensity in the earth below, due to the concentration of the earth-currents, as shown above. This concentration of electric energy corresponds to that in the positive charge on the interior coating of the Leyden jar; and the inductive effect seen in the auroral arch, to the negative charge; electricity flowing from the arch, as shown by the streamers, just as it flows from the exterior coating of the jar, producing an effect similar to that in the Geissler tubes connected with these coatings, as already explained; the insulating air corresponding to the insulating glass of the jar.

Another reason for this higher intensity is found in the greater density of the insulating air stratum in the cold region under the auroral arch, which brings the auroral air stratum proportionally nearer to the earth's surface, increasing the effect of induction inversely as the square of the distance; so that, if this distance is reduced one half, for instance, the effect of induction becomes four times as great.

The electric theory of the aurora as first proposed by Franklin ascribed its origin to the warm currents of air arising in the torrid zone, positively charged by evaporation, especially from the ocean, meeting the cold, negatively-charged air-currents from the frigid zones, and producing electric discharges in the rarefied air of the upper atmospheric strata. This theory has been accepted by leading electric writers, and if true, then the inductive effects described above must occur in reverse order, the earth currents being induced by the atmospheric currents.

It is difficult to reconcile this theory with the fact that the principal air-currents, or winds, are confined to the

insulating atmospheric stratum, within five miles of the earth's surface, and more than sixty miles below the stratum usually assigned to the aurora; the air above this lower stratum being so thin that winds are hardly perceptible. Hence, according to this theory, the aurora should occupy a much lower altitude than that assigned to it by any observer, whereas some assign to it an altitude of 120 miles above the earth's surface.

CHAPTER III.

ELECTRIC BATTERIES.

ELEMENTARY PRINCIPLES.—The simplest method of generating electricity for practical use is by means of the battery, called, by way of distinction, the *voltaic* battery, after Volta, its original inventor, or the *primary* battery, to distinguish it from the *secondary* or *storage* battery.

There are a great number of different kinds of these batteries, but, for our present purpose, only a few of the leading kinds which have come into general use need be described. They all generate electricity by chemical action, and have certain peculiarities of construction, common to all, which it will be most convenient to describe first.

The term *battery* is applied either to a single jar, or *cell*, containing the generating materials, or to a number of such cells connected together by electric conductors; the latter being the more proper use of the term, though the former use is common. These materials are a fluid mixture, or solution, in which are partly immersed two solid bodies, as shown in Fig. 16, the combination resulting in chemical action and the generation of electricity. And the variation in these simple materials, or in the manner of employing them, is what produces the different kinds of batteries.

The solid bodies are called *electrodes*, the one principally affected by chemical action being called the *generating* electrode, and the other the *conducting* electrode. The parts of these electrodes which project out of the fluid are called *poles*, and are distinguished by the terms *positive* and *negative*, as indicated by the plus and minus signs; the positive pole, by which the electric current leaves the cell, as indicated by the arrow on the right, belonging to the conducting electrode, and the negative pole, by which the returning current enters the cell, as indicated by the arrow on the left, belonging to the generating electrode. These electrodes are always carefully insulated from each other, so that the current must go through

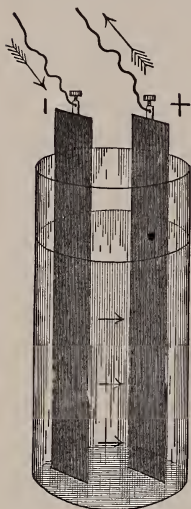

Fig. 16.

the fluid from the generating to the conducting electrode, and, after passing out by the positive pole and traversing the external circuit, return by the negative pole to the generating electrode. They are made of various materials, but zinc is almost invariably used for the generating electrode, and carbon is more generally used for the conducting electrode than any other substance, copper being the next material in most common use for this electrode; silver, platinum, and mercury are also used, mercury being the only liquid thus used.

Various kinds of fluid are employed, the principal kinds being solutions in water of sal-ammoniac, potassium bichromate, and copper sulphate; also nitric and

sulphuric acids diluted with water. The battery fluid contained in a cell may be of one kind only, or of two kinds partly separated by a porous cup, or in some other way, as by gravity, when one fluid is lighter than the other. This gives rise to the two kinds of cells, the *one-fluid* cell, in which both electrodes are immersed in the same kind of fluid, and the *two-fluid* cell, in which each electrode is immersed in a separate fluid.

POLARIZATION.—The construction of a battery cell would be a very simple matter, if there were nothing to interfere with the generation of electricity when the electrodes are immersed in the fluid and the circuit closed. A cell constructed with zinc and copper for the electrodes, and dilute sulphuric acid for the fluid, would then continue in active operation till the strength of the acid was exhausted. But, unfortunately, an opposing force is developed by this action which soon stops it entirely, unless means are provided for its suppression.

There is always in the water, and also in most of the other materials composing the various battery fluids, both oxygen and hydrogen. These elements are separated by the chemical action; the oxygen, going to the zinc or other metal composing the generating electrode, and uniting with it, forms an oxide, while the hydrogen goes to the conducting electrode, accumulates on its surface, and produces an electric pressure which opposes the electric current generated at the surface of the zinc by the chemical action just described. This hydrogen accumulation forms an *opposing positive pole*, and hence this effect is termed *polarization*; and it is the various devices for the suppression of polarization, by preventing the accumulation of the hydrogen, which, more than anything else, has produced the great number of different

kinds of battery cells which have been invented, and constitutes the principal differences between them.

One of the most effective means for suppressing polarization is to use, in the composition of the fluid, some chemical substance which is so rich in oxygen that there is enough of this element set free by the chemical action not only to unite with the zinc, but also with the hydrogen, and prevent its accumulation.

Another method often employed effectively, either alone or in connection with the above method, is to give the conducting electrode a rough surface, to which the hydrogen cannot adhere so easily as to a smooth surface, since a point has but little adhesion for any fluid, and hence a surface composed chiefly of points allows the hydrogen to escape rapidly through the liquid into the air, which it has a strong tendency to do, being the lightest of all gases, except the ether.

THE SMEE CELL.—The first battery cell constructed on this principle was made by Smee, an English electrician, in 1840, and had for its conducting electrode a plate made either of silver plated with a rough coating of platinum, or of copper plated with a rough coating of copper, which was then plated with silver, to give it greater conductivity, and afterward with platinum, to protect it from the dilute sulphuric acid used for the fluid. This plate was suspended between two plates of zinc, so as to have the two rough surfaces exposed to the direct action of two zinc surfaces, as shown in Fig. 17, in which the zinc plates are marked *z z* and the silver plate *s*.

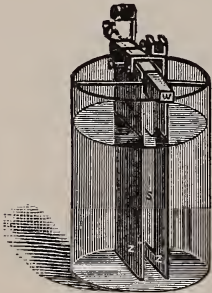

Fig. 17.

ZINC-CARBON CELLS.—It was soon found that the rough-surface method of depolarization could be much more cheaply and efficiently carried out by the use of carbon for the conducting electrode than by the expensive method adopted by Smee; carbon having not only a rough external surface like that of the Smee plate, but, being porous, a large internal surface is also brought into contact with the fluid. It has also the requisite conductivity for an electrode, when of sufficient cross-section, and, like the platinized surface of the Smee plate, is insoluble in acid.

The carbon first used for this purpose was cut from the inside of gas-retorts, but this was very impure; and it is now prepared from pure carbon, which may be obtained from petroleum and other substances, and after being ground and made into a paste with some liquid carbon, as gas-house pitch, it is molded to the proper form and baked, going through various processes to give it the requisite consistence.

THE LAW CELL.—The Law cell, shown in Fig. 18, is one of the most common cells of this kind. It is constructed with a cylinder of pure carbon and a rod of pure zinc, attached to a close-fitting, insulating cover—the zinc being within the cylinder, so that its entire surface is exposed to the carbon surface. The great extent of carbon surface in proportion to zinc surface reduces the density of the hydrogen, which spreads over this carbon surface in a very thin film, from which the gas escapes rapidly into the air. In Fig. 19 is shown a double carbon cylinder, a small cylinder being inclosed within a larger one, giving a proportionally greater extent of carbon surface, which is used in a similar cell of this kind.

The Law cell belongs to a class known as sal-ammoniac

cells; the fluid in this and other cells of this class being a solution of sal-ammoniac, about six ounces of which, finely pulverized, is dissolved in enough water to fill a

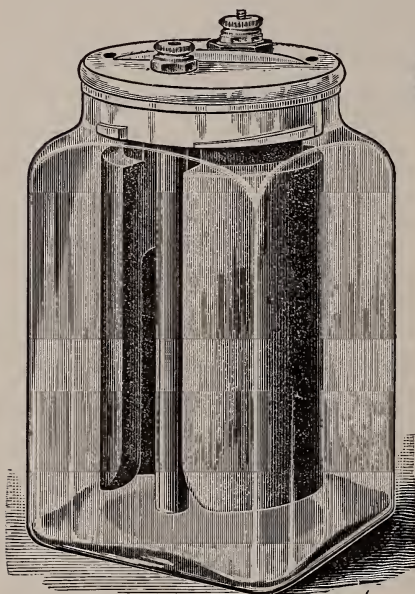

Fig. 18.



Fig. 19.

quart cell about two-thirds full. As sal-ammoniac contains no oxygen to unite with the hydrogen, it does not assist in depolarization, which is therefore effected, in this cell, by the rough carbon surface only.

It is claimed that there is no chemical action in any well-constructed sal-ammoniac cell, having materials of requisite purity, except when the electric circuit is closed, and that consequently the electrodes can remain constantly in the fluid without injury. But when the circuit is closed, the zinc surface is attacked by the chlorine liberated from the sal-ammoniac, which corrodes it, forming zinc chlo-

ride, so that the zinc is eventually destroyed, and a new one required ; but pure carbon, like that employed in the Law cell, is not affected by the chemical action, and hence this electrode does not require renewal, but should occasionally be soaked in warm water to remove any impurities which may have accumulated.

THE SAMSON CELL.—This cell, shown in Fig. 20, belongs also to the sal-ammoniac class, and is constructed on principles quite the reverse, in some respects, of those

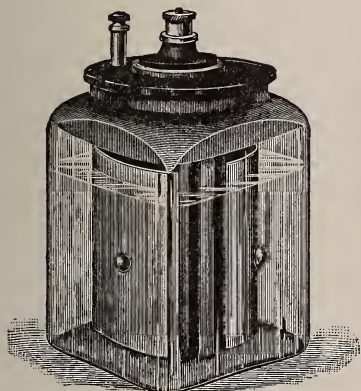

Fig. 20.

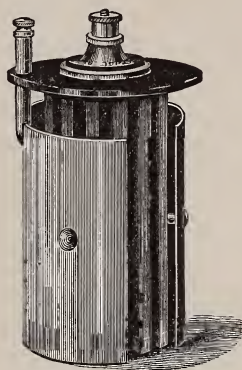

Fig. 21.

followed in the construction of the cell just described. Instead of a small zinc rod inclosed within a large carbon cylinder, either single or double, it has a cylinder of sheet zinc inclosing a porous carbon cylinder of large cross-section, having a channeled surface, as shown in Fig. 21 ; thus giving a much greater extent of zinc surface in proportion to carbon surface than in the Law cell. This large generating surface is thus brought close to the conducting surface, reducing the electric resistance between them, through the fluid, to the lowest practical

limit, and proportionally increasing the electric efficiency of the cell. This internal resistance is still farther reduced by the large cross-section of the carbon, and the channeling greatly increases the depolarizing external surface.

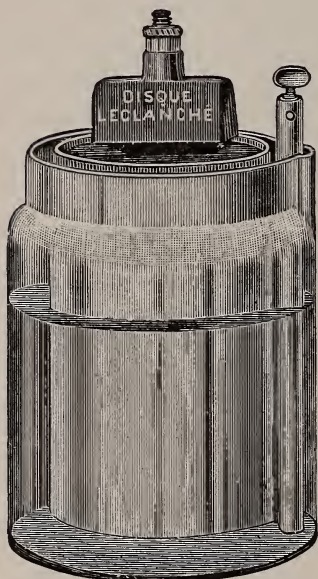

Fig. 22.



Fig. 23.

The carbon cylinder is hollow, and filled with a mixture of crushed carbon and *manganese binoxide*, a substance which is rich in oxygen; and some of this oxygen, being liberated by the chemical action, unites with some of the hydrogen, forming water, and thus assists in depolarization, compensating for the smaller proportion of depolarizing surface as compared with that in the Law cell.

THE LECLANCHÉ CELLS.—The first battery cell in which sal-ammoniac was used was invented by Leclanché,

a French electrician, and is known as the *Disque* Leclanché cell. It is represented in Fig. 22, and cells of this kind are still in common use.

The conducting electrode is constructed with a porous cup of unglazed porcelain, in which is placed a carbon plate, surrounded with a mixture of crushed carbon and manganese binoxide, in about equal proportions, to which is added a little water. This cup is closed with Portland cement, except two small openings left for ventilation and the addition of water when required, and is placed in a glass jar, with a half-inch zinc rod, similar to that used in the Law cell, for the generating electrode, which is placed in a recess, as shown.

The sal-ammoniac solution, which is placed in the glass jar, permeates the porous cup, and by its chemical action on the manganese binoxide liberates some of its oxygen, which unites with some of the hydrogen, and assists in depolarization, as already described; the principal chemical action being at the surface of the zinc, as in other cells.

It was found that the porous cup added greatly to the electric resistance of the cell, proportionally reducing its electric energy. To remedy this, Leclanché invented the conducting electrode shown in Fig. 23, in which the porous cup is dispensed with, and the manganese binoxide, and other materials having important qualities, are cemented together, molded into prisms, and condensed under heavy pressure to increase their conductivity. Two of these prisms are attached to the carbon plate by stout rubber bands, as shown, each prism being so shaped as to leave an opening between it and the plate. And the cell having this electrode is called the *prism*, or *pile*, Leclanché cell.

The internal resistance of the cell being greatly reduced by this construction, its electric energy is proportionally increased. The gradual disintegration of the prisms by the chemical action referred to as resulting in the production of oxygen, eventually destroys them, necessitating their renewal from time to time; while the carbon plate to which they are attached, being indestructible, remains permanent, as in the Law cell. This disintegration of the conducting electrode occurs in every cell in which it is composed in part of manganese binoxide or other substance decomposed by the chemical action.

There are various other sal-ammoniac cells in use, as the Laclede, Microphone, Diamond Carbon, and various dry cells. A very important advantage in all cells of this class is their entire freedom from noxious fumes and from acid, which makes them especially desirable for ringing house bells, or any household use for which a battery current may be required. And as the electrodes remain inactive in the fluid, without injury, in all such cells, properly constructed, the cell is always ready for work the moment the circuit is closed by pressing the push-button or otherwise.

Sal-ammoniac cells are very efficient for what is called *open circuit* work, where the circuit is closed for only brief intervals, giving time for the escape of the hydrogen during the intervals of rest. But, like all one-fluid cells, they polarize by the accumulation of hydrogen, when employed too long at a time, and hence are not adapted to *closed circuit* work, where the current is employed for long intervals without intermission.

POTASSIUM BICHROMATE CELLS.—In this class of zinc-carbon cells potassium bichromate is used in the fluid as a chemical depolarizing agent, the fluid being com-

posed of 9 per cent. of this salt, 25 per cent. of sulphuric acid, and 66 per cent. of water, which are recommended as the best proportions, though they may be varied if desired. Oxygen, being liberated from the potassium bichromate by the sulphuric acid, unites with some of the hydrogen, forming water, as in the similar cases already described.

Cells of this class have great electric energy, and are especially adapted to work requiring a powerful battery current for a short time, and hence are preferred for laboratory, lecture room, and medical use. But as polarization is not wholly suppressed, and waste material accumulates which obstructs chemical and electric action, agitation of the fluid, and the removal of the electrodes from it, or of the zinc alone, becomes necessary after a few minutes' work, to give the cell an opportunity to recuperate. Both these results are accomplished at the same time by plunge batteries, of which there are many different kinds, in which the electrodes are lifted out of the fluid, supported above it, and allowed to drip, and then lowered into it again by some convenient mechanical device.

THE GRENET CELL.—The Grenet cell, shown in Fig. 24, belongs to this class, and is constructed with a zinc plate suspended between two carbon plates, so as to have two carbon surfaces exposed to the direct action of two zinc surfaces, and as close to them as practicable without contact, to reduce the electric resistance through the fluid to the lowest degree. The glass jar has a capacious base to hold a large charge of fluid, which shall not be soon exhausted, and a wide neck into which the zinc can be lifted by a sliding rod having sufficient friction to support it, as shown in Fig. 25. As the fluid produces

chemical action on the zinc when immersed in it, whether the circuit is opened or closed, this electrode must be lifted out of it when the cell is not in use.

This cell is very convenient for experimental work requiring only a single cell; but, for heavier work, cells are constructed with two or more zinc plates suspended



Fig. 24.

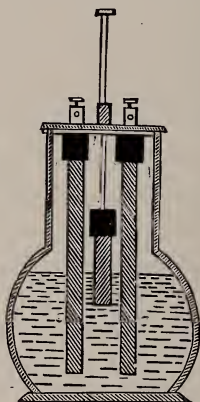

Fig. 25.

between carbon plates in a similar manner, in jars with straight sides, both electrodes being raised or lowered as required, by some mechanical device.

As the fluid used in this class of cells soon weakens with use, and is subject to slow chemical decomposition when not in use, which results in the deposition of a crystalline substance called *chrome alum*, freshly made fluid should be used when strong electric action is required.

AMALGAMATION OF THE ZINC.—As ordinary commercial zinc contains impurities which reduce the electric efficiency of battery cells by producing electric currents confined to the surface of the zinc, which do not circulate

through the external circuit, and as strictly pure zinc is too expensive for battery use, it is customary in these and many other cells to amalgamate the surface of the zinc from time to time, as may be required, with mercury, combined with some suitable acid which will make it adhere properly. This gives the zinc a surface better adapted to its work, and assists materially in suppressing this *local action*, as it is called, which interferes with it.

THE EDISON-LALANDE CELL.—This cell, shown in Fig. 26, is constructed with a plate of black oxide of copper suspended between two plates of zinc, and the fluid is a solution of caustic potash in water. It has very low electric resistance, which gives it proportionally high electric energy, notwithstanding its comparatively low electric pressure. It is said to be free from polarization, local action, and noxious fumes, and does not require the removal of the electrodes from the fluid when not in use, as there is no chemical action except when the circuit is closed. Hence it is well adapted to domestic use, and is also recommended for telegraph work.

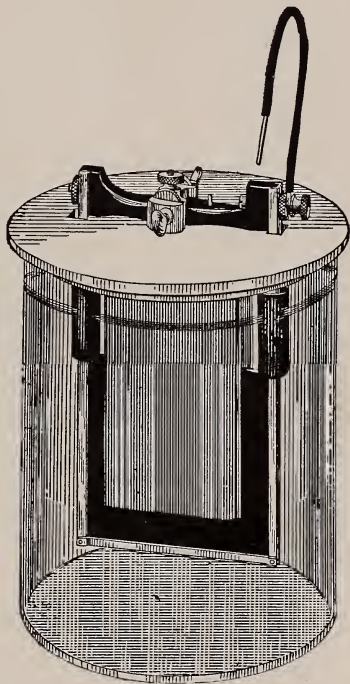

Fig. 26.

As both the caustic potash and black oxide of copper are rich in oxygen, the depolarization is doubtless due to the liberation of this element by the chemical action, and its union with the hydrogen.

DRY CELLS.—Cells of the sal-ammoniac class are now extensively used, in which starch, or some similar absorbent, is mixed with the fluid, producing a jelly not easily spilled. This is placed in a small cup made of sheet zinc, which is employed as the generating electrode, and in its center is placed a carbon conducting electrode, as shown in Fig. 27. The cup is then permanently closed with an insulating cement which electrically separates the electrodes, making a portable cell, the contents of which cannot be displaced in any position.



Fig. 27.

These are known as *dry cells*, and when well constructed have a high degree of efficiency for open circuit work; and, being small and portable, are very convenient for physicians, lecturers, and others who require a strong battery of several cells, which can be easily and safely carried. But when the fluid charge is exhausted the cell is of no farther use, as it requires complete reconstruction, the cost of which would be more than that of a new cell.

TWO-FLUID CELLS.—One-fluid cells, such as have been described, are all liable to polarization on a closed circuit, no matter how perfect their construction, and hence are not so well adapted as two-fluid cells to work in which the circuit is closed for long intervals, as in many kinds of plating; or in which it is in constant use for long intervals, with rapid alternate opening and closing, as in

large telegraph offices. Hence, for such work, two-fluid cells are preferred, being practically free from polarization.

THE DANIELL CELL.—The first two-fluid cell was invented by Daniell, an English electrician, in 1836, and the main principles adopted in his cell have never been superseded, cells constructed according to his original method being still in use, while improved cells, constructed on the same leading principles, are far more extensively used than any other two-fluid cells, being considered the best of this class.

This construction is illustrated by Fig. 28, in which is shown, in a glass jar, a porous cup containing the zinc. This cup is inclosed within a copper cylinder having a vertical opening on one side, for the free circulation of the fluid, this cylinder being the conducting electrode. Dilute sulphuric acid is placed in the cup, in contact with the zinc; and in the jar, in contact with the copper, is a solution of copper sulphate, a salt composed of copper and sulphuric acid without hydrogen.

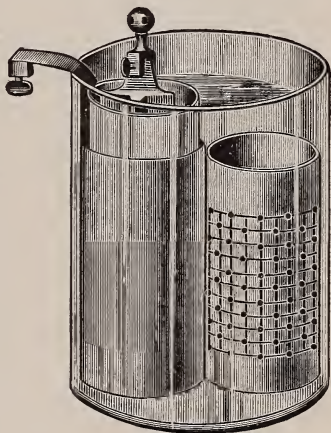

Fig. 28.

The chemical action decomposes the sulphuric acid in the porous cup, zinc uniting with it, displacing its hydrogen, and forming zinc sulphate. The copper sulphate in the outer jar is also decomposed, and its copper deposited on the copper cylinder, liberating its sulphuric

acid, which unites with the displaced hydrogen through the porous cup, and is changed to ordinary sulphuric acid, which is decomposed and unites with the zinc, as before, displacing more hydrogen. Hence there is never any free hydrogen in the cell, as it is absorbed by the acid destitute of it the moment it is liberated from the acid in combination with it, and is thus kept constantly employed in transferring sulphuric acid from the decomposed copper sulphate to make the zinc sulphate, and hence cannot do mischief as an idle polarizer, as in other cells, copper instead of hydrogen being deposited on the copper cylinder, and zinc sulphate accumulating around the zinc.

Crystals of copper sulphate are placed in a perforated copper cup, shown on the right, and these dissolve slowly and keep the solution replenished, supplying fresh copper sulphate in place of that decomposed by the chemical action; the consumption of this material, and also of the zinc, being nearly as great when the cell is idle as when it is in action.

The electric pressure generated by this cell is only a very small fraction more than a volt, as mentioned in the definition of that unit on page 19; hence it is the standard usually referred to as representing the volt, where strict accuracy is not required.

GRAVITY CELLS.—The electric resistance of the porous cup employed in the Daniell cell, and the local action produced by the material of which it is composed, led to the invention of similar cells in which it is dispensed with. This resistance is due to the reduction of cross-section in the fluid between the copper and the zinc by the intervention of the cup, this cross-section being represented in the cup only by the fluid permeating its

pores, which is but a small fraction of the entire fluid cross-section.

As the solution of zinc sulphate, which surrounds the zinc, is lighter than the solution of copper sulphate, which surrounds the copper, the method has been adopted of placing the zinc in the upper part of the cell and the copper in the lower part, as shown in Fig. 29; the separation of the fluids by gravity bringing each electrode into contact with its own fluid, with full fluid cross-section, and corresponding low resistance between them, thus dispensing with the porous cup, with its limited cross-section and corresponding high resistance. Connection with the copper electrode is made by a copper wire, insulated from the zinc and fluid surrounding it by a covering of gutta-percha or India-rubber. Crystals of copper sulphate are placed in the bottom of the cell, around the copper electrode, for the same purpose as in the Daniell cell.

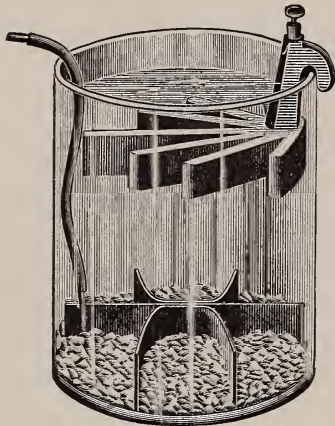

Fig. 29.

After the cell has been set up and put in action, sufficient time must elapse for the formation of zinc sulphate and separation of the fluids before full action is attained; and agitation of the fluids, which would result in mixing them, must be avoided. Total separation is not practicable, a small percentage of the copper sulphate rising into contact with the zinc and producing copper pendants from it, after the fluid has been in use for some

time. These pendants must be removed before they become long enough to reach the lower fluid.

Cells of this construction require but little care, and are extensively used for telegraphing, to which they are well adapted, large batteries of them being often employed for this purpose.

BUNSEN AND GROVE CELLS.—The Bunsen cell, shown in Fig. 30, is a two-fluid cell constructed with zinc and carbon electrodes; a carbon prism being placed in a porous cup containing nitric acid, and this cup inclosed within a slotted zinc cylinder, well amalgamated, which is placed in a glass jar containing dilute sulphuric acid.

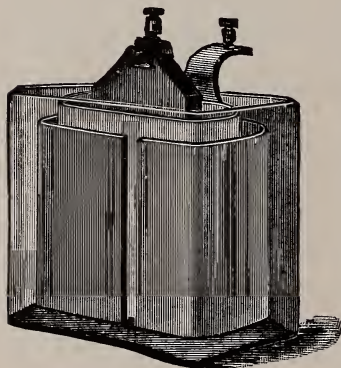

Fig. 30.

Oxygen is liberated from the nitric acid in sufficient quantity to absorb all the hydrogen and produce complete depolarization; and the comparatively low resistance of this acid adds greatly to the electric energy of the cell, which is one of the most powerful in use.

The Grove cell is of similar construction and equal energy, but has a strip of platinum for its conducting electrode, which is much more expensive than the carbon prism.

Both cells emit noxious red fumes, due to the chemical decomposition of the nitric acid, which are so irritating and unwholesome that these cells are now but little used.

BATTERY CONNECTIONS.—Cells are connected so as to form batteries by connecting their electrodes together

with conductors, which are usually copper wires. A battery thus formed may consist of any number of cells required for the work for which it is intended, from two to several hundred; but they should all be of the same kind, as it is not advisable to have cells of different kinds in the same battery.

There are two methods of making this connection, known respectively as the *series* method, and the *parallel* method. In the series method, illustrated by Fig. 31, the

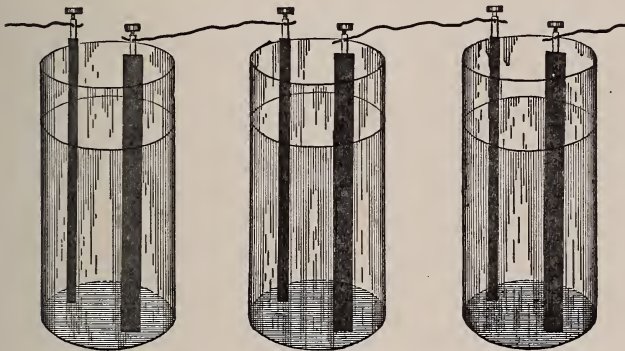

Fig. 31.

generating electrode of each cell is connected with the conducting electrode of the adjacent cell; and in the parallel method, illustrated by Fig. 32, all the generating electrodes are connected together and likewise all the conducting electrodes.

The quantity of electric energy generated is precisely the same by either method, but the effects produced are very different. The series method gives high electric pressure and proportionally small volume of current, while the parallel method gives low electric pressure and proportionally large volume of current.

The electric pressures of the three cells shown in Fig. 31 are added together by the flow of the current from cell to cell, producing three times the pressure of a single cell; but as this current encounters the electric resistance of each cell, the resistance is increased in the same proportion as the pressure, so that the current's volume is equal only to that from a single cell.

In the three cells shown in Fig. 32, the three carbon electrodes being connected together, and likewise the

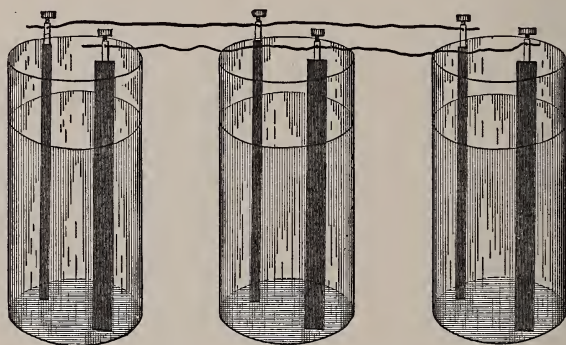

Fig. 32.

three zinc electrodes, each set has only the same electric potential as that of a single electrode, and hence the difference of potential between the positive and negative poles, which produces the electric pressure, is only the same as that between the poles of a single cell; and the whole combination of electrodes, poles, and fluid in the three cells is just the same as that of a single cell three times the size of any one of them.

But the increase in cross-section of electrodes and fluids, by this combination, produces a corresponding reduction in the electric resistance, and hence a propor-

tional increase in current volume, which is three times that of a single cell, while the electric pressure is only the same as that of a single cell.

As the total electric energy is represented by the electric pressure and current volume multiplied together, it is evident that three times the current volume multiplied by the pressure of a single cell, as in the parallel arrangement here represented, gives just the same electric energy as three times the electric pressure multiplied by the current volume of a single cell, as in the series arrangement—the pressure being represented in volts and the current volume in amperes. And the same rule will apply to any number of cells.

The difference between these two methods of battery connection may be illustrated by the following example: Let a tank filled with water have a faucet at bottom through which the water can flow. Now let another tank, three times the height, have a faucet of one third the size. The pressure at this faucet will be three times as great as at the other, but the volume of current which can flow through it in a given time will be just the same, because the resistance is increased, by reduced size, in the same proportion as the pressure. This represents the series method.

Now let three tanks of the same height as the first one be placed side by side, on the same level, and connected together at bottom by pipes, and a faucet three times the size of the first be attached to one of them. The pressure at this faucet will be just the same as that at the first one, but the volume of water which can flow through it in a given time will be three times as great, because the resistance, reduced by increase of size, is only one third as great. This represents the parallel method.

These different methods of battery connection are quite important in practical electric work, and may be varied to any extent required, by combining both methods in the same battery, as by having two or more groups of parallel-connected cells joined in series, or two or more groups of series-connected cells joined in parallel.

The electric pressure of the battery must be proportioned to the electric resistance of the circuit. If this resistance is high, as in a long telegraph line, the electric pressure must be made proportionally high, so that there shall be enough strength of current left to operate the instruments after overcoming the resistance of the circuit. Hence the series method is preferred for this purpose. But if the circuit resistance is low, and a current of large volume is required, as in electric plating, the parallel method is preferred; or such a combination of the two methods may be employed as shall give the requisite pressure and current.

COMPARISON BETWEEN LARGE AND SMALL CELLS.—The electric pressure of battery cells varies from half a volt to about one and three quarter volts. This pressure depends on the difference of potential between the poles, which is produced by the materials of which the cell is composed and their relative arrangement, and not by the size of the cell. A cell no bigger than a lady's thimble has just as great electric pressure as one the size of a gallon jar, whose materials and construction are the same.

This may be illustrated by the pressure of water, or any other liquid, which depends entirely on the height of the column, and not on its size in cross-section. A column of water in a tank ten feet high, and one square foot in cross-section, has just the same pressure as a

column in a tank of the same height which is a hundred square feet in cross-section. And if the two tanks be connected together at bottom by a pipe, the small column will counterbalance the large one, so that the water will stand at exactly the same level in each.

In like manner, if the small cell referred to above be so connected with the large one that its pressure shall oppose that of the large one, the two pressures will exactly counterbalance each other, so that there will be no current in the connecting circuit.

But it is evident that a small cell cannot have the same durability or constancy as a large one of the same construction, though it has the same electric pressure,—its material being more rapidly exhausted, proportionally, by the chemical action, just as the water in the small tank would be more rapidly exhausted than that in the large one, by the same outflow.

Also, as the electric resistance of conductors varies inversely as their cross-section, that is, decreases in the same proportion as the cross-section increases, it is evident that the resistance of a large cell is as much less than that of a small cell of the same construction as the cross-section of its electrodes and fluid is greater. Hence its volume of current, with the same pressure, being increased in the same proportion as the reduction of resistance, is proportionally greater.

STORAGE BATTERIES.—The apparatus commonly called the *storage battery* is also known as the *accumulator*, and as the *secondary battery*, this last term being employed to distinguish it from the primary battery, and these various terms being applied either to a single cell, or to a collection of cells electrically connected together. These batteries are employed to accumulate, or store, a given

quantity of electric energy, estimated by the number of hours required to discharge it at a given rate, and are not, in any sense, generators of electric energy.

The electric energy thus stored is usually generated by a dynamo, but may also be generated by a primary battery, and produces certain chemical changes in the material contained in the cell during the storing process, or *charging*, by which electric energy is accumulated. And during the discharge these chemical changes are reversed, electric energy flowing from the cell, till the materials are restored to their original chemical condition, when the discharge ceases.

THE PLANTÉ CELL.—Various attempts to accomplish electric storage by means of gases and otherwise were made by different electricians during the first half of the present century, but the first practical storage cell was invented by Planté, a French electrician, in 1859, who discovered the special adaptability of lead to this purpose. His cell was constructed with two lead plates, insulated from each other and immersed in water acidulated with sulphuric acid contained in a glass jar. These plates were connected respectively with the opposite poles of a primary battery, by which the chemical changes pertaining to the charge were produced.

After each charge, given in this manner, he discharged the cell by connecting the plates together by a copper wire, and then charged them in reverse order, and by continuing this process for several months, increasing the charge continually and allowing a period of rest after each discharge, he produced a cell which, when charged, had a thick coating of lead dioxide on the positive plate, and of spongy lead on the negative, but when discharged, had a coating of lead sulphate on both plates. During

the discharge a powerful electric current flowed through the connecting wire, by which iron rods were melted and other interesting laboratory experiments performed.

THE FAURE CELL.—Faure, another French electrician, shortened this process by coating the plates with a paste made of lead oxide and sulphuric acid, which, by Planté's process of alternate charging and discharging, could be changed in a few days to lead dioxide on the positive plate and spongy lead on the negative.

This cell was subsequently improved by substituting for the supporting lead plates lead grids, like that shown in Fig. 33, each hole being narrower at its center than at each surface, as indicated by the shading,

so that the paste, when pressed into it, took the form of a rivet, and was thus held in place. The lead oxide, known as red lead, or *minium*, was used for the positive plates, and the light-colored lead oxide, known as *lith-*

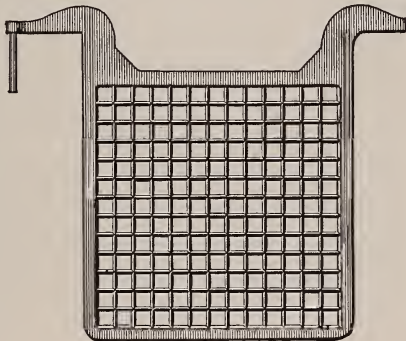

Fig. 33.

arge, for the negative plates, and the water was acidulated with 36 per cent. of sulphuric acid.

The cells thus improved have come into general use, and are made of different sizes, each having a number of these plates. Fig. 34 illustrates the construction and the mode of connecting them together to form a battery. The plates are supported vertically by lead lugs which rest on opposite edges of a glass jar, space being left below for the circulation of the fluid. The positive plates

alternate with the negative and are separated from them about three sixteenths of an inch by hard-rubber insulators, the outside plates being both negatives, so that there is always one more negative than positive, giving an equal number of active surfaces of each kind, as the two outside surfaces are inactive.

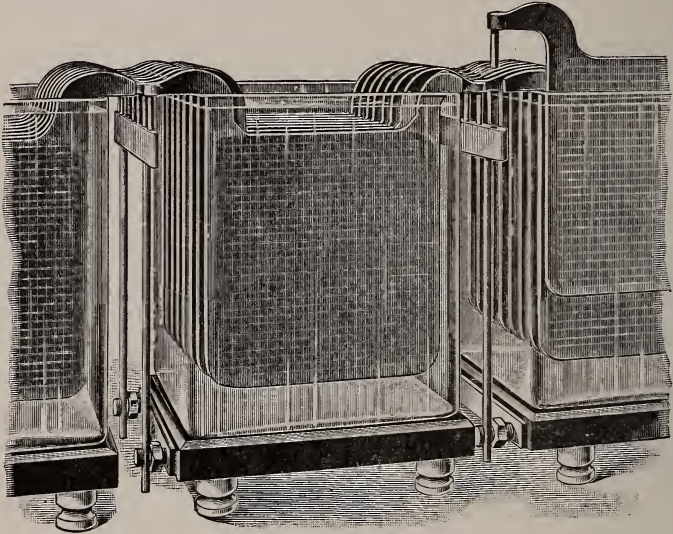

Fig. 34.

One of the lugs on each plate has a short copper rod attached to it, as shown, which fits loosely into a hole in a transverse copper bar, one of which is supported on each side of the cell, as shown; the plates being so placed that the lugs with rods attached alternate with those without rods on each side, so that all the positive plates are electrically connected together by the rods and transverse bar on one side, and all the negative plates in a similar manner on the opposite side; the holes in the bars containing mercury to maintain perfect electric contact.

When the cells are connected together as a battery, as shown, the lugs with rods, in each cell, come opposite those without rods in the adjacent cell, the rods from each cell occupying alternate holes in the transverse bars, so that the positive plates of one cell are electrically connected with the negative plates of the adjacent cell by the transverse bar supported between them, as shown. By this arrangement any plate can be lifted out for inspection or repairs without disturbing the others, as shown on the right in Fig. 34.

The number and size of the plates vary in different cells, and also their thickness; plates eighth of an inch thick and quarter of an inch being used, the positives being a little thicker than the negatives. The negatives, not being subject to oxidation like the positives, have much greater durability, one year of constant use being the longest time for which manufacturers guarantee the positives. Portable cells are made with hard-rubber vessels, furnished with covers.

Most of the Faure cells in use have lead connections, without joints, which are not liable to corrosion by the acid fumes and creeping salts, like the copper connections here described.

THE AMERICAN CELL.—Plates constructed like those in the Faure cell are liable to warp or buckle, especially when the discharge is continued too long, on account of the unequal expansion, on opposite surfaces, of the lead sulphate which forms during the discharge; the lead plate bending easily, while the grid bars, being short and rigid, cannot yield so as to make room for the expansion of the paste. It is also difficult to obtain lead oxide of uniform chemical composition, the ordinary commercial article being liable to great variation in its composition.

These faults have led to the invention of plates of a different construction both mechanical and chemical, in the cell known as the American, shown in Fig. 35. Its plates constructed as shown in perspective in Fig. 36, and

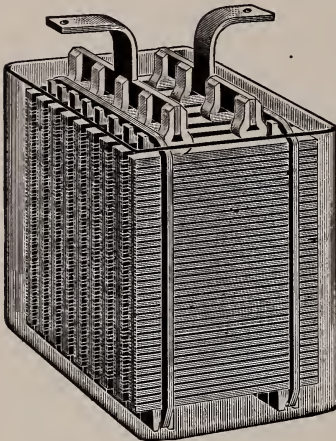

Fig. 35.

in cross-section at A in Fig. 37, are made of pure lead, and deeply grooved on both surfaces. The active material, lead peroxide in the positive plates and spongy lead in the negatives, fills these grooves. The peroxide is formed from the lead itself, as in the Planté cell, but much more rapidly, requiring only two days for its formation instead of several months. This is done by a special process, the nature

of which is a business secret, as well as the composition of the fluid employed for this purpose. The peroxide formed in this way, being of perfectly uniform composition throughout, is claimed to have much higher electric efficiency than is possible to be obtained from paste, as in the Faure cell. The negative plates are formed from the positives by chemically changing the peroxide to spongy lead by the electric current, as in the Planté and Faure cells.

The plates of both kinds are about $\frac{7}{16}$ of an inch in thickness, and when assembled in the cell, as shown in Fig. 35, the positives alternate in position with negatives and are insulated from them by hard rubber separators

constructed as shown at B in Fig. 37, leaving a space about $\frac{3}{16}$ of an inch wide for the free circulation of the fluid.

The plates in each set are electrically connected together, as shown, by lead bars soldered to lead clamps, strips of lead extending from the bars for connecting the cells in a battery; and are supported on projections at the



Fig. 36.

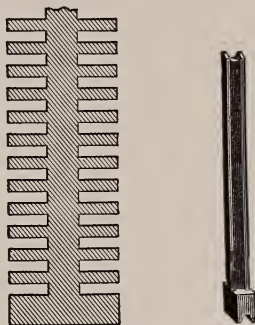

A Fig. 37. B

bases of the separators; and the two sets are held together by stout rubber bands. The fluid is composed of one part sulphuric acid and five parts pure water.

THE CHLORIDE ACCUMULATOR.—The invention of this cell, which is of recent origin, is due to Payen, a French electrician. Its construction is illustrated by Figs. 38 and 39, Fig. 38 showing one of the negative plates after its chemical formation. The little circular tablets, or *pastilles*, as they are called, form the active material, and are prepared from a mixture of lead chloride and zinc chloride, from which, after fusion by heat, they are cast in molds; each having a hole in the center, as shown, and its outer edge being convex, and therefore wider at the center than at each surface. These pastilles are then arranged in a mold, by being placed on pins through the central holes,

and the supporting plate, composed of lead and a small percentage of antimony, cast round them; the melted metal being forced into the mold under powerful air pressure, so as to make the plate dense and free from air-holes, the convex edge of each pastille being inclosed by the concave groove which it forms in the inclosing plate, so as to be firmly held in place.

A number of these plates are then placed in a tank

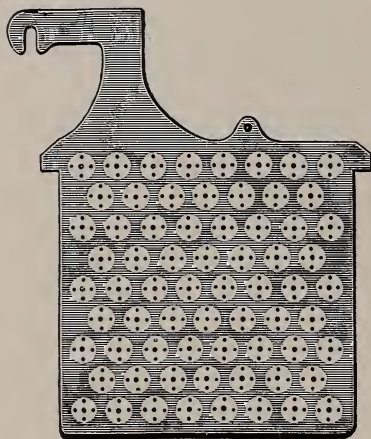

Fig. 38.

containing a solution of zinc chloride, in contact with solid plates of zinc, which alternate with them, where they remain forty-eight hours. This combination is virtually a primary battery, the electric action of which is confined to the cell itself; and its effect is to remove both the zinc chloride and the chlorine of the lead from the pastilles, leaving in them

only a porous crystalline structure of pure lead, supported by the solid lead-frame. The pores in the pastilles are at right angles to the surface of the plate, and can easily be seen by a magnifying glass; a few of them being roughly represented by the small holes surrounding the central hole. A connecting lug of lead is fused on each plate, and the plates to be used as negatives are then complete.

The pastilles for the positive plates are made of lead tape with cross projections on one surface, and are rolled into

flat disks, like cloth tape, the spaces between the projections producing little holes, or pores, through them, and they are softened and made more porous by a short immersion in a bath of nitric acid. They are concave at the edges, and being wider at the surfaces than at the centers, are held in the plate like rivets.

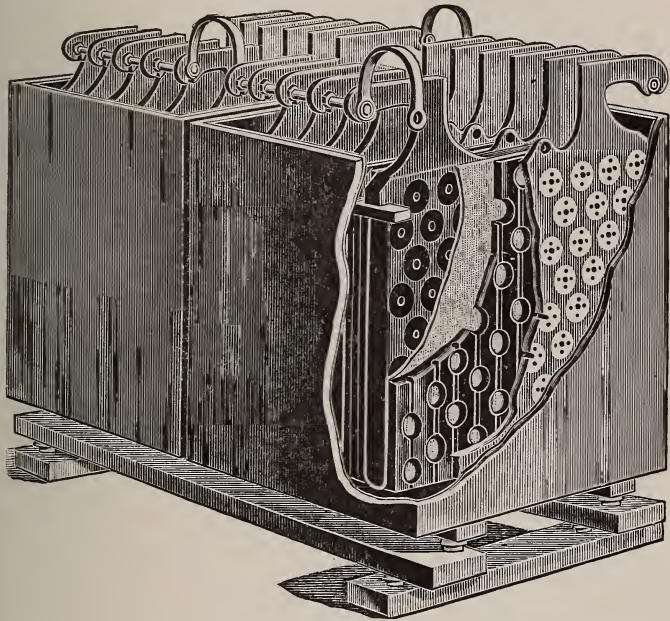

Fig. 39.

The plates are then assembled in tanks containing dilute sulphuric acid, positives and negatives alternating, and being insulated from each other, but each kind connected together by conductors, outside the fluid, in two separate sets; and are subjected for several days to a powerful dynamo current, which flows constantly from the positive set to the negative; by which lead peroxide

is formed upon the lead tape of the positives, while the spongy lead of the negatives remains unchanged. The positives and negatives are then assembled in a cell as shown in Fig. 39, the adjoining plates being separated from each other by thin wooden boards or by strips of hard rubber.

THE EDISON STORAGE CELL.—Mr. Edison has recently developed a storage cell containing very different elements from those already described, and designed with particular reference to producing a cell which should be as light as possible. The *electrodes* in this new cell are *iron* and *superoxide of nickel*, and the electrolyte is a 20 per cent. aqueous solution of potassium hydrate.

When discharging the iron is oxidized and the superoxide of nickel is reduced to a low oxide; when charging the iron oxide is reduced to spongy metallic iron, and the nickel oxide is oxidized to a superoxide.

The oxide of nickel is used in a finely divided form, commingled with a conducting substance such as flake graphite in order to improve the conductivity of the mass. The iron is also used in finely divided form commingled with a similar conducting substance. Both of these active materials are compressed into thin cakes or briquettes. Each briquette is placed in a shallow, closely fitting nickel plated box of thin perforated sheet steel, and this is then closed by a cover of similar material. These boxes containing the active material are then forced into holes in nickel plated steel grids under hydraulic pressure, so as to make plates of great mechanical strength.

ELECTRIC PRESSURE AND RATE OF DISCHARGE.—The electric pressure of the lead storage cells is about two volts each, and the volume of current far greater than that usually obtained from ordinary primary cells, on ac-

count of the relatively greater number and larger size of the plates, the low internal resistance, and entire absence of polarization. This volume of current can be varied to any required extent by varying the resistance of the external circuit, producing proportional variation in the rate of discharge. A cell which can furnish a current of one ampere for 300 hours is said to have a storage capacity of 300 ampere-hours; but, by varying the resistance of the circuit, such a cell can be discharged in one hour with a current of 300 amperes, or in ten hours with a current of 30 amperes, or in thirty hours with a current of 10 amperes, and so on.

Batteries of any required size can be formed by connecting cells together, either in series or in parallel, or by a combination of both methods, so as to furnish current of sufficient electric pressure and volume for electric lighting, or the operation of machinery by the electric motor. But notwithstanding the adaptation of storage batteries to work of this kind, they have not yet fulfilled the expectations entertained in regard to them; the direct use of current from the generator, wherever obtainable, being more practical and economical.

ELECTROLYSIS.—The decomposition of a chemical compound by the electric current, which occurs in the charging of a storage battery, in the manner described, is known as *electrolysis*, a process which is employed in the arts for various purposes, especially for the deposition of metal in electroplating, electrotyping, and the electric refining of metals and their separation from their ores.

It consists in transmitting a current of electricity, obtained from a battery or a dynamo, through a bath composed of a solution of the substance to be decomposed, by which its constituent elements are separated. Two

electrodes are employed, as in batteries, one of which is connected with the positive terminal of the electric circuit, and called the *anode*, and the other with the negative terminal, and called the *cathode*; and the electric current, as it traverses the bath, decomposes the solution, one or more of its elements being deposited on the cathode and the others on the anode.

In electroplating, the articles to be plated are employed as the cathode, the anode usually consisting of one or more plates of the metal to be deposited, and the bath containing some chemical salt of the same metal, dissolved in water. This solution being decomposed by the current, the pure metal is deposited on the articles to be plated, while the other constituents of the salt, being set free, combine with the metal of the anode, forming a fresh supply of the salt, which is dissolved in the bath, replacing that which was decomposed.

The electrotype process is similar. Impressions of the cuts or type to be copied are taken on plates composed of beeswax and graphite, which, after being properly prepared, are immersed in a solution of copper sulphate, and connected with the negative terminal of the electric circuit, at a distance of about two inches from anode plates of pure copper, connected with the positive terminal. The sulphate being decomposed by the current, its copper is deposited on the cathode plates, and its sulphuric acid, being thus set free, unites with the copper of the anode plates and thus renews the supply of copper sulphate.

When the copper deposited has attained the requisite thickness, it is stripped from the plates and given a thin coat of solder on the reverse surface, over which is poured type-metal, which is thus made to adhere, form-

ing plates about one eighth of an inch thick, which are then mounted on wooden blocks.

Metals are refined in a similar manner, the crude metal being used as the anode, and pure metal as the cathode, the bath containing a solution of some salt of the metal. Pure metal, taken from the solution, is deposited on the cathode plates by the current, and replaced by metal taken from the anode plates, which are thus gradually dissolved and replaced by similar plates of crude metal; the deposit being stripped from the cathode plates when it has acquired sufficient thickness. Copper refining is accomplished in this way on a very extensive scale.

The separation of aluminum from its ore is now accomplished exclusively by this process. Carbon is employed both for the anode and cathode, and the aluminum ore, mixed with other substances, is fused at a red heat, in steel crucibles, and forms the bath from which the pure metal is deposited on the cathode by the electric current. The materials in the bath are kept fused constantly, fresh ore being added as required, and the pure metal, which sinks to the bottom in a melted mass, removed as it accumulates.

ELECTROLYSIS IN MEDICAL PRACTICE.—Electrolysis is also employed in medical practice for medicating diseased parts internally; the process being known as *cataphoresis*. The medicine is applied to the surface of the affected part by a sponge or plate electrode, connected with whichever pole of the battery will produce its deposition in this part: and being usually a compound, it is decomposed, and each of its elements being transmitted through the tissues to the electrode for which it has an electrochemical affinity, a certain portion is deposited during transmission, and retained.

If, for instance, iodine is to be deposited in the diseased part, potassium iodide, which is a compound of potassium and iodine, may be used, and should be applied to the diseased part by the negative electrode, while the positive electrode is in contact with some other part of the body; because iodine, being what is known in electrolysis as an *electronegative* element, or *anion*, goes to the positive electrode, while potassium, being an *electropositive* element, or *cation*, goes to the negative electrode. But if the element to be deposited in the diseased part were electropositive, then the medicine should be applied by the positive electrode.

ELECTRIC CAUTERY.—The battery current is also employed for *electric cautery*, by which abnormal tissue is destroyed; and, for this purpose, electrodes are constructed with fine platinum wires of suitable shape, attached to insulating handles. These wires, having high electric resistance, are instantly heated to a red or a white heat by a strong current, and such electrodes can be employed for various cauterizing purposes, limited chiefly to diseases of the throat and nose; furnishing also, at a white heat, light to guide in their application in the interior cavities of these organs.

CHAPTER IV.

MAGNETISM.

ELEMENTARY PRINCIPLES.—Magnetism, like electricity, was known to the ancients five or six hundred years before the Christian era, having been discovered in a certain black stone, first found in Magnesia, a country of Asia Minor, which was therefore called the *magnet* stone. This stone, which is a species of iron ore, has the property of attracting iron, and also of pointing to the earth's poles, when balanced so as to have free motion. Hence this last property has been called *polarity*, and from it has originated the name *lodestone*, that is, *leading* stone, which has been given to the stone.

Both these properties can be given to iron or steel rubbed with this stone, iron soon losing them, but steel retaining them permanently; and, in this way, steel magnets, and needles for the compass used by mariners, surveyors, and civil engineers, were at first made. Various metals, as well as iron and steel, can acquire these properties, especially nickel and cobalt, but only in a very limited degree; and it is believed that they pertain to all bodies, the earth itself having been found to be a great magnet, with its north and south *magnetic poles*, which attract the opposite poles of the steel magnet or compass needle. The north magnetic pole is in latitude $70^{\circ} 5'$ N., longitude $96^{\circ} 46'$ W., as stated on page 52; and the south magnetic pole at about latitude 73° S., longitude

154° E., its exact location having never been accurately determined.

Magnetism is one of the many forms in which energy manifests itself through matter as its medium, and, like electricity, it is believed to be a mode of molecular motion, propagated by vibrations of the molecules and undulations of the ether. Hence we find, in different substances, magnetic conductivity and resistance, similar to electric conductivity and resistance; and we have also magnetic induction, magnetic potential and difference of potential—magnetic influence emanating from magnetized bodies as electric influence emanates from electrified bodies.

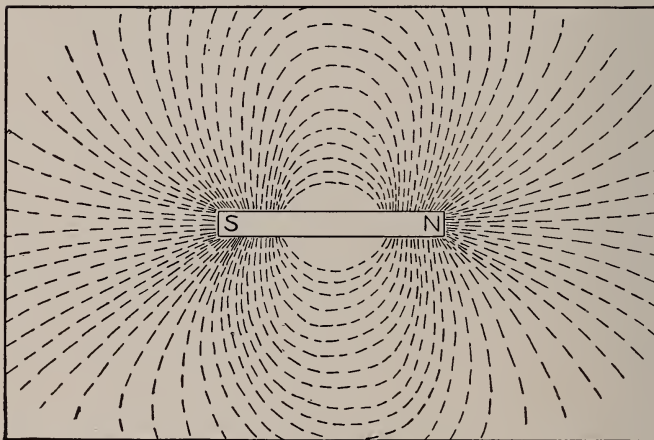

Fig. 40.

MAGNETIC LINES OF FORCE.—The existence and position of the *magnetic lines of force*, representing this influence, may be made manifest by a very simple experiment. Place a sheet of stiff paper over a steel bar mag-

net, and dust iron filings over it, tapping the paper gently, and the filings will arrange themselves in conformity with the position of the lines of force, as shown in Fig. 40, or rather, will be moved into this position by the magnetic force. Now if it were possible to make the filings adhere properly in any other position of the paper, without dropping off by their own weight, a similar result would be obtained at any angle in which the paper might be placed while parallel to the magnet. From which it is evident that this flat figure is a cross-section of a spheroidal figure, represented by the lines of force which inclose the magnet.

These lines, which are the result of magnetic induction in the space surrounding the magnet, appear to emanate from each end and curve toward the opposite end; but it is believed that, in reality, they emanate from one end, which has positive magnetic potential, and curve to the other, which has negative, by virtue of the difference of potential between the ends, the return circuit being through the magnet, in the opposite direction.

THE EARTH'S MAGNETISM.—The shape of the earth is similar to that of the above figure, and lines of magnetic force circulate round it in a similar manner, from one of its magnetic poles to the other. Hence a straight magnet, or magnetic needle, which has a free horizontal motion, is forced into a north and south position conformable to these lines, and we call the end which points north its north pole and mark it *N*, and that which points south its south pole, and mark it *S*. But the polarity of each is opposite to that of the earth's pole toward which it points; for each pole of a magnet attracts that pole of another magnet which has opposite polarity, but repels the pole which has similar polarity.

When such a needle has a free vertical motion, its position conforms to that of the lines of force in a similar manner, tending constantly to assume a vertical position when moved in the direction of either of the earth's magnetic poles, and becoming vertical at each pole, but tending to assume a horizontal position when moved toward a great circle midway between these poles, which is the earth's *magnetic equator*, and becoming horizontal at this equator. The vertical angle assumed by the needle at any point is called its *dip* or *inclination*, for that point. The needle's north pole dips in the northern hemisphere, and its south pole in the southern hemisphere.

AGONIC LINE.—As the needle always points to one of the earth's magnetic poles, it is evident that it can also point to the adjacent geographical pole, that is, directly north and south, only when on a meridian which passes through both these poles, and that there can be only one such meridian. This meridian is known as the *agonic line*, or line of no angle, because the needle makes no angle with this line, while at every point east or west of it, the needle, pointing only to the magnetic pole, declines from a true north and south position, making the angle known as its *declination*, this declination being eastward when the needle is west of this line, and westward when east of it.

The agonic line now passes through the United States, near Charleston, S. C., Toledo, O., and the west end of the Straits of Mackinaw. Hence, the compass needle on a vessel sailing from Chicago to Buffalo shows constantly decreasing east declination till the Straits of Mackinaw are reached, when it points directly north, and constantly increasing west declination from that point to

Buffalo; these variations occurring in reverse order on the return trip.

The position of this line is slowly shifting continually, with corresponding variation of declination. It reached its eastern limit, a short distance east of Washington, D. C., in 1797, and has since been moving westward. It will probably reach some point a short distance east of Chicago during the last half of the next century, and then move eastward again for a corresponding length of time.

Both dip and declination vary considerably at different points; hence lines of equal dip and equal declination, as drawn on magnetic maps by connecting such points respectively, show great irregularity, which must be ascribed to various local causes which produce variation in the earth's magnetism. And as the total magnetic *intensity* at any point is the result of the combined effects of dip and declination, this intensity also shows corresponding irregularity.

STEEL MAGNETS.—Steel bars, or compass needles, of any convenient size or shape, when properly tempered, are easily magnetized permanently by contact with a magnet. The usual method of accomplishing this is to place the bar or needle which is to be magnetized in a horizontal position, and placing the opposite poles of two bar magnets in contact on its center, the outer end of each being elevated at a convenient angle, draw them apart to the opposite ends of the bar and bring them together again at its center a number of times alternately, stroking each side in this way an equal number of times, and quitting at its center. Another, and much more effective method, is to place the bar or needle inside a spiral coil of insulated copper wire, through which a

strong current of electricity is then transmitted, by which it will be permanently magnetized.

Magnets made in the form of a horseshoe, or the letter U, as shown in Fig. 41, are the best for many practical

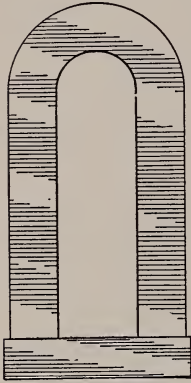

Fig. 41.

purposes. The two poles being thus brought near each other, the magnetic energy is concentrated on a small space which it traverses from one pole to the other, so that both poles can be employed for the same purpose, furnishing twice the energy of one.

Steel magnets retain their magnetism for an indefinite length of time, unless heated to a white heat, or subjected to violent concussion, either of which may destroy it; but it becomes impaired in the course of years, especially in straight magnets or compass needles, which require to be remagnetized from time to time to maintain requisite efficiency.

By placing a piece of soft iron across the poles of a U magnet, as shown in Fig. 41, this magnetic loss is greatly reduced. The iron having high magnetic conductivity, the lines of force circulate through it freely, while this circulation is greatly impeded by the high magnetic resistance of the insulating air, and the magnetic energy thus impaired. This piece of iron is called the *keeper* or *armature*, from its ability thus to protect the magnet against magnetic loss; and it becomes a magnet during its connection, having poles opposite to those of the magnet, at the points of connection.

PORTATIVE FORCE.—The lifting power of a steel magnet, which is a result of its attraction, is called its *portative force*, and is much stronger in a U or horseshoe

magnet than in a bar magnet, since both poles can be employed to sustain a weight attached to the armature. A magnet may thus sustain several times its own weight. By increasing the weight gradually, day by day, the portative force may be increased, but this increase is lost if the weight becomes so great as to separate the armature from the magnet.

EFFECT OF BREAKING A MAGNET.—If a magnet is cut or broken into two or more pieces, each piece becomes a separate magnet, with north and south poles in the same relative positions as in the original magnet, as shown in Fig. 42. But if the pieces be pressed closely together, their



Fig. 42.

poles disappear, leaving only the two original poles. Which shows that the magnetic energy traverses the magnet constantly from one end to the other; so that the number of poles may be considered infinite, all arranged in the same relative position as the end poles—there being two of opposite polarity on opposite sides of any cross line, the relative polarity of which is not changed by the breaking.

CONSEQUENT POLES.—It is possible, however, to magnetize a bar oppositely in alternate sections, and thus produce a magnet in which the polarity of each alternate section is reversed, producing what are called *consequent* poles; two north poles being in contact at one sectional junction, and two south poles at the next, and so on alternately, as if the sections were separate magnets joined together by their similar poles.

MAGNETIC ATTRACTION AND REPULSION.—North and south polarity being regarded simply as positive and negative magnetic potential, as already stated, the same principle is found in magnetism as in electricity; difference of potential producing attraction, and equality of potential producing repulsion. Hence either pole of a magnet attracts that pole of another magnet having opposite polarity, by virtue of this difference of potential, but repels that pole having similar polarity, by virtue of equality of potential; a north pole and a south pole attracting each other, but two north poles or two south poles repelling each other; while either pole attracts unmagnetized iron or steel, and is attracted by it, on account of difference of magnetic potential.

ELECTROMAGNETISM.—It is remarkable that the intimate relationship now known to exist between electricity and magnetism was unknown till 1819, when the discovery was made by Oersted of Copenhagen that the magnetic needle can be deflected by the electric current into a position at right angles to the current; the direction in which its opposite poles are deflected depending on the direction in which the current flows. This discovery marks one of the most important epochs in the progress of electric science, opening the way for that wonderful electric development which has since been achieved, chiefly through that branch of electric science known as *electromagnetism*, the foundation of which was thus laid.

DEFLECTION OF THE MAGNETIC NEEDLE BY THE ELECTRIC CURRENT.—Oersted's experiments are illustrated by Fig. 43, which shows, at *A*, *B*, *C*, and *D*, the four different positions which a balanced magnetic needle tends to assume when placed parallel to a wire through which an

electric current is flowing in the different directions indicated by the arrows; its poles being deflected in opposite directions as the current flows from right to left, or from left to right, under or over the needle. By comparing *A* with *C*, and *B* with *D*, it will be seen that the needle assumes the same position when the current

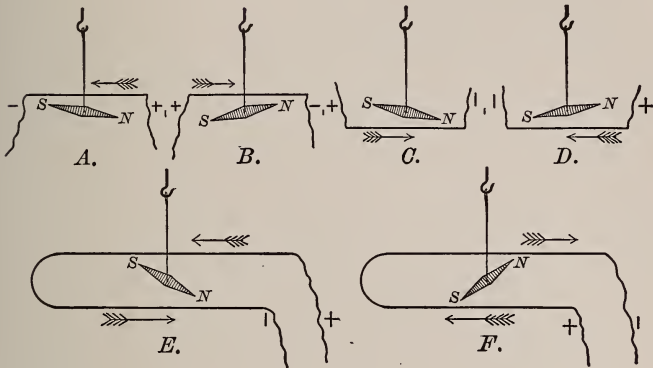

Fig. 43.

flows under it in the opposite direction to that in which it flows over it. Hence when the current flows round it lengthwise, in opposite directions above and below, as at *E* and *F*, it is deflected with twice the force, the under current deflecting it in the same direction, in each case, as the upper current.

By placing the wire in any other relative position to the needle, the same deflective effect is obtained; the needle always tending to assume a position at right angles to the direction of the current. Ampère gave this very simple rule for ascertaining the direction in which either pole is deflected. Imagine a little human figure, with its face toward the needle, traversed by the current,

which enters at its feet and leaves at its head; its extended left hand will always point in the direction in which the north pole is deflected, the south pole being of course deflected in the opposite direction.

If the wire incloses the needle as a spiral coil, through which, viewed endways, the current circulates in the same direction as watch-hands move, then, according to Ampère's rule, the north pole will be turned from the observer, and the south pole toward him; but if the direction of the current is reversed, the direction of the poles will be reversed also.

If an unmagnetized steel bar or needle is magnetized in this way, as already explained, its polarity will be permanently established in accordance with this rule. A soft iron bar, or needle, will be temporarily magnetized in a similar manner during the transmission of the current, acquiring its magnetism almost instantly when the current flow begins, and losing it as quickly when this flow ceases.

ELECTROMAGNETS.—Magnets so constructed as to be

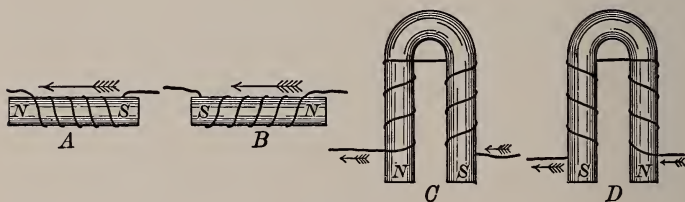

Fig. 44.

temporarily magnetized in this way are called *electromagnets*. Their construction is illustrated by Fig. 44. The spiral winding shown at A being the reverse of that shown at B, the spiral flow of the current is the reverse,

though its general direction is from right to left in each magnet, as indicated by the arrows. Hence, according to Ampère's rule, the little figure's left hand would indicate a north pole at the left in *A* and at the right in *B*. If each magnet, wound in this way, were bent into the form of a **U**, as shown at *C* and *D*, the polarity of *C* would be the same as that of *A*, and the polarity of *D* the same as that of *B*. But if the general direction of the current were reversed in each magnet, so that it flowed from left to right, the polarity would be reversed. Hence the relative polarity of the poles, in any electromagnet, depends on the direction of the winding and the general direction of the current.

Of course the wire in a **U** or horseshoe magnet is always wound after the magnet is bent into proper form, as in other magnets; but it must be wound as shown at *C* or *D*, the wire crossing to the opposite side of the bend, otherwise the end poles would both have the same polarity, and there would be consequent poles at the bend, whose polarity would also be the same, but opposite to that of the end poles.

There are usually a number of layers of this wire, which is wrapped with insulating material and closely wound like thread on a spool; in fact, it is often wound on spools, which are afterward placed on the limbs of the magnet, as shown in Fig. 45.

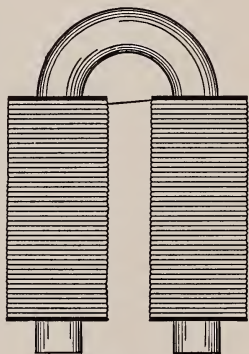

Fig. 45.

MAGNET CORE.—The iron part of an electromagnet is called its *core*, which should be made of the very best

quality of soft iron, capable both of acquiring and losing its magnetism in the shortest time; quick loss being as important as quick gain for most practical purposes, in which magnetic gain and loss usually alternate in rapid succession. The quantity of wire should be properly proportioned to the quantity of iron in the core, and should be just sufficient to produce magnetic saturation of the iron. Wire in excess of this is not only a wasteful incumbrance, but reduces the magnetic efficiency by increasing the electric resistance. The size of the wire and the number of times it should be coiled round the core depend entirely on the purpose for which the magnet is intended; the pressure of the electric current varying in nearly the same proportion as the number of coils, and its volume as the size of the wire, and the magnetism, up to the point of saturation, varying in nearly the same proportion. But both pressure and volume must be adapted to the requirements of the electric circuit with which the magnet is connected.

Electromagnets are far more powerful in proportion to their size than steel magnets. They may be of any required size, and are often made very large and massive in the construction of electric apparatus in which they are employed, as dynamos and motors, sometimes weighing several tons.

SOLENOIDS.—A coil of wire through which an electric current is flowing shows magnetic properties similar to those of an electromagnet, but much weaker than those of a similar coil having a soft iron core. Such a coil, if suspended so as to have a free horizontal motion, as shown in Fig. 46, will assume a north and south position, and its poles will be attracted by the poles of a magnet or coil having opposite polarity, but repelled by those

having similar polarity, like a magnetic needle. Coils made to illustrate this principle are usually shaped like a tube, as shown in Fig. 46, and are therefore called *solenoids*, the word solenoid meaning tube-like.

The reason why the magnetism of an electro-magnet is so much stronger than that of a solenoid is because the iron core, on account of its high magnetic conductivity, absorbs the magnetic lines of force, and permits their free circulation, while, in the solenoid, they encounter the high resistance of the insulating air.

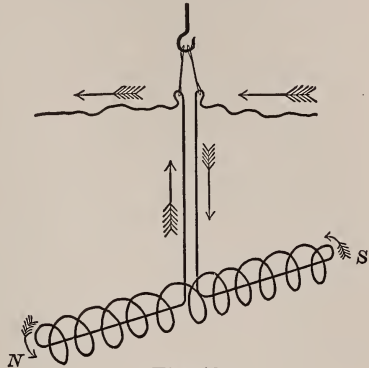

Fig. 46.

AMPÈRE'S THEORY OF MAGNETISM.—Since a current of electricity, circulating in a wire coil, produces magnetism either in the coil itself or in an iron or steel bar enclosed within it, as shown above, Ampère inferred that such currents are in constant circulation in different directions round the molecules of iron and steel and other metals capable of acquiring magnetism, and that the magnetizing process causes these currents all to circulate in the same relative direction, producing the magnetic effects; this direction remaining permanent in steel, but being only temporary in soft iron, in which the irregular circulation is resumed as soon as the magnetizing process ceases.

These currents, in a magnetized bar, would evidently circulate in opposite directions on adjacent sides of the

molecules, as shown in Fig. 47, in which the little circles represent the molecules, round which the currents circulate in the direction shown by the arrows; hence they would all neutralize each other in the interior of the

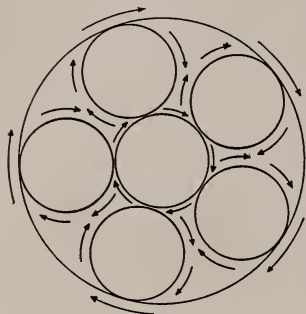

Fig. 47.

bar, leaving only the surface currents to circulate round it, as shown, just as they do in the coils of an electro-magnet, thus accounting for the permanent magnetism of steel magnets, round which, according to this theory, electric currents are in constant circulation.

Ampère's theory is not inconsistent with the more recent theory, already given, that magnetism is a mode of molecular motion, the magnetizing process, according to the latter theory, producing harmony of vibration among the molecules, while, according to Ampère's theory, it produces harmony of electric circulation round them. But there is no reason why the magnetic vibration should interfere with the electric circulation, while it is not improbable that harmony of vibration may produce harmony of circulation by bringing all the molecules into the same relative position.

The magnetism of the earth has been attributed to the circulation of east and west currents round it continuously in the same direction, that is, from any given point, on one side, and toward the same point on the opposite side. But the existence of currents circulating in this way has never been established, while the east and west currents, which have been observed, circulate in

the same direction on opposite sides, from the side exposed to the sun's rays to the opposite side; and therefore the magnetizing effect of each current is neutralized by the opposite magnetizing effect of the other, both tending to produce opposite poles at the same points north and south, as shown by Ampère's rule. For it is evident that, as the earth revolves, any point on its surface has an east to west current for twelve hours, and a west to east current for the next twelve, alternately, as explained on page 53; hence, when a point on one side has an east to west current, a point diametrically opposite to it has a west to east current.

MAGNETISM GENERATING ELECTRICITY.—As electricity generates magnetism, so magnetism generates electricity. If a steel bar magnet be suddenly thrust into the interior of a wire coil, a transient current of electricity will be generated in the coil, and when the magnet is withdrawn, a similar current, flowing in the opposite direction, will be generated. If the magnet were given a constant motion, in and out alternately in rapid succession, a corresponding series of these transient currents would flow through the coil alternately in opposite directions.

The direction in which each of these alternate currents would flow would depend on the relative direction of the magnet's poles, in accordance with Ampère's rule. A current produced by the entrance of the magnet's north pole first would be the reverse of that produced by the entrance of its south pole first.

If a bar of soft iron were inclosed within the coil, the approach of a steel magnet to the end of this bar, and its subsequent withdrawal, alternately, would generate electric currents in the coil in a similar manner, their relative direction, alternately, depending on the pole employed in

this way ; a current produced by the approach of a north pole being the reverse of that produced by the approach of a south pole.

An electromagnet or a solenoid coil can be employed in the same way as a steel magnet for these various experiments, producing similar results. If a straight bar electromagnet be placed within the coil, being insulated from it, an electric current transmitted through the magnet's coil will induce a transient current in the opposite direction in the outer coil, and when the current in the magnet's coil is interrupted, another transient current will be induced in the outer coil, which will flow in the opposite direction to that of the first transient current, and hence in the same direction as the current in the magnet's coil. By opening and closing the circuit of the magnet's coil in rapid succession, in this way, a series of these transient currents, flowing alternately in opposite directions, can be induced in the outer coil.

A similar result can be produced by alternately weakening and strengthening the current in the magnet's coil, which can be done by connecting the terminals of this coil by a wire through which a portion of the current can be diverted. By alternately opening and closing this *short circuit*, a full current, at one instant, and a partial current, at the next, traverses the coil alternately, inducing an alternating current in the outer coil, proportionally weaker than that induced by the opening and closing of the main circuit.

INDUCTION COILS.—Coils constructed on the above principles are known as *induction coils*, the construction of which is illustrated by Fig. 48. The inner coil, called the *primary*, is composed of a few layers of coarse wire, which inclose the soft iron core, and the outer coil, called

the *secondary*, is composed of many layers of fine wire, and is insulated from the primary coil.

Lines of force from the current transmitted through the primary coil, circulating through the secondary coil, induce the transient currents described; and as each turn of the wire in the secondary coil comes within this inductive influence, the electromotive force, or electric pressure, varies as the number of turns. But as the length of the

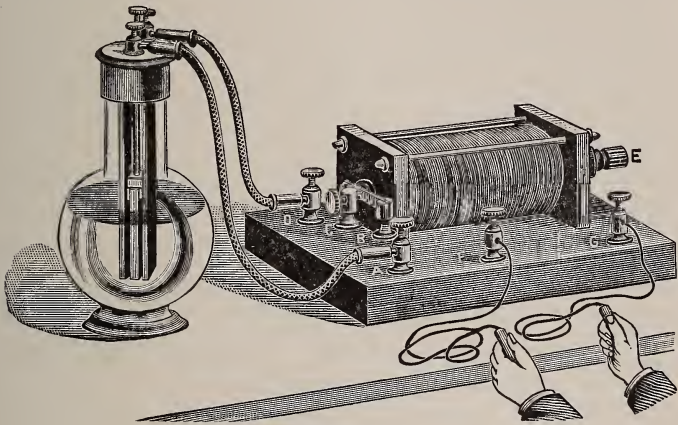

Fig. 48.

wire, and therefore its resistance, varies also as the number of turns, and the volume of current varies as the resistance, it is evident that as the electric pressure is increased by increasing the number of turns, the volume of the induced current is proportionally reduced by the increase of resistance. Hence, in this way, a primary current of large volume and low pressure can be transformed into an induced current of small volume and proportionally high pressure.

The two binding posts, *C* and *D*, in Fig. 48, are connected with the terminals of the primary coil, and the

posts *A* and *D* with the battery, as shown. Post *A* is connected by a wire with *B*, and to post *B* is attached a steel spring called a *vibrator*, which makes contact with the point of an adjusting screw attached to post *C*. Therefore the battery current can be transmitted from *A* to *B*, through the spring to *C*, through the primary coil to *D*, and thence back to the battery. Posts *F* and *G* are connected with the terminals of the secondary coil.

To the outer extremity of the vibrator is attached a little soft iron armature, which comes close to the end of the iron core of the primary coil; and when the battery current is transmitted, this armature is attracted by the magnetism of the core, and the spring pulled away from its contact with the screw in post *C*, opening the circuit at that point. The opening of the circuit interrupts the current, thus demagnetizing the core, and the spring flies back into contact with the screw, closing the circuit again. Thus the circuit is automatically opened and closed alternately, the opening being technically called the *break*, and the closing, the *make*.

The length of the vibrations is adjusted by the screw in *C*; and as the waves of current induced in the secondary coil correspond to these vibrations, their frequency can be controlled in this way, and, to a certain extent, their strength also, as each wave is either allowed to attain its full force during a long vibration, or is checked by a short vibration before attaining its full force.

The core is usually composed of a bundle of soft iron wires, to prevent the formation of eddy currents, to which solid cores are liable; the wires being soldered together at each end. It is inclosed by a copper tube, called a *shield*, which can be drawn out to any required

extent by the handle shown at *E*. This tube intercepts the mutual inductive action between the primary coil and core, an electric eddy current being induced in the tube itself, and thus weakens the induced current in the secondary coil, which can be regulated in this way, its strength being increased as the shield is drawn out, and reduced as it is pushed in. In some coils the current is regulated by a similar movement of the core itself, and in others by the movement of the primary coil, an electromagnet being employed to operate the vibrator. The vibrator is also constructed and operated in different ways.

The transient current induced in the secondary coil by the opening of the primary circuit has much greater electric pressure than that induced by its closing; which is due to the fact that a current is induced between the adjacent turns and layers of the wire in the primary coil by what is called *self-induction*, which flows in opposition to the battery current at the instant the primary circuit is closed, but in the same direction as the battery current at the instant the primary circuit is opened. Hence the battery current at *break* has far greater pressure than at *make*, and its inductive effect on the secondary coil is proportionally greater. This inductive effect becomes manifest in a bright spark between the terminals of the secondary coil when brought near each other, similar to that of an influence machine, while the induced current at *make* has not sufficient pressure to produce a spark in coils of the ordinary size, and only a weak one in the largest coils.

These sparks vary in length, from a small fraction of an inch to several feet, in proportion to the size of the coil. The largest coil in the world, that of Spottiswoode,

an English electrician, produces sparks $42\frac{1}{2}$ inches in length when operated by a battery of fifty Bunsen cells. It has 280 miles of wire in its secondary coil, and 660 yards in its long primary coil. It has also a shorter primary coil, by which shorter, thicker sparks are produced.

Induction coils are extensively used in medical practice, the induced current being applied by handles, sponge *electrodes*, and other apparatus attached to flexible conducting cords connected with the terminals of the secondary circuit, as shown at the posts *F* and *G*.

This current is known as the *faradic*, and is similar to the static induced current, already described, though not identical with it, and is employed in medical practice for similar purposes.

These coils are also used for various laboratory experiments illustrating the principles of electric science, such as electric transmission through vacuum tubes. They are also used to produce the sparks by which the gas is lighted in churches and audience halls, the spark being transmitted through the gas by a short break in the circuit at each burner. The primary coil alone is generally preferred for this purpose, being simpler, cheaper, and less liable to accidental injury.

ELECTRIC BELLS.—One of the most common uses of the electromagnet is to ring the electric bell. The construction of this simple apparatus is shown in Fig. 49. The clapper of the bell is attached to a soft iron armature *A*, supported near the poles of the electromagnet *B*, by the spring *C*. This spring makes contact with an adjusting screw at *D*. The coils of the magnet are connected with the battery circuit by the binding posts *E* and *F*; and this circuit passes through the spring *C* and screw at *D*.

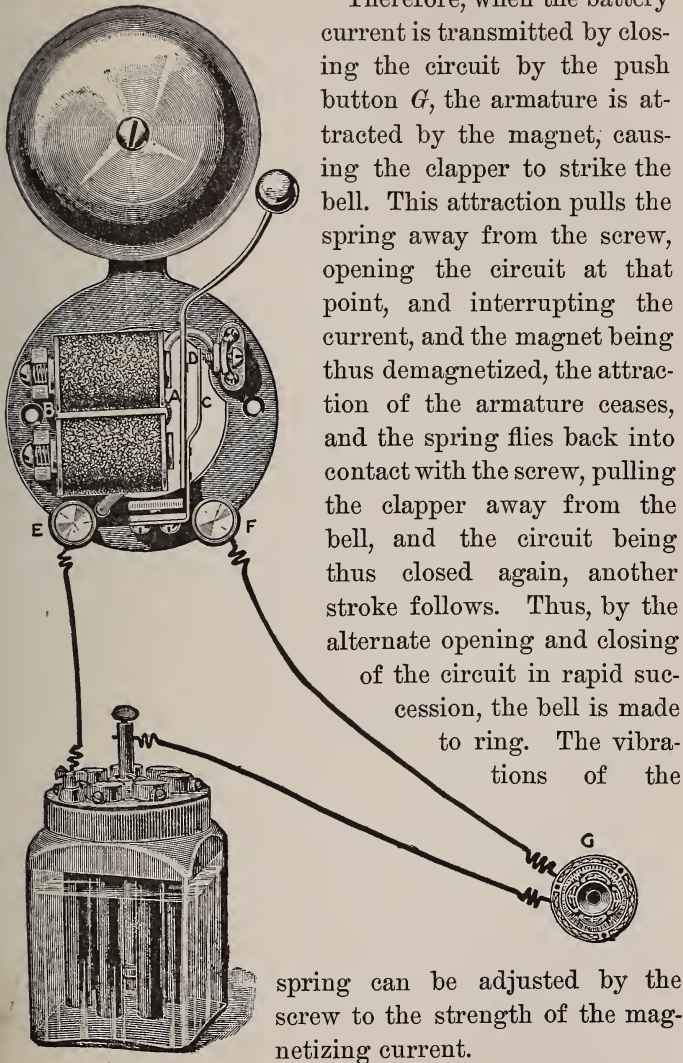

Fig. 49.

Therefore, when the battery current is transmitted by closing the circuit by the push button *G*, the armature is attracted by the magnet, causing the clapper to strike the bell. This attraction pulls the spring away from the screw, opening the circuit at that point, and interrupting the current, and the magnet being thus demagnetized, the attraction of the armature ceases, and the spring flies back into contact with the screw, pulling the clapper away from the bell, and the circuit being thus closed again, another stroke follows. Thus, by the alternate opening and closing of the circuit in rapid succession, the bell is made to ring. The vibrations of the

spring can be adjusted by the screw to the strength of the magnetizing current.

CHAPTER V.

DYNAMOS.

EVOLUTION OF THE DYNAMO.—It was shown in the last chapter that magnetism can be generated by electricity, and electricity by magnetism; and that by the mechanical movements of the poles of a steel magnet or an electromagnet in proximity to the poles of an electromagnet, a series of transient electric currents can be generated in its coils, flowing alternately in opposite directions in such rapid succession as to constitute an alternating current.

Small machines are made on this principle, as illustrated by Fig. 50, in which is shown an electromagnet mounted with its poles in proximity to those of a steel magnet

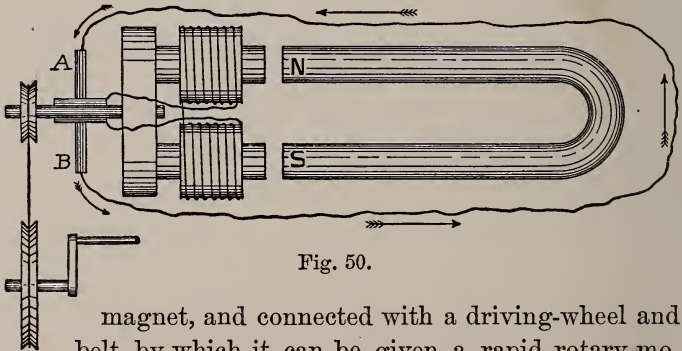

magnet, and connected with a driving-wheel and belt, by which it can be given a rapid rotary motion, so that its poles alternately rotate past those of the steel magnet, producing an alternate reversal of polarity

in its core by which an alternating current is generated in its coils.

By attaching two strips of copper, insulated from each other, to its axis, and connecting the terminals of the magnet's coils with them as shown, the current may be collected by the two copper *brushes*, *A* and *B*, pressing on these strips, and transmitted through the external circuit, as shown by the arrows.

If an electromagnet be substituted for the steel magnet as shown in Fig. 51, and the terminals of its coils con-

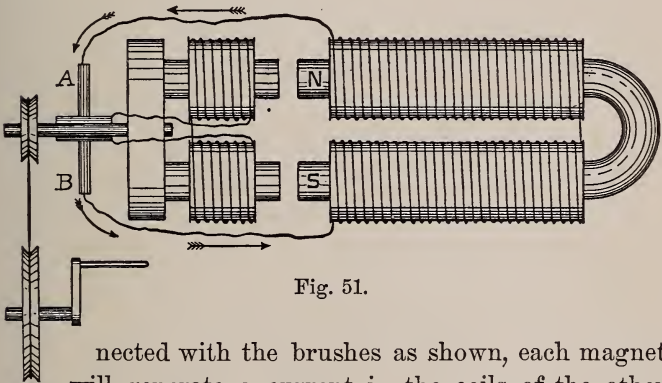

Fig. 51.

nected with the brushes as shown, each magnet will generate a current in the coils of the other magnet. This current is generated by a very small quantity of magnetism which is always produced in iron by the work done on it in preparing it for use, and is called *residual* magnetism; hence the current is very feeble at first, but as the magnetism is increased in each magnet by the current, and the current by the magnetism, the inductive effect being constantly multiplied in this way, the cores quickly become magnetically saturated, and a powerful current is thus rapidly generated, of far greater electric energy than can be generated by

the steel magnet. The cores, after being once magnetized in this way, always retain a residual magnetic charge.

As the relative positions of the two insulated copper strips with which the brushes *A* and *B* make contact are reversed at each half revolution, at the same instant that the transient currents generated in the coils of the revolving magnet are reversed, these currents must all pass out in the same direction by one brush and return by the other, and therefore circulate in the same direction through the external circuit and coils of the stationary magnet, as shown by the arrows. For if a transient current passes out by brush *B* and returns by brush *A*, then, when the strip in contact with *B* rotates into contact with *A*, if the current were not reversed it would pass out by *A* and return by *B*, but being reversed it must pass out by *B* and return by *A* as before. Hence the alternating current generated in the coils of the revolving magnet is transformed into a direct current in the coils of the stationary magnet and in the external circuit.

The revolving magnet is called the *armature*, because it generates the current, and the pair of insulated copper strips are called the *commutator*, because they are the means by which the alternating currents are *commuted*, or exchanged for a direct current.

Large machines constructed on these principles, for the generation of electricity, and driven by steam or water power, are called *dynamos*, from a Greek word which means power. They are divided into two principal classes, known respectively as *direct current* dynamos and *alternating current* dynamos, and, in each class, there are many different forms of construction. The direct current dynamos are divided into three

distinct classes, known respectively as the *series* wound, *shunt* wound, and *compound* wound.

DIRECT CURRENT DYNAMOS.—The general construction of the direct current dynamo is illustrated by

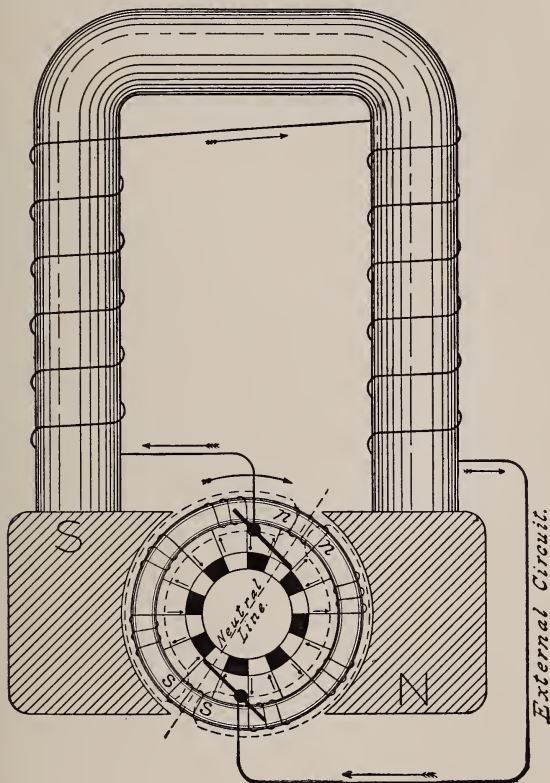

Fig. 52.

Fig. 52, which shows especially the construction of the series wound dynamo. The armature consists of a circular magnet mounted between two massive *pole-pieces* belonging to the stationary magnet, by which it is partly

inclosed, sufficient space being left on each side for it to revolve freely without contact.

The coils of both magnets being wound in the direction shown, when the armature revolves in the direction indicated by the curved arrow above, the current flows in the direction indicated by the other arrows, producing a north pole on the right and a south pole on the left in the stationary magnet, in accordance with Ampère's rule; lines of magnetic force flowing across from the north pole to the south, filling the space in which the armature revolves, and circulating in two magnetic currents through its core on opposite sides, from the lower corner of the right pole-piece to the upper corner of the left pole-piece. Hence this space is called the *magnetic field*, and the stationary magnet is called the *field-magnet*.

The electric current from the field-magnet, after traversing the external circuit as shown, enters the armature by the lower brush, and divides, like the magnetic current, into two equal currents, which circulate through its coils on opposite sides, and leave by the upper brush. Hence each half of the armature becomes a magnet, as indicated by the circular dotted lines, two north poles, marked *n n*, being produced above, and two south poles, marked *s s*, below, in accordance with Ampère's rule.

On account of this division of the armature current between two circuits, the wire used in the armature coils of series wound dynamos is much smaller than that used in the field-magnet coils, since it carries only half the volume of current in each circuit, while the field-magnet wire carries the full volume of current in a single circuit.

The commutator shown has eight copper bars, or *segments*, insulated from each other, the ends of which are

indicated by the circle of dark spaces, and the armature coils are attached to these in such a manner that each coil connects two segments, as shown. Hence the field-magnet current, entering by a segment through the lower brush, and dividing as described, must traverse every coil and segment on each side till it reunites and leaves by a segment through the upper brush. In like manner, the currents generated in the armature coils, being added to this current, traverse the coils on each side, from the lower to the upper brush. Magnetic lines of force are generated in the armature's core by this accumulated current, and circulate through it at right angles to the electric current.

The magnetic poles produced by these lines being in proximity to the similar poles of the field-magnet, mutual repulsion occurs between them, by which the north field-magnet pole is pushed downward on the right, and the north armature pole upward, the south pole of each magnet being deflected in the opposite direction, on the left. Hence the poles occupy the positions indicated by the letters, as already described. These poles constantly maintain these fixed positions, *the armature rotating through the positions occupied by its poles*. When, therefore, that part of the armature which has north polarity rotates downward from the polar position *nn* to that marked *ss*, the current traversing its coils is reversed as it crosses the *neutral line* on which the brushes are placed, and it acquires south polarity; the opposite section of the armature, which had south polarity, having, at the same time, rotated upward to the polar position *nn*, and acquired north polarity by a similar reversal of the current.

The current is reversed whenever two opposite com-

mutator segments come into contact with the two brushes. In the little armature shown in Fig. 51, which has two coils connected with two commutator segments, it was shown that a reversal of current occurs at every half revolution, and, therefore, two at every full revolution; so that the number of reversals is the same as the number of coils, or commutator segments, one occurring whenever an opposite pair of segments completes a half revolution. Hence the dynamo shown in Fig. 52, having eight coils connected with eight commutator segments, would have eight current reversals at each revolution, and, therefore, eight waves of current traversing its coils and external circuit. A dynamo may have forty or more coils and commutator segments, and may revolve at the rate of 2,000 revolutions a minute, and hence generate 80,000 or more current waves per minute.

If the brushes were moved so as to make contact with the commutator on a line at right angles to the neutral line, the current could neither enter nor leave at the polar positions where reversal occurs, consequently a current generated in any armature coil as it moved through a quarter circle, from a brush to the neutral line, on either side, would be neutralized by an equal opposite current as this coil moved through the next quarter circle, from the neutral line to a brush; so that there would be no current to flow in or out through the brushes.

Therefore, when the brushes are moved to any intermediate position between the neutral line and a line at right angles to it, there is a partial neutralization of the currents in this way, which varies in proportion to the distance of the brushes from the neutral line, increasing as they are moved away from it and decreasing as they are

moved toward it. And in this way, within certain limits, the dynamo current is regulated, the brushes being attached to a yoke having a handle by which they can both be moved at the same time, in either direction; their movement away from the neutral line being technically called giving them *lead*.

SERIES WOUND DYNAMO.—The dynamo described above is called *series wound* because its field-magnet is wound with wire large enough to carry the whole current which is transmitted through the armature coils, field-magnet coils, and external circuit, *in series*, as shown. Therefore any variation of the resistance encountered by the current in the performance of electric work in the external circuit, as the production of light or the operation of machinery, affects the whole volume of current, both in the internal and external circuits, requiring its regulation by a movement of the brushes as described, to maintain evenness of current.

SHUNT WOUND DYNAMO.—When a dynamo is so constructed that only a small part of its current is employed to magnetize its field-magnet, it is called *shunt wound*, because the magnetizing current is diverted from the main circuit through a *shunt* circuit. This construction is illustrated by Fig. 53. The field-magnet is wound with fine wire coiled round its core in a great number of turns. This wire, on account of its fineness and length, has high resistance, so that it carries only a small volume of current, ranging from $1\frac{1}{2}$ per cent. to 20 per cent. of the entire volume; but on account of the great number of turns in the winding, the electric pressure of the current is increased in the same proportion as its volume is diminished, so that it has high magnetizing power.

The external circuit, which is composed of large wire, and has, therefore, comparatively low resistance, carries the main current and is entirely independent of the field-magnet circuit, and both circuits are connected with the

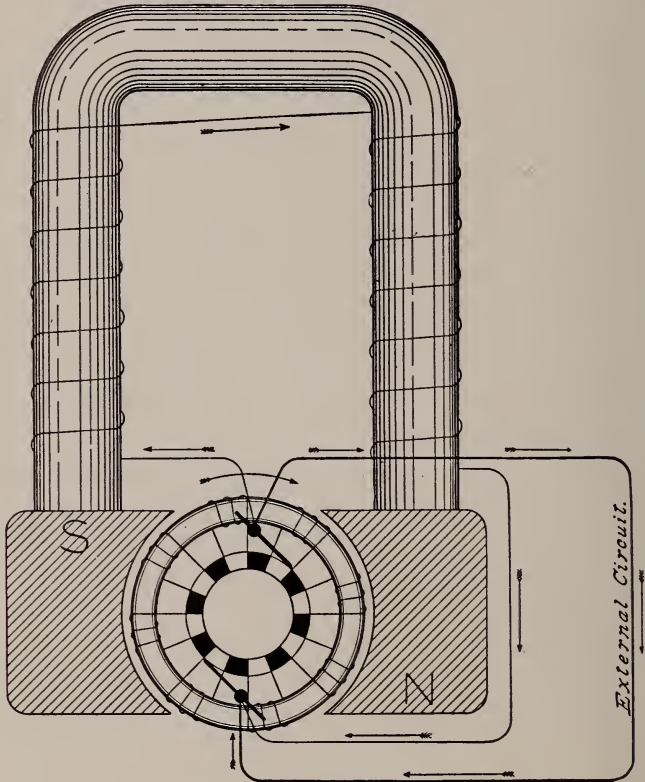

Fig. 53.

brushes as shown. Therefore the current, as it leaves the upper brush, divides in proportion to the resistance of each circuit, and, after traversing the two circuits, reunites at the lower brush.

When the current in the external circuit is employed for electric work, the electric resistance in this circuit being thus increased, the volume of its current is proportionally diminished; this causes an accumulation of electric energy which increases the electric pressure at the upper brush, where the current divides, much in the same way as an obstruction in a steam or water pipe increases the steam or water pressure; and as the resistance of the field-magnet circuit remains unchanged, a greater volume of current is transmitted through it, increasing its magnetizing energy, and thus supplying increased electric energy for the performance of the work in the external circuit. In this way a shunt wound dynamo becomes self-regulating within the limits of the magnetic saturation of its cores, beyond which its magnetizing energy cannot be increased.

COMPOUND WOUND DYNAMO.—The series and shunt methods of winding may be combined in the same machine, producing what is called the *compound* wound dynamo, which is illustrated by Fig. 54. In this dynamo there are two separate coils of wire wound on the field-magnet core, a coil of fine wire of many turns and a coil of coarse wire of fewer turns. The coarse wire coil is connected at the brushes with the external circuit, as in the series wound dynamo, while the fine wire coil, like that of the shunt wound dynamo, is also connected with the brushes, but has no connection with the external circuit. Both coils are employed to magnetize the field-magnet, the coarse wire coil carrying a current of comparatively large volume and low electric pressure, and the fine wire coil one of small volume but high electric pressure. Hence this dynamo combines the advantage of a magnetizing current of large volume in its field-

magnet circuit, through which the whole current flows as in the series wound dynamo, with that of high electric pressure in this circuit and of self regulation by the two circuits, as in the shunt wound dynamo. By a proper

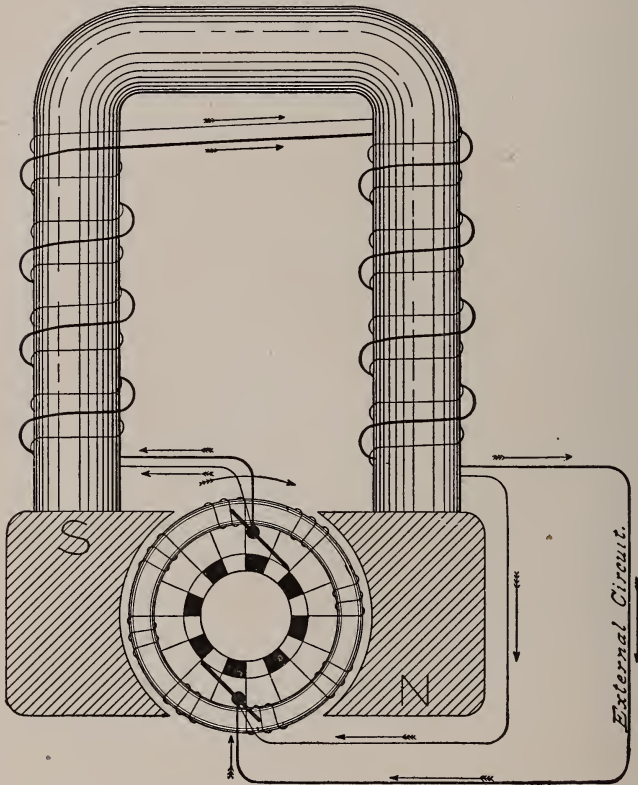

Fig. 54.

adjustment of the relative resistances of the two field-magnet coils the best combination for these purposes may be obtained.

CONSTANT CURRENT AND CONSTANT POTENTIAL.— These different dynamos differ in their adaptation to

different kinds of electric work. The series wound dynamo is found to be best adapted to work which requires a current to be maintained constantly at the same volume by varying the electric pressure in the same proportion as the resistance of the external circuit is varied by the quantity of work. Hence it is also called the *constant current* dynamo. But where the work re-

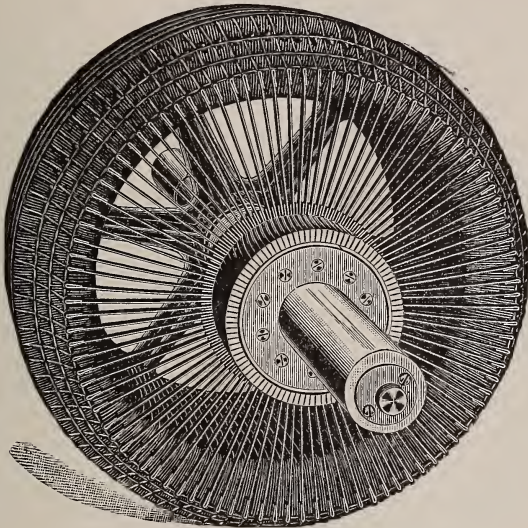

Fig. 55.

quires a current to be maintained constantly at the same electric pressure, or potential, while the volume of current varies as the resistance produced in the external circuit by the quantity of work, the shunt and compound wound dynamos are found to have the best adaptation. Hence they are also called *constant potential* dynamos.

ARMATURE CONSTRUCTION.—Armatures are constructed in different ways, but there are two leading kinds, known

respectively as the *ring* armature and the *drum* or *cylinder* armature. The ring armature, called also, from its inventor, the Gramme armature, is shown in Fig. 55. It consists of a wide iron ring, round which are wound a number of coils of copper wire wrapped with insulating material. This ring is attached by bolts to a narrow metal ring, without coils, mounted at the rear end with spokes on a steel shaft; and on the front end of this shaft is mounted the commutator, to whose bars the coils are attached by stout connecting wires or rods, as shown.

The core is made up of a number of thin, flat rings of soft sheet-iron, one of which is shown in Fig. 56, which are bound together by the bolts mentioned above, and insulated from each other with tissue paper. This produces a laminated core,



Fig. 56.

across which wasteful electric eddy currents cannot circulate in the iron under the coils, as in a solid core.

The drum, or cylinder armature, called also, from its inventor, the *Siemens* armature, is shown in Fig. 57. It is constructed in the form of a cylinder, and is of greater length than the ring armature, and of proportionally less diameter. The coils are wound lengthwise on a core

mounted directly on the shaft, round which they curve at each end, as shown, crossing spirally from one side of the cylinder to the other, so that there is no interior wire, as in the ring armature; and their ends are attached to the commutator, as shown.

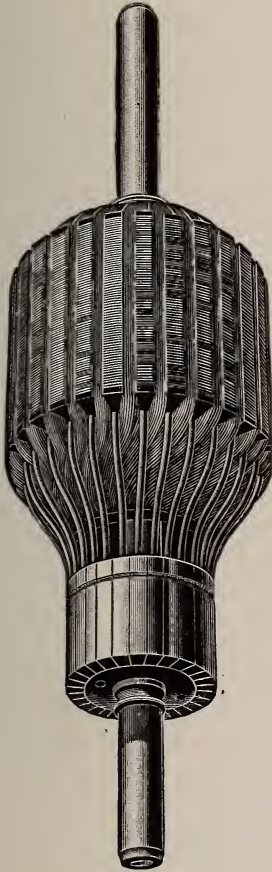

Fig. 57.

This core is also laminated, being composed of sheet-iron disks, insulated as above, one of which is shown in Fig. 58. In its centre is a hole for the shaft, and around this are four holes for ventilation, which, being placed in line in the several disks when the core is constructed, make four ventilating tubes which, in some armatures, connect with narrow openings, at intervals, between the disks.

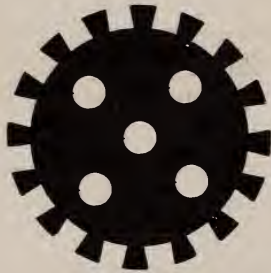

Fig. 58.

In the circumference are projecting teeth, between which, when placed in line, are long grooves, in which the coils are wound, as shown, and confined either by wooden

wedges above them or by metal bands round the armature; armatures of this kind being called *iron-clad*.

This method of construction is also employed in the ring armature, and is called, from its inventor, the *Paciniotti* method. Its principal advantage is that it brings the iron of the core close to the pole-pieces of the field-magnet, thus reducing the magnetic resistance to its lowest practical limit. The lamination is shown at the ends of the teeth in Fig. 57. The core of this armature is also constructed with a plain surface, like that shown in Fig. 56; also without ventilating openings.

Each of these methods of construction has its special advantages. The coils can be more securely confined when wound round a ring than when wound on the surface of a cylinder, and are less liable to displacement by centrifugal force. Hence the ring armature can be made of any required diameter; and by giving it large diameter, its rotary speed can be proportionally reduced without reduction of its efficiency. But as the wire in its interior and on its ends takes little or no part in electric generation, acting merely as a conductor of the currents generated in the exterior wire, it increases the cost without corresponding increase of efficiency. One of the principal advantages of the ring armature is the interior ventilation obtained by its open structure, which is of the highest importance in preventing the injurious accumulation of heat in its coils and core.

The cylinder armature has the advantage of a more compact mechanical structure, and of less wire in proportion to its efficiency, the only idle wire being that on the ends. But its diameter is limited by the difficulty of properly securing its coils against displacement in an armature of large diameter, especially on a plain surface core;

and the accumulation, in such an armature, of a mass of comparatively idle end wire confines the heat with overlapping coils, and prevents proper interior ventilation. This limitation of its diameter requires higher speed to produce the same electric efficiency, the efficiency of an armature being largely dependent on the number of lines of magnetic force cut by its coils per second or minute.

CONSTRUCTION OF BRUSHES AND COMMUTATOR.—The brushes are insulated from each other, and are usually composed of strips of copper, soldered together at their outer ends, and beveled at the ends in contact with the commutator. Each brush is usually divided into two or more sections, as shown in the dynamo in Fig. 59, which are confined in clamps with set-screws, and can be easily removed for repairs or replacement. Pressure on the commutator is produced by spiral springs, as shown in the lower brush; and by the connecting yoke shown, the brushes can be moved to or from the neutral line, for regulation of the generating electric pressure, as already explained.

Brushes are also made of solid strips of carbon, which are often preferred to copper brushes, as they wear the commutator much less and more evenly, leaving its surface always smooth, and seldom producing sparks at the point of contact.

The beveled point of the brush must be broad enough to bridge the space between adjoining commutator bars, so as to make contact with the approaching bar, as the commutator rotates, before breaking contact with the receding bar, thus preventing interruption between the successive waves of current, and a spark at each break.

The commutator is insulated from the shaft, and has usually a ventilating space underneath. Its bars are

insulated from each other, usually with mica, and are securely bound together by metal collars, insulated from them and fitted to beveled shoulders at the ends, and the surface is finished in a lathe, so as to be perfectly even and smooth.

BIPOLAR DYNAMO.—The dynamo shown in Fig. 59 is called *bipolar* because it has only two poles, and is com-

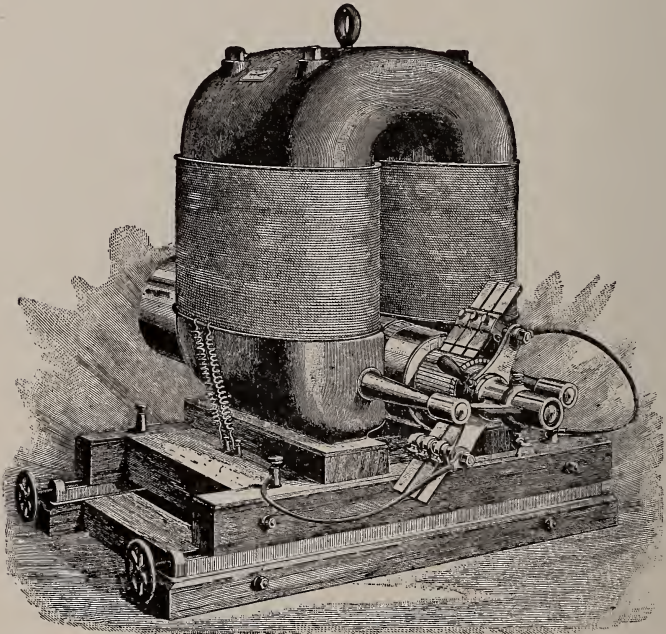

Fig. 59.

pound wound, two terminals of the two coils in its field-magnet being shown on the left; the conductors connecting these coils with the brushes are shown in front, and one of the two binding-posts for connecting them with the external circuit is shown in the rear; the other con-

nections being made underneath. All angular projections in the field-magnet core, connecting yoke above, and pole-pieces below, are carefully avoided, the corners being rounded to prevent magnetic loss by the escape of magnetic lines of force into the air, to which angular corners are liable. The joints in these parts are all so closely fitted as to be invisible, thus preventing magnetic resistance from imperfect contacts. The armature is of the cylinder type, and the band-wheel, by which its rotation is produced, is shown in the rear.

Field-magnet cores and the parts connected with them are usually made of cast-iron, as in this case; lamination being of less importance than in armature cores, and cast-iron cheaper than laminated iron.

MULTIPOLAR DYNAMOS.—Direct current dynamos are sometimes constructed with a field-magnet having a circular yoke from which a number of poles project inward; the coils being wound on these polar projections in such direction as to produce alternate north and south poles all around. A dynamo of this kind is called *multipolar*, and may have as many poles as can be conveniently attached to its field-magnet yoke.

In Fig. 60 is shown a four-pole dynamo of this construction. Its field-magnet coils are wound on bobbins fitted to the cores, so that they can easily be removed for repairs or replacement; and a pole-piece is attached to each core. These four alternate poles produce four alternate poles in the armature, on two neutral lines which cross each other at right angles; and hence four brushes are required, one at each polar position in the commutator, the two positive brushes being connected together, and likewise the two negative. There are therefore twice as many current reversals at each revolution

of the armature as in a two-pole dynamo having the same number of armature coils, and twice as many waves of current traversing the external circuit. Hence, in a dynamo of this construction, the rotary speed of the armature need be only half that of a two-pole dynamo

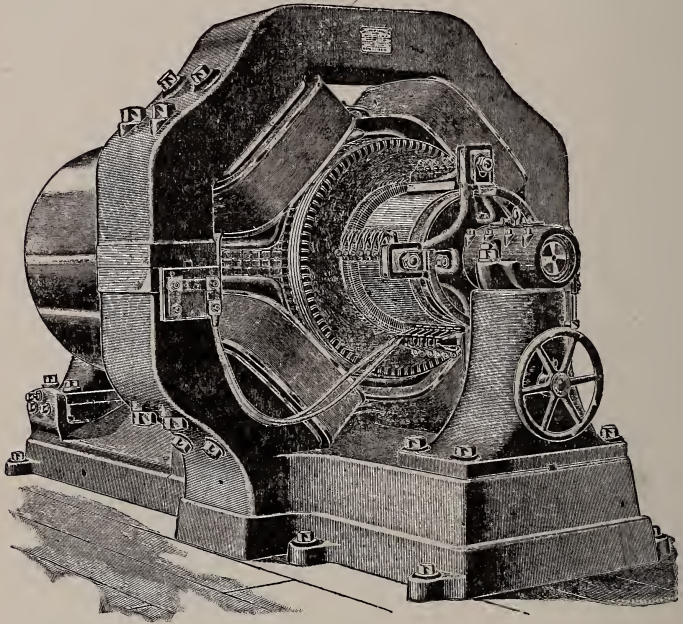

Fig. 60.

having the same number of armature coils, to produce the same number of current waves per minute. In like manner any further increase in the number of poles can produce a corresponding reduction of armature speed, a six-pole dynamo requiring only one third the speed, and an eight-pole dynamo only one fourth the speed. And as the generation of electric energy depends on the num-

ber of electric waves produced per minute, as well as on the magnetic strength of the field, it is possible, by this construction, to reduce the armature's rotary speed, in a field of given magnetic strength, without reducing the electric energy. But the proportion in which this can be done depends on the quantity of power employed to rotate the armature against the electromagnetic force, and on the general construction of the dynamo.

In the construction of large dynamos for special electric work the multipolar method has the advantage of shortening the magnetic circuit between the poles, and thus reducing the magnetic resistance, which, in large two-pole dynamos, is liable to become excessive, requiring corresponding increase in the massiveness of the cores and connecting yoke for its reduction. But the two-pole construction is cheaper and less complicated, and hence is generally preferred for small dynamos.

ALTERNATING CURRENT DYNAMOS.—A dynamo constructed without a commutator for making the current direct in its external circuit, produces an alternating current. One of this construction is shown in Fig. 61. Two copper rings, mounted on the shaft near the front end of the armature, take the place of the commutator. These are insulated from each other, and each is connected with a separate terminal of the armature circuit. The current is collected from these rings by two brushes, each of which is connected with a separate terminal of the external circuit, so that the current-waves, traversing this circuit, pass out from one ring and return to the other by the brushes, alternately in opposite directions.

The field-magnet is of the multipolar type, a large number of coils, wound in one continuous circuit, being attached to a circular yoke, the winding alternately in

opposite directions, so as to produce alternate poles of opposite polarity.

The armature is of the cylinder type, but the coils do not cross at the ends, from side to side, as in direct current armatures of this type, but are wound back and forth in deep grooves on the face of a laminated core, round the projections between the grooves, and held in place by wooden wedges above them, making the armature *ironclad*, the iron projecting above the coils. These coils are also wound alternately in opposite directions, in one continuous circuit, producing alternate poles of opposite polarity.

As the armature revolves, and its poles rotate past those of the field-magnet, a current is generated in all its coils at the same instant, which follows the winding in the same direction. This current is reversed at the next instant by the reversal of polarity, as the armature poles rotate past the adjacent field-magnet poles, following the winding in the opposite direction, this action being sustained continuously by the rotation, with alternate reversal of the armature current in this manner.

In large dynamos of this construction, like that shown in Fig. 61, the field-magnet is separately excited by a small direct current dynamo, called the *exciter*, which is run by a belt from the band-wheel shown on the right, while the large dynamo is run by the band-wheel on the left. The current from the exciter traverses a set of fine wire coils, wound on the field-magnet cores, but does not magnetize the field sufficiently for heavy electric work. Hence a separate set of coarse wire coils is also wound on these cores in the same direction, alternately, as the others, and connected with the armature coils by brushes through the commutator shown at the right of the two

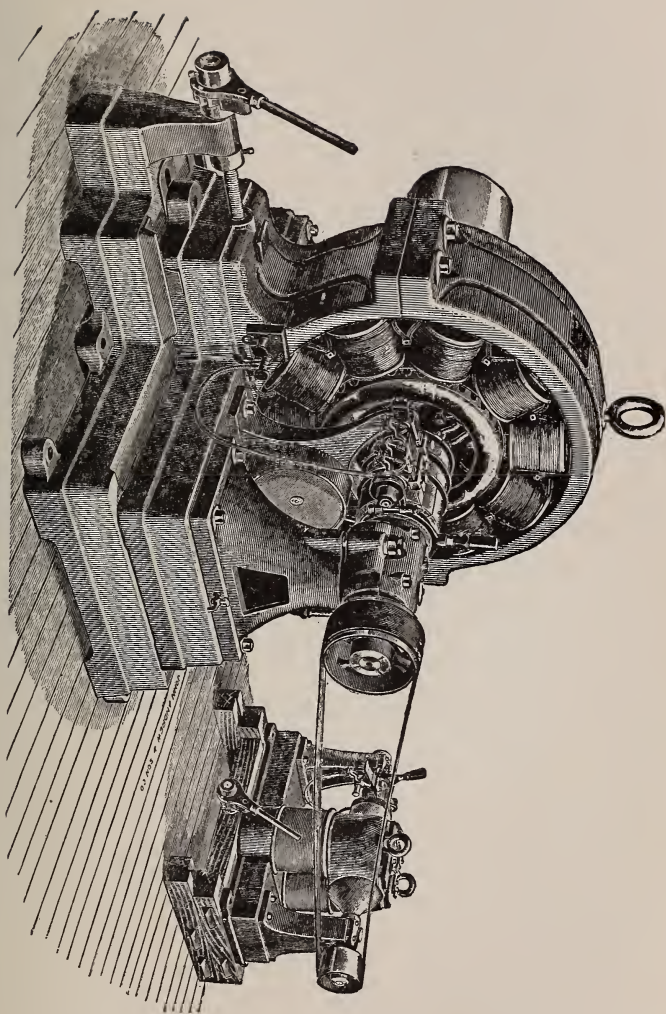

Fig. 61.

collecting rings, by which part of the armature current is made direct for the purpose of magnetizing the field. Increase of electric resistance in the external circuit, caused by the increase of electric work, produces a proportional increase in the volume of this magnetizing current, and decrease of resistance, a corresponding decrease in the volume of current, in the manner explained on page 123, thus making this dynamo self-regulating within the limits of the magnetic saturation of its cores, as in direct current shunt and compound wound dynamos. This magnetizing current can be varied by the movement of the brushes on the commutator, as in direct current dynamos, producing corresponding variation in the pressure and volume of the main current.

TRANSFORMERS.—The electric pressure at which the alternating current is generated by large dynamos ranges usually from 1000 to 5000 volts. This pressure is much higher than necessary for ordinary electric work, but is capable of transmitting a current through a comparatively small copper wire, having high electric resistance, to a distance of several miles with but little loss, thus effecting a great saving in the cost of copper wire in a long external circuit. The current transmitted at this high pressure can be reduced to a current of low pressure, with corresponding increase of volume, at the place where it is required for use. This is accomplished by an instrument called a *transformer*, which is practically an induction-coil of special construction, as illustrated by Fig. 62.

Like the induction-coil, it has an iron core and two coils of copper wire, a primary and a secondary, which are insulated from each other and from the core in the most thorough manner. The core, instead of being

inclosed within the coils, partly incloses them, and is composed of a number of sheet-iron plates insulated from each other with tissue paper, forming a laminated structure like that of an armature core, which is bolted together in an iron frame, as shown. This construction brings the core equally close to both coils, as shown in

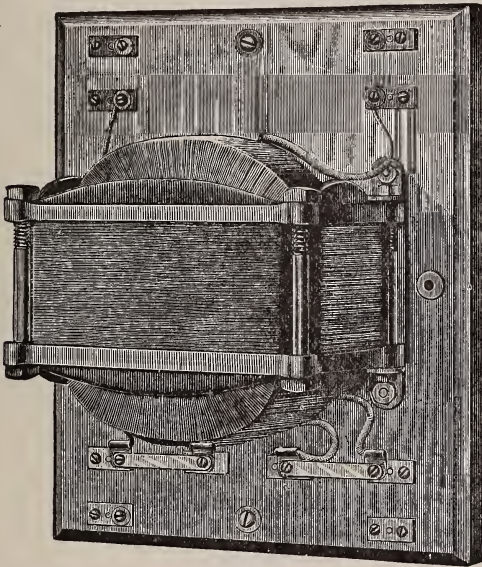

Fig. 62.

the cross-section in Fig. 63, so that both are equally exposed to its magnetic inductive influence, instead of the secondary coil being separated from it by the primary, and hence receiving only a minor share of that influence, as in induction-coils.

The fine wire coil is usually made the primary and connected with the dynamo circuit, while the coarse wire coil becomes the secondary, and is connected with the

lamp or motor circuit where the work is to be done. Hence the electric transformation is usually the reverse of that in the induction-coil, being from high to low electric pressure, with corresponding increase of current volume, instead of from low to high pressure with corresponding decrease of current volume. Thus a dynamo current of a 1000 volts pressure may be transformed into an electric lighting current of 50 volts pressure and

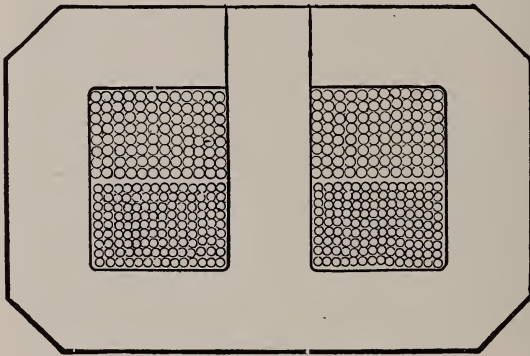

Fig. 63.

twenty times the volume, adapted to the supply of a large number of incandescent lamps or small motors. Such a current can be employed in a building with perfect safety, while a 1000-volt current would be dangerous.

Where this current is transmitted to a distance of several miles at a high pressure, it is received at the station by a large transformer, which is divided into several sections, each of which bears its proportional part in the transformation; each one of ten sections, for instance, performing a tenth part of the work. From this station it is distributed to the buildings in a large district, at each of which it passes through a small transformer, and

its pressure is again reduced. Thus a current of 4000 volts may be reduced in the large transformer to 400 volts, and in each small transformer to 50 volts.

The transformer may be employed for increasing instead of diminishing the electric pressure, by reversing the usual connection of its coils with the dynamo and circuit. Thus a low-pressure current may be transformed into a high-pressure current, at the generating station, for the purpose of long distance transmission, and be transformed oppositely to a low-pressure current, at the receiving station. A 54-volt current has, in this way, been transformed into a 30,000-volt current, transmitted more than 100 miles, and then reduced to a 100-volt current, with a total loss of only 28 per cent. of efficiency.

CHAPTER VI.

ELECTRIC MOTORS.

PRINCIPLES OF CONSTRUCTION.—It has been shown that the dynamo is a machine for the transformation of the mechanical energy produced by steam or water-power into electric energy; and that this energy can be conveyed by wires to any point where it is required for use. One of the principal uses to which it is applied, when generated in this way, is the operation of machinery; and in order to apply it to this use, it must be transformed back again into mechanical energy by the machine known as the electric motor.

The general construction of these motors is, in all respects, the same as that of dynamos. They have the same principal parts, the armature, field-magnet, commutator or collecting rings, and brushes; and are classified in the same way, as direct current and alternating current; and the direct current as series wound, shunt wound, compound wound, bipolar, and multipolar. A motor can be employed as a dynamo and a dynamo as a motor, and the same general principles of construction apply to each.

Where a motor is connected with the electric circuit of a dynamo, as shown in Fig. 64, and the armature of the dynamo is rotated by mechanical power in opposition to the electromagnetic force, an electric current is generated, which traverses the motor and causes its armature

to rotate in obedience to the electromagnetic force, reproducing the mechanical power, which can be applied to the operation of any kind of machinery. Hence the two machines, connected in this way, become a convenient apparatus for the electric transformation of power, and its distribution and application.

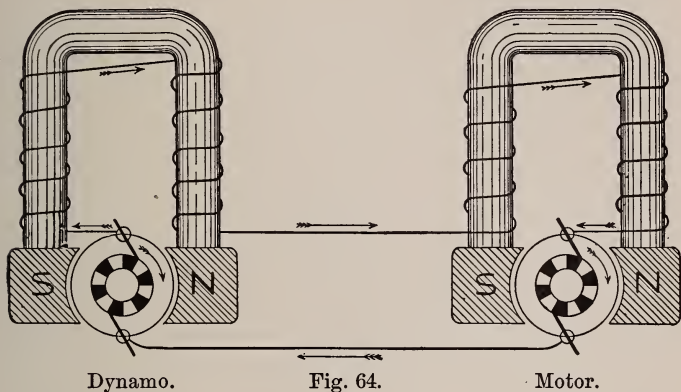

COUNTER ELECTRIC PRESSURE.—But the rotation of the motor's armature, in this way, generates electric pressure, the same as if it were rotated by mechanical power, and this pressure opposes that of the dynamo. Hence, if both machines were of the same size, this counter pressure would nearly neutralize that of the dynamo when the motor's speed nearly equaled that of the dynamo, as would be the case if the motor were doing no work. But when it is applied to work, its speed being reduced, this counter pressure is correspondingly reduced, and a proportionally stronger current supplied by the dynamo for the performance of the work. This pressure thus becomes a means of automatic regulation of the current, so as to make it proportional to the work.

Hence, if the speed of the dynamo be increased in the same proportion as the work required of the motor, the necessary speed for the performance of the work will be maintained by the motor. And as increase of speed by the dynamo requires increase of power, it is evident that the power applied to the dynamo must always vary as the work required of the motor.

RELATIVE SIZE OF DYNAMOS AND MOTORS.—While the general principles of construction are the same in the motor as in the dynamo, there are certain specific differences which adapt each machine to its specific use. The motor, being intended for the distribution and application of the power transformed into electricity by the dynamo, is usually a much smaller machine. A dynamo of 100 horse-power, for instance, may be employed to operate 100 motors of approximately one horse-power each, or twenty motors of approximately five horse-power each, or any other number within the limits of its power; the dynamo being located at the source of power, the steam-engine or water-wheel, while the motors are distributed to the various points where power is required for use.

ELECTRIC DISTRIBUTION OF POWER.—Thus power may be distributed by a dynamo and motors from a steam-engine in the basement to the various departments of industry on the upper floors of a large building, for the operation of lathes, saws, stamping presses, paper cutters, printing presses, and other machinery, cheaper and more conveniently than it would be possible to distribute the power direct from the engine by belts and shafting. And the electric energy may also be employed for lighting and heating the building. In like manner, the power employed in a large factory, covering perhaps several acres, may be more economically distributed by wires than by belts.

But one of the chief advantages of this system is in its distribution of power from a central station, in or near a town or city, where it can be generated on a large scale by steam or water, and supplied to customers at much cheaper rates than they could generate it themselves. Such stations are also employed to generate and distribute electric energy for lighting and heating, as well as power, thus keeping the machinery in constant operation, and the capital invested constantly employed.

Various small industries can thus be supplied with power where the use of a steam-engine would be impractical, inconvenient, or prohibitive. The motor occupies but little room, requires but little care, and furnishes power at a moment's notice, by the simple turning of a switch, without the delay, labor, heat, dirt, and annoyance of the small steam-engine, with its furnace and boiler, requiring a proper outlet for its steam and smoke, continual attention, to supply fuel and water and remove ashes and cinders, and frequent repairs, and the constant menace of danger from incompetent management.

Instances have come under the writer's notice where motors have been in constant daily use for years, without costing a cent for repairs, or requiring any care or attention, except for starting and stopping, and renewing the supply of oil, once a day, in self-oiling bearings. These motors were of three to five horse-power, and took the place of gas-engines of the same horse-power, whose use, for some years previous, had been a constant source of annoyance and expense, requiring continual watching; while that of the motors, at nearly the same cost for current as had been paid for gas, was entirely satisfactory.

The electric system of power transmission is especially adapted to mines, in which its superiority to the pneu-

matic system of power transmission by compressed air, formerly in extensive use, has been amply demonstrated both in the cost of installation and subsequent maintenance in proper repair, in its superior efficiency for the operation of the various apparatus and the running of the tram cars, and in the cheapness and facility with which it can be changed from one part of the mine to another, as old diggings are abandoned and new ones opened.

NIAGARA FALLS ELECTRIC POWER STATIONS.—The great water falls at Niagara have been estimated to be capable of developing over seven million horse-power. There are at present in operation or in course of construction four principal electric power stations having an aggregate capacity of over 500,000 horse-power. The earliest of these, the plant of the Niagara Falls Power Co., is situated on the American side of the falls and is now operating at its full capacity of 105,000 horse-power. The water for this station is taken from the Niagara River about a mile and a half above the falls and is conveyed by means of a short surface canal to the two power houses of the plant situated on each side of the canal. There are in all 21 vertical turbines in the wheel pits of this plant about 200 feet below the surface, and the water is delivered to these turbines through vertical steel penstocks each $7\frac{1}{2}$ feet in diameter. After passing through the turbines the water discharges through a tunnel 7,000 feet long into the Niagara River a few hundred feet below the falls. These 21 turbines drive 21 alternating current dynamos placed on the surface over the turbines and connected to them by means of long vertical shafts. Each dynamo has a capacity of 5,000 horse-power, and generates two phase alternating

currents at 2,200 volts. This is transformed to three phase currents at 22,000 volts by means of step-up transformers, and is transmitted at this high pressure to Buffalo and to intermediate points.

The other three large electric power stations are situated on the Canadian side of the Niagara River, namely, that of the Canadian Niagara Power Co., of the Toronto and Niagara Power Co., and of the Ontario Power Co.

The hydraulic arrangements of the Canadian Niagara Power Co.'s station are similar to those of the Niagara Falls Power Co. The Canadian power house is situated in the Queen Victoria Niagara Falls Park, about half a mile above the Horseshoe Falls. The water is taken from the river through a short canal, delivered through steel penstocks to the turbines at the bottom of the wheel pit, and discharged through a tunnel about 2,000 feet long into the river below the falls. There will be eleven turbines installed, each driving an alternator on the surface by means of a long vertical shaft. Each of the eleven alternators will have a capacity of 10,000 horse-power, and will generate three phase alternating currents at 11,000 volts, making an ultimate capacity of 110,000 horse-power. At present four units have been installed.

The power house of the Toronto and Niagara Falls Power Co. is in course of construction on the bank of the Niagara River about a mile above the Horseshoe Falls. Its arrangements of turbines and dynamos will be in general similar to those of the two plants already described. The discharge water will be carried away by two tunnels, one from each end of the wheel pit, which two tunnels will come together and form the main discharge tunnel which passes under the Niagara River and discharges at the base of the Horseshoe Falls at a point

about midway between the American and Canadian banks. This power house will contain eleven turbines and generators with a total capacity of 125,000 horse-power. At present three units have been installed.

The power house of the Ontario Power Co. is situated on the Canadian bank of the lower Niagara River, directly below the Horseshoe Falls. This power house differs radically in its construction from those already described. The water is taken from the upper Niagara River at the head of the Dufferin Islands, over a mile above the falls, and is carried through a steel pipe,—laid directly beneath the surface of the ground,—to the power house, where it passes through steel penstocks to the turbines and then discharges directly into the river. The turbines are of the horizontal type and each turbine is directly coupled to an alternator having a capacity of 12,500 horse-power and generating three phase alternating currents at 12,000 volts. The ultimate capacity of this station will be 180,000 horse-power. Three units have at present been installed. A unique feature of the electrical equipment is the installation of all switching and controlling apparatus in a separate transformer house on the bluff above the power house instead of directly in the power house.

LOSS OF POWER IN ELECTRIC TRANSMISSION.—Whenever power is transmitted over a distance there is an inherent loss of power in the transmission wires. The amount of the loss depends upon the distance of transmission, and upon the size and kind of wires employed. This loss can be kept as low as desired, and is determined in practice by the first cost of the transmission line and by the cost of generating the electric power. This loss is generally less than in power transmission by mechanical means.

This is especially true of long distance electric transmission for the running of street cars, as compared with cable transmission for the same purpose; the greater proportion of the power, in the latter case, being consumed in moving the heavy cable, and overcoming the friction of the supporting pulleys, leaving, on the average, a smaller proportion for moving the cars; whereas, in the electric system, much the larger proportion is employed in moving the cars.

STATIONARY MOTORS.—Motors employed for stationary work, in shops, factories, and elsewhere, are nearly all of the direct current kind, and may be either series, shunt, or compound wound. When required for steady work, in which the variation of strain is not excessive, and automatic regulation of the first importance, so that the motor shall require little or no attention, except to start and stop it and supply it with oil, the shunt wound motor is generally preferred; the relative supply of current in the two circuits of a well-constructed machine of this kind varying automatically in proportion to the work, in the same manner as in the shunt wound dynamo, without danger of overheating and injuring the coils.

Where the variation of strain is excessive, as in the operation of elevators and dock hoists and the blowing of large pipe organs, special automatic regulation is required, and compound wound motors are sometimes preferred for such work.

RHEOSTATS.—The rheostat is an apparatus for admitting the current to the motor gradually, so as not to heat and injure the coils and insulating material by admitting the full current before the armature has attained its full rotary speed, and developed corresponding counter elec-

tric pressure; electric energy producing heat when excessive, and not fully employed for mechanical work. The rheostat is also employed for regulating the volume of current, to adapt it to the requirements of the work.

Its general construction is shown in Fig. 65. A number of coils of German-silver wire, which has very high electric resistance, are connected together in series and inclosed in a box. This series of coils is connected with a circular row of brass stops on the lid of the box; one or more coils being connected with each stop, except the neutral coil on the left. A brass switch has a rotary movement over these stops; one end of it resting on a main circular stop, while the other end rests on one of the

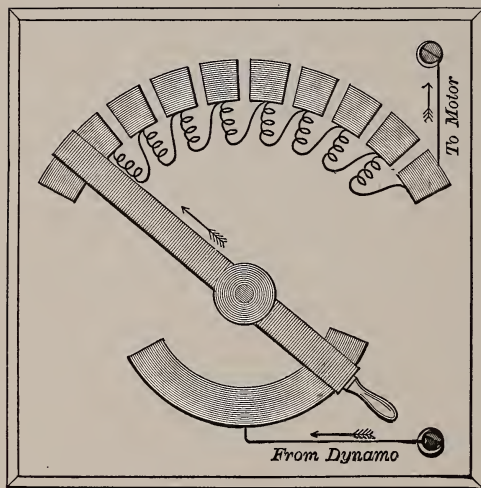

Fig. 65.

smaller stops. One terminal of the electric circuit is connected with the main stop, and the other terminal with the series of coils by the right-hand small stop. Therefore, when the switch is moved from the neutral stop on the left to the first stop

connected with the series of coils, the current, entering from the dynamo by the main stop, must traverse the switch and all the coils, encountering their full resistance, before it can leave for the motor by the right-hand stop.

But as the switch is moved to the right, from stop to stop, this resistance is gradually cut out, till the right-hand stop is reached, when it is all cut out, and the current flows direct to the motor.

This construction is varied to adapt it to different classes of motors and different kinds of work, and to the separate circuits of field-magnet and armature. The rheostat may be employed merely to start the motor, or also to regulate the current, or to reverse its direction in armature and field-magnet. For such work as the blowing of pipe organs, or the operation of elevators, the switch is often moved automatically in opposite directions alternately, over the stops, and the supply of current thus adjusted to the requirements of the work; increasing as the electric resistance in the rheostat decreases, and decreasing as this resistance increases.

REVERSAL OF ROTATION.—Reversal of rotation is required in many kinds of work, as in the upward and downward movements of an elevator or dock hoist, or the backward and forward movements of a street car. This is sometimes accomplished by a mechanical device, as a belt-shifter, or a clutch; but it is often preferable to reverse the rotation of the motor's armature, which can be done by reversing the direction of the current, either in the armature or the field-magnet, but usually in the armature. This reversal of current reverses the relative polarity of the armature and field-magnet, so that the magnetic attraction and repulsion, by which rotation in a given direction is produced, are reversed, producing rotation in the opposite direction. But if the direction of the current were reversed in both armature and field-magnet, the relative polarity would remain unchanged, and therefore the rotation would not be reversed.

The reversal is sometimes accomplished by two sets of brushes attached to the same conductors, but placed in reversed positions on the commutator; one set being lifted out of contact as the other set is depressed into contact; so that the current which, for instance, entered the commutator below and left above, by the first set, enters above and leaves below by the other set, and therefore traverses the armature coils in the opposite direction. The same result may be accomplished by one set of brushes, and a rheostat with two sets of stops, so connected with the circuits of the field-magnet and armature that the direction of the armature current may be reversed by reversing the movement of the switch, while the field-magnet current remains unreversed.

ALTERNATING CURRENT MOTORS.—The construction of alternating current motors varies greatly, and is much more complicated than that of direct current motors. The general construction, in its simplest form, is similar to that of alternating current dynamos, and consists of a circular, multipolar field-magnet, inclosing a cylinder armature with coils wound back and forth in grooves on its face. These coils have no connection with either the field-magnet coils or external circuit, but form a closed circuit within themselves, without any external outlet, the terminals being soldered together.

The cores of both field-magnet and armature are laminated; and the field coils are wound in two series, on alternate poles, as shown in Fig. 66, so as to produce north and south polarity alternately, in each series, all around the field; eight field coils being shown, four in each series, and four armature coils, the ends of which are shown. But these relative numbers may vary in different motors.

The current from the dynamo traverses each series of field coils alternately, reversal of current occurring after every two successive waves. A current wave entering at *B*, traverses the series connected with that terminal, and returns to the dynamo by *A*. The next current wave,

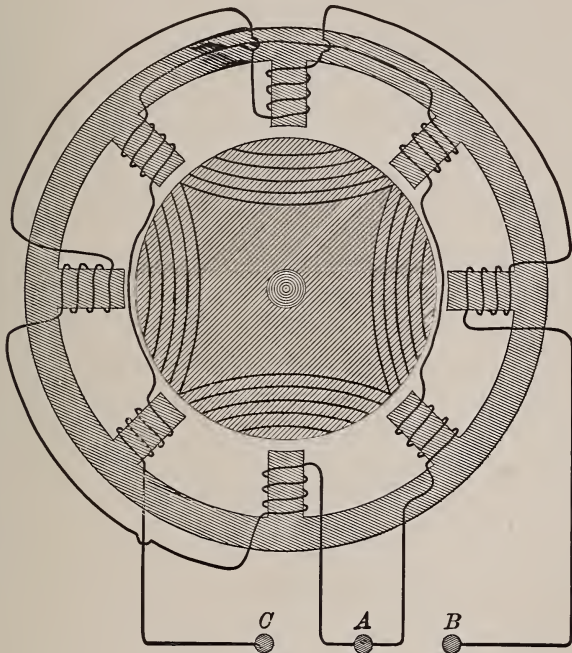

Fig. 66.

entering by *C*, without reversal, traverses the series connected with that terminal, and returns also by *A*. The current is then reversed at the dynamo, and the next two successive waves enter by *A*; the first turning to the right, traversing the series connected with *C* and returning by that terminal; and the second turning to the left,

traversing the series connected with *B*, and returning by that terminal.

Alternate field poles of opposite polarity being produced in this way by each current wave induce, in the armature, alternate poles of opposite polarity to the adjacent field poles and to each other. And as each successive current wave magnetizes a series of field poles a step in advance of those magnetized by the receding wave, the armature is rotated round, step by step, by the magnetic attraction and repulsion between its poles and those of the field-magnet; the field polarity thus traveling round the stationary field, and forcing the rotary armature to follow it.

This action may be better understood by considering its effect on a single armature pole. Suppose a north pole is induced in the armature by a south pole in the field-magnet; the next current wave produces a south field pole adjacent to this armature pole, on one side, which attracts it, and a north field pole adjacent to it, on the other side, which repels it in the same direction; and the armature is rotated a step by these two forces. The next wave produces the same effect, and the armature is rotated round another step. And thus it continues to rotate, step by step, till it has made a complete revolution, and is ready to make another in a similar manner. The same action having occurred at every pole, the rotary force is multiplied proportionally. And as the waves follow each other with great rapidity, the speed of rotation is proportionally rapid.

It is evident that the distance to which an armature is rotated by each current wave depends on the number of poles in the surrounding field-magnet. With an eight-pole field-magnet, for instance, each armature pole is

rotated through one eighth part of the circumference, or twice as far as with a sixteen-pole field-magnet. Hence, with a given number of current waves per minute, the speed of rotation varies inversely as the number of field poles, as in direct current machines.

TWO PHASE MOTORS.—Motors constructed to operate with two sets of field coils, receiving from the dynamo two distinct waves of current, following each other successively in this way, and each appearing in the field circuit a certain number of degrees in advance of its predecessor, as described above, are called *two phase* motors, and are the kind now in most general use, especially for heavy work. Special construction is required in the dynamos by which such motors are operated, and also in the circuit which connects the two machines; this circuit requiring a double construction, with three parallel wires; each outside wire carrying a current wave alternately, to or from each set of coils, which returns by the central wire, as described above; and the armature of the dynamo requiring to be wound in two circuits, to supply these alternate waves.

SINGLE PHASE MOTORS.—Motors designed to be operated on a two wire circuit by alternating current dynamos of the ordinary construction are called *single phase* motors. Their construction has not been so fully developed as that of the two phase motors, but the importance of adapting alternating current motors to the two wire circuits and alternating current dynamos already in use for electric lighting has stimulated invention, and brought into market, recently, several different motors of this class, especially those designed for light work; though such motors are also constructed for heavy work.

These motors are usually constructed with two sets of

coils, in which the two different phases of current appear alternately at different points, as in two phase motors. But these alternate phases, instead of being produced by a special construction in the dynamo, and transmitted by a double circuit, as described above, are produced by a special construction in the motor itself, which varies greatly in different motors.

The successful operation of an alternating current motor requires that the alternations of current and the reversals of polarity should occur at the same instant in both field-magnet and armature, and also that there should be synchronism between the action of the motor and the dynamo from which it receives its current. But such motors are liable to a momentary lag in the inductive effect of the field-magnet on the armature; and also to the generation of an opposing electric pressure in the armature coils by self-induction, which partly neutralizes the currents induced by the field-magnet.

Both these effects interfere seriously with the operation of the motor, especially in starting, before it has attained full speed; and the efforts of inventors have been directed to various means of suppressing them, which have proved successful to such a degree, that very efficient alternating current motors are now in practical use, more especially those of the two phase kind.

Among the most important improvements has been the application of tinfoil condensers, for the suppression of self-induction, like those employed on telegraph lines; also a double construction in both field-magnet and armature; as if two motors of the same construction were joined together, end to end, in such a manner that the field poles in one come opposite the spaces between field poles in the other, so that the action of each alternately

supplements that of the other, as the coils in each separate field are traversed alternately by a reversed wave of current.

RAILWAY MOTORS.—Motors for railway service require a very different construction from those designed for stationary work. On account of their exposed position

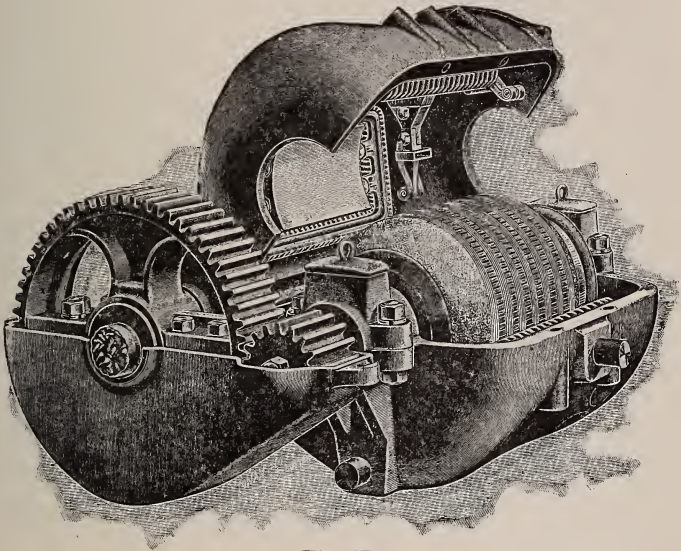

Fig. 67

under the cars, an iron or steel armor, water-tight up to the axle, has been found necessary, and is easily provided by employing, for this purpose, the connecting yoke to which the core projections of a bipolar or multipolar field-magnet are attached, as shown in Fig. 67. This armor is about three-quarters of an inch thick, and furnishes ample protection against water, mud, dirt, and obstructions liable to be met with on the track. It is ventilated either above or at the sides, and constructed

with upper and lower sections, which can be raised or lowered on a hinge, as shown, for the removal of the armature when repairs are required.

Reduction of speed is another very important matter. This was accomplished at first by two sets of gears, by which the high speed of the armature was reduced to the low speed required for the car axle. The production of high speed, and its subsequent double reduction in this way, was not only a wasteful process, resulting in the useless consumption of energy, but the noise occasioned by so much gearing, and by the friction of the brushes on a high-speed commutator, was very objectionable to the passengers.

Reduction of the armature's speed without reduction of the motor's efficiency was evidently the proper remedy; and this has been accomplished in three ways: either by increasing the diameter of the armature, so that it shall cut the same number of lines of magnetic force per minute, at slower speed; or by increasing the number of field-magnet poles, so as to produce the same number of current waves in the circuit, per minute, at slower speed, as already explained; or by a combination of both these methods.

In one of these three ways, according to the preference of the inventor, motors have been constructed in which only one set of gears is required to produce the same rate of speed as formerly required two sets. These are known as *single reduction* motors, and have taken the place of the old *double reduction* motors on most street railways. The prevention of useless waste of energy and wear of the machinery, with corresponding reduction in cost of maintenance and increase of comfort for passengers by the suppression of noise, are their most prom-

inent features. The motor shown in Fig. 67 is of this construction.

A further reduction of armature speed, in the manner indicated above, has resulted in dispensing entirely with gearing, producing the *gearless* motor, in which the speed of the armature is reduced to the requirements of the car axle; the armature being mounted either directly on the axle, or on a hollow shaft inclosing it, and connected with it in such a manner as to allow independent spring pressure. To bring the speed within the requisite limits, with this construction, requires a motor with an armature of much larger diameter than that of the single reduction motor, and a field-magnet of corresponding size, occupying more space under the car, and hence requiring greater elevation of the car above the track. Such motors are evidently better adapted to elevated roads and tunnel roads, where high speed is permissible, and size and massiveness not objectionable, than to surface roads. They are in successful operation on such roads, at a speed of 12 to 26 miles an hour, and also on some surface roads, at a speed of 10 to 20 miles an hour.

All railway motors now in use are of the direct current kind, and are series wound; and the wire used in the coils of both armature and field-magnet is much larger than in stationary motors of similar winding, so as to be capable of carrying a current of much greater volume. The wire in the field coils is much larger than in the armature coils, as in all series wound machines, since it carries the full current, while the armature current is divided between the two circuits on opposite sides of the armature.

This current being under constant manual control,

automatic regulation, like that employed in stationary motors, with shunt or compound winding, is not only unnecessary, but would be impracticable under the existing conditions; these motors being subject to excessive variations of electric strain far beyond the range of such automatic regulation. A car may be running nearly empty, on the level, on one part of its route, requiring barely enough current to keep it in motion at the proper speed; and, on another part, may be loaded to its utmost capacity, and require sufficient current to start it after stoppage, and move it up a steep grade.

This supply of current is regulated by a rheostat under control of the motor-man, and can be increased or diminished as required, by the movement of the *controller* switch; the large wire composing the motor's coils being capable of carrying sufficient current to supply power for any emergency, without danger of injury to the coils by overheating.

ELECTRIC RAILWAYS.—The usual construction of electric railways is illustrated by Fig. 68. There is a central station where the power is generated, usually by steam, and transformed by dynamos into electricity, which is transmitted to the motors under the cars by an electric circuit composed usually of the rails for one branch, and of a bare copper wire suspended above the track, for the other branch. This wire is attached to insulators, supported either on cross wires, as shown in the cut, or on brackets, by poles of wood or iron, and the rails are connected together at the ends, for this purpose, by bonds of heavy copper wire, as shown, making the circuit continuous; and the rails on opposite sides of the track are also connected by similar cross-wires, to equalize the current on both sides.

Two motors are usually employed on each car, and connection between them and the rails is made through the car-wheels and axles, and between them and the line wire, by a wire connected with a wheel called the *trolley*, which is carried at the end of a pole supported on the car roof by springs which press the trolley upward against the line wire; the construction being such as to allow the pole a horizontal motion for rounding curves in the line, or reversing its position.

The line wire is divided into sections, each of which carries suf-

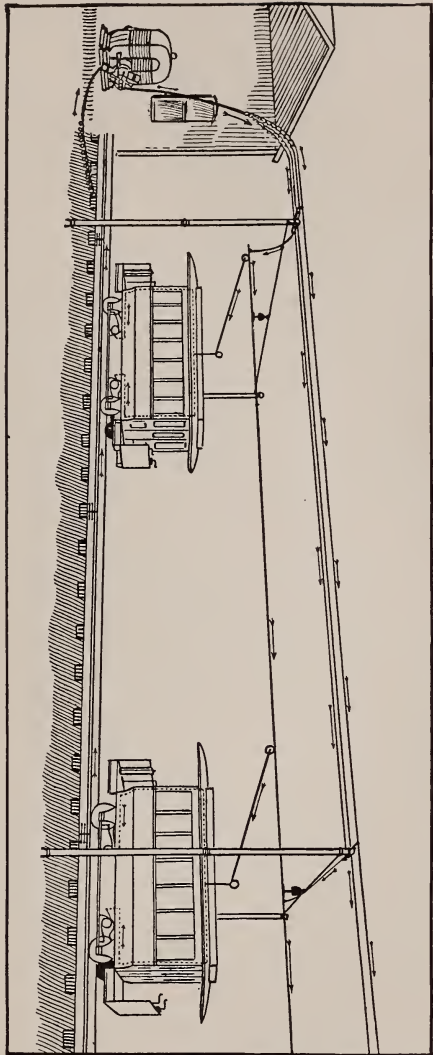

Fig. 68.

ficient current to run the cars on that section, and receives its supply through a *feeder* wire, which forms part of the circuit and is connected with the dynamos at the station. These feeder wires are wrapped with insulating material, and form cables which are supported on the poles parallel with the line wire, as shown.

There may be half a dozen or more cars running on the same section at the same time, each tapping the line wire by its trolley, and taking so much current as it requires, and all thus taking current in parallel; the supply of current in this way being similar to the supply of water or gas to buildings along a street, by service pipes tapping the main pipe at various points.

The current may be transmitted from the positive poles of the dynamos, either through the feeder wires and line wire, returning to the negative poles by the rails, as shown by the arrows; or through the rails, returning by the line wire and feeder wires; the practice being now adopted of reversing the direction of the current through the circuit at stated intervals, to prevent injury to water and gas pipes adjacent to the track by the electrolysis caused by a current constantly flowing in the same direction.

The cars can be lighted and heated more economically and satisfactorily by the current which supplies the power than in any other way; part of it being diverted through electric lamps and heaters for this purpose.

On elevated roads, and tunnel roads, the current is often supplied by a third rail, and the circuit completed, either by another such rail on a parallel track, or by the track rails as above described. Conductors, either of copper or iron, may also be laid in conduits adjacent to

the track, for the same purpose, in cities where overhead wires are not permitted; but this system is much more expensive than the overhead system, and it is difficult to insulate bare conductors properly in conduits; but it has, nevertheless, been successfully accomplished.

RUNNING CARS BY STORAGE BATTERIES.—Various attempts have been made to run cars by storage batteries, carried on the cars, and charged at a central station when exhausted; relays of charged batteries taking the place of those exhausted. But this system, from which so much was once expected, has not proved successful in practice, and has usually been abandoned after trial. The great weight of the battery, 3,600 pounds to a car, has always been a serious objection; but the failure to produce batteries of the requisite durability and efficiency for such work, has been the most serious defect in this system.

LIGHTNING ARRESTERS.—The electric apparatus connected with an air line for an electric railway or any other electric purpose requires special protection against lightning, which is furnished by the apparatus known as the *lightning arrester*, of which there are many different kinds, all constructed on the same general principle. The line wire passes through a box, in which it is connected with two rows of sharp points, one row on each side of a short bend in the wire, between which is another row connected with a wire leading direct to the earth.

The dynamo current, no matter how strong its pressure, will follow the bend; but the enormous electric pressure of a lightning discharge on the line, causes the current produced by it to leap across the narrow air space between one of the rows of points connected with the line and the central row, and pass to the earth by the

ground wire; so that it is arrested in its course before it can reach the dynamos, motors, or other apparatus.

These arresters are placed at intervals all along the line, and also in the station and on the cars; and afford a limited protection, but not always sufficient to prevent injury to the apparatus, which, during severe thunderstorms, often receives a sufficient electric charge to burn, or seriously damage, the coils of dynamos or motors, or injure other apparatus in a similar manner.

RECORDING WATT-METER.—Meters for the separate measurement of electric pressure and current volume have already been described; but as both pressure and volume are elements of the electric current, it is evident that a meter designed to measure current sold to consumers for the supply of motors, lamps, or heaters, should include both elements. This has been accomplished by a meter invented by Elihu Thomson, shown in Fig. 69, which records the full electric energy of the current in *watts*; the watt being an electric unit obtained by multiplying the volt, which represents pressure, into the ampere, which represents volume.

It consists mainly of an electric motor constructed without iron cores, either in its armature or field. Two field coils wound with coarse wire are arranged to be connected with the electric circuit in series, so as to carry the whole volume of current. These coils inclose an armature mounted on a vertical shaft, as shown, wound with fine wire, which forms a shunt circuit between the two wires of the main circuit, and carries a current of very small volume, which nevertheless represents the full electric pressure by which both branches of the current are impelled. Hence current volume, represented in the field coils, combined with current pressure, represented

in the armature coils, produces rotation of the armature, which puts in motion a train of clock-work, contained in a case above, by which the electric energy, supplied to a consumer, is recorded on dials, graduated on a decimal

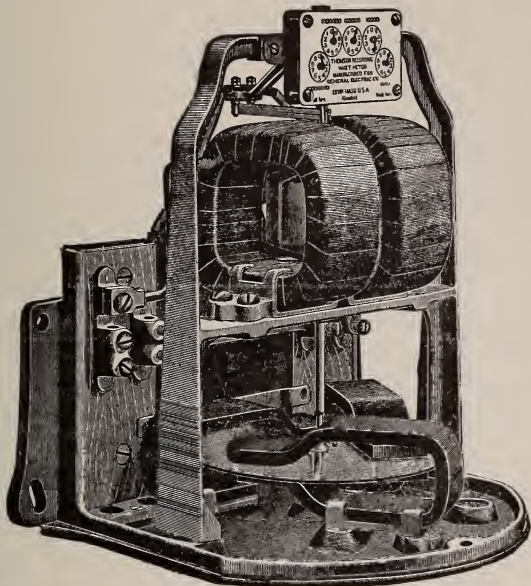

Fig. 69.

scale, in the same manner as gas consumption is recorded in a gas meter.

This record is made in *watt-hours*; a current of one watt, that is of one ampere with a pressure of one volt, flowing for one hour, recording one watt-hour. Hence a current of 500 watts, that is of five amperes with a pressure of 100 volts, or of ten amperes with a pressure of 50 volts, would record 500 watt-hours in one hour, 1,000 watt-hours in two hours, and so on.

At the lower part of the meter is shown a disk, made of copper or aluminum, attached to the armature shaft, and three permanent steel horseshoe magnets with their poles brought close together, and arranged so that the disk rotates between these poles. By this means the eddy currents induced in the disk produce a retarding force which is directly proportional to the speed, and this speed is thus made directly proportional to the electric energy passing through the meter.

THE SINGLE PHASE ALTERNATING CURRENT RAILWAY MOTOR.—A direct current series motor will turn in the same direction irrespective of the direction in which the current passes through the motor. A series motor will, therefore, operate with alternating current. The solid field magnets of a direct current series motor would, however, have strong eddy currents induced in them by the alternating currents and these would produce excessive heating; there would also be vicious sparking at the commutator owing to the self-induction of the armature.

The single phase alternating current railway motor which has recently been introduced is a series motor in which the entire magnetic circuit of the field magnet is built up of sheet steel punchings so as to minimize these eddy currents; these steel punchings are held together in a steel frame forming a box type of motor similar in its outer appearance to a direct current railway motor. The alternating current motor has also a neutralizing field winding in addition to the regular field winding in order to counteract the self-induction of the armature and so reduce sparking. The armature is practically the same in the alternating and direct current motors.

CHAPTER VII.

ELECTRIC LIGHTING.

HEAT AND LIGHT BY ELECTRIC RESISTANCE.—The transmission of electricity through any substance always generates a certain quantity of heat, which varies in proportion to the electric resistance of the substance. If the substance is a good electric conductor, like copper, and large enough to carry the current easily, the heat may be barely perceptible; but if it is a bad conductor, like platinum, carbon, or air, the heat may be sufficient to produce combustion or incandescence, especially if the conductor is too small to carry the current easily. And it is by means of apparatus constructed on this principle that electric light and heat are produced.

There are two systems of electric lighting in common use, known respectively as *arc* lighting and *incandescent* lighting; arc lighting being the older, and having attained considerable prominence before the incandescent system came into use.

ARC LIGHTING.—In the general construction of the various lamps now in common use for arc lighting, two carbon rods are employed, which are made from some good carbon, as petroleum coke, ground fine and made into a paste with gas-house pitch, or some similar hydrocarbon, and then molded and baked with a great deal of care; going through various processes to give them the requisite purity, density, hardness, straightness, and electric resistance.

They are supported vertically in the lamp, one above the other, as shown in Fig. 70. The upper one is about twelve inches long, and the lower one, which is consumed only half as fast, is about six inches long; each being about seven-sixteenths to one-half an inch in diameter. The electric current is transmitted through them downward, from the upper to the lower carbon, and its action in producing the light is controlled and regulated by the apparatus contained in the brass case in the upper part of the lamp, above which connection is made with the electric circuit; and the light is produced between the points of the two carbons, when separated for this purpose, as shown at A in Fig. 71.

This apparatus is constructed with a brass rod to which the upper carbon is attached by a set screw. This rod passes through a loose washer connected by a clutch with a laminated iron armature, which has a free vertical movement between the poles of an electromagnet, the coils of which are connected with the electric circuit. The current

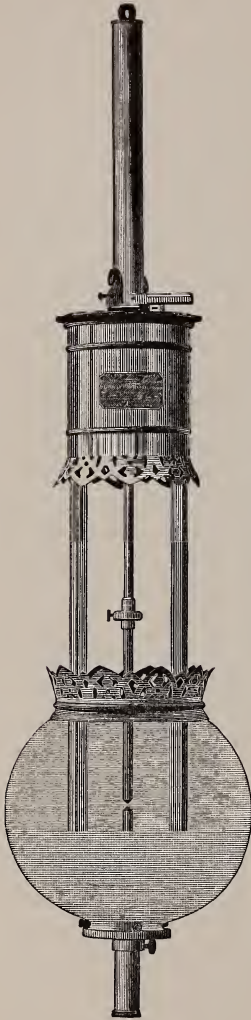

Fig. 70.

when admitted by the switch shown above in Fig. 70, traverses these coils, passes thence through the brass rod and the two carbons, and returns to the dynamo by the wire on the left, as shown by the arrows. When this

occurs the armature is attracted upward from the position shown at *B* to that shown at *A*; the clutch tilting the loose washer, so that it grips the brass rod, lifting it, and separating the carbons about one eighth of an inch, as shown.

The carbons become hot at the points, but their electric resistance is not sufficient to make them

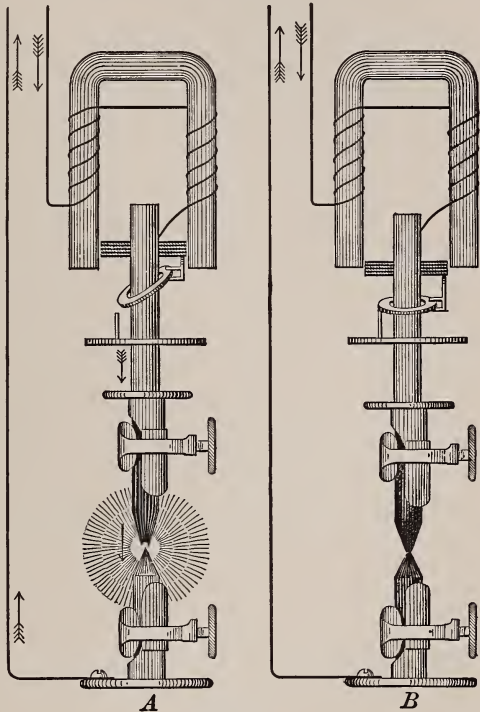

Fig. 71.

hot enough to produce light till separated; when, on account of the greater resistance of the air, the light bursts out in the air space between them; the points becoming incandescent, and the air space filled with burning carbon vapor from their combustion, producing a light of about 1,500 to 2,000 average candle-power. The con-

sumption of the carbon keeps both rods pointed, and a little pit, called the *crater*, forms in the upper point, as shown, from which the light is radiated downward.

The flame takes the form of an arc, from which the name *arc* light is derived. This is caused chiefly by the difference of potential between the burning vapor and external air, producing electric attraction outward, and equality of potential between the molecules of the vapor within the air space, producing electric self-repulsion outward; the center of the flame curving outward while its tips adhere to the points above and below. The upper tip circulates round the edge of the crater as the carbon burns away; and as the force is greatest toward the side from which this tip starts, the outward curve is always on that side.

There is a shunt circuit of fine wire, not shown, which is wound on the cores of the electromagnet in the opposite direction to that of the main circuit, so that a current passing through it tends to reverse the polarity produced by the main current, and hence correspondingly weakens the magnetism. This circuit branches off from the main circuit above the magnet and reunites with it below the magnet, without including the carbons.

As the carbons burn away the distance between them increases, producing corresponding increase of electric resistance in the air-space. This reduces proportionally the volume of current in the main circuit, and increases that in the shunt circuit, and in both ways weakens the magnetism; and when it becomes so weak that the weight of the armature and connected rods can no longer be sustained, they drop down, and the edge of the washer strikes the little post, supported on a fixed disk, by which the washer is tilted back into the position shown at *B*, so

that it loosens its grip on the brass rod, which slips down through it, bringing the carbons closer together. This renews the volume of current in the main circuit, and the magnetism, so quick that the descent of the upper carbon is stopped when the distance between the carbons is sufficiently reduced; and the constancy of the light is thus automatically regulated. This method of regulation is so sensitive, that the apparatus responds instantly to very slight variations of resistance in the arc.

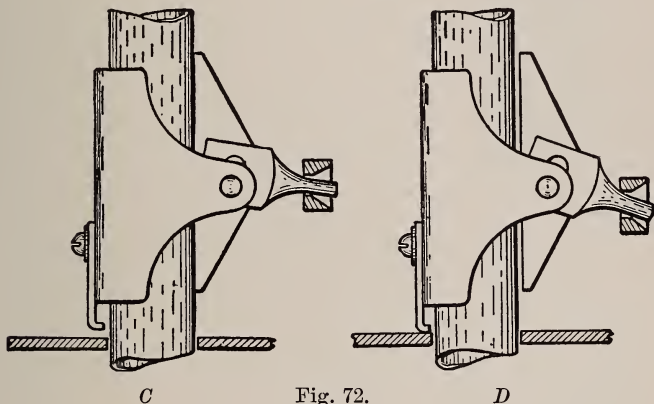

Fig. 72.

If the lamp is accidentally extinguished, the supply of current in the main circuit being thus interrupted, the magnetic action is so weakened that the upper carbon drops into contact with the lower one, renewing the main current and magnetism instantly and relighting the lamp.

The loose washer method, which has been used for illustration on account of its simplicity, has been superseded in practice by the clutch shown in Fig. 72, which is more certain in its action and less liable to obstruction. By comparing *C* and *D* in Fig. 72, with *A* and *B* in Fig.

71, it will be seen that the action of the clutch is practically the same as that of the washer.

DOUBLE CARBON LAMP.—One pair of carbons will last for six or eight hours; but when light is required for a longer period without renewal of carbons, a lamp with two pairs, like that shown in Fig. 73, is required, in which a double clutch is employed, by which one pair are kept separated till the other pair are consumed. This is accomplished simply by so constructing the double clutch that it lifts the upper carbon of the second pair a little higher than that of the first pair; so that when the first pair are in contact there is space between the second pair. But when the first pair are consumed, the current being interrupted, the second pair instantly come into contact, and the light is renewed; such a lamp furnishing light for twelve or sixteen hours without renewal of carbons.

The arc light requires a powerful current, usually of ten amperes, with a pressure of 1,500 to 2,500 volts, supplying 25 to 50 lamps connected together in series, the current flowing from lamp to lamp.

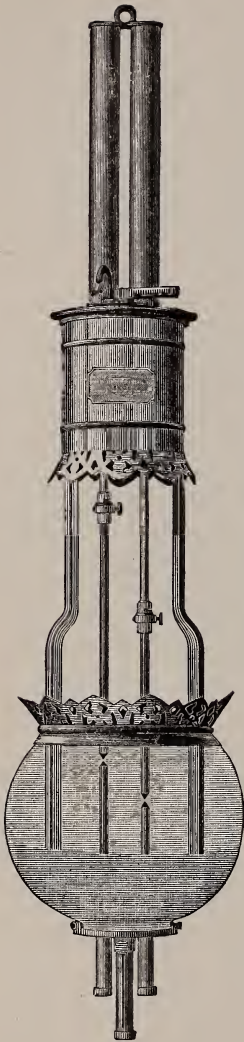

Fig. 73.

Hence each lamp must be so constructed that its supply of current shall not in any way interfere with the supply of current to the others; otherwise the accidental extinguishing of one lamp, by the consumption or breaking of its carbons, would stop the flow of current, and thus extinguish all the lamps in the circuit; or any variation of resistance in a lamp would, by causing a variation in its supply of current, affect the brilliancy of the light in all the others; so that, in a circuit of 25 or 50 lamps, there would be a continual flickering of the light by this variation of resistance in different lamps.

CUT-OUT.—The method of regulation already described keeps the light steady, but does not provide against interruption of the current by the accidental breaking of the carbons, or their entire consumption in a lamp; which requires a *cut-out* by which the full current can flow through a separate channel, independent of the carbons, and also of the magnet coils. This consists of a short horizontal brass bar, attached to a lever connected with the clutch which separates the carbons. This bar makes contact with two binding-posts connected with the main circuit, when the lever is depressed, but when the clutch lifts the upper carbon, it also raises this lever, and withdraws the cut-out bar from its contact with the posts, so that the main current, which flowed through the bar, must now flow through the carbons. But the instant a lamp is extinguished, so that the magnetism ceases, this lever drops, and pushes the cut-out bar against the posts, so that the current flows through it to the other lamps.

But as current would still flow through the shunt circuit, which, from its increased strength, might heat and

injure the fine wire magnet coil connected with it, and also create sufficient magnetic attraction to retard the fall of the cut-out lever, an auxiliary electromagnet is provided, wound oppositely with two sets of coils, like the principal magnet, through which the shunt current is diverted, for a moment, till the current through the cut-out bar is fully established, cutting out the magnet coils.

There are also resistance coils and other minor auxiliary apparatus, which regulate the supply of current and movement of the carbons, but need not be described. This construction also varies considerably in the different kinds of lamps, but its main principles are essentially the same in all.

ENCLOSED ARC LAMPS.—In the arc lamps just described, the carbons burn away rapidly because they are heated to incandescence in the presence of an excess of air, and must be replaced after about six or eight hours. In an enclosed arc lamp a small glass globe is used to enclose the lower carbon and a portion of the upper carbon, which latter passes loosely through a gas valve in the upper part of the glass globe. Free access of air is thereby prevented from reaching the incandescent carbon tips, and the combustion of carbon is, therefore, much slower, so that a pair of ordinary carbons last about one hundred hours in the enclosed lamp.

FLAMING ARC LAMPS.—In the ordinary carbon arc lamps the light is given out from the incandescent carbon tips, while the arc itself gives but little light. Recently several new types of arc lamps have been placed upon the market, in which the arc is made luminous so as to be the principal source of light; these have for this reason been called *flaming arc lamps*.

In one type of flaming arc lamp special or *mineralized*

carbons are used. These mineralized carbons contain, in mixture or as a core, some salt of a metal as calcium or titanium, which is evaporated by the heat of the arc and renders this highly luminous. The light given by these lamps is of a reddish-yellow or a white color.

A second type of flaming arc lamp is the *magnetite lamp*, in which metallic copper and magnetite are the electrodes. The magnetite or black oxide of iron used in this lamp is mixed with a salt of titanium and compressed in powdered form into a thin iron tube forming a stick about the size of an ordinary arc lamp carbon and which forms the negative electrode. The copper electrode is the upper and positive electrode. The magnetite lamp can only be used on direct current. The magnetite is slowly consumed, lasting from one hundred to two hundred hours. The copper remains unchanged and does not have to be renewed. The magnetite lamp gives a strong white light, which is essentially the spectrum of titanium.

Flaming arc lamps have the advantage over ordinary carbon arc lamps of giving several times the amount of light for a given expenditure of electrical energy.

INCANDESCENT LAMPS.—The ordinary incandescent lamp consists of a thin piece of carbon about the size of a horse hair and about six inches long, called a filament, which is enclosed in a pear-shaped glass globe, from which the air has been exhausted by means of specially constructed air pumps so as to produce a nearly perfect vacuum.

These carbon filaments were originally made by carbonizing strips of substances such as bamboo, cellulose, bass-broom cotton, linen and silk. At present these filaments are made by squirting a viscous preparation of carbon through dies, and then baking, shaping and treating these

threads of carbon so as to bring them up to the constituency required for the incandescent lamp. The ends of the filament are attached to fine platinum wires which are melted through a glass stopper, which is then melted into the bottom of the glass globe. Platinum wires are used to bring the terminals out through the glass, because the coefficient of expansion of platinum is the same as that for glass. The outer ends of the platinum wires are connected to the lamp terminals by copper wires.

The electric current in passing through this carbon filament heats it to incandescence and it thus becomes a source of light. The exclusion of air from the filament prevents its combustion. The effect of the continued heating is, however, to slowly deteriorate the filament, owing to the presence of traces of air, and to other causes, so that the light given out by an incandescent lamp diminishes gradually with use. For this reason these lamps are not used until the filament is actually destroyed, but it is usual to replace them after they have burnt from 600 to 1,000 hours, after which the light given out is so reduced as to make them uneconomical to operate. The efficiency of incandescent lamps varies from 3.1 to 3.5 watts per horizontal candle-power when the lamps are new.

Recently incandescent lamps with *metallic filaments*, instead of the usual carbon filaments, have been placed upon the market, notably in Europe. The *tantalum* and *tungsten* lamps are the most prominent examples of these metallic filament lamps. While these metals have long been known, it is only very recently that means for working them have been developed by which thin threads such as are needed for lamp filaments can be commercially made. These metallic filaments can be operated at a

higher degree of incandescence than carbon filaments and for this reason these metallic filament lamps have a much higher efficiency, which varies from 1.15 to 2 watts per horizontal candle-power.

THE NERNST LAMP.—In the Nernst lamp there is instead of a long thin filament of carbon or metal, one or more short filaments, each about $\frac{1}{32}$ inch in diameter and 1 inch long, made of the oxides of the rare metals mixed with suitable binding materials. These filaments, or *glowers* as they have been termed, are non-conductors of electricity when cold, but become conductors when heated to a red or white heat. In this lamp means must, therefore, be provided to heat the glowers when starting the lamp. This is accomplished in the commercial lamp by *heaters* which consist of thin platinum wires wound upon thin hollow cylinders of porcelain. These platinum wire heaters are connected in shunt with the glowers. When current is turned on the lamp it passes through the heaters, but cannot pass through the glowers because these are cold and do not conduct. The platinum heaters are heated to a white heat by the current and this heat radiates to the nearby glowers, bringing them to a red heat in from 15 to 30 seconds. The glowers now become conductors and current passes through them and heats them to a white heat and these now give out a powerful white light. As soon as the current passes through the glowers it also passes through the electromagnet of a *cut-out*, which disconnects the heaters from the circuit. The heated glowers have the property of diminishing in resistance with increase in temperature; if such glowers were connected directly across a constant potential circuit the current would, therefore, keep on increasing until the glowers would burn out. To prevent this

it is necessary to connect a steadying resistance in series with the glowers, which resistance must be made of a material which increases in resistance with increase in temperature and, therefore, with increase in current. A thin iron wire, enclosed in a small glass globe exhausted

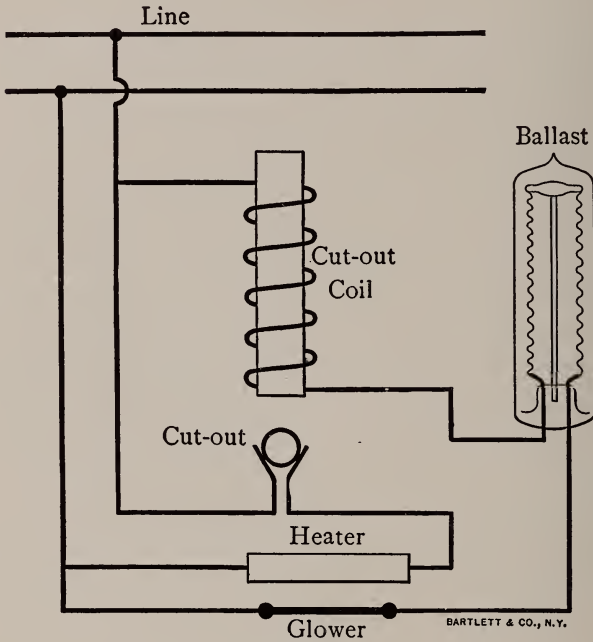

Fig. 74.

of air; is used in the Nernst lamp for this purpose, and this iron wire resistance has been termed a *ballast*. The connections of the elements in the Nernst lamp are shown in Fig. 74. The glowers in the Nernst lamp are enclosed in a glass globe to protect them from draughts and to keep in the heat, but this globe is not exhausted of air, but has on the contrary free access of air.

THE MERCURY VAPOR LAMP.—In the *mercury vapor lamp* a column of mercury vapor, enclosed in a glass tube, is rendered incandescent by passing an electric current through the vapor. The standard 110 volt mercury vapor lamp, manufactured by the Cooper Hewitt Electric Co., consists of a glass tube, 1 inch in diameter and 45 inches long, which has been exhausted of air. At the lower end of this tube is a small bulb containing about one pound of metallic mercury, which forms the *negative electrode* of the lamp. At the other end of the tube is a pear-shaped enlargement called a condensing chamber. The *positive electrode* of the lamp, consisting of a short cylinder of iron or graphite, is supported in the centre of the tube near the upper end. Connection to the electrodes is made by means of platinum leading-in wires. Owing to the presence of the mercury in the otherwise exhausted tube this is always filled with mercury vapor. If the two electrodes of the lamp are connected to a 110 volt direct current circuit, the mercury electrode being connected to the negative side, and the iron or graphite electrode to the positive side, no current will pass through the lamp. The reason for this lies in the fact that there is an extremely high resistance between the negative electrode and the mercury vapor. If the current is once started this high negative electrode resistance disappears and the current continues to flow through the lamp. If the current is interrupted, however, for even the shortest time, this high negative electrode resistance reasserts itself. Means must, therefore, be provided in the mercury vapor lamp for breaking down the negative electrode resistance on starting the lamp. This is most conveniently done by tilting the lamp until the mercury bridges across the tube from the negative to the positive electrode, thus forming

a metallic circuit through the mercury; when this bridge of mercury breaks, an arc follows which breaks down the negative electrode resistance, and the current then continues to flow through the mercury vapor. The heated mercury vapor also has the property of diminishing in resistance with increase in temperature, so that a balancing resistance must be used in series with the lamp. The standard lamp takes a current of 3.5 amperes. In the operation of the lamp, the negative electrode is disintegrated, forming mercury vapor; this condenses again in the upper part of the tube, and the condensed mercury flows back, thus reconstructing the negative electrode. It is for this reason that a substance like mercury must be used for the negative electrode. The positive electrode undergoes no change in the operation of the lamp. The lamp as described here can only be used on direct current. A special form of mercury vapor lamp has recently been designed which operates on alternating current.

PARALLEL SYSTEM OF ELECTRIC DISTRIBUTION.—Electric current is generally distributed for incandescent lighting by the *parallel system*, already referred to in connection with stationary motors and electric railways. In this system the lamps are placed on short parallel circuits between supply wires which branch off from the main wires as shown in Fig. 75, so that each lamp receives the supply voltage, and takes the current it requires independent of all the other lamps.

The amount of current taken by any lamp is determined by the resistance of its filament; for an ordinary 100 volt 16 candle-power incandescent lamp this current is one half ampere. The total amount of current which must be supplied to a group of incandescent lamps is equal to the number of lamps multiplied by the current

taken by one lamp. For instance, if there are 2,000 lamps in a circuit, each of 100 volts and 16 candle-power, the current supplied will be 1,000 amperes, while the voltage supplied is 100, just the same as when only one lamp is in circuit.

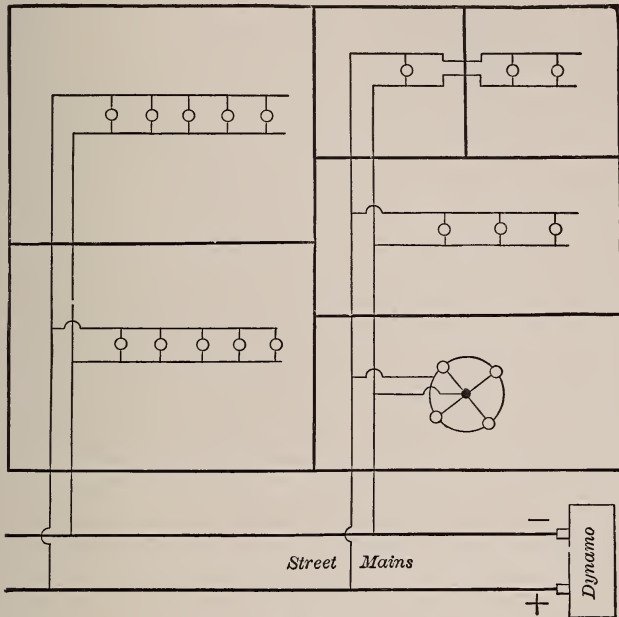

Fig. 75.

When current for incandescent lighting is supplied from street mains, the latter are tapped by feeder wires opposite each building as shown in Fig. 75. Only so much current flows into each building as is required by the lamps in circuit. Each feeder circuit is led to a convenient point in the building from which separate circuits are led off, each supplying a group of lamps. In large buildings there may, however, be a number of such

centres of distribution from which the individual branch circuits are supplied. Each of the branch circuits has a switch for opening and closing the circuit. Short pieces of an easily fusible metal of high resistance, such as tin or lead, called *fuses*, are also connected in each branch circuit. The object of these fuses is that they should melt and interrupt the circuit, in case the current becomes excessive, due to accident, and so prevent the wires from becoming overheated and possibly starting a fire. The fuses are placed in a fire-proof box so that they do not produce a fire hazard when they melt. There are also fuses and a switch in the main circuit at its entrance in the building.

When current for incandescent lighting is supplied from a central station all the dynamos are usually connected to two heavy copper bars, called *bus bars*, by which the dynamos are all connected in parallel, and from which all the incandescent lighting circuits are supplied.

THREE-WIRE SYSTEM.—In the *Edison three-wire system* of distribution, the dynamos at the station are coupled together in pairs, the positive pole of one dynamo and the negative pole of the other being connected with the same bus bar, called the *neutral bus*, and the two remaining poles being each connected with a separate bus bar. Each supply circuit has three wires which are connected to these three bus bars, and extend through the streets, and are tapped by similar circuits extending into the buildings, in which the lamps are placed on short wires which connect the central wire with either outside wire, as shown in Fig. 76, and making two parallel circuits supplied by three wires instead of by four wires as would be required by two circuits in the two-wire system; there is thus a saving of one wire, a very material item

in the expense of the large copper wires required in the parallel system.

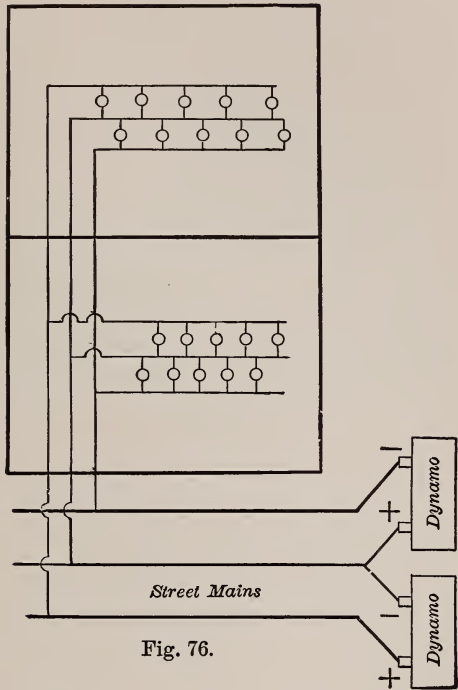

The two outside wires carry the principal part of the current for both circuits, which flows through the lamps from the positive to the negative wire. But when more lamps are lighted in one circuit than in the other, as is usually the case, more current, proportionally, is required by the circuit having the greater number lighted. The neutral wire carries, therefore, only the excess of the current in one outside wire over that in the other outside wire. The neutral wire can, therefore, be made of smaller cross-section than the outside wires.

CHAPTER VIII.

HEAT AND ELECTRICITY.

ELECTRIC HEATING.—The use of electricity for heating is comparatively recent, and has been made practical, within certain limits, by the invention of properly constructed heaters. But the cost of current is still a serious obstacle to its general use, so that, notwithstanding its superior advantages, it cannot compete successfully with other means of heating till current can be supplied more cheaply than at present.

But on electric railways, where all the facilities for supply of current are already in use, so that the additional current required for heating the cars can be had by a little enlargement of the generating apparatus, it has been found that heat can be supplied in this way more economically than by any other method; about 35 cents a day, per car, being the average cost.

DEWEY HEATER.—Among the electric heaters which have come into successful practical use is the Dewey heater, employed both for car heating and for house and office heating. It is constructed with an iron case having openings above and below for the free circulation of the air, as shown in Fig. 77. This case incloses one or more coils of wire, made of a composite metal which has high electric resistance, and therefore becomes hot when the coil is traversed by the electric current. Each coil is wound in a great number of turns, separated by narrow

air spaces, on two porcelain insulators, which are notched to keep the wire in place, and supported on a vertical iron plate in the center of the case, extending from end to end; one insulator resting on the upper edge of the plate and the other on its lower edge; the plate being perforated with holes for air circulation.

The two terminals of the coil are connected with the electric circuit at the points of

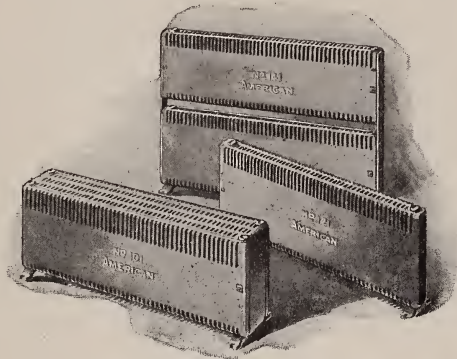

Fig. 77.

attachment shown at the upper corners, and in the two-coil heaters shown, one or both coils may be employed, according to the degree of heat required; the two being either placed side by side, as shown in the lower heater, or one above the other, as shown in the upper heater. Single-coil heaters, like the upper half of the upper heater, are also made for attachment to the side of a car, or wall of a room.

These heaters may be employed advantageously in the house or office, to furnish a mild heat in chilly weather, when the furnace is not in use, or to heat bed-rooms and other small apartments; or they may be employed exclusively instead of other heating apparatus, to furnish any degree of heat required, by those who can afford to pay for sufficient current.

Fig. 78 shows a street-railway car equipped with four

single-coil heaters, which are sufficient to heat a small car, six being usually employed for large cars; the object being to distribute the heat evenly in different parts of

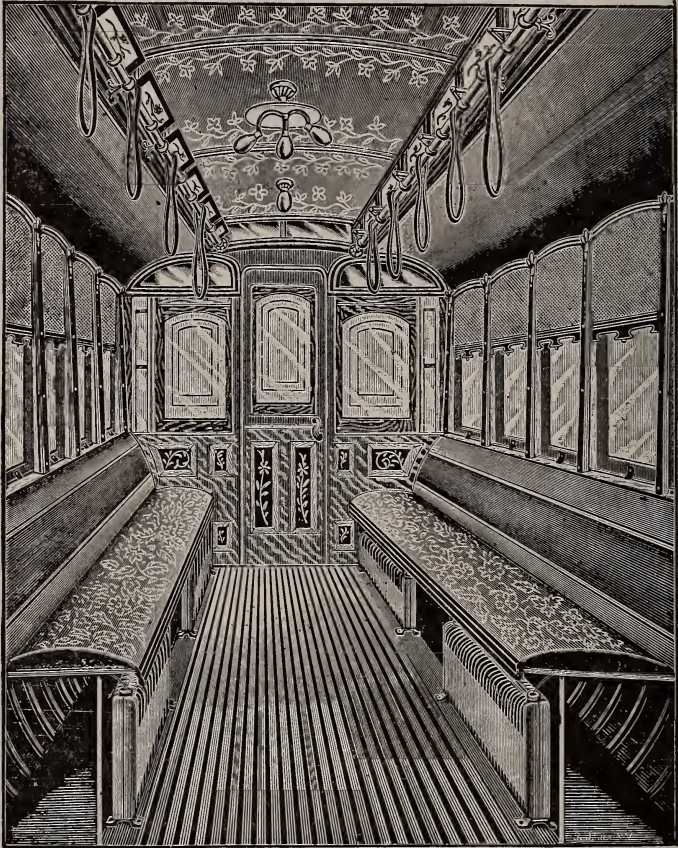

Fig. 78.

the car by several single-coil heaters, instead of concentrating it at one or two points by a smaller number of two-coil heaters. They fit easily under the seats, as

shown, and may be attached either to the floor or sides of the car.

They are connected with the electric circuit in different ways, and the current is admitted by the closing of a switch, or excluded by opening it. They may be connected in a single series, in which all the heaters are included; or in two series connected together in parallel, in each of which half the heaters are included; or in two separate series, each connected with the circuit by a separate switch, so that, when both switches are closed, all the heaters are in use, but when only one is closed, half of them are in use; the connections being so arranged, in the latter case, that the heaters in use are on opposite sides of the car.

By these different methods the heat can be adapted to the requirements of the climate and season; the parallel-series method giving the strongest heat, and the heat produced by each of the other methods being proportioned to the number of heaters in use.

The incandescent electric lamps by which the car is lighted are also shown in Fig. 78, making the electric equipment complete, for heating, lighting, and propulsion.

CARPENTER HEATER.—In the Carpenter heater the coils are imbedded in a special insulating enamel, on iron plates made in any convenient form, either flat or cylindrical, and inclosed in iron cases of any suitable style, which may resemble ordinary heating stoves, and are furnished with openings for radiation of the heat, and for ventilation.

ADVANTAGES OF ELECTRIC HEATING.—The great convenience of the electric system of heating over every other system becomes apparent when we consider that it furnishes heat without dirt, dust, smoke, or smell, supply-

ing it instantly when wanted by the simple closing of a switch, or excluding it instantly when not wanted by the opening of the switch, so that there is no waste of current: while heating by stoves, furnaces, steam, or hot water involves the labor and expense of supplying coal, making and caring for the fire, removing ashes and cinders, with attendant dirt, dust, and smoke; or of maintaining a supply of water in the boiler, and keeping boiler, pipes, and coils in repair; there being always a considerable waste of heat, even under the most favorable conditions. The electric system includes all the advantages of every other system without any of the disadvantages; even dispensing with chimneys and smoke-stack. Hence whenever current can be furnished at such cost as to make its use economical, electric heating must come into general use, wherever current is obtainable.

ELECTRIC COOKING.—Electricity can be employed more economically for cooking than for space heating, because the heat can be concentrated under each cooking utensil separately, so that none is wasted on the surrounding air; and far less current is required in proportion to the work accomplished than in space heating. Hence, even at the present cost of current, this method of cooking can be employed economically wherever current is obtainable.

The electric cooking range is far superior, in convenience and comfort, to the coal or wood range, and fully equal to the gas range. The cost of current is no greater than that of gas, as usually supplied, and the heating of the kitchen, in summer, still less than that of gas; while there can be no such thing as an explosion in the oven, or danger incurred by the escape of gas, to which even the best gas range is liable by careless use; the electric range being absolutely free from every element of danger.

Cooking utensils are prepared for electric use by the Carpenter method, by attaching to the bottom of each an iron plate, as in the electric tea-pot shown in Fig. 79, which is coated with the special enamel already referred to, in which is imbedded a coil of composite metal wire, the same kind as that used in the heaters; the plate being supplied with a socket by which the coil can be connected with the electric circuit.



Fig. 79.

The wire in this coil is corrugated, as shown in Fig. 80, to prevent the enamel from being cracked by expansion and contraction of the coil, in heating and cooling; the difference of expansion by heat, between the enamel and this wire, being too slight, in these short corrugations, to produce injury.

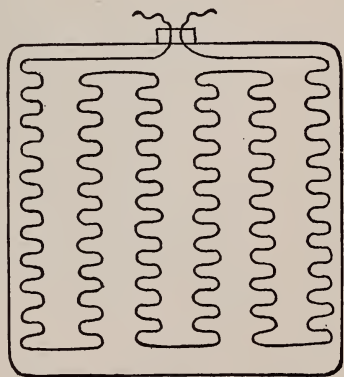

Fig. 80.

The range consists simply of a slab of marble or slate, on which the various utensils are placed, as shown in Fig. 81. Above this is a switch-board, to the back of

which are attached a number of spring-jacks, connected with the electric circuit; and by thrusting a plug into one of these spring-jacks, through a hole in the board,

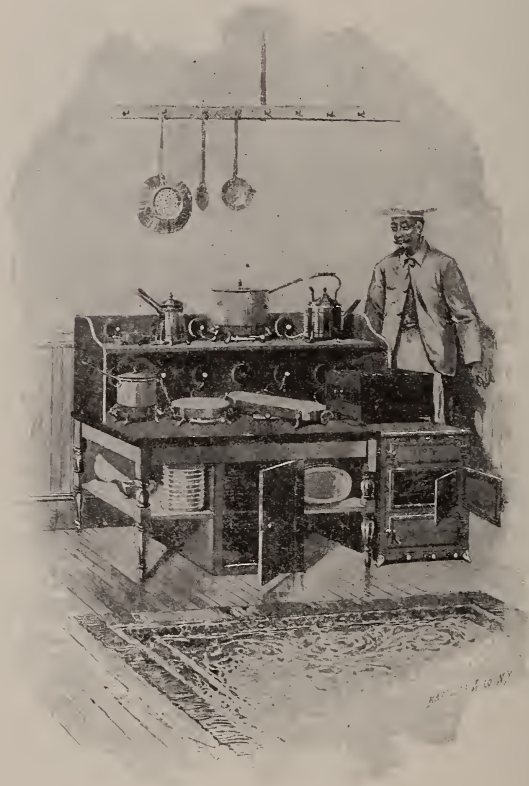

Fig. 81.

any utensil can be connected with the circuit by its socket, through a flexible conductor attached to this plug, as shown.

On the right is shown the oven, constructed with coil-bearing plates for heating above and below ; the connections of which with the electric circuit are so arranged that by the turning of a switch the heat can be regulated for any kind of work, so as to produce a strong heat or a mild heat, as may be required. Water tanks can also be arranged with suitable connections, either for a constant supply of hot water or for laundry work.

ELECTRIC IRONING.—In Fig. 82 are shown four laundry irons, with flexible conductors attached, by which constant connection with the electric circuit, and hence a steady heat, can be maintained while the iron is in use ; so that the same iron can be used continuously ; the heating by the electric current being equalized by the cooling by evaporation from the damp clothes. Thus one iron can do the same work as several by the ordinary process, and the changing of irons and caring for the fire, the scorching and soiling of the clothes, and the heating of the kitchen or laundry in warm weather are avoided.



Fig. 82.

ELECTRIC WELDING.—Metals can be welded more perfectly by electric heat than by furnace heat, and the electric process is now employed successfully, not only for welding together metals capable of being united by the ordinary process, but also for

welding which is impracticable by this process. This includes the welding of such metals as cast-iron and cast-steel, copper, brass, tin, lead, bismuth, bronze, and German silver; each of which can not only be welded to its own kind, but to any other kind of metal.

The process consists simply in pressing the two pieces of metal together while heated at the junction by an electric current till they become soft enough to unite. Two bars, for instance, may be pressed end to end and fused together, in this way, instead of being lapped, and hammered or rolled together, as by the ordinary process. The experiment is easily performed with two or three storage battery cells; but, for practical work, a *welder* of special construction is required. This machine is made with massive copper clamps for gripping and holding the metals, applying the pressure, and admitting the current close to the junction. The alternating current is usually preferred, and is supplied by a dynamo specially designed for the purpose, at a high electric pressure, which is reduced in the welder, by a transformer of special construction, to low pressure, with corresponding increase of volume, which may be varied as required for different kinds of work.

Wire cables can be successfully welded by this process, also metal tubes, and it can be advantageously employed for repairing broken shafts and other parts of massive machinery. It can also be used with special advantage for welding joints in electric conductors; a welded joint having the same conductivity as any other part of the conductor, and being free from the electric resistance and liability to oxidation of joints made by contact and soldering. The time required for making a weld varies according to its kind, from a second to three minutes.

ELECTRICITY GENERATED BY HEAT.—Electricity can be generated by heat, as well as heat by electricity. This is accomplished by an instrument called the *thermopile*, which is constructed with a number of short bars of two different kinds of metal which show a great difference of electric potential under the influence of heat. Bismuth and antimony are the metals usually selected for this purpose. An equal number of bars of each metal, about six inches in length, are arranged in a series in which the bars of each metal alternate with each other, and are either soldered or electrically welded together, end to end, at the junctions; being arranged in a compact pile, with insulating spaces between, so that alternate junctions are at opposite ends of the pile.

By mounting this pile on an insulating support and exposing one end of it to heat, alternate junctions are heated, and a current of electricity generated, which flows from the bismuth to the antimony bars through the heated junctions, and from the antimony to the bismuth bars through the alternate junctions at the opposite end of the pile, and hence continuously in the same direction; the circuit being completed by a copper wire, or other conductor, attached to the terminal bismuth bar at one end of the series, and the terminal antimony bar at the other end. The electric generation may be greatly increased by cooling one end of the pile while heating the opposite end, so that while the junctions at one end are heated, the junctions alternating with them, at the other end, are cooled; thus producing a difference of electric potential proportionate to the difference of heat potential.

This is a very sensitive instrument, being capable of generating a perceptible electric current by an imperceptible degree of heat; hence it is employed as a ther-

mometer in delicate laboratory experiments with heat; but it cannot be used for generating electricity for ordinary practical use; the electric current generated by it being weak, and the degree of heat which may be applied without fusing the bismuth, very limited. Various attempts have been made to construct powerful electric batteries on this principle; metals being employed which do not fuse easily, and a high degree of heat applied; but no permanent practical success has resulted from these experiments.

The earth itself is doubtless a great thermopile, generating electric currents by the difference of potential between its heated and cooled parts, as explained in Chapter II.

Various attempts have also been made to produce electromagnetic motors which can be operated by the direct application of furnace heat, without the intervention of the steam engine and dynamo; but no practical results have yet been accomplished in this way, though laboratory experiments have demonstrated the possibility of constructing motors of this kind having very limited energy.

CHAPTER IX.

THE TELEGRAPH AND TELEPHONE.

SIMPLE TELEGRAPH EQUIPMENT.—The electric telegraph, in its simplest form, consists of an electric circuit connecting the points between which telegraphic intercourse is established, a battery at each point, connected with this circuit, and two instruments, one for transmitting and the other for receiving electric impulses by

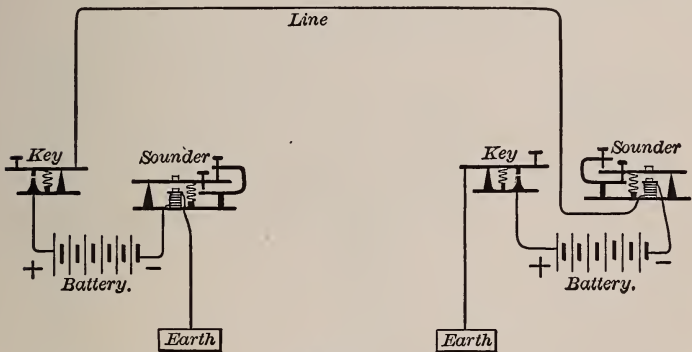

Fig. 83.

which arbitrary signs representing written language are produced.

As batteries have already been fully described in Chapter III, it is only necessary to remark that the gravity battery, there described, is the one in general use for telegraphing in America, as it is not liable to polari-

zation, has great constancy, and needs but little care. But in large offices, in the principal cities, the dynamo is now generally employed instead of the battery.

The circuit is constructed either with a zinc-coated iron wire or hard-drawn copper wire supported on poles by glass insulators, and connected, through two of the instruments, with the positive pole of one battery and the negative pole of the other, as shown in Fig. 83; the remaining pole of each battery being connected, through the remaining instruments, by a short wire, with the earth, by which the circuit is completed. The earth, in this case, is not considered a conductor in the same sense as the wire, but as an electric reservoir, from which electricity is obtained at one end of the line, and to which an equal quantity is restored at the other end.

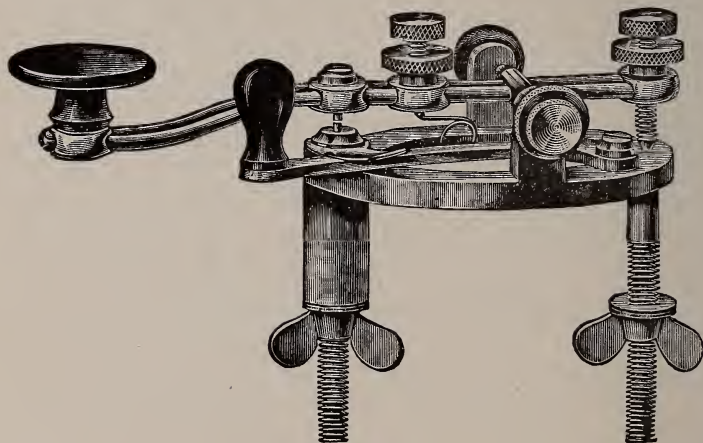

Fig. 84.

THE KEY.—The transmitting instrument is called a *key*, and is constructed as shown in Fig. 84, with a

hinged lever which can be depressed by an insulating knob in opposition to a supporting spring, so as to bring into contact two points, shown under the lever on the left, and thus close the circuit; one terminal of the circuit being connected, through the lever and mountings,

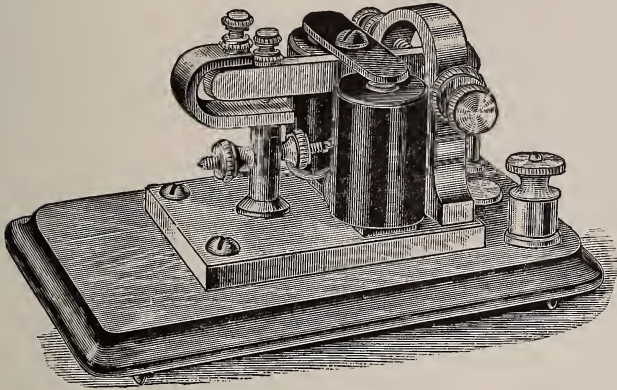

Fig. 85.

with the upper point, by the right-hand attachment bolt, and the other terminal connected with the lower point by the left-hand attachment bolt, which is insulated from the other parts. The movements of the lever can be adjusted by set-screws to any required range, as shown.

When the key is not in use, the circuit is closed for the reception of a message from the opposite station by pushing a short lever under a projection, as shown. But when a message is to be transmitted, the circuit is opened by moving this lever out of contact with this projection.

THE SOUNDER.—The receiving instrument most generally used is called a *sounder*, the construction of which is shown in Fig. 85. A lever mounted on an arched support, at the right, has a limited vertical movement between

the ends of a curved bar on the left, which can be adjusted to any required range by two set-screws. This lever has a short vertical arm, on the right, which is connected by a spiral spring with the post which supports the curved bar, as shown; and the tension of this spring brings the lever into contact with the upper set-screw in the curved bar. An iron armature, attached to the center of the lever, is attracted downward by an electromagnet, in opposition to the force of the spring, when current is transmitted, bringing the lower set-screw into contact with the lower end of the curved bar.

The magnet coils are connected with the electric circuit by the two binding-posts on the right; and as current is alternately transmitted or stopped by the manipulation of the key at the distant station, the lever vibrates between the ends of the curved bar, emitting a succession of distinct clicks, by which the message is indicated; a loud click, when descending, and a fainter click, when ascending, so that each kind can easily be distinguished.

THE MORSE ALPHABET.—The characters representing letters, numerals, and punctuation marks, invented by Morse for telegraphic communication, are given in Fig. 86. They consist of four distinct elements, short dashes, long dashes, dots, and spaces, arranged in different ways. *T*, for instance, is represented by a short dash, *L* by a long one, *E* by a dot, *I* by two dots, *O* by two dots separated by a short space, *A* by a dot followed by a short dash, *N* by a short dash followed by a dot, and so on.

These characters were evidently employed on account of their special adaptation to the original method of receiving the message, which was by marks made with a pencil or a steel point, on long strips of paper, fed automatically from a roller, in a machine called a *register*.

But it was soon found that the message could be read much more rapidly by the clicking of the point than by the marks which it made; and hence the sounder, described above, was invented, and took the place of the

<i>A</i>	<i>B</i>	<i>C</i>	<i>D</i>	<i>E</i>	<i>F</i>	<i>G</i>	
-----	-----	-----	-----	-----	-----	-----	-----
<i>H</i>	<i>I</i>	<i>J</i>	<i>K</i>	<i>L</i>	<i>M</i>	<i>N</i>	<i>O</i>
-----	-----	-----	-----	-----	-----	-----	-----
<i>P</i>	<i>Q</i>	<i>R</i>	<i>S</i>	<i>T</i>	<i>U</i>	<i>V</i>	<i>W</i>
-----	-----	-----	-----	-----	-----	-----	-----
<i>X</i>		<i>Y</i>		<i>Z</i>		<i>&</i>	
-----		-----		-----		-----	
Period.		Semicolon.		Comma.		Exclamation.	
-----		-----		-----		-----	
Interrogation.		Paragraph.		Parenthesis.			
-----		-----		-----			
1	2	3	4	5			
-----	-----	-----	-----	-----			
6	7	8	9	0			
-----	-----	-----	-----	-----			

Fig. 86.

register, though the register is still employed in special cases; a pen and ink being usually preferred to the embossing point.

The clicks and pauses of the sounder have, in this way, come to represent the dots, dashes, and spaces of the

Morse alphabet. As the register point would evidently rest on the paper during the pause following a down click, making a dot, a short dash, or a long dash, according to the length of the pause; or would be lifted off the paper for a corresponding time, during the pause following an up click; so, in the sounder, a down click followed instantly by an up click, represents a dot; a down click followed by a short pause, represents a short dash, or, followed by a long pause, a long dash; an up click followed by a short pause represents a short space, or, followed by a long pause, a long space. The combination of sounds and pauses representing, in this way, each letter or character, is instantly recognized by the practised ear of the operator, who writes down the message with pen or pencil.

In a modified form of this alphabet, known as the International, now used everywhere except in the United States and Canada, the space element, as in *O* and other letters, is omitted, dots and dashes alone being used. This is the form used on all the cable lines.

THE RELAY.—When a telegraph line exceeds twenty or thirty miles in length, the loss of electric energy by the electric resistance of the circuit, and leakage from imperfect insulation, render the current too weak to operate the sounder properly, and an auxiliary local battery is required for this purpose, at each station, whose circuit is closed and opened by an instrument called a relay, which is so delicately adjusted that it can be operated by this weak line current.

This instrument, shown in Fig. 87, is constructed with an electromagnet, which can be connected with the main circuit by the two binding-posts on the right. An armature, supported on a hinge opposite the poles of this magnet, carries a vertical lever, which has a limited vibration

between two platinum points attached to set-screws, supported on a curved yoke, as shown; the left set-screw being insulated from this yoke. Two spiral springs, connected with this armature, a weak one below, and a stronger one above, operate against each other, and can be adjusted to any difference of tension required to make the vibrations of the lever respond promptly to the magnetic attraction of the armature.

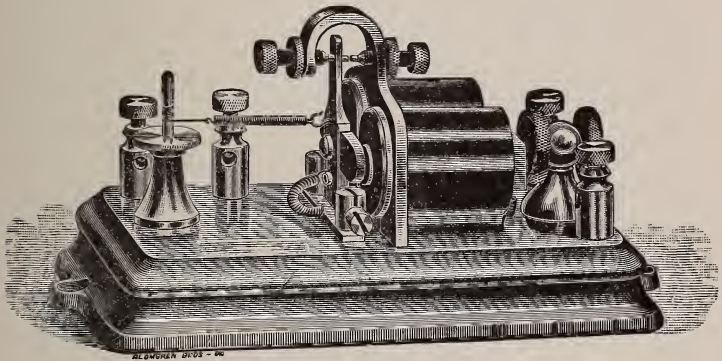

Fig. 87.

The circuit of the local battery includes the sounder, and is connected with the two binding-posts on the left, one of which is connected with the armature and attached lever, and the other with the curved yoke, through its support.

When there is no current in the main circuit, the lever is pulled against the left insulated point by the upper spring, and hence the circuit of the local battery is open; but when current is transmitted through the main circuit, the armature is attracted and pulls the lever against the right point, closing the circuit of the local battery, and operating the sounder.

The vibrations of the lever can be adjusted to any required range by the set-screws, and the tension of the springs being also properly adjusted, the instrument can be made to respond instantly to the weakest current transmitted through the main circuit; the sounder responding simultaneously to the stronger current of the local battery, and to the manipulations of the operator's key, a hundred miles away.

CUT-OUT AND LIGHTNING ARRESTER.—Every telegraph station must be furnished with a lightning arrester, and also an apparatus by which the instruments can be either cut out of the circuit or connected with the earth, as may be required.

The simple little apparatus shown in Fig. 88 fulfils these three functions. It is constructed with three brass plates, attached to an insulating base, with spaces between them, so that they are insulated from each other; a brass plug being furnished by which they can be electrically connected. The two side plates are connected with the main circuit by the terminal wires attached to them above, and with the instruments by the wires attached to them below; and the central plate is connected with the earth by the wire attached to it. Hence the line current, entering by either side plate, must traverse the instruments before it can leave by the other side plate, when all the holes are open, as shown. But if the plug, shown at the center, be inserted into the lower hole, the current will pass through it, direct from one plate to the other, without traversing the instruments.

If, when the plug is out, lightning should strike the line wire, it will usually take the shorter route through the points, across to the central plate, and thence to the earth by the central wire, instead of the longer one

through the instruments. But as an unusually heavy discharge may divide, and part of it traverse and injure the instruments, it is important that they should be cut

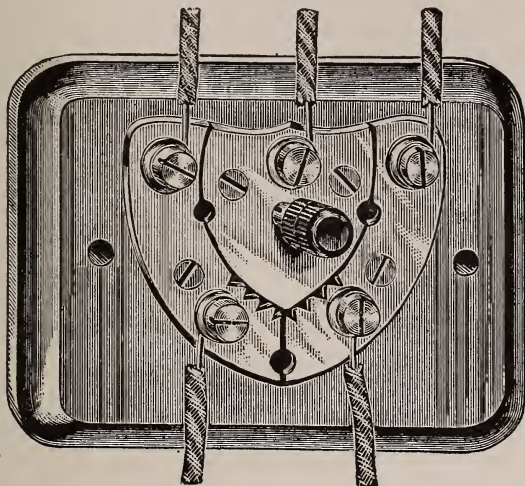

Fig. 88.

out by the plug during a thunder-storm or the absence of the operator.

If a break occurs in the line wire, by which the current flowing through a way station is interrupted, connection can be reëstablished with the stations on the opposite side from the break by inserting the plug into the side hole next the break, so that current can flow through the instruments to the earth by the central plate and wire. If the break occurs on the left, and the plug should happen to be inserted first into the right-hand hole, the current would flow direct to the earth, without traversing the instruments; and the operator, perceiving this, would then move the plug to the left-hand hole, and

thus reëstablish current through the instruments, and locate the direction of the break.

REPEATERS.—When messages are to be transmitted long distances, the battery current must be replenished before it becomes too weak to operate the relay. Hence main batteries must be located along the line wherever required for this purpose, by which current can be supplied for repeating the message from one of these stations to another, to any required distance.

This requires the employment of two instruments called *repeaters*, at every such station, each connected with a main local battery, whose circuit can be closed automatically by the line current, which traverses both instruments, so that current can be transmitted from either battery according to the direction in which the message is to be repeated; the circuit of one battery being opened at the same instant that the circuit of the other one is closed.

If, for instance, a message is to be transmitted from New York to Chicago, it must pass through several such stations, at each of which the two repeaters may be distinguished as the eastern and western. Current transmitted by the manipulation of the New York operator's key, automatically closes the local battery circuit through each western repeater and opens it through each eastern repeater, so that the message is repeated instantly, from east to west, all along the line. In like manner, when a message is to be transmitted from Chicago to New York, these conditions are reversed by the manipulation of the Chicago operator's key; each eastern repeater circuit being automatically closed, and each western repeater circuit opened.

The repeater is simply a relay which operates a sounder

by a small local battery, in the usual manner; and has attached to it an extra magnet, which opens and closes the circuit of one of the main local batteries for repeating, as above.

DUPLEX TRANSMISSION.—The simple apparatus already described is sufficient for the moderate amount of business done on telegraph lines where the transmission of a message can be delayed while the line is occupied with the reception of a message; but is quite inadequate for the transaction of the large volume of business done on many of the principal lines. Therefore, to prevent the expense and inconvenience of an excessive multiplication of wires, it became necessary to devise what is known as the *duplex* system, by which messages can be transmitted simultaneously, in opposite directions, by the same wire. This has been accomplished in two different ways, by means of relays of special construction, one of which, invented by Stearns, is known as the *neutral* relay, and the other, invented by Siemens, as the *polarized* relay.

THE NEUTRAL RELAY.—The neutral relay is constructed with an electromagnet having two pairs of coils oppositely wound, one pair being connected with the line and the other pair with the earth, at each station. When an equal volume of current flows through each pair, the magnetic polarity is neutralized by the opposite winding, and no effect is produced on the armature; but when current flows through only one pair, or more current flows through one pair than through the other pair, the armature is attracted, closing the circuit through the sounder, and producing a down click.

TRANSMISSION BY THE NEUTRAL RELAY.—Suppose two stations, *A* and *B*, equipped as shown in Fig. 89; each being furnished with a neutral relay, connected as above,

and also with a sounder and key, at each of which an operator is seated; and that messages are to be transmitted from each station to the opposite station, at the same time. The circuit being closed by depression of the key at *A*, current flows, in equal volume, through both branches of the relay; one half going to the earth by the coils *m* and *p*, and the other half to the line, by the coils *o* and *n*, neutralizing the magnetism, and therefore producing no attraction of the armature. But the half which goes to the line enters the relay at station *B*, and traversing only the branch *n'* and *o'* connected with the line, produces attraction of the armature, and a down click in the connected sounder.

If now the key at *B* is also depressed, current will flow to both branches of the relay, one half going to the line branch, *o'* and *n'*, and neutralizing the line current from *A*, and the other half to the earth, through branch *m'* and *p'*, so that the armature is still held attracted as before. But the current through the line branch of the relay at *A* being neutralized also, while current still traverses the earth branch, the armature is attracted, and a down click produced in the connected sounder.

Now if the key at *A* is opened, the current from *A*'s battery ceases entirely, so that current from *B*'s battery flows equally through both branches of the relay at *B*, neutralizing the magnetism, and therefore releasing the armature and producing an up click in the connected sounder. But the current from *B* flowing in through the line branch of the relay at *A*, its armature is still held attracted as before. If now the key at *B* is also opened, *B*'s battery current ceases entirely, releasing the armature at *A*, and producing an up click in the connected sounder.

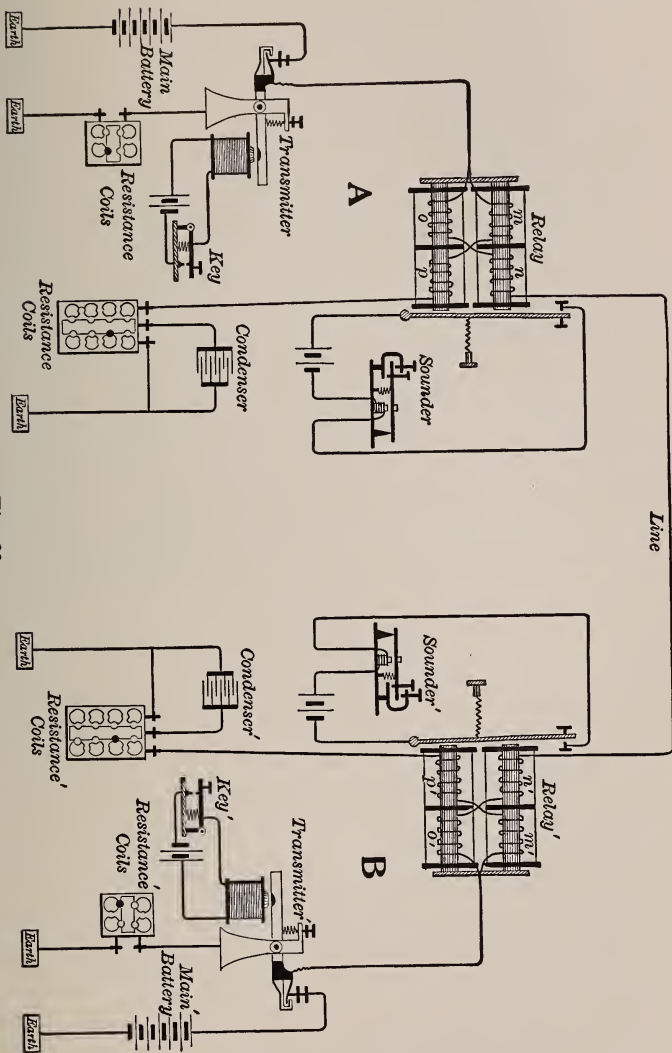

Fig. 89.

Hence it will be seen that each sounder responds to the manipulation of the key at the opposite station, as in single transmission, but is unaffected by the manipulation of the key at the home station; so that there can be simultaneous transmission in opposite directions, by the same wire, without the slightest interference. Two of the three ground wires, at each station, traverse resistance coils, by which the resistance of this branch of the circuit is made equal to the line resistance, so that the currents traversing each branch of the relay shall be exactly equal. There is also a *condenser* connected with the ground wire of the relay, by which false currents, due to static charges of the line, are suppressed.

CONDENSER.—The condenser is constructed with a number of sheets of tin-foil, insulated from each other by paper saturated with paraffine. The ends of alternate sheets project beyond the paper and come into contact on opposite sides of the condenser; all the evenly numbered sheets being in contact on one side and all the oddly numbered sheets on the other side. Hence, when each side is connected with the electric circuit, as shown in Fig. 89, an electric charge, either positive or negative, produced on the tin-foil sheets on one side, produces, by induction, an equal charge of opposite kind on the other side, which can be employed as above, or in other ways equally important.

TRANSMITTER.—A *transmitter*, connected with the key and operated by a small battery, closes and opens the circuit through the main battery, and also through the central ground wire; always opening one circuit as it closes the other.

The neutral relay, for duplex transmission, has been superseded by the polarized relay, which is a more sen-

sitive instrument; and it has been described only on account of its use in quadruplex transmission, to be described hereafter.

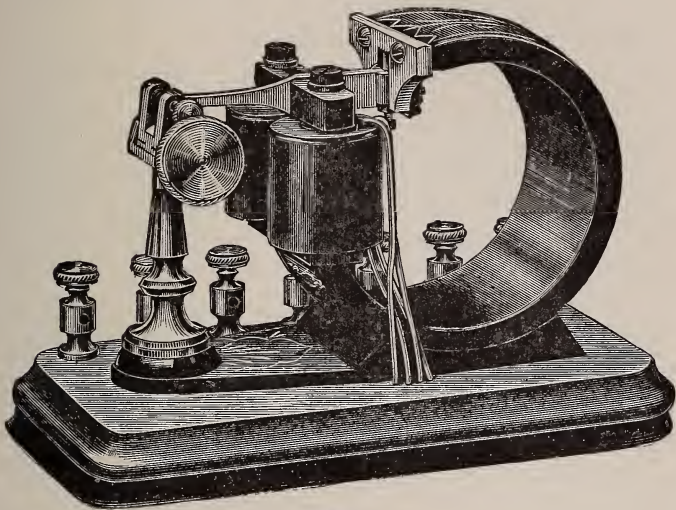

Fig. 90.

THE POLARIZED RELAY.—It is unnecessary to weary the reader with a full description of the polarized relay and its mode of operation. But it may be stated briefly that it is constructed with a curved steel magnet combined with an electromagnet, as shown in Fig. 90. The latter has two coils oppositely wound, as in the neutral relay, so that current transmitted equally through both, in a given direction, neutralizes the magnetism, but current transmitted through only one, or in larger volume through one than through the other, produces magnetic attraction of the armature.

The armature is a small iron bar hinged to one pole of the curved steel magnet, so that it can vibrate between

the poles of the electromagnet, which is mounted on the other pole of the steel magnet, as shown. The two poles of the electromagnet are therefore permanently magnetized by the steel magnet, both having the same polarity; and the armature, which vibrates between them, is also permanently magnetized, having opposite polarity, derived from the other pole of the steel magnet. The permanent magnetism does not interfere with the temporary magnetism produced by the transmission of the current through the coils of the electromagnet; but it makes this relay more sensitive than the neutral relay, so that it responds to weaker currents.

The armature, having permanent polarity, is attracted by one pole of the electromagnet and repelled by the other, alternately in opposite directions, in response to the manipulation of the key at the opposite station; closing and opening the circuit and operating the sounder in the usual manner; the connections through the relays at the opposite stations being such that simultaneous transmission, in opposite directions, is effected without interference.

A *pole-changer* is employed in connection with this relay, instead of a transmitter, as with the neutral relay, by which the direction of the battery current, through the relay, is changed from positive to negative, or the reverse, in response to the manipulation of the key.

QUADRUPLEX TRANSMISSION.—Simultaneous transmission in opposite directions, by a single wire, having been accomplished, the next important step was simultaneous transmission in the same direction by a single wire. This was successfully accomplished by a combination of the neutral and polarized relays in such a manner that transmission could be effected through either instrument, by

the other, without interference; the sensitiveness of the polarized relay having been increased and that of the neutral relay diminished, so that a battery current which would operate the polarized relay would not be strong enough to operate the neutral relay, while the stronger current required for the neutral relay would not interfere with the simultaneous operation of the polarized relay.

Two opposite stations being equipped in this manner, it was found that, by a proper adjustment of the resistances and battery currents, four messages could be transmitted simultaneously, in opposite directions, by the same wire, two in each direction; and thus the problem of *quadruplex* transmission was successfully solved.

This system has been in successful operation for many years on our principal telegraph lines; but as it is very complicated, a detailed description would not be in accordance with the simple character of this book, and must therefore be omitted.

AUTOMATIC TRANSMISSION.—Transmission by manipulation of the key does not exceed 25 to 50 words per minute; a rate which is sufficient, in most cases, for the ordinary business of a telegraph office. But this mode of transmission is entirely inadequate for the large volume of telegraphic business done in large cities, including both press dispatches and private telegrams; especially on occasions of extraordinary public interest, or when accidental interruption of telegraphic communication has caused an accumulation of business.

This led to the invention, by Wheatstone, of a system of automatic transmission, briefly described as follows:—The telegrams are prepared for transmission in an instrument called a *perforator*, by which holes are punched in long strips of tough manilla paper, at the proper dis-

tances to operate a *transmitter* in such a manner as to record the message in Morse characters, in a *register* at the distant station.

A strip of paper, punched so as to record the word "*toilet*," would appear as in Fig. 91; in which is shown a row of small holes, at equal distances apart, between two

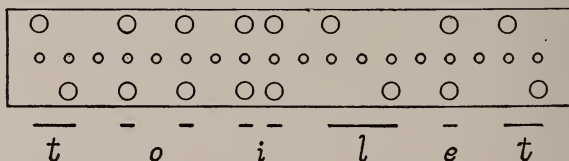

Fig. 91.

rows of larger holes, at different distances apart. A dot is made by arranging these holes as shown at *e*; a short dash by the arrangement shown at *t*; a long dash by the arrangement shown at *l*; and a space by the omission of the upper and lower holes, as shown in *o*, or between any two letters.

When one of these strips of paper is placed in the transmitter, it is moved lengthwise at a uniform rate of speed, by a wheel underneath, having teeth adapted to the central row of holes. On each side of this wheel are little L-shaped levers, each having a short spur which is pressed upward against the paper by a spiral spring, so that when it meets a hole in one of the side rows, it passes up through it, and is pulled down again by a little walking beam; each lever operating alternately in this manner through the two rows of side holes.

These levers are so connected with the battery circuit, as to reverse the direction of the current alternately by their upward movements; one making it positive and the other negative, and thus operating the registering pen at

the distant station ; the positive current depressing it, so as to make a dot or a dash on a moving strip of paper, according to the length of time it is kept depressed, and the negative lifting it, so as to leave a space corresponding in length to the time it is kept lifted.

Telegrams are transmitted automatically in this way, at the rate of 125 to 250 words a minute, about five times as fast as by manipulation of the key ; one operator feeding the strips into the transmitter as fast as a number of others can prepare them on the perforators ; operators at the other end of the line transcribing the messages for delivery as fast as they are received.

SUBMARINE TRANSMISSION.—The telegraph cables which cross the ocean are composed of seven or more copper wires of medium size, twisted together and incased in a thick coating of insulating material, impervious to water, and covered outside with a protecting armor of zinc-coated iron wires ; this armor being much heavier near the shore, as a protection against ships' anchors, than in the deep sea.

As the preservation of the cable from internal as well as external injury is of the highest importance, a comparatively weak current is employed, which is never liable to heat the wires so as to injure the insulating material. The receiving instrument must therefore be so sensitive that it can be operated by this weak current ; so that neither the sounder nor ordinary register, which require much stronger currents, can be employed.

REFLECTING GALVANOMETER.—The *reflecting galvanometer* has the requisite sensitiveness, and was the instrument originally employed for this purpose. It is constructed with a little concave mirror, about half the size of a dime, suspended vertically between two coils of fine,

insulated copper wire, by a silk thread attached to a brass ring above and below. A little magnetic needle is fastened to the back of this mirror, and when the cable current traverses the coils, this little needle turns the mirror to the right or left, according to the direction of the current, which is controlled by the key at the opposite end of the line.

A ray of light, from a lamp, is reflected from this mirror, on a scale three feet distant, producing a round spot of light which rests on the zero mark, at the center of the scale, when there is no current traversing the coils, but is moved to the right or left, when the mirror is turned as above; dots being indicated by movements in one direction, and dashes by movements in the opposite direction, a slight turn of the mirror moving the spot several degrees on the scale.

This instrument is now but little used, the siphon recorder having taken its place.

SIPHON RECORDER.—The siphon recorder, employed for the same purpose, is shown in Fig. 92. It is constructed with a small glass siphon, shown at *A*, lightly poised on a vertical steel wire axis inclosed in the tube *B*, the tension of which is regulated by an adjusting screw shown at the top of the tube. A short transverse spur from the upper end of the siphon is connected by a silk fiber, shown above the tube *C*, with one corner of a light rectangular coil of fine insulated copper wire, mounted on a vertical axis between the poles of a powerful steel magnet *M*. When this coil is traversed by the cable current, it turns in the magnetic field, to the right or left, according to the direction of the current, rotating the siphon slightly on its wire axis, against the torsion of the wire, and causing its point to oscillate across a strip of paper, which is moved

under it at a uniform rate of speed; being pulled to the left by clock-work, and unrolled from the wheel shown at the center of the magnet.

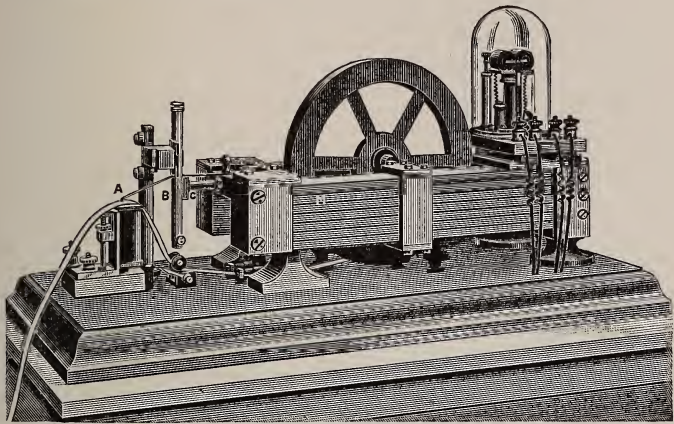

Fig. 92.

The point of the siphon, when at rest, is held exactly over the center of the paper strip; being adjusted to that position by two soft iron armatures, which are slid to the right or left as required, on the poles of the magnet, and control two similar armatures attached to the vertical coil which moves the siphon. When the coil rotates in one direction, the strain of the silk fiber pulls the siphon point toward one edge of the paper, in opposition to the torsion of the wire axis, and when it rotates in the opposite direction, the slack of the fiber allows the torsion of the wire to move the siphon point toward the opposite edge of the paper.

This siphon is a capillary glass tube, the upper end of which dips into ink contained in a small reservoir, from which it is drawn by the siphon's capillary attraction, and

flows from its point in minute drops on the paper, producing a crooked line, as shown in Fig. 93, whose irregular curves and angles, projecting in opposite directions, indicate the Morse characters; dots being indicated by the projections in one direction, and dashes by the projections in the opposite direction.

The point of the siphon has also a rapid vertical vibration which causes the ink to flow, and prevents friction between the ink and paper, which would interfere with the horizontal movements by which the record is made. This vibration is produced by the electromagnetic apparatus shown under the glass shade on the right, which is operated by a local battery, and is connected by an electric circuit with the electromagnet shown under the point of the siphon at *A*. This apparatus consists of an electromagnet mounted on a vertical support, as shown, which operates a vertical steel spring vibrator by means of a soft iron armature attached to it above. This vibrator oscillates at the rate of about eighty times a second between two contact points, one of which is attached to the set-screw shown near its base, alternately opening and closing the circuit of the local battery; the circuit being opened by the attraction of the armature, demagnetizing the electromagnet and allowing the vibrator to fly back and close the circuit, as in the operation of the vibrator of an electric bell, or an induction coil.

A glass tube containing mercury is attached to this vibrator, as shown, and the height of the mercury, which is adjusted by the tube and piston shown on the left, regulates the rate of vibration; this rate being diminished as the center of gravity in the mercury is raised, and increased as it is lowered; as in an inverted pendulum. The electric current passes through a resistance coil

shown, having two circuits differentially wound, by which sparking at the contact points is suppressed.

The electromagnet at *A* is included in the same circuit as this apparatus, and hence is also alternately magnetized and demagnetized by the oscillations of the vibrator; and, when magnetized, it attracts a little armature consisting of a very small piece of fine iron wire, which is cemented to the point of the siphon, pulling down this point, and bringing the ink drop adhering to it into contact with the paper, the point being lifted again by the tension of the wire axis in the tube *B*, when the magnetic attraction ceases; thus producing a vertical vibration of this point at the same rate as that of the spring vibrator, about eighty times a second, by which a dotted line is traced on the paper.

The sole object of the various pieces of apparatus in this instrument is to produce simultaneously the two kinds of vibration of the siphon point; the vertical, by which the ink is drawn from the siphon, and the horizontal, by which the record is made.

AUTOMATIC TRANSMITTERS.—Automatic transmitters are used, which are modified forms of the Wheatstone transmitter, already described. In one of these, invented by Wilmot, the perforated paper is used, and in the other, invented by Cuttriss, indentations in the paper are employed instead of perforations. An average speed of 59 words a minute is maintained with transmitters and receivers of the latest construction, whereas 15 to 20 words a minute is the highest speed attainable by manipulation of the key and the old receivers.

Another very important advantage obtained by automatic transmission is uniformity in the shape of the letters, which makes the record much more legible, and

reduces the liability to mistakes incident to manual transmission. Duplex transmission is also employed.

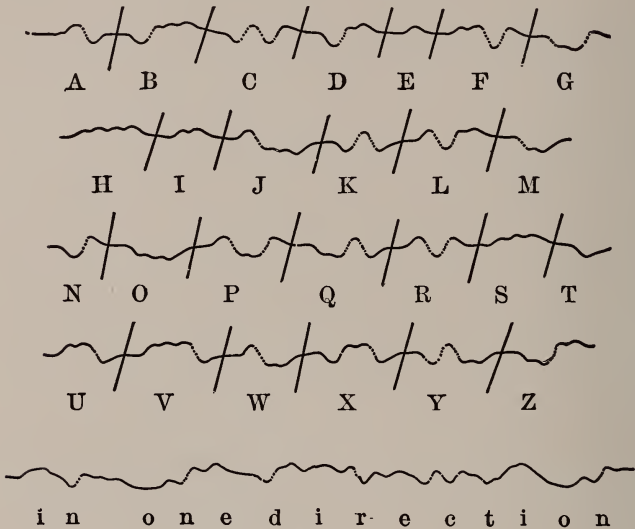

Fig. 93.

CABLE ALPHABET.—The alphabet employed is shown in Fig. 93, and also a sample of the record made on the paper strip, the letters in which can easily be recognized by comparing them with the alphabet.

STATIC CHARGE.—The construction of the cable, with internal and external wires, separated by insulating material, makes it similar to that of a Leyden jar; so that when the current flows through the internal wires, a static charge is accumulated, as in the Leyden jar; the inside wires being oppositely charged from the outside wires and water in contact with them. This charge opposes and retards the current, so that a current wave sent through an Atlantic cable, by closing the circuit, does

not attain sufficient strength for about three seconds to operate the most sensitive apparatus.

OPERATION OF CONDENSER.—The static charge makes it necessary to keep the cable constantly charged during transmission, so that the receiving instrument shall respond promptly to the flow of current, without waiting for the full rise or fall of each current wave. This is done by connecting the cable, through the receiving instrument, with one pole of a large condenser, whose opposite pole is connected with the earth; and making such connection with the battery circuit, through the transmitter at the opposite end of the line, that the current shall be alternately reversed, through the condenser and receiving instrument, by the closing or opening of the circuit in the transmitter, but not interrupted.

The condensers connected with the Atlantic cables, at each end, are composed of about 40,000 square feet of tin-foil.

THE TELAUTOGRAPH.—The telautograph, invented by Prof. Gray, is an apparatus by which a telegram can be reproduced at one end of the line in the same handwriting in which it was written at the other end. This is accomplished by two instruments, a *transmitter*, shown in Fig. 94, and a *receiver*, shown in Fig. 95. A pencil in the transmitter is attached by a pair of silk cords to apparatus connected with the electric circuit; and as the message is written, this apparatus transmits electric currents through the circuit, which reproduce identical movements in a pen attached to a pair of light aluminum arms, in the receiver, so that the message written in the receiver is a fac-simile of that written in the transmitter.

The receiving pen is a capillary glass tube, supported at an angle made by the junction of the arms, and supplied

with ink through a small rubber tube attached to one of them. The paper in each instrument is supplied from

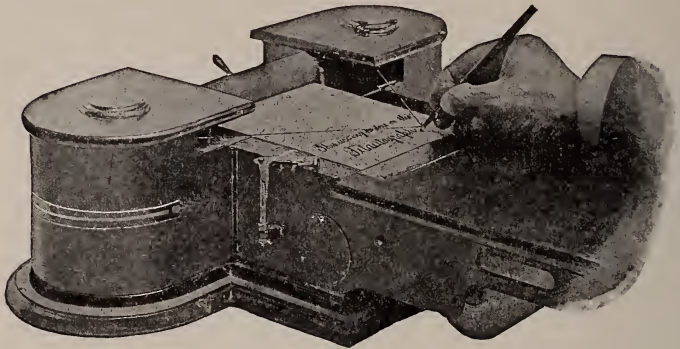

Fig. 94.

a continuous roll; and, in the transmitter, it is moved forward by the writer, as each line is finished, by a lever

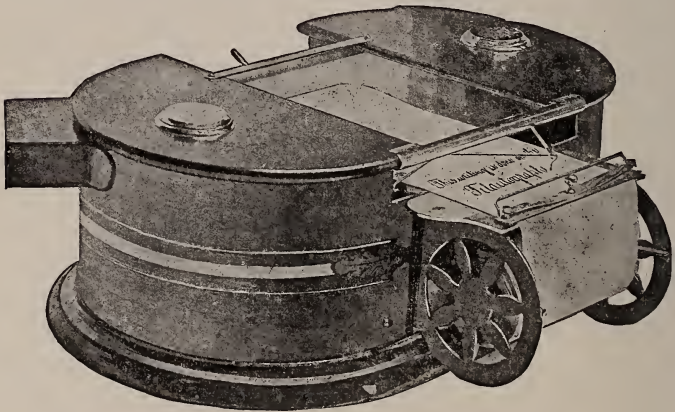

Fig. 95.

shown on the left, which reproduces a similar movement, by electric transmission, in the paper of the receiver.

The chief merit of this system of transmission consists

in the fact, that the handwriting of the person sending a message can be recognized and identified by the person receiving it, and also that it dispenses with the service of the operator; so that important confidential business correspondence, or other correspondence of a strictly private character, can be carried on in this way, without risk of being counterfeited by designing parties, and without the publicity of ordinary telegraphic correspondence, which must pass through the hands of operators and clerks.

Another important advantage is that diagrams and pictures can be reproduced, as well as handwriting; so that press correspondents can illustrate dispatches transmitted in this way. Messages can also be written in the receiver of a person temporarily absent, which will be found on his return.

THE TELEPHONE.—The electric telephone is an apparatus by which articulate speech is reproduced at one end of an electric circuit, by electric impulses transmitted by the voice of a speaker at the other end.

This apparatus is of an exceedingly simple character, and consisted originally of a single instrument, the well-known Bell receiver, which was employed at each end of the circuit, both as a transmitter and a receiver; being held to the mouth for the former purpose, and to the ear for the latter. The electric current was generated in the instrument itself, without a battery, by the slight movements of an armature opposite one pole of a steel magnet, by the impulses of the voice.

This system was improved by the addition of a transmitter of greater sensitiveness than the Bell instrument, which was still retained as a receiver, and also of a small battery to supply the current, consisting of a single sal-ammoniac cell.

THE BELL RECEIVER.—The Bell receiver, illustrated by Fig. 96, is constructed with a hard-rubber case about $6\frac{1}{2}$

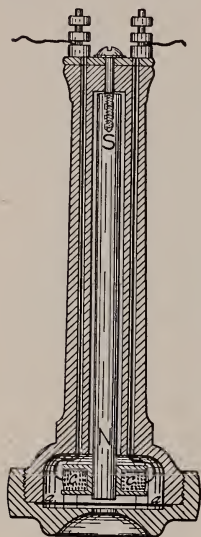

Fig. 96.

inches long, having an ear-piece at one end, with a hole in the center, opposite which is fixed the armature already referred to, which is a thin sheet-iron disk, about twice the size of a silver dollar, called the *diaphragm*, shown in cross-section by the line *a a*. Just back of the center of the diaphragm is shown the pole of a steel magnet, *N S*, to which is attached an insulated coil of fine copper wire, *cc*, connected with the electric circuit; and when a current is transmitted through the circuit and coil, the diaphragm, acting as an armature, vibrates in response to the variations of current strength, producing air-waves, which reproduce the message spoken into the transmitter at the opposite end of the line.

The diaphragm is held fast in the case by its rim, but it has sufficient flexibility to permit the slight vibrations required at the center; and enough space is allowed on each side of it, to prevent contact either with the magnet-pole or the mouth-piece; the width of the space next the pole being so adjusted by the screw at *S*, as to produce the proper magnetic attraction.

THE BLAKE TRANSMITTER.—The Blake transmitter, illustrated by Fig. 97, is the one usually employed on local circuits. The apparatus is contained in a wooden case, hung on the wall at the proper height for speaking into, in the center of which is a funnel-shaped opening

employed for this purpose; opposite which is mounted a diaphragm *a*, like that in the Bell receiver. Just behind this is a little carbon disk, *b*, attached to a brass disk, suspended by a metal spring *c*, so that the carbon disk comes opposite the center of the diaphragm. The end of another spring, *d*, which comes between this disk and the diaphragm, carries two platinum points, one of which touches the center of the disk and the other the center of the diaphragm. These springs are attached to an iron arm, *e*, suspended by a spring, as shown; a short bevel on the bottom of this arm being in contact with an adjusting screw, by which the pressure of the platinum points on the diaphragm and carbon disk can be varied as required.

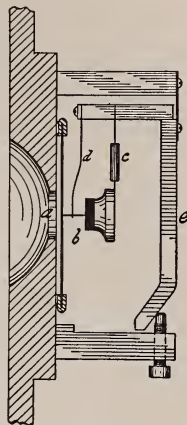

Fig. 97.

The battery cell is contained in a separate compartment below, shown in Fig. 98, and its circuit passes through the springs *c* and *d*, and the disk *b*, and through a lever contained in a separate compartment above, by which the circuit is closed and opened. This lever terminates in a hook outside the case, in which the receiver is hung, as shown; and the circuit is kept open by the weight of the receiver, which pulls down the lever; but when the receiver is taken off the hook, to be applied to the ear, the lever is pushed up by a spring, and closes the circuit; so that current traverses the circuit constantly while the apparatus is in use.

This circuit is connected with the primary circuit of an induction coil, also contained in the lower compartment; and the secondary circuit of this coil is connected,

through the main circuit, with the receiver at the other end of the line.

When a person speaks into the transmitter, the pulsations of the air, produced by the voice, produce the slight vibrations of the diaphragm, already referred to, and these vary the pressure of the platinum point on the carbon disk, and thus vary the strength of the electric current, and reproduce precisely similar vibrations in the diaphragm of the receiver, at the opposite end of the line, which reproduce the spoken words.

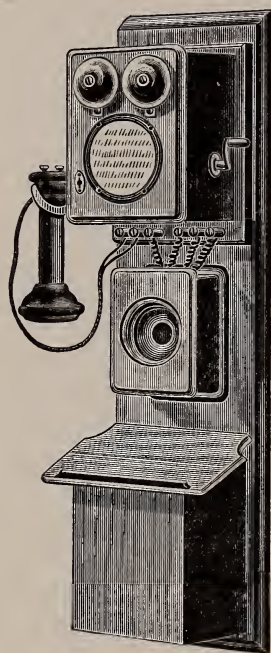

Fig. 98.

In the upper compartment of the case is a little magneto-electric machine, constructed on the same principle as the dynamo, and operated by the crank shown; and when a person, wishing to converse with another, turns the crank, an electric current is transmitted to the central station, by which an annunciator tablet, having this person's telephone number inscribed on it, is exposed to view. The attendant then inquires, through the telephone, the number of the person wanted, and being informed, rings a call

on the bells in this person's telephone instrument, shown in Fig. 98; and the requisite connection being made between the two, each converses with the other through a transmitter and obtains replies through a receiver held to the ear.

DIFFERENCE BETWEEN TELEPHONIC AND TELEGRAPHIC TRANSMISSION.—It should be noticed that transmission by telephone is effected by varying the strength of a constant current in the electric circuit; so that the current rises and falls in waves, and thus reproduces not only the words spoken, but all the modulations and peculiarities of the speaker's voice, so that it can be recognized. Whereas ordinary telegraphic transmission is effected by closing and opening the circuit alternately, producing a series of brief currents, each of which begins and ends abruptly, and produces arbitrary sounds or marks.

CONSTRUCTION OF TELEPHONE CIRCUIT.—The construction of the ordinary telephone circuit, employed for local transmission in towns and cities, is usually similar to that of a telegraph circuit; a single line wire being employed for one branch, and ground wires at each end, for the other branch; copper wire being used instead of iron, on account of its superior conductivity. But a complete metallic circuit, composed of two line wires, is also often employed, which gives more perfect transmission, but is, of course, more expensive.

Each person employing the telephone requires connection with a central station by a separate circuit. And, in a large city, there are several of these stations, connected together by as many main trunk lines as are required by the volume of business; through which connections are made, in rotation, between persons connected with the different stations, in the same manner as between persons connected with the same station.

CROSS TALK.—The indistinct conversation, known as *cross talk*, heard through the telephone, by a person waiting, with the receiver to his ear, to be put in communication with another, is due to electric induction between

numerous parallel wires mounted on the same brackets. This can be corrected on complete metallic circuits by crossing the wires, without contact, to opposite sides of the bracket, at regular intervals along the line, or twisting them together when in cables; an arrangement by which the induced currents on adjacent circuits, which always flow in the opposite direction to the inducing currents, are made to oppose and neutralize each other.

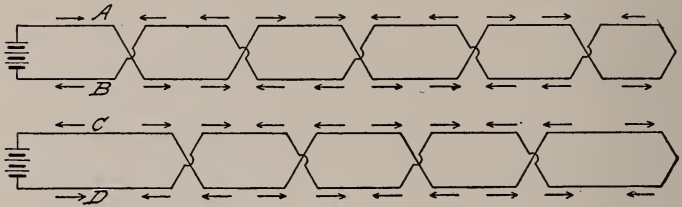

Fig. 99.

THE LONG DISTANCE TELEPHONE.—This transposition is adopted on all long distance lines, which are invariably constructed with two wires. It is illustrated by Fig. 99, in which are shown two parallel circuits, mounted one above the other on the same poles, wire *A* over wire *C*, and wire *B* over wire *D*, and each connected with a battery on the left. The arrows show the direction of the battery current in the upper circuit, and of the opposite currents induced by it in the lower circuit, which oppose and neutralize each other, as shown; the battery current in the lower circuit producing a similar inductive effect in the upper circuit, which it is not necessary to show.

Long distance lines are constructed with much heavier wire than local lines, and are equipped with the *solid back transmitter*, which has greater sensitiveness than the Blake transmitter, and is superseding it on local lines also.

THE SOLID BACK TRANSMITTER.—The construction of this transmitter is shown in Fig. 100. It is made with a metal case having a funnel-shaped mouth-piece in front, which terminates in an opening opposite the center of a diaphragm *a a*, similar to that used in the Blake transmitter. Just back of the diaphragm is a little brass box, *b b*, lined inside with insulating material, mica in front and paper at the sides and rear, and filled with granulated carbon, in which are imbedded two little carbon disks, *c c* and *d d*, each attached to a brass plate, one at the front and the other at the rear, supported opposite the center of the diaphragm. The front plate is attached to the diaphragm by a pin, and the rear plate is attached to an adjusting screw by which the pressure of the carbon disks on the granulated carbon between them is regulated.

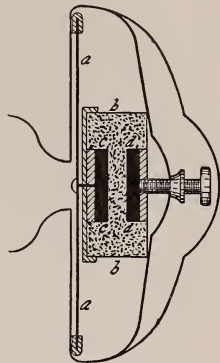

Fig. 100.

The disks being much smaller than the box, the carbon dust, which would be liable to accumulate between them and clog the granulated carbon, sifts down into the lower part of the box. The two plates are connected with opposite terminals of the electric circuit, so that the current traverses the two carbon disks and the granulated carbon between them. The greater sensitiveness of this transmitter, as compared with the Blake transmitter, is due to the granulated carbon in contact with the carbon disks; carbon being superior to any other substance for this purpose, and granulated carbon superior to solid carbon.

The speaker applies his mouth to the mouth-piece, in-

stead of speaking at a little distance from it, as with the Blake transmitter. The Bell receiver is employed in connection with this instrument, in the usual manner, and also the call bell.

The long distance telephone has been brought to such perfection by these methods, that two persons, 1,000 miles apart, can converse through it as easily as if seated in the same room.

CHAPTER X.

THE RÖNTGEN X-RAYS.

DISCOVERY OF THE RAYS.—One of the most remarkable properties of electricity is the production, under certain conditions, of rays which can penetrate bodies opaque to rays of light, and produce visible effects on specially prepared screens, and permanent pictures on photographic plates and films.

These rays were first discovered about 1891 by Hertz, a German professor, and subsequently investigated by Professor Lenard, of Bonn, and shown to possess the property of penetration to a very limited extent, being capable of passing through very thin sheets of metal and other substances. But their nature, source, and properties were very imperfectly understood by these investigators. This investigation was taken up by Professor Röntgen, of the University of Würzburg, who discovered that the rays could penetrate substances of considerable thickness, and produce the photographic and other effects referred to above. The visible effect on a screen was discovered accidentally November 8, 1895, and a full account of his discoveries was published about January 1, 1896. The term *X-rays* was chosen by him merely for its brevity, and without any special significance.

GENERATING APPARATUS.—To produce these rays, a Crookes vacuum tube similar to those described on page

42 is employed, the construction of which is shown in Fig. 101. Two platinum wires, sealed into the glass in the usual manner, constitute the electrodes, by which a

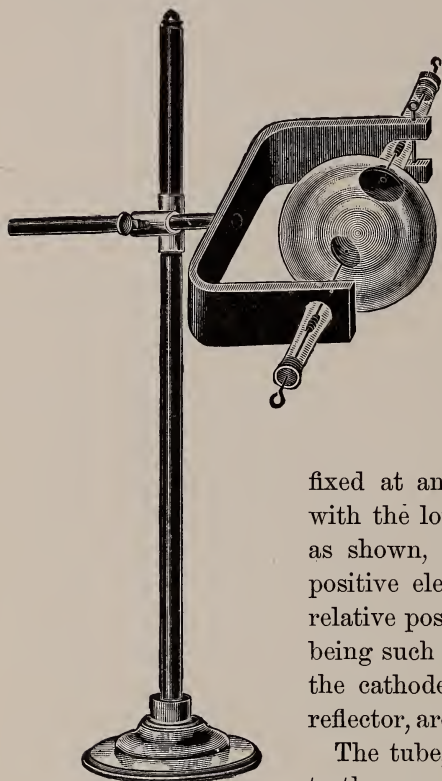

Fig. 101.

current of electricity may be transmitted through the tube. To the inner end of the wire on the right is attached a concave, aluminum disk, which is employed as the negative electrode, or *cathode*; and to the inner end of the other wire is attached a small, flat, platinum disk,

fixed at an angle of 45 degrees with the longer axis of the tube, as shown, and employed as the positive electrode, or *anode*; the relative positions of the two disks being such that rays collected by the cathode, acting as a concave reflector, are focused on the anode.

The tube, or bulb, is exhausted to the usual high degree of vacuum mentioned on page 42; the

best vacuum for this special purpose being carefully determined by experiment, and depending, to a certain extent, on the nature of the other generating apparatus employed. As the electric resistance of this high vacuum may exceed that of the glass, and the electric current,

taking the path of least resistance, pass round through the glass, avoiding the inner terminals of the electrodes, the resistance of the platinum wires is made equal to that of the vacuum by extending them, as shown, in terminal tubes closed at both ends, which makes direct transmission through the vacuum more certain.

The tube is mounted on a stand by an adjustable clamp, to which it is attached by the terminal tubes, so that it can be set at any required angle, and is connected by its electrodes with the poles of an induction coil, capable of producing a spark four or more inches in length, and operated by a current from a battery or other generator. A primary battery of at least four strong cells, like the Edison-Lalande, may be employed, or a direct dynamo current, but a storage battery current is usually preferred.

The current being transmitted from the anode to the cathode produces rays of light from each, the cathode rays being focused, as already stated, on the anode disk; and here the X-rays, which are invisible, are generated, and projected at right angles to the axis of the tube, from the slanting disk, as a focal source, through the glass on any object placed within their influence.

There is also a tube made with two platinum plates at the center, slanting in opposite directions, like the letter V, and two concave aluminum reflectors at the opposite ends. It was designed originally for use with the alternating current, the aluminum reflectors being made the electrodes, each acting alternately as anode or cathode; the platinum plates being insulated, and the X-rays generated alternately on each of them as the polarity is reversed.

This tube may also be used with the direct current by

making the platinum plates the anodes and the others the cathodes, dividing the current between them. A small tube connected with the main tube contains a chemical mixture from which, when the vacuum is too high for electric transmission, a gas is generated by heating with a lamp, which enters the main tube and reduces the vacuum.

Induction coils have been fully described on pages 108-12, and one with the spring vibrator shown there

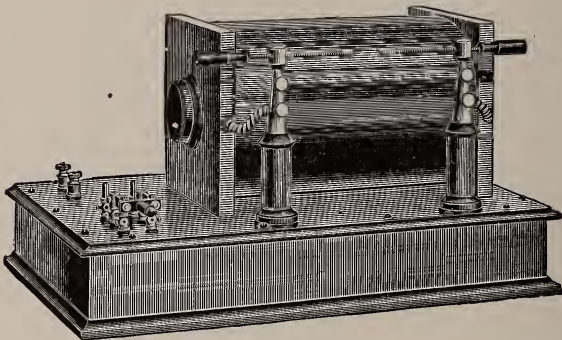

Fig. 102.

may be employed for the X-rays; but Fig. 102 shows a large Ruhmkorff coil designed especially for this purpose. Its primary coil is connected with a tinfoil condenser, placed in its base, as in all Ruhmkorff coils. At its side are shown two binding-posts, connected by set-screws with the terminals of the secondary coil, and having also set-screws for connecting it with the vacuum tube, and adjustable electrodes above, to show the spark-length. At the farther left-hand corner are shown two binding-posts for connecting the primary coil with the battery, and at the near corner a double-bladed reversing switch,

by which the direction of the current through the coil may be reversed when required.

As there is always sparking at the contacts of a spring vibrator, or any current interrupter operating in the air,

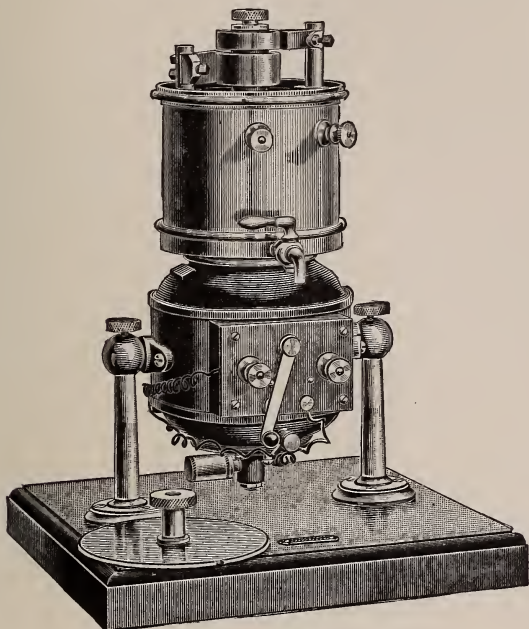

Fig. 103.

which wastes the electric energy, a special interrupter is used in connection with this coil, the construction of which is shown in Figs. 103 and 104.

It consists of a pair of wheels, placed one above the other and rotated horizontally in a tank of mineral oil, shown above, by a small electric motor, shown below, which is run by the current that operates the coil; the upper wheel being notched. The terminals of the electric

circuit leading to the coil and tube are connected with two copper springs, acting as electric brushes, which press against the wheels, as shown in Fig. 103, the upper brush having a platinum tip, and the current is inter-

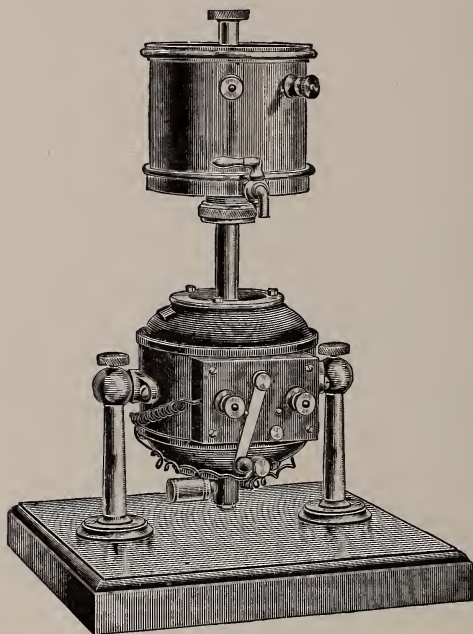

Fig. 104.

rupted at each revolution, as this brush breaks contact with the upper wheel at the notch.

When the tank is elevated to its proper position, as shown in Fig. 104, this interruption takes place in the oil, which is a good insulator, and the contacts being immersed in the liquid, the spark is suppressed, and the full electric energy goes to the tube, less the small percentage required to operate the motor.

As the electric strain on the insulation of a coil is very great, and liable to produce rupture, resulting in a short circuit within the coil, coils in constant use for this purpose are sometimes kept immersed in mineral oil, which greatly improves the ordinary insulation, especially at weak or defective points which may have escaped notice.

The static induced current of an influence machine, described on page 35, may be employed in producing these rays, the electric energy being supplied by the machine, but the current from an induction coil is generally preferred.

COMPARATIVE PERMEABILITY OF DIFFERENT SUBSTANCES.—These rays are transmissible through all substances, solid, liquid, and gaseous, but with different degrees of facility, dependent mainly on the comparative density of the substance, and on its thickness; dense metals, like platinum, lead, and gold, tending to arrest and absorb them; while light metals, like aluminum and tin, transmit them; thin sheet aluminum being nearly transparent to them, while sheet platinum of the same thickness is nearly opaque, their absorption by the platinum disk of the tube making it red hot in a few seconds.

In like manner, but in less degree, bone tends to arrest the rays, while the other animal tissues tend to transmit them. Glass, which is transparent to rays of light, is nearly opaque to the X-rays; while wood, which is nearly opaque to light, is, to an equal degree, transparent to these rays; and hard rubber, which is entirely opaque to light, even in thin sheets, is transparent to them in sheets of considerable thickness.

FLUORESCENCE.—Certain substances become *fluorescent* when exposed to these rays, emitting light visible in a dark room. This is true of glass, and also of various

chemical salts and other substances, prominent among which are *barium platinocyanide*, *calcium tungstate*, calcium sulphide, rock-salt, Iceland spar, and uranium glass.

FLUORESCENT SCREEN. — Apparatus constructed in accordance with these principles is employed to produce visible effects with these rays. Röntgen employs for this purpose a paper screen coated on one side with barium platinocyanide. Putting the tube in action in a dark room, and wrapping it in black paper, which completely confines the light produced within it, the screen, when brought into its vicinity, lights up with a brilliant fluorescence which varies in proportion to the distance from the tube, remaining visible at a distance of more than six feet.

If the hand be placed on the side of the screen next the tube, its shadow will be seen on the reverse side; the flesh casting a faint shadow, and the bones a deep shadow, making a skeleton picture of startling vividness.

THE FLUOROSCOPE. — Edison employs a similar screen, coated with calcium tungstate, which, he claims, has six times the fluorescent power of barium platinocyanide, and has constructed an instrument known as a *fluoroscope*, shown in Fig. 105, with a small screen of this kind, which has come into general use, and can be employed to produce these X-ray shadows either in daylight or darkness.

It is a box about seven inches long, made of stiff, black cardboard, with slanting sides, terminating, at the small end, which is open, in a cover designed to fit closely round the observer's eyes, and lined at the edges with some soft material, as plush or fur, to exclude the light. The broad end, which is about 7x9 inches in area, is coated on its inner surface with crystals of calcium tungstate, and constitutes the screen.

This screen when exposed to the X-rays becomes fluorescent, and the shadows of objects placed on its outer surface may be seen by an observer looking in at the small end, showing the peculiar effects hereafter described.

The instrument is provided with a handle by which it can be held to the eyes, and is very convenient for various kinds of observations where a large screen is not required.

SCIAGRAPHS.—Pictures of these shadows can be produced either on photographic glass plates or films, pre-

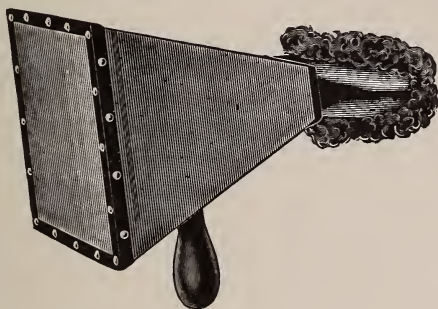

Fig. 105.

pared in the usual manner. Exposure of the plate or film to the light is not permissible for this purpose, as the picture would, in that case, be a true photograph of the object, produced by reflected light, and not of its shadow produced by the intercepted X-rays. Hence it is necessary that the plate should be inclosed, during the operation, in some substance opaque to light but transparent to these rays. This is done most conveniently by using as an inclosing envelop the cardboard case in which the plate is kept previous to its exposure, in which it is wrapped in two thicknesses of paper, one of which is black.

The object being placed on this case, between the tube and the inclosed plate, the projected rays act on the sensitized plate through the envelop, but are absorbed by the different substances composing the object, in proportion mainly to their relative density and thickness, as already mentioned, leaving a permanent negative picture, having light shades where the rays are most absorbed, and dark shades where they are least absorbed. This negative being developed by the usual photographic process, positive pictures are printed from it in which the lights and shades are reversed; giving true shadow pictures, in which the relative penetration of the rays is shown by the relative darkness of the shadows.

The time of exposure varies from a few seconds to half an hour; the tendency, as in ordinary photography, being to shorten the time as improved apparatus and methods are discovered.

These pictures are known as *sciagraphs*, a name derived from two Greek words, *scia*, a shadow, and *grapho*, to write. They have also been called *radiographs*. It is evidently improper to call them photographs, as they are not produced by light, except as it is employed in printing from the negatives.

NATURE OF THE RAYS.—The true nature of these rays is unknown, and no theory has yet been proposed in regard to it which is not more or less open to objection. In addition to their properties of invisibility, penetration, and chemical action, already described, they have another which distinguishes them from all other rays, either of light, heat, or electricity; they cannot be deflected from straight lines of radiation by any known means whatever, as other rays are deflected.

Hence they can neither be refracted nor reflected, and

therefore cannot be focused either by a lens or a mirror, nor made parallel.

The cathode rays generated in a Crookes tube can be deflected from their course by a magnet, but magnetic influence produces no deflection of the X-rays; which seems to mark as a distinct property that which might otherwise be considered a result of their penetration of all substances.

Light, according to a well-known theory, is produced by short waves, or undulations, of the ether, which are transverse to the direction of the ray, extending in all directions across its central axis like the radii of a circle. If a ray of light be transmitted through a crystal of tourmaline, it seems to become flattened by the molecular structure of the crystal, so that the undulations are all made to occur in a plane parallel with a line known as its optical axis. If another similar crystal be placed in a position parallel to this one, the ray which has passed through the first will pass through the second when the optical axes of both crystals are in the same plane, and produce a spot of light on a screen beyond. But if the second be given a quarter turn, so that the planes of the two axes cross, at right angles, the flattened ray can no longer pass through the second crystal, and the spot of light will be extinguished. If now the second crystal be given another quarter turn, bringing the optical axes again into the same plane, the ray of light will pass through as at first, and the spot of light be restored.

This well-known experiment has long been accepted as proof of the transverse, undulatory theory of light, referred to above, the flattening of the ray being known as its *polarization*. Applying this test to the X-rays, it is found that they cannot be polarized, but pass through

the crystals with the same facility when the axes are crossed as when they coincide in position. This, taken in connection with the fact that these rays cannot be deflected, has given rise to the theory that they are produced by ether waves which undulate in the direction in which the ray is projected, and not transversely like the undulations in rays of light.

Another theory is that the undulations are transverse, but much shorter than those which produce light, so that the ray can pass through the crystals without being polarized like the ray of light. Either of these theories, more especially the former, will account for the penetrative power of these rays as compared with rays of light.

PRACTICAL USES OF THE RAYS. — These rays are found to be an invaluable aid in surgery, showing the exact location of bullets, shot, and other foreign substances in the human body without resort to the painful, and often dangerous, operation of probing; and enabling the surgeon to remove them with less cutting and risk.

Internal malformations, cavities, and bony excrescences may also be shown in this way, and the extent and character of fractures, dislocations, and decay of the bones; so that treatment can be given much more intelligently and expeditiously than formerly. In short, the surgeon and physician can now see inside the body, and are not limited, as formerly, to the formation of an opinion from external symptoms, often leading to wrong treatment and a fatal termination. Had this process been known when the lamented President Garfield was shot, the bullet could have been accurately located, and his life probably saved.

Two views, obtained at different angles, may be required to determine the exact location of the foreign substance, or the relative position of the parts in a fracture or dislocation. These views can usually be taken

with sufficient accuracy in a fluoroscope, and much more expeditiously than by a sciagraph, which requires time for the exposure and subsequent chemical development. As an illustration of this, a small revolver bullet was located so accurately by the fluoroscope that the surgeon's needle struck it at the first probing. Both methods have their relative value in different cases, the sciagraph being especially valuable where a permanent record is required.

The employment of the X-rays in medical practice is, as yet, very limited as compared with their employment in surgery; but, in Germany, physicians have succeeded, by means of them, in detecting and locating calcareous deposits in the valves of the heart and in other internal organs; so that they may yet become as valuable in medicine as in surgery. But they have not been employed as a remedial agency by any intelligent physician, and their reported germicidal qualities have been proved to have no foundation in fact; experiments showing that the disease-producing germs, or bacilli, are not affected even when exposed to their direct action without the intervention of any protecting substance, much less destroyed by them when inclosed in the tissues of the body. It has been shown, however, that these rays can produce destructive changes in those tissues; effects similar to sun-burning, resulting in inflammation and blistering, having been caused by repeated exposures of the hand to their action.

X-RAY ILLUSTRATIONS.—The following illustrations, taken from living subjects and material objects, will explain more fully the practical use of these rays in surgery and for other purposes. Each illustrates some special feature of X-ray work, similar illustrations of which might be multiplied to any extent, if space permitted.



Fig. 106.

In Fig. 106 is shown the chest of a man who was shot, the bullet having entered at the front and lodged at the base of the fifth rib, near the spinal column. The time of exposure was fifteen minutes. As lead casts a darker shadow than either bone or flesh, on account of its greater density, it is easily located in all such cases. And as the shadow cast by clothing is very light, only the outer, heavy garments need be removed in taking such scia-graphs, the shadow of the lighter undergarments disappearing entirely in the picture.

Fig. 107 shows a dislocated ankle, taken by an exposure

of thirty minutes. The leg bone is shown projecting forward, at the joint, a considerable distance beyond its true place. In cases of this kind, views of opposite sides

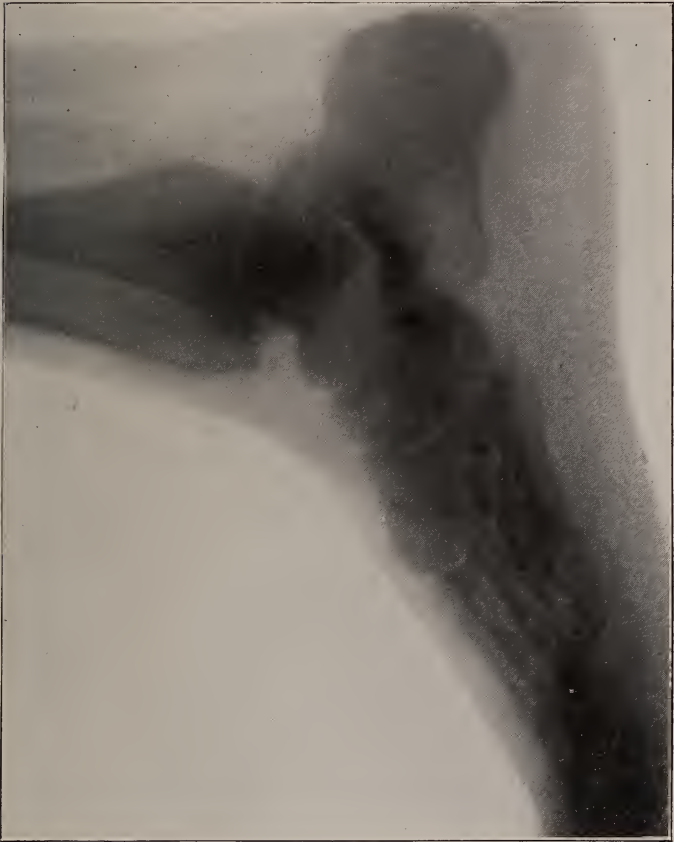

Fig. 107.

of the dislocation may be required to insure sufficient accuracy.



Fig. 108.



Fig. 109.

In Fig. 108 is shown the arm of a man who was accidentally shot while hunting. The surgeon removed all the shot, as he supposed, and the wound healed; but subsequently a few more shot were discovered, which, having become *encysted*,—that is, permanently inclosed in sacs,—were allowed to remain. Twenty-three years afterward, when the X-rays came into use, the man, wishing to know just how many shot were still in his arm, had this sciagraph taken, which shows thirty-four, instead of nine as was supposed.

This shows the special value of the X-rays in such cases, as even the most skilful surgeon can never otherwise be sure that all the shot have been removed. Five minutes was the time of exposure in this case.

Fig. 109 shows a fracture of the arm bone known as the *radius*, just below the wrist joint, on the right, which was taken by ten minutes' exposure.

To an unskilled eye, a fracture is not very clearly defined in a sciagraph; but, in this case, a comparison of the bone at this point, with the same bone as shown in Fig. 108, reveals it distinctly.

In Fig. 110 are shown sciagraphs of two cameos, cut on onyx, taken by an exposure of three minutes. This picture shows the beautiful effects of shading produced by the relative thickness of material, impossible to obtain in a photograph, which shows only the surface; the figures cut in relief showing dark shades in the thicker parts, and shades of varying lightness in the thinner parts, especially those representing the faces and upper parts of the dresses; and all clearly defined above the light, almost transparent, background. Some of the finest and most delicate effects of the original sciagraph are lost in the engraving.

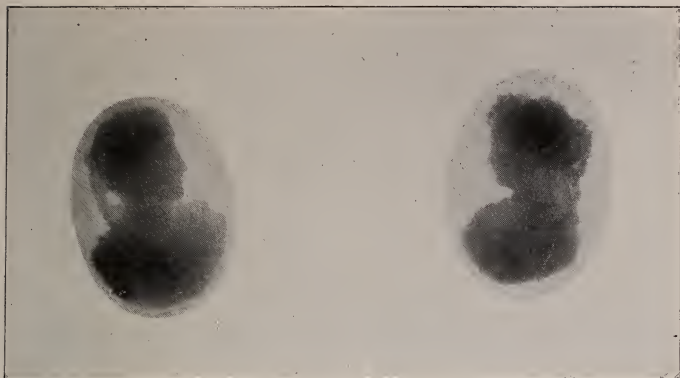

Fig. 110.

It is an important feature of this process that not only prominent objects, as bullets and shot, can be located by it, but also foreign substances so minute as to escape ordinary observation. This is well illustrated by Fig. 111, which shows a lady's hand, taken by fifteen seconds' exposure.

A painful spot indicated the presence of some foreign substance which could not be found; but the sciagraph revealed a minute speck, just below the knuckle of the third finger, on the side next the little finger, as shown, which proved to be a little splinter of glass, the point of which was stuck in the bone.

The delicate shading of this sciagraph is particularly noticeable, showing the folds of the flesh between the thumb and forefinger, and even the faint outlines of the nails, and the sharp bony prominences at their roots.

Fig. 112 is a sciagraph of a man's hand, taken by an exposure of only three seconds, in which the difference in shading brings out all the parts prominently, notwithstand-



Fig. 111.



Fig. 112.

ing the brevity of the exposure; the jewelled ring encircling the finger, and standing out from the bone, is especially noticeable, the dense gold casting an intensely black shadow.

Fig. 113, taken by three minutes' exposure, shows a block of Georgia pine, inch and a half thick, into which



Fig. 113.

six iron screws and two iron staples were driven. It is composed of two pieces, cut across the grain and glued together, the joint being shown in the center. The shading shows with great distinctness the layers of the wood, their relative density, and the greater density of the iron.

Fringes in the shadow are shown at the bottom and left-hand edges, while the upper and right-hand edges are sharply defined. This is due to the different angles in which the radiated rays impinge on the block, striking the lower and left edges at acute angles, and traversing

a comparatively small thickness of wood, and thus producing fringed shadows; and striking the upper and right-hand edges, and especially the upper right-hand corner, at right angles, or nearly so, and hence traversing a greater thickness of wood, and producing a clearer, sharper impression, without fringes.

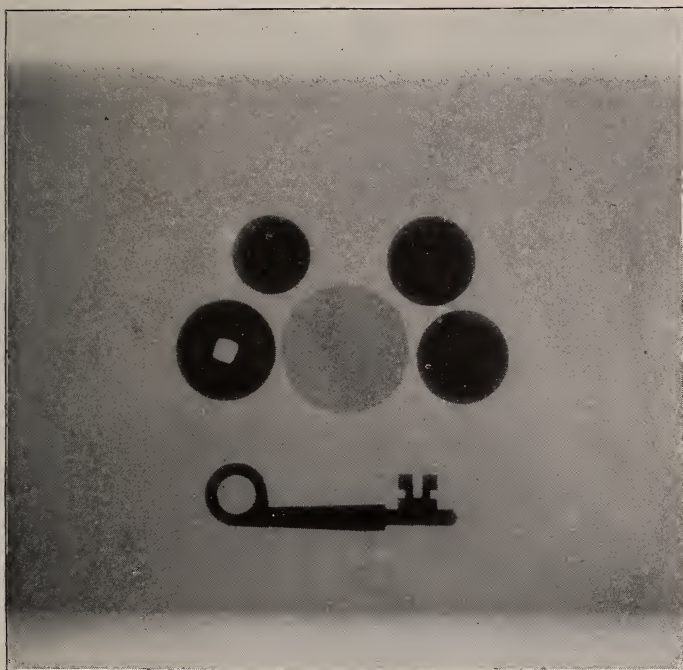

Fig. 114.

The greater thickness of air traversed by the oblique rays than by the direct rays tends to produce the same result; the diffusion of the rays and their absorption by the air being directly proportional to the square of the distance between their source and the object on which

they impinge. The difference in the clearness of impression of the different layers is due to the same causes, and the darker shadows of the screws and staple on the right as compared with those on the left.

Fig. 114 shows a picture of coins and a key, taken through a book of 656 pages, by an exposure of five and a half minutes; the book having been laid on the case containing the sensitized plate, and the articles on its bottom cover inside, the rays being projected on it from above.

In the center is shown an aluminum medal, and on the right of this a copper, five-centime, French coin, and above it a silver quarter dollar. On the left is shown a Chinese brass coin having a square hole in its center, and above this a nickel five-cent coin. Below the coins is shown a steel key, above which was placed a rubber band, quarter of an inch wide, which has nearly disappeared in the picture, showing that India rubber is practically transparent to these rays. The aluminum medal gives a faint shadow, showing its relative transparency as compared with the copper, brass, nickel, silver, and steel, all of which give dark shadows, showing little or no difference.

These rays may be employed to distinguish real gems, especially diamonds, from their cheap imitations; the diamond being nearly transparent to the rays, while its imitation in glass is nearly opaque.

This is well illustrated by Fig. 115, which represents a sciagraph taken with a small tube by an exposure of fifteen minutes. Real diamonds of various kinds cast the light shadows, numbered 13, 14, 15, and 16, while the imitation, number 19, casts a dark shadow. It is also noticeable that the black diamond, number 20, which is a dull,



Fig. 115.

lusterless substance, perfectly opaque to rays of light, is as transparent to the X-rays as the brilliants, while the diamond bortz, number 6, which is an imperfect brilliant, is much less transparent than either, but more so than the imitation, number 19.

The garnets, 11 and 12, cast darker shadows than the imitation garnet, number 2; and the turquoise and pearl, 4 and 5, much darker shadows than the opal 3, sapphire 7, chrysolite 8, emerald 9, and ruby 10. The rough tourmaline, number 17, casts a darker shadow than the polished tourmaline, number 18, but this may be due merely to the difference in size. The darker shadow cast by the imitation amethyst, number 1, as compared with the imitation diamond, may also be due to the same cause, most of these imitations being made of glass, either solid, or pulverized and made into a paste; and glass, as we have seen, always casts a dark shadow.

CHAPTER XI.

WIRELESS TELEGRAPHY.

INVENTION OF THE WIRELESS TELEGRAPH.—In the latter part of 1896 announcement was made of the invention of a new system of telegraphy, by a young Italian, Sig. Gulielmo Marconi, in which the transmission was accomplished through the ether of space, without the use of connecting wires or cables. Many experimenters before Marconi had been attempting to transmit messages without wires, and some had succeeded in a limited way over short distances. Marconi was, however, the first to produce a system whereby wireless messages could be transmitted over considerable distances. As the elimination of wires and cables would mean a large saving in cost, and as there were also many places where neither wires nor cables could be maintained, but where it was desirable to establish communication, this new method gave immediate promise of becoming an important commercial system.

THE MARCONI SENDING APPARATUS.—The essential elements of the early Marconi sending station are shown diagrammatically in Fig. 116. In this diagram I is an ordinary induction coil with vibrator, the primary of which is connected in series with a battery and the telegraph key K. The secondary terminals of the induction coil are connected to two brass spheres mounted upon insulating stands and forming the spark gap S. One sphere is also

connected to the ground at G. The second sphere is also connected to a wire, A, which projects vertically into the air and is called the *antenna*. The operation of sending

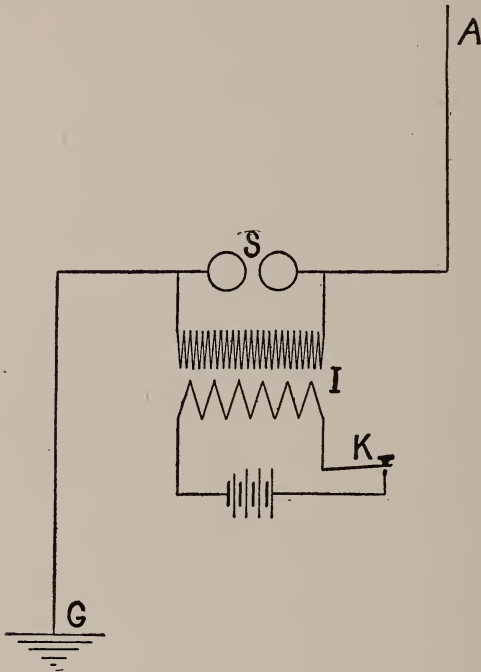

Fig. 116.

is as follows: When the key K is pressed, the primary circuit of the induction coil is closed and sparks will jump across the spark gap between the two spheres. This will cause electric waves to be radiated out from the antenna into space in all directions, very much as light waves are radiated from a source of light. The higher this antenna, the greater the distance over which these waves will be propagated. These waves will continue to

be sent out from the antenna so long as the key K is kept closed. If the key is closed for a short period, a short succession of electric waves will be sent out, while if the key is kept closed for a longer time a correspondingly longer succession of electric waves will be sent out. If the key is operated to send dots and dashes as in the ordinary Morse telegraph system corresponding short and long series of electric waves will be radiated into space.

THE COHERER.—At the receiving station means must be provided for detecting and indicating the presence of these electric waves. A sensitive detecting device was the principal element in the invention of the Marconi system of wireless telegraphy. The original form of this detecting device is the *coherer*. This consists of a glass tube about $\frac{1}{8}$ inch in inside diameter, and two or three inches long, containing near the centre two short silver cylinders fitting tightly into the tube and separated from each other by about $\frac{1}{16}$ inch. The space between the cylinders is about half filled with metallic filings, preferably of nickel and silver. The tube may be left open, but for best results should be sealed and exhausted of air. In the latter case the two cylinders are connected to outside terminals by platinum wires passing through the glass.

When these filings lie loosely between the metal cylinders, they offer a resistance of many thousand ohms to the passage of a current of electricity of low voltage, such as is obtained from a few cells of battery. If, however, electric waves pass through the coherer, this resistance immediately falls to a few ohms, through which a current of electricity can pass readily. The filings will remain in this low resistance condition even after the electric waves cease to pass through them. If, however, the tube is tapped so as to shake the filings, they will

immediately return to their former state of high resistance.

One explanation for this cohering action is, that the high resistance is due to contact resistance between the filings caused by thin films of vapor surrounding each filing, and that the electric waves cause minute sparks to leap across from filing to filing and thus break down this contact resistance by breaking through the thin films. When the filings are shaken they assume new points of contact, and the high resistance is, therefore, again established between them.

THE MARCONI RECEIVING APPARATUS.—The essential elements of the early Marconi wireless receiving station are shown diagrammatically in Fig. 117. In this diagram the coherer is shown at C, the two metallic cylinders being marked P. One of these cylinders is connected to the ground at G, and the other is connected to an antenna similar to the antenna used at the sending station. The metal cylinders of the coherer are also connected to a local circuit containing a battery and a telegraph relay, R. In the secondary circuit of this relay is connected a battery, and a telegraph sounder, S, or a recording telegraph instrument, and an electromagnetic vibrating device, T, similar to an electric bell, called a *tapper*, which in its vibration strikes against the coherer tube. The operation of the receiving apparatus is as follows:

The primary circuit of the relay R is ordinarily interrupted by the high resistance of the coherer filings. When electric waves strike the antenna, they pass down through the coherer to the ground, and in so doing break down the resistance of the coherer, thereby closing the circuit of the relay, which in turn closes the local circuit which operates the sounder S and the tapper T. As soon

as the tapper strikes the coherer the filings *decohere*, breaking the relay circuit and, therefore, also, the sounder circuit, and if the waves have ceased by this time, these circuits will remain open. If, however, the waves are still striking the antenna, all the circuits will again be

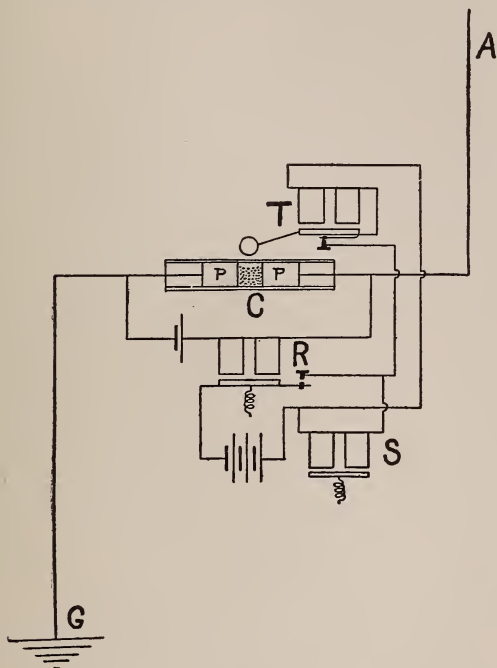

Fig. 117.

closed. It is thus seen that so long as electric waves reach the antenna, the relay, sounder and tapper will vibrate continuously. If now dots and dashes are sent from the sending station, these will be received as short and long series of vibrations of the sounder.

SELF-RESTORING DETECTORS.—A great drawback to

the use of the coherer with metal filings is the fact that the conductivity continues after the waves have ceased, so that a mechanical decoherer, such as a tapper, must be used to restore the coherer to its high resistance condition after each wave has passed. This not only involves mechanical difficulties, but also limits the speed with which signals can be received.

To overcome this difficulty, a large number of self-restoring detecting devices has been developed. Some of these depend also upon contact resistance, but most of them depend upon the thermal, magnetic or electrolytic effects of the electric current. One of these is a self-restoring coherer, which has been successfully used in the Italian navy, and consists of a glass tube, similar to that used in a filings coherer, with two plugs of iron or carbon, placed a short space apart, and having a globule of mercury between them. Conduction through this coherer exists only as long as the electric waves are passing through, and ceases the instant the waves cease. This coherer is, therefore, self-restoring, and requires no tapper.

A form of electrolytic detector which is very largely used at present consists of an extremely fine platinum wire, of which one end is made to barely touch the surface of a small quantity of dilute acid. This fine platinum wire, measuring about .0001 inch in diameter, is made by casting a thin rod of silver with a platinum wire as a centre core, and then drawing this down to a wire a few thousands of an inch in diameter. The silver is now dissolved away at one end, leaving the platinum wire exposed. In this detector there is ordinarily contact between the platinum wire and the dilute acid; when the electric waves pass through this contact is interrupted by the rapid evolution of gas produced.

THE TELEPHONE AS A RECEIVING INSTRUMENT.—The self-restoring detectors are often used with a telephone and a battery, in the local circuit shunting the detector, in place of the relay and sounder. This gives a far more sensitive arrangement, and can be used to detect much weaker waves than when telegraph instruments are used. The telephone is for this reason always used to receive messages transmitted over great distances.

INTERFERENCE OF MESSAGES.—The electric waves radiated out from the antenna of a sending station spread out in all directions, and every receiving station within their range would respond to the signals. For use on shipboard, or between ships and the shore, this is an important advantage, because it enables any ship to communicate with any other ship or with any shore station within the range of its wireless apparatus. Besides, where ships are scattered on the seas, the probabilities of interference are small. Where telephones are used to receive the messages, it has, however, been found that a trained operator can select and read any one of several messages coming at the same time, because the signals from any one transmitter produce a characteristic tone in the telephone, due to the peculiarities of the particular transmitter. This is on the same principle by which it is possible to carry on a number of conversations between different persons in the same room.

TUNED OR SYNTONIC SIGNALLING.—In order to avoid the interference of messages, methods have been developed whereby a station can communicate with any one of several stations, without being affected by messages passing from or to neighboring stations at the same time. This has been accomplished by tuning the oscillations of the sending and receiving stations, so that a receiving

station will respond to the signals from a sending station to which it has been tuned, but will not respond to signals from other stations. This is analogous to a tuning fork, which will respond to and be set into vibration by sound waves of its own particular frequency, but will not respond to waves of any other frequency. This is done by combining with the sending and receiving apparatus, properly adjusted combinations of inductance and capacity, so that the sending station sends out waves of only one frequency, and the receiving station responds to waves of this frequency but is unaffected by waves of other frequencies. Sending apparatus which is not provided with an adjusted combination of inductance and capacity, such as the simple apparatus shown in Fig. 116, will send out waves having a wide range of frequencies; similarly receiving apparatus without this inductance and capacity will respond to any waves within a wide range of frequencies. Two or more stations which will send out and respond to waves of only one frequency, are said to be tuned to each other.

APPARATUS FOR LONG DISTANCE TRANSMISSION.—The distance over which wireless messages can be transmitted depends upon the strength of the electric waves radiated from the antenna, upon the height and construction of the antenna, and upon the sensitiveness of the receiving apparatus. Atmospheric conditions also affect the transmission. Under similar conditions, the signals transmitted between two stations are generally also much stronger at night than in daylight.

For long distance transmission, the induction coil and battery are usually replaced by an alternating current dynamo and a high potential transformer, giving 25,000 or more volts. Instead of a single wire, a combination

of wires is also used in multiple for the antenna to get the strongest effect. These have been variously arranged as elements of a cylinder, of an inverted cone, in the form of a fan, a grid, etc. In the transatlantic experiments made by Marconi, the antenna consisted of four high iron towers, with heavy wires stretched across their tops, and having a large number of wires radiating from these connecting wires down to a common vertex on the roof of the station containing the wireless apparatus.

APPLICATION OF WIRELESS TELEGRAPHY.—When Marconi's invention was first announced, many people predicted that this new system would soon replace the wire and cable systems. Ten years have elapsed since this first announcement and the present time of writing, and the wireless system has become an established commercial business. It has not, however, displaced the older systems, but has rather found a field of application of its own. The large ships of commerce, as well as those of the important navies, have already been equipped with wireless apparatus, and a large number of shore stations have also been established, so that these ships now regularly communicate with each other and also with the shore. Many light-ships have also been placed in communication with the shore by wireless telegraphy, where previously a cable could only be maintained with great difficulty and uncertainty. The interior of snow-bound Alaska has also recently been placed in communication with the outer world by means of the wireless telegraph. Transatlantic wireless transmission has also been demonstrated as a possibility by the actual transmission of messages between England and America.

While wireless telegraphy may thus be said to have passed the experimental stage, the army of investigators

who are studying the problems involved will doubtless accomplish much in the future to improve present methods.

INDEX.

INDEX.

A

	PAGE
Accumulator	79
Accumulator, chloride, the.....	85
Action, local	69
Advantages of electric heating.....	185
Agonic line.....	96
Alphabet, cable	215
“ , Morse	196
Alternating current	107, 108
“ “ dynamo	133
“ “ “ , exciter for	134
“ “ motors	150
Amalgamation of the zinc	68
American storage battery cell.....	83
Ammeter	18
Ampere	18, 19
Ampère's theory of magnetism.....	105
Anion	92
Anode.....	90
Apparatus, generating.....	227
Atkinson Töpler-Holtz machine.....	28
“ “ “ four-plate machine	33
Arc	168
Arc lighting	165, 172
Armature, dynamo	116
“ construction	125
“ , drum, cylinder, or Siemens'	126
“ , iron-clad, or Pacinotti	128, 134
“ , keeper or	98
“ , ring, or Gramme	126
Arresters, lightning.....	161
Attraction and repulsion, electric	20, 21
“ “ “ , magnetic	100
Aurora.....	51
“ australis	51
“ borealis	51
“ , cause of the	53
“ polaris	51
Automatic telegraph transmission	209
“ “ transmitters	210, 215

	PAGE
Batteries, electric	57-92
" , storage	79
Battery cell	57
" , Daniell	71
" , Disque Leclanché	65
" , Edison-Lalande	69
" , Grenet	67
" , Law	61
" , prism, or pile, Leclanché	65
" , Samson	63
" , Smee	60
cells, Bunsen and Grove	74
" , comparison between large and small	78
" , dry	70
" , gravity	72
" , Leclanché	64
" , one-fluid	59
" , potassium bichromate	66
" , two-fluid	59, 70
" , voltaic	58
" , zinc-carbon	61
connection	74
" , parallel	76
" , series	75
, Leyden	25
poles	58
, primary	57
, secondary	79
, storage	79
, voltaic	57
Bell telephone receiver	220
Bells, electric	112
Bipolar dynamo	130
Blake telephone transmitter	220
Break and make	110
Brush discharge	36
Brushes and commutator, construction of	129
" for dynamos	115
" influence machines	29
Bunsen and Grove battery cells	74
Bus, neutral	179
Bus-bars	177

C

Cable alphabet	215
Calibrated	17
Carpenter heater	185
Carriers	29
Cataphoresis	91
Cathode	90
Cation	92
Cause of the aurora	53
Cautery, electric	92
Cell, battery	57

	PAGE
Chain lightning	47
Charge, static, in ocean telegraph cable	216
Chloride accumulator, the	85
Circuit, closed	10, 66
" , electric	7
" , magnetic	95
" , open	10, 66
" , short	108
" , shunt	121
Closed circuit	10, 66
Coil, primary	108
" , secondary	109
Coils, induction	108
Combs in static machines	22, 23
Commutator	116
" segments	118
Comparative permeability of different substances	233
Comparison between large and small battery cells	78
Compound wound dynamo	123
Condenser,	154, 206
" , operation of	217
Conducting electrode	58
Conductivity	6
Conductor, prime	22
Conductors	6
Connection, battery	74
Consequent poles	99
Conservation of energy	2
Constant current and constant potential	124
" " dynamo	125
" potential dynamo	125
Construction, armature	125
" of armature brushes and commutator	129
" " telephone circuit	223
Controller	158
Cooking, electric	186
Core, magnet	103
Counter electric pressure	141
Crater in arc lamp carbon	168
Crookes vacuum tubes	42
Cross-talk telephone	223
Current, alternating	107, 108
" and circuit, electric	7
" , direct	116
" , electric	7
" , faradic	112
" , static induced	35
" volume	8
Cut-out in arc lamp	171
" and lightning arrester	200

D

Daniell battery cell	71
Declination of the magnetic needle	96
Deflection of magnetic needle by electric current	100
Dewey heater	182

	PAGE
Diaphragm, telephone.....	220
Dielectrics.....	12
Difference between telephonic and telegraphic transmission.....	223
Dip or inclination of the magnetic needle.....	96
Direct current.....	116
“ “ dynamos.....	117
Direction of rotation in influence machines.....	37
Discharge, brush.....	36
“ , spark.....	32
Discharger.....	26
Discoveries, Tesla's.....	181
Discovery of the X-rays.....	227
Disque Leclanché cell.....	65
Distribution, alternating current.....	181
Distribution of power, electric.....	142
Double carbon lamp.....	170
“ reduction motors.....	156
Drum, cylinder, or Siemens' armature.....	126
Dry cells.....	70
Duplex telegraph transmission.....	203
“ transmitter.....	206
Dynamo armature.....	116
“ , bipolar.....	130
“ brushes.....	115
“ “ , lead of.....	121
“ , compound wound.....	123
“ , constant current.....	125
“ , “ potential.....	125
“ , evolution of the.....	114
“ , series wound.....	121
“ , shunt wound.....	121
Dynamos.....	114-139, 116
“ , alternating current.....	133
“ and motors, relative size of.....	142
“ , direct current.....	117
“ , multipolar.....	131

E

Earth's magnetic poles.....	93
“ magnetism.....	95
Edison-Lalande battery cell.....	69
Edison storage cell.....	88
Effect of breaking a magnet.....	99
Electric retraction and repulsion.....	20, 21
Electric batteries.....	57-92
“ bells.....	112
“ cautery.....	92
“ circuit.....	7
“ “ , opening and closing.....	9
“ cooking.....	186
“ current.....	7
“ “ and circuit.....	7
“ “ , deflection of magnetic needle by.....	100
“ distribution of power.....	142
“ “ , natural.....	13
“ “ , three-wire system of.....	180
“ energy.....	5

	PAGE
Electric generator, frictional	21
“ heating	182
“ “ , advantages of	185
“ induction	10
“ ironing	189
“ lighting	165-181
“ lighting, arc	165
“ “ , incandescent	172
“ motors	140-164
“ or magnetic storms	53
“ potential	7
“ power station, Niagara Falls	144
“ pressure	7
“ “ and current volume, measurement of	15
“ “ “ rate of discharge in storage batteries	88
“ “ , counter	141
“ railways	158
“ resistance	6
“ “ , heat and light by	165
“ transmission	6
“ “ , loss of power in	146
“ “ , nature of electricity and	1-19
“ units	18
“ welding	189
“ wind or souffle	42
Electricity and electric transmission, nature of	1-19
“ generated by heat	191
“ , heat and	182-192
“ , magnetism generating	107
“ , nature of	1
“ , static	20-56
Electrode, conducting	58
“ , generating	58
Electrodes	58
Electrolysis	89
“ in medical practice	91
Electromagnetism	100
Electromagnets	102
Electrometer	35
Electromotive force	7
Electron	20
Elementary principles of batteries	57
“ “ “ magnetism	93
“ “ “ static electricity	20
Energy	2
“ , conservation of	2
“ , electric	5
“ , mass	3
“ , molecular	3
Equator, magnetic	96
Ether	4
Evolution of the dynamo	114
Exciter for alternating current dynamos	134

F

Faradic current ..	112
Faure storage battery cell	81

	PAGE
Feeder wires.....	160
Field, magnetic.....	15, 118
Field-magnet.....	118
Flaming.....	172
Fluorescence.....	233
Fluorescent screen.....	234
Fluoroscope, the.....	234
Force, electromotive.....	7
“ , portative.....	98
Four-plate machine, Atkinson Töpler-Holtz.....	33
Frictional electric generator.....	21
“ “ “ , rubbers in.....	21
Fuses.....	179

G

Galvanometer, reflecting.....	211
Gearless motors.....	157
Geissler vacuum tubes.....	42
Generating apparatus.....	227
“ electrode.....	58
Gravity battery cells.....	72
Grenet battery cell.....	67
Grove battery cells, Bunsen and.....	74

H

Heat and electricity.....	182-192
“ “ light by electric resistance.....	165
“ , electricity generated by.....	191
“ lightning.....	47
Heater, Carpenter.....	185
“ , Dewey.....	182
Heating, advantages of electric.....	185
“ , electric.....	182

I

Illustrations, X-ray.....	239
Incandescent lamps.....	173
Indicators, potential.....	18
Induced current, static.....	35
Induction coils.....	108
“ , electric.....	10
“ , magnetic.....	94, 95
Inductors.....	29
Influence machine, Atkinson Töpler-Holtz.....	28
“ “ , Wimshurst.....	38
“ machines.....	27
“ “ , brushes for.....	29
“ “ , uses of.....	41
Insulation.....	6
Insulators.....	6
Intensity, magnetic.....	97
Ironclad or Pacinotti armature.....	128, 134
Ironing, electric.....	189

J

	PAGE
Jar, Leyden	24

K

Keeper or armature.....	98
Key, telegraph	194

L

Lamp, double carbon	170
Law, Ohm's.....	9
Law cell	61
Lead of dynamo brushes.....	121
Leclanché battery cells	64
Leyden battery	25
" jar	24
" " , residual charge in	26
Lighting, arc	105
" , electric.....	165-181
" , arc lamps.....	172
Lightning.....	44
" arrester, cut-out and.....	200
" arresters.....	161
" , chain.....	47
" , heat.....	47
" , return stroke	46
" , sheet	47
Lightning-rods	49
Line, agonic	96
" , neutral.....	119
Lines of force, magnetic	94
Local action	69
Lodestone	93
Long distance telephone.....	224
Loss of power in electric transmission	146

M

Machine, Atkinson Töpler-Holtz	28
" " " " four-plate.....	33
" , Wimshurt.....	28
Machines, influence	27
Magnet core	103
" , effect of breaking a	99
" stone.....	93
Magnetic attraction and repulsion	100
" circuit	95
" equator	96
" field.....	15, 118
" induction	94, 95
" intensity	97
" lines of force.....	94
" needle, declination of the	96
" " , dip, or inclination of the.....	96
" shield	110

	PAGE
Magnetism	93-113
“ , Ampère's theory of	105
“ , earth's	95
“ , elementary principles of	93
“ generating electricity	107
“ residual	115
Magnets, steel.	97
Make and break	110
Mass energy	3
Measurement of electric pressure and current volume.	15
Medical practice, electrolysis in	91
Mercury vapor lamp	177
Molecular energy	3
“ motion	5
Morse alphabet	196
Motion, molecular.	5
Motor construction, principles of	140
Motors, alternating current	150
“ , double reduction	156
“ , electric	140-164
“ , gearless	157
“ , railway	155
“ , single phase	153
“ , “ reduction	156
“ , stationary	147
“ , two phase	153
Multipolar dynamos	131

N

Natural electric distribution	13
Nature of electricity	1
“ “ “ and electric transmission	1-19
“ “ the X-rays	236
Negative	7
“ battery pole	58
Neutral bus	181
“ line	119
“ relay, telegraph	203
“ “ , transmission by the	203
Niagara Falls electric power station	144
Nonconductors	6

O

Ohm	19
Ohm's law	9
One-fluid battery cells	59
Open circuit	10, 56
Opening and closing electric circuit	9
Operation of condenser	217

P

Parallel connection of battery cells	76
“ system of electric distribution	178
Pastilles	86

Perforator	209
Permeability of different substances, comparative	233
Planté storage battery cell	80
Plate, revolving, in Atkinson Töpler-Holtz machine.....	28
“ , stationary “ “ “ “ “	28
Polarity	93
Polarization	59
Polarized relay	203, 207
Pole, negative battery	58
Pole, positive battery	58
Pole-changer	208
Pole-pieces	15, 117
Poles, battery	58
“ , consequent	99
“ , earth's magnetic	93
Positive	7
“ battery pole.....	58
Portative force	98
Potassium bichromate battery cells.....	66
Potential, constant current and constant.....	124
“ , electric	7
“ indicators	14
Practical uses of the X-rays	238
Pressure, counter electric	141
“ , electric	7
“ , coil	108
Prime conductor	21
Principles of batteries, elementary	57
“ “ magnetism, elementary	93
“ “ motor construction.....	140
“ “ static electricity, elementary	20
Prism, or pile, Leclanché battery cell.....	65
Push-button	10

Q

Quadruplex transmission.....	208
------------------------------	-----

R

Railway motors	155
Railways, electric.....	158
Receiver, Bell telephone.....	220
“ , telautograph	217
Recorder, siphon	212
Recording watt-meter	162
Reflecting galvanometer	211
Register	197, 210
Relative size of dynamos and motors	142
Relay, telegraph	198
“ , neutral, telegraph	203
“ , polarized, telegraph.....	203, 207
Repeaters, telegraph.....	202
Report in electric discharge	37
Residual charge in Leyden jar.....	26
“ magnetism.....	115
Resistance, electric	6

	PAGE
Return stroke, lightning	46
Reversal of rotation in motors	149
Revolving plate in Atkinson Töpler-Holtz machine	28
Rheostats	147
Ring or Gramme armature	129
Röntgen X-rays, the	227-252
Rotation in influence machines, direction of	37
" " motors, reversal of	149
Rubbers in frictional electric generator	21
Running cars by storage batteries	161

S

Samson battery cell	63
Sciagraphs	235
Screen, fluorescent	234
Secondary battery	58, 79
" coil	109
Segments, commutator	118
Self-induction	111
Series connection of battery cells	75
" wound dynamo	121
Sheet lightning	47
Shield, magnetic	110
Short circuit	108
Shunt circuit	121
" wound dynamo	121
Simple telegraph equipment	193
Single phase motors	153, 164
" reduction motors	156
Siphon recorder	212
Smee battery cell	60
Solenoids	104
Solid back telephone transmitter	225
Sounder, telegraph	195
Spark discharge	32
Static charge in ocean telegraph cable	216
" electricity	20-56
" induced current	35
Stationary motors	147
" plate in Atkinson Töpler-Holtz machine	28
Steel magnets	97
Stone, magnet	93
Storage battery	58, 79
" " cell, American	83
" " " , chloride accumulator, the	85
" " " , Faure	81
" " " , Planté	80
" batteries	79
" " , running cars by	161
Storms, electric or magnetic	53
Submarine telegraph transmission	211
Switch	9

T

Telautograph	217
" receiver	217

	PAGE
Telautograph transmitter	217
Telegraph and telephone	193-226
" equipment, simple	193
" key	194
" relay	198
" " , neutral	203
" " , polarized	207
" repeaters	202
" sounder	195
" transmission, automatic	209
" " by neutral relay	303
" " " polarized relay	208
" " , duplex	203
" " , quadruplex	208
" " , submarine	211
" transmitter, duplex	206
" transmitters, automatic	210, 215
Telephone	219
" circuit, construction of	223
" cross-talk	223
" diaphragm	220
" , long distance	224
" receiver, Bell	220
" transmitter, Blake	220
" " , solid back	225
Telephonic and telegraphic transmission, difference between	223
Thermopile	191
Three-wire system of electric distribution	180
Thunder	48
Töpler-Holtz machine, Atkinson	28
" " " , " four-plate	33
Transformers	236
Transmission, electric	6
Trolley	159
Two-fluid battery cells	59, 70
Two phase motors	153
Tubes, Crookes vacuum	42
" , Geissler vacuum	42
" , vacuum	42

U

Units, electric	18
Uses of influence machines	41

V

Vacuum tubes	42
Vibrator	110
Volt	17, 19
Voltaic battery	57
Voltmeter	15
Volume of current	8

W

Watt	163
Watt-hours	163

	PAGE
Watt-meter, recording	162
Welder	190
Welding, electric	189
Wimshurst machine.....	38
Wind or souffle, electric.....	42
Wires, feeder	160
Wireless telegraphy.....	253-262
" " , apparatus for long distance transmission.....	260
" " , application of	261
" " , interference of messages	259
" " , invention of	253
" " , Marconi receiving apparatus.....	256
" " , Marconi sending apparatus.....	253
" " , self-restoring detectors.....	257
" " , the coherer.....	255
" " , the telephone with.....	259
" " , tuned or syntonie signalling.....	259

X

X-ray illustrations	239
X-rays, discovery of the	227
" , nature of the.....	236
" , practical uses of the	238
" , the Röntgen.....	227-252

Z

Zinc, amalgamation of the.....	68
Zinc-carbon battery cells	61

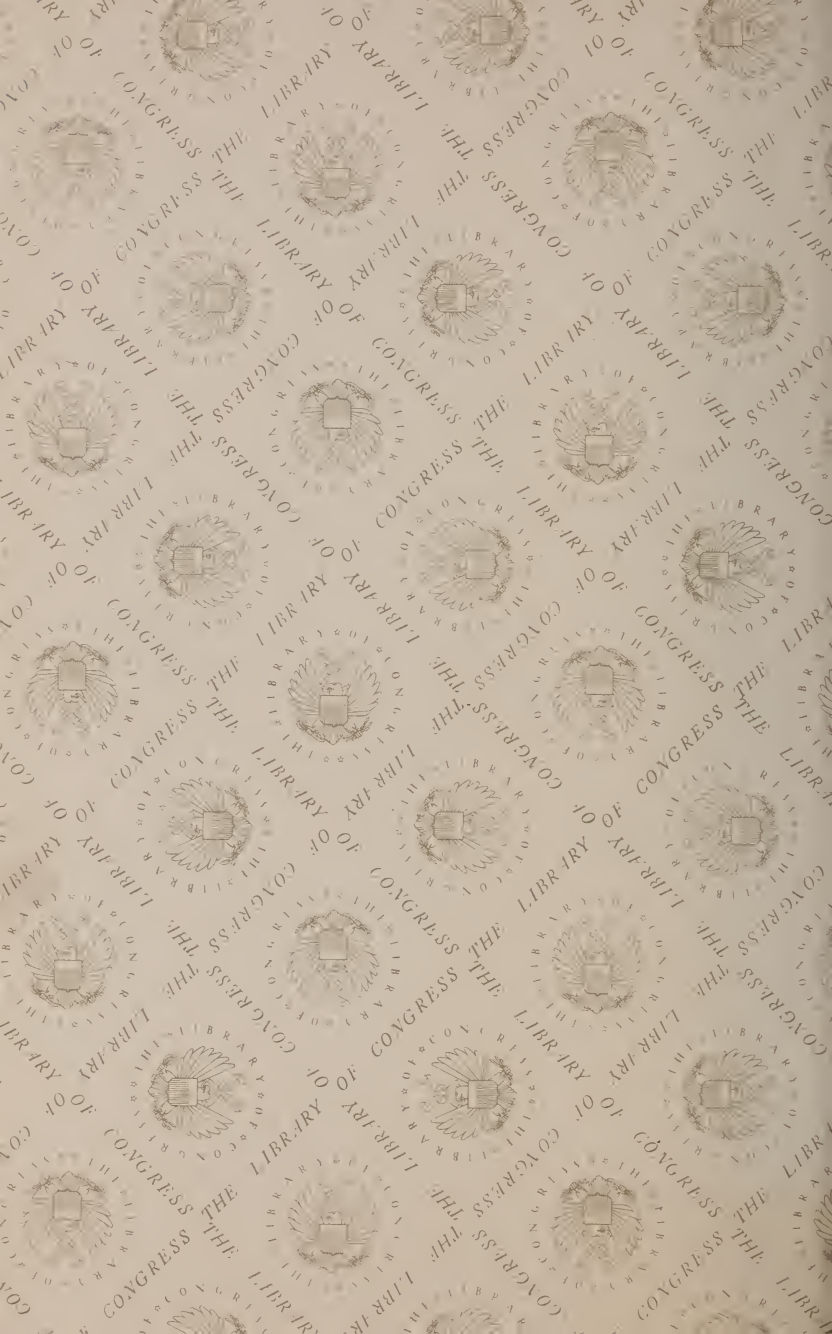

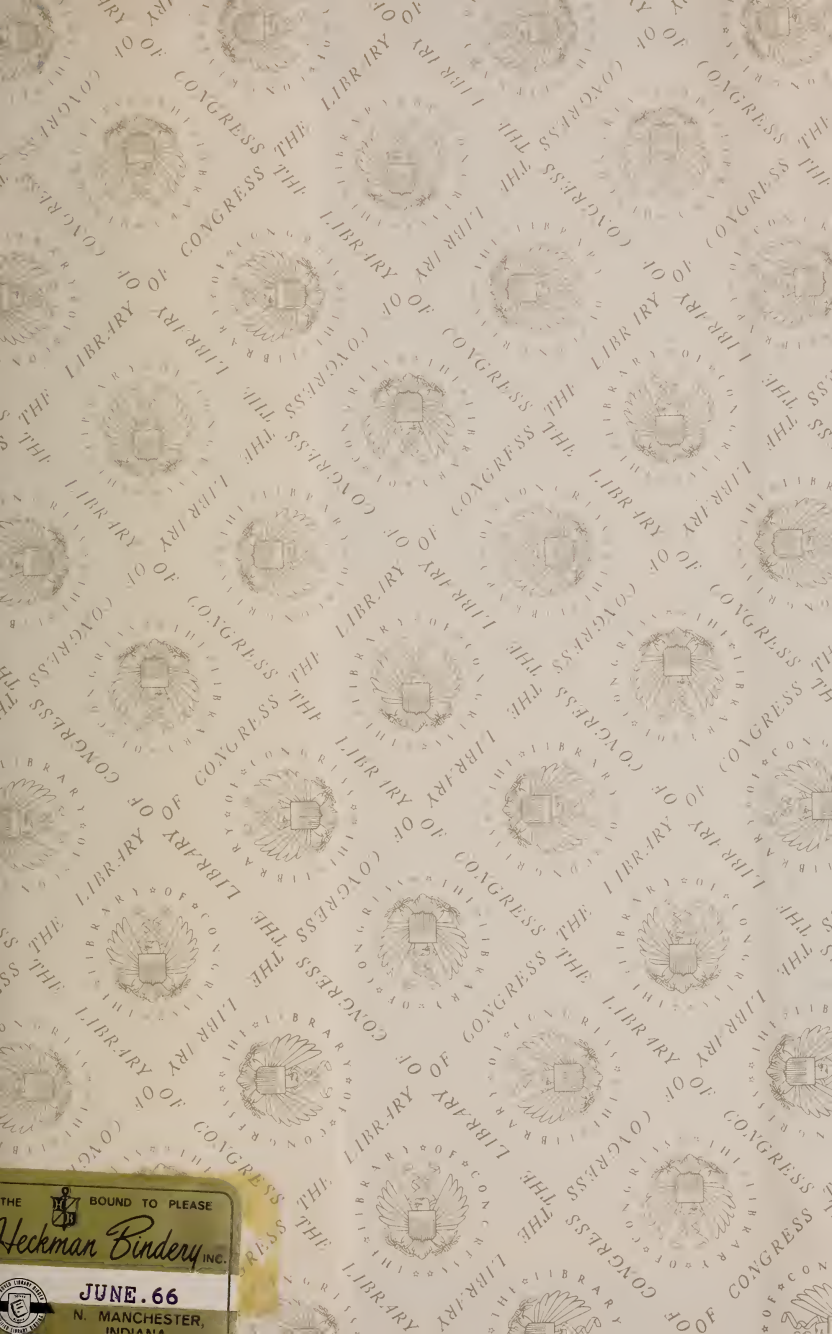

THE BOUND TO PLEASE
Heckman Bindery INC.
JUNE .66
N. MANCHESTER,
INDIANA

LIBRARY OF CONGRESS



0 003 709 014 1

