

TK 151

.H792

MODERN ELECTRICAL CONSTRUCTION

HORSTMANN & TOUSLEY

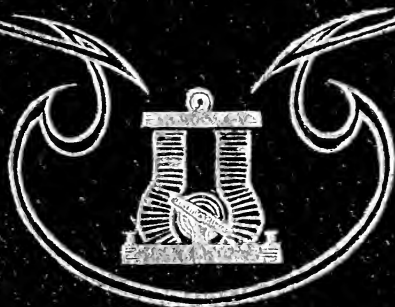



Class TK151

Book H792

Copyright N^o _____

COPYRIGHT DEPOSIT.





MODERN Electrical Construction

A RELIABLE, PRACTICAL GUIDE FOR THE
BEGINNER IN ELECTRICAL CONSTRUCTION
SHOWING THE LATEST APPROVED METHODS
OF INSTALLING WORK OF ALL KINDS AC-
CORDING TO THE SAFETY RULES OF THE

National Board of Fire Underwriters

By
HENRY C. HORSTMANN
"and

VICTOR H. TOUSLEY

*Authors of "Modern Wiring Diagrams and Descriptions" Elec-
trical Wiring and Construction Tables," "Practical
Armature and Magnet Winding," "Electricians
Operating and Testing Manual," Etc.*

Illustrated

THIRD EDITION—REVISED AND ENLARGED



CHICAGO
FREDERICK J. DRAKE & CO., PUBLISHERS

TK 151
H792

COPYRIGHT, 1904
BY
HORSTMANN AND TOUSLEY

COPYRIGHT, 1908
BY
HORSTMANN AND TOUSLEY

COPYRIGHT, 1911
BY
HORSTMANN AND TOUSLEY

2511A
D

©CL.A2S9076

PREFACE

In this volume an attempt is made to provide the beginner in electrical construction work with a reliable, practical guide; one that is to tell him exactly how to install his work in accordance with the latest approved methods.

It is also intended to give such an elaboration of "safety rules" as shall make the book valuable to the finished workman as well. To this end the rules of the "National Electrical Code" of the National Board of Fire Underwriters have been given in full, and used as a text in connection with which there is interspersed in the proper places a complete explanation of such work as the rules may apply to. This method of teaching and explaining practical electricity may at first glance seem somewhat haphazard, but it resembles very closely the actual method by which the most successful, practical workmen have learned the trade. It is thought that explanations pertaining directly to the work in hand will be more deeply considered and more likely to be fully comprehended than explanations necessarily more abstract.

It should be noted that, while the rules published in the "National Electrical Code" are standard and work done in

conformity with them will be first-class, several of the larger cities have ordinances governing electrical work which conflict in some details with these rules. Workers in such cities should, therefore, provide themselves with copies of these ordinances (usually obtainable without charge), and compare them with the rules given in this work. It is necessary for the electrical worker at all times to keep himself posted, for safety rules are liable to change.

The tables concerning screws, nails, number of wires that can be used in conduit, etc., are especially prepared for this volume, and give to it particular value for practical men.

THE AUTHORS.

PREFACE TO SECOND EDITION

The favorable reception which the first edition of this work has received at the hands of electrical workers generally has induced the authors to prepare this, the Second Edition. Considerable new matter, notably a section on Theater Wiring, has been added. All the necessary alterations and additions have been made in the text to conform to the latest issue of the National Code, together with the required explanations and illustrations. Other sections have been extended and the whole work has been carefully gone over and revised wherever the progress of the art has made it desirable.

THE AUTHORS.

PREFACE TO THE THIRD EDITION

In a work of this kind it is of prime importance that it be kept abreast of the times. Safety rules are liable to change, in fact must do so to adapt themselves to the steadily increasing number of new inventions and devices brought upon the market.

This work having found sufficient favor in the eyes of many instructors to warrant its adoption as a text-book, is to be revised and new matter added as often as notable changes in methods of construction or safety rules make it appear desirable.

The latest additions and modifications of the "National Electrical Code" are contained in an appendix which should be consulted. New illustrations are inserted in the body of the work as needed.

THE AUTHORS.

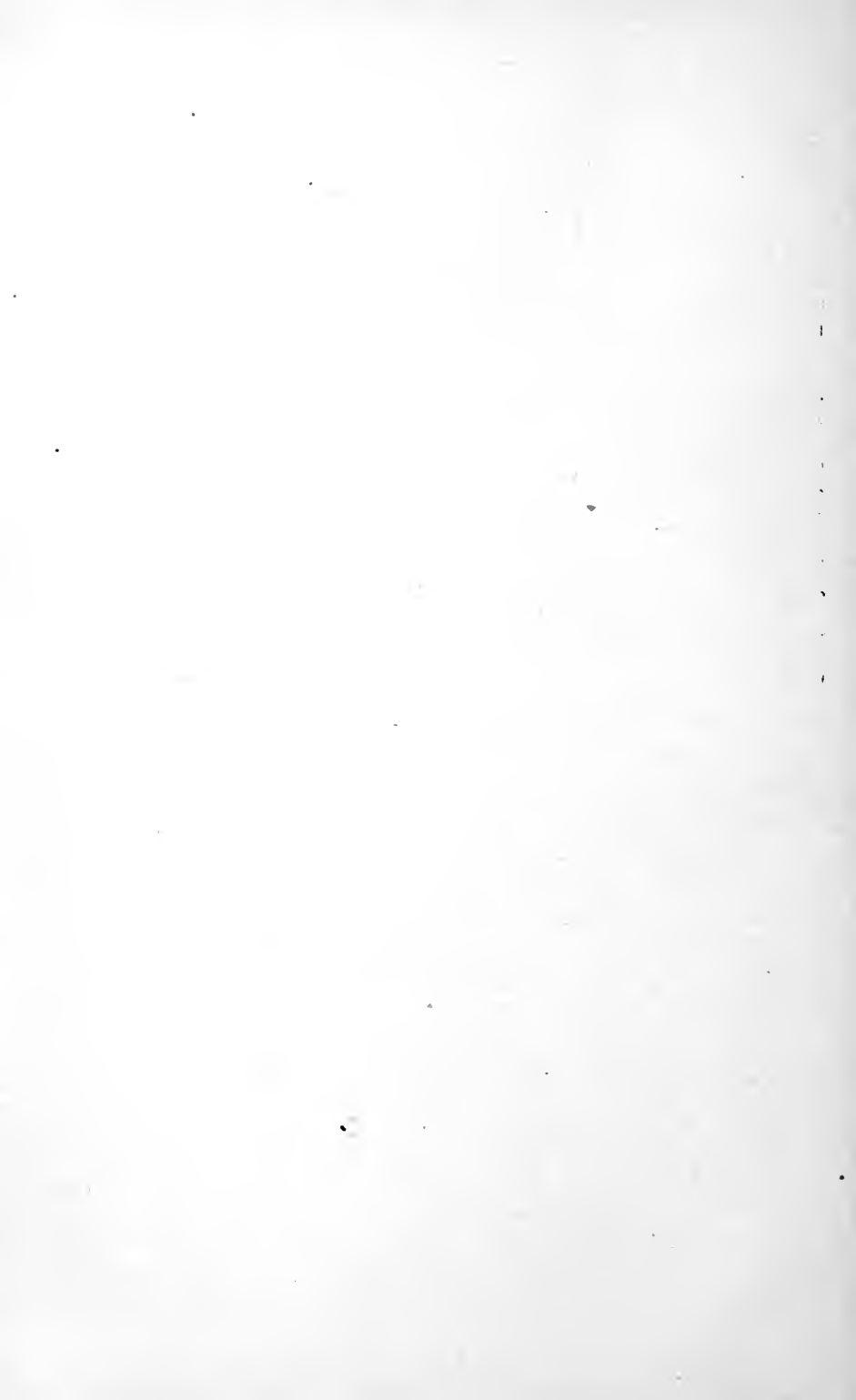

CHAPTER I.

The Electric Current.

It is quite customary and convenient to speak of that agency by which electrical phenomena, such as heat, light, magnetism, and chemical action are produced as the electric current. In many ways this current is quite analogous to currents of air or water. Just as water tends to flow from a higher to a lower level, and air from a region of greater density or pressure to one of lesser density, so do currents of electricity flow from a region of high pressure to one of low pressure. Currents of electricity form no exception whatever to the general law of all action, which is along the lines of least resistance. It must not be understood, however, that electricity actually flows in or along a conductor, as water does in a pipe, and the analogy must not be carried too far, for the flow of water in pipes is influenced by many conditions which do not influence a flow of electricity at all, and vice versa; there are conditions surrounding conductors, which influence the flow of electricity which do not affect the flow of water.

Above all, let it be understood that electricity is not independent energy, any more than the belt which gives motion to a pulley is. In other words, it is not a prime mover, it is simply a medium which may be used for the transmission of energy, just as the belt is used. To use electricity as a medium for the transmission of energy, it must be, we may say, compressed, or, to use a more properly technical expression, a difference of potential or pressure must be created in a system of conductors. This is very similar to the use of air

for power transmission; this must also be compressed so that a difference of pressure exists within a system of piping.

It is the flow of electricity or air which takes place when switches or valves are operated and which tends to equalize this pressure, i. e., flow from high to low pressure, that does our work. The real energy, however, (so far as we are concerned), to which we must look for our initial motion in either case is derived from the coal which generates steam; or, in the case of water-driven machinery, the rays of the sun which evaporate water, allowing it to be carried to higher levels, from whence it flows downward over dams and falls on its way back to the lowest level. In the battery, the real energy is that of chemical action, which is transformed into electrical energy.

The flow of current can take place only in a system of conductors which usually, for convenience, are made in the form of wires. The current for practical purposes may be considered as flowing along such wires only. It is not, how-

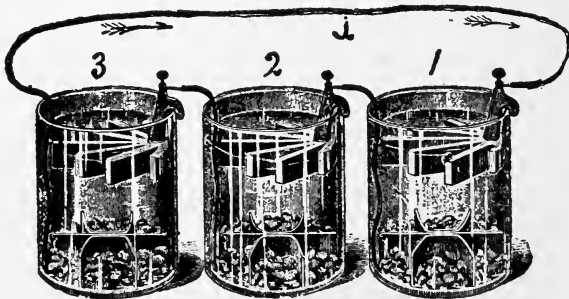

Figure 1

ever, necessary that these wires should be of any particular size, or consist all of the same material. In an electric battery, part of the circuit consists of the liquid contained within the battery; the rest being made up usually of wire. In an incandescent light circuit part of the circuit consists of the

lamp filament (usually carbon), while the balance of the circuit consists of copper wire.

The flow of current is also said to have a certain direction; that is, it is noticed that many of its effects are reversed when the terminals of the battery are reversed. Referring to Fig. 1, which shows a battery of three cells, the current flows from the copper element at bottom of jar 1, along the wire to the zinc element at top of jar 2, thence through the liquid to the copper element at bottom of jar 2, and from there to the zinc at top of jar 3, etc., and finally through the wire *a* back to the starting point. Within the battery the current flows from the zinc to the copper and the decomposition of the zinc generates the current. In the wire outside of the battery the current flows from the copper to the zinc as indicated by arrows. The combination of battery and wire is known as an electric circuit. The current will flow in this circuit only while it is complete, that is while each wire connects to its proper place as shown. If any wire is disconnected, the current flow will cease. Such a circuit is said to be *open*, but when all connections are properly made it is said to be *closed*.

Work can be obtained from a flow of current in many ways. If the current be forced to flow over a wire which is very small in proportion to the current carried, it will be heated thereby and finally melted if the current is excessive. This is how electric light is obtained.

If a wire carrying current be wound many times about an iron bar this bar becomes a magnet; that is, while the current is flowing around it, the bar has the power to attract other objects of iron or steel. The bar if made of well annealed iron will be a magnet while current is flowing around it, but will cease to be magnetic whenever the current flow ceases. Upon this fact the operation of electric bells, telegraph instruments and motors is based.

If a current of electricity flow through a properly arranged

“bath,” one of the plates will be gradually consumed and the other increased in weight. This effect is made use of in electro-plating, etc. If the jar contains water slightly acidulated and the current flows through it, the water will be decomposed and oxygen and hydrogen gas will be formed. This and many kindred effects are daily used in thousands of chemical laboratories.

If a wire carrying an electric current be placed very close to another wire forming a closed circuit, a wave of current will be induced in that wire every time the current in the other is made or broken, i. e., whenever it starts to flow or stops flowing. This fact forms the basis of the alternating current transformer.

All of these facts are used sometimes together, sometimes singly in measuring the electric current.

Conductors and Insulators.

Electrically speaking, all substances are divided into two classes. They are either conductors or insulators. By this is not meant that some substances can carry no current at all, for, as a matter of fact, there is no such thing as either a perfect conductor or a perfect insulator. A current of electricity can be forced through any substance, provided the pressure (E. M. F.) be made great enough, and there is no easier path open to the current. The two terms, conductor and insulator, are relative terms and must be understood simply to mean that the electrical resistance of a good conductor is infinitesimally small as compared to that of a good insulator. The lower the specific resistance of any substance, the better its conducting qualities; the higher the specific resistance of any substance, the better will be its insulating qualities.

At the left is given a list of good conductors, in the order of their conductivity, the figures representing the relative con-

ductivity of these metals. A list of insulators is given at the right; all of these are more or less affected by moisture, losing their insulating qualities when wet.

Silver	100.0	Dry air.	Fiber.
Copper	94.0	Rubber.	Wood.
Gold	73.0	Paraffin.	Shellac.
Platinum	16.6	Slate.	
Iron	15.5	Marble.	
Tin	11.4	Glass.	
Lead	7.6	Porcelain.	
Bismuth	1.1	Mica.	

Pressure or Electro-Motive Force.

Currents of electricity flow only in obedience to electrical pressure. This pressure is measured and expressed in *volts*, the unit of electrical pressure being the *volt*. If we speak of water or steam pressure, we speak of it in pounds, the pound being the unit of measurement. In speaking of electrical pressure we refer to it as of so many *volts*. There is no direct connection between the pound and the volt, but each in its place means about the same thing.

The *volt* is defined as that difference of potential (pressure) that must be maintained to force a current of one *ampere* through a resistance of one *ohm*.

If we have a resistance greater than one ohm and wish to send a current of one ampere through it, we can do so by increasing the pressure or voltage, as it is termed, accordingly. The current flowing in a circuit can also be reduced by reducing the *voltage*.

The ordinary incandescent lamps operate at about 110 *volts* pressure, although some are built for 220 volts. An electric bell requires about 2½ volts (a battery of 2 cells) for proper operation.

Resistance.

We have seen that a flow of current always takes place along or in a conductor. Every conductor, no matter how large or small it may be, offers some resistance to this flow of current just as the water pipe offers more or less resistance to the flow of water. This resistance may be measured and expressed in *ohms*; the unit of electrical resistance being the *ohm*. The *ohm* is defined as that resistance which requires a difference of potential of one volt to send a current of one *ampere* through it. If we should desire to send a greater current through any resistance, we can do so by increasing the pressure, just as we can increase the flow of water in a pipe by increasing the pressure or head of water in the tank that supplies it. If the pressure is fixed we can decrease the current by using a wire of greater resistance or increase it by using wires of lesser resistance.

The *ohm* is the resistance of a column of mercury 106.2 centimeters long (about $3\frac{1}{2}$ feet) and one square millimetre (about .0015 sq. in.), in cross-section, at the temperature of melting ice.

The resistance of a No. 14 copper wire about 380 feet long is equal to one ohm.

The resistance of all conductors increases directly as the

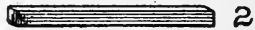

Figure 2

length and decreases as the cross-section increases. In Figure 2 the resistance of the two bars of copper is exactly equal. Bar No. 1 having a cross-section of 4 square inches and being 4 feet long, while bar No. 2 has a cross-section of only 1 square inch and is only one foot long. If bar No. 1 were

reduced to a cross-section of 1 square inch, it would become 16 feet long and would have a resistance 16 times as great as that of bar No. 2.

Current.

The electric current is the result of electrical pressure (volts) acting through a resistance, and is measured in *amperes*, the *ampere* being the unit of current strength. The *ampere* is defined as that current which will flow through a resistance of one *ohm* when a difference of potential or pressure of one volt is maintained at its terminals.

The *ampere* expresses only the rate of flow, not the quantity. Knowing the amperes if we would know the quantity, we must multiply by the time that the rate of flow continues. The rate of flow is analogous to the speed of a train; unless we know how long the train is to maintain a certain speed, we have no idea how far it is going.

Quantity in electricity is measured in *coulombs*. The *coulomb* is the quantity of current delivered by a flow of one ampere in one second.

Ohm's Law.

Ohm's law expresses the relation of the three principal electrical units to each other and forms the basis of all electrical calculations.

This law states that in any electric circuit (with direct current) the *current* equals the *electro-motive force* divided by the *resistance*. The current, we have already seen, is the medium which does our work. Current flow, we see from this law, can be increased either by increasing the electro-motive force, or electric pressure, which causes the flow; or by decreasing the resistance which tends to prevent current flow.

Expressed in symbols it is this: $I=E/R$; where I stands for

current, E, for electro-motive force, and R for resistance. If, as an example, we have an electro-motive force (which we shall henceforth designate by the customary abbreviation, E. M. F.) of 110 volts and a resistance of 220 ohms, the resulting current will be 110 divided by 220 = $\frac{1}{2}$ ampere, being approximately the current used in a 16 cp. incandescent lamp at 110 volts. Thus it will be seen that by a very simple calculation we can find the current flow in any conductor if we but know the E. M. F. and the resistance of that circuit.

This formula can also be used to find the E. M. F., if we know the value of current and the resistance, since E divided by R = I; I times R must equal E. If the current and resistance are known, we need only to multiply them together to find the E. M. F.; $I \times R = E$. Knowing the current and E. M. F., we can find the value of the resistance by dividing the E. M. F. by the current; $E/I = R$.

As a practical application of these formulas: If we wish to know how much current a certain E. M. F. can force through a certain resistance, we must divide the E. M. F. (volts) by the resistance (ohms.) If we wish to know what E. M. F. (volts) will be necessary to force a certain current (amperes) through a certain resistance, we need only multiply the current (amperes) to be obtained by the resistance in ohms. If we wish to know how much resistance (ohms) must be placed in a circuit to keep down the current flow to a certain limit, we need only divide the E. M. F. (volts) by the desired current (amperes); the result will be the value in ohms of the required resistance.

Power.

The power consumed or transmitted in an electric circuit equals the product of the volts and amperes; pressure and current.

To find the power of a steam engine, we must know the pressure of the steam and the quantity used; the power contained in the water of a dam depends upon its volume and its head. The power we can obtain from the wind depends upon its speed and the surface we expose to it which also measures the quantity.

All of these cases are analogous and similar. Power expresses the rate of doing work, thus the rate of work is the same whether we are lifting one pound at the rate of 100 feet per minute, or 100 pounds at the rate of one foot per minute. The unit of electrical power is the *watt*. It is the power expended in an electric circuit when one ampere flows through a resistance of one ohm, or when a difference of potential of one volt is maintained in a circuit having a resistance of one ohm. In an electric light circuit, for instance, as far as the power is concerned, it is immaterial whether each lamp requires 110 volts and $\frac{1}{2}$ ampere, or 55 volts and one ampere, or 220 volts and $\frac{1}{4}$ ampere. The power (watts) expended in an electric circuit is always equal to the volts multiplied by the amperes; thus, one ampere at 1,000 volts is equal to 100 amperes at 10 volts, or to 200 amperes at 5 volts. In any power transmission whenever the pressure (volts) is lowered, the current (amperes) must be increased or the power (watts) will fall off, and, on the other hand, whenever the pressure is increased the current may be decreased.

Instead of multiplying volts by amperes, we can find the power in an electric light circuit by multiplying the current by itself and then by the resistance; or the E. M. F. by itself and divide by the resistance.

Thus knowing the volts and the amperes, we use the formula $E \times I = W$. Knowing only the amperes and the ohms, we may use the formula, $I^2 \times R = W$; and lastly,

knowing only the volts and ohms, we use the formula, $E^2/R = W$.

In the above E stands for E. M. F., or volts; I for current or amperes; and R for resistance or ohms.

Divided Circuits.

Currents of electricity always flow along the paths of least resistance just as currents of water do. Water, it is well known, will not flow over the top of a mill dam while

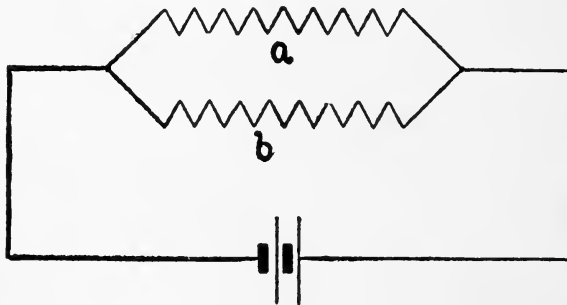

Figure 3

there is an opening alongside of it through which it can flow. If a barrel of water be provided with two openings, one large opening and one small, a much larger quantity will flow out through the large opening than through the small. This is because the resistance to the flow of water of the large opening is so much less than the resistance of the small opening.

An electric current will act in just the same way; the conductor having the lesser resistance will carry the greater current. If we know the resistances of the different paths open to a certain current we can determine to a nicety how much current will flow in each. In Figure 3, which represents diagrammatically a battery of two cells and an electric circuit, the resistance of the two paths, *a* and *b*, is equal to

10 ohms each, and the current will divide equally between them. If the resistance of a were 5 ohms, and that of b , 10 ohms, two-thirds of the total current would pass through a and the one-third through b .

In all such divided circuits, the current is always inversely proportional to the resistance and the simplest way to find the current in each is to add the resistances of the two circuits; for instance as above, 5 plus 10 equals 15; now $5/15$ of this current will flow through the 10 ohms and $10/15$ of the current will flow through the 5 ohms.

To determine the combined resistance of the two wires, a and b , we need simply to consider them as made into one wire. If they are both alike, they would, if made into one wire, be twice as large as either one is at present, and would then have only one-half as much resistance as either one had before; for the resistance of any conductor increases directly as its length, and decreases as the cross-section increases. The combined resistances of any two conductors can be found by multiplying their two resistances together and dividing this product by their sum. Thus, again taking the value of a and b as 10 ohms each, 10×10 equals 100, this divided by 10 plus 10 equals 5, which is the combined resistance of the two.

If we have a large number of branch circuits as shown in Figure 4, which represents diagrammatically an incandescent

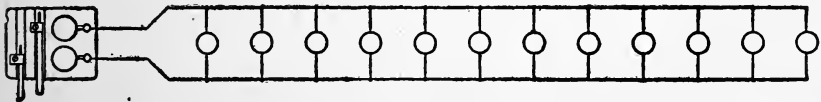

Figure 4

electric light circuit of 12 lights (which is equal to 12 separate circuits, since each lamp really forms a circuit by itself), we can find the joint resistance of the 12 by proceeding as before; that is, multiplying together the resistance of the first and

second lamp and dividing by the sum of these resistances; next take the result so obtained (which is the combined resistance of the first two lamps) and with it multiply the resistance of the third lamp and divide by the sum as before. By repeating this operation and always treating the joint resistances already found as one circuit, the joint resistance of any number of such circuits can be found. Another and a very much quicker way consists in using the following formula: The joint resistance of any number of parallel circuits is equal to the reciprocal of the sum of the reciprocals. The reciprocal of any number is 1 divided by that number. If we have three circuits, having respectively 10, 20, and 30 ohms resistance, we proceed in the following way: The reciprocal of 10 is $1/10$, of 20, $1/20$, etc., the joint resistance, therefore, is $1/10$ plus $1/20$ plus $1/30$ equals $11/60$, and 1 divided by this number which is $5\ 5/11$.

These methods are only necessary when the resistances are of different values. When all of them are alike, as is usual with incandescent lights, the resistance of one lamp needs only to be divided by the number of lamps to find the joint resistance. Thus, supposing each of the 12 lamps to have a resistance of 220 ohms, the joint resistance of the circuit would be $220/12 = 18\ 1/3$.

CHAPTER II.

Electric Bells.

We are now in a position to apply the electrical laws we have just discussed practically, and for this purpose may take up electric bells and bell circuits.

Figure 5 shows an electric bell, push button and battery, all connected up and complete. The action of the bell when

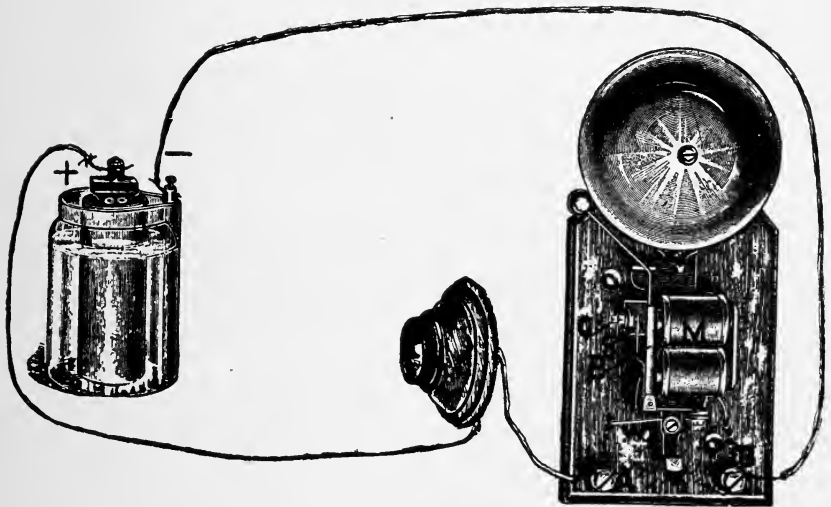

Figure 5

fully connected is as follows: Pressing the push button closes the circuit and current at once flows from the carbon pole marked + through the push button to the binding post A on the bell frame, thence along the fine wire W to the iron frame-work supporting the armature, B. This frame-

work is in electrical connection with B. The armature, B, is provided with contact spring S, which normally rests against the adjusting screw, C. The current now passes from the contact spring to the adjusting screw and from it to the wire wound on the magnets, M, around the many turns of wire to the binding post, D, and back to the zinc pole of the battery marked —.

The current circulating many times in the wire wound on the spools of M makes the iron cores magnetic so that they now attract the armature B. When this armature is attracted, it moves towards the magnets, M, and carries the small contact spring with it, thus breaking the connection between C and S.

This stops the current flow and the magnets, M, are at once demagnetized, thus releasing the armature B, which flies back and again closes the circuit at CS, this causes the armature to be attracted again and once more the circuit is broken. In this way the armature is made to strike the gong continuously while the circuit is kept closed at the push button. When the button is released, the circuit is permanently open and the bell at rest.

In the figure there is shown only one cell, this, if a good form is selected, is sufficient for a new bell if the circuit is not long. When, however, the bell is used much the contact points are eaten away by the little sparks occurring every time the bell breaks the circuit. Dirt is also likely to gather on them and prevent good contact being made. Both of these factors add resistance to the circuit, and consequently lessen the current flow:

We have seen before that the current equals the E. M. F. divided by the resistance, and in order to obtain the necessary current flow to operate the bell, we may either clean the contact points to lessen the resistance, or increase the E. M. F. by adding another cell in series with the first.

The latter expedient is by far the better, because it gives us a little surplus of power which is very useful to overcome variations in adjustment of the contact spring, loose contacts, dirt, etc. We should avoid using too many cells as well as not enough. If too many cells are used, there

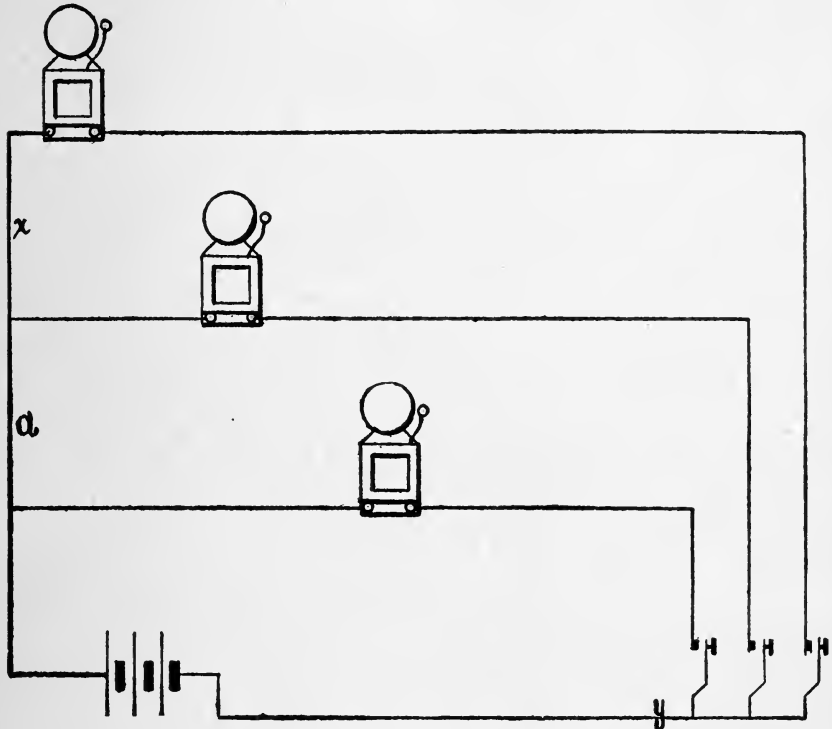

Figure 6

will be much unnecessary damage done to contact points by the larger sparks.

If the circuit is very long, the great length of wire will also provide additional resistance. This can be overcome in two ways, by increasing the E. M. F. as above, or by using larger wires. We have already seen that the larger the wire, the less will be its resistance. It is common practice to use

No. 18 copper wire for all ordinary distances and for single bells. With large bell systems, it is customary to use No. 16 or 14 for the main wire, which leads to all of the bells and may be called upon to supply several bells at the same time. Figure 6 shows a diagram of such a system and in case the three push buttons are used at the same time, three times as much current will flow in the main or battery wire *a* as in either of the other wires.

We have seen before that currents of electricity divide among different circuits in the inverse ratio of their resistances. In other words, the circuit having the least resistance will carry the most current. If our bell system, Figure 6, be "grounded" at the two points *x* and *y* (i. e., bare wire in contact with metal parts of buildings which are connected together) the current instead of flowing through the longer circuit and the bell, will flow through the short circuit and leave it impossible to operate the bells. If the contacts, at *x* and *y* are poor, i. e., of high resistance, only a small part of the current will leak from one to the other. In such a case, the bells may work properly, but the battery will soon run down and there is a strong likelihood that one of the wires will be eaten away through electrolytic action. To prevent troubles of this kind, bell wires should be well insulated and kept away from pipes or metal parts of building. Damp places should also be avoided and special care is recommended for the battery wire *a*, Figure 6. For further information concerning diagrams, etc., of bell circuits the reader is referred to *Wiring Diagrams and Descriptions* by the authors of this work, Fred J. Drake & Co., Chicago.

Bell wires are usually run along base boards, over picture mouldings, etc., in some cases they are also fished as explained further on. Batteries should be located in cool, dry places, where they are not liable to freeze, and where they are readily accessible as they must be kept nearly full of water and must be recharged from time to time.

The Telephone.

The principle and action of the Bell telephone can be best explained by reference to Figure 7. In this figure, A represents the transmitter, and B, the receiver. The essential parts of the transmitter are: the diaphragm, *a*; an electric circuit, containing a battery, *b*, and consisting of the wires, *c*, *c*¹ and partly wound upon an iron core, *d*.

This electric circuit, it will be seen from the figure, connects with one pole to the diaphragm, *a*, and with the other to a small metal plate, *e*. Between the diaphragm, *a* (which is a plate of very thin iron), and the plate, *e*, there are many small pieces of carbon which complete the circuit. When now a party speaks into the mouthpiece of the transmitter,

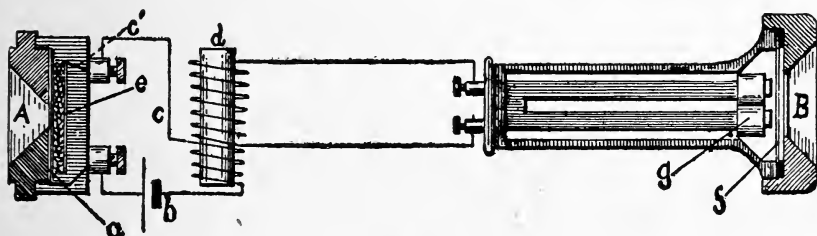

Figure 7

the sound waves cause the diaphragm, *a*, to vibrate; the rate of vibration and character of the vibrations being an exact duplication of the voice speaking into it. These vibrations cause the small pieces of carbon between the diaphragm and the back plate to be alternately compressed and allowed to expand. Now the resistance of these carbon pieces is decreased as they are tightly pressed together, and again increased when the pressure is released. Therefore the current of electricity flowing through them varies continuously while the diaphragm is in motion.

This varying current circulates around the lower part of the iron core, *d*, and the two windings upon it form an

ordinary induction coil. Every variation of current strength in the circuit of the transmitter is by means of it reproduced in the circuit of the receiver, *B*.

The essential parts of the telephone receiver are: The diaphragm *f*, very similar to that of the transmitter, the two magnets, *g*, and the electric circuit coming from the induction coil of the transmitter. The electric circuit, we have already seen, is traversed by electric currents exactly like those that flow in the circuit of the transmitter. These currents pass around electro-magnets, *g*, and attract the diaphragm, *f*, more or less strongly in proportion to the varying degrees of current strength.

In this manner the diaphragm, *f*, of the receiver is made to vibrate in exact unison with that of the transmitter, and thus to reproduce exactly the sounds given to the transmitter.

The transmitter is not absolutely necessary for the re-

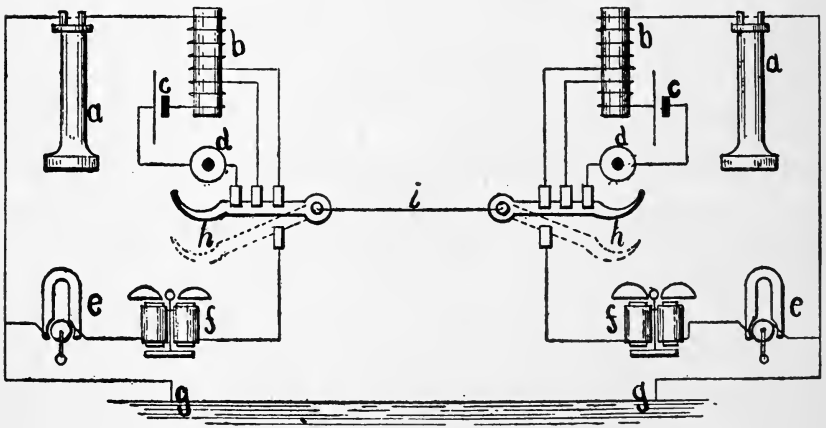

Figure 8 ·

ceiver can be used as such, and in fact was so used at first. Lines of short distances can be operated without transmitters, but the speech will not be as plain.

Figure 8 is a diagram of the connections of two telephone instruments together with the necessary call bells. When the lines are not in use, the receivers, *a*, are hanging on the hooks, *h*, holding them down as shown by dotted lines. This leaves the circuit complete through the earth, *g*, magneto generator, *c*, bell *f*, line *i*, and duplicates of these parts at the right. When now the magneto generator is operated both bells will ring. When the receivers are removed, a spring forces the hook upwards making the connection shown in solid lines. This closes the battery circuit which must be open when the instrument is not in use or the battery will run down.

The talking circuit is now complete from earth, *g*, through the receiver, *a*, induction coil, *b*, line *i*, and duplicates of these parts at the right.

The Induction Coil.

Figure 9 is a diagrammatic illustration of an induction coil as used mostly by medical men. Such an instrument

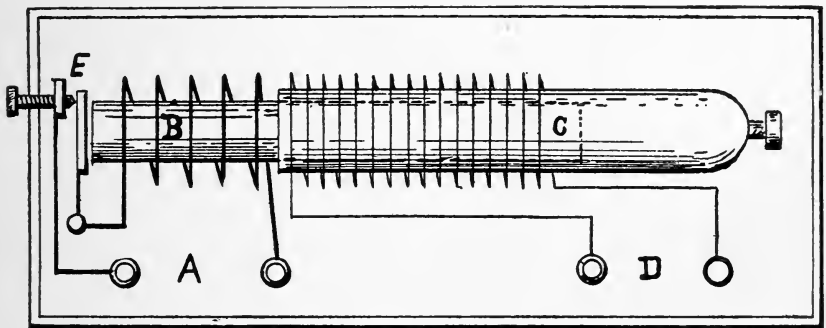

Figure 9

consists of an iron core, *B*, usually made up of a number of soft iron wires; and two electrical circuits insulated from each other, and terminating in the two pair of binding posts, *A* and *D*. Of these two circuits *A* consists of a short length

of comparatively heavy wire wound upon the iron core, and is known as the *primary* coil. D is a similar coil, but usually consisting of many more turns of wire, and the wire is also of much smaller gauge and is known as the *secondary* coil.

The operation is as follows: A battery is connected to the binding posts, A, and current begins to flow in the circuit. In this circuit is an interrupter or vibrator, E, constructed similarly to the one described in connection with the electric bell. As current flows through the primary coil, it magnetizes the core, B, and this attracts the armature, E, causing it to break the connection between itself and the adjusting screw. As this connection is broken, the current in A ceases to flow, the core is de-magnetized and the armature again connects with the adjusting screw. This action is repeated just as in the electric bell, and in consequence the core B, is rapidly magnetized and de-magnetized.

Every time the core, B, is magnetized a current of electricity, lasting, however, only an instant, is induced in the secondary coil, D. The magnetism in the core is caused by a current of electricity circulating around it, and currents of electricity are in turn produced by this magnetism in the other or secondary coil.

This method of producing electric currents is known as electro-magnetic induction, and currents so produced are said to be "induced" currents, hence the name induction coil. The currents so induced are alternating, that is, changing in direction. At the "making" of the primary circuit, the current in the secondary coil is in a direction which opposes the magnetization of the core by the primary current; at the time of "break" in the primary circuit, the induced current will be in the opposite direction.

The tube, C, is movable and may be slipped entirely in over the iron core, or withdrawn entirely. If it is in, the currents which were before being induced in the secondary wires are

now induced in the metal of the tube and consequently the effect on the secondaries is very much reduced.

The energy in the primary and secondary coils is always equal. If the two coils have the same number of turns, the currents and electro-motive forces are exactly alike. If the secondary coil has more turns of wire than the primary, the induced E. M. F. in it will be greater, but the current will be smaller and vice versa. The induction coil is very similar to the alternating current transformer, the main difference being that the transformer does not have an interrupter since the current supplied to it is itself constantly alternating.

Batteries.

Currents of electricity for commercial purposes are produced either by dynamo electric machines or by batteries.

A "battery" is the name given to a number of cells connected together so as to produce a current greater than one



Figure 10

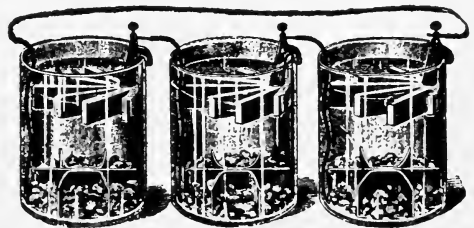

Figure 11

cell alone could produce. Figure 10 shows one cell of a kind that is generally used only intermittently, as for instance with door-bells. When the bell is not ringing the battery is idle.

This style of cell is very useful for such work, but entirely useless for work requiring current continuously. The cell consists of a glass jar which is filled about $\frac{3}{4}$ full of water in which a quantity of sal-ammoniac is dissolved. Immersed in this solution is a carbon cup or center, which forms the positive or + pole of the cell, and a zinc rod, carefully separated from the carbon by a rubber washer at the bottom and a porcelain tube at the top. So arranged, the current tends to flow, in the battery, from the zinc to the carbon and if the zinc and carbon outside of the cell be joined by a piece of wire or other conductor of electricity, the current will flow in the external circuit, from the carbon back to the zinc. If the zinc and carbon are not joined by a conductor of electricity there will be no current flow, but merely an electrical pressure tending to send a current. Each cell of this kind has an electro-motive force of about 1.4 volts. This is not sufficient for general use in connection with bells, etc., and in order to obtain greater current strength a number of cells are connected together in series as shown in Figure 11.

This figure shows a different kind of cell, but will nevertheless illustrate the method of connecting cells in series; which is, to connect the carbon or copper pole of the first cell to the zinc of the second, and again the carbon pole of the second to the zinc of the third, continuing in this way through all of the cells. Thus connected, all of the electro-motive forces act in one direction and if we have twelve cells each of an electro-motive force of 1.4 volts, we obtain a total electro-motive force to apply on our work of 12×1.4 or 16.8 volts.

Should we, however, connect six of the twelve cells as above, and then accidentally connect the other six in the opposite direction, that is, the zinc of the sixth cell to the zinc of the seventh, and then continue in this order, we should obtain no current whatever; six of our cells would tend to

send current in one direction and six in the other, so that the result would be nothing. Should ten cells be properly connected to send current in one direction and two connected to oppose them, the net electro-motive force would be 10×1.4 minus 2×1.4 , which is 11.2. The ten cells would force current through the other two in the opposite direction.

The electro-motive force of a cell is independent of its size, that is, a very small cell would set up just as high an electrical pressure as a very large one made of the same material. A large cell is, however, capable of delivering a much stronger current because its own resistance to the current flow is much less than that of a small cell. Large cells will, therefore, in most cases give very much better service than small ones. Especially in cases where considerable current is required as in electric gas-lighting and annunciator work, where it is always possible that two or three bells or fixtures may be called into action at the same time.

In setting up and maintaining sal-ammoniac batteries, the following general rules should be observed:

Use only as much sal-ammoniac as will readily be dissolved; if any settles at the bottom it shows that too much has been used. Keep your battery in a cool place, but do not allow it to freeze. See that the jars are always about $\frac{3}{4}$ full of water.

Keep the tops of glass jars covered with paraffin to prevent salts from creeping.

The battery should never be allowed to remain in action (i. e., send current) continuously, or it will run down. If it has been run down through a short circuit or other cause, it should be left in open circuit for several hours; it will then usually "pick up" again.

The so-called dry-batteries are made up of about the same material, but applied in form of a paste. They are

suitable for the same kind of work and especially handy for portable use.

For continuous current work, such as telegraphy, for instance, the kind of battery shown in Figure 11 is generally used. The electro-motive force of this style of battery is a little less than that of the sal-ammoniac battery and its resistance is considerably greater.

Therefore, it is not well adapted for work requiring considerable current strength. Bells, telegraph instruments, etc., to be used with this battery require to be specially designed for it; the current being less in quantity must be made to circulate around the magnets many more times in order to fully magnetize them.

The sal-ammoniac batteries cannot be used continually or they will run down; this battery must be kept at work always or it will deteriorate.

This style of cell is known as the crow-foot or gravity cell, the action of gravity being depended upon to separate the essential elements of the solution.

To set up this battery, the zinc crow-foot is suspended from the top of the glass jar as shown. The other element of the cell consists of copper strips riveted together and connected to a rubber-covered wire shown at the left of each cell, Figure 11. This copper is spread out on the bottom of the jar and clear water poured in until it covers the zinc. Next drop in small lumps of blue vitriol, about six or eight ounces to each cell.

The resistance may be reduced and the battery be made immediately available by drawing about half a pint of the upper solution from a battery already in use and pouring it into the jar; or, when this cannot be done, by putting into the liquid four or five ounces of pulverized sulphate of zinc.

Blue vitriol should be dropped into the jar as it is consumed, care being taken that it goes to the bottom. The

need of the blue vitriol is shown by the fading of the blue color, which should be kept as high as the top of the copper, but should never reach the zinc.

A battery of this kind when newly set up should be short circuited for a few hours, that is, a wire should be connected from the zinc at one end of the battery to the copper at the other.

There are many styles of batteries and different chemicals are used with them. The two kinds above described are, however, the most used. The methods of connecting is in all batteries the same.

Figure 12 shows a diagram of a battery connected in series; the long thin lines represent the copper or carbon pole from which the current flows in the external circuit and the short thick lines represent the zinc from which the current flows toward the copper inside of the cell.



Figure 12

If we have a circuit of low resistance to work through and desire to increase the current, we may group our cells as shown in Figure 13, where two sets are in parallel. This arrangement will give a stronger current, but it is necessary to see that both groups of cells have the same electro-motive force; if they have not, the higher one will send the current through the lower. If the two batteries are not connected with similar poles together, they would be on short circuit, and no current could be obtained in the external circuit.

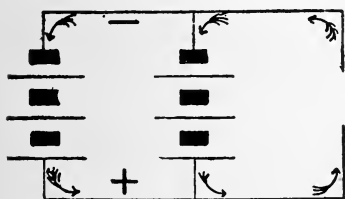

Figure 13

CHAPTER III.

Wiring Systems.

There are numerous systems of electric light distribution. The oldest and the first to come into general use is shown diagrammatically in Figure 14. This is the series arc system. In this system the same current passes through all of the lamps; and as more or less lamps are required the E. M. F. of the dynamo must be correspondingly increased or dimin-

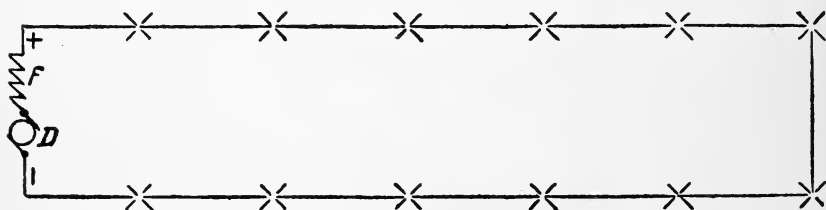

Figure 14

ished. This is accomplished by means of an automatic regulator connected to the dynamo.

The current used with this system seldom exceeds ten amperes and large wires are never required. This system is best suited for street lighting where long distances are to be covered.

In these diagrams, D represents the dynamo, and F, the "field" coils of the dynamo. With *constant current* systems the "fields" are usually in series with the armature of the dynamo, as shown in Fig. 14, and the lamps, so that the same current must pass through all. With *constant*

potential systems, the field coils are generally independent of the rest of the circuit. With such systems the current used in the circuit is so variable that it cannot be used in the fields.

Another system, known as the multiple arc or parallel system, is shown in Figure 15. In this system the E. M. F. never varies, but the current is always proportional to the

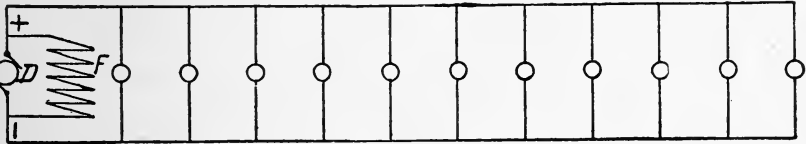

Figure 15

number of lights used. If, for instance, only one light is used, there is a current of about one-half ampere, but if ten 16 cp. lights are used there must be a current of about five amperes. Where many lights are used with this system, the main wires require to be quite large, and must always be proportional to the number of lights. This system is operated usually at 110 volts and is suitable for residences, stores, factories and all indoor illumination. It is not well adapted to the transmission of light and power over long distances.

The 3-wire system shown in Figure 16 combines many of

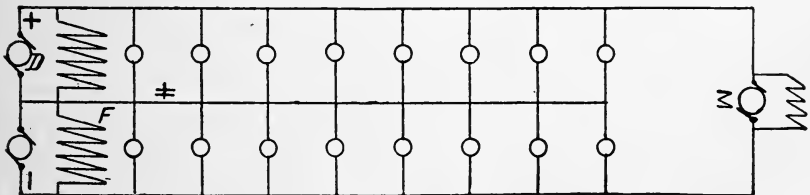
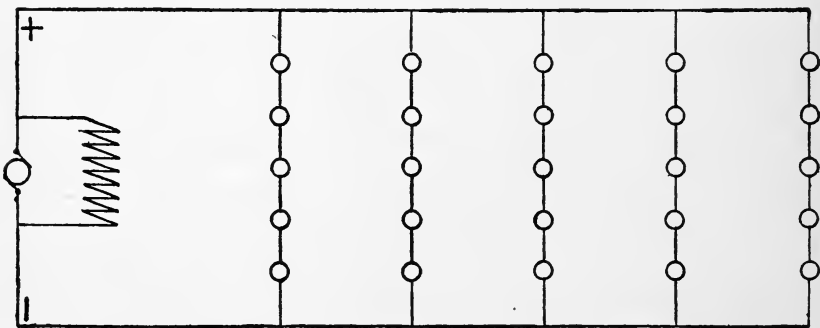

Figure 16

the advantages of both the foregoing systems. As will be seen from the diagram, it consists of two dynamos connected in series and a system of wiring of one positive +, one negative — and a neutral = wire. So long as an equal number of

lights are burning on both sides of the neutral wire, this wire carries no current, but should more lights be in use on one side of the system than on the other, the neutral wire will be called upon to carry the difference. If all the lights on one side are out, the dynamo on that side will be running idle.

The currents in the neutral wire may be either positive or negative in direction. The principal advantage of this system is that with it double the voltage of the 2-wire systems is employed and yet the voltage at any lamp is no greater than with the use of two wires. It is customary to use 110 volts on each side of the neutral wire and this gives a total voltage over the two outside wires of 220 volts. As the same current passes ordinarily through two lamps in series, we need, for a given number of lamps only half as much current as with 2-wire systems and can, therefore, use smaller wires. For the same number of lights and the same per-



- Figure 17

centage of loss the amount of copper required in the two outside wires is only one-fourth that of 2-wire systems; to this must be added a third wire of equal size for the neutral, so that the total amount of copper required with this system is $\frac{3}{8}$ of that of 2-wire system using the same kind of lamps.

Incandescent lamps are often run in multiple-series, as in

Figure 17, without a neutral wire. The number of lamps to be used in series depends upon the voltage of the dynamo. If that is 550, five 110 volt lamps are required in each group, or ten 55 volt lamps.

If the filament of one lamp breaks all of the lamps in

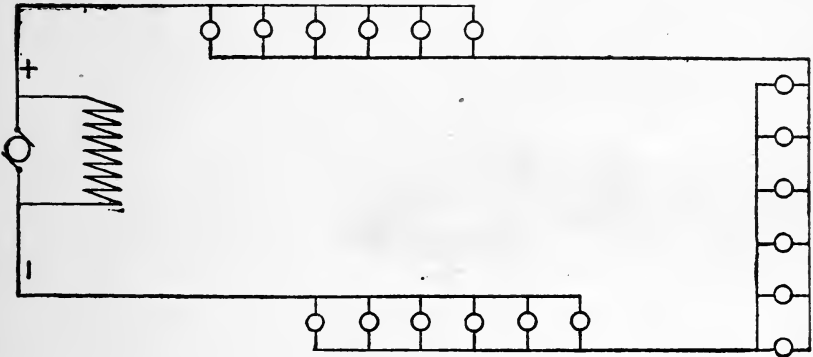

Figure 18

that group are extinguished and if one is to be used all must be used.

Figure 18 shows the diagram of a series-multiple system. This style of wiring should be avoided.

A diagram of an alternating current system is shown in

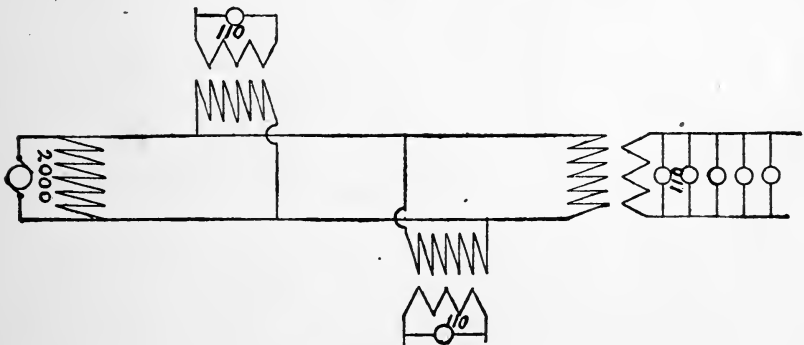

Figure 19

Figure 19. In this system extremely high voltage is used and consequently the currents are never very great. This makes

it extremely useful for long distance transmission. Since, however, the high pressure employed cannot be used directly in our lamps it must be transformed into lower pressure. This is done by means of transformers, and it is possible to reduce the line voltage to any desirable extent. As the voltage is reduced, however, the current increases and the wires taken from the transformers into the buildings must be as large as those for 2-wire systems using the same kind of lamps. The high pressure, or primary wires, are rarely allowed inside of buildings.

The Transmission of Electrical Energy.

We have seen that currents of electricity flow only in electrical conductors, and that these conductors are usually arranged in the form of wires. We have further seen that the power transmitted is proportional to the product of the volts and amperes used. The actual amount of energy transmitted being the product of the above multiplied by the time.

Currents of electricity always encounter some resistance and in consequence of this resistance, generate heat; the generation of heat in any electric circuit being proportional to the square of the current multiplied by the resistance. This formula, $I^2 \times R$ expresses the loss of electrical energy due to the resistance of the conductors and which reappears in the form of heat. If this loss is not kept within reasonable limits, the wires will become very hot and destroy the insulation or ignite surrounding inflammable material. The above loss and hazard is generally guarded against by insurance companies and inspection boards by designation of the current in amperes which certain wires may be allowed to carry.

Table No. 1 gives the currents which the National Board of Fire Underwriters has decided to consider safe and which

should be closely followed, and on no account should wires smaller than those indicated be used. There is no harm and no objection to using wires larger than indicated, but neither is there much gained unless the run be a long one as we shall see further on.

The table of carrying capacities shows a great discrepancy between the relative cross-section of large and small wires and the currents they are allowed to carry; thus a No. 0000 wire has a cross-section about eight times as great as that of No. 6, yet is allowed to carry less than five times as much.

This discrepancy arises from the different rate of heat radiation. The radiating surface or circumference of a small circle or wire is relatively to its cross-section much greater than that of a large circle, and other things being equal the ratio existing between the heat given to a body and its radiating surface determine its temperature.

We have seen before that the power (either for lights or motors) consists of two factors; current and pressure, expressed respectively as amperes and volts. We have also seen that the power (watts) equals the product of these two; hence it follows, that as we increase either one, we may decrease the other, or conversely, as one is decreased the other must be increased in order to deliver a given amount of power. We further know that it is the current alone which heats the wires and that accordingly as our currents are large or small, the wires used to transmit them must be large or small. It is obvious, therefore, that we can save much on copper by using higher voltages, since, if we double the voltage, we shall need only one-half as much current and can, therefore, use a much smaller wire. As an example: Suppose we have power to transmit which at 110 volts requires 90 amperes. This requires a No. 2 wire containing 66,370 circular mils. Now, if we double the voltage, we shall need only 45 amperes; this much we are allowed to transmit over

a No. 6 wire which has only 26,250 circular mils. We must not, however, increase our voltage without due precaution and consideration, for high voltage is dangerous to life and increases the fire hazard. It also increases the liability to leakage and requires better and more expensive insulation which in a small measure offsets the other advantages. The usual voltage employed at present varies from 110 to 220 volts for indoor lighting and power; 500 to 650 volts for street railway work and from 2 to 20,000 volts for long distance transmission. The higher voltages mentioned are seldom brought into buildings, and are nearly always used with some transforming device which reduces the pressure to 110 or 220 volts for indoor lighting or power.

The flow of current through a given lamp, motor, or resistance determines the light, power or heat obtainable from such device. We know that the flow of current in turn (other things being equal) varies as the E. M. F. maintained at the terminals of any of these devices. Consequently in order to obtain a steady flow of current it is necessary to provide a steady E. M. F.

The loss of E. M. F. in any wire is equal to the current flowing in that wire multiplied by the resistance of the wire. Since it is impossible to obtain wires without resistance, it is also impossible to establish a circuit without loss and wherever electricity is used some loss must be reckoned with. We may make this loss as large or as small as we desire. Where the cost of fuel is high, it is important to keep this loss quite small, using for that purpose larger wires. On the other hand where there is an abundance of cheap fuel, or, where, for instance, water power is used, it will be more economical to waste five or ten per cent of the electrical energy than to spend the money needed to provide the copper necessary to reduce the waste to one or two per cent.

In this connection, however, it must not be overlooked that

the quality of the service depends to a great extent upon the loss allowed and here the nature of the business supplied must be taken into consideration. In yards, warehouses, barns, etc., a variation of five or ten per cent in candle power may not matter much, but in residences or offices it is very annoying.

The loss in voltage depends, as we have already seen, upon the current used, and the resistance of the wire employed. If the current is decided upon, we can reduce the loss only by reducing the resistance; the resistance can be reduced only by increasing the size of wire used. If we double the cross-section of the wire, we decrease the resistance one-half and consequently reduce the loss or variation in voltage one-half. Thus it will be seen that as we attempt to reduce the loss in voltage to a minimum we shall require very large wires and thus greatly increase the cost of our installation.

For instance, if a line be in operation with a loss of twenty per cent, by doubling the amount of copper, we reduce the loss to ten per cent. In order to reduce our loss to five per cent, we must again double the amount of copper; and to reduce the loss still more, say to $2\frac{1}{2}$ per cent, a wire of double the cross-section of the last must be used. If the cost of copper in the original installation utilizing eighty per cent of the energy be taken as 1, then the cost of copper to utilize ninety per cent will be 2; of ninety-five per cent, 4; and of ninety-seven and one-half per cent, 8; and no amount of copper will ever be able to save the full 100 per cent. We must not overlook, however, that although a reduction of loss from four to two per cent requires us to double the amount of copper, it does not necessarily double the cost of our installation, for in many cases it adds but a small percentage to the total cost. For instance, if it were decided to use No. 12 instead of No. 14 wire in moulding or insulator

work, the cost of labor would not be appreciably affected thereby; similarly in connection with a pole line, the difference in total cost occasioned by the use of say No. 6 instead of No. 10 wire would be small.

Calculation of Wires.

In electrical calculations so far as they relate to wiring, the *circular mil* plays an important part, and it becomes necessary to thoroughly understand its meaning. The mil is the 1/1000 part of an inch, consequently one square inch contains $1,000 \times 1,000$ equals 1,000,000 *square mils*. If all electrical conductors were made in rectangular form, we should be able to get along nicely by the use of the square mil, but, since they are nearly all in circular form, the use of the square mil as a unit would necessitate otherwise unnecessary figures. The *circular mil* means the cross-section of a circle one mil in diameter, whereas the *square mil* means a square each side of which is equal to one mil in length. Square mils, can, therefore, be transformed into circular mils by dividing by .7854, and circular mils into square mils by multiplying by .7854, since it is well known that a circle which can be inscribed within a square bears to that square the ratio of .7854 to 1.

To illustrate: Using square mils if we wish to determine the cross-section of a wire having a diameter of 50 mils, we must first square the diameter and then multiply by .7854; $50 \times 50 \times .7854$, or 1963.5, which is the cross section of the wire expressed in square mils. To express the cross-section in circular mils, we have but to square the diameter, or $50 \times 50 = 2500$ circular mils. The 2500 circular mils are exactly equal to the 1963.5 square mils. The adoption of the circular mil simply eliminates the figure .7854 from the calculations.

The resistance of a copper wire having a cross-section of

one mil and a length of one foot is from 10.7 to 10.8 ohms, the variation being due to the temperature of the wire. 10.8 ohms is the resistance usually taken. This resistance increases directly as the length and decreases as the cross-section increases. The resistance of any copper wire can, therefore, be found by multiplying its length by 10.8 and dividing by the number of circular mils it contains. Expressed in

formula this becomes $R = \frac{L \times 10.8}{C. M.}$ where L stands for the

total length of wire in feet, and C. M. for the cross-section in circular mils, and R for the resistance in ohms. In order to find the loss in volts, we must multiply the resistance by the current used. Representing this current by I, the

formula becomes $\frac{I \times L \times 10.8}{C. M.} = V$; V being the volts lost.

It is, however, seldom necessary to find how many volts would be lost with a certain wire and current, but rather to find how many circular mils are necessary in a wire so that the volts lost may not exceed a certain percentage. In order to determine this, we transpose V and C. M. and the formula now becomes

$\frac{I \times L \times 10.8}{V} = C. M.$ This is the final formula and gives

directly the number of circular mils a wire must have so that the loss with this current and length of wire shall not exceed the limits set by V.

As an example, we have a current of 20 amperes to transmit a distance of 200 feet and the loss shall not exceed two per cent; voltage 110. This requires 400 feet of wire (two wires 200 feet long) and two per cent of 110 is 2.2. We therefore have $20 \times 400 \times 10.8$ divided by 2.2, which gives us 39,270 circular mils, which we see by table I is a little less than a No. 4 wire.

The above formula will answer for all 2-wire work, whether it be lights or power.

It is simply necessary to find the current required with whatever devices are to be used.

These calculations are not often made in actual practice. It is much easier to refer to tables such as II, III, IV, V, VI, given at the end of this volume, by which the proper size of wire can be determined at a glance almost.

In connection with 3-wire systems using two lamps in series, we need to calculate the two outside wires only, the neutral wire should then be taken of the same size. We must however assume double the voltage existing on either side of the neutral; that is to say, a 2-wire system using 110 volts would be figured at 110 volts, while a 3-wire system, using 110 volt lamps on each side of the neutral wire would be figured at 220 volts.

It must also be noted that with 3-wire systems the current required is only $\frac{1}{2}$ of that required with 2-wire systems. Ordinarily we have two lamps in series and the same current passes through both. Applying this to our formula we see that with the 3-wire system the current I is only half as great as with 2-wire systems and (the percentage of loss in both cases being the same) V , which stands for the volts to be lost, becomes twice as great. Owing to these two factors, the wire for 3-wire systems need have only $\frac{1}{4}$ as many circular mils as that of a 2-wire system with the same percentage of loss. To this must be added the neutral wire so that the total cost of wire must be $\frac{3}{8}$ of that for the 2-wire systems.

The amount of copper required in power transmission for a given percentage of loss varies as the square of the voltage employed. By doubling the voltage we can transmit power with the same loss four times as far; or, if we do not change distance or wire, we shall have only one-fourth of the loss

we had before. A practical idea of the laws governing the distribution of circuits and the losses in voltage and wire which are unavoidable may be gained from Figure 20.

Figure 20 shows 96 incandescent lights arranged on one floor and placed 10 feet apart each way. With all cutouts placed at A and circuits arranged as in No. 1, 2,080 feet of branch wiring for the eight circuits of 12 lights each, will be required. If the cutouts be placed in the center, B, the same length of wire will be necessary. We have in this case merely transferred the cross wires from one end of the hall to the center. If we arrange two sets of cutouts as at C and D and run circuits as 3 and 4 the total amount of wire necessary will be only 1,920 feet. By this arrangement we avoid the necessity of crossing the space indicated by dotted lines at the right, opposite B.

If we run the circuits on the plan of No. 2, the least amount of wire for the eight circuits will be 2,560 ft. Such wiring would require extra wires feeding the various groups. Should we run a set of mains along ACBD, and make 12 circuits of the installation by placing one cutout for each eight lights, the amount of wire required will be 1,680 feet. If we run a set of mains through B as shown by dotted lines using 12 lights per circuit, 1,760 feet of wire will be required. If we now double the number of lights in the same space or limit the number per circuit to six, we shall require 3,200 feet of wire to feed them all from A, but only 2,400 to feed them from B; to feed them all from the two centers C and D will also require 2,400 feet.

The most economical location of cutout centers will, with even distribution of light, and in regard to branch wiring only, be such that it is unnecessary to run circuits like No. 2; in other words, not more than the number of lights allowed on one circuit should lead away from it in one direction.

Suppose, for instance, the number of lights be increased

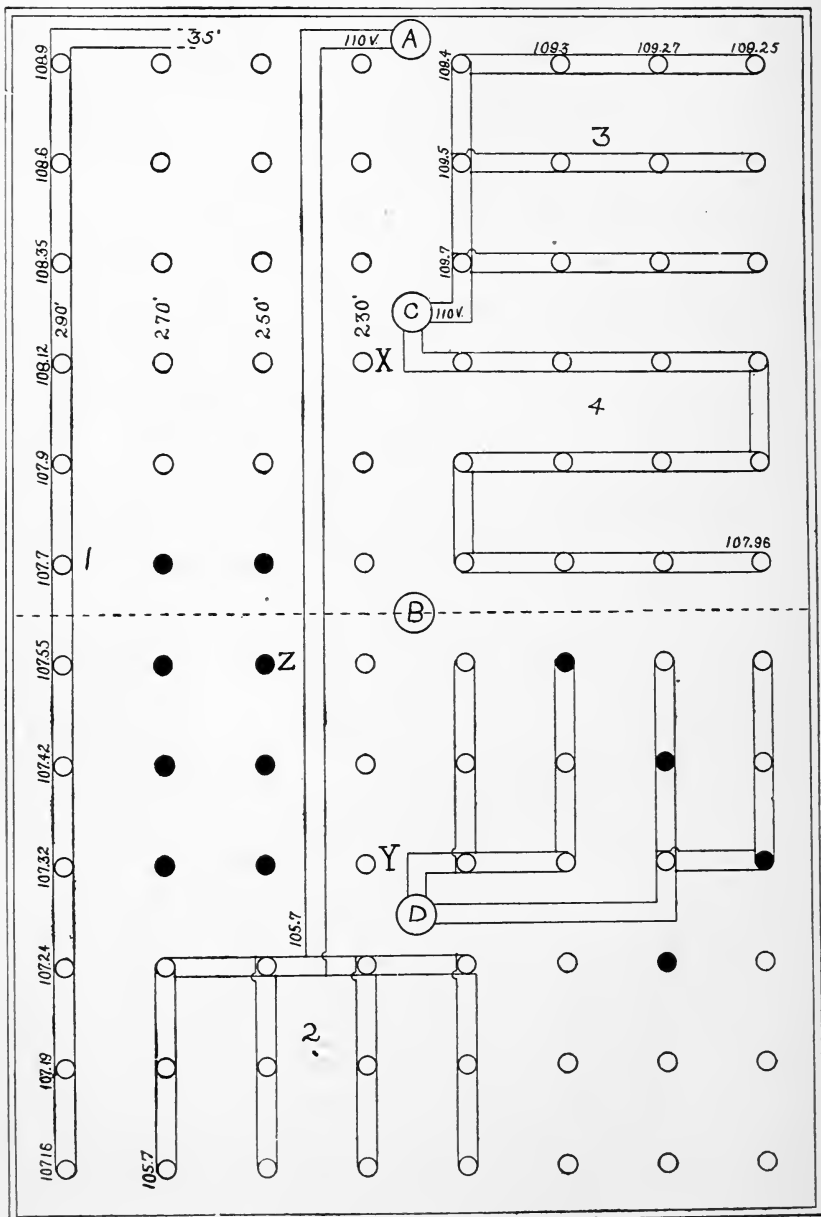

Figure 20

by one-half or (which amounts to the same thing in wire), the number of lights per circuit be limited to eight. If we run all branch circuits from A, we shall need a total of 2,760 feet. It will require just as much wire to run the 64 lights below X as was required to run the whole 96 before; viz.: 2,080 feet; to this must be added the wire necessary to run the four circuits above which is 680 feet. By extending our mains to the point X, we can save eight runs of wire each equal in length to the distance between A and X. X is the point of extreme economy as regards branch wires and nothing can be gained in this respect by extending the mains any further unless several cutout centers are decided upon as before explained. Whether it be more economical to extend the mains to X, or run branch circuits from A, depends upon the relative cost, in this instance, of 30 feet of mains and 480 feet of branch wires.

With an uneven distribution of lights as indicated by the black circles, each of which may be taken as an arc lamp or cluster of incandescent lamps, the most economical location of cutouts will be at Z. To move them farther to the right would shorten the wires of five circuits and lengthen them on eight; to move either up or down in the group of eight would also lengthen more wires than it would shorten.

In laying out circuits for electric lights, however, we must not take into consideration the cost of wire only. In many cases the loss in voltage is of far greater importance, not only because it means a steady waste of power, but also because of unsatisfactory illumination, lamps in different parts of a circuit not being of the same candle power, or the light in one place varying greatly when lights in another place are turned on or off.

Some idea of the variation in voltage in different parts of differently arranged circuits can be obtained from Figure 20. The length of wire in circuit 1 is 35 feet to the first lamp and

10 feet from this to the next, etc. The voltage at the cut-out A is 110 and at each lamp is given the actual voltage existing at that point with all lamps burning. The wire of the circuit is No. 14 and with 55 watt lamps, the loss to the last lamp over a run of 145 feet is a trifle over two and one-half per cent when all lamps are burning.

Circuit No. 2 is figured as of the same length as No. 1, and supplies the same number of lamps, but at a much greater loss, slightly over four per cent to the last lamp. Circuits 3 and 4 feeding from C contain equal lengths of wire, but there is quite a difference in loss; in 3 only .75 of one volt, while in 4 it is a little over two volts. From study of Figure 20 we may learn that the arrangement of circuit 1 is fairly satisfactory especially if the nature of the work done under it is such that only part of the lamps are used at the same time. Circuit No. 2 is bad if all lights are used at once, and it should be wired with No. 10 or 12 wire. Whenever the location of lights is such as to allow a circuit like No. 3 to be run, the loss can be kept very low with a minimum of wire. In general the more cutout centers there are established in proportion to the number of lights, if mains are properly arranged, the less will be the loss in pressure and the more satisfactory the service.

NOTICE.—DO NOT FAIL TO SEE WHETHER ANY RULE OR ORDINANCE OF YOUR CITY CONFLICTS WITH THESE RULES.

CLASS A.

STATIONS AND DYNAMO ROOMS.

Includes Central Stations, Dynamo, Motor and Storage-Battery Rooms, Transformer Substations, Etc.

1. Generators.

a. Must be located in a dry place.

It is recommended that water-proof covers be provided, which may be used in case of emergency.

Perfect insulation in electrical apparatus requires that the material used for insulation be kept dry. While in the construction of generators the greatest care is taken that all current carrying parts are well insulated, still, if moisture is allowed to settle on the insulation, trouble is almost sure to occur. For this reason a generator should never be installed where it will be exposed to steam or damp air or in any place where through accident water may be thrown against it. A location under steam or water pipes or close to an outside window should be avoided.

b. Must never be placed in a room where any hazardous process is carried on, nor in places where they would be exposed to inflammable gases or flyings of combustible materials.

In even the best constructed dynamos there is always more or less sparking at the brushes and small pieces of hot carbon

are sometimes thrown off. As a general rule in buildings where there is considerable dust, such as in wood-working plants, grain elevators and the like, the dynamo is located in the engine room, which is generally isolated from the dusty part of the building.

c. Must, when operating at a potential in excess of 550 volts, have their base frames permanently and effectively grounded.

Must, when operating at a potential of 550 volts or less, be thoroughly insulated from the ground wherever feasible. Wooden base frames used for this purpose, and wooden floors which are depended upon for insulation where, for any reason, it is necessary to omit the base-frames, must be kept filled to prevent absorption of moisture, and must be kept clean and dry.

Where frame insulation is impracticable, the Inspection Department having jurisdiction may, in writing, permit its omission, in which case the frame must be permanently and effectively grounded.

A high potential machine should be surrounded by an insulated platform. This may be made of wood, mounted on insulating supports, and so arranged that a man must always stand upon it in order to touch any part of the machine.

In case of a machine having an insulated frame, if there is trouble from static electricity due to belt friction, it should be overcome by placing near the belt a metallic comb connected with the earth, or by grounding the frame through a resistance of not less than 300,000 ohms.

The smaller generators are usually insulated on wooden base frames. A base frame suitable for this work is shown in Figure 21. Almost any kind of wood, well varnished, is very good for this purpose. The base frame is screwed to the floor or foundation and the slide rail (which is used where the dynamo is belted to the engine to allow the tightening and slackening of the belt) is independently attached to it, that is, the same bolt must not be used to hold the slide rail to the base frame and the base frame to the floor, as this would be liable to ground the frame. The direct connected machines

(dynamo and engine on same bed plate) are often insulated by the use of mica washers and bushings surrounding the bolts which fasten the dynamo to the bed plate and by using

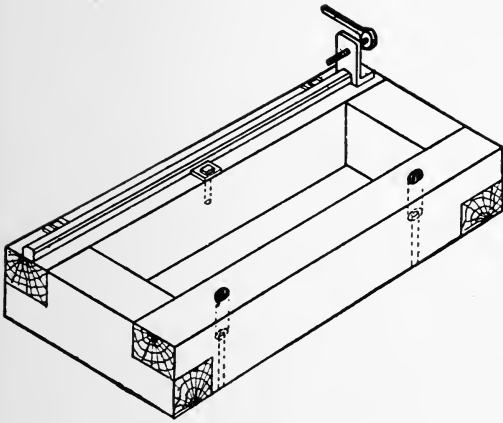

Figure 21.

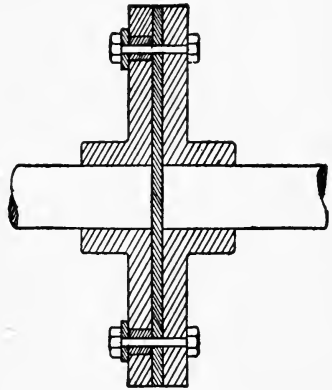

Figure 22.

an insulated flange coupling between the shaft of the dynamo and that of the engine. Figure 22 shows a section of a flange coupling insulated in this way, the heavily shaded parts representing the insulating material.

The larger machines, which on account of their weight cannot be insulated, must be permanently and effectually grounded. Where the engine and dynamo are direct connected a very good ground is obtained through the engine connections. Where belts are used a good ground can be obtained by fastening a copper wire under one of the bolts on the dynamo and connecting the other end of the wire to available water pipes. In the case of high tension machines, especially series arc, the machine should always be surrounded by an insulated platform so arranged that a man must stand on it in order to touch any part of the machine, either live parts or

frame, and in handling such a machine only one hand at a time should be used. A hardwood platform mounted on insulators will serve very well for this purpose or suitable platforms may be obtained from dealers in electrical supplies.

Figure 23 shows a metallic comb such as is occasionally used to overcome the static electricity due to the friction of the belt. A strip of metal, one end of which is cut with a

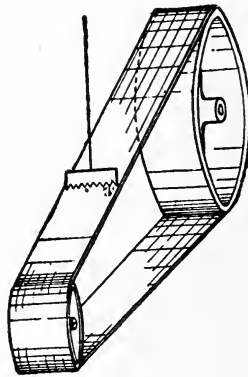

Figure 23.

number of projecting points, is suspended crosswise a short distance above the belt. A wire connects this plate to any suitable ground.

A resistance for grounding the generator frame in accordance with this rule is constructed of ground glass equipped with two metal terminals separated a short distance and connected by means of a lead pencil mark. One terminal is connected to the frame of the machine and the other to the ground.

d. Constant potential generators, except alternating current machines and their exciters, must be protected from excessive current by safety fuses or equivalent devices of *approved* design.

For two-wire, direct-current generators, single pole protection will be considered as satisfying the above rule, pro-

vided the safety device is located in the lead not connected to the series winding. When supplying three-wire systems, the generators should be so arranged that these protective devices will come in the outside leads.

For three-wire, direct-current generators, a safety device must be placed in each armature, direct-current lead, or a double pole, double trip circuit breaker in each outside generator lead and corresponding equalizer connection.

In general, generators should preferably have no exposed live parts and the leads should be well insulated and thoroughly protected against mechanical injury. This protection of the bare live parts against accidental contact would apply also to any exposed, uninsulated conductors outside the generator and not on the switchboard unless their potential is practically that of the ground.

Where the needs of the service make the above requirements impracticable, the Inspection Department having jurisdiction may, in writing, modify them.

Constant potential generators are designed to carry a certain amount of current without seriously overheating. If any considerable overload is put on a machine of this type a dangerous rise in the temperature of the generator and the wires connected to it will occur and a fire may result. To protect the apparatus some safety device must be installed in the main circuit which will cut off the current when it exceeds its normal maximum value. The safety fuse is commonly used for this purpose, but circuit breakers of approved design meet the requirements of the rule and may be used in place of the fuses.

Alternating current generators are usually constructed in large units. If a safety device installed in the main circuit of one of these large machines should operate and open the circuit, the generating apparatus, dynamo and engine would momentarily be left in a dangerous condition owing to the fact of the load being suddenly removed from the generator.

The sudden disrupting of the circuit of an alternating current generator gives rise to a momentary, excessive increase in the E. M. F., and as this is usually already very high

there is great tendency to pierce the insulation of the generator winding.

In view of these facts, and for the further reason that on short circuit the impedance of an alternating current armature consisting of many coils in series is generally of such an amount as to limit the resultant current, alternating current generators are excepted from the general rule requiring protection by safety devices. While the rule does not require protective devices in any alternating current generator, still it is the general practice, and it is advisable, to provide fuses or circuit breakers on the smaller size generators such as are used in isolated plants for instance.

Fuses are sometimes mounted on the generator itself, but the general practice at the present time is to mount all fuses on the switchboard. For two-wire, direct current generators

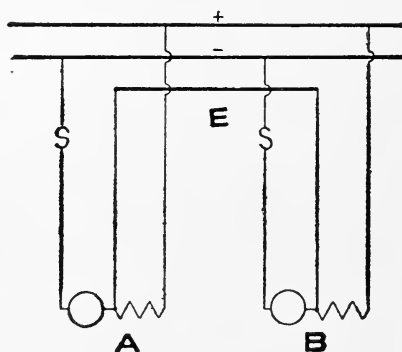

Figure 24.

one fuse will suffice, provided this fuse is located in the lead which is not connected to the series winding. The diagram Figure 24 shows the proper location of the fuses. An inspection of this diagram will also show the reason for this requirement. Two compound wound generators are shown con-

nected in parallel. To avoid confusion the shunt field and switch connections are not shown. When the generators are operating together current from the brush on the right-hand side of machine A has two paths by means of which it can get to the positive bus bar. One of these paths is through its own series field and the other through the equalizer connection and series field of generator B. The current in the lead connected to the series field may not be of as great strength as that generated in the armature; or, due to the fact that it may be receiving additional current from the other machine through the equalizer connection, it may be of greater strength than that generated in the armature. A fuse placed in this lead could not, therefore, provide proper protection for the armature.

Where a shunt wound generator is used the fuse may be placed in either lead. The same is true in the case of a single, compound wound generator, for no equalizer connection is used in this case, and the current in both leads is always the same.

Where generators are feeding a three-wire system the fuses

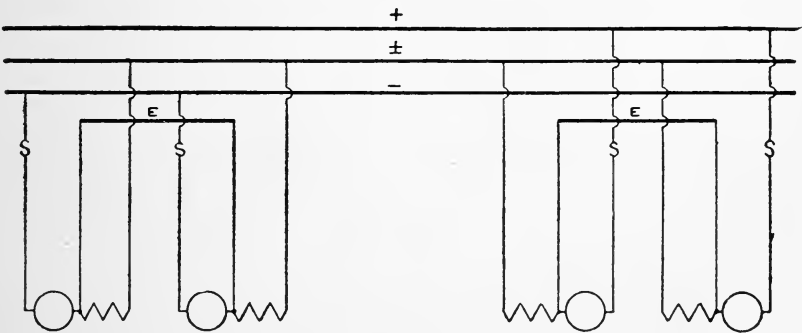

Figure 25.

should be placed in those leads which feed into the positive and negative mains, Figure 25. They should not be placed in

the equalizer lead or in the lead connected to the series field for the reasons already given. It will be noticed that the two generators shown at the right of the diagram are connected in a reverse manner from those at the left. An examination of the diagram, Figure 26, will show the reason for

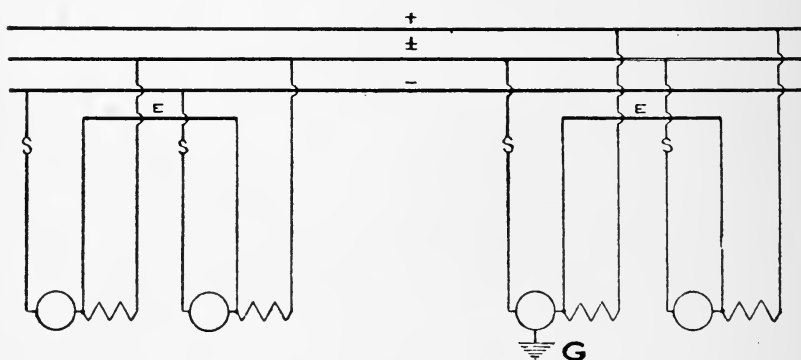

Figure 26.

this. In this case the placing of the fuse in the lead not affected by the equalizer current brings it in the lead connected to the neutral bus. If, with the fuse located in this line, the generator winding should become grounded a short circuit would result, as the neutral wire is always grounded, current flowing from the positive bus bar through the positive lead and the wires on the generator to the ground. The generator would have absolutely no protection in a case of this kind and a fire would be sure to result. If the fuses were placed in the outside leads the circuits would be immediately opened and current shut off from the machine.

Figures 27, 28 and 29 show the proper location of fuses in three-wire, direct current generator installations. In Figure 27 is shown the wiring connection of a three-wire direct current generator. The armature of this generator contains

two separate armature windings, each winding being provided with its own commutator, located on each side of the armature. Two separate series field windings are provided, each

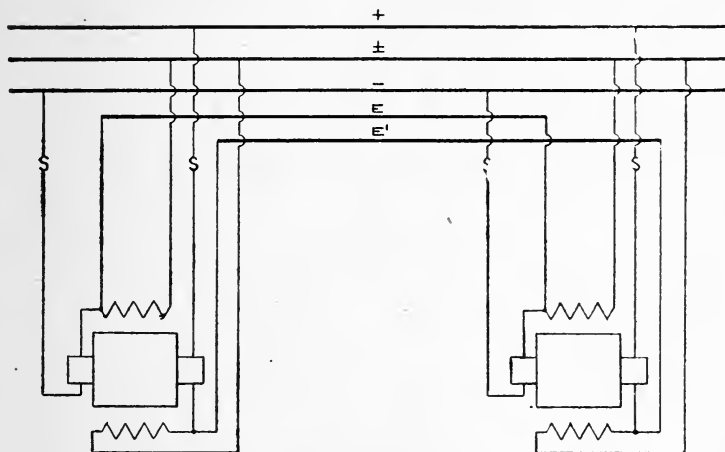

Figure 27.

field winding being connected in series with an armature winding. The shunt field connections are not shown.

To comply with the requirements each generator should be connected to the bus bars and fuses installed as shown. The simplified diagram, Figure 30, shows in a plainer manner the reason for this arrangement. Referring to the connections shown it will be seen that the fuses protect each armature winding both from overload or from possible shorts caused by the grounding of the armature windings. A wrong arrangement of the fuses, and one that should be avoided, is shown in the diagram, Figure 31. In this case fuses are installed in the lead from the series winding. The first objection to this arrangement is the one which has already been explained, *i. e.*, the current from the armature having two paths open to it, one through the series field and one through

the equalizer, the armature could generate an excessive current without the fuse, which may be carrying only a part of the current, blowing. If for any reason one of the fuses shown did blow serious conditions might result owing to the fact that the armature of that machine is still connected to the armatures of all the remaining machines through the equalizer bus. A double-pole circuit breaker so arranged as to open both the series field lead and the equalizer lead would remove this objection, but, as the circuit breaker would be actuated by the current in the series field lead the objections before

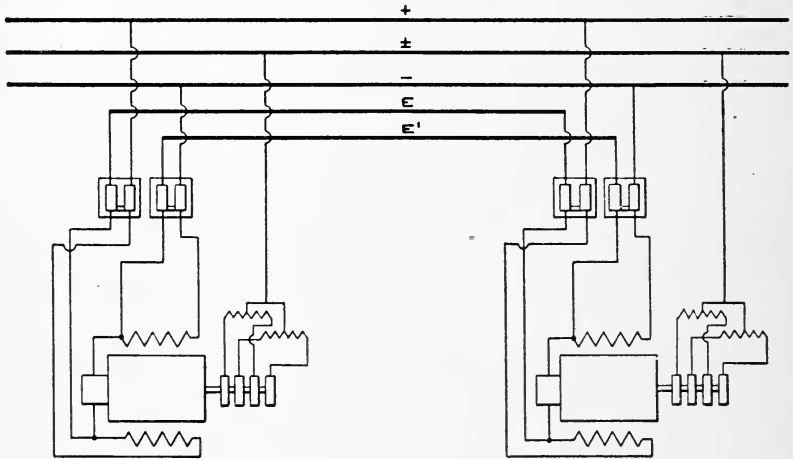

Figure 28.

stated still exist. Locating the fuse in the armature lead connected to the neutral bus would leave the generator unprotected in case of grounds.

Figure 28 shows the connections of the Westinghouse direct current, three-wire generator. In this generator direct current at the potential of the outside mains, usually 220 volts, is taken off the commutator side while the neutral connection is made through auto transformers to slip rings on the opposite

side of the armature shaft. Two separate series field windings are connected in series with each direct current armature lead. In order to place a fuse in each direct current armature lead, fuses would have to be mounted on the generator itself or the leads would have to be carried from the armature brushes to the switchboard and back to the series field. The usual protection provided with this generator consists of double-pole, double-trip circuit breakers connected in the leads from the series fields and corresponding equalizer connection, this circuit breaker being actuated by the current in the lead from the series field and arranged to open both series field and equalizer leads. As this generator is designed to withstand only a 25 per cent overload the circuit breakers should be interconnected so that in case one generator lead opens it automatically opens the remaining lead.

Figure 29 shows the wiring connections of a compensator

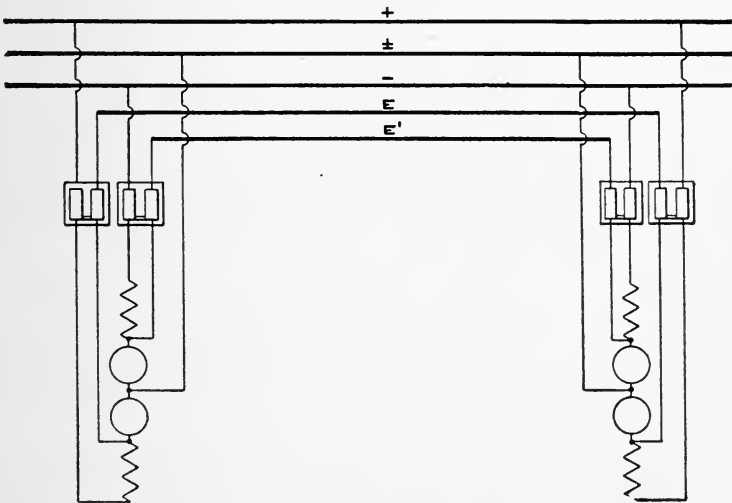

Figure 29.

set. This set consists of two machines, the armature shafts of which are rigidly connected together. Each machine acts as

a motor or generator, depending on the condition of unbalance; and they are used only to balance the system, other generators supplying current to the outside mains.

This class of apparatus is protected in the same manner as in the case just described. A double-pole, double-trip circuit breaker should be installed in each outside lead and cor-

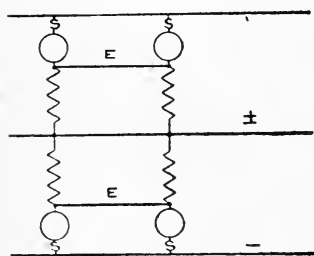

Figure 30.

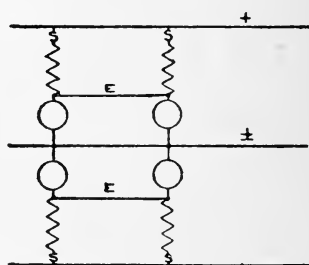

Figure 31.

responding equalizer lead. It might be well to state that with apparatus designed on the principle just described various details of construction of the machines, as built by the different manufacturers, require a more complicated system of protection so that the above rule is not always exactly complied with.

Circuit breakers, when used for protection in dynamo leads, are generally mounted on the switchboard and connected in the circuit ahead of the main switch. The circuit breaker as at present constructed is, in nearly all cases, a much more efficient and reliable device than the fuse, and its use is to be recommended. The fusing point of an ordinary fuse depends on the temperature of the fuse metal. When fuses are used in an engine room where the temperature is often very high the fuse may blow when it is carrying a current very much less than its rated capacity, and this will generally result in a larger fuse being installed. The circuit

breaker is not affected by this increase in temperature. When a fuse blows from overload it generally occurs at a time when all the apparatus is in use and serious delays are apt to result before the fuse can be replaced. This objection does not exist where the circuit breaker is used.

As to the relative currents at which the fuse and circuit breaker should be set to operate, authorities differ. Some advise that both be set to operate at the same current strength so that the fuse, which takes a longer time to operate, will blow only in case the circuit breaker fails. Another recommends that the fuses be of such capacity as to carry any load which will be required of them and to set the circuit breaker a little higher than the fuses so that the fuses will operate on overload and the circuit breaker on short circuit. The practice of setting the fuses at about 25 per cent above the circuit breaker seems to be preferred, for it frequently happens, when both are set to operate at the same current strength, the fuse alone will "blow," due to the excessive heat produced in the fuse at full load.

There is a tendency in the design of some of the newer generators to do away with binding posts, leads properly bushed through the generator frame and arranged for direct connection to leads from switchboard being provided instead. As this does away with exposed, live parts it is to be recommended. Where there are exposed live parts on the generator or its connections they should be protected from accidental contact, except where they are at the same potential as the ground, as in the case of the neutrals on the direct current three-wire systems and the ground return on trolley systems.

Cases are sometimes found where the cessation of current due to the blowing of a fuse could cause more damage than would result from an overload, as, for instance, where the

dynamo operates some safety device. In cases of this kind the Inspection Department having jurisdiction may modify the requirements.

c. Must each be provided with a name-plate, giving the maker's name, the capacity in volts and amperes, and the normal speed in revolutions per minute.

f. Terminal blocks when used on generators must be made of *approved* non-combustible, non-absorptive insulating material, such as slate, marble or porcelain.

2. Conductors.

From generators to switchboards, rheostats or other instruments, and thence to outside lines.

a. Must be in plain sight or readily accessible.

Wires from generator to switchboard may, however, be placed in a conduit in the brick or cement pier on which the generator stands, provided that proper precautions are taken to protect them against moisture and to thoroughly insulate them from the pier. If lead-covered cable is used, no further protection will be required, but it should not be allowed to rest upon sharp edges which in time might cut into the lead sheath, especially if the cables were liable to vibration. A smooth runaway is desired. If iron conduit is provided, double braided rubber-covered wire (see No. 47) will be satisfactory.

b. Must have an *approved* insulating covering as called for by rules in Class "C" for similar work, except that in central stations, on exposed circuits, the wire which is used must have a heavy braided, non-combustible outer covering.

Bus bars may be made of bare metal.

Rubber insulations ignite easily and burn freely. Where a number of wires are brought close together, as is generally the case in dynamo rooms, especially about the switchboard, it is therefore necessary to surround this inflammable material with a tight, non-combustible outer cover. If this is not done, a fire once started at this point would spread rapidly along the wires, producing intense heat and a dense smoke. Where the wires have such a covering and are well insulated and supported, using only non-combustible materials, it is believed that no appreciable fire hazard exists, even with a large group of wires.

Flame proofing should be stripped back on all cables a sufficient amount to give the necessary insulation distances for the voltage of the circuit on which the cable is used. The stripping back of the flame proofing is necessary on account

of the poor insulating qualities of the flame proofing material now available. Flame proofing may be omitted where satisfactory fire proofing is accomplished by other means, such as compartments, etc.

c. Must be kept so rigidly in place that they cannot come in contact.

d. Must in all other respects be installed with the same precautions as required by rules in Class "C" for wires carrying a current of the same volume and potential.

e. In wiring switchboards, the ground detector, voltmeter, pilot lights and potential transformers must be connected to a circuit of not less than No. 14 B. & S. gage wire that is protected by an *approved* fuse, this circuit is not to carry over 660 watts.

For the protection of instruments and pilot lights on switchboards, *approved* N. E. Code Standard Enclosed Fuses are preferred, but *approved* enclosed fuses of other designs of *not over two (2) amperes capacity* may be used.

Voltmeter switches having concealed connections must be plainly marked, showing connections made.

A number of different methods are used for running wires in dynamo rooms. Where the dynamo is located in a room with a low ceiling, or where it is not desirable to run the wires open, metal conduits may be imbedded in the floor and the wires run in them. If the engine room is located in the basement or in any place where water or moisture is liable to gather in the conduits the wires should be lead covered. At outlets the conduits should be carried some distance above the floor level and close to the frame of the machine, where they will be protected from mechanical injury. If the space under the machine will allow it, the conduit should be ended there where it will be protected by the base frame. Where lead covered wires are used, the lead should be cut back some distance from the exposed part of the wire and the end of the lead should be well taped and compounded so that no moisture can creep in between the lead and the insulation.

In place of the metal conduits tile ducts can be used; or, if the floor is of cement, a channel may be left in the floor

and the wires run into it. A removable iron cover should be provided.

The wires may be run open on knobs or cleats as described in Class C. Where there are many wires, cable racks, constructed of wood or preferably iron, having cleats bolted to them, may be used. As a general rule moulding should not be used for this class of work. Especially in central stations the generators are often called upon for a very heavy overload and should the wires become overheated a fire is much more apt to result when the leads are run in moulding than if they were run open where any trouble could be immediately noticed.

3. Switchboards.

a. Must be so placed as to reduce to a minimum the danger of communicating fire to adjacent combustible material.

Special attention is called to the fact that switchboards should not be built down to the floor, nor up to the ceiling. A space of at least ten or twelve inches should be left between the floor and the board, except when the floor about the switchboard is of concrete or other fireproof construction, and a space of three feet, if possible, between the ceiling and the board, in order to prevent fire from communicating from the switchboard to the floor or ceiling, and also to prevent the forming of a partially concealed space very liable to be used for storage of rubbish and oily waste.

b. Must be made of non-combustible material or of hardwood in skeleton form, filled to prevent absorption of moisture.

If wood is used all wires and all current-carrying parts of the apparatus on the switchboard must be separated therefrom by non-combustible, non-absorptive insulating material.

c. Must be accessible from all sides when the connections are on the back, but may be placed against a brick or stone wall when the wiring is entirely on the face.

If the wiring is on the back, there should be a clear space of at least 18 inches between the wall and the apparatus on the board, and even if the wiring is entirely on the face it is much better to have the board set out from the wall. The space back of the board should not be closed in, except by grating or netting either at the sides, top or bottom, as such an enclosure is almost sure to be used as a closet for clothing

or for the storage of oil cans, rubbish, etc. An open space is much more likely to be kept clean, and is more convenient for making repairs, examinations, etc.

d. Must be kept free from moisture.

e. On switchboards the distances between bare live parts

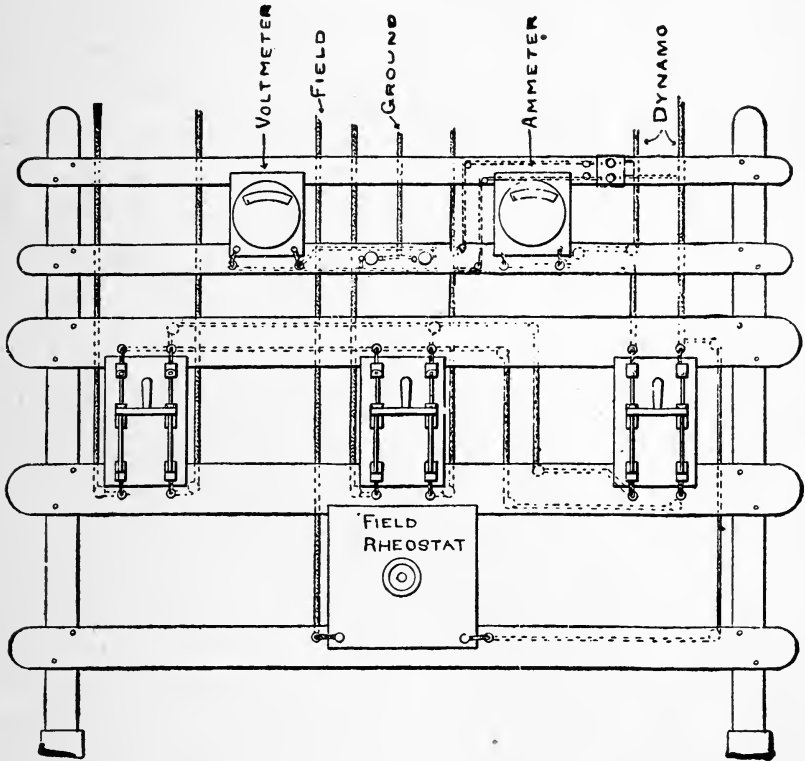

Figure 32.

of opposite polarity must be made as great as practicable, and must not be less than those given for tablet-boards (see No. 53 A).

The switchboard may be located in any suitable place in the dynamo room. It should generally be placed in a central position as close as possible, without inconvenience, to all machines and perfectly accessible. Do not locate a switch-

board under or near a steam or water pipe or too close to windows, as these may accidentally be the means of wetting the board.

The material generally used for the construction of switchboards is slate or marble, free from metallic veins. If metallic veins are not guarded against they may cause great leakage of current, which will manifest itself in heating the slate or marble.

The switchboard may be made of hardwood in skeleton form (see Figure 32), but in this case all switches, cutouts, instruments, etc., must be mounted on non-combustible, non-absorptive insulating bases, such as slate or marble and all wires must be properly bushed where they pass through the woodwork and must be supported on cleats or knobs. Wood base instruments are not approved.

Marble or slate boards are usually set in angle iron frames and are much safer and better than the skeleton board shown. It is a good plan to have the iron legs rest on a wooden base, so that they will be insulated from the ground.

Although only 18 inches clear space is required back of the board, where the board is back connected, this should be increased wherever possible, especially in the case of large boards.

4. Resistance Boxes and Equalizers.

(For construction rules, see No. 60.)

a. Must be placed on a switchboard or, if not thereon, at a distance of at least a foot from combustible material, or separated therefrom by a non-inflammable, non-absorptive insulating material such as slate or marble.

This will require the use of a slab or panel of non-combustible, non-absorptive insulating material such as slate or marble, somewhat larger than the rheostat, which shall be secured in position independently of the rheostat supports. Bolts for supporting the rheostat shall be countersunk at least $\frac{1}{8}$ inch below the surface at the back of the slab and

filled. For proper mechanical strength, slab should be of a thickness consistent with the size and weight of the rheostat, and in no case to be less than $\frac{1}{2}$ inch.

If resistance devices are installed in rooms where dust or combustible flyings would be liable to accumulate on them, they should be equipped with a dust-proof face plate.

Ordinarily the dynamo field rheostat is mounted on the back of the board if the board is back connected, a small hand wheel being provided so that the rheostat may be operated from the front of the board. If the switchboard is in skeleton form, or if the rheostat is placed on a wall, it should be mounted on a solid piece of slate or marble. Separate screws should be used for attaching the rheostat to the slate

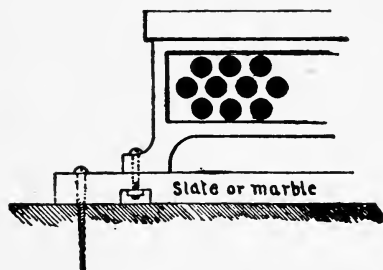

Figure 33.

or marble and the slate or marble to the wall, for, if the same screws were used for this purpose, they would be apt to ground the rheostat frame. (See Figure 33.)

On central stations where current is furnished over a large area, there is on some of the circuits, especially the long ones, a considerable "drop," or loss of potential. In order to keep the voltage at the point of supply on these circuits at the proper value, the voltage at the station must be raised. This in turn causes the voltage on those circuits near the dynamo to become excessive. Equalizers, which are large resistance boxes generally constructed of iron wire or strips, and capable of carrying a heavy current, are connected in the circuits and adjusted at such resistances as to make the voltage at the various points of supply uniform. They are generally too heavy to mount on the board, but should be raised on non-combustible, non-absorptive insulating supports and should be separated from all inflammable material.

b. Where protective resistances are necessary in connection with automatic rheostats, incandescent lamps may be used, provided that they do not carry or control the main current or constitute the regulating resistance of the device.

When so used, lamps must be mounted in porcelain receptacles upon non-combustible supports, and must be so arranged that they cannot have impressed upon them a voltage greater than that for which they are rated. They must in all cases be provided with a name-plate, which shall be permanently attached beside the porcelain receptacle or receptacles and stamped with the candle-power and voltage of the lamp or lamps to be used in each receptacle.

c. Wherever insulated wire is used for connection between resistances and the contact plate of a rheostat, the insulation must be slow burning (see No. 43). For large field rheostats and similar resistances, where the contact plates are not mounted upon them, the connecting wires may be run together in groups so arranged that the maximum difference of potential between any two wires in a group shall not exceed 75 volts. Each group of wires must either be mounted on non-combustible, non-absorptive insulators giving at least $\frac{1}{2}$ inch separation from surface wired over, or, where it is necessary to protect the wires from mechanical injury or moisture, be run in *approved* lined conduit or equivalent.

5. Lightning Arresters.

(For construction rules, see No. 63.)

a. Must be attached to each wire of every overhead circuit connected with the station.

It is recommended to all electric light and power companies that arresters be connected at intervals over systems in such numbers and so located as to prevent ordinary discharges entering (over the wires) buildings connected to the lines.

b. Must be located in readily accessible places away from combustible materials, and as near as practicable to the point where the wires enter the building.

In all cases, kinks, coils and sharp bends in the wires between the arresters and the outdoor lines must be avoided as far as possible.

The switchboard does not necessarily afford the only location meeting these requirements. In fact, if the arresters

can be located in a safe and accessible place away from the board, this should be done, for in case the arrester should fail or be seriously damaged there would then be less chance of starting arcs on the board.

c. Must be connected with a thoroughly good and permanent ground connection by metallic strips or wires having a conductivity not less than that of a No. 6 B. & S. gage copper wire, which must be run as nearly in a straight line as possible from the arresters to the ground connection.

Ground wires for lightning arresters must not be attached to gas pipes within the buildings.

It is often desirable to introduce a choke coil in circuit between the arresters and the dynamo. In no case should the ground wires from the lightning arresters be put into iron pipes, as these would tend to impede the discharge.

d. All choke coils or other attachments, inherent to the lightning protection equipment, shall have an insulation from the ground or other conductors equal at least to the insulation demanded at other points of the circuit in the station.

A lightning discharge is simply a discharge of electricity at very high potential. While the insulation of the ordinary wire

serves very well for the voltages for which it is used it offers very little resistance to a current of such high potential, and providing the discharge can reach the ground by jumping through the insulation it will generally take that course unless some easier path is offered to it. A lightning arrester in its simplest form consists of two metal plates separated by a small air space as shown in Figure 34. One of the plates is connected to the line and the other to the ground, a set being provided for each line wire to be protected.

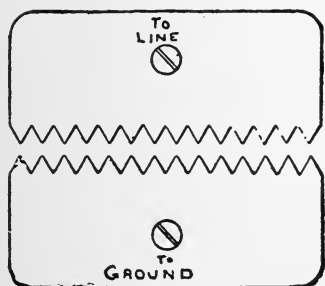

Fig. 34.

The air space between the metal plates offers a much lower

resistance to a lightning discharge than the insulation of the ordinary wire.

resistance to the passage of such a sudden current as a discharge of lightning consists of, than do the magnets of a dynamo, for instance, or highly insulated parts of the line. The current, therefore, jumps the air space and passes to ground. When the current jumps this air space it produces an arc similar to that seen in an arc lamp, and after the lightning discharge is over the dynamo current is very likely to maintain this arc and thus cause a short circuit from one lightning arrester through the ground to the other. Different methods of preventing this by interrupting the arc have been devised.

Figure 35 shows the T. H. lightning arrester, in which the arc is extinguished by a magnetic field set up by the electro-magnet. In the Wurts non-arcing lightning arrester (Figure 36) the discharge takes place across the air gaps between the cylinders; these are made of a metal which will not arc.

A choke coil is simply a coil of wire, the size of wire and the number of turns depending upon the normal current and voltage of the system on which it is used. On 500 volt street railway circuits the choke coil sometimes consists of a spiral of five or six turns of heavy copper rod, while on high potential, alternating current circuits a greater number of turns and smaller wire is used. As every coil of wire has a certain amount of inductance, or, in other words, tends to hold back any change in the E. M. F., the placing of a coil in the circuit between the lightning arrester and the apparatus on which the current is used affords a protection to the apparatus and forces the lightning discharge to pass to the ground through the lightning arrester.

As the lightning arrester and choke coil are subjected to extremely high potentials they should be carefully insulated and properly located.

6. Care and Attendance.

a. A competent man must be kept on duty where generators are operating.

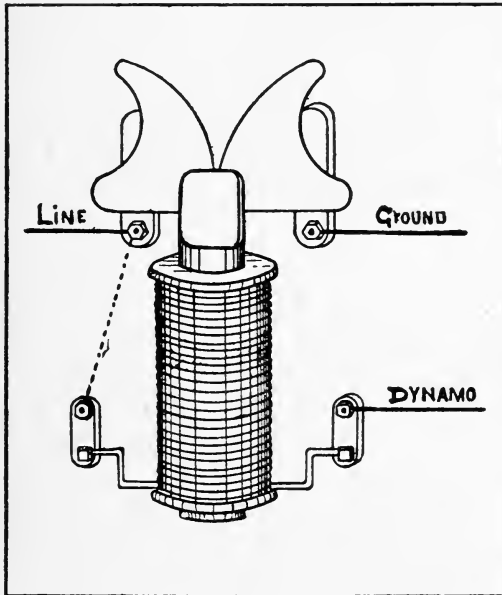

Figure 35.

b. Oily waste must be kept in *approved* metal cans and removed daily.

Approved waste cans shall be made of metal, with legs raising can 3 inches from the floor and with self-closing covers.

7. Testing of Insulation Resistance.

a. All circuits except such as are permanently grounded in accordance with Rule 13 A must be provided with reliable ground detectors. Detectors which indicate continuously and give an instant and permanent indication of a ground are preferable. Ground wires from detectors must not be attached to gas pipes within the building.

b. Where continuously indicating detectors are not feasi-

ble the circuits should be tested at least once per day, and preferably oftener.

c. Data obtained from all tests must be preserved for ex-

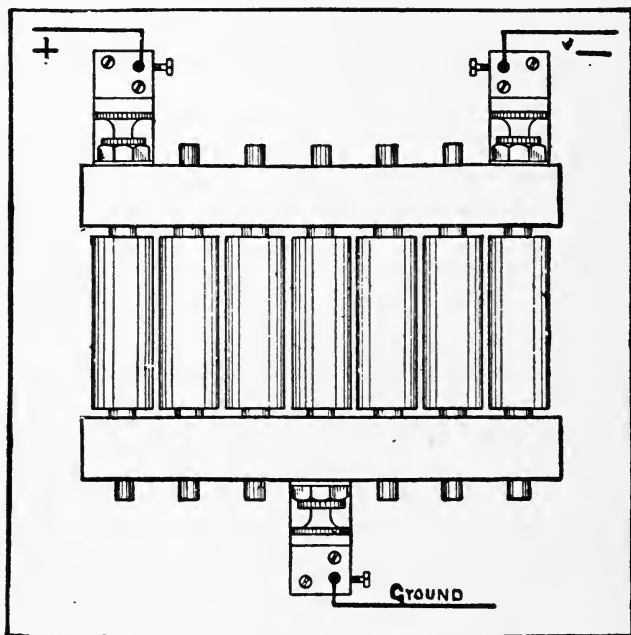

Figure 36.

amination by the Inspection Department having jurisdiction.

These rules on testing to be applied to such places as may be designated by the Inspection Department having jurisdiction.

The exceptions to this rule are 3-wire direct current systems where the neutral is grounded and 2 and 3 wire alternating current secondaries where the neutral or one side is grounded.

In every installation of electric wiring there is a certain "leak" of current. This leak is partly between the wires and the ground and between the wires themselves. The amount of leak varies, but is always dependent on the insulation resist-

ance. Where a small amount of wire is well installed the leak should be very small, but in the case of large installations or where the wiring has been poorly done the flow of current to ground or between the wires of opposite polarity may become quite large. Wires lying on pipes or on damp woodwork, crossed wires or live parts of apparatus mounted on wooden blocks, all tend to cut down the insulation resistance and increase the leak. The effects of poor insulation are: First, it represents a useless loss of current, and, second, and more important, it means a possible cause of fire.

The simplest way to determine the insulation resistance of a circuit is by means of a voltmeter. In Figure 37 if a voltmeter of known resistance is connected between one side of the circuit and the ground and there is a ground on the other side of the circuit, say at X, current will flow from the positive wire through the voltmeter, then through the ground at X to the negative side of the circuit. The voltmeter needle will indicate a certain reading which we will call V^1 . If the voltmeter is now connected directly across the circuit we get the circuit voltage, which we will call V . The two readings, V^1 , and V , are to each other as the resistance of the voltmeter is to the combined resistance of the voltmeter and the ground at X; or, calling the resistance of the voltmeter R and the resistance of the ground at X r , we get

$$\frac{V^1}{V} = \frac{R}{R + r}, \text{ or } r = R \frac{V - V^1}{V^1}.$$

As an example: On a certain system the voltage across the mains is 110, while with the voltmeter connected as shown in Figure 37 we obtain a reading of 38. The resistance of the voltmeter is 10,500 ohms. Supplying the numbers in the for-

mula, $r = 10,500 \times \frac{110-38}{38} = 28,000$ ohms as the resistance to ground the negative side of the system. If the voltmeter is

connected to ground from the other side, or — main, the resistance to ground of the + side can be obtained.

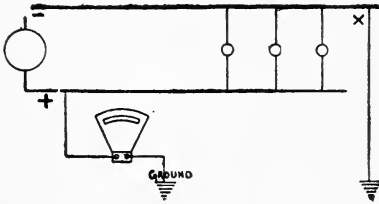

Figure 37.

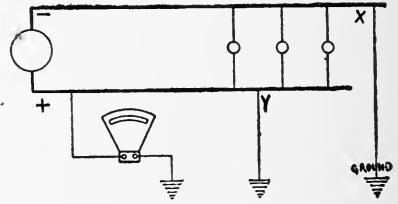

Figure 38.

If both sides of the system are grounded as at x and y, Figure 38, the voltmeter will be robbed of part of the current which would pass through it if Y were not in parallel with it. It will therefore not indicate correctly under such circumstances.

If, however, tests are frequently made and defects cleared up at once when noticed it will seldom happen that two grounds occur on the system at the same time. An engineer or dynamo tender will soon learn what the insulation resistance of the plant in his charge should be and be governed accordingly.

A diagram of a direct current ground detector switch is shown in Figure 39. By throwing switch A down the — bus bar is connected to the ground through the voltmeter and by throwing switch B the + bar is connected to ground through the voltmeter. The ground wire should be run to a water or steam pipe

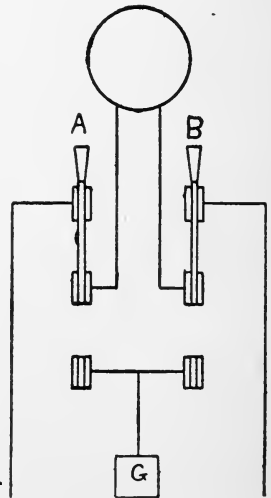

Fig. 39.

(never to a gas pipe) or to some grounded part of the building. If no good ground is obtainable one may be made as described under 13 A.

8. Motors.

The use of motors operating at a potential in excess of 550 volts will only be approved when every practicable safeguard has been provided. Plans for such installations should be submitted to the Inspection Department having jurisdiction before any work is begun.

a. Must, when operating at a potential in excess of 550 volts, have no exposed live metal parts and have their base frames permanently and effectively grounded.

Motors operating at a potential of 550 volts or less must be thoroughly insulated from the ground wherever feasible. Wooden base frames used for this purpose, and wooden floors, which are depended upon for insulation where, for any reason, it is necessary to omit the base frames, must be kept filled to prevent absorption of moisture, and must be kept clean and dry. Where frame insulation is impracticable, the Inspection Department having jurisdiction may, in writing, permit its omission, in which case the frame must be permanently and effectively grounded.

A high-potential machine should be surrounded with an insulated platform. This may be made of wood, mounted on insulating supports, and so arranged that a man must stand upon it in order to touch any part of the machine.

In case of a machine having an insulated frame, if there is trouble from static electricity due to belt friction, it should be overcome by placing near the belt a metallic comb connected to the earth, or by grounding the frame through a resistance of not less than 300,000 ohms.

Where motors with grounded frames are operated on systems where one side is either purposely or accidentally grounded there exists a certain difference of potential between the windings and the motor frame, this difference of potential depending on the part of the circuit considered. At some places in the winding it will be the full difference of potential at which the motor is operating and at other points

practically nothing. Should the conductors accidentally come in contact or "ground" on the motor frame a short circuit would result, as the circuit would then be completed through the motor frame and ground. To obviate this the motor frame should be insulated from the ground. This may be done either by setting the motor on a wood floor or by the use of a base frame, as with generators. A base frame should always be used where possible, for when a motor is set directly on the floor it is often impossible to keep the space under it clean, and there is always a liability of the floor being damp or of nails in the floor passing through the woodwork into some grounded part of the building or metal piping. A properly constructed base frame will allow of easy cleaning of the space under the motor.

In the case of elevator or other motors where the shunt field is suddenly broken, a momentarily high voltage is induced in the field windings. If the frame of the motor is grounded this high voltage has a strong tendency to jump through the insulation of the wires to the metal work of the motor, thus grounding the circuit.

b. Motors operating at a potential of 550 volts or less must be wired with the same precautions as required by rules in Class "C" for wires carrying a current of the same volume.

Motors operating at a potential between 550 and 3,500 volts must be wired with approved multiple conductor, metal sheathed cable in approved unlined metal conduit firmly secured in place. The metal sheath must be permanently and effectively grounded, and the construction and installation of the conduit must conform to rules for interior conduits (see No. 25 and No. 49, *a*, *j*, and *k*), except that at outlets approved outlet bushings shall be used.

The motor leads or branch circuits must be designed to carry a current at least 25 per cent greater than that for which the motor is rated, in order to provide for the inevitable occasional overloading of the motor and the increased current required in starting, without overfusing the wires; but where

the wires under this rule would be overfused, in order to provide for the starting current, as in the case of many of the alternating current motors, the wires must be of such size as to be properly protected by these larger fuses.

The insulation of the several conductors for high potential motors, where leaving the metal sheath at outlets, must be thoroughly protected from moisture and mechanical injury. This may be accomplished by means of a pot head or some equivalent method. The conduit must be substantially bonded to the metal casings of all fittings and apparatus connected to the inside high tension circuit. It would be much preferable to make the conduit system continuous throughout by connecting the conduit to fittings and motors by means of screw joints, and this construction is strongly recommended wherever practicable.

High potential motors should preferably be so located that the amount of inside wiring will be reduced to a minimum.

Inspection Department having jurisdiction may permit the wire for high potential motors to be installed according to the general rules for high potential systems when the outside wires directly enter a motor room (see Section f). Under these conditions there would generally be but a few feet of wire inside the building and none outside the motor room.

Good values to use for calculating the size of wire for branch conductors are given below. The question of loss of voltage is not taken into consideration here.

110 volts.....	9.3 amperes per horsepower
220 volts.....	4.6 amperes per horsepower
500 volts.....	2 amperes per horsepower

For mains supplying many motors it is not necessary to provide the twenty-five per cent. overload capacity, because it is not likely that all motors will start at the same time. If, however, any one motor has more than half the capacity of the whole installation, it is advisable to provide the overload capacity. For instance, if two motors, each of 50 amperes capacity, are fed over a line of 100 amperes capacity and one is started while the other is working at full load, they will overload that line twelve and one-half per cent.

For mains supplying many small motors the size should

be chosen for the total load connected, using the following values:

110 volts.....	7.5	amperes per horsepower
220 volts.....	3.75	amperes per horsepower
500 volts.....	1.65	amperes per horsepower

Where there are a number of 110-volt motors installed on the Edison 3-wire system, providing the load is evenly balanced between the two sides, the mains may be figured as though the motors were operating at 220 volts. The reason for this will be easily seen when it is remembered that two 110-volt motors operating in series on 220 volts (as they do on the Edison 3-wire system) take only one-half the current they would if operated on a straight 2-wire 110-volt system.

c. Each motor and resistance box must be protected by a cut-out and controlled by a switch (see No. 17*a*), said switch plainly indicating whether "on" or "off." With motors of one-fourth horsepower or less, on circuits where the voltage does not exceed 300, No. 21 *d* must be complied with, and single pole switches may be used as allowed in No. 22 *c*. The switch and rheostat must be located within sight of the motor, except in cases where special permission to locate them elsewhere is given, in writing, by the Inspection Department having jurisdiction.

The use of circuit-breakers with motors is recommended, and may be required by the Inspection Department having jurisdiction.

Where the circuit-breaking device on the motor-starting rheostat disconnects all wires of the circuit, the switch called for in this section may be omitted.

Overload-release devices on motor-starting rheostats will not be considered to take the place of the cut-out required by this section if they are inoperative during the starting of the motor.

The switch is necessary for entirely disconnecting the motor when not in use, and the cut-out to protect the motor from excessive currents due to accidents or careless handling when starting. An automatic circuit-breaker, disconnecting all

wires of the circuit may, however, serve as both switch and cut-out.

In general, motors should preferably have no exposed live parts.

For the larger size motors a cut-out must be installed for each motor, but with motors of $\frac{1}{4}$ horsepower or less, where

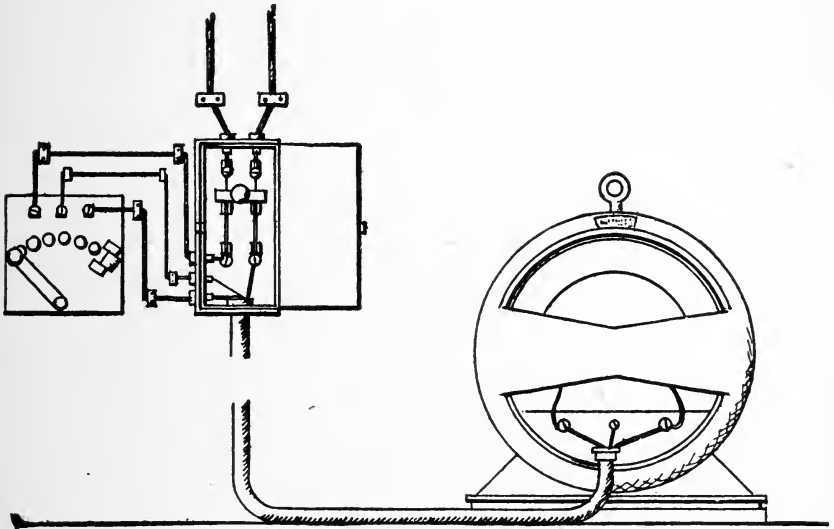

Figure 40.

the voltage does not exceed 300, a cut-out need be installed for every 660 watts only. This allows about $5 \frac{1}{8}$ horsepower motors, $3 \frac{1}{6}$ horsepower motors or $2 \frac{1}{4}$ horsepower motors on one cut-out. Every motor whether large or small must be controlled by a switch which will indicate whether the current is on or off. This is required to reduce the liability of a motor being accidentally left in circuit, which might result in serious trouble. Figure 40 shows a complete motor installation as usually arranged.

As a general rule fused knife switches are used for the larger motors, while with the smaller motors cut-out blocks

and indicating snap switches are often used. If the motor is $\frac{1}{4}$ horsepower or less, and operated on a circuit where the voltage does not exceed 300, a single pole switch may be used. For all motors over $\frac{1}{4}$ horsepower, and for all motors operated on voltages over 300, double pole switches must be used. The object of locating the switch and starting box within sight of the motor is that, should any trouble occur when the motor is being started, such as a short circuit or overload, it will be immediately noticed and the current shut off. If the conditions are such that it is necessary to locate the motor out of sight of the switch and starting box the motor should be located in a safe place, away from inflammable material. A special permit should be obtained from the inspection department having jurisdiction in order that the exact conditions may be noted.

d. Rheostats must be so installed as to comply with *all* the requirements of No. 4. Auto starters must comply with requirements of No. 4 *c.*

Starting rheostats and auto starters, unless equipped with tight casings enclosing all current-carrying parts, should be treated about the same as knife switches, and in all wet, dusty or linty places should be enclosed in dust-tight, fireproof cabinets. If a special motor room is provided, the starting apparatus and safety devices should be included within it. Where there is any liability of short circuits across their exposed live parts being caused by accidental contacts, they should either be enclosed in cabinets, or else a railing should be erected around them to keep unauthorized persons away from their immediate vicinity.

Auto starters answer the same purpose with alternating current motors that starting boxes do with direct current motors. Instead of an ohmic resistance an inductance is used to keep the current from attaining an excessive value while the motor is coming up to speed.

In some cities the local rules allow the starting box or rheostat to be mounted on asbestos board, in which case it

must be mounted out from the wall on porcelain knobs so that there will be at least one inch air space between the wall and the current-carrying parts. If the starting box or rheostat is to be mounted on a wall or other support where the frame would be grounded, it may be attached to a wood support and the wood support then independently attached to the wall. The best construction is to use slate or marble. If slate or marble is used it must be a continuous piece which will entirely cover the space back of the rheostat and the frame of the rheostat should be screwed to the slate or marble and the slate or marble then independently screwed to the wall, never using the same screw for attaching both.

A starting box is a device for limiting the current strength during the starting of the motor by inserting a resistance in series with the armature. The ohmic resistance of the armature of a shunt or compound wound motor is ordinarily very small. When such a motor is at rest and the current thrown directly on, the full voltage is thrown across the small resistance of the armature. Consider for a moment the case of a 1 horsepower 110 volt motor having an armature resistance of say 2 ohms, and taking, when running normally, 8 amperes. Suppose the current were thrown on without the use of a starting box. According to Ohm's law the current through the armature would be $110/2=55$ amperes. The results, were 55 amperes sent through the armature, can easily be imagined. Now, suppose a resistance of 8 ohms were inserted in series with the armature when starting. In this case $110/10=11$ amperes only would have to pass through the armature and this the armature can easily stand. As the motor begins to revolve a counter electro-motive force is generated which opposes the inrush of current. This counter electro-motive force

increases until the motor reaches full speed and takes its normal current.

In the example given above at the first step of the starting box there will be a current of 11 amperes flowing through a resistance of 8 ohms and the power consumed will be equal to $I^2 R$, or 968 watts, which are lost in heat produced in the resistance wire. As this amounts to more than one horsepower thrown off in heat the advisability of mounting the rheostat away from inflammable material and of properly ventilating it can readily be seen.

Figure 41 shows an illustration of an *automatic* starting box, and a diagram of the connections to a motor circuit. It

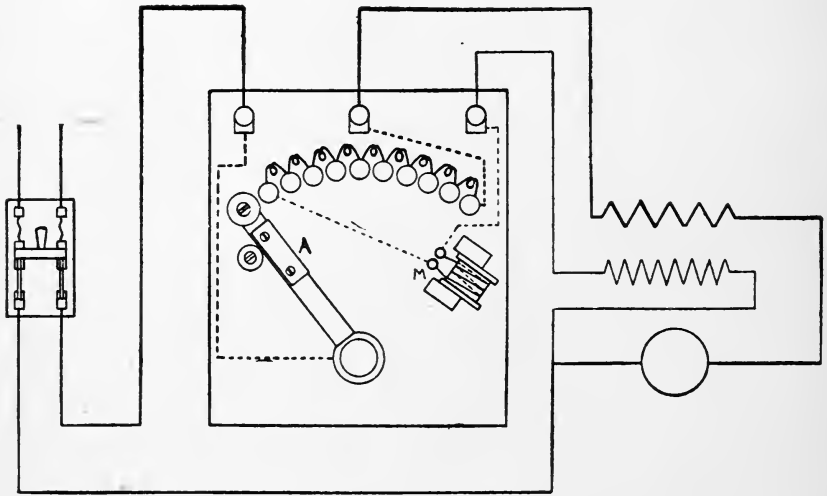

Figure 41.

will be seen that the resistance coils are in series with the armature circuit. As the arm A is moved to the right, resistance is gradually cut out of the armature circuit until the arm reaches the last point, where it is automatically held in position by means of the small magnet M, which is connected

in series with the field circuit. By tracing out the circuits it will be found that the field connection is made on the first point of the rheostat, so that when the arm A is in the "off" position there is no current passing through the field coils.

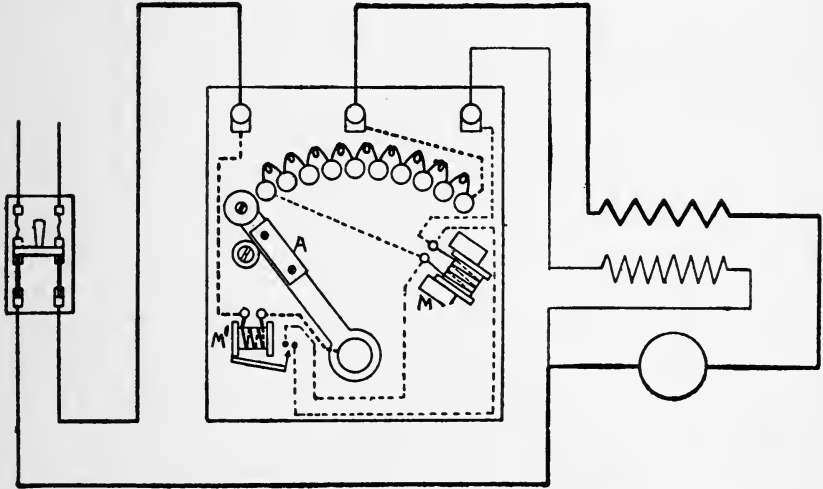

Figure 42.

It will also be noticed that the last contact upon which the arm rests when "off" is dead. If the supply current for any reason fails, current will cease to flow around the coils of the magnet M and it will become demagnetized, thus allowing the arm A to fly back to the "off" position. This overcomes the possibility of the main current being momentarily shut off and then thrown on when all the resistance is out of the armature circuit. This device is known as "no-voltage" release.

Another device known as the "overload" release is shown in Figure 42, with a diagram of the connections. The winding of the magnet M¹ carries the main current. When the current exceeds a certain amount (which can be regulated

by a small nut) the armature below the magnet will be attracted, thus short circuiting the coil M and allowing the arm to fly back and shut off the current to the motor. This device cannot be considered to take the place of the regular cut-outs, as it is not operative during the starting of the motor. It can only operate after the arm A is held in position by the magnet M.

Starting boxes are made in different designs to meet the

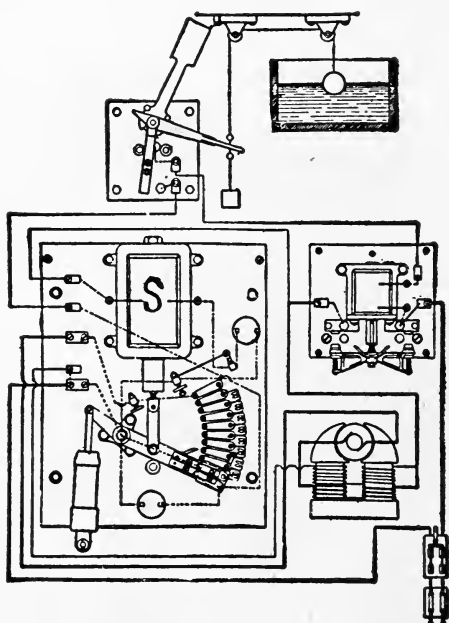

Figure 43.

requirements of the various classes of work on which they are used. Figure 43 shows a large automatic starting box where the resistance is cut out by the action of the solenoid S, which draws up the movable arm. When solenoids are used for this purpose it is often advisable to arrange the

connections so that when the movable arm has been raised to the highest and last point a resistance will be inserted in series with the solenoid to cut down the current and reduce the heating in the coil, as less current is required to hold the arm in place than to move it over the contacts. Incandescent lamps are often used for this purpose and must be installed as in 4, Class A.

A speed controller differs from a starting box mainly in the size of wire used as resistance. The resistance coils of a

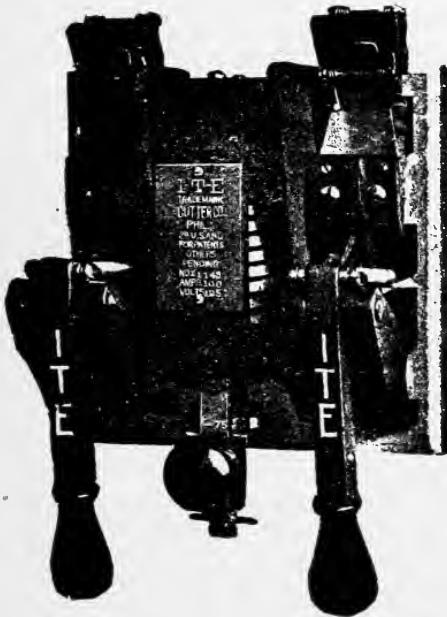

Figure 44.

starting box are wound with comparatively small wire connected in circuit for a short time only, generally from ten to twenty seconds, while in a speed controller the wire must be of sufficient size to carry the current as long as the motor

is running. Another difference between the starting box and speed controller is the automatic coil (Fig 41) M, which in the speed controller is arranged to hold the arm A in any position in which it may be placed. This is accomplished in some types of speed controllers by a lever attached to an armature, which is attracted by the magnet M, the other end of the lever fitting into a series of indentations on lower part of movable arm.

While the underwriters' rules do not require a speed controller to be automatic, still it is good practice to make them so, as the same principles apply to the starting of a motor with a speed controller as with a starting box.

Figure 44 shows a circuit breaker which is operative during the starting of the motor, and can be used to take the place of the switch required.

As the arm of a starting box or speed controller is moved from one contact to another, more or less sparking results, and, as has already been stated, considerable heat is developed in the coils. A rheostat should never be located in a room

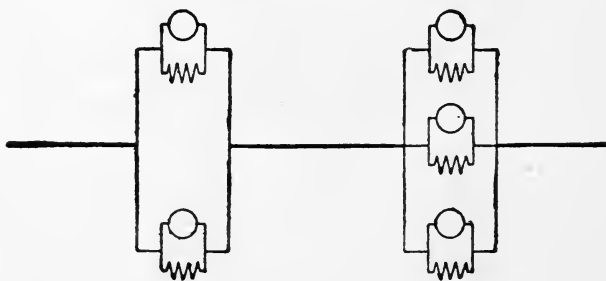

Figure 45.

where either inflammable gases or dust exist. If a starting box is to be located in a room where considerable dirt is apt to gather, or if the room is unusually damp, the starting box should be mounted in a dust-tight fire-proof box, which

should be kept closed at all times, except when starting the motor. If the enclosing box is rather large, sufficient ventilation of the coils will be obtained while the motor is being started and the door open. A speed controller should never be mounted in an enclosure unless the same is arranged to give a thorough ventilation to the outside air, as heat is constantly being generated in the coils of the rheostat, and this heat must be dissipated. A speed controller should never be located where dust or lint is apt to gather on it. If it is necessary to use one on a motor located in such a place, it should be mounted outside the room.

In metal working establishments or in any place where there is a liability of the contacts on the switches or the starting boxes being short-circuited, they should be enclosed or suitably protected.

e. Must not be run in series-multiple or multiple-series, except on constant-potential systems, and then only by special permission of the Inspection Department having jurisdiction.

Figure 45 shows a series-multiple, and Figure 46 a multiple-series system of wiring.

f. Must be covered with a waterproof cover when not in

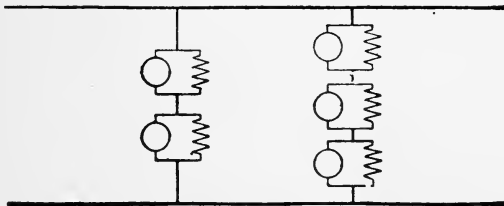

Figure 46.

use, and, if deemed necessary by the Inspection Department having jurisdiction, must be enclosed in an *approved* case.

When it is necessary to locate a motor in the vicinity of

combustibles or in wet or very dusty or dirty places, it is generally advisable to enclose it as above.

Such enclosures should be readily accessible, dust proof and sufficiently ventilated to prevent an excessive rise of temperature. The sides should preferably be made largely of glass, so that the motor may be always plainly visible. This lessens the chance of its being neglected, and allows any derangement to be at once noticed.

The use of enclosed type motor is recommended in dusty places, being preferable to wooden boxing.

From the nature of the question the decision as to details of construction must be left to the Inspection Department having jurisdiction to determine in each instance.

Under certain conditions it is found necessary to enclose motors in dust-tight enclosures. The practice of building a small box which fits entirely around the motor, enclosing the pulley and provided with slots through which the belt passes, is very unsatisfactory. While this construction prevents considerable dust from settling on and around the motor, still a great deal will be carried in by the belt. If the box is so made that it fits tightly around the shaft between the pulley and the motor frame and is otherwise well constructed, most of the dust and dirt can be kept out. As the efficient working of the motor requires that it be kept as cool as possible, the box should afford sufficient ventilation. This may be obtained by making the box somewhat larger than the motor, thus allowing the heat to radiate from the sides, or the boxes should be ventilated to the outside air.

A number of motors are so constructed that, by means of hand plates, they can be entirely enclosed. When they are so enclosed their efficiency and capacities are somewhat reduced, but cases are sometimes found where the conditions require motors of this kind to be used.

In places where there is considerable dust flying about in the air, and where the dust is not readily combustible, a fine gauze can be used to close the hand holes. This gauze will allow ventilation, but will prevent the dirt from gathering

inside the motor. The alternating induction motors, which are operated without brushes or collector rings, can be used in almost any location, as there is no sparking.

g. Must, when combined with ceiling fans, be hung from insulated hooks, or else there must be an insulator interposed between the motor and its support.

Ceiling fans are generally provided with an insulating knob on which the fan hangs. If this is not provided, a simple knob break can be used, or the fan can be suspended from a hook screwed into a hardwood block, provided the hook does not pass through the block into the plaster, the block being separately supported from the ceiling.

h. Must each be provided with a name-plate, giving the maker's name, the capacity in volts and amperes, and the normal speed in revolutions per minute.

i. Terminal blocks when used on motors must be made of *approved* non-combustible, non-absorptive insulating material such as slate, marble or porcelain.

j. Variable speed motors, unless of special and appropriate design, if controlled by means of field regulation, must be so arranged and connected that they cannot be started under weakened field.

The speed of a motor may be changed either by inserting resistance in series with the armature, thereby cutting down the voltage at the armature terminals; or by decreasing the field current through the addition of resistance in series with the shunt field winding. By this latter method the lines of force passing through the armature gap are considerably decreased and the armature must therefore revolve at a greater speed to develop the proper counter electro-motive force. When a motor is started under a weakened field, the starting torque being reduced, the armature is slow in coming up to speed. This prevents the rapid rise of counter E. M.

F. which takes place in the ordinary motor and consequently the heavy rush of current through the armature is more likely to continue and burn out the armature.

Unless motors are so designed that they do not require this excessive current when starting under a weakened field, the field rheostat, if separate from the starting rheostat, must be provided with a no-voltage release, such as is described in figure 41. When the field rheostat is combined with the starting rheostat the apparatus should be so constructed that

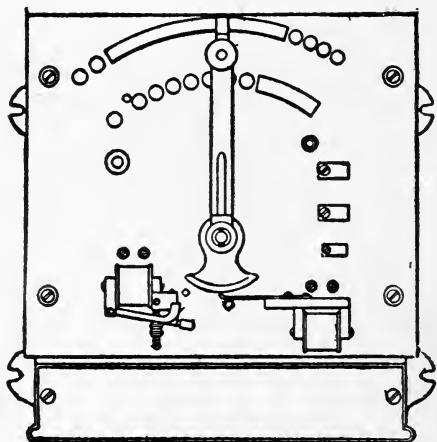

Figure 47

the motor cannot be started under a weakened field. Figure 47 shows a starting rheostat of this kind, the last four contacts at the right being connected to the shunt field resistance. Moving the rheostat arm to the right cuts this resistance in series with the shunt field.

9. Railway Power Plants.

a. Each feed wire before it leaves the station must be equipped with an *approved* automatic circuit breaker (see No. 52) or other device, which will immediately cut off the current

in case of an accidental ground. This device must be mounted on a fireproof base, and in full view and reach of the attendant.

10. Storage or Primary Batteries.

a. When current for light or power is taken from primary or secondary batteries, the same general regulations must be observed as apply to similar apparatus fed from dynamo generators developing the same difference of potential.

b. Storage battery rooms must be thoroughly ventilated.

c. Special attention is directed to the rules for wiring in rooms where acid fumes exist (see No. 24 *i* and *j*).

d. All secondary batteries must be mounted on non-absorptive, non-combustible insulators, such as glass or thoroughly vitrified and glazed porcelain.

e. The use of any metal liable to corrosion must be avoided in cell connections of secondary batteries.

Rubber-covered wire run on glass knobs should be used for wiring storage battery rooms. The knobs should be of such size as to keep the wire at least one inch from the surface wired over, and they should be separated $2\frac{1}{2}$ inches for voltage up to 300 and 4 inches for voltage over 300. Waterproof sockets hung from stranded rubber covered wire and properly supported independently of the joints should be used; these lights to be controlled by a switch placed outside of battery room. All joints after being properly soldered and taped with both rubber and friction tape should be painted with some good insulating compound. This tends to keep all acid fumes away from the wire.

Acid fumes are not only liable to bring about a fire hazard, but are also irritating to employes. Thorough ventilation is therefore very important.

11. Transformers.

(For construction rules, see No. 62.)

(See also Nos. 13, 13a, 36.)

a. In central or sub-stations the transformers must be so placed that smoke from the burning out of the coils or the boiling over of the oil (where oil filled cases are used) could do no harm.

If the insulation in a transformer breaks down, considerable heat is likely to be developed. This would cause a dense smoke, which might be mistaken for a fire and result in water being thrown into the building, and a heavy loss thereby entailed. Moreover, with oil cooled transformers, especially if the cases are filled too full, the oil may become ignited and boil over, producing a very stubborn fire.

b. In central or sub-stations casings of all transformers must be permanently and effectively grounded.

Transformers used exclusively to supply current to switch-board instruments need not be grounded, provided they are thoroughly insulated.

NOTICE--DO NOT FAIL TO SEE WHETHER ANY
RULE OR ORDINANCE OF YOUR CITY CON-
FLICTS WITH THESE RULES.

CLASS B.

OUTSIDE WORK.

*(Light, Power and Heat. For Signaling Systems,
see Class E.)*

All Systems and Voltages.

12. Wires.

a. Line wires must have an *approved* weatherproof or rubber insulating covering (see No. 44 and No. 41). That portion of the service wires between the main cut-out and switch and the first support from the cut-out or switch on outside of the building must have an approved rubber insulating covering (see No. 41), but from the above mentioned support to the line may have an approved weatherproof insulating covering (see No. 44), if kept free from awnings, swinging signs, shutters, etc.

By service wires are meant those wires which enter the building. It is customary to run the rubber-covered wire from the service switch and cut-out inside of building through the outer walls, and to leave but a few feet of wire to which the line wires can later be spliced. This is illustrated in Figure 48, which shows how wires are run from pole to building.

b. Must be so placed that moisture cannot form a cross connection between them, not less than a foot apart, and not

in contact with any substance other than their insulating supports. Wooden blocks to which insulators are attached must be covered over their entire surface with at least two coats of waterproof paint.

c. Must be at least 7 feet above the highest point of flat roofs, and at least one foot above the ridge of pitched roofs over which they pass or to which they are attached.

Roof structures are frequently found which are too low or much too light for the work, or which have been carelessly put up. A structure which is to hold the wires a proper distance above the roof in all kinds of weather must not only be of sufficient height, but must be substantially constructed of strong material.

It is well to avoid fastening wires perpendicular above one another, as in winter icicles may form which extend from the

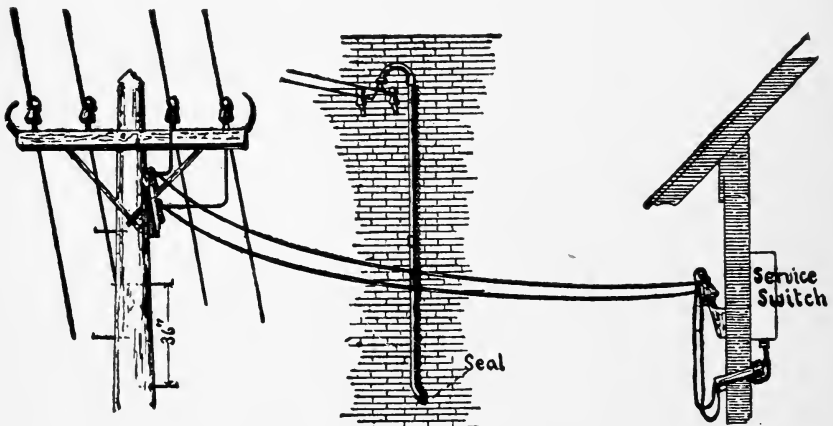

Figure 48.

top to the lower wire, and the moisture on these will often cause much trouble. The rule requires that wires be 7 feet above flat roofs, and roof structures must, therefore, be made high enough to allow for "sag." In moderately long runs 2 or 3 feet will be sufficient. For long runs, see following

table, taken from construction rules of Commonwealth Electric Company of Chicago:

The tension on wires should be such that the sag of a span of 125 feet will not exceed the amounts shown.

Temperature, F...	10	20	30	40	50	60	70	80	90
-------------------	----	----	----	----	----	----	----	----	----

Sag, inches	6	8	8	10	10	12	12	14	14
-------------------	---	---	---	----	----	----	----	----	----

This table will also be useful to consult when running wires over housetops to which they are not attached, as it shows the variation in "sag" due to different temperatures. Wires should be so run that even at the highest temperature they will still clear the buildings. Allowance should also be made for the gradual elongation of the wire to its own weight, giving way of supports or sleet that may at times weigh it down.

d. Must be protected by dead insulated guard irons or wires from possibility of contact with other conducting wires or substances to which the current may leak. Special precautions of this kind must be taken where sharp angles occur, or where any wires might possibly come in contact with electric light or power wires.

Crosses, when unavoidable, should be made as nearly at right angles as possible.

These guard wires are run parallel to and above the lower set of wires. Their object is to prevent the upper crossing wires, should they break, from coming in contact with the lower. A separate set of cross arms must be placed on the lower poles or above the lower wires to which the guard wires must be fastened. In Figure 49 1 and 2 show break insulators that may be used to electrically disconnect guard wires.

e. Must be provided with petticoat insulators of glass or porcelain. Porcelain knobs or cleats and rubber hooks will not be approved.

f. Must be so spliced or joined as to be both mechani-

cally and electrically secure without solder. The joints must then be soldered, to insure preservation, and covered with an insulation equal to that on the conductors.

All joints must be soldered, unless made with some form of *approved* splicing device. This ruling applies to joints and splices in all classes of wiring covered by these rules.

In Figure 49 single and double petticoat insulators are shown. It is very often convenient to fasten such insulators upside down or horizontally, but this should never be done, as they will then fill with water or dirt and their insulating qualities be destroyed.

g. Must, where they enter buildings, have drip loops outside, and the holes through which the conductors pass must be bushed with non-combustible, non-absorptive insulating tubes slanting upward toward the inside.

For low potential systems the service wires may be brought into buildings through a single iron conduit. The conduit to be curved downward at its outer end and carefully sealed or equipped with an approved service-head to prevent the entrance of moisture. The outer end must be at least one



Figure 49.

foot from any woodwork and the inner end must extend to the service cut-out, and if a cabinet is required by the Code must enter the cabinet in a manner similar to that described in fine print note under No. 25 b.

h. Electric light and power wires must not be placed on the same cross-arm with telegraph, telephone or similar wires, and when placed on the same pole with such wires the dis-

tance between the two inside pins of each crossarm must not be less than twenty-six inches.

i. The metallic sheaths to cables must be permanently and effectively connected to "earth."

The telephone or telegraph wires are sometimes placed above the power wires, and it very often becomes necessary for a lineman to pass through the lower wires to get at the upper. Great care is necessary to avoid coming in contact with high tension power wires while handling the telephone wires.

Poles should not be set more than 125 feet apart; 100 or 110 feet is good practice. For small wires poles with 6-inch tops are often used, but for heavier wires 7-inch tops are advisable. The tops of pole should be pointed, so as to shed water, and the whole pole be well painted. Steps should be placed so that the distance between any two steps on the same side is not over 36 inches; these steps should all be the same distance apart, and should not extend nearer than 8 feet to the ground. All "gains" cut into poles should be painted before cross-arms are placed in them. Such places are more likely to hold moisture and rot than exposed parts. Wherever feed wires end or sharp angles occur, double cross-arms should be used, fastened on opposite sides of pole and bolted together.

All bolts, lag screws, etc., should be galvanized. Poles should be set at least as far into the ground as shown in the following table:

Length of pole.	Depth in ground.
35 feet	5½ feet
40 "	6 "
45 "	6 "
50 "	6½ "
55 "	7 "
60 "	8 "

The holes should be large enough to admit of thorough tamping on all sides of bottom of hole. If the tamping at bottom of hole is not well done, the pole will always be shaky, no matter how much tamping may be done at the top. If the ground is soft, the pole may be set in cement, or short pieces of planking fastened to it at right angles underground. At the end of line or where sharp bends occur, strong galvanized guy cables fastened to poles six or eight feet long, buried underground, should be used.

Trolley Wires.

j. Must not be smaller than No. 0 B. & S. gage copper or No. 4 B. & S. gage silicon bronze, and must readily stand the strain put upon them when in use.

k. Must have a double insulation from the ground. In wooden pole construction the pole will be considered as one insulation.

l. Must be capable of being disconnected at the power plant, or of being divided into sections, so that, in case of fire on the railway route, the current may be shut off from the particular section and not interfere with the work of the firemen. This rule also applies to feeders.

m. Must be safely protected against accidental contact where crossed by other conductors.

Guard wires should be insulated from the ground and should be electrically disconnected in sections of not more than 300 feet in length.

Ground Return Wires.

n. For the diminution of electrolytic corrosion of underground metal work, ground return wires must be so arranged that the difference of potential between the grounded dynamo terminal and any point on the return circuit will not exceed twenty-five volts.

It is suggested that the positive pole of the dynamo be connected to the trolley line, and that whenever pipes or other underground metal work are found to be electrically positive

to the rails or surrounding earth, that they be connected by conductors arranged so as to prevent as far as possible current flow from the pipes into the ground.

12 A. Constant-Potential Pole Lines, Over 5,000 Volts.

(Overhead lines of this class unless properly arranged may increase the fire loss from the following causes:

Accidental crosses between such lines and low-potential lines may allow the high-voltage current to enter buildings over a large section of adjoining country. Moreover, such high voltage lines, if carried close to buildings, hamper the work of firemen in case of fire in the building. The object of these rules is so to direct this class of construction that no increase in fire hazard will result, while at the same time care has been taken to avoid restrictions which would unreasonably impede progress in electrical development.

It is fully understood that it is impossible to frame rules which will cover all conceivable cases that may arise in construction work of such an extended and varied nature, and it is advised that the Inspection Department having jurisdiction be freely consulted as to any modification of the rules in particular cases.)

a. Every reasonable precaution must be taken in arranging routes so as to avoid exposure to contacts with other electric circuits. On existing lines, where there is a liability to contact, the route should be changed by mutual agreement between the parties in interest wherever possible.

b. Such lines should not approach other pole lines nearer than a distance equal to the height of the taller pole line, and such lines should not be on the same poles with other wires, except that signaling wires used by the company operating the high-pressure system, and which do not enter property other than that owned or occupied by such company, may be carried over the same poles.

c. Where such lines must necessarily be carried nearer to other pole lines than is specified in Section *b* above, or where they must necessarily be carried on the same poles with

other wires, extra precautions to reduce the liability of a breakdown to a minimum must be taken, such as the use of wires of ample mechanical strength, widely spaced cross-arms, short spans, double or extra heavy cross-arms, extra

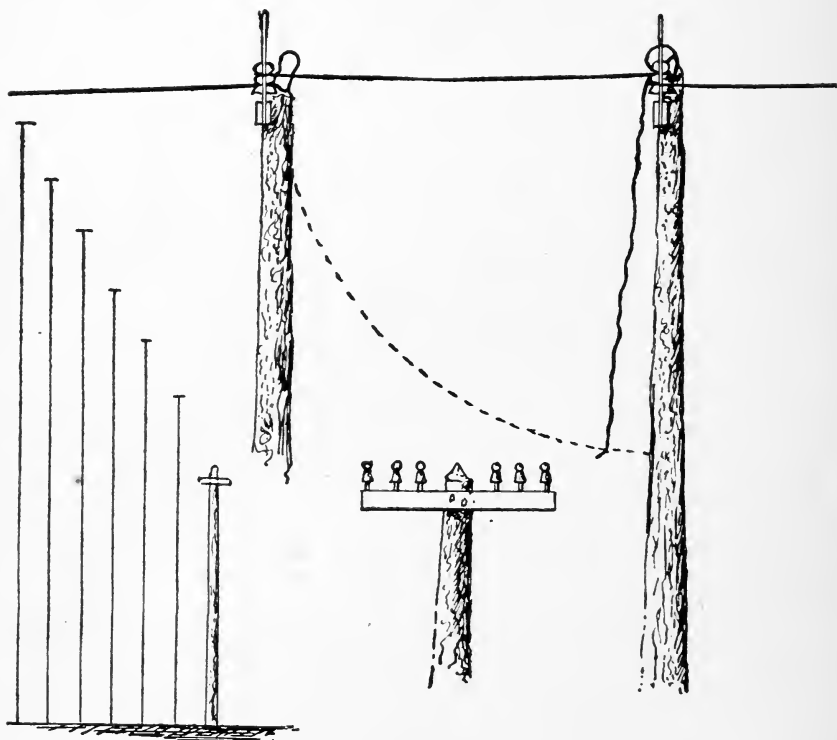

Figure 50

heavy pins, insulators, and poles thoroughly supported. If carried on the same poles with other wires, the high-pressure wires must be carried at least three feet above the other wires.

d. Where such lines cross other lines, the poles of both lines must be of heavy and substantial construction.

Wherever it is feasible, end-insulator guards should be placed on the cross-arms of the upper line. If the high-pres-

sure wires cross below the other lines, the wires of the upper line should be dead-ended at each end of the span to double-grooved, or to standard transposition insulators, and the line completed by loops.

One of the following forms of construction must then be adopted:

1. The height and length of the cross-over span may be made such that the shortest distance between the lower cross-arms of the upper line and any wire of the lower line will be greater than the length of the cross-over span, so that a wire breaking near one of the upper pins would not be long enough to reach any wire of the lower line. The high-pressure wires should preferably be above the other wires.

By reference to Fig. 50 it will be seen that the first plan of making cross-over is not very practical. In the lower left hand corner the vertical lines drawn alongside of the pole show the rate at which poles must be lengthened to comply with the rule when they are some distance from the pole to be crossed.

If a line is to be crossed in this manner, economy and also good construction require that the poles be set close to the line to be crossed as shown at the right of the figure. The poles here are about twice the length of the cross-arm apart. The wires between the two poles cannot touch the lower wires and the expense of the cross-over is only the setting of one pole and its cross-arms, etc. With the poles set as close as this there remains, however, the possibility of a wire in one of the adjacent spans breaking and, if strongly whipped about by the wind, being lashed against the lower wires. Guard wires can in a measure prevent such a wire coming in contact with the lower wire, but it is conceivable that the wire in question be broken off at such a distance from the

pole that it will swing over and lodge on top of the lower wires. If the cross-over poles are to be set farther apart to lessen this danger, they must be increased two feet in height for every foot they are moved to one side.

Figure 51 is a suggestion towards making crosses on a joint pole. It is simply a trough-like screen built around the lower wires and set so that it must catch the upper wires when they break and confine them so that the wind cannot whip them out.

A cross-over made on a joint pole in some such manner as this is probably the most satisfactory. Wires are absolutely prevented from coming together, and such a pole being braced by the wires in two ways would seem to be quite safe. When wires cross at rather an acute angle the

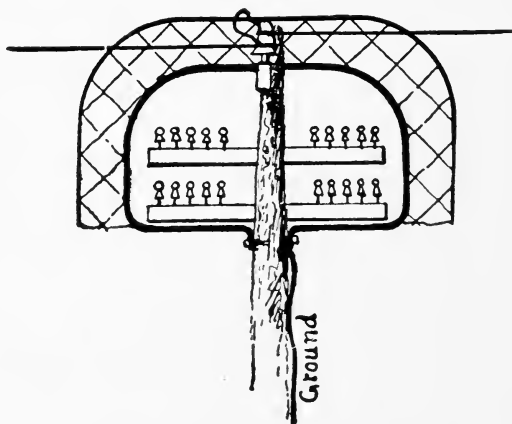

Figure 51

screen mentioned stretched from pole to pole under the upper wires is probably the best safeguard.

2. A joint pole may be erected at the crossing point, high-pressure wires being supported on this pole at least three feet above the other wires. Mechanical guards or supports must then be provided, so that in case of the breaking of any upper wire it

will be impossible for it to come into contact with any of the lower wires.

Such liability of contact may be prevented by the use of suspension wires, similar to those employed for suspending aerial telephone cables, which will prevent the high-pressure wires from falling in case they break. The suspension wires should be supported on high potential insulators, should have ample mechanical strength, and should be carried over the high-pressure wires for one span on each side of the joint pole, or where suspension wires are not desired guard wires may be carried above and below the lower wires for one span on each side of the joint pole, and so spread that a falling high-pressure wire would be held out of contact with the lower wires.

Such guard wires should be supported on high-potential insulators or should be grounded. When grounded, they must be of such size, and so connected and earthed, that they can surely carry to ground any current which may be delivered by any of the high-pressure wires. Further, the construction must be such that the guard wires will not be destroyed by any arcing at the point of contact likely to occur under the conditions existing.

3. Whenever neither of the above methods is feasible a screen of wires should be interposed between the lines at the cross-over. This screen should be supported on high tension insulators or grounded and should be of such construction and strength as to prevent the upper wires from coming into contact with the lower ones.

If the screen is grounded each wire of the screen must be of such size and so connected and earthed that it can surely carry to ground any current which may be delivered by any of the high pressure wires. Further, the construction must be such that the wires of screen will not be destroyed by any arcing at the point of contact likely to occur under the conditions existing.

e. When it is necessary to carry such lines near buildings, they must be at such height and distance from the building as not to interfere with firemen in event of fire; therefore, if within 25 feet of a building, they must be carried at a height not less than that of the front cornice, and the height must be greater than that of the cornice, as the wires come nearer

to the building, in accordance with the following table:—

Distance of wire from building. Feet.	Elevation of wire above cornice of building. Feet.
25	0
20	2
15	4
10	6
5	8
2½	9

It is evident that where the roof of the building continues nearly in line with the walls, as in mansard roofs, the height

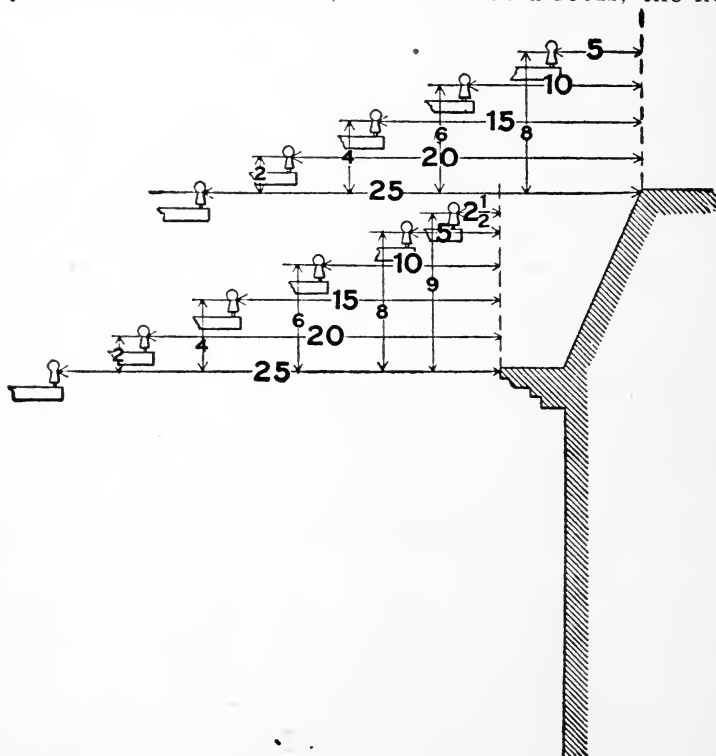

Figure 52.

and distance of the line must be reckoned from some part of the roof instead of from the cornice.

A graphic illustration of the rule concerning the placing of poles near buildings is given in Figure 52. The upper

group of figures and insulators shows the distance from the building and the corresponding height above high point of roof required with mansard roofs. Distance being measured from the roof. The lower groups show measurements taken from cornice line as will be proper with ordinary flat roofed buildings.

13. Transformers.

(For construction rules, see No. 62.)

(See also Nos. 11, 13A and 36.)

Where transformers are to be connected to high-voltage circuits, it is necessary, in many cases, for best protection to life and property, that the secondary system be permanently grounded, and provision should be made for it when the transformers are built.

a. Must not be placed inside of any building, excepting central stations and sub-stations, unless by special permission of the Inspection Department having jurisdiction.

An outside location is always preferable; first, because it keeps the high-voltage primary wires entirely out of the building and, second, for the reasons given in the note to No. 11 a.

b. Must not be attached to the outside walls of buildings, unless separated therefrom by substantial supports.

It is recommended that the transformers be not attached to frame buildings when any other location is practicable.

As a rule transformers are fastened to buildings on horizontal bars of wood. This method is as satisfactory as any if the wood itself is securely enough fastened to the wall. The wooden supports of the transformer should be fastened to the wall either by suitable expansion bolts or better still by bolts passing entirely through the wall. In fastening transformers to poorly constructed walls where permission to go through the wall cannot be obtained, some advantage can be gained by supporting the transformer sticks set vertically as shown in Figure 53. It must be borne in mind that there is not only a downward strain on the supports but also an outward tipping strain. Almost any wall

will stand the downward strain but in a loosely constructed wall there may not be a good hold for the bolts and a heavy transformer may tear them out as indicated. If the transformer is supported as indicated the supports may be dis-

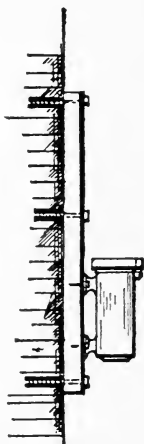

Figure 53.

tributed over a much larger wall area and a much greater leverage obtained against tipping strain than would be possible with horizontally arranged timbers.

The alternating current transformer consists of an iron core upon which wires of two distinct electrical circuits are wound. One of these is known as the *primary* circuit, and in it the high pressure currents coming direct from the dynamo circulate. The other is known as the *secondary* circuit, and in it the low pressure currents used inside of building circulate. These two circuits are wound generally one over the other, and are very close together. The pressure used in the primary coil is from 1,000 to 5,000 volts, while in the secondary it is reduced usually to 110 or 220.

It quite frequently happens that the insulation between the

two windings breaks down and thus the high pressure is accidentally brought into buildings. Under such circumstances should any one touch any live part of the installation while touching also grounded parts of the building death would very likely result. Also, should there be a weak spot in the insulation, it is quite likely the high pressure would pierce it at that point with a possible result of a fire. Many deaths and fires

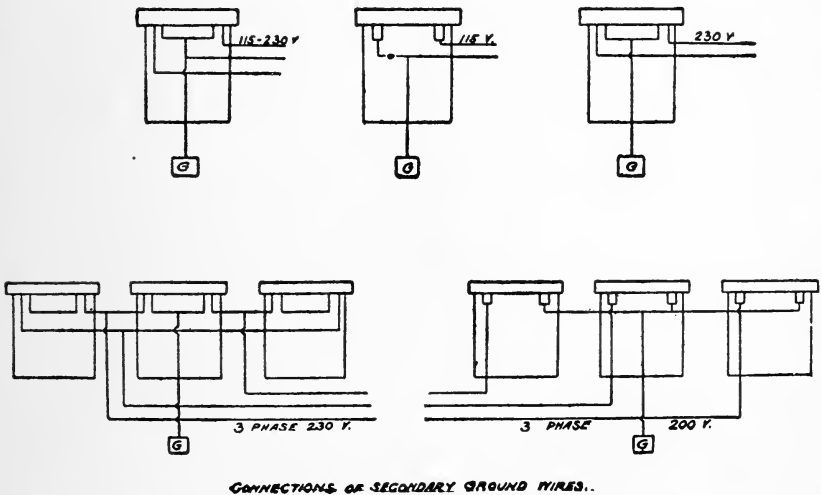

Figure 54.

have been caused in this way. If such lines are connected to ground the chances for harm are very much lessened, for the current will never take the path of high resistance through a man's body while a direct path through a low resistance wire is open to it.

It must not be supposed that "grounding" one side of an electric light system is not often followed by serious consequences, for under such circumstances a ground coming on any other part of the system will cause a short circuit at once.

The grounding in these cases is to be looked upon as the lesser of two evils rather than as an advantage. With alternating currents, the chances of possible damage from grounding are much less than with direct currents, because each transformer with its small group of lamps is a system by itself and not affected by grounds on other transformers. Thus a 5,000 light alternating current installation would consist of from 25 to 50 separate systems, each independent of defects on the rest, while in a continuous current installation a ground on the most remote branch circuit would in conjunction with a ground on the opposite pole of any other part of the system form a short circuit.

Methods of grounding secondary wires of alternating current transformers are shown in Figure 54, taken from an instruction book issued by the Commonwealth Electric Company of Chicago.

In connection with 3-wire systems, grounding of the central wire can do little harm, because ordinarily the neutral wire seldom carries much current, and that current is apt to vary in direction so that the electrolytic effect will be on the whole quite negligible.

There is, of course, the hazard brought about by the fact that a ground coming on one of the outside wires will immediately form a short-circuit in connection with the ground on the neutral.

In connection with 3-wire systems, however, it is of the greatest importance (as more fully explained further on) that the neutral wire remain intact, and it being thoroughly grounded at all available outside places will help to keep it so.

13A. Grounding Low-Potential Circuits.

The grounding of low-potential circuits under the following regulations is only allowed when such circuits are so

arranged that under normal conditions of service there will be no passage of current over the ground wire.

Direct-Current 3-Wire System.

a. Neutral wire may be grounded, and when grounded the following rules must be complied with:—

1. Must be grounded at the Central Station on a metal plate buried in coke beneath permanent moisture level, and also through all available underground water and gas-pipe systems.
2. In underground systems the neutral wire must also be grounded at each distributing box through the box.
3. In overhead systems the neutral wire must be grounded every 500 feet, as provided in Sections *c* to *g*.

Inspection Departments having jurisdiction may require grounding if they deem it necessary.

Two-wire direct-current systems having no accessible neutral point are not to be grounded.

Alternating-Current Secondary Systems.

b. Transformer secondaries of distributing systems should preferably be grounded, and when grounded, the following rules must be complied with:—

1. The grounding must be made at the neutral point, or wire, whenever a neutral point or wire is accessible.
2. When no neutral point or wire is accessible, one side of the secondary circuit may be grounded, provided the maximum difference of potential between the grounded point and any other point in the circuit does not exceed 250 volts.
3. The ground connection must be at the transformer or on the individual service as provided in sections *c* to *g*, and when transformers feed systems with a neutral wire the neutral wire must also be grounded at least every 250 feet for overhead systems and every 500 feet for underground systems.

Inspection Departments having jurisdiction may require grounding if they deem it necessary.

Ground Connections.

c. When the ground connection is inside of any building, or the ground wire is inside of or attached to any building (except Central or Sub-stations) the ground wire must be of copper and have an approved rubber insulating covering National Electrical Code Standard, for from 0 to 600 volts. (See No. 41.)

d. The ground wire in direct-current 3-wire systems must not at Central Stations be smaller than the neutral wire and not smaller than No. 4 B. & S. gage elsewhere. The ground wire in alternating current systems must never be less than No. 4 B. & S. gage.

On three-phase system, the ground wire must have a carrying capacity equal to that of any one of the three mains.

e. The ground wire should, except for Central Stations and transformer sub-stations, be kept outside of buildings as far as practicable, but may be directly attached to the building or pole by cleats or straps or on porcelain knobs. Staples must never be used. The wire must be carried in as nearly a straight line as practicable, avoiding kinks, coils and sharp bends, and must be protected when exposed to mechanical injury.

This protection can be secured by use of an approved moulding, and as a rule the ground wire on the outside of a building should be in moulding at all places where it is within seven feet from the ground.

f. The ground connection for Central Stations, transformer sub-stations, and banks of transformers must be made through metal plates buried in coke below permanent moisture level, and connection should also be made to all available underground piping systems including the lead sheath of underground cables.

g. For individual transformers and building services the ground connection may be made as in Section *f*, or may be made to water piping systems running into the buildings. This connection may be made by carrying the ground

wire into the cellar and connecting on the street side of meters, main cocks, etc.

Where it is necessary to run the ground wire through any part of a building it shall be protected by approved porcelain bushings through walls or partitions and shall be run in approved moulding, except that in basements it may be supported on porcelain.

In connecting a ground wire to a piping system, the wire should be sweated into a lug attached to an approved clamp, and the clamp firmly bolted to the water pipe after all rust and scale have been removed; or be soldered into a brass plug and the plug forcibly screwed into a pipe-fitting, or, where the pipes are cast iron, into a hole tapped into the pipe itself. For large stations, where connecting to underground pipes with bell and spigot joints, it is well to connect to several lengths, as the pipe joints may be of rather high resistance.

Where ground plates are used, a No. 16 Stubbs' gage copper plate, about three by six feet in size, with about two feet of crushed coke or charcoal, about pea size, both under and over it, would make a ground of sufficient capacity for a moderate-sized station, and would probably answer for the ordinary substation or bank of transformers. For a large central station, a plate with considerably more area might be necessary, depending upon the other underground connections available. The ground wire should be riveted to the plate in a number of places, and soldered for its whole length. Perhaps even better than a copper plate is a cast-iron plate with projecting forks, the idea of the fork being to distribute the connection to the ground over a fairly broad area, and to give a large surface contact. The ground wire can probably best be connected to such a cast-iron plate by soldering it into brass plugs screwed into holes tapped in the plate. In all cases, the joint between the plate and the ground wire should be thoroughly protected against corrosion by painting it with waterproof paint or some equivalent.

NOTE.—DO NOT FAIL TO SEE WHETHER ANY RULE OR ORDINANCE OF YOUR CITY CONFLICTS WITH THESE RULES.

CLASS C.

INSIDE WORK.

(Light, Power and Heat. For Signaling Systems, see Class E.)

All Systems and Voltages.

GENERAL RULES.

14. Wires.

(For special rules, see Nos. 16, 18, 24, 35, 38 and 39.)

a. Must not be of smaller size than No. 14 B. & S. gage, except as allowed under Nos. 24 *v* and 45 *b*.

The exceptions being wires used inside of fixtures and flexible cord used to suspend individual electric lights. For general purposes a wire smaller than No. 14 is too easily broken, either through a sharp kink or by drawing too tight with tie wires. To avoid trouble from kinks or sharp bends, wires smaller than 14 should preferably be stranded.

b. Tie wires must have an insulation equal to that of the conductors they confine.

The use of some form of confining knob or insulator which will dispense with tie wires is recommended.

This is considered necessary, because very often the tie wire cuts through the insulation of the wire it confines, and if the tie wire should come in contact with other than its insu-

lating support, there would still be good insulation. In Figure 55, (1) and (2) illustrate the method of tying usually employed with small wires on insulators; (4) shows a method

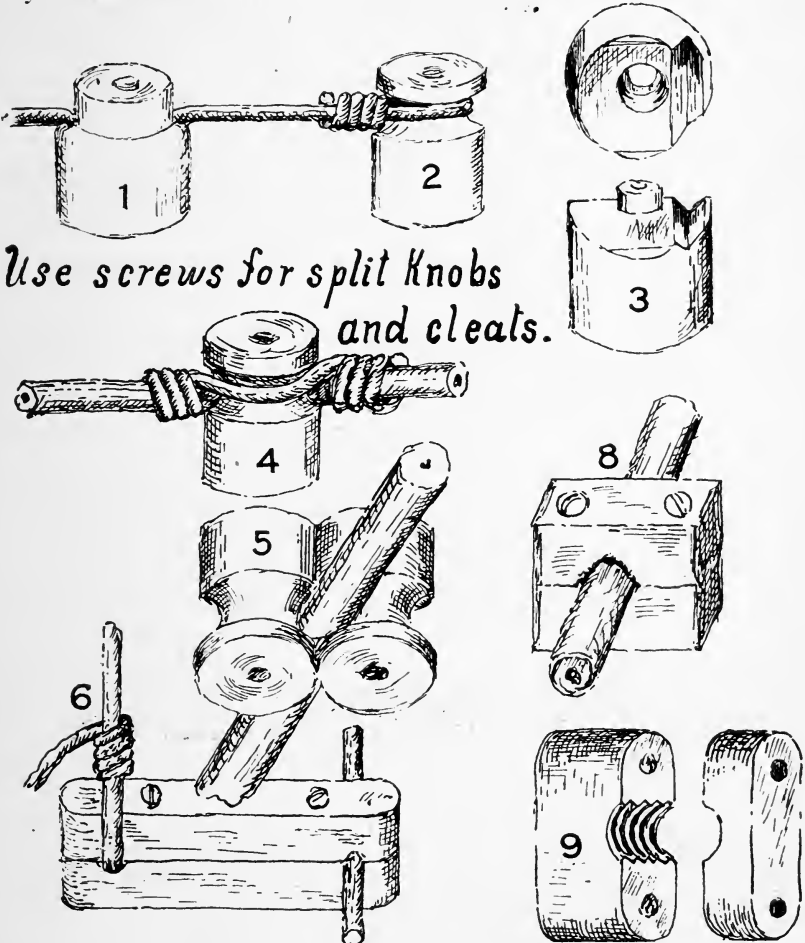

Figure 55.

employed with larger wires. This is also especially useful, because slack can be taken up if the tie wire is arranged to draw the main wire about half way around the insulator; (6)

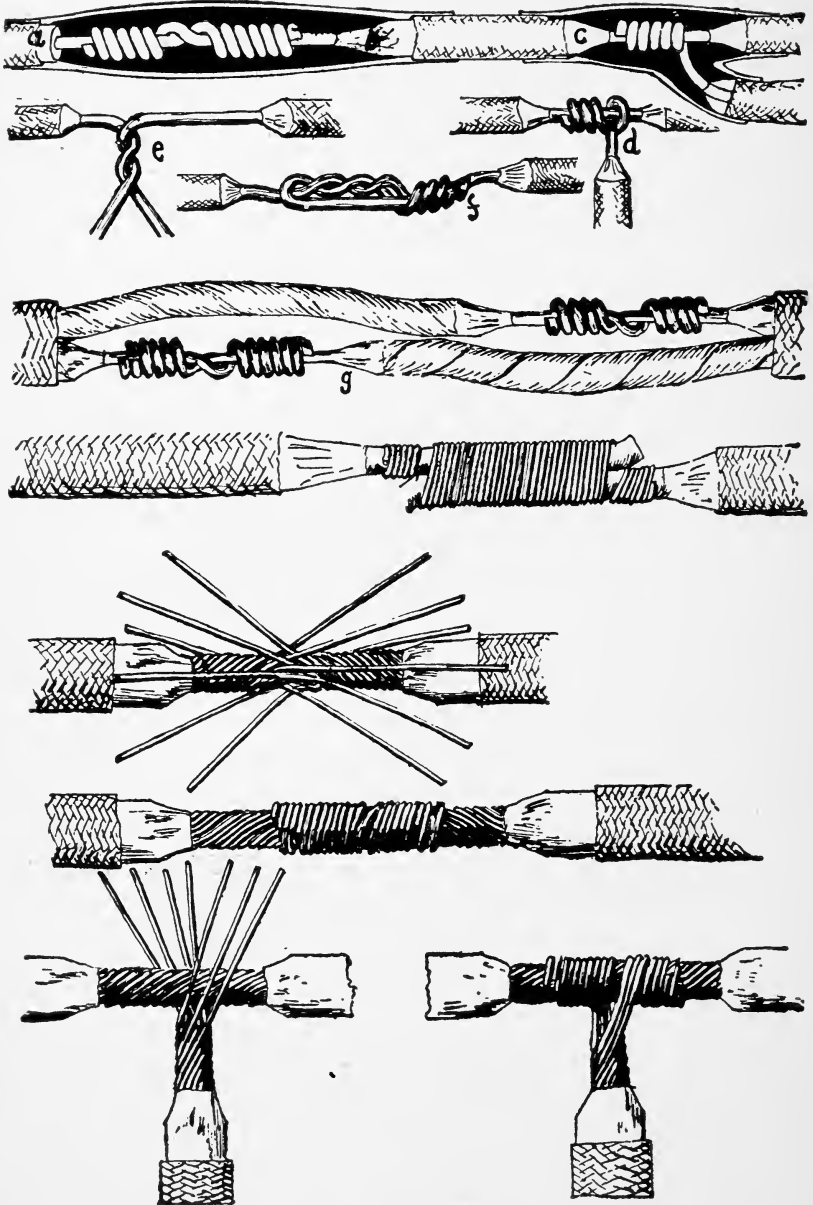

Figure 54

shows a knot tied into the wire, as is usual where the end of the wire connects into cut-outs or switches. At (5) insulators are arranged to hold large wires. It is not advisable to tie large wires to insulators, as the weight of the wire will soon cause it to cut through the insulation. Cleats, such as shown at (8) and (9), are preferable.

c. Must be so spliced or joined as to be both mechanically and electrically secure without solder. The joints must then be soldered to insure preservation, and covered with an insulation equal to that on the conductors.

Stranded wires must be soldered before being fastened under clamps or binding screws, and whether stranded or solid when they have a conductivity greater than that of No. 8 B. & S. gage they must be soldered into lugs for all terminal connections.

All joints must be soldered unless made with some form of *approved* splicing device. This ruling applies to joints and splices in all classes of wiring covered by these rules.

On the left at the upper part of Fig. 56 is shown the well-known Western Union joint. Before joining wires they should be thoroughly cleaned by scraping with the back of a knife or sand or emery paper. The insulation should be removed, as indicated at *b*; if it is cut into as at *a*, it is very likely that the wire will be "nicked" and will be likely to break at that point. It is also more difficult to tape a joint properly if the rubber has been cut in this way than it is with the rubber cut as at *b*. After the joint has been made it is covered with soldering fluid, a formula for which is given below. In lieu of this there are soldering sticks and salts, already prepared, on the market.

The following formula for soldering fluid is suggested:—

Saturated solution of zinc chloride.....	5 parts
Alcohol	4 parts
Glycerine	1 part

The joint having been thoroughly covered with one of

these preparations is next heated with a gasoline or alcohol torch and a small piece of solder allowed to melt on it near the center. It is well to avoid heating too much at the ends of the joint, as it weakens the wire. After the joint is partly cooled wipe off all moisture and cover with layers of rubber tape, enough, at least, so that it is equal in thickness to the rubber insulation on the wire used, as shown at *a* and *b*. If the rubber tape is put on before the wire has entirely cooled the remaining heat will assist in vulcanizing the rubber. This rubber tape is then covered with friction tape to keep it in place. Before taping joints the outer braid of the wire should be carefully skinned back. If any of the cotton threads of which it consists were to be left in contact with the bare wire, they would, when moist, form a leak, which might prove troublesome. If joints are exposed to the weather it will be well to paint them over with some insulating paint to keep the friction tape in place, as it will otherwise soon work loose when it becomes dry.

At *c* and *d* "tap" joints are shown. The method shown at *d* is preferable, because the wire cannot easily work loose. The method of joining shown at *e* is useful when, for instance, two wires, each of which is fastened to an insulator, are to be joined. The wires can be drawn very tight in this way. This sort of joint is very common in fixture work, and should be finished off as at *f*.

Twin wires other than flexible cord are allowed only in metal conduits, and joints in them should be made only within the junction boxes. When joints in conduit are unavoidable, twin wires should be joined as at *g*, so that the joints are not opposite each other. Joints in flexible cord should be avoided as much as possible.

In splicing stranded wires it is customary to remove some of the center strands to avoid making a very bulky splice. All

stranded wires must be soldered where fastened under binding screws; this refers also to flexible cord used in sockets. The best way to solder the ends of cords is to dip them in melted solder; a blow torch will easily overheat small wires and leave them brittle.

Figure 57 shows lead covered wire spliced and taped. In handling lead covered wire great care must be exercised (especially with paper insulated) that it be not bruised and the lead not punctured. The lead covering is of use only as a protection against water; if it admits the least bit of moisture it is worse than useless. The ends of lead covered wires should always be kept sealed until ready for use; in damp places the paper insulation may absorb moisture, which will ground the wire on the lead. When installed the ends should always be sealed against moisture. Lead covered wires should never be used where there is a liability of nails being driven into them.

Joints in lead covered wires are made just as in ordinary wires. Extreme care is necessary that no moisture be left on

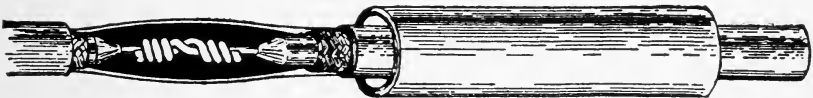

Figure 57.

the wire **when** it is taped or covered up. Before the wire is joined a **sleeve** (Figure 57) is slipped over one of the wires. After the **joint** has been made and taped, this sleeve is placed so as to **cover** it, and the ends split and arranged to fit close against the **lead** on the wires. That part of the lead which must be **soldered** to make the joint watertight is scraped until it is perfectly **bright** and then coated with tallow candle grease. It can then be soldered with an iron, or melted solder can be

poured on it and wiped around it, as plumbers do. If a soldering iron is used it must not be too hot and not allowed to remain in one place too long, as the lead itself melts at nearly the same temperature as the solder. An inexperienced workman may burn more holes into the lead than he closes. If a neat job is desired, that part of the lead which is to be kept free of solder is covered with lampblack and glue, or ordinary paper hanger's paste, or a mixture of flour and water boiled, so as to prevent the solder from taking on it.

d. Must be separated from contact with walls, floors, timbers or partitions through which they may pass by non-combustible, non-absorptive insulating tubes, such as glass or porcelain, except as provided in No. 24 *u*.

Bushings must be long enough to bush the entire length of the hole in one continuous piece or else the hole must

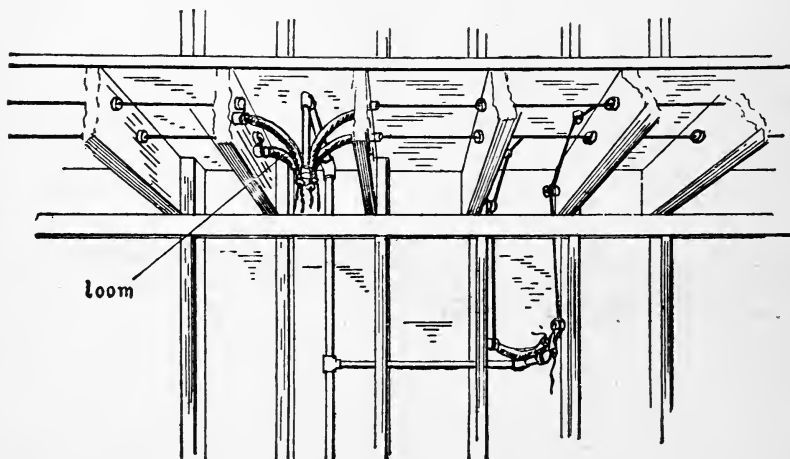

Figure 58.

first be bushed by a continuous waterproof tube. This tube may be a conductor, such as iron pipe, but in that case an insulating bushing must be pushed into each end of it, extending far enough to keep the wire absolutely out of contact with the pipe.

The exception mentioned is in regard to wires at outlets

where they are required to be in approved flexible tubing from the last insulator to at least one inch beyond plaster, or end of the cap on gas piping. This is shown in Figure 58. The reasons for the separation of wires from everything but their insulating supports are many. Should a bare live wire come in contact with damp woodwork or masonry, there would very likely be some flow of current to ground and through the ground to the other pole of the dynamo or other wire. This flow of current may gradually char the woodwork, and in time start a fire; or it may gradually eat away the wire, finally causing it to break. When a wire is eaten away, as shown at *c* and *e*, Figure 59, if it is carrying much current, the thin

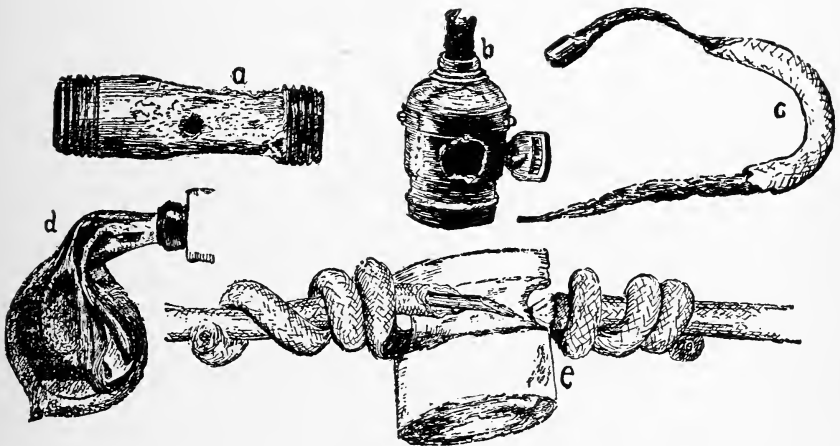

Figure 59.

part will become very hot and will set fire to whatever inflammable material may be near it. If the current flow to the ground continues, the positive wire will finally be entirely severed, and an arc, similar to that noticed in an ordinary arc lamp, will be established, and will continue until the wire has been burned away and the space between the two ends becomes

too great for the arc to maintain itself. The negative wire, to which the current flows, is not eaten away in this manner, and such current flow is only possible when two wires of a system are in electrical connection with the ground. This action may, however, occur, even if the two grounded wires are miles apart. Wires and gas pipes are often destroyed through intermittent contact; for instance, if a wire makes a good contact to a gas pipe and there is a small leak to the pipe no particular harm will be done as long as the contact remains good. Should, however, the contact be intermittent, there will be a small arc at each break, and this will, little by little, burn holes into the gas pipe and into the wire. This action will take place on either a positive or negative wire. Non-combustible supports for wires are further useful in that they tend to prevent flames from the rubber insulation (which is very easily ignited from any of the above causes) from spreading to surrounding material.

Figure 59 consists of copies of specimens showing effects of electrolysis, short circuits, and heating of lamp. These illustrations are copied from fire reports of the National Board of Underwriters.

At *a* is shown a piece of gas pipe, which had been subject to electrolytic action until finally a hole had been eaten through the metal; *b* is a socket which had been short circuited, and the excessive damage was due to overfusing of circuit.

At *c* and *e*, the effects of electrolysis on wire are shown; *c* is a piece of underwriter's wire (not approved in moulding), which had been used in damp moulding, the leak to ground through the dampness causing the gradual eating away of the wire; *e* shows a breakdown in the insulation and subsequent electrolytic action on the wire, causing it finally to break. This wire had been used in a roundhouse, where the sulphur

fumes and the condensation of escaping steam on insulators had formed a path to ground. At *d* is an incandescent lamp which had been covered with a towel, the confined heat softening the glass and setting fire to the towel. The danger of fire from overheated lamps is much greater than is generally supposed. Small lamps and lamps subject to a little excess of voltage are especially dangerous, and many instances are on record where they have charred woodwork and set fire to cloth or paper shades.

It may in many cases seem unnecessary to have bushings in one piece long enough to pass through a floor, or wide wall; but especially in passing through floors, it is very easily possible for wires to become crossed between the joists; that

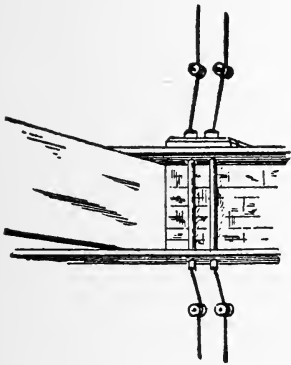

Figure 60.

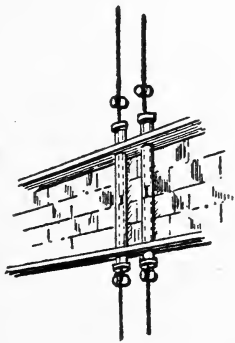

Figure 61.

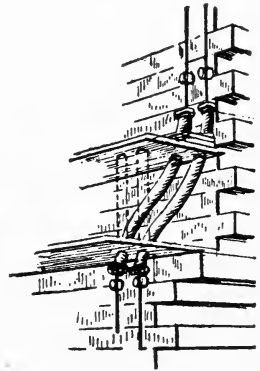

Figure 62.

is, the wire entering at the right above the floor may be brought out at the left below the floor and the other wire through the opposite holes. In such a case the two wires of opposite polarity will be in contact, and should the insulation give out from any cause whatever, such as abrasion, or the gnawing of rats and mice, there would be nothing to prevent a short circuit and consequent fire. In passing through floors

or walls the wires often come in contact with concealed pipes or other grounded material, so that only by making the bushings continuous can the wires be properly protected.

Figure 61 shows short bushings arranged in iron pipe. Figure 62 shows a case where there is an offset in the wall. Cases of this kind very often occur. Sometimes the floor can be taken up and an iron conduit, properly bent, put in place; the wires being reinforced with flexible tubing; or the wires placed on insulators. In this latter case the floor must not be put down until the inspector has examined the wires. The wires may be run on top of the floor to such a place where a continuous bushing may be dropped through the floor. The wires on top of the floor must be then protected by a suitable boxing of at least the same dimensions as given for boxing on side walls.

e. Must be kept free from contact with gas, water or other metallic piping, or any other conductors or conducting material which they may cross, by some continuous and firmly fixed non-conductor, creating a permanent separation. Deviations from this rule may sometimes be allowed by special permission.

Where one wire crosses another wire the best and usual means of separating them is by a porcelain tube on one of the wires. The tubing must be prevented from moving out of place either by a cleat or knob on each end, or by taping it securely in place.

The same method may be adopted where wires pass close to iron pipes, beams, etc., or, where the wires are above the pipes, as is generally the case, ample protection can frequently be secured by supporting the wires well with a porcelain cleat placed as nearly above the pipe as possible.

This rule must not be construed as in any way modifying No. 24, Sections h and j.

Figure 63 is a sectional view of the manner in which wires are usually run through joists in bushings. For small wires bushings should preferably be installed as shown at top; never as shown in the middle row. For larger wires the holes must

be bored as straight as possible; otherwise it will be difficult to pull wires through. The quantity of wire needed is also

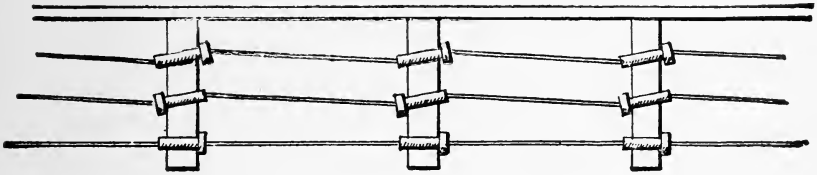

Figure 63.

somewhat increased by slanting the holes. In open places wires are generally installed on insulators as shown in Figure 64.

Figure 64 shows different methods employed where one wire crosses another. The method at the left, which is more suited to large stiff wires, does not quite comply with the rule, but is very often used. The other two methods are preferable. Insulating supports should always be provided at the place of crossing to prevent the upper wires from sagging and resting on the lower; also to prevent any strain from coming on tap joints. Approved flexible tubing such as circular loom is also often used in crossing wires and pipes. In dry locations it is quite safe and does not break as easily as tubes, but should never be used where there is any likelihood of dampness.

f. Must be so placed in wet places that an air space will be left between conductors and pipes in crossing, and the former must be run in such a way that they cannot come in contact with the pipe accidentally. Wires should be run over rather than under pipes upon which moisture is likely to gather or which, by leaking, might cause trouble on a circuit.

This is a rule that is very often violated, as much work is done using loom, as shown at the left of Figure 65, and is quite safe with gas pipes. With cold water pipes, which are

likely to sweat, or with steam pipes, it is very bad practice. Where pipes are close against a ceiling it is better either to fish over them or drop wires some distance below them as illustrated at the right of the figure. No part of the wiring should be in contact with pipes. On side walls where ver-

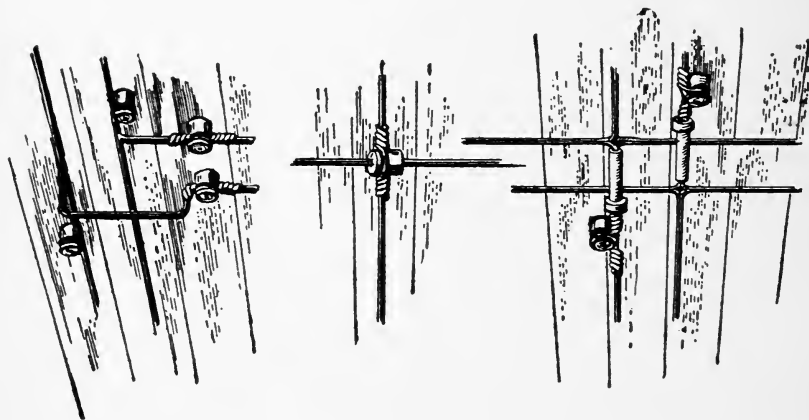

Figure 64.

tical wires run across horizontal pipes the only safeguard would be to box the pipes and run the moisture to one side. The most harm is done by water on the insulators. If these can be kept dry it does not matter much about wires which



Figure 65.

hang free in the air. Whatever form of insulation is used in crossing pipes, it must be continuous. Short bushings strung on the wire, where a large pipe or number of pipes are being crossed, is not satisfactory, as the bushings are

apt to separate or moisture gather in the space between them. The insulation must also be firmly attached to the wires. If knobs are not used as shown in Figure 64 to keep the bushings in place, they must be taped to the wire.

g. The installation of electrical conductors in wooden moulding or where supported on insulators in elevator shafts will not be approved, but conductors may be installed in such shafts if encased in approved metal conduits.

Wires supported on insulators in such places are very likely to be disturbed, especially in freight elevators. Moulding is often so impregnated with oil and the draft in an elevator shaft is usually so strong that a blaze once started would quickly run to the top.

15. Underground Conductors.

a. Must be protected against moisture and mechanical injury where brought into a building, and all combustible material must be kept from the immediate vicinity.

b. Must not be so arranged as to shunt the current through a building around any catch-box.

By reference to Figure 66 the meaning of this rule will be made clear. With wires run as shown it would be easy for any one having disconnected one service switch to believe all wires in the building dead, while they were in reality still being kept alive by the other switch. This connection would allow current to pass from one street main to another without going through the fuses in the street catch-box.

c. Where underground service enters building through tubes, the tubes shall be tightly closed at outlets with asphaltum or other non-conductor, to prevent gases from entering the building through such channels.

d. No underground service from a subway to a building shall supply more than one building except by written permission from the Inspection Department having jurisdiction.

16. Table of Carrying Capacity of Wires.

(See tables in back of book.)

17. Switches, Cut-Outs, Circuit-Breakers, Etc.

(For construction rules see Nos. 51, 52 and 53.)

a. On constant potential circuits, all service switches and all switches controlling circuits supplying current to motors or heating devices, and all cut-outs, unless otherwise provided (for exceptions as to switches see Nos. 8 *c* and 21 *a*; for exceptions as to cut-outs see No. 21 *a* and *b*) must be so arranged that the cut-outs will protect and the opening of the switch or circuit-breaker will disconnect all of the wires; that is, in the two-wire system the two wires, and the three-wire system

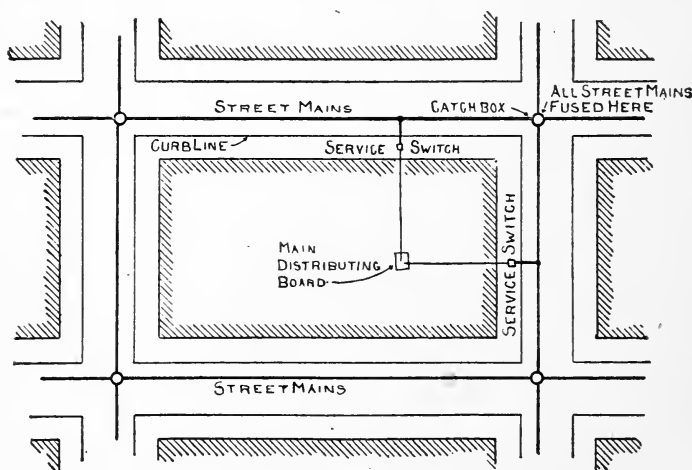

Figure 66.

the three wires, must be protected by the cut-out and disconnected by the operation of the switch or circuit-breaker.

This, of course, does not apply to the grounded circuit of street railway systems.

The exceptions are in regard to motors of $\frac{1}{4}$ H. P. or less on circuits of not over 300 volts and incandescent cir-

uits of not over 660 watts where single pole switches are allowed. Further explanation of the exceptions will be given in connection with the rules mentioned; 21 *a* and *b*, and 22 *c*.

In connecting double-pole snap switches the wireman should be very careful. Most of these switches cross polarities as shown in Figure 67, and if connected wrong will form short circuits. Many of them have been connected that way, even by wiremen of some experience.

b. Must not be placed in the immediate vicinity of easily ignitable stuff or where exposed to inflammable gases or dust or to flyings of combustible material.

When the occupancy of a building is such that switches, cut-outs, etc., cannot be located so as not to be exposed to dust or flyings of combustible material they must be enclosed in approved dust-proof cabinets with self-closing doors, except oil switches and circuit breakers which have dust-tight castings.

Whenever an electric current is broken, whether by fuse or switch, an arc varying with the current strength is formed.



Figure 67.

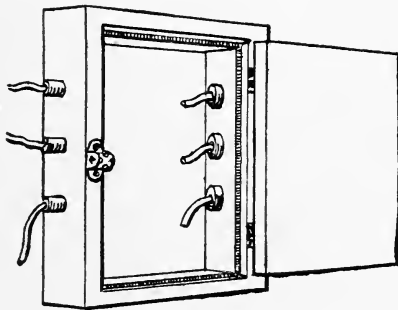

Figure 68.

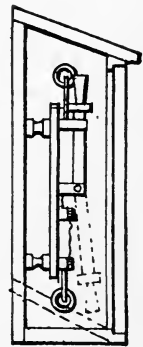

Figure 69.

Should a switch be only partly opened, this arc will continue and consume the metal of the switch until the gap in which it burns becomes too long, when the current will be broken.

Meanwhile there is much heat generated which may readily communicate to inflammable materia. near by.

There seems to be no reason except economy of wire why cut-outs should ever be placed inside of dust rooms. Switches of course must often be placed in such rooms, as in many cases the entire building outside of the engine room is dusty. In such cases the switches as well as the cut-outs may, however, be often placed on the outside walls convenient to some window.

An approved cabinet is shown in Figure 68. If used in connection with knife switches it should be large enough to admit being closed when the switch is open. In cases where cut-outs and switches must be located in dusty rooms, it would be well to construct double cabinets, one part for the cut-outs and another for the switches. The fuses, which are the most dangerous, can then be tightly enclosed, as it will seldom be necessary to get at them. In practice it has been found almost impossible to keep the doors of cabinets which are much used closed. It seems next to impossible to construct a cabinet which is dust proof, with a door that can be readily opened, and a self-closing door can hardly be made to remain dustproof. Doors are made self-closing either through gravity or by suitable springs.

As switch and cut-out boxes are very likely to be used for the storage of cotton waste, paper, etc., which would readily ignite from a melted fuse, it would be well to construct them with a slanting bottom as indicated by the dotted line in Figure 69, so that nothing will lie in them.

c. Must, when exposed to dampness, either be enclosed in a waterproof box or mounted on porcelain knobs.

The cover of the box should be so made that no moisture which may collect on the top or sides of the box can enter it.

Figure 69 is a sectional side view of a cut-out box for use

out of doors. In it the switch is mounted on porcelain knobs. In all damp places much trouble is experienced from leakage through the moisture on the surface of the slate or marble and through the wax used to cover the bare parts on back of switch.

d. Time switches, sign flashers and similiar appliances must be of approved design and enclosed in a steel box or cabinet lined with fire-resisting material.

If a steel box is used, the minimum thickness of the steel must be 0.128 of an inch (No. 8 B. & S. gage).

If a cabinet is used, it must be lined with marble or slate at least $\frac{3}{8}$ of an inch thick, or with steel not less than 0.128 of an inch thick. Box or cabinet must be so constructed that when switch operates blade shall clear the door by at least one inch.

Special attention should also be given to the location of such switches and flashers. They are often left without care, the blades wear down and the arcing continues through bad contacts. Often springs become weak and no longer break the circuit properly.

Time switches are usually operated by clockwork, the clock releasing a spring which throws the switch on or off as may be required and pre-determined. Complete diagrams of sign flashers are given in "*Modern Wiring Diagrams and Descriptions*" and will not be repeated here.

CONSTANT-CURRENT SYSTEMS.

18. Principally Series Arc Lighting Wires.

(See also Nos. 14, 15 and 16.)

a. Must have an *approved* rubber insulating covering (see No. 41).

b. Must be arranged to enter and leave the building

through an *approved* double-contact service switch (see No. 51 *b*), mounted in a non-combustible case, kept free from moisture, and easy of access to police or firemen.

In order that all of the wiring in the building may be entirely disconnected a switch, the principle of which is illus-

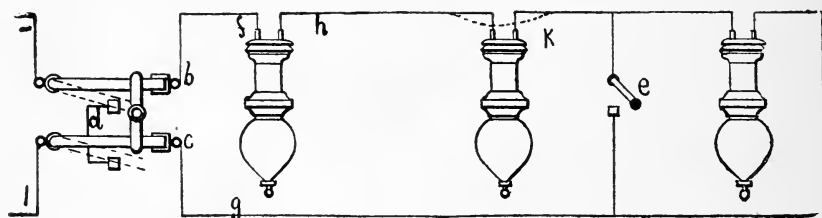

Figure 70.

trated at *d*, Figure 70, is provided where wires enter and leave the building. A modern commercial form of this switch is shown in Figure 71. This switch never breaks the circuit. As shown in Figure 70, the current passes from the positive pole, through the upper blade of the switch to *b* and thence through the arc lamps back to *c* and to the negative pole. When it is desired to extinguish the lamps the two blades of the switch are moved downward, as indicated by the dotted lines. The contacts *d* are arranged so that both switch blades connect with them before disconnecting entirely from the points *b* and *c*. As soon as both blades are in contact with *d* all current flows through it because the resistance of it is so very much less than that of the lamps. With the switch in the position indicated by dotted lines, the current still flows in the outside wires, but all wires within the building are "dead." At *e*, Figure 70, is shown a single-pole switch which

operates on the same principle as the other. If this switch is closed all current will pass through it; if open the current will pass through the last lamp. A switch of this kind is always arranged within the lamp itself. This latter way of switching lamps should never be used, as a lamp switched in this way is never safe to handle. There is just as much danger from shocks when the lamp is switched off as when on.



Figure 71.

With switches as described above there is no spark whatever when lamps are switched off, but there is usually quite an arc when the lamps are switched in. Should there be a broken wire or a lamp out of order in the circuit to be switched in, there will be quite an arc maintained for some time. In such a case the switch should be quickly closed and the trouble located.

In handling live wires of this system great care is necessary. The wireman should insulate himself from the ground by a dry board, or, if all about him is damp, by a board resting on insulators. Rubber gloves and rubber boots, if kept dry, are useful.

Death or bad burns may result if the wireman, standing on wet ground or any conductor in connection with it, touches part of a circuit which is also partly in connection with the ground. If, in Figure 70, the wire at *f* is grounded, a man in connection with the ground and touching a bare wire at *h* will

receive a shock due to about 50 volts, but if he touches the wire at *g* he will receive a shock of about 150 volts. The shock received from a line containing 100 lamps may be anything from 50 to 5,000 volts, and may result in only a slight burn or in instant death.

Another danger in connection with live circuits is the liability of cutting oneself into circuit. If one is perfectly insulated from the ground there is no harm whatever in touching one live wire (with very high voltages such insulation is, however, hard to obtain) with either one or both hands while the wires are in order. Should, however, the wire between the two hands break, the current would immediately pass through the body, very likely causing instant death. Even if the circuit is not entirely broken, if only a resistance is cut in, the shock will be very severe. As, for instance, if one should touch the terminal of an arc lamp, not burning, with each hand nothing whatever would be felt, but, if the lamp were now suddenly switched on, there would be a very severe shock at first, which would become less so when the lamps were fairly started. To avoid the possibility of such occurrences when working on live lamps or circuits a short wire known as a "jumper" is often connected, as at *k*, Figure 70. This will carry all current, and there is now no danger except from a connection to ground.

c. Must always be in plain sight, and never encased, except when *required* by the Inspection Department having jurisdiction.

What is known as concealed knob and tube work is not allowed in wiring for H. T. arcs; neither can the wires be run in moulding or conduit.

It has been customary to use no smaller than No. 6 wire for these high tension series circuits. The current required is seldom more than 10 amperes, and No. 14 wire has sufficient

carrying capacity, but its mechanical strength is not very great. The danger from a broken wire in high tension systems is much greater than in low tension systems, because of the long arc which occurs at the break. The loss in volts per 100 feet with No. 6 will be about .4, while with No. 14 it will be 2.6. While this will not affect the lights, the pressure at the generator being correspondingly increased, the question of drop is of importance. On a circuit 10 miles long a No. 14 wire would have a drop of 1372 volts and a No. 6 wire a drop of 211 volts.

d. Must be supported on glass or porcelain insulators, which separate the wire at least one inch from the surface wired over, and must be kept *rigidly* at least eight inches from each other, except within the structure of lamps, on hanger-boards or in cut-out boxes, or like places, where a less distance is necessary.

An extra precaution often taken in this kind of work on plastered walls is to place a wooden block or rosette about three inches in diameter and one-half inch thick under each insulator; this secures greater separation from ceilings and side walls and adds greatly to the stability of the insulators. On plastered walls a small insulator, if subjected to side strain, will cut into the plaster on one side and allow the wires to sag; the wooden block will prevent this.

e. Must, on side wall, be protected from mechanical injury by a substantial boxing, retaining an air space of one inch around the conductors, closed at the top (the wires passing through bushed holes), and extending not less than seven feet from the floor. When crossing floor timbers in cellars, or in rooms where they might be exposed to injury, wires must be attached by their insulating supports to the under side of a wooden strip not less than one-half an inch in thickness. Instead of the running-boards, guard strips on each side of and close to the wires will be accepted. These strips

to be not less than seven-eighths of an inch in thickness and at least as high as the insulators.

Except on joisted ceilings, a strip one-half of an inch thick is not considered sufficiently stiff and strong. For spans of say eight or ten feet, where there is but little vibration, one-inch stock is generally sufficiently stiff; but where the span is longer than this or there is considerable vibration, still heavier stock should be used.

Figure 72 is an illustration of protection on side walls, giving the dimensions required. The wooden block shown, which raises bushings above floor, is an extra protection to prevent water from running into them.

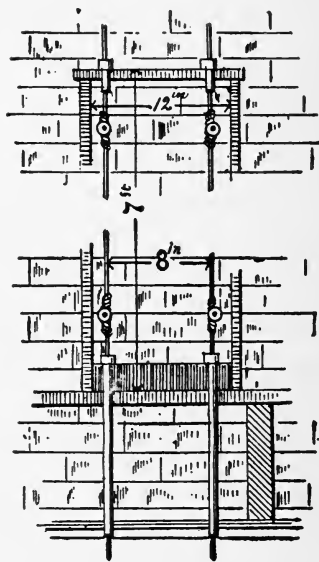

Figure 72.

19. Series Arc Lamps.

(For construction rules, see No. 57.)

- a. Must be carefully isolated from inflammable material.
- b. Must be provided at all times with a glass globe surrounding the arc, and securely fastened upon a closed base. Broken or cracked globes must not be used.
- c. Must be provided with a wire netting (having a mesh not exceeding one and one-fourth inches) around the globe, and an *approved* spark arrester (see No. 58), when readily inflammable material is in the vicinity of the lamps, to prevent escape of sparks of carbon or melted copper. It is recommended that plain carbons, not copper-plated, be used for lamps in such places.

Outside arc lamps must be suspended at least eight feet above sidewalks. Inside arc lamps must be placed out of reach or suitably protected.

Arc lamps, when used in places where they are exposed to

flyings of easily inflammable material, should have the carbons enclosed completely in a tight globe in such manner as to avoid the necessity for spark arresters.

"Enclosed arc" lamps, having tight inner globes, may be used, and the requirements of sections b and c above would, of course, not apply to them, except that a wire netting around the inner globe may in some cases be required if the outer globe is omitted.

d. Where hanger-boards (see No. 56) are not used, lamps must be hung from insulating supports other than their conductors.

At the left, Figure 73, is shown the usual method of suspending outdoor arc lamps on buildings. The supporting wire may be fastened to brick or stone walls by drilling a hole about four inches deep and plugging this securely with wood, when an eye or lag bolt or large spike may be driven or screwed into it. Expansion bolts, of which there are many kinds to be had, may also be used. It is best to arrange the

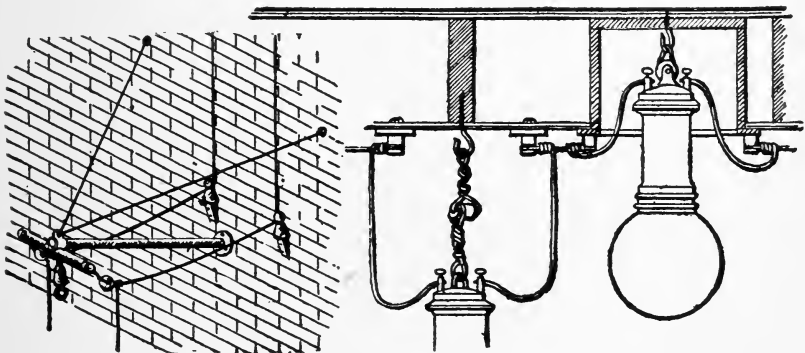

Figure 73.

supporting wires at quite a high angle, otherwise the direct outward pull may be too great. Some of the older arc lamps are not provided with insulators, and may be suspended, as shown in the center of the figure. On very low ceilings, lamps are often arranged as shown at the right, the plastering

being cut away and lamp suspended from floor above joists. The space above plaster must be enclosed on all sides and all woodwork protected with asbestos board at least one-eighth inch thick.

If this method is used with constant potential arc lamps carrying resistance in the hood, it would be well to remove or short-circuit this resistance and locate another in a more suitable place.

e. Lamps when arranged to be raised and lowered, either for carboning or other purposes, shall be connected up with stranded conductors from the last point of support to the lamp, when such conductor is larger than No. 14 B. & S. gage.

20. Incandescent Lamps in Series Circuits.

a. Must have the conductors installed as required in No. 18, and each lamp must be provided with an automatic cut-out.

b. Must have each lamp suspended from a hanger-board by means of rigid tube.

c. No electro-magnetic device for switches and no multiple-series or series-multiple system of lighting will be approved.

d. Must not under any circumstances be attached to gas fixtures.

CONSTANT-POTENTIAL SYSTEMS.

GENERAL RULES—ALL VOLTAGES.

21. Automatic Cut-Outs (Fuses and Circuit-Breakers).

(See No. 17, and for construction, Nos. 52 and 53.)

Excepting on main switchboards, or where otherwise subject to expert supervision, circuit-breakers will not be accepted unless fuses are also provided.

The fuse is the principal protective device used in elec-

tric light and power work. In its simplest form it consists of a piece of wire made of a certain alloy designed to melt at a comparatively low temperature. It is so connected in the circuit that all the current must pass through it. We have already seen that currents of electricity generate heat in the conductors through which they pass, and that this heat is proportional to the square of the current flowing; that is, if we double the current we shall increase the production of heat fourfold. A dangerous rise in current strength may be due to a "short circuit" or to an overload, too many lamps or motors being connected to a circuit. To prevent damage to wires and other apparatus from excessive currents, fuses or cut-outs must be installed. When the current rises above its allowed strength the fuse melts and opens the circuit; that is, stops all current flow. The melting of the fuse is accompanied by a flash of fire due to the arc which is set up across the break in the fuse wire. On an ordinary overload with the smaller size fuses this arc may not be very severe, but with the larger size fuses and on short circuits a very severe flash and explosion may result and molten metal may be thrown for some distance from the fuse. This explosion is caused by the outer layers of metal of the fuse remaining cool and in a solid state while the metal at the center of the fuse is first melted and then vaporized.

Another device which is used for the same purpose as the fuse is known as the circuit-breaker. A circuit-breaker in its simplest form comprises a knife switch which when closed is forced in against a spring and held in place by means of a small catch. A solenoid, inside of which is placed a moveable iron core, is connected in series with one side of the switch. When the current passing through this solenoid exceeds a certain amount, the iron core is drawn up into it,

and, striking against the catch, releases the switch which will then fly open, thus cutting off the current. The core of this solenoid is so designed that when it starts to move its speed is greatly accelerated so that it strikes the catch a sharp blow. By means of a small adjusting screw the circuit-breaker can be set to operate at various current strengths within its limits. For this reason and for the further reason that it is so easily made inoperative by tying or blocking its solenoid it is not approved for general use unless fuses are also installed. It may be used under the care of a competent electrician who understands the dangers of its abuse.

Under these conditions its use is to be strongly recommended. Where not so used fuses must also be provided in the same circuit with the circuit breaker. For further information in reference to the use of circuit breakers see section on Generators, Page 58.

a. Must be placed on all service wires, either overhead or underground, as near as possible to the point where they enter the building and inside the walls, and arranged to cut off the entire current from the building.

Where the switch required by No. 22 *a* is inside the building, the cut-out required by this section must be placed so as to protect it.

For three-wire (not three-phase) systems the fuse in the neutral wire may be omitted, *provided the neutral wire is of equal carrying capacity to the larger of the outside wires, and is grounded as provided for in No. 13 A.*

In risks having private plants, the yard wires running from building to building are not generally considered as service wires, so that cut-outs would not be required where the wires enter buildings, provided that the next fuse back is small enough to properly protect the wires inside the building in question.

The fuse block here required serves a double purpose; it affords protection to the whole installation while in use, and

is an effective means of disconnecting a building when current is no longer used. This can also be accomplished by means of the service switch, but a switch is so easily closed by any one that it must never be relied upon entirely for this purpose.

Figure 74 shows arrangement of fuses and switch as commonly installed where wires enter buildings. The wires enter at the top, connect to the fuse terminals, current passing through the fuses to the switch.

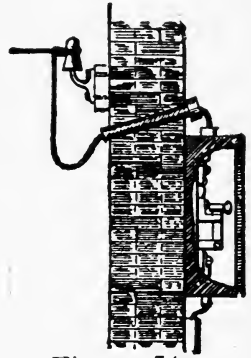

Figure 74.

This rule allows the neutral fuse to be omitted on three-wire systems where the neutral is grounded and where the neutral wire is of as great carrying capacity as the larger of the outside wires. On three-wire systems where the neutral wire is not grounded, as in the case of some isolated plants, fuses must be placed in all three wires, including the neutral wire. The reason for this is obvious. A ground coming on any part of the neutral wire of a three-wire grounded system cannot cause a short circuit. Referring to Figure 75, *G* shows the permanent ground and *B* a ground on any other point on the neutral wire. It is plain that the ground *B* cannot cause a short circuit, and the fuse in this wire may, therefore, be omitted. A ground coming on either of the outside wires, at *A* for instance, would be cleared by the fuse protecting that wire. In a system with an ungrounded neutral a single ground coming on one of the outside wires, as at *G'* for instance, would not cause a short circuit, but if the outside wire was grounded at *G'* and a ground should come on the neutral wire, at *B* for instance, a short circuit would immediately result and the neutral wire would

probably be destroyed owing to the fact that there is no fuse to protect it.

If the fuse is omitted in the neutral wire and a fuse on one of the outside mains should blow, the neutral wire would then be called upon to carry the same amount of current as was being carried in the remaining outside wire. For this reason the neutral wire must be of as great carrying capacity as the larger of the outside wires.

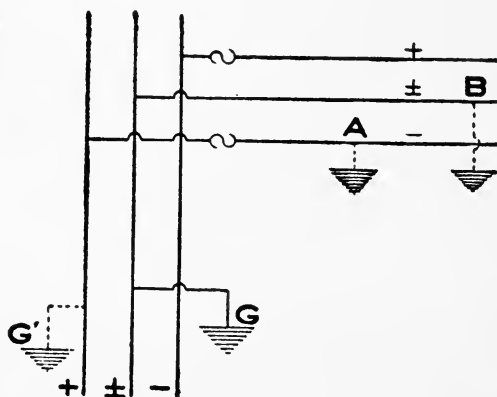

Figure 75

The danger arising from the blowing of the neutral fuse (which this rule is designed to prevent) is described under the next rule, 21 *b*.

b. Must be placed at every point where a change is made in the size of wire [unless the cut-out in the larger wire will protect the smaller (see Table of Carrying Capacity)].

For three-wire (not three-phase) systems, the fuse in the neutral wire, except that called for under No. 21 *d*, may be omitted, *provided the neutral wire is of equal carrying capacity to the larger of the outside wires, and is grounded as provided for in No. 13 A*.

Figure 76, A to D, shows systems of distribution and arrangement of mains in general use. Figure A shows the

simplest and cheapest method of running mains, and is known as the "tree system." Beginning at the service the wires must be large enough to carry the whole amount of current used to the first floor or wherever the first cut-out center is located. At this point the size of wire may be reduced because it will be required to carry only the current used further on. Main cut-outs should be arranged as shown in the figure at 1 and 2. That is, the cut-outs protecting the mains must be installed in the mains at each floor after the current for that floor has been taken off. Cases are often found where the cut-out is placed in the main line, ahead of the branch blocks. This is obviously wrong, as the fuse will have to be too heavy to protect the smaller mains.

Figure B shows a somewhat different arrangement which requires more wire and is more expensive in the beginning, but far more satisfactory and economical in operation. With the wires arranged as shown in the diagram the pressure at all the lamps will be nearly uniform. Even if the mains are designed for a considerable loss to the center of distribution the dynamo may be made to compensate for this loss and keep the lamps burning properly. With the tree system, A, this is impossible; the lamps at the first cut-out center will either be too bright or those at the last center too dim.

Figure C shows a convertible three-wire system.

In order to convert a three-wire system into a two-wire system the two outside wires are joined together. The middle wire then forms one side of the system and the outside wires the other. The middle wire must carry as much current as both outside wires combined and should have a carrying capacity equal to them. It should be remembered that a

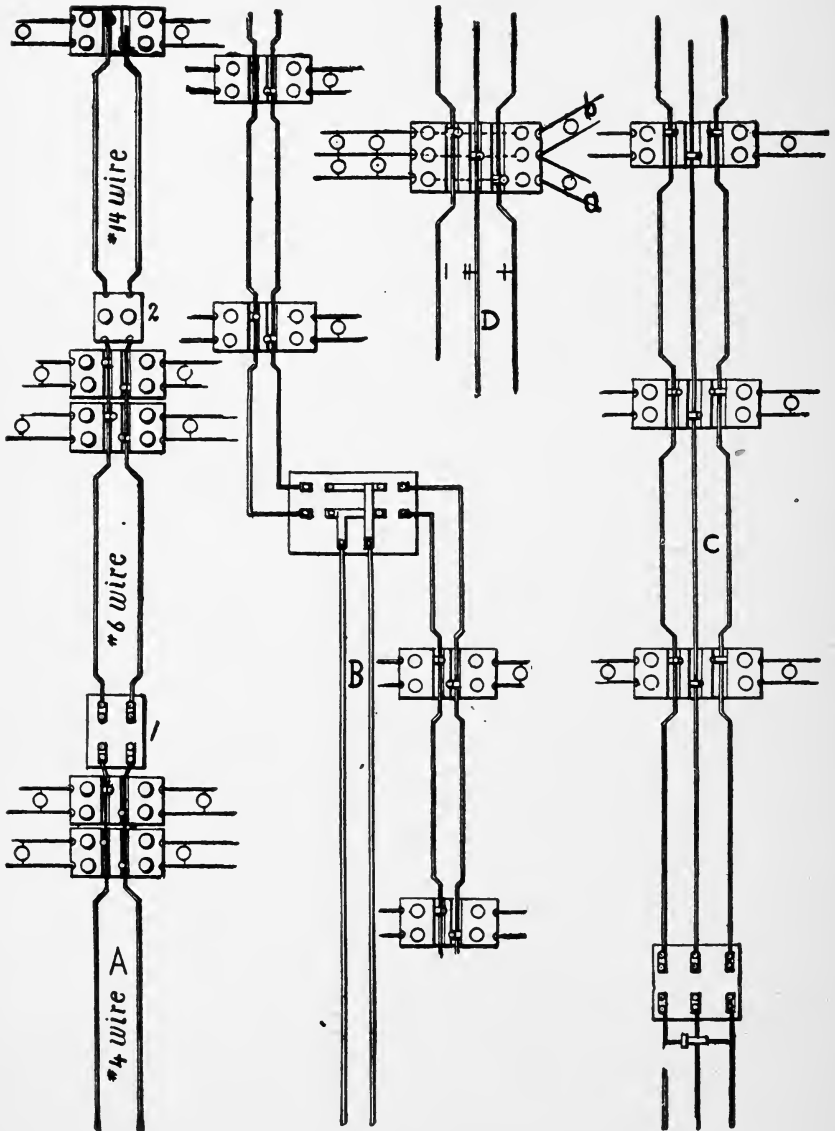

Figure 76.

wire containing simply twice as many circular mils does not fulfill this requirement, as is shown in Table No. I on page 312, which must be consulted in selecting wires.

In three-wire systems the middle or neutral wire is merely a balancing wire and normally carries very little or no current, but it is very important that it remain intact. If for instance in Figure D the branch circuit *a* has twelve lights burning while there are also twelve lights burning on *b*, the current will pass from the positive wire through the lower fuse to *a*, through the twelve lights in *a* back to the middle fuse, thence through the twelve lights in *b* to the upper fuse and negative wire, the two sets of lamps burning in series. If now the lamps in *b* are switched off the current from *a* can no longer pass through them and instead returns through the middle fuse to the neutral wire. If only six lights in *b* are burning, while twelve are burning in *a*, the current of six lights will return over the negative wire and the other six in *a* will return over the neutral wire. Should the neutral wire be broken or its fuse blown there would be no return path on it for the extra current, and consequently the current passing through the twelve lights in *a* would be forced to pass through the six lights in *b*, causing them to burn with excessive brilliancy and to break in a very short time. Should a short circuit occur, say on circuit *b*, with the neutral wire intact, it would merely blow out a fuse, but if the main neutral fuse were out it would bring 220 volts on circuit *a* and speedily cause damage to the lamps. Thus it will be seen that it is of great importance to fuse the neutral wire so that it will not easily blow out.

Figure C shows a system of wiring quite often used. A set of heavy mains are run from the service or dynamo to the top floor and taps taken off at each floor. These mains do not change size at each floor, but are continuous for their

entire length. While this method has some of the objections of the tree system in regard to voltage, still the faults of the tree system are greatly reduced owing to the much smaller losses in the mains between the upper floors, or those farthest from the dynamo.

Figure 77 shows the method of fusing main switch and branch circuits. The switch itself will require a fuse to protect it, although it need not be right at the switch.

It often becomes necessary to reinforce a set of mains, especially for motors, which have become overloaded, by running another wire in parallel with the old, as indicated in Figures 78 and 79. Two separate and distinct ways of ar-

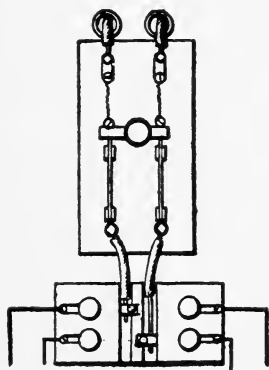

Fig. 77.



Fig. 78.



Fig. 79.

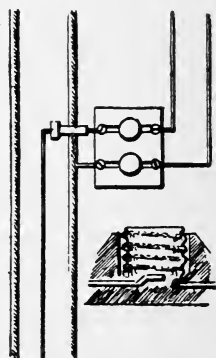

Fig. 80.

ranging them are shown and it depends upon the conditions as to which is preferable. If the wires are small or run in places where they are liable to be broken, the plan shown in Figure 78 is the better. Here each wire is properly fused and if one breaks the other carries the whole load until its fuse melts. If the wires, as often happens, are much overfused, the breaking of one wire would force the other to carry

the whole current and become overheated. If the arrangement were as in Figure 79 the unbroken wire would carry the current indefinitely and soon become overheated. On the other hand, if both wires are large and the run is short the fuses arranged as in Figure 78 may, through poor contacts, prevent one or the other of the wires from obtaining its full share of the current. The fuse making poor contact would force a much greater share of current through the other wire. In most cases the better plan would be to arrange the wires as in Figure 79. If the current supplied is for lights the branch cut-outs can be separated and each set of mains allowed to supply a certain part of them, when each set should be made independent. For sizes of wires to be used for reinforcing, see Tables.

With the three-wire system where a larger motor load and a few lights are run the lights are often fused as shown in Figure 80, a small wire being run for the neutral, this smaller wire, of course, being properly fused at the main cut-out. Plug cut-outs of the type shown in this figure often have the metal parts projecting above the porcelain; they should be connected so that the metal parts which project are dead when the plugs are removed. This will prevent many short circuits on disconnected cut-outs.

Figure 81 shows the method of converting a two-wire system into a three-wire system with one extra wire to run. This extra wire will very likely not need to be as large as the other wires are, because the three-wire system requires only one-half as much current and it should, therefore, be used as the neutral. This arrangement will secure the full benefit of all the copper in the old wires (which are probably much larger than necessary) and will operate at a very small loss.

Figure 82 shows a straight three-wire system changed to a two-wire system, one extra wire run for it. If the three

wires are of the proper capacity the addition of the fourth wire as in the figure will make it correct for two-wire sys-

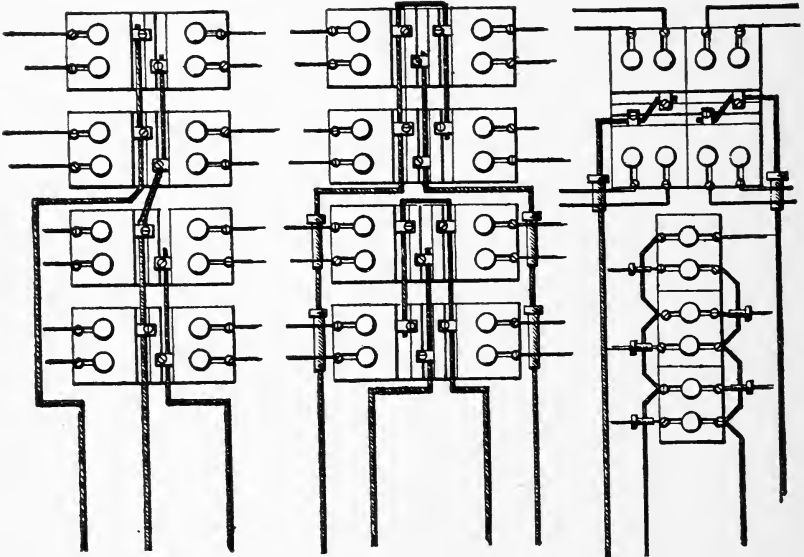

Figure 81.

Figure 82.

Figure 83.

tems, the mains feeding the upper and lower groups being, of course, properly fused where they start.

In Figure 83 the cut-outs are so connected that all branch wires leaving the cut-out box at either side are of the same polarity. This is often useful where many wires are to be run close together.

c. Must be in plain sight, or enclosed in an *approved* cabinet (see No. 54), and readily accessible. They must not be placed in the canopies or shells of fixtures.

The ordinary porcelain link fuse cut-out will not be approved. Link fuses may be used only when mounted on slate or marble bases conforming to No. 52, and must be enclosed in dust-tight, fireproofed cabinets, except on switchboards located well away from combustible material, as in the ordi-

nary engine and dynamo room and where these conditions will be maintained.

While it is required that cut-out cabinets be accessible there is also danger in making them too accessible, for such cabinets are very often used for storage of paper or cotton waste. It would seem that about seven feet above the floor is the most desirable height to place them or the cabinet may be arranged with a slanting bottom which will make it impossible to store anything in it. It is also well to locate the cut-out cabinet away from inflammable material, for long experience has shown that doors are nearly always left open. Especially is this the case when switches are in the same cabinets with the cut-outs.

d. Must be so placed that no set of incandescent lamps requiring more than 660 watts, whether grouped on one fixture or on several fixtures or pendants, will be dependent upon one cut-out. Special permission may be given in writing by the Inspection Department having jurisdiction for departure from this rule, in the case of large chandeliers. (For exceptions, see No. 31 -A, *b*, 3 [*b*] and 4 [*b*] for border lights, see List of Fittings for rules for electric signs.) All branches or taps from any three-wire system which are directly connected to lamp sockets or other translating devices must be run as two-wire circuits if the fuses are omitted in the neutral, or if the difference of potential between the two outside wires is over 250 volts, and both wires of such branch or tap circuits must be protected by proper fuses.

The above rule shall also apply to motors when more than one is dependent on a single cut-out.

The fuses in the branch cut-outs should not have a rated capacity greater than 6 amperes on 110 volt systems and 3 amperes on 220 volt systems.

The idea is to have a small fuse to protect the lamp socket and the small wire used for fixtures, pendants, etc. It also lessens the chances of extinguishing a large number of lights if a short circuit occurs.

“On open work in large mills approved link fused rosettes may be used at a voltage of not over 125 and approved enclosed fused rosettes at a voltage of not over 250, the fuse in the

rosettes not to exceed 3 amperes, and a fuse of over 25 amperes must not be used in the branch circuit."

c. The rated capacity of fuses must not exceed the allowable carrying capacity of the wire as given in No. 16. Circuit-breakers must not be set more than 30 per cent above the allowable carrying capacity of the wire, unless a fusible cut-out is also installed in the circuit.

In the arms of fixtures carrying a single socket a No. 18 B. & S. gage wire supplying only one socket will be considered as properly protected by a six ampere fuse.

A 16 c. p. incandescent lamp is usually estimated at 55 watts and consequently the number of lamps allowed on one circuit is usually twelve, whether 110 or 220 volts are used. If voltages lower than 110 are used the current required by twelve 55 watts lamps will be too great, and fewer lamps should be used per circuit. Although a number of small fan motors may be run on one circuit each motor should be provided with a switch; as a rule such a switch is on the motor.

22. Switches.

(See No. 17, and for construction, No. 51.)

a. Must be placed on all service wires, either overhead or underground, in a readily accessible place, as near as possible to the point where the wires enter the building and arranged to cut off the entire current.

Service cut-out and switch must be arranged to cut off current from all devices including meters.

In risks having private plants the yard wires running from building to building are not generally considered as service wires, so that switches would not be required in each building if there are other switches conveniently located on the mains or if the generators are near at hand.

In overhead construction the best plan is to locate the switch at either front or rear of building so that wires may lead to it direct from pole. Avoid running wires on sides of building where it is likely that other buildings may be erected. In underground construction, where the space under

sidewalk and basement is not occupied, it is advisable to place a cut-out where wires enter the building from street and to locate the service switch in a more accessible place.

Although the rules do not call for switch to be installed in each separate building in the case of large plants, still it is often advisable to install them, for in case of trouble it is necessary that the current can be immediately shut off. A switch is also useful in cases of trouble on the wiring, to allow of repairing.

b. Must always be placed in dry, accessible places, and be grouped as far as possible. (See No. 17 *c.*) Single-throw knife switches must be so placed that gravity will tend to open rather than close them. Double-throw knife switches may be mounted so that the throw will be either vertical or horizontal as preferred.

When possible, switches should be so wired that blades will be "dead" when switch is open.

If switches are used in rooms where combustible flyings would be likely to accumulate around them, they should be enclosed in dust-tight cabinets. (See note under No. 17 *b.*) Even in rooms where there are no combustible materials it is better to put all knife switches in cabinets, in order to lessen the danger of accidental short circuits being made across their exposed metal parts by careless workmen.

Up to 250 volts and thirty amperes, approved indicating snap switches are advised in preference to knife switches on lighting circuits about the workrooms.

To comply with this rule will ordinarily bring the fuses of knife switches directly under the handle of switch. If there happens to be a short circuit on the wires when switch is closed the fuses will blow instantly and very likely burn the operator's hand. In connection with such switches cartridge fuses should be used or the switches, especially the larger ones, closed by pushing them in with a stick. The danger from opening a switch is much less.

Figure 84 shows a switch arranged to comply with all three points of this rule, the feed wires coming from below.

This requires that incoming and outgoing wires pass each other. In this case, the wires pass each other behind the

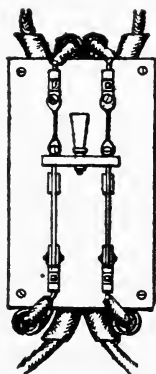

Figure 84.

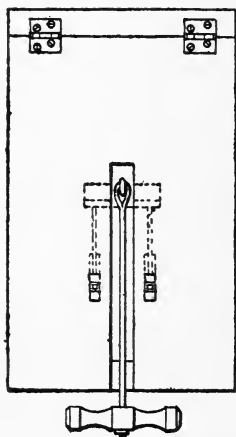
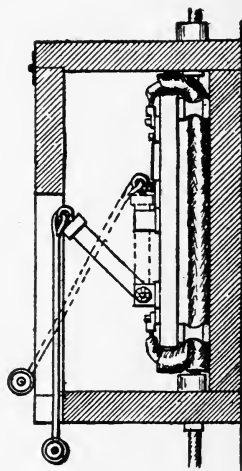

Figure 85.



switch base, they being encased in flexible tubing. A side view is also given in Figure 85. Instead of passing behind the switch the wires may, of course, run around one side to the top, the other wires around the other side to the bottom.

Figure 85 illustrates a cabinet so arranged that the switch within can be opened or closed without opening the cabinet. The cover is hinged at the top, and slotted in the center, which leaves room for the lever by which the switch is worked to adjust itself so it will always be out of the way. A switch which is often used may as well be left without a cover as with one, for the door must be opened or closed every time the switch is used, and the cabinet will always be found open. Figure 85 will answer where only protection against accidental contacts is required.

c. Single pole switches must never be used as service

switches nor placed in the neutral wire of a three-wire system, except in the two-wire branch or tap circuit described in 21, *d*.

This, of course, does not apply to the grounded circuits of street railway systems.

Three-way switches are considered as single pole switches and must be wired so that only one pole of the circuit is carried to either switch.

This rule allows the use of single pole switches on circuits of 660 watts, 6 amperes at 110 volts, or 3 amperes at 220 volts, which corresponds roughly to twelve 16 c. p. lamps. In systems that are not grounded a single pole switch will

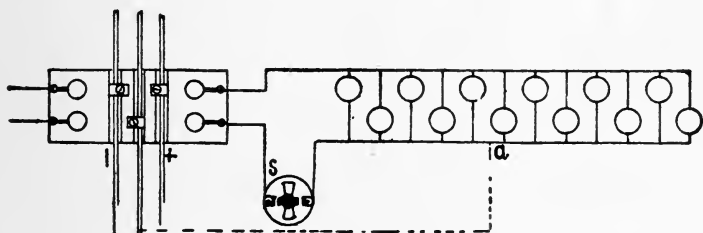

Figure 86.

answer fairly well if large enough. It will readily open the circuit and it offers no opportunities for short circuits, as do double pole switches. Where, however, three-wire systems with grounded neutrals are used double-pole switches are preferable, for by reference to Figure 86 one can readily see that if the neutral or middle wire is grounded (which is equivalent to being in connection with gas piping) and another ground should come onto the wiring say at *a*, the single-switch, *S*, would not control the lights at all. The current would flow from the positive wire to the top fuse, through the twelve lights to ground *a*, through the ground to the neutral or middle wire and back to the dynamo, regardless of whether the switch is on or off. Also, a man working at the lights could easily make a short circuit by bringing the wires

into contact with the gas piping even if the switch were turned off. When single-pole switches are used in connection with such circuits they should never be placed in the neutral wire as in the diagram. If the switch S were placed in the top wire these troubles would be avoided. Often times, however, switches are connected before the circuits are run into cut-outs and an attempt to place single-pole switches on a certain wire requires considerable care, which many wiremen will not take. In the case of only two wires from a central, three-wire, station being run into a building, the neutral wire is not known until meters are set and instructions would, therefore, have to be left for meter men which would often be disregarded, so that in all cases on three-wire grounded systems double-pole switches are preferable.

Three-way switches must not be used on circuits of over 660 watts. In wiring up three-way switches if both poles of the circuit are brought to the switch only one wire need be run between the switches, but where both poles of the circuit are connected into the switch the arc produced on operating the switch may carry from one pole to the other and cause a short circuit so that this method of wiring should never be used.

For full and comprehensive description of "three-way" switches the reader is referred to "Modern Wiring Diagrams and Descriptions" by the authors of this work.

d. Where flush switches or receptacles are used, whether with conduit systems or not, the switches must be enclosed in boxes constructed of iron or steel. No push buttons for bells, gas-lighting circuits, or the like shall be placed in the same wall plate with switches controlling electric light or power wiring.

This requires an *approved* box in addition to the porcelain enclosure of the switch or receptacle.

e. Where possible, at all switch or fixture outlets, a

$\frac{7}{8}$ -inch block must be fastened between studs or floor timbers flush with the back of lathing to hold tubes and to support switches or fixtures. When this cannot be done, wooden base blocks, not less than $\frac{3}{4}$ -inch in thickness, securely screwed to lathing must be provided for switches, and also for fixtures which are not attached to gas pipes or conduit tubing.

The above will not be necessary where outlet boxes are used which will give proper support for fixtures, etc.

Figure 87 shows concealed wiring back of lathing leading to a double-pole flush switch. The board fastened between studdings must be cut out to admit the box of switch and

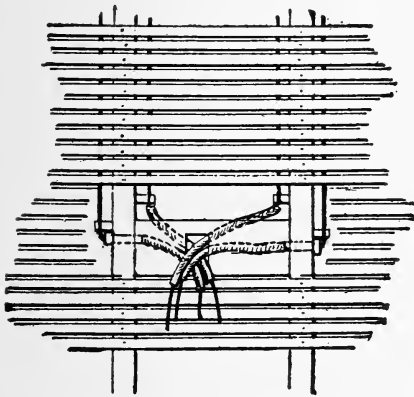

Figure 87.

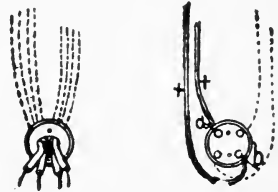

Figure 88.

the size of this box should be known when wires are put in. The board should not rest hard against the lathing, but leave a little space for plaster to work in behind the lath. Loom is put on all wires at outlets and must extend back to the nearest knob.

Figure 88 shows two methods of fastening snap switches by means of wooden blocks first fastened to the plaster. One block is cut out so as to bring all wires under the switch and entirely conceal them. The opening in block to admit

wires and bushings should be oblong, so as to leave room on two sides for the screws with which the switch is to be fastened. On the other block the wires and bushing are brought through close to the outer edge of switch base. By careful workmanship a neat job can be done in this way. As most snap switches cross conductors, that is, connect points *a* and *b*, if from the nature of the case it becomes necessary to run any of the wires close together these two wires may be run that way, for they can never be of opposite polarity.

f. Sub-bases of non-combustible, non-absorptive insulating material, which will separate the wires at least $\frac{1}{2}$ inch from the surface wired over, must be installed under all snap switches used in exposed knob and cleat work. Sub-bases must also be used in moulding work, but they may be made of hardwood.

23. Electric Heaters.

It is often desirable to connect in multiple with the heaters and between the heater and the switch controlling same an incandescent lamp of low candle power, as it shows at a glance whether or not the switch is open and tends to prevent its being left closed through oversight. Inspection Departments having jurisdiction may require this provision to be carried out if they deem it necessary.

a. Must be protected by a cut-out and controlled by indicating switches. Switches must be double pole except when the device controlled does not require more than 660 watts of energy.

b. Must never be concealed, but must at all times be in plain sight.

Special permission may be given in writing by the Inspection Department having jurisdiction for departure from this rule in certain cases.

c. Flexible conductors for smoothing irons and sad irons and for all devices requiring over 250 watts must comply with No. 45, *g.*

d. For portable heating devices the flexible conductors must be connected to an *approved* plug device, so arranged

that the plug will pull out and open the circuit in case any abnormal strain is put on the flexible conductor. This device may be stationary or it may be placed in the cord itself. The cable or cord must be attached to the heating apparatus in such manner that it will be protected from kinking, chafing or like injury at or near the point of connection.

e. Smoothing irons, sad irons, and other heating appliances that are intended to be applied to inflammable articles, such as clothing, must conform to the above rules so far as they

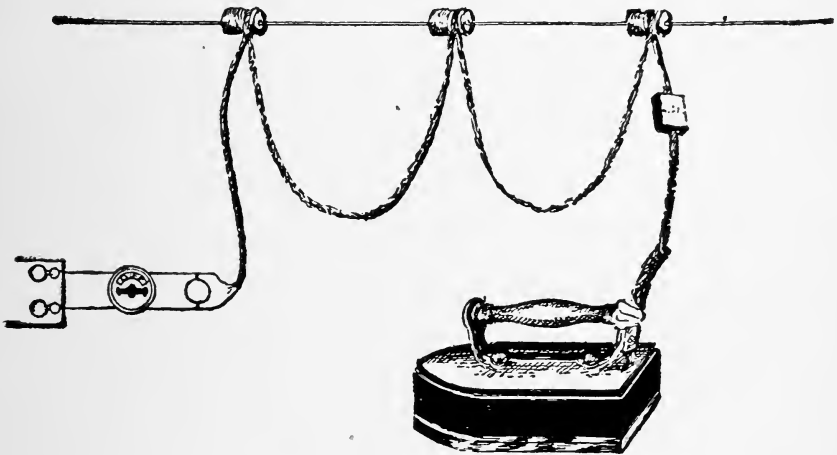

Figure 89.

apply. They must also be provided with an approved stand, on which they should be placed when not in use.

An approved automatic attachment which will cut off the current when the iron is not on the stand or in actual use is desirable. Inspection Departments having jurisdiction may require this provision to be carried out if they deem it advisable.

f. Stationary electric heating apparatus, such as radiators, ranges, plate warmers, etc., must be placed in a safe location, isolated from inflammable materials, and be treated as sources of heat.

Devices of this description will often require a suitable heat-resisting material placed between the device and its sur-

roundings. Such protection may best be secured by installing two or more plates of tin or sheet steel with a one-inch air space between or by alternate layers of sheet steel and asbestos with a similar air space.

g. Must each be provided with name-plate, giving the maker's name and the normal capacity in volts and amperes.

In Figure 89 is given a diagram of a heater circuit with a 4 c. p. lamp in circuit. Where there are many irons in use, as in some tailoring establishments, it is advisable to run them all from one set of mains with a main switch convenient to exit door and have this switch opened whenever the irons are not in use. The individual switch at each iron should be located as near as possible to each iron. Cords feeding irons or cloth cutting machines are often installed as shown, insulators are strung on a tight wire and the cord tied to them. This allows considerable latitude in moving the iron.

LOW-POTENTIAL SYSTEMS.

550 VOLTS OR LESS.

Any circuit attached to any machine, or combination of machines, which develops a difference of potential between any two wires, of over ten volts and less than 550 volts, shall be considered as a low-potential circuit, and as coming under this class, unless an approved transforming device is used, which cuts the difference of potential down to ten volts or less. The primary circuit not to exceed a potential of 3,500 volts unless the primary wires are installed in accordance with the requirements as given in No. 12 A, or are underground.

For 550 volt motor equipments a margin of ten per cent above the 550 volt limit will be allowed at the generator or transformer.

Before pressure is raised above 300 volts on any previously existing system of wiring the whole must be strictly brought up to all of the requirements of the rules at date.

24. Wires.

GENERAL RULES.

(See also Nos. 14, 15 and 16.)

a. Must be so arranged that under no circumstances will there be a difference of potential of over 300 volts between any bare metal parts in any distributing switch or cut-off cabinet, or equivalent center of distribution.

This rule is not intended to prohibit the placing of switches or single pole cut-outs for motor systems of voltage above 300 in cabinets, but would require that the cabinets be divided by *approved* barriers so arranged that no one section shall contain more than one switch nor more than one single pole cut-out.

This rule, as far as it applies to lighting systems or pressures higher than 300 volts, contemplates a three-wire system on which, instead of the customary 110 volts on each side

of the neutral, 220 volts are used, making a pressure of 440 volts between the two outside wires.

The ordinary 110-220 volt, three-wire system will require to be changed at cut-out centers as shown in Figure 90, where

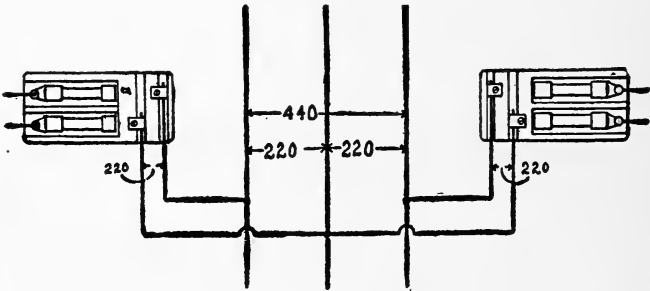

Figure 90.

it will be seen a difference of potential greater than 220 volts cannot be found within any cut-out box, or at any switch or cut-out.

Special attention should be given to the balancing of the load with this arrangement of wiring and both sides of the system should be brought into every room or hall requiring more than one circuit. False ideas of economy should not induce one to arrange large groups of lamps on one side of the system in order to save a few cut-out boxes.

b. Must not be laid in plaster, cement, or similar finish, and must never be fastened with staples.

c. Must not be fished for any great distance, and only in places where the inspector can satisfy himself that the rules have been complied with.

Figure 91 illustrates a very common combination of "fish" and "moulding" work. Moulding is used to bring the wires from the floor to the ceiling and along the ceiling to a point opposite the outlet and parallel with the joists. From this

point to the fixture the wires can then be readily fished.

The connection between the fish and moulding work should be made as shown at the right, where the moulding is cut out so as to admit the loom. It is better, even, to have the

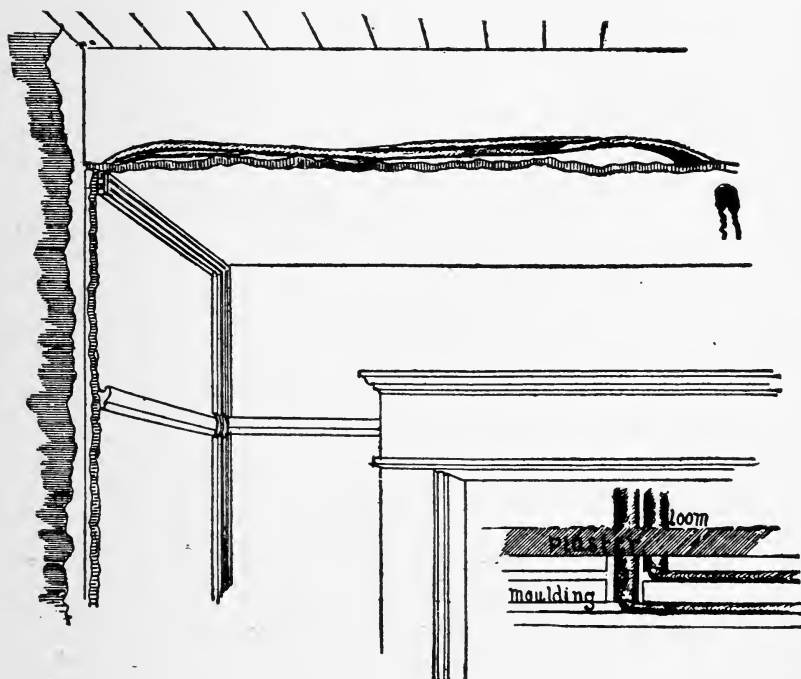

Figure 91.

loom show to some extent than to have the wire come in contact with the plaster, as will very likely be the case if the loom is not fully brought through.

d. Twin wires must never be used, except in conduits, or where flexible conductors are necessary.

Flexible conductors are in general considered necessary only with pendant sockets, certain styles of adjustable brack-

ets, portable lamps, motors and stage plugs, or heating apparatus.

e. Must be protected on side walls from mechanical injury. When crossing floor timbers in cellars, or in rooms where they might be exposed to injury, wires must be attached by their insulating supports to the under side of a wooden strip, not less than $\frac{1}{2}$ inch in thickness and not less than three inches in width. Instead of the running boards, guard strips on each side of and close to the wires will be accepted. These strips to be not less than seven-eighths of an inch in thickness and at least as high as the insulators.

Suitable protection on side walls should extend not less than five feet from the floor. This may be secured by substantial boxing, retaining an air space of one inch around the conductors, closed at the top (the wires passing through bushed holes) or by approved metal conduit, or pipe of equivalent strength.

When metal conduit or pipe is used, the insulation of each wire must be reinforced by *approved* flexible tubing extending from the insulator next below the pipe to the one above it, unless the conduit is installed according to No. 25 (sections c and f excepted), and the wire used complies with No. 47. The two or more wires of a circuit, *each* with its flexible tubing

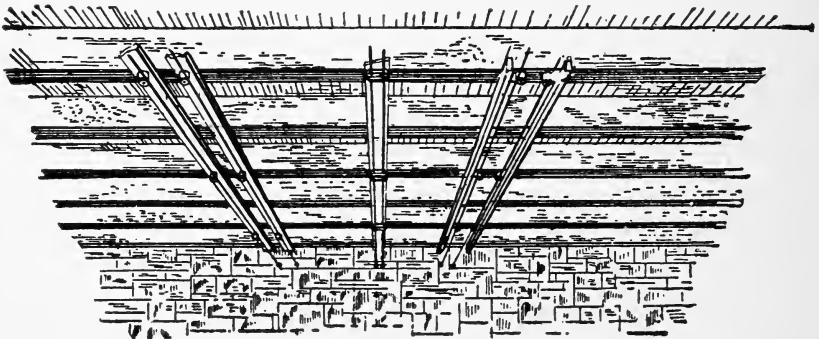

Figure 92.

(when required), if carrying alternating current *must*, or if direct current, *may* be placed within the same pipe.

In damp places the wooden boxing may be preferable because of the precautions which would be necessary to secure proper insulation if the pipe were used. With this exception, however, iron piping is considered preferable to the wooden

boxing, and its use is strongly urged. It is especially suitable for the protection of wires near belts, pulleys, etc.

f. When run in unfinished attics, will be considered as concealed, and when run in close proximity to water tanks or pipes will be considered as exposed to moisture.

In unfinished attics wires are considered as exposed to mechanical injury, and must not be run on knobs on upper edge of joists.

Figure 92 illustrates the meaning of the rule in regard to wires run along low ceilings.

Figure 93 gives the dimensions necessary for boxing wires on side walls. At the right, the side wall protection consists of conduit; a junction box with the lower side knocked out is used to enclose bushings. When the cover is screwed on the wires are completely enclosed.

SPECIAL RULES.

For Open Work.

In dry places.

g. Must have an *approved* rubber, slow-burning weather-proof, or slow-burning insulation (see Nos. 41, 42 and 43).

A slow-burning covering, that is, one that will not carry fire, is considered good enough where the wires are entirely on insulating supports. Its main object is to prevent the copper conductors from coming accidentally into contact with each other or anything else.

h. Must be rigidly supported on non-combustible, non-absorptive insulators, which will separate the wires from each other and from the surface wired over in accordance with the following table:

Voltage.	Distance from Surface.	Distance between Wires.
0 to 300	$\frac{1}{2}$ inch	2 $\frac{1}{2}$ inch
300 to 550	1 inch	4 inch

Rigid supporting requires, under ordinary conditions, where wiring along flat surfaces, supports at least every four and one-half feet. If the wires are liable to be disturbed, the distance between supports should be shortened. In buildings of

mill construction, mains of No. 8 B. & S. gage wire or over, where not liable to be disturbed, may be separated about six inches, and run from timber to timber, not breaking around, and may be supported at each timber only.

This rule will not be interpreted to forbid the placing of the neutral of an Edison three-wire system in the center of a

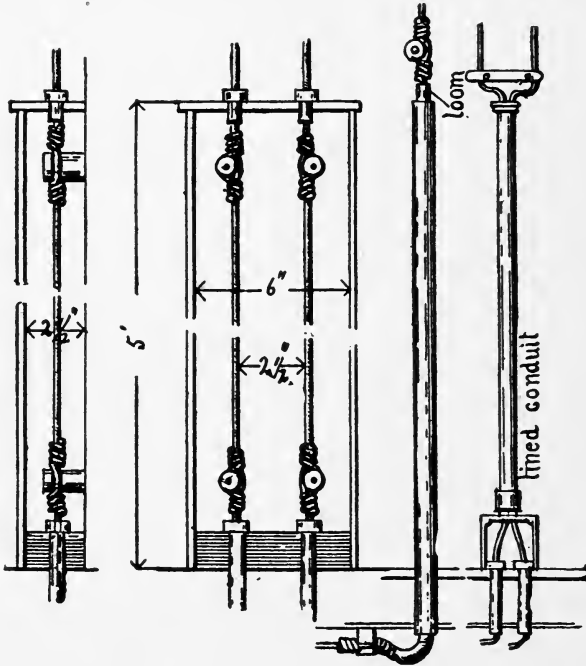

Figure 93.

three-wire cleat where the difference of potential between the outside wires is not over 300 volts, provided the outside wires are separated two and one-half inches.

Figure 94 shows different methods of running wires in buildings of mill construction. If the method shown at *a* is used, a few insulators should be placed here and there and the wires tied to them to prevent sagging. The arrangements shown at *b* and *c* are suitable for small wires on high ceilings.

The methods shown at *d* and *e* are sometimes used where

there is no danger of interference. With long spans, supports as shown at *f* may be used.

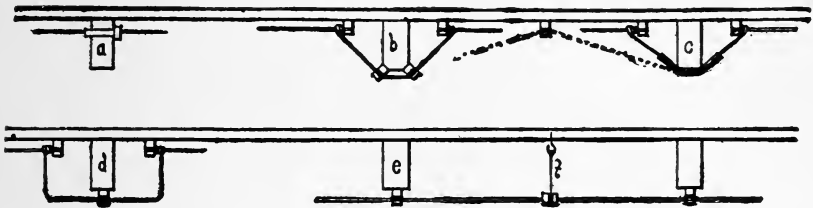

Figure 94.

In damp places, or buildings specially subject to moisture or to acid or other fumes liable to injure the wires or their insulation.

i. Must have an *approved* insulating covering.

For protection against water, rubber insulation must be used. For protection against corrosive vapors, either weather-proof or rubber insulation must be used. (See Nos. 41 and 44.)

j. Must be rigidly supported on non-combustible, non-absorptive insulators, which separate the wire at least one inch from the surface wired over, and must be kept apart at least two and one-half inches for voltages up to 300 and four inches for higher voltages.

Rigid supporting requires, under ordinary conditions, where wiring over flat surfaces, supports at least every four and one-half feet. If the wires are liable to be disturbed, the distance between supports should be shortened. In buildings of mill construction, mains of No. 8 B. & S. gage wire or over, where not liable to be disturbed, may be separated about six inches, and run from timber to timber, not breaking around, and may be supported at each timber only.

In damp places the wires are often run on the under side of an inverted trough as shown in Figure 95. The main point of usefulness of such a trough lies in the fact that it prevents drippings from wetting the wires and insulators. Condensation will, however, keep insulators and wires wet nevertheless.

The trough, to be useful, should be put together with many

screws, the butting edges of the boards having been first painted with a waterproof paint, with which, when finished, the whole trough is also painted inside and out.

Notwithstanding the rule given above, it would seem far better where practicable to use petticoat insulators and keep them much farther apart, even if, in order to do so, a larger wire would be required. Each insulator, when wet, allows some current to leak over its surface and, therefore, the fewer we have the better so long as there is no danger of breaking wires. If splices are necessary in wet places they should be made quite a distance from insulators, the insulation of a splice being always weaker than that of the unbroken wire. Care should also be taken that the insulation of wires be not damaged through tying.

Weather-proof sockets are required by the rule and are

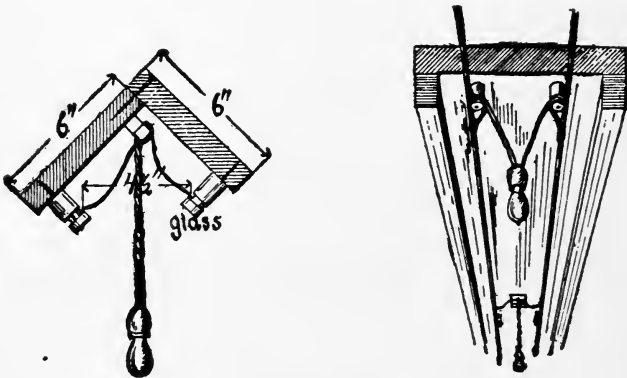

Figure 95.

best in such places when not subject to much handling. As these are, however, easily broken, brass shell sockets are often used. These are thoroughly covered with tape and compound so as to exclude all moisture and are very durable.

For Moulding Work (Wooden and Metal).

(For construction rules see No. 50.

See also No. 25 A.)

k. Must have an *approved* rubber insulating covering. (For wooden moulding see No. 41, for metal moulding see No. 47.)

l. Must never be placed in either metal or wooden moulding in concealed or damp places or where the difference of potential between any two wires in the same moulding is over 300 volts. *Metal* mouldings must not be used for circuits requiring more than 660 watts of energy.

As a rule, wooden moulding should not be placed directly against a brick wall, as the wall is likely to "sweat" and thus introduce moisture back of the moulding.

m. Must for alternating current systems if in metal moulding have the two or more wires of a circuit installed in the same moulding.

It is advised that this be done for direct current systems also, so that they may be changed to alternating systems at any time, induction troubles preventing such a change if the wires are in separate mouldings.

Figure 96 shows the dimensions of approved moulding.

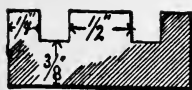

Figure 96.

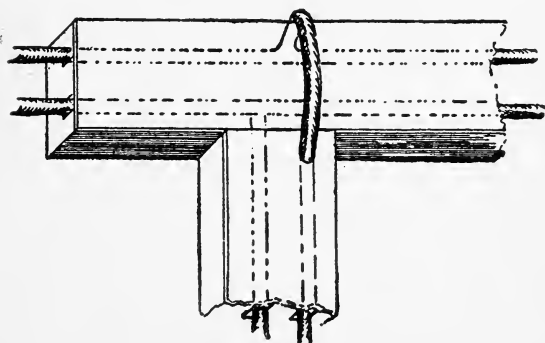

Figure 97.

Figure 97 shows the proper method of making a tap joint in moulding. This method brings the capping between the two

wires of opposite polarity. Wires should never be crossed below the capping. If the exposed wire in Figure 97 is objectionable, part of the back of moulding may be cut out, or the wall back of the moulding may be gouged out as shown in Figure 98. This method must, however, never be used with other than walls or partitions of hardwood.

Figure 99 shows proper method of tapping flexible cord to

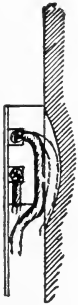

Fig. 98.

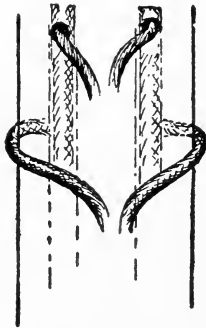

Figure 99.

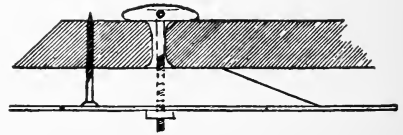

Figure 100.

wires in moulding. The whole cord should never be taken out of one hole in capping. There is always some chance of abrasion and joints are often poorly covered, so that there is always more likelihood of short circuits at this point.

Figure 100 shows how moulding should be fastened to tile ceiling. When toggle bolts are used, the nut should always be put on outside of capping (unless a very small one is used, or more than ordinary care is exercised). Many wiremen are careless and cut away the middle tongue too much, giving the nut a chance to work itself diagonally across it, so as to come in contact with both wires and, in time perhaps, cause short circuits. Although toggle bolts are mostly used, screws have been successfully used in tile. It is only necessary to first drill a hole of just the proper size for the screw to be used.

A very rough, quick way of making a square turn with

moulding is shown in Figure 101. One piece is cut entirely off along the line *a*; the pieces are then joined as shown and

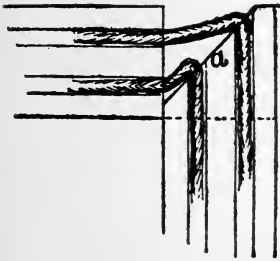

Figure 101.

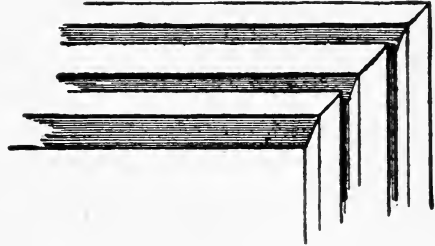

Figure 102.

the capping hides the botch work. Such work will not be passed by inspectors if noticed. The proper way of fitting moulding is shown in Figure 102.

Figure 103 shows methods of running around corners. The saw cuts, *a*, *b*, *c*, etc., should be made with a fine saw and for short bends require to be close together. Bending is

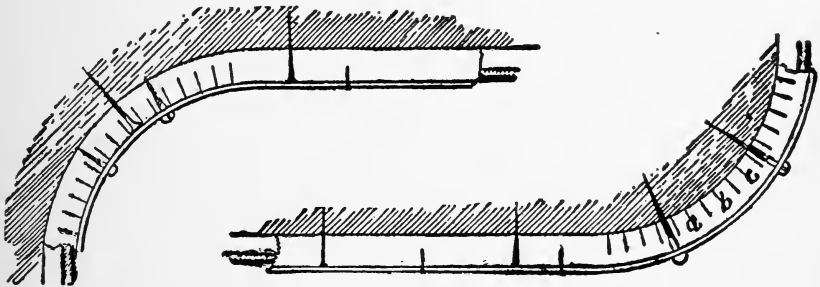

Figure 103.

facilitated by wetting the moulding, and if, before the moulding is put in place, the saw cuts are filled with glue, it will greatly add to the durability of the job. Screws or nails used in fastening the capping should pass through the moulding into the wall to get a firm hold.

For Conduit Work.

n. Must have an *approved* rubber insulating covering (see No. 47).

o. Must not be drawn in until all mechanical work on the building has been, as far as possible, completed.

Conductors in vertical conduit risers must be supported within the conduit system in accordance with the following table:—

No. 14 to 0 every 100 feet.

No. 00 to 0000 every 80 feet.

0000 to 350,000 C. M. every 60 feet.

350,000 C. M. to 500,000 C. M. every 50 feet.

500,000 C. M. to 750,000 C. M. every 40 feet.

750,000 C. M. every 35 feet.

A turn of 90 degrees in the conduit system will constitute a satisfactory support, as per above table.

The following methods of supporting cables are recommended:—

1. Junction boxes may be inserted in the conduit system at the required intervals, in which insulating supports of *approved* type must be installed and secured in a satisfactory manner so as to withstand the weight of the conductors attached thereto, the boxes to be provided with proper covers.
2. Cables may be supported in *approved* junction boxes on two or more insulating supports so placed that the conductors will be deflected at an angle of not less than 90 degrees and carried a distance of not less than twice the diameter of the cable from its vertical position. Cables so suspended may be additionally secured to these insulators by tie wires.

Other methods, if used, must be approved by the Inspection Department having jurisdiction.

Figure 104 shows different methods employed to fasten

wires in vertical runs in conduits. In the upper left-hand figure insulators are used, reinforced by metal straps so arranged that they will prevent the insulators from being pulled off sideways. The method shown in the lower figure is some-

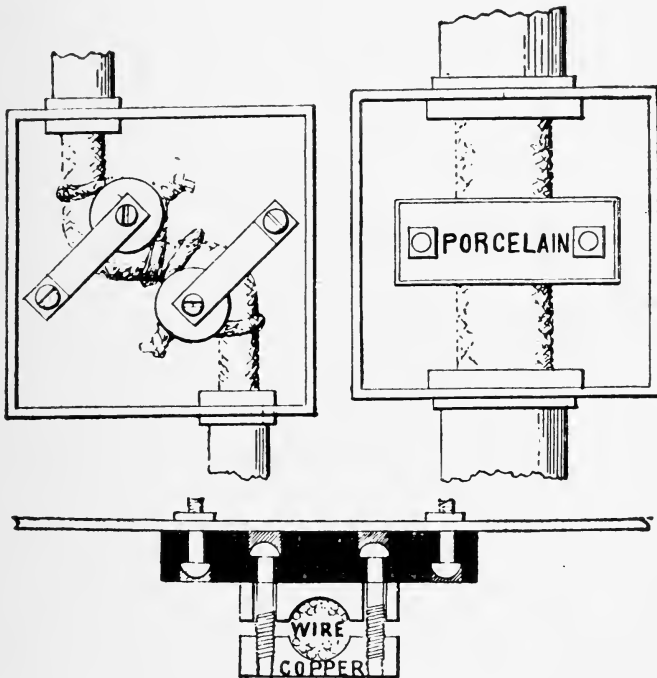

Figure 104.

times used with cables so heavy that the rubber insulation will not stand the strain of supporting them. The figure shows a clamp made of copper so that it can be soldered to the bare wires of the cable. This clamp is mounted on slate so as to furnish the insulation necessary for the cable.

p. Must, for alternating systems, have the two or more wires of a circuit drawn in the same conduit.

It is advised that this be done for direct-current systems

also, so that they may be changed to alternating systems at any time, induction troubles preventing such a change if the wires are in separate conduits.

The same conduit must never contain circuits of different systems, but may contain two or more circuits of the same system.

If a single wire carrying alternating currents of electricity were run in iron pipe there would be a very large drop in voltage. This drop is due to the fact that all currents while changing in strength generate a counter E. M. F. in their surroundings. This is particularly strong when the wires are surrounded by, or very close to, iron. If both wires are run in the same pipe the current in one wire neutralizes that of the other and there is no trouble.

For Concealed "Knob and Tube" Work.

q. Must have an *approved* rubber insulating covering (see No. 41).

r. Must be rigidly supported on non-combustible, non-absorptive insulators which separate the wire at least one inch from the surface wired over. Should preferably be run singly on separate timbers, or studdings, and must be kept at least five inches apart. Must be separated from contact with the walls, floor timbers and partitions through which they may pass by non-combustible, non-absorptive insulating tubes, such as glass or porcelain.

Rigid supporting requires, under ordinary conditions, where wiring along flat surfaces, supports at least every four and one-half feet. If the wires are liable to be disturbed, the distance between supports should be shortened.

At distributing centers, outlets or switches where space is limited and the five-inch separation cannot be maintained, each wire must be separately encased in a continuous length of approved flexible tubing.

Wires passing through timbers at the bottom of plastered partitions must be protected by an additional tube extending at least four inches above the timber.

s. When, in a concealed knob and tube system, it is impracticable to place the whole of a circuit on non-combustible supports of glass or porcelain, that portion of the circuit which cannot be so supported must be installed with *approved*

metal conduit, or *approved* armored cable (see No. 24 *t*), except that if the difference of potential between the wires is not over 300 volts, and if the wires are not exposed to moisture, they may be fished if separately encased in *approved* flexible tubing, extending in continuous lengths from porcelain support to porcelain support, from porcelain support to outlet, or from outlet to outlet.

An illustration of wiring on the "loop" system is shown in Figure 105. This system makes it unnecessary to have any

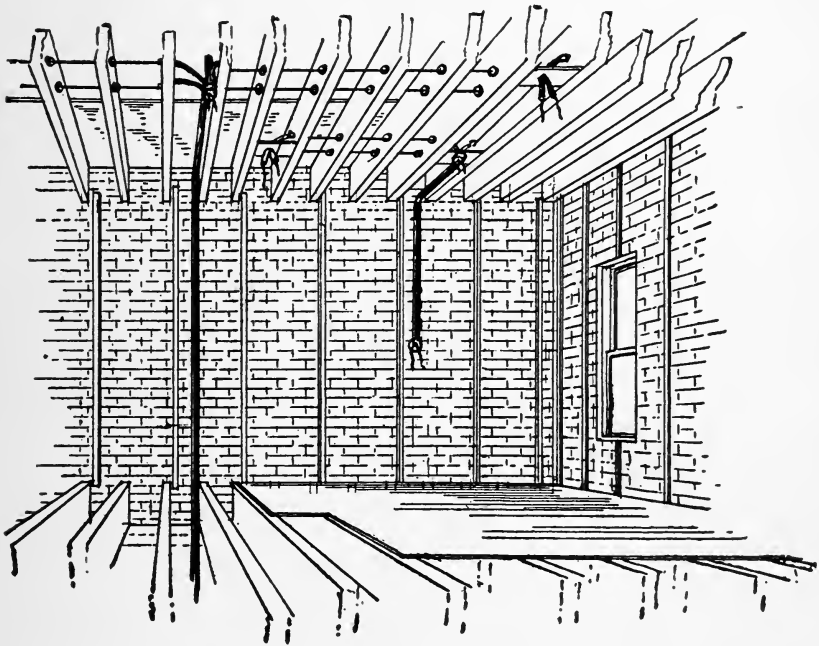

Figure 105.

concealed joints or splices. The amount of wire required is somewhat in excess of that required for tap systems, but this is often balanced by a saving in labor. Sometimes, however, the labor is also in excess of that required for tap systems.

The main advantage of the system is that all joints and splices are always accessible. The figure also shows mixed "knob and tube" work and "conduit" work. Along the walls behind the furring strips there is seldom sufficient space to admit of knob and tube work and conduit must be used.

t. Mixed concealed knob and tube work is provided for in No. 24 s, must comply with requirements of No. 24 n to p, and No. 25, when conduit is used, and with requirements of No. 24 A, when armored cable is used.

u. Must at all outlets, except where conduit is used, be protected by *approved* flexible insulating tubing, extending in continuous lengths from the last porcelain support to at least one inch beyond the outlet. In the case of combination fixtures the tubes must extend at least flush with outer end of gas cap.

It is recommended, but not required, that *approved* outlet boxes or plates be installed at all outlets in concealed "knob and tube" work, the wires to be protected by *approved* flexible insulating tubing, extending in continuous lengths from the last porcelain support into the box.

Figure 106 is drawn to illustrate "fish work." Fish work is used in finished buildings, mostly, and is often very tedious and expensive. Hours are sometimes spent before wires can be brought through and often the effort is an entire failure. In combination work, as shown in Figure 91, there is usually little trouble, as there is the whole span between joists to run wires in. An effort to fish at right angles to the joists (when there are strips under joists) is more difficult, but often successful if the distance is not too great.

When there are two men the usual method of fishing is: One man takes a wire sufficiently long to reach from one opening to the other, and, after bending a small hook on one end in such a way that it will not catch easily on obstructions, pushes this end into one opening and, by twisting and working backward and forward, gradually forces it toward the other

opening. At this opening his helper is stationed with a short wire, also provided with a hook, with which he must seek to catch the other wire when it comes near his opening. When the two wires come in contact, the larger one is drawn out and the conducting wires (encased in approved flexible tubing) are fastened to it and drawn through. The tubing should always be put on the wires before drawing in. If it is put on

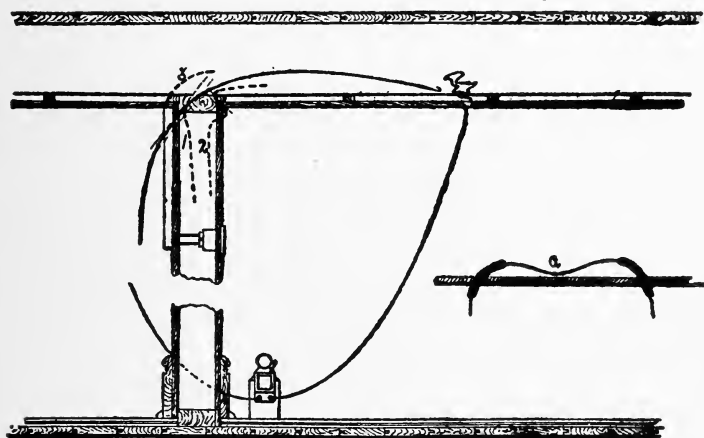

Figure 106.

later there is much temptation to leave it as indicated at the right of the figure at *a*. This trick is quite common, but is very easily detected by inspectors; the wire at either end can easily be pushed in without pushing out at the other, as it would if the tubing were continuous. If the tubing has been taped to the wires this will be impossible, but either one of the tubings can still be moved without moving the other, which would be impossible in a job properly done. The tubing must consist of one piece, and there must be only one wire in each tubing.

If one man is alone on a fish job, a handful of small wire

is pushed into one opening in a manner which will allow it to spread out considerably. When the fish wire from the other opening comes in contact with it, it will indicate it by moving this wire, which can be seen by that left hanging out. A small fish wire is then used to draw out the long one. If the two openings are in different rooms and not visible, one from the other, a bell and battery can be used, as shown in the drawing, if there are no wire lath.

When wires are to be entirely concealed it is nearly always necessary to find a way through headers, timbers, etc.; this can hardly be done without cutting holes in plaster. A method doing as little damage as any is shown at the top in Figure 106. A hole is bored through the 2×4 , which will allow the wire, when job is finished, to continue downward as shown by dotted lines, 1 and 2. Such turns are seldom ever used with electric light wires on account of their size; they are more practicable with bell or telephone wires.

Where it is desired to keep wires from showing in a parlor, for instance, they can be fished from an adjoining room, as indicated by dotted line 3, where the wires are run down partition in moulding in closet and then through to switch, which is in the same room with the lights. Before undertaking a job of fish work it is well to look the whole building over carefully. There are often false walls along chimneys, especially at both sides of mantels, in which wires can be easily run from basement to attic.

Often it may be necessary to remove baseboards in order to find room for wires. When removing such boards never attempt to drive nails out, always break them off; if driven out they will usually split off parts of the board.

Soft wood floors can easily be taken up when necessary. Use a broad thin chisel and cut away the tongue on each side of the board to be taken up; the board can then be readily

taken up. With double floors or with tightly laid hardwood floors, it is better to cut pockets in ceiling below.

For Fixture Work.

v. Must have an *approved* rubber insulating covering (see No. 46) and be not less in size than No. 18 B. & S. gage.

See No. 46, e, fine print note, for exceptions to the use of rubber-covered wire.

w. Supply conductors, and especially the splices to fixture wires, must be kept clear of the grounded part of gas pipes, and, where shells or outlet boxes are used, they must be made sufficiently large to allow the fulfillment of this requirement.

x. Must, when fixtures are wired outside, be so secured as not to be cut or abraded by the pressure of the fastenings or motion of the fixture.

y. Under no circumstances must there be a difference of potential of more than 300 volts between wires contained in or attached to the same fixture.

24 A. Armored Cables.

(For construction rules, see No. 48.)

a. Must be continuous from outlet to outlet or to junction boxes, and the armor of the cable must properly enter and be secured to all fittings, and the entire system must be mechanically secured in position.

In case of underground service connections and main runs, this involves running such armored cable continuously into a main cut-out cabinet or gutter surrounding the panel board, as the case may be. (See No. 54.)

b. Must be equipped at every outlet with an approved outlet box or plate, as required in conduit work. (See No. 49A.)

Outlet plates must not be used where it is practicable to install outlet boxes.

The outlet box or plate shall be so installed that it will be flush with the finished surface, and if this surface is broken it shall be repaired so that it will not show any gaps or open spaces around the edge of the outlet box or plate.

In buildings already constructed where the conditions are such that neither outlet box nor plate can be installed, these appliances may be omitted by special permission of the Inspect-

tion Department having jurisdiction, provided the armored cable is firmly and rigidly secured in place.

c. Must have the metal armor of the cable permanently and effectively grounded.

It is essential that the metal armor of such systems be joined so as to afford electrical conductivity sufficient to allow the largest fuse or circuit breaker in the circuit to operate before a dangerous rise in temperature in the system can occur. Armor of cables and gas pipes must be securely fastened in metal outlet boxes so as to secure good electrical connection. Where boxes used for centers of distribution do not afford good electrical connection, the armor of the cables must be joined around them by suitable bond wires. Where sections of armored cable are installed without being fastened to the metal structure of building or grounded metal piping, they must be bonded together and joined to a permanent and efficient ground connection.

d. When installed in so-called fireproof buildings in course of construction or afterwards if concealed, or where it is exposed to the weather, or in damp places such as breweries, stables, etc., the cable must have a lead covering at least $1/32$ of an inch in thickness placed between the outer braid of the conductors and the steel armor.

e. Where entering junction boxes and at all other outlets, etc., must be provided with approved terminal fittings which will protect the insulation of the conductors from abrasion, unless such junction or outlet boxes are specially designed and approved for use with the cable.

f. Junction boxes must always be installed in such a manner as to be accessible.

g. For alternating current systems must have the two or more conductors of the cable enclosed in one metal armor.

25. Interior Conduits.

(See also Nos. 24 n to p, and 49.)

The object of a tube or conduit is to facilitate the insertion or extraction of the conductors and to protect them from mechanical injury. Tubes or conduits are to be considered merely as raceways, and are not to be relied upon for insulation between wire and wire or between the wire and the ground.

The installation of wires in conduit not only affords the

wires protection from mechanical injury, but also reduces the liability of a short circuit or ground on the wires producing an arc, which would set fire to the surrounding material; the conduit being generally of sufficient thickness to blow a fuse before the arc can burn through the metal of the pipe. For this reason the wires should be entirely encased in metal throughout, both in the conduit and at all outlets. Another advantage derived from the use of iron conduit is the facility with which wires can be extracted and replaced in case a fault develops on any of them. The saving which this may mean in cases where the installation of new wires would necessitate the destruction of costly decorations can readily be seen. It must be remembered that the arc or burn produced by a short circuit or ground is proportional to the size of the fuse protecting the circuit. If a large fuse, say 30 amperes, is used to protect a branch circuit and a ground or short occurs on this circuit, the wire may become fused to the pipe so that it cannot easily be pulled out. This is one reason why fuses should be as small as practicable. More than six amperes is seldom used on branch circuits, so that no larger fuse than this should ordinarily be used. The installation of wires in iron conduit also reduces the liability of lightning discharges entering a building as the pipe surrounding the wires offers great resistance to the passage of these sudden currents.

Conduit is classed under two general heads, lined and unlined. In both classes of conduit the same thickness of metal is required.

a. No conduit tube having an internal diameter of less than five-eighths of an inch shall be used. Measurements to be taken inside of metal conduits.

This rule favors lined conduit inasmuch that it requires the same pipe for lined and unlined, and allows a lined conduit of less than five-eighths of an inch in diameter.

b. Must be continuous from outlet to outlet or to junction boxes, and the conduit must properly enter, and be secured to all fittings and the entire system must be mechanically secured in position.

In case of service connections and main runs, this involves running each conduit continuously into a main cut-out cabinet or gutter surrounding the panel board, as the case may be (see No. 54).

When conduit is used every run of pipe must end in accessible outlet boxes. This box may be a cut-out center, switch outlet, fixture outlet or a junction box. If a mixed form of wiring is used, where part of a circuit is run in conduit and the balance with some other form of construction, such as

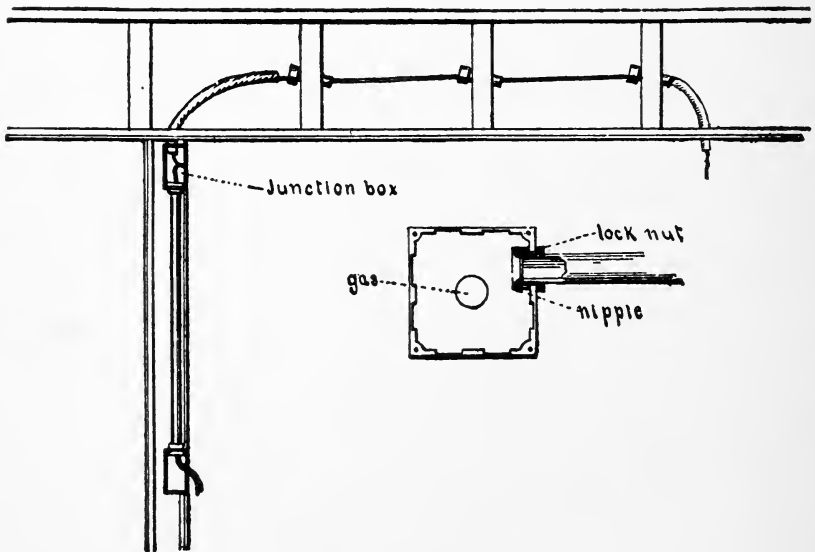

Figure 107.

concealed knob and tube work, for instance, the conduit must in all cases enter the box and be firmly attached to it, as shown in Figure 107. Cases are sometimes found where the

conduit is brought just to the box, but does not enter it, the wires being extended through holes into the box. This method of wiring is obviously wrong, as a wireman is apt to find if he ever has occasion to replace wires in such a system. The same holds true of cut-out centers. Here also every run of conduit must enter the box. The conduit should not simply be brought to the sides or the back of the cut-out center and the wires then carried to the cut-outs in flexible tubing, but every conduit should enter clear into the box so that when

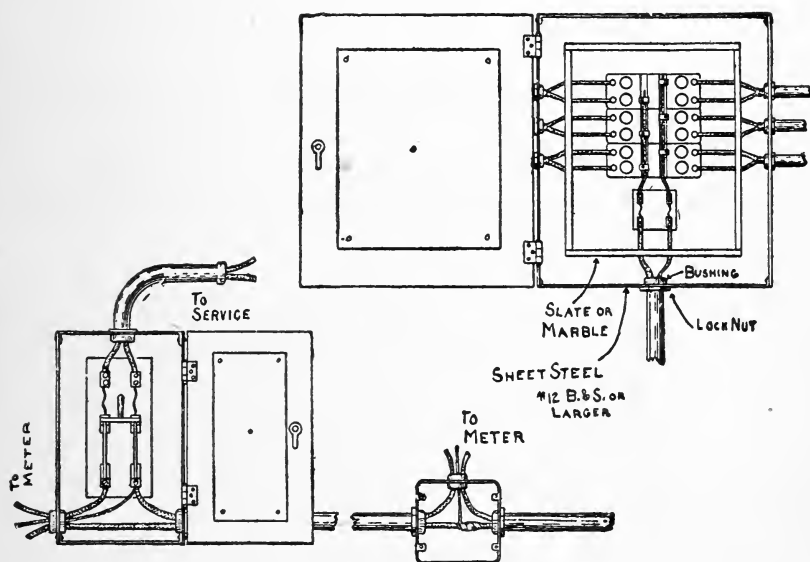

Figure 108.

the work is completed there will be no exposed wiring. In the case of main runs the conduit should enter the boxes and never be broken between the outlets. Sometimes it is necessary to install meters on the mains and the conduit is ended and the wires carried to the meters and then either extended

in conduit or carried into the cut-out center. This construction should be avoided. If a meter is to be installed near a cut-out center, the main conduit should be carried into the box and the necessary meter loops then brought out. In this way the quantity of wire outside of conduits is reduced to a minimum. If a meter is to be installed in some location along the mains other than at the cut-out center or service switch, a junction box should be provided and the meter loops brought out from that. This is shown in Figure 108, which also shows a cut-out box as used with conduit systems.

c. Must be first installed as a complete conduit system, without the conductors.

As fast as the conduit is installed, the ends of the pipes should be closed, using paper or corks. This does away with the liability of plaster or other substances entering the pipes and causing trouble when the wires are to be pulled in. The conductors should not be pulled in until all the mechanical work on the building is, as far as possible, finished. When a conduit system is ready for the wires, the "pulling in" may be done in various ways. For short runs, all that is necessary is to shove the wires in at one opening until they come out at the other. If a run is too long to be inserted in this way, what is known as a "fish wire" can be used. The ordinary fish wire is a flat band of steel about $5/32$ inch wide and $1/32$ inch thick. This wire can be forced through any ordinary length of pipe. Ordinary round steel wire of about No. 12 or 14 B. & S. gage can also be used, although this is not as good as the fish wire above described.

The end of the wire is first bent back so as to form a very small hook or eye; this will enable it to slide easily over obstructions in the pipe and also make it possible should it stick somewhere to engage it with another fish wire provided with

a suitable hook and entered from the other end of the pipe. This is very often necessary in runs having many bends. The fish wire, having been pushed through the pipe, is now fastened to the copper wire by means of a strong hook and the copper wire pulled into the pipe.

In pulling in the large size cables, it is often found advantageous to pull on the fish wire and at the same time push on the end of the cable entering the pipes. It is also well to remember that it is easier to pull down than to pull up, as, when pulling down, the weight of the cable assists. The use of soapstone facilitates the drawing in of the wires. The wire may either be covered with the powdered soapstone or the soapstone may be blown into the pipes. An elbow partly filled with soapstone is often found convenient for blowing the soapstone into the pipe, always blowing from the highest point.

Graphite or axle grease should never be used for this purpose, as the graphite is a conductor and the axle grease will rot the rubber insulating covering of the wire.

d. Must be equipped at every outlet with an *approved* outlet box or plate (see No. 49 A).

Outlet plates must not be used where it is practicable to install outlet boxes.

The outlet box or plate shall be so installed that it will be flush with the finished surface, and if this surface is broken it shall be repaired so that it will not show any gaps or open spaces around the edge of the outlet box or plate.

In buildings already constructed where the conditions are such that neither outlet box nor plate can be installed, these appliances may be omitted by special permission of the Inspection Department having jurisdiction, provided the conduit ends are bushed and secured.

The object of an outlet box is to hold the conduits firmly in place, to connect the various runs of conduit so that they form a continuous electrical path to the ground, and to afford a fireproof enclosure for the joints, switches, etc. Outlet

boxes are made in various designs to meet the requirements of the work on which they are to be used.

Where it is impossible to use an outlet box, an outlet plate can be used. These plates are fitted with set screws so that they hold the ends of the conduits firmly in position and make the metal of the system continuous. They do not afford a fireproof enclosure for the joints and for that reason should never be used when it is practicable to use an outlet box. If the conditions are such that neither an outlet box nor plate can be used, special permission can be obtained from the Inspection Department having jurisdiction to omit them. In this case the conduits should be bushed at the ends and the pipes should be bonded together.

e. Metal conduits where they enter junction boxes, and at all other outlets, etc., must be provided with *approved* bushings, fitted so as to protect wire from abrasion, except when such protection is obtained by the use of approved nipples, properly fitted in boxes or devices.

When a piece of conduit is cut with a pipe cutter, a sharp edge is left on the inside. This edge, if left on, would soon cut into the insulation of the wires. It should be removed by means of a pipe reamer. The bushing can now be screwed on as shown in Figure 107, a locknut having first been screwed onto the pipe. The locknut and bushing are then screwed up so that they are tight and form a good connection.

f. Must have the metal of the conduit permanently and effectually grounded.

It is essential that the metal of conduit systems be joined so as to afford electrical conductivity sufficient to allow the largest fuse or circuit breaker in the circuit to operate before a dangerous rise in temperature in the conduit system can occur. Conduits and gas pipes must be securely fastened in metal outlet boxes so as to secure good electrical connection. Where boxes used for centers of distribution do not afford good electrical connections, the conduits must be joined around them by suitable bond wires. Where sections of metal

conduit are installed without being fastened to the metal structure of buildings or grounded metal piping they must be bonded together and joined to a permanent and efficient ground connection.

That the metal in a conduit system should be permanently and effectually grounded is plainly evident when the hazards which are present with ungrounded or poorly grounded conduit are recalled. Until recently very little attention has been given to the matter of properly grounding conduits, but with the increased use the necessity of so doing has become very apparent. If the bare wire of one side of a system comes in contact electrically with the iron pipe and if there is a ground on the other side of the system (and there always is with 3-wire systems) the conduit becomes a conductor. If the conduit system is so installed that every piece is in good electrical connection and the entire system effectually grounded no harm will be done except the blowing of a fuse. Conduit is installed in all kinds of locations. It may be in contact with a gas pipe, lead pipe, or run in a damp floor, or it may be run exposed where a person could easily come in contact with it. The effects that might result from a conduit so run should the conduit become alive are readily seen. Suppose that in the first case the conduit crosses the gas pipe at right angles, the area of contact would be very small and the effect of the current in a livened conduit crossing this poor contact would result in burning a hole in the gas pipe and igniting the escaping gas. Again, suppose the conduit run in a damp floor should become alive; the damp woodwork, being a conductor, would soon char and the charred part would then readily ignite.

With a system which is grounded, an exposed piece of conduit will usually only be alive for a very short time during the blowing of the fuse. Even if it remains permanently alive, current will not flow from it to the surrounding

material, but will take the easiest path to ground, which is along the conduit. On the ordinary branch circuits, the various runs of conduit are bonded together through the outlet boxes and, in connecting the conduits to these boxes, care must be taken that they make good contact. In order to do this, the conduit should enter at right angles to the box and the enamel should be scraped away from the box so that the locknut and bushing make good electrical connection. The same thing should be done where the conduit enters the cut-out box. The metal of the cut-out box will bond together the various branch conduits and the main conduit. The main conduit should now be connected to some good ground, such as a water or steam pipe or metal work of the building. Never carry the ground wire to a gas pipe. The various branch conduits should also be grounded wherever possible, at and on metal beams over which they cross and at every gas outlet. The reason of grounding the gas pipe thoroughly at the gas outlets is to be sure of a good ground. The gas pipe is necessarily in contact with the outlet box at this point and any poor contact which might cause arcing must be avoided.

Strictly speaking, a conduit should be grounded with a wire equal to that used in the conduit. This can easily be done in the case of smaller circuits, but with the larger size mains it is a more difficult matter. Special devices for attaching the ground wire to both conduit and the grounded pipes are now on the market and should be used. When these are not obtainable a ground connection can be made by taking a number of good turns around the conduit and then soldering the wire to the conduit and taping the joint. A better way would be to use a few T couplings on the system and to screw brass plugs to these and solder the ground wire to the plugs. Such

couplings should be installed near outlets where they will not interfere much with "fishing."

If the ground wire has to be run for any great distance, it should be installed as though it were at all times alive, and should be kept away from inflammable material. The method advised under 13 A for grounding wires should be used. Where a 3-wire system is used, the best ground obtainable is the neutral wire of the system. When a ground is made to the neutral wire, it should be made back of the fuses on the service switch; never make the connection with the neutral inside of the service switch.

g. Junction boxes must always be installed in such a manner as to be accessible.

h. All elbows or bends must be so made that the conduit or lining of same will not be injured. The radius of the curve of the inner edge of any elbow not to be less than three and one-half inches. Must have not more than the equivalent of four quarter bends from outlet to outlet, the bends at the outlets not being counted.

If more than four quarter bends are necessary, a junction box should be installed and the wires first pulled from one of the outlets to the junction box and then from the junction box to the other outlet.

Several methods are in use for bending conduit. With the lined conduit elbows and bends of various shapes can be obtained already bent, and it is much more satisfactory to use these, as considerable care must be exercised in making bends in order to keep the inside lining from coming loose from the pipe and causing trouble when "pulling in." To prevent this a suitable spiral spring is sometimes inserted into the conduit before bending. Plumbers working with lead pipe often use coarse sand to fill the pipe before bending. This is more particularly useful with special conduits such as brass tubing,

which is sometimes used in showcase or window work and classed with fixtures.

With unlined conduits the bending is a simple matter, although here also care must be taken to see that the conduit does not bend flat. In a good bend the pipe retains its circular form throughout the bend, while, if the bend is poorly made, the pipe will assume an oval shape, flattening somewhat at the bend. The smaller size conduits can be bent in a common vise. This is best accomplished by gripping the pipe in the

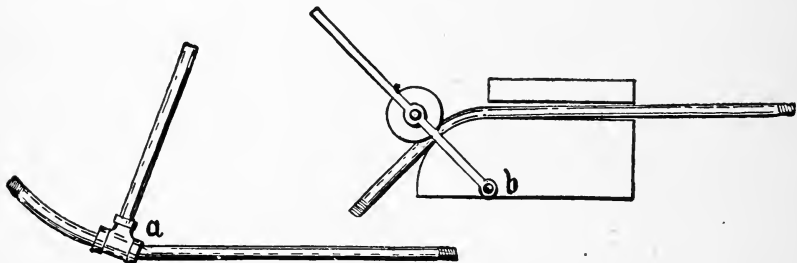

Figure 109.

vise and making a small bend, then moving the pipe for a slight distance and bending again, and continuing until the desired shape is obtained. Another method which can be used on small pipes is shown at *a* in Figure 109, using a three or four foot length of gas pipe or conduit with an ordinary gas pipe T on the end. This is run over the conduit and gives sufficient leverage to make any bend.

A simple device used for bending conduits is shown at *b* in Figure 109. This is constructed of metal, the wheel being grooved to fit the pipe. A similar device minus the wheel and lever may be made up of two blocks of wood firmly fastened to a work bench. The pipe can be bent around this by hand.

For the larger size conduits, elbows can be obtained already

bent. Connections between the various lengths of conduit are made with the ordinary gas-pipe couplings. When the conduit comes from the factory each length of pipe is provided with a coupling at one end. (This practice is now being discontinued, the couplings being left off.) This coupling should be removed and the end of the conduit reamed out. The reaming should always be done so that there is considerable metal left at the end of the pipe, and it should never be carried so far as to leave only a sharp edge. If a thread is to be cut, it is good practice to take a couple of turns with the reamer after this has been done. The coupling can then be screwed on. When making the connection, the pipes should be screwed into the coupling so that the ends just "butt." Do not attempt to screw them too tight, or, in all probability, the thread on the end



Figure 110.

of the pipe will be turned in and close the opening. Figure 110, *a*, shows how a connection should be made. If lined conduit is not properly reamed and is screwed too tight the opening is often entirely closed or forced inward, as shown at *b*.

It is often necessary, especially in making changes in old installations, to fit pieces between two pipes, neither one of which can be turned so as to draw them together. In such cases a long thread is cut on one piece of the pipe and the coupling run back on it; when the pipes are butted together the coupling is run over the two pipes, thus connecting them. A locknut may be run upon either pipe and used to keep the coupling in place.

In running conduits avoid as much as possible passing

through bath-rooms and other places where plumbers are likely to run their piping.

When practicable, conduits should be run so they will drain; for instance, where crossing a room from one side bracket to another, it is better to run along ceiling than along the floor. Conduits will sometimes become quite moist inside from condensation. Where there is any likelihood of this the ends may be sealed.

25 A. Metal Mouldings.

(See also Nos. 24 k to m, and 50.)

a. Must be continuous from outlet to outlet, to junction boxes, or approved fittings designed especially for use with metal mouldings, and must at all outlets be provided with approved terminal fittings which will protect the insulation of conductors from abrasion, unless such protection is afforded by the construction of the boxes or fittings.

b. Such moulding where passing through a floor must be carried through an iron pipe extending from the ceiling below to a point five feet above the floor, which will serve as an additional mechanical protection and exclude the presence of moisture often prevalent in such locations.

In residences, office buildings and similar locations where appearance is an essential feature, and where the mechanical strength of the moulding itself is adequate, this ruling may be modified to require the protecting piping from the ceiling below to a point at least three inches above the flooring.

c. Backing must be secured in position by screws or bolts, the heads of which must be flush with the metal.

d. The metal of the moulding must be permanently and effectively grounded, and must be so installed that adjacent lengths of moulding will be mechanically and electrically secured at all points.

It is essential that the metal of such systems be joined so as to afford electric conductivity sufficient to allow the largest fuse in the circuit to operate before a dangerous rise of temperature in the system can occur. Mouldings and gas pipes must be securely fastened in metal outlet boxes, so as to secure good electrical connection. Where boxes used for

center of distribution do not afford good electrical connection the metal moulding must be joined around them by suitable bond wires. Where sections are installed without being fastened to the metal structure of the building or grounded metal piping they must be bonded together or joined to a permanent and effective ground connection.

c. Must be installed so that for alternating systems the two or more wires of a circuit will be in the same metal moulding.

It is advised that this be done for direct systems also, so that they may be changed to the alternating system at any time, induction troubles preventing such change if the wires must be in separate mouldings.

26. Fixtures.

(See also Nos. 22 c, 24 v to y.)

a. Must when supported from the gas piping or any grounded metal work of a building be insulated from such piping or metal work by means of *approved* insulating joints (see No. 59) placed as close as possible to the ceiling or walls.

Gas outlet pipes must be protected above the insulating joint by approved insulating tubing, and where outlet tubes are used they must be of sufficient length to extend below the insulating joint, and must be so secured that they will not be pushed back when the canopy is put in place.

Where canopies are placed against plaster walls or ceilings in fireproof buildings, or against metal walls or ceilings, or plaster walls or ceilings on metallic lathing in any class of buildings, they must be thoroughly and permanently insulated from such walls or ceilings.

Figure 111 shows insulating joints such as are used to insulate fixtures from the gas piping of buildings.

The object of an insulating joint is to prevent a "ground" on one fixture from causing trouble on other fixtures. If, for instance, one fixture in a building were in contact with the positive wire of the system and another in contact with a negative wire, and the two fixtures connected direct to the gas piping, the two contacts or "grounds" would form a short circuit, the current flowing from one pole along the gas piping to the other. This becomes impossible when the fixtures are

insulated from the piping, or conducting parts of ceilings.

Insulating joints are made in a variety of patterns. The one shown at *a* in Figure 111 is designed for use on a combination gas and electric fixture, and is made to allow the gas



Figure 111.

to pass through. Other forms, such as *b*, can be used on conduit work to connect to the stub in the outlet box, or on a gas outlet where it is desired to use the electric light only.

Insulating joints should be placed as close as possible to the ceiling, so that there will be a minimum of exposed pipe above

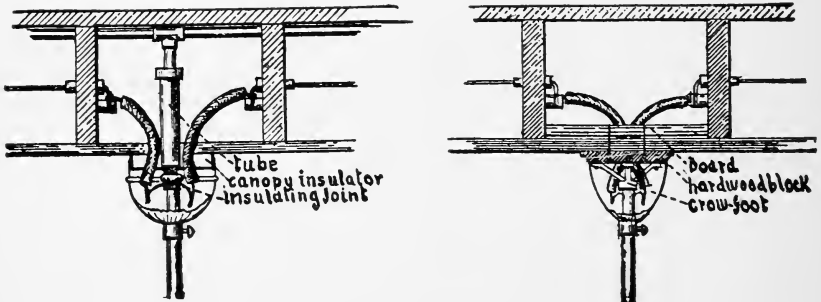

Figure 112.

the joint. If the gas pipe has been left long so that the insulating joint comes some distance below the ceiling, it is a good plan to protect the pipe above the joint either by using a porcelain tube which will fit over the pipe or by taping the pipe

thoroughly. Flexible tubing is also sometimes used. See Figure 112.

In connecting the fixture, care should be taken that the extra wire usually left for making the joint is twisted around the pipe below the insulating joint; never above. If the wires at the outlet have been properly run, as shown in Figure 112, the flexible tubing will extend to the bottom of the insulating joint.

When a straight electric fixture is to be installed on some grounded part of the building, a crowfoot, shown at *c*, Figure 111, can be fastened to the metal work and the fixture then connected with the insulating joint.

If the fixture is to be mounted on plaster, a hardwood block can be screwed to the wall or ceiling and a crowfoot screwed to this. The screws holding the crowfoot must not extend through the block. Such a case is illustrated at the right in Figure 112.

Before the plastering is put on, a board should be fastened

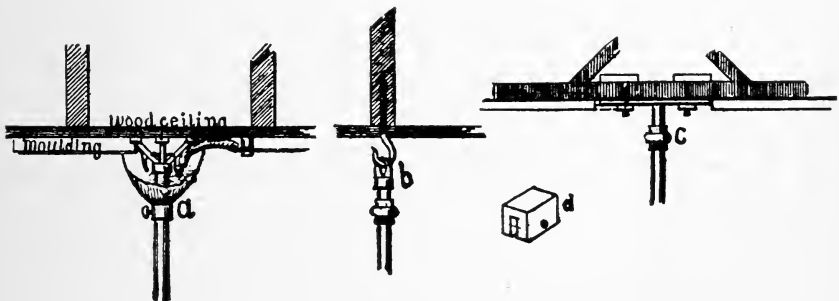

Figure 113.

between the joists, so that the wooden block may later be screwed to it. This is not absolutely necessary, as screws in lath will usually hold light fixtures. Heavy fixtures in old buildings can best be hung as shown at *b*, in Figure 113. This

method is also used for ceiling fan motors. These motors must never be rigidly fastened, but should always be left free to swing and find their own centers.

In connection with open or moulding work, the canopies should always be cut out, so that the loom or moulding may enter them. On no account should wires be allowed to rest on sharp edge of canopy. See *a*, Figure 113.

Figure 113 illustrates at *c* how fixtures are fastened to tile ceilings, toggle bolts and a metal strip to which a piece of pipe is fastened being used.

Fiber is often used for the insulation of canopies from the ceiling. Figure 113 at *d* shows a bug insulator, which can be used for this purpose. A hole is drilled in the center of a small block of fiber, and it is then slotted lengthwise with a saw. A small dent is made in the upper edge of the canopy and the fiber block slipped on the edge, so that the small dent fits into the hole. If a hole is punched through the edge of the canopy, and a brass pin riveted in, a much better job is obtained. Short, thin strips of fiber, or a long strip riveted to the inside of the canopy and left to project about one-eighth inch, are often used. These being placed on the inside of the canopy are much more sightly than the bug insulators. When a wooden block is used to fasten the fixture to the wall, the block may be made large enough so that the canopy will fit against it. The practice of fastening the canopy a short distance from the ceiling does not comply with the rule.

b. Must have all burs, or fins, removed before the conductors are drawn into the fixture.

c. Must be tested for "contacts," between conductors and fixture, for "short circuits" and for ground connections before it is connected to its supply conductors.

Fixtures are always made up of gas piping and their construction is, therefore, very similar to conduit work.

Three tests should be made on each fixture before it is connected. If tests are not made until fixtures have been connected, it is often necessary to disconnect them again to determine whether a fault is in the fixture or in the wiring. Where there are several fixtures on one circuit and a short circuit should be discovered, it would also likely be necessary to disconnect several of them before the right one would be found.

A test for short circuit may be made, first, by connecting the two wires of a magneto to the two main wires at top of fixtures. If all sockets are properly connected and the wiring is clear, no ring will be obtained. If a ring is obtained, it indicates a short circuit.

Without changing connections each socket may now be tested for connections. While one man is operating the magneto, another may insert a screw-driver, jack-knife, or piece of wire into each socket in turn, thus connecting the two terminals and causing a ring of the magneto. Failure to obtain a ring would indicate an open circuit, which must, of course, be remedied.

The third test is made for "grounds." To make it, the two fixture wires are connected to one wire of the magneto and the other wire is connected to the metal of the fixture.

It is best to connect this wire to the iron piping, and not to the lacquered brass; the lacquer is often a very good insulator. If a ring is now obtained, it indicates that the insulation on a wire has been damaged, and that the bare wire is in contact with the fixture. This test can be made more thorough by working the accessible fixture wires back and forth during the test; sometimes a damaged portion of wire is not in contact with the metal of fixture while lying upon the floor, but may be brought in contact with it when hanging.

Fixtures that have been connected to the circuit and pro-

vided with insulating joints can be individually tested for "grounds," by connecting one wire of a magneto to the body of the fixture and the other, first to one, and then the other, of the circuit wires in the sockets. This test will detect a "ground" in a fixture without disconnecting it from the circuit.

In connecting sockets to fixtures, it is advisable to connect them so that all protruding parts, as keys or receptacles for lamps, be of the same polarity, that is, all connected to the same main wire. This also applies to reflectors, border lights for theaters, encased in metal, etc. This will not lessen the liability of such parts to "ground," but lessens the chances of short circuits very much. Many "shorts" are brought about by the projecting brass lamp butts on fixtures being of opposite polarity. If they are of the same polarity, they will cause no trouble.

Special fixtures for show windows, etc., are often made up as shown in Figure 114. The construction shown at the left is

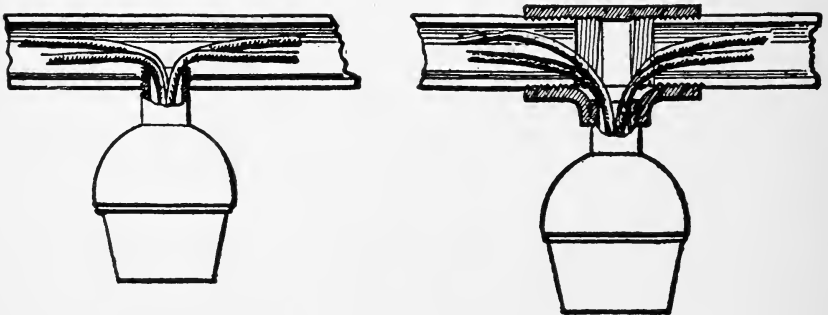

Figure 114.

more compact and neat, but requires more care in installing than the other, because of the edges of pipe in contact with the wires. If very long fixtures of this kind are installed, it is

advisable to insert insulating joints as often as practicable, even if necessary to run wires around them.

d. All fixture arms made of tubing smaller than $\frac{1}{2}$ inch outside diameter, also the arms of all one-light brackets, must be secured after they are screwed into position by the use of a set-screw properly placed, or by soldering or cementing or some equally good method to prevent the arms from becoming unscrewed. Arms must **not** be made of tubing lighter than No. 18 B. & S. gage, and must have at screw joints not less than five threads all engaging. This rule does not apply to fixtures or brackets with cast or heavy arms.

27. Sockets.

(For construction rules, see No. 55.)

a. In rooms where inflammable gases may exist the incandescent lamp and socket must be enclosed in a vapor-tight globe, and supported on a pipe-hanger, wired with *approved* rubber-covered wire (see No. 41) soldered directly to the circuit.

Key sockets contain a switch (see No. 17 b).

In Figure 115, *a* shows a "vapor-tight" globe suspended on a pipe hanger, the construction of which complies with the requirements of this rule. If moisture is present it is well to seal the upper end of the pipe with compound.

Key sockets must not be used in rooms where inflammable gases exist. If enclosed as required above they would be useless.

b. In damp or wet places "waterproof" sockets must be used. Unless made up on fixtures they must be hung by separate *stranded* rubber-covered wires not smaller than No. 14 B. & S. gage, which should preferably be twisted together when the pendant is over three feet long.

These wires must be soldered direct to the circuit wires but supported independently of them.

c. Key sockets will not be approved if installed over spe-

cially inflammable stuff, or where exposed to flyings of combustible material.

Waterproof sockets are constructed entirely of porcelain and are not provided with keys, therefore the circuits to which they are connected must be controlled by switches. As a general rule these sockets are furnished with a short piece of

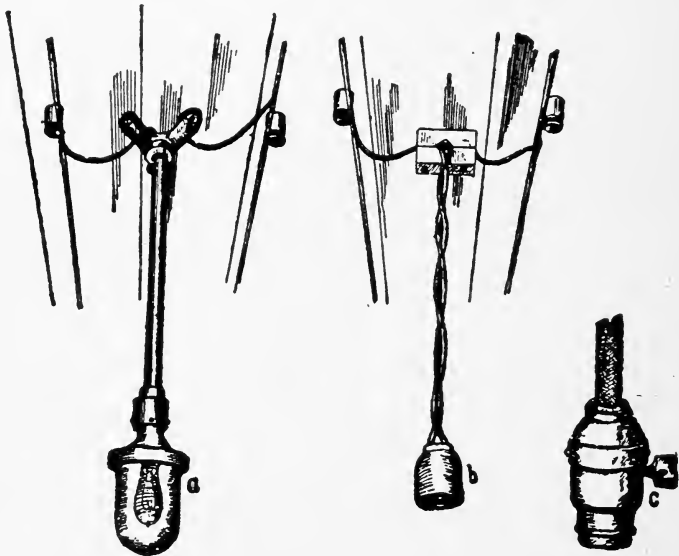

Figure 115.

stranded, rubber-covered wire extending through sealed holes in the top of the socket and the supporting wires are soldered to them. The method of suspending waterproof sockets varies with the conditions. Ordinarily, stranded rubber-covered wires of the proper length are suspended from single cleats as shown at *b*, in Figure 115, or, if the line knobs are large enough, the stranded wire may be supported from them. If the lamp is to be suspended only a short distance from the ceiling, where it will not be liable to be disturbed, it may be

hung from two ordinary inch porcelain knobs, as shown in Figure 95. If cleats are used in a damp place for supporting the drop a half cleat must be provided back of the supporting cleat to give a one-inch separation, as required for wires in wet places.

28. Flexible Cord.

a. Must have an *approved* insulation and covering (see No. 45).

b. Must not be used where the difference of potential between the two wires is over 300 volts.

The above rule does not apply to the grounded circuits in street railway property.

c. Must not be used as a support for clusters.

d. Must not be used except for pendants, wiring of fixtures, portable lamps or motors, and portable heating apparatus.

The practice of making the pendants unnecessarily long and then looping them up with cord adjusters is strongly advised against. It offers a temptation to carry about lamps which are intended to hang freely in the air, and the cord adjusters wear off the insulation very rapidly.

For all portable work, including those pendants which are liable to be moved about sufficiently to come in contact with surrounding objects, flexible wires and cables especially designed to withstand this severe service are on the market, and should be used. (See No. 45 f.)

The standard socket is threaded for one-eighth-inch pipe, and if it is properly bushed the reinforced flexible cord will not go into it, but this style of cord may be used with sockets threaded for three-eighths-inch pipe, and provided with substantial insulating bushings. The cable to be supported independently of the overhead circuit by a single cleat, and the two conductors then separated and soldered to the overhead wires.

The bulb of an incandescent lamp frequently becomes hot enough to ignite paper, cotton and similar readily ignitable materials, and in order to prevent it from coming in contact with such materials, as well as to protect it from breakage, every portable lamp should be surrounded with a substantial wire guard.

Cord adjusters should never be used where their use can be avoided and where they are installed should only be placed

on lamps which will seldom need adjusting. The indiscriminate use of cord adjusters cannot be too strongly condemned, as the constant rubbing soon destroys the insulation. At *c*, Figure 115, shows a brass socket threaded for $\frac{3}{8}$ -inch pipe, and which is designed to be used with portable cord. Care should be taken in making up these sockets to see that the knot under the head of the socket has a good bearing surface so that it will not pull through the larger bushing, these portables being very apt to be jerked about.

A lamp guard to be of any value should be so constructed that the bulb of the lamp cannot come in contact with anything outside of the lamp guard; it should also protect the lamp from any sudden jar. The design of the guard should be such that it can be firmly attached to the socket so it will not work loose and come in contact with the live butt of the lamp or projecting threaded portion of the socket.

e. Must not be used in show windows except when provided with an *approved* metal armor.

The great number of fires which have been caused by the use of flexible cord in show windows is sufficient argument against its use.

f. Must be protected by insulating bushings where the cord enters the socket.

g. Must be so suspended that the entire weight of the socket and lamp will be borne by some *approved* device under the bushing in the socket, and above the point where the cord comes through the ceiling block or rosette, in order that the strain may be taken from the joints and binding screws.

This is usually accomplished by knots in the cord inside the socket and rosette.

Special ceiling blocks or rosettes which facilitate the fastening of cords are on the market and should be used. In fastening the cord to sockets the end of the cord should be soldered. This does away with the liability of stray strands

short circuiting on the shell of the socket and also affords a better and stronger contact under the binding screws. This soldering is best done by dipping the ends of the cord in melted solder. If a blow torch is used the small wires are very easily overheated and the soldering may do more harm than good. It is also well to tape the ends of cords, leaving only just enough bare metal to go under the binding screws; the tape will hold the end of the braid and will confine any ends of wires which do not happen to come under the binding screws.

29. Arc Lamps on Constant-Potential Circuits.

α. Must have a cut-out (see No. 17 *α*) for each lamp or each series of lamps.

The branch conductors should have a carrying capacity about 50 per cent in excess of the normal current required by the lamp to provide for heavy current required when lamp is started or when carbons become stuck without overfusing the wires.

Figure 116 at the left gives a diagram of a constant potential arc circuit as generally used at present for enclosed arc

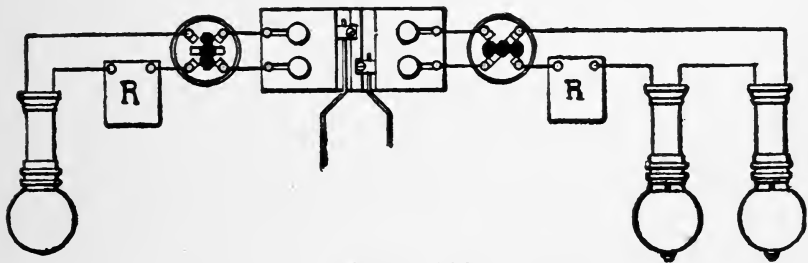

Figure 116.

lamps. Each arc lamp of this kind requires a pressure of 110 volts. A steadying resistance, *R*, is always placed in series with constant potential lamps, its object being to keep down the current while the lamp feeds. During the short time that

the two carbons are together, the resistance of the lamp is so low that an enormous amount of current would flow were it not for this resistance. With most lamps this resistance is now installed in the hood. Since the rule requires a carrying capacity about 50 per cent in excess of the normal current for branch conductors, it would be well to provide this also for mains in such cases where groups of arc lamps are likely to be controlled by one switch and used together.

Figure 116 at the right shows a diagram of wiring for *open* arc lamps. Two lamps are usually run in series on 110 volts together with a steadying pressure. An *open* arc does not work well with a pressure higher than about 45 volts.

b. Must only be furnished with such resistance or regulators as are enclosed in non-combustible material, such resistances being treated as sources of heat. Incandescent lamps must not be used for this purpose.

c. Must be supplied with globes and protected by spark arresters and wire netting around the globe, as in the case of series arc lamps (see Nos. 19 and 58).

Outside arc lamps must be suspended at least eight feet above sidewalks. Inside arc lamps must be placed out of reach or suitably protected.

d. Lamps when arranged to be raised and lowered, either for carboning or other purposes, shall be connected up with stranded conductors from the last point of support to the lamp, when such conductor is larger than No. 14 B. & S. gage.

30. Economy Coils.

a. Economy and compensator coils for arc lamps must be mounted on non-combustible, non-absorptive insulating supports, such as glass or porcelain, allowing an air space of at least one inch between frame and support, and must in general be treated as sources of heat.

31. Decorative Lighting Systems.

a. Special permission may be given in writing by the

Inspection Department having jurisdiction for the temporary installation of *approved* Systems of Decorative Lighting, provided the difference of potential between the wires of any circuit shall not be over 150 volts and also provided that no group of lamps requiring more than 1,320 watts shall be dependent on one cut-out.

No "System of Decorative Lighting" to be allowed under this rule which is not listed in the Supplement to the National Electrical Code containing list of approved fittings.

31A. Theater Wiring.

(For rules governing Moving Picture Machines see No. 65 A.)

All wiring apparatus, etc., not specifically covered by special rules herein given must conform to the Standard Rules and Requirements of the National Electrical Code.

In so far as these Rules and Requirements are concerned, the term "theater" shall mean a building or part of a building in which it is designed to make a presentation of dramatic, operatic or other performances or shows for the entertainment of spectators which is capable of seating at least four hundred persons, and which has a stage for such performances that can be used for scenery and other stage appliances.

A. Services.

1. Where source of supply is outside of building there must be at least two separate and distinct services where practicable, fed from separate street mains, one service to be of sufficient capacity to supply current for the entire equipment of theater, while the other service must be at least of sufficient capacity to supply current for all emergency lights.

By "emergency lights" are meant exit lights and all lights in lobbies, stairways, corridors and other portions of theater to which the public have access which are normally kept lighted during the performance.

2. Where source of supply is an isolated plant within same building, an auxiliary service of at least sufficient capacity to supply all emergency lights must be installed from some outside source, or a suitable storage battery within

the premises may be considered the equivalent of such service.

The spirit of this rule requires that the "emergency" light-

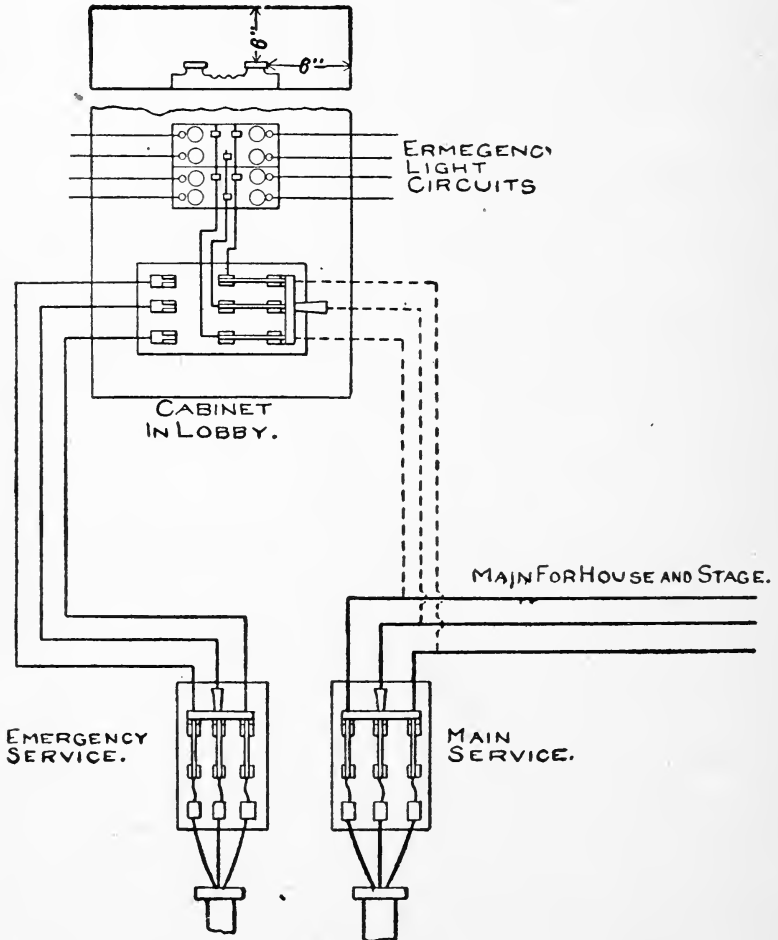

Figure 117.

ing system be kept entirely separate and distinct from the general lighting system. The emergency lighting system is

designed to provide illumination sufficient for the audience to get from the auditorium to the outside of the building under any and all conditions liable to exist, even where the general illuminating system has been rendered useless. It is, therefore, of the utmost importance that the emergency system be made as reliable as is possible to the end that under no condition liable to exist will these lights be out of service. Figure 117 shows how this rule and also e-4 may be complied with. The emergency circuit should if possible be taken from mains that have no connection whatever with those supplying the auditorium and stage lights. The emergency mains must lead to the lobby and are not allowed to have any fuses except those at the street and those finally protecting the branch circuits. Under certain interpretation of this rule it is permissible to connect the two systems as

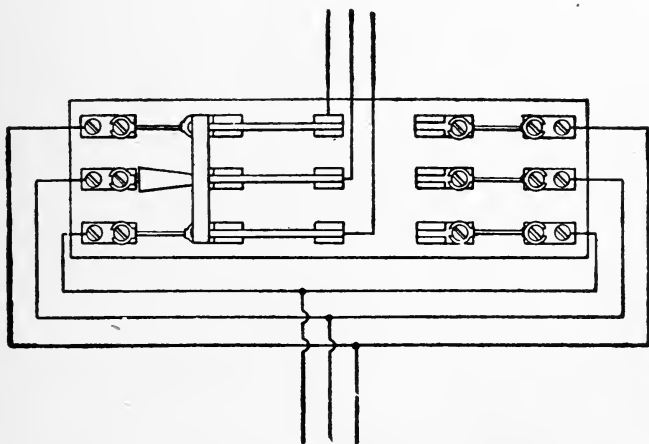

Figure 118.

shown by dotted lines. This is, however, bad practice, as the switch may be unintentionally left as shown in the cut and thus when the main fuse blows all of the lights will be

out. In many cases this arrangement will be very costly, as often lobby and theater mains do not run close together. As there is to be only one fuse between street and cut-out box, the mains to lobby will have to be of the same size as the house mains.

It will be a good plan to arrange the house mains as shown in Figure 118. The double throw switch is provided

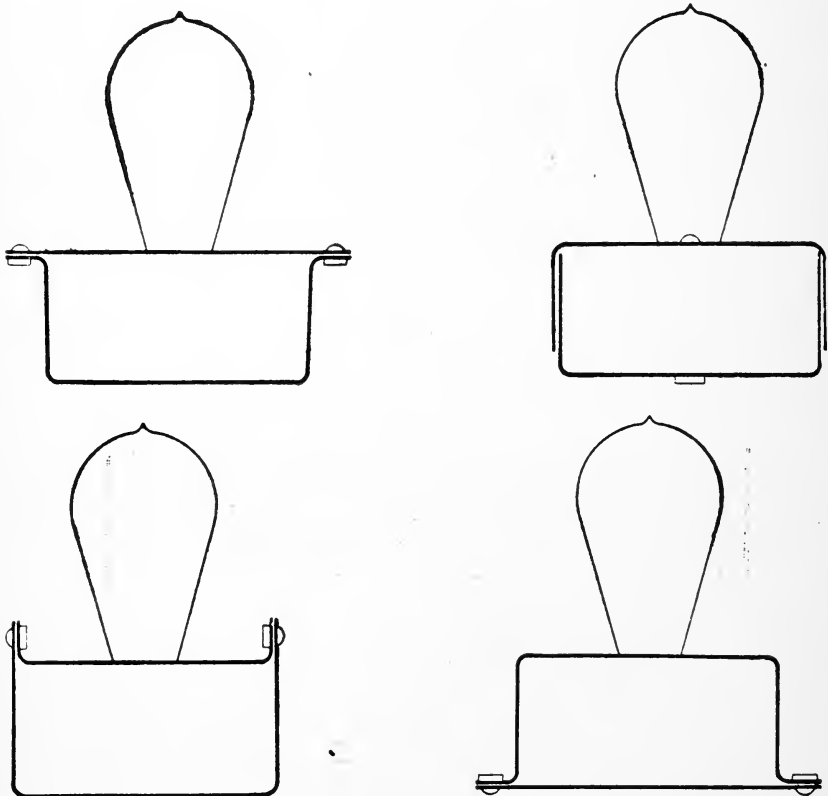

Figure 119.

merely to enable a quick re-illumination to take place in case one of the fuses were to blow. The switch is located at the

electrician's station and it is but necessary for him to throw the switch to the other side to light up the house again.

In order to be certain that the fuse in the street will not blow, the wires between street and switch may be made several sizes heavier than required and fuse accordingly. Under such circumstances it is extremely unlikely that any but the fuse at the electrician's station will blow.

b. Stage.

1. All permanent construction on stage side of proscenium wall must be *approved* conduit, with the exception of border and switchboard wiring.

2 *Switchboards*.—Must be made of non-combustible, non-absorptive material, and where accessible from stage level must be protected by an *approved* guard-rail to prevent accidental contact with live parts on the board.

The switchboard of necessity being close to the stage proper is generally in such a position that persons leaving the stage pass directly in front of it. As the costumes worn by actors are very often made up of tinsel or other conduct-

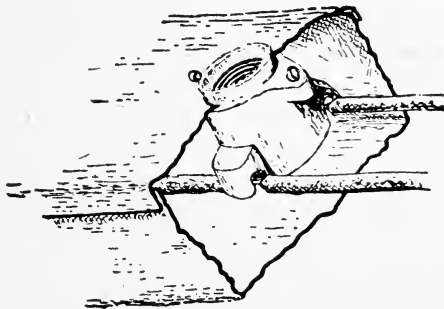

Figure 120.

ing material, and as various metal trappings are carried, it is essential that the guard rail be of such design as to pre-

vent these materials from coming in contact with the live parts of the board. Where the guard rail is placed close to the board it is often advisable to provide a screen between the guard rail and the floor.

3. Footlights.

a. Must be wired in *approved* conduit, each lamp receptacle being enclosed within an *approved* outlet box, the whole to be enclosed in a steel trough, metal to be of a thickness not less than No. 20 gage, or each lamp receptacle may be mounted on or in an iron or steel box so constructed as to enclose all the wires and live parts of receptacles.

b. Must be so wired that no set of lamps requiring more than 1,320 watts will be dependent on one cut-out.

Figure 119 shows a number of forms in which footlight troughs are made up. These troughs are constructed of No. 20 Stubbs gage iron or steel, the receptacles being attached to the upper section as shown in Figure 120. The completed footlight strip is shown in Figure 121. These

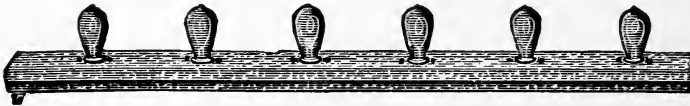

Figure 121.

strips are combined in various ways to make up the footlight proper, their arrangement depending on the lighting effect desired. A common arrangement is shown in Figure 122, where two separate strips are used, one elevated above the other in order that the light from the back row of lamps will not be obstructed by the lamps in the front row. When footlights are installed in this manner more light is obtained when the clear lamps are placed in the front row, as only a small part of the light emitted from the colored lamps

will be absorbed by passing through the clear globes, while, with the reverse arrangement, where the colored lamps are placed in the front row, a considerable amount of light would be absorbed by the light from the clear lamps passing through the colored glass. Owing to the fact that the footlights are generally placed in troughs cut in the stage floor, thus bringing the lamps below the level of the stage floor, the placing of the white lamps in the lower row would not

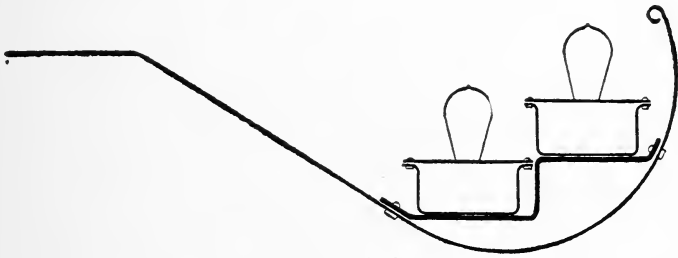

Figure 122.

allow sufficient light to illuminate the back part of the stage, and for this reason where footlights are placed as shown in the figure it is the usual practice to place the white lights in the upper row.

Where all the lamps, both white and colored, are placed

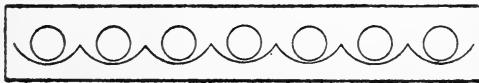

Figure 123.

in one row, a reflector of the design shown in Figure 123 will materially increase the useful light.

Receptacles used in footlight construction must be of approved design and where the receptacle is fastened to the

metal work with porcelain or metal threaded rings the receptacle must be so designed that it cannot be turned by the insertion or extraction of the lamp. This is generally accomplished by means of notches or projections on the porcelain of the receptacle and the metal should always be stamped to fit these parts.

Double braid, rubber covered wire must be used, and, with clip sockets, the wire must be soldered to the clip, in addition to being fastened by the binding screws. If the porcelain of the receptacle does not provide proper protection all exposed contacts, including the clips themselves, should be taped or covered with a suitable compound. Compound should not be used on border lights, as the heat from the lamps will cause the compound to melt and run down on the lamps. This also applies to any device of this form where the lamp hangs down, or below, the trough. In cases of this kind the clips should be taped, or, better, properly designed receptacles used.

The footlight circuits may be wired for a capacity of 1,320 watts, this allowing 24-16 c. p. lamps, 18-24 c. p. lamps, or 12-32 c. p. lamps on one circuit.

4. *Borders.*

a. Must be constructed of steel of a thickness not less than No. 20 gage, treated to prevent oxidation, be suitably stayed and supported by a metal framework, and so designed that flanges of reflectors will protect lamps.

b. Must be so wired that no set of lamps requiring more than 1,320 watts will be dependent upon one cut-out.

c. Must be wired in *approved* conduit, each lamp receptacle to be enclosed within an *approved* outlet box, the whole to be enclosed in a steel trough, or each lamp receptacle may be mounted on or in the cover of a steel box so constructed as to enclose all the wires and the live parts of receptacles, metal to be of a thickness not less than No. 20 gage.

d. Must be provided with suitable guards to prevent

scenery or other combustible material coming in contact with lamps.

e. Cables must be continuous from stage switchboard to border; conduit construction must be used from switchboard to point where cables must be flexible to permit of the raising and lowering of border, and flexible portion must be enclosed in an *approved* fireproof hose or braid and be suitably supported.

Junction Boxes will be allowed on fly floor and rigging loft in existing theaters where the wiring has been completed and approved by Inspection Department having jurisdiction.

f. For the wiring of the border proper, wire with slow burning insulation should be used.

g. Must be suspended with wire rope, same to be insulated from border by at least two *approved* strain insulators properly inserted.

The design and construction of border lights is similar to that just described for footlights with the exception of the arrangement of the strips and the kind of wire used. Border lights are suspended above the stage and are designed to throw the light downward and slightly to the back of the stage. To produce the proper lighting effects the

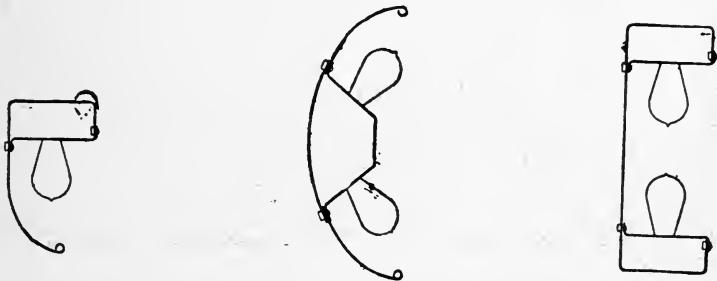

Figure 124.

border must be capable of adjustment, both as to its height above the stage and its position.

Figure 124 shows several forms of border lights.

Figure 125 shows a simple form of border light in common use. It will be noticed that the flange of the reflector is carried around the lamps in such a manner as to protect them from accidental contact with the scenery.



Figure 125.

Figure 126 shows a completed border light with one method of suspension. The iron bands to which are fastened the supporting chains are carried entirely around the border frame and serve as a means of attaching it to its support and at the same time provide mechanical protection for the lamps. These bands are placed from four to six feet apart.

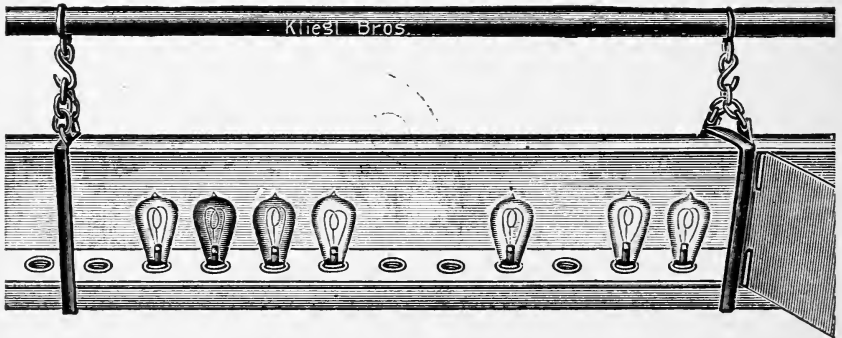

Figure 126.

The cables which carry current to the border lights are generally made up for each individual installation, the size and number of wires varying according to the number and

combination of lamps used and the distance of the border from the stage switchboard or center of distribution.

There are at the present time no specifications governing the construction of border light cable, but in a general way it should comply with the following: The wire of the cable should be stranded, the wires composing the strands to be of such size as will allow of sufficient flexibility with the required strength. Each of the stranded wires should be covered with a wind of cotton as required for flexible cord and should then be covered with a rubber covering of about the same thickness as required for rubber covered wires of corresponding sizes. Each wire should have a stout braid which should be filled with a waterproofing compound. To round out the cable, jute, slightly impregnated with a waterproof compound, should be used. The whole cable should be covered with a tough outer braid of such thickness as to provide proper protection with continued rough usage. No rubber need be used between this outer braid and the individual wires comprising the cable.

In reference to the above specifications it might be well to state that they are given simply as a guide to enable one to choose a cable suitable to the work. There are at the present time no Underwriters' specifications covering this class of wire and there is considerable cable in use which is entirely unsuited to the purpose. The latest Underwriters' rules should be consulted before buying or ordering cable.

Border cables must be continuous from the stage switchboard or center of distribution to the border itself, the exposed portion of the cable being protected by a fireproof braid or hose. This fireproof covering can be put on when the cable is manufactured or fireproof hose suitable for the purpose may be obtained from the manufacturers of this class of goods and placed on the ordinary cable. The cables

should be long enough to allow the border to be lowered to within six or seven feet of the floor to permit of the necessary repairs and adjustments and the replacement of lamps.

"Take-up" devices, which are attached to the cable to take up the slack when the border is raised, should be fastened to the cable by some suitable device which will give a large bearing surface so that the insulation of the cable will not be injured. The practice of simply tying a rope around the cable is very bad, as the rope is sure to cut into the insulation.

As considerable heat is developed in a border light, due to the great number of lamps employed and to the position of the border itself, the rubber covering of the ordinary rubber covered wire would be very apt to become useless as an insulator, so that for this class of wiring slow-burning wire should be used. Specifications covering this wire are given under "Fittings."

Wire rope must be used for the suspension of the border lights. The rope should be of such size as to properly support the border with an ample safety factor. Generally three or four ropes are provided, each rope being fastened to a bridle which will distribute the strain uniformly along the length of the border frame. Two strain insulators of the type shown in Figure 49 should be connected in the cable at the point where it connects to the border. The supporting cables are generally run to counterweights, hemp ropes fastened to either the counterweights or the border itself serving as a means to raise and lower the border. Where the border is small and of inconsiderable weight the wire rope is run directly to the point of fastening and the adjustments made with it direct.

5. *Stage Pockets*.—Must be of approved type controlled from switchboard, each receptacle to be of not less than fifty

amperes rating, and each receptacle to be wired with a separate circuit to its full capacity.

For the connection of portable apparatus on the stage,

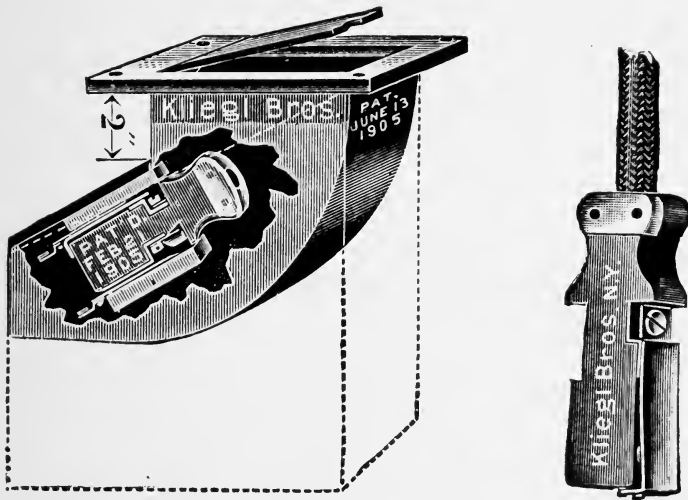

Figure 127.

pockets are provided in the stage floor. These pockets contain receptacles into which the plugs connected to cables attached to the apparatus are inserted. The pockets should be made absolutely fireproof and the receptacles should be so installed that all live parts will be clear of the opening. It would be a good rule to have stage plugs of different shapes to be used in connection with arc and incandescent lights, so that it will be impossible to plug incandescent lights on arc light circuits. An arc light circuit requires a fuse of about forty amperes. Many times a single incandescent light is plugged into such a circuit. A short circuit occurring under these circumstances would be accompanied with disastrous results. Figure 127 shows a stage pocket

with receptacles. The average stage pocket accommodates four receptacles.

6. *Proscenium Side Lights*.—Must be so installed that they cannot interfere with the operation of or come in contact with curtain.

Those lights placed at the stage opening on the stage side of the wall which separates the stage from the auditorium (proscenium wall) are known as the proscenium side lights. They are constructed in the same manner as the footlights previously described, with the exception of

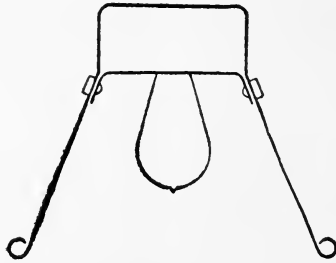

Figure 128.

the reflectors, which are of various shapes. Figure 128 shows a common form of proscenium side light.

The troughs are generally hinged so that they may be turned to illuminate any particular part of the stage, and special care should be exercised in placing them so that they cannot in any manner interfere with the operating of the curtain. It is sometimes advisable, especially in the case of vaudeville or burlesque houses, to provide a wire mesh screen for the protection of the lamps.

7. *Scene Docks*.—Where lamps are installed in Scene Docks, they must be so located and installed that they will not be liable to mechanical injury.

As scene docks are often used for the storage of scenery and other stage paraphernalia and as lights are generally placed on the side walls, a substantial guard should be provided. This guard should be capable of standing considerable hard usage and should be firmly attached. The ordinary lamp guard fastened to the socket or lamp itself is useless as a protection.

8. *Curtain Motors*.—Must be of ironclad type and installed so as to conform to the requirements of the National Electrical Code. (See No. 8.)

Rheostats used with curtain motors, if installed on the stage wall or in any other location outside of the motor room, should be entirely enclosed and well protected, so that nothing of an inflammable nature can come in contact with them.

9. *Control for Stage Flues*:

a. In cases where dampers are released by an electric device, the electric circuit operating same must be normally closed.

b. Magnet operating damper must be wound to take full voltage of circuit by which it is supplied, using no resistance device, and must not heat more than normal for apparatus of similar construction. It must be located in loft above scenery and be installed in a suitable iron box with a tight self-closing door.

c. Such dampers must be controlled by at least two standard single pole switches mounted within *approved* iron boxes provided with self-closing doors without lock or latch, and located, one at the electrician's station, and others as designated by the Inspection Department having jurisdiction.

The dampers referred to are ventilators arranged above the stage and scenery. In case of fire it is essential that these be opened immediately to allow smoke to escape and

also to prevent the total consumption of oxygen in the building by the flames. This rapid consumption of oxygen, making it very difficult for people to breathe, thereby causing frantic efforts at inhalation, which result in inhaling large quantities of smoke and overheated air, are perhaps the main causes of the enormous death loss usual in theater fires.

Where current is obtained from an isolated plant which is shut down at night time and is not supplied with storage

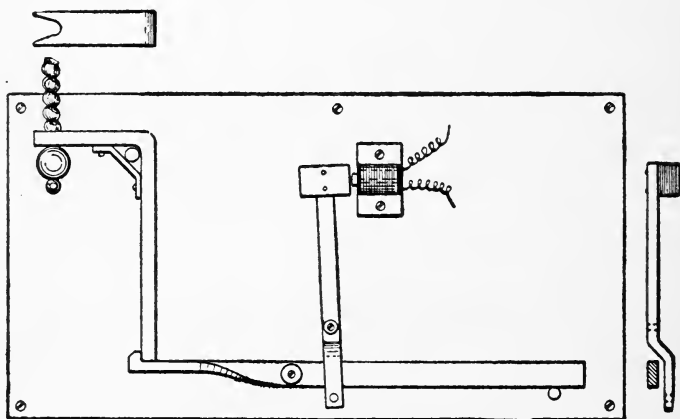

Figure 129.

battery, or where alternating current is used, it is generally more satisfactory to use battery current for the operation of the damper, gravity cells being used for this purpose. Where the installation is supplied by a direct current system which is continuous the damper circuit may be taken directly from the system. Figure 129 shows an inexpensive form of damper control which is supplied by current from two or three cells of gravity battery. The lever arms are made from bar iron formed in the shapes shown. The magnet

is of the type used in door openers and is enclosed in an iron box, that part of the enclosure immediately surrounding the magnet pole pieces being of brass. When the circuit is opened the armature falls and strikes the lower arm a sharp blow, thus releasing the damper rope. To close the damper the circuit is first closed, the magnet armature is pulled back in place by the cord attached to the lower end of it, and the damper is closed, the ball in the damper rope engaging in the slot in the end of the lever arm.

c. Dressing Rooms.

1. Must be wired in *approved* conduit, except that in existing buildings where it is impracticable to install *approved* conduit, *approved* armored cable may be used, provided it is installed in accordance with No. 24 A.

2. All pendant lights must be equipped with *approved* reinforced cord or cable.

3. All lamps must be provided with *approved* guards.

Experience has proven it a difficult matter to arrange dressing rooms in such a way that actors cannot disarrange them and thus cause troubles of many kinds. One of the principal preventive devices is a lamp guard fastened to each socket in such a way that it cannot be removed without assistance from the house electrician. This will prevent the removal of the lamp and the substitution of a lamp of greater candle power or of the portable devices which many actors carry that require much more current. A lamp guard so arranged that it can be locked on will readily accomplish the purpose and such lamp guards are on the market.

The principal use of light in the dressing rooms is for the "make-up" of the actors. One light on each side of every mirror, suitably placed, with one or two lights for general illumination, are generally sufficient. A receptacle for

curling iron connection can also be provided, but should also be under lock and key.

d. Portable Equipments.

1. *Arc lamps* used for stage effects must conform to the following requirements:—

a. Must be constructed entirely of metal except where the use of *approved* insulating material is necessary

b. Must be substantially constructed, and so designed as to provide for proper ventilation, and to prevent sparks being emitted from lamps when same is in operation, and mica must be used for frame insulation.

c. Front opening must be provided with a self-closing hinged door frame in which wire gauze or glass must be inserted, excepting lens lamps, where the front may be stationary and a solid door be provided on back or side.

d. Must be provided with a one-sixteenth-inch iron or steel guard having a mesh not larger than one inch, and be substantially placed over top and upper half of sides and back of lamp frame; this guard to be substantially riveted to frame of lamp, and to be placed at a distance of at least two inches from the lamp frame.

e. Switch on standard must be so constructed that accidental contact with any live portion of same will be impossible.

f. All stranded connections in lamp and at switch and rheostat must be provided with approved lugs.

g. Rheostat, if mounted on standard, must be raised to a height of at least three inches above floor line, and in addition to being properly enclosed must be surrounded with a substantially attached metal guard having a mesh not larger than one square inch, which guard is to be kept at least one inch from outside frame of rheostat.

h. A competent operator must be in charge of each arc lamp, except that one operator may have charge of two lamps when they are not more than ten feet apart and are so located that he can properly watch and care for both lamps.

On the stage hand-feed arc lamps are used almost ex-

clusively and an operator is always required to look after the lamps. The style of lamps generally used are shown in Figures 130 and 131. Figure 130 shows the focusing or

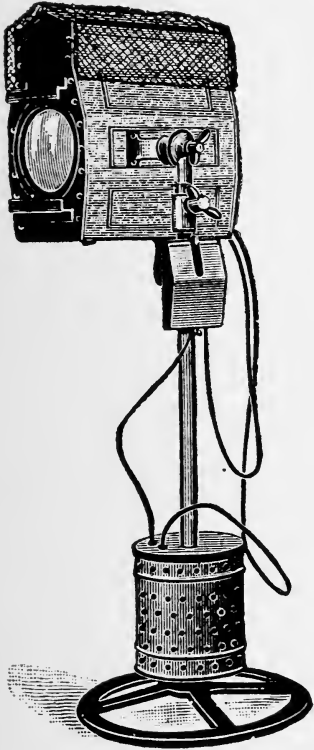
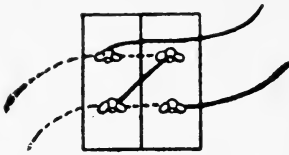

Figure 130.

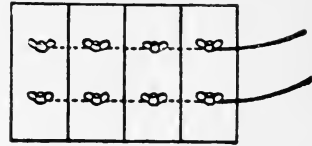

Figure 131.

spot lamp and Figure 131 the open box or olivet lamp, which is used for general illumination. These arc lamps require a



Rheostat No. 83.
 Hard line—One lamp on 220 volts, 20 amperes.
 Dotted line—One lamp on 110 volts, 30 amperes.



Rheostat No. 82.
 One lamp on 110 volts, 60 amperes.

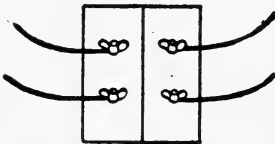

Rheostat No. 83.
 Two lamps on 110 volts each, 15 amperes.

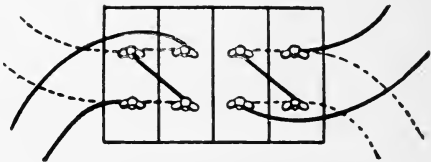

Rheostat No. 82.
 Hard line—Two lamps on 220 volts each, 20 amperes.
 Dotted line—Two lamps on 110 volts each, 30 amperes.

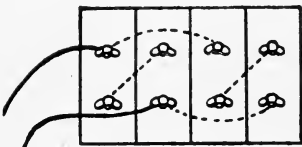

Rheostat No. 82.
 One lamp on 220 volts, 35 amperes.

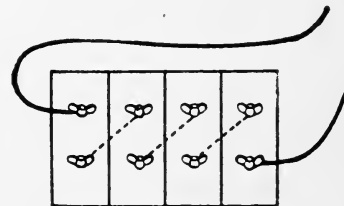

Rheostat No. 82.
 One lamp on 450 volts, 20 amperes.

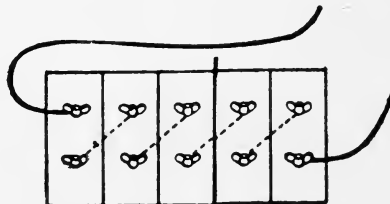

Rheostat No. 81.
 One lamp on 550 volts, 22 amperes.

Figure 132.

current of from 20 to 40 amperes and should be wired for accordingly.

Figure 132 shows diagrammatically a very useful form of rheostat for stage purposes. As most "shows" are constantly traveling, the apparatus carried by them should be adjustable in so far as voltage is concerned and also as to system, i. e., alternating or direct current. As will be seen from the figure, this rheostat lends itself to any voltage or system. This particular rheostat is manufactured by the Chicago Stage Lighting Co.

2. *Bunches.* *a.* Must be substantially constructed of metal and must not contain any exposed wiring.

b. The cable feeding same must be bushed in an approved manner where passing through the metal and must be properly secured to prevent any mechanical strain from coming on the connection.

The bunch light is used in various locations around the stage where only a small amount of illumination is required.

3. *Strips.* *a.* Must be constructed of steel of a thickness not less than No. 20 gage, treated to prevent oxidation, and suitably stayed and supported by metal framework.

b. Cable feeding must be bushed in an *approved* manner where passing through the metal, and must be properly secured to prevent any mechanical strain coming on the connections.

Strip lights are laid on the floor and hung on the scenery and are used to illuminate those parts of the scenery where the lights from the foots and borders is obstructed. Any of the forms shown in Figure 119 may be used for footlight construction. Reflectors are generally provided which serve to concentrate the light on the spot desired and to protect the lamps from accidental contact. Special care must be given to cables, where they leave strips; being portable, they soon suffer damage at these points.

4. *Portable Plugging Boxes.*—Must be constructed so that no current carrying part will be exposed, and each receptacle must be protected by *approved* fuses mounted on slate or marble bases and enclosed in a fireproof cabinet equipped with self-closing doors. Each receptacle must be constructed to carry thirty amperes without undue heating, and the bus-bars must have a carrying capacity equivalent to

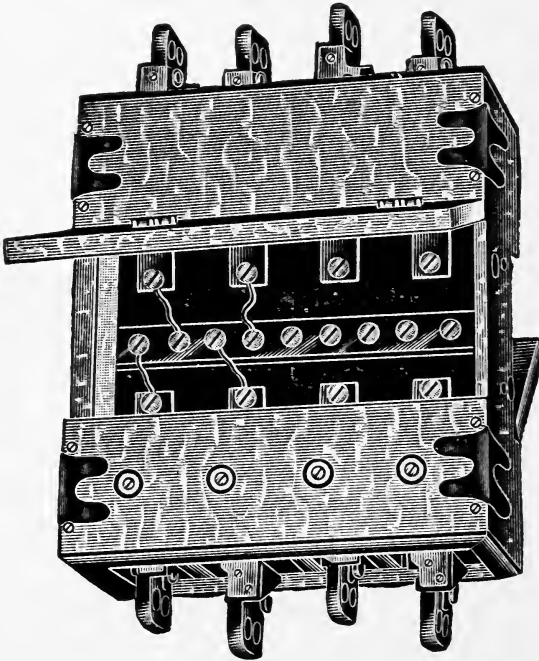

Figure 133.

the current required for the total number of receptacles, allowing thirty amperes to each receptacle, and *approved* lugs must be provided for the connection of the master cable.

When a number of pieces of electrical apparatus are to be used at one time on the stage, instead of carrying a separate cable from each piece of apparatus to a pocket, a portable

plugging box or spider box is used. This is shown in Figure 133. One large cable is carried from the plugging box to a pocket or other convenient point of connection and the various pieces of apparatus connected to the plugging box by plugs and short cables. This greatly reduces the amount of cable used and allows of rapid assembly and removal.

5. *Pin Plug Conductors.* *a.* When of *approved* type may be used to connect *approved* portable lights and appliances.

b. Must be so installed that the "female" part of plug will be on the live end of cable and must be so constructed

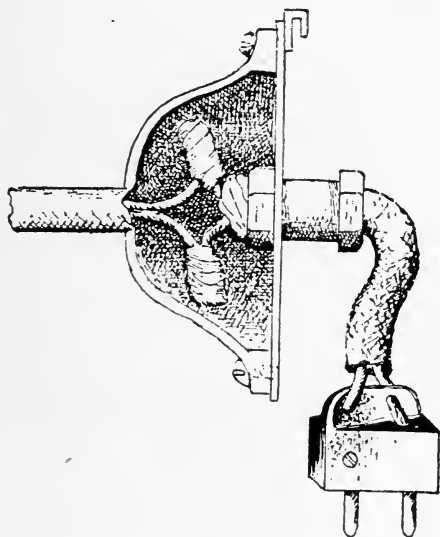

Figure 134.

that tension on the cable will not cause any serious mechanical strain on the connections.

6. *Lights on Scenery.*—When brackets are used they must be wired entirely on the inside, fixture stem must come through to the back of the scenery and end of stem be properly bushed.

The usual method of complying with this rule is shown in

Figure 134. Everything about the bracket is of metal and stage cable is used to make the connection to the outside.

7. *String or Festoon Lights.*—Wiring for same should be *approved* cable, joints where taps are taken from same for lights to be properly made, soldered and taped, and where lamps are used in lanterns or similar devices lamps must be provided with *approved* guards. Where taps are taken from cable, they should be so staggered that joints of different polarity will not come immediately opposite each other and must be properly protected from strain.

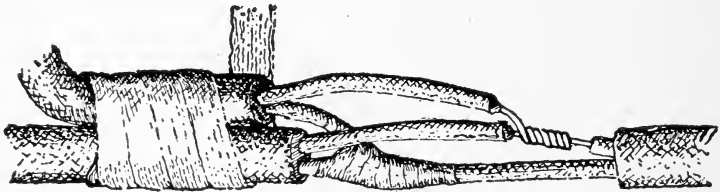

Figure 135.

A good method of making tap joints in festoons is shown in Figure 135. The joints are made staggering and properly soldered and taped with both rubber and friction tape. The cable which is tapped on is then carried along the main cable for three or four inches and securely taped. This removes nearly all the strain from the joints and prevents the wires from working loose.

8. *Special Electrical Effects.*—Where devices are used for producing special effects, such as lightning, waterfalls, etc., the apparatus must be so constructed and located that flames, sparks, etc., resulting from the operation cannot come in contact with combustible material.

The necessity for electrical current in connection with stage effects has of late years been greatly reduced. Scenes and effects of almost any description can be produced by

means of transparent films attached to and rotating in front of an arc lamp. Celluloid films, if they remain stationary exposed to the light of an arc lamp, may be ignited in two or three seconds and burn very rapidly.

Care must be exercised in the use of some of these effects, as the sudden and unexpected production of a fire effect or of a puff of smoke or momentary blaze such as would be produced by a short circuit might have a disastrous effect on the audience.

In Figure 136 a device is shown for producing lightning flashes. It consists of a solenoid, the core of which is at-

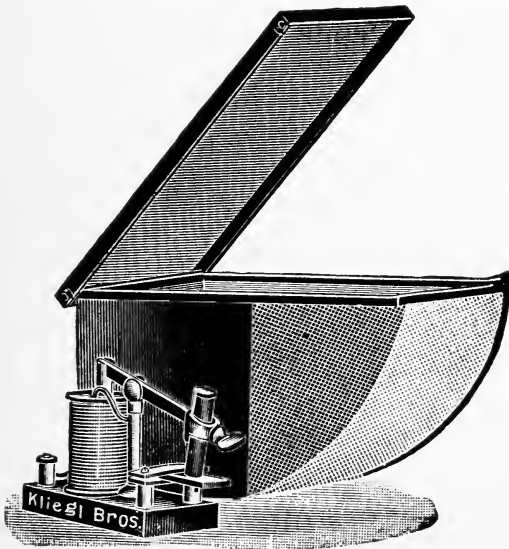

Figure 136.

tached to a lever fitted with a piece of carbon. The carbon rests on a piece of steel bar. When the circuit is closed the solenoid operates and raises the carbon from the piece of steel, a considerable flash resulting. The carbon continues

to rise until the circuit opens, when it drops again, causing another flash, etc.

e. Auditorium.

1. All wiring must be installed in *approved* conduit, except that in existing buildings where it is impracticable to install *approved* conduit, *approved* armored cable may be used, provided it is installed in accordance with No. 24 A.

2. All fuses used in connection with lights illuminating all parts of the house used by the audience must be installed in fireproof enclosures so constructed that there will be a space of at least six inches between the fuses and the sides and face of enclosure.

3. Exit lights must not have more than one set of fuses between same and service fuses.

The only fuses allowed on the exit light circuits are the branch fuses and the fuses at the service. This necessitates running the exit light main direct to the service, not changing size and not tapping onto any other main unless both mains are of equal carrying capacity.

4. Exit lights and all lights in halls, corridors or any other part of the building used by the audience, except the general auditorium lighting, must be fed independently of the stage lighting, and must be controlled only from the lobby or other convenient place in front of the house.

All sockets used on the exit and emergency lighting should be of the keyless type, so that they cannot be controlled from any point except the lobby.

5. Every portion of the theater devoted to the use or accommodation of the public, also all outlets leading to the streets and including all open courts, corridors, stairways, exits and emergency exit stairways, should be well and properly lighted during every performance, and the same should remain lighted until the entire audience has left the premises.

To conform with this rule there should be provided in

the auditorium a sufficient number of lights to properly illuminate it at all times. These lights should never be turned out while the audience is in the building. They should be supplied with current from the emergency mains and should be controlled from the lobby.

32. Car Wiring and Equipment of Cars.

a. Protection of Car Body, etc.

1. Under side of car bodies to be protected by *approved* fire-resisting, insulating material, not less than 1-8 inch in thickness, or by sheet iron or steel, not less than .04 inch in thickness, as specified in Section *a*, 2, 3 and 4. This protection to be provided over all electrical apparatus, such as motors with a capacity of over 75 H. P. each, resistances, contactors, lightning arresters, air-brake motors, etc., and also where wires are run, except that protection may be omitted over wires designed to carry 25 amperes or less if they are encased in metal conduit.

2. At motors of over 75 H. P. each, fire-resisting material or sheet iron or steel to extend not less than 8 inches beyond all edges of openings in motors and not less than 6 inches beyond motor leads on all sides.

3. Over resistances, contractors and lightning arresters, and other electrical apparatus, excepting when amply protected by their casing, fire-resisting material or sheet iron or steel to extend not less than 8 inches beyond all edges of the devices.

4. Over conductors, not encased in conduit, and conductors in conduit when designed to carry over 25 amperes, unless the conduit is so supported as to give not less than $\frac{1}{2}$ inch clear air space between the conduit and the car, fire-resisting material or sheet iron or steel to extend at least 6 inches beyond conductors on either side.

The fire-resisting insulating material or sheet iron or steel may be omitted over cables made up of flame-proof braided outer covering when surrounded by 1-8 inch flame-proof covering, as called for by Section *i*, 4.

5. In all cases fireproof material or sheet iron or steel

to have joints well fitted, to be securely fastened to the sills, floor timbers and cross braces, and to have the whole surface treated with a waterproof paint.

6. Cut-out and switch cabinets to be substantially made of hard wood. The entire inside of cabinet to be lined with not less than 1-8 inch fire-resisting insulating material which shall be securely fastened to the woodwork, and after the fire-resisting material is in place the inside of the cabinet shall be treated with a waterproof paint.

b. Wires, Cables, etc.

1. All conductors to be stranded, the allowable carrying capacity being determined by Table "A" of No. 16, except that motor, trolley and resistance leads shall not be less than No. 7 B. & S. gage, heater circuits not less than No. 12 B. & S. gage, and lighting and other auxiliary circuits not less than No. 14 B. & S. gage.

The current used in determining the size of motor, trolley and resistance leads shall be the per cent of the full load current, based on one hour's run of the motor, as given by the following table:

Size each motor.	Motor Leads.	Trolley Leads.	Resistance Leads.
75 H. P. or less	50%	40%	15%
Over 75 H. P.	45%	35%	15%

Fixture wire complying with No. 46 will be permitted for wiring *approved* clusters.

2. To have an insulation and braid as called for by No. 41 for wires carrying currents of the same potential.

3. When run in metal conduit, to be protected by an additional braid as called for by No. 47.

Where conductors are laid in conduit, not being drawn through, the additional braid will not be required.

4. When not in conduit, in *approved* moulding, or in cables surrounded by $\frac{1}{8}$ inch flameproof covering, must comply with the requirements of No. 41 (except that tape may be substituted for braid) and be protected by an additional flameproof braid, at least 1-32 inch in thickness, the outside being saturated with a preservative flameproof compound.

This rule will be interpreted to include the leads from the motors.

5. Must be so spliced or joined as to be both mechanically and electrically secure without solder. The joints must then be soldered and covered with an insulation equal to that on the conductors.

Joints made with *approved* splicing devices and those connecting the leads at motors, plows or third rail shoes need not be soldered.

6. All connections of cables to cut-outs, switches and fittings, except those to controller connection boards, when designed to carry over 25 amperes, must be provided with lugs that will grip the conductor between the screw and the lug, the screws being provided with flat washers; or by block terminals having two set screws, and the end of the conductors must be dipped in solder. Soldering, in addition to the connection of the binding screws, is strongly recommended, and will be insisted upon when above requirements are not complied with.

This rule will not be construed to apply to circuits where the maximum potential is not over 25 volts and current does not exceed 5 amperes.

c. Cut-outs, Circuit Breakers and Switches.

1. All cut-outs and switches having exposed live metal parts to be located in cabinets. Cut-outs and switches, not in iron boxes or in cabinets, shall be mounted on not less than $\frac{1}{4}$ inch fire-resisting insulating material, which shall project at least $\frac{1}{2}$ inch beyond all sides of the cut-out or switch.

2. Cut-outs to be of the *approved* cartridge or *approved* blow-out type.

3. All switches controlling circuits of over 5 ampere capacity shall be of *approved* single pole, quick break or *approved* magnetic blow-out type.

Switches controlling circuits of 5 ampere or less capacity may be of the *approved* single pole, double break, snap type.

4. Circuit breakers to be of *approved* type.

5. Circuits must not be fused above their safe carrying capacity.

6. A cut-out must be placed as near as possible to the

current collector, so that the opening of the fuse in this cut-out will cut off all current from the car.

When cars are operated by metallic return circuits, with circuit breakers connected to both sides of the circuit, no fuses in addition to the circuit breakers will be required.

d. Conduit.

When from the nature of the case, or on account of the size of the conductors, the ordinary pipe and junction box construction is not permissible, a special form of conduit system may be used, provided the general requirements as given below are complied with.

1. Metal conduits, outlet and junction boxes to be constructed in accordance with Nos. 49 and 49A, except that conduit for lighting circuits need not be over 5-16 inch internal diameter and 1-2 inch external diameter, and for heating and air motor circuits need not be over 3-8 inch internal diameter and 9-16 inch external diameter, and all conduits where exposed to dampness must be water tight.

2. Must be continuous between and be firmly secured into all outlet or junction boxes and fittings, making a thorough mechanical and electrical connection between same.

3. Metal conduits, where they enter all outlet or junction boxes and fittings, must be provided with *approved* bushings fitted so as to protect cables from abrasion.

4. Except as noted in Section *i*, 2, must have the metal of the conduit permanently and effectively grounded.

5. Junction and outlet boxes must be installed in such a manner as to be accessible.

6. All conduits, outlets or junction boxes and fittings to be firmly and substantially fastened to the framework of the car.

e. Moulding

1. To consist of a backing and a capping and to be constructed of fire-resisting insulating material, except that it may be made of hard wood where the circuits which it is designed to support are normally not exposed to moisture.

2. When constructed of fire-resisting insulating material, the backing shall be not less than 1-4 inch in thickness and be of a width sufficient to extend not less than 1 inch beyond conductors at sides.

The capping, to be not less than $\frac{1}{8}$ inch in thickness, shall cover and extend at least $\frac{3}{4}$ inch beyond conductors on either side.

The joints in the moulding shall be mitered to fit close, the whole material being firmly secured in place by screws or nails and treated on the inside and outside with a waterproof paint.

When fire-resisting moulding is used over surfaces already protected by 1-8 inch fire-resisting insulating material no backing will be required.

3. Wooden mouldings must be so constructed as to thoroughly encase the wire and provide a thickness of not less than 3-8 inch at the sides and back of the conductors, the capping being not less than 3-16 inch in thickness. Must have both outside and inside two coats of waterproof paint.

The backing and the capping shall be secured in place by screws.

f. Lighting and Lighting Circuits

1. Each outlet to be provided with an *approved* porcelain receptacle, or an *approved* cluster. No lamp of over 32 candle power to be used.

2. Circuits to be run in *approved* metal conduit or *approved* moulding.

3. When metal conduit is used, except for sign lights, all outlets to be provided with *approved* outlet boxes.

4. At outlet boxes, except where *approved* clusters are used, porcelain receptacles to be fastened to the inside of the box and the metal cover to have an insulating bushing around opening for the lamp.

When *approved* clusters are used, the cluster shall be thoroughly insulated from the metal conduit, being mounted on a block of hard wood or fire-resisting insulating material.

5. Where conductors are run in moulding the porcelain receptacles or cluster to be mounted on blocks of hard wood or of fireproof insulating material.

g. Heaters and Heating Circuits

1. Heaters to be of *approved* type.

2. Panel heaters to be so constructed and located that when heaters are in place all current carrying parts will be at least 4 inches from all woodwork.

Heaters for cross seats to be so located that current carrying parts will be at least 6 inches below under side of seat, unless under side of seat is protected by not less than 1-4 inch fire-resisting insulating material, or .04 inch sheet metal with 1 inch air space over same, when the distance may be reduced to 3 inches.

2. Circuits to be run in *approved* metal conduit, or in *approved* moulding, or if the location of conductors is such as will permit an air space of not less than 2 inches on all sides except from the surface wired over they may be supported on porcelain knobs or cleats, provided the knobs or cleats are mounted on not less than 1-4 inch fire-resisting insulating material extending at least 3 inches beyond conductors at either side, the supports raising the conductors not less than 1-2 inch from the surface wired over and being not over 12 inches apart.

h. Air Pump Motor and Circuits.

1. Circuits to be run in *approved* metal conduit or in *approved* moulding, except that when run below the floor of the car they may be supported on porcelain knobs or cleats, provided the supports raise the conductor at least 1-2 inch from the surface wired over and are not over 12 inches apart.

2. Automatic control to be enclosed in *approved* metal box. Air pump and motor, when enclosed, to be in *approved* metal box or wooden box lined with metal of not less than 1-32 inch thickness.

When conductors are run in metal conduits the boxes surrounding automatic control and air pump and motors may serve as outlet boxes.

i. Main Motor Circuits and Devices.

1. Conductors connecting between trolley stand and main cut-out or circuit breakers in hood to be protected where wires enter car to prevent ingress of moisture.

2. Conductors connecting between third rail shoes on same truck to be supported in an *approved* fire-resisting insulating moulding or in *approved* iron conduit supported by soft rubber or other *approved* insulating cleats.

3. Conductors on the under side of the car, except as noted in Section *i*, 4, to be supported in accordance with one of the following methods:

a. To be run in *approved* metal *conduit*, junction boxes being provided where branches in conduit are made and outlet boxes where conductors leave conduit.

b. To be run in *approved* fire-resisting insulating moulding.

c. To be supported by insulating cleats, the supports being not over 12 inches apart.

4. Conductors with flameproof braided outer covering, connecting between controllers at either end of car, or controllers and contactors, may be run as a cable, provided the cable where exposed to the weather is encased in a canvas hose or canvas tape, thoroughly taped or sewed at ends and where taps from the cable are made, and the hose or tape enters the controllers.

Conductors with or without flameproof braided outer covering connecting between controllers at either end of the car, or controllers and contactors, may be run as a cable, provided the cable throughout its entire length is surrounded by 1-8 inch flameproof covering, thoroughly taped or sewed at ends, or where taps from cable are made, and the flameproof covering enters the controllers.

Cables where run below floor of car may be supported by *approved* insulating straps or cleats. Where run above floor of car, to be in a metal conduit or wooden box painted on the inside with not less than two coats of flameproof paint, and where this box is so placed that it is exposed to water, as by washing of the car floor, attention should be given to making the box reasonably waterproof.

Canvas hose or tape, or flameproof material surrounding cables after conductors are in same, to have not less than two coats of waterproof insulating material.

5. Motors to be so drilled that, on double truck cars, connecting cables can leave motor on side nearest to king bolt.

6. Resistances to be so located that there will be at least 6 inch air space between resistances proper and fire-resisting material of the car. To be mounted on iron supports, being insulated by non-combustible bushings or washers, or the iron supports shall have at least 2 inches of insulating surface between them and metal work of car, or the resistances may be mounted on hardwood bars, supported by iron stirrups, which shall have not less than 2 inches of insulating surface between foot of resistance and metal stirrup, the entire surface of the bar being covered with at least 1-8 inch fire-resisting insulating material.

The insulation of the conductor, for about 6 inches from terminal of the resistance, should be replaced, if any insulation is necessary, by a porcelain bushing or asbestos sleeve.

7. Controllers to be raised above platform of car by a not less than 1 inch hardwood block, the block being fitted and painted to prevent moisture working in between it and the platform.

j. Lightning Arresters

1. To be preferably located to protect all auxiliary circuits in addition to main motor circuits.

2. The ground conductor shall be not less than No. 6 B. & S. gage, run with as few kinks and bends as possible, and be securely grounded.

k. General Rules

1. When passing through floors, conductors or cables must be protected by *approved* insulating bushings, which shall fit the conductor or cable as closely as possible.

2. Mouldings should never be concealed except where readily accessible. Conductors should never be tacked into moulding.

3. Short bends in conductors should be avoided where possible.

4. Sharp edges in conduit or in moulding must be smoothed to prevent injury to conductors.

33. Car Houses.

a. The trolley wires must be securely supported on insulating hangers.

b. The trolley hangers must be placed at such a distance apart that, in case of a break in the trolley wire, contact with the floor cannot be made.

c. Must have an emergency cut-out switch located at a proper place outside of the building, so that all the trolley wires in the building may be cut out at one point, and line insulators must be installed, so that when this emergency switch is open, the trolley wire will be dead at all points within 100 feet of the building. The current must be cut out of the building when not needed for use in the building.

This may be done by the emergency switch, or if preferred a second switch may be used that will cut out all current from the building, but which need not cut out the trolley wire outside as would be the case with the emergency switch.

d. All lamps and stationary motors must be installed in such a way that one main switch may control the whole of each installation, lighting and power, independently of the main cut-out switch called for in Section *c*.

e. Where current for lighting and stationary motors is from a grounded trolley circuit, the following special rules to apply:

1. Cut-outs must be placed between the non-grounded side and lights or motors they are to protect. No set or group of incandescent lamps requiring over 2,000 watts must be dependent upon one cut-out.
2. Switches must be placed between non-grounded side and lights and motors they are to protect.

3. Must have all rails bonded at each joint with a conductor having a carrying capacity at least equivalent to No. 00 B. & S. gage annealed copper wire, and all rails must be connected to the outside ground return circuit by a not less than No. 00 B. & S. gage copper wire or by equivalent bonding through the track. All lighting and stationary motor circuits must be thoroughly and permanently connected to the rails or to the wire leading to the outside ground return circuit.
 - f. All pendant cords and portable conductors will be considered as subject to hard usage (see 45-f).
 - g. Must, except as provided in Section e, have all wiring and apparatus installed in accordance with the rules for constant potential systems.
 - h. Must not have any system of feeder distribution centering in the building.
 - i. Cars must not be left with the trolley in electrical connection with the trolley wire.

34. Lighting and Power from Railway Wires.

a. Must not be permitted under any pretense, in the same circuit with trolley wires with a ground return, except in electric railway cars, electric car houses and their power stations, nor shall the same dynamo be used for both purposes.

HIGH-POTENTIAL SYSTEMS.

550 TO 3,500 VOLTS.

Any circuit attached to any machine or combination of machines which develops a difference of potential, between any two wires, of over 550 volts and less than 3,500 volts, shall be considered as a high-potential circuit, and as coming under that class, unless an approved transforming device is used, which cuts the difference of potential down to 550 volts or less.

(See note following first paragraph under Low-Potential systems.)

35. Wires.

(See also Nos. 14, 15 and 16.)

a. Must have an *approved* rubber-insulating covering (see No. 41).

b. Must be always in plain sight and never encased, except as provided for in No. 8 *b*, or where required by the Inspection Department having jurisdiction.

c. Must (except as provided for in No. 8 *b*), be rigidly supported on glass or porcelain insulators, which raise the wire at least one inch from the surface wired over, and must be kept about eight inches apart.

Rigid supporting requires, under ordinary conditions, where wiring along flat surfaces, supports at least about every four and one-half feet. If the wires are unusually liable to be disturbed, the distance between supports should be shortened.

In buildings of mill construction, mains of No. 8 B. & S. gage or over, where not liable to be disturbed, may be separated about ten inches and run from timber to timber, not breaking around, and may be supported at each timber only.

d. Must be protected on side walls from mechanical injury by a substantial boxing, retaining an air space of one inch around the conductors, closed at the top (the wires passing through bushed holes) and extending not less than seven feet from the floor. When crossing floor timbers, in cellars, or in rooms where they might be exposed to injury wires must be attached by their insulating supports to the under side of a wooden strip not less than one-half an inch in thickness.

For general suggestions on protection, see note under No. 24 e. See also note under No. 18 e.

36. Transformers. (When permitted inside buildings, see No. 13.)

(For construction rules, see No. 62.)

(See also Nos. 13 and 13 A.)

Transformers must not be placed inside of buildings without special permission from the Inspection Department having jurisdiction.

a. Must be located as near as possible to the point at which the primary wires enter the building.

b. Must be placed in an enclosure constructed of fire-resisting material; the enclosure to be used only for this purpose, and to be kept securely locked, and access to the same allowed only to responsible persons.

c. Must be thoroughly insulated from the ground, or permanently and effectually grounded, and the enclosure in which they are placed must be practically air-tight, except that it must be thoroughly ventilated to the out-door air, if possible, through a chimney or flue. There should be at least six inches air space on all sides of the transformer.

37. Series Lamps.

a. No multiple series or series multiple system of lighting will be approved.

b. Must not, under any circumstances, be attached to gas fixtures.

EXTRA-HIGH-POTENTIAL SYSTEMS.

OVER 3,500 VOLTS.

Any circuit attached to any machine or combination of machines which develops a difference of potential, between any two wires, of over 3,500 volts, shall be considered as an extra-high-potential circuit, and as coming under that class, unless an approved transforming device is used, which cuts the difference of potential down to 3,500 volts or less.

38. Primary Wires.

a. Must not be brought into or over buildings, except power stations and sub-stations.

39. Secondary Wires.

a. Must be installed under rules for high-potential systems when their immediate primary wires carry a current at a potential of over 3,500 volts, unless the primary wires are installed in accordance with the requirements as given in rule 12 A or are entirely underground, within city, town and village limits.

NOTICE—DO NOT FAIL TO SEE WHETHER ANY RULE OR ORDINANCE OF YOUR CITY CONFLICTS WITH THESE RULES.

CLASS D.

**FITTINGS, MATERIALS AND DETAILS OF
CONSTRUCTION.**

*(Light, Power and Heat. For Signaling Systems see
Class E.)*

ALL SYSTEMS AND VOLTAGES.

The following rules are but a partial outline of requirements. Devices or material which fulfill the conditions of these requirements and no more will not necessarily be acceptable. All fittings and materials should be submitted for examination and test before being introduced for use.

INSULATED WIRES—Rules 40 to 48.

40. General Rules.

a. Copper for insulated solid conductors of No. 4 B. & S. gage and smaller must not vary in diameter more than .002 of an inch from the standard. On solid sizes larger than No. 4 B. & S. gage the diameter shall not vary more than one per cent from the specified standard. The conductivity of solid conductors shall not be less than 97% of that of pure copper of the specified size.

In all stranded conductors the sum of the circular mils of the individual wires shall not be less than the nominal circular mils of the strand by more than one and one-half per

cent. The conductivity of the individual wires in a strand shall not be less than is given in the following table:

Number	Per cent
14 and larger	97.0
15	96.8
16	96.6
17	96.4
18	96.2
19	96.0
20	95.8
21	95.6
22	95.4
23	95.2
24	95.0
25	94.8
26	94.6
27	94.4
28	94.2
29	94.0
30	93.8

The Standard for diameters and mileages shall be that adopted by the American Institute of Electrical Engineers.

b. Wires and cables of all kinds designed to meet the following specifications must have a distinctive marking the entire length of the coil, so that they may be readily identified in the field. They must also be plainly tagged or marked as follows:

1. The maximum voltage at which the wire is designed to be used.
2. The words "National Electrical Code Standard."
3. Name of the manufacturing company and, if desired, trade name of the wire.
4. Month and year when manufactured.

Wires described under Nos. 42, 43 and 44 need not have the distinctive marking, but are to be tagged.

41. Rubber-Covered Wire.

a. Copper for conductors must be thoroughly tinned.

Insulation for Voltages, 0 to 600 inclusive.

b. Must be of rubber or other approved substances,

homogeneous in character, adhering to the conductor and of a thickness not less than that given in the following table:

B. & S. Gage.		Thickness.
18 to	16.....	1-32 inch
15 to	8.....	3-64 "
7 to	2.....	1-16 "
1 to	0000.....	5-64 "

Circular Mils.		
250,000 to	500,000.....	3-32 "
500,000 to	1,000,000.....	7-64 "
Over	1,000,000.....	1-8 "

Measurements of insulating wall are to be made at the thinnest portion of the dielectric.

c. The completed coverings must show an insulation resistance of at least 100 megohms per mile during thirty days' immersion in water at 70 degrees Fahrenheit (21 degrees Centigrade).

d. Each foot of the completed covering must show a dielectric strength sufficient to resist throughout five minutes the application of an electro-motive force proportionate to the thickness of insulation in accordance with the following table:

Thickness in 64th inches.	Breakdown Test on 1 foot.
1	3,000 Volts A. C.
2	6,000 " "
3	9,000 " "
4	11,000 " "
5	13,000 " "
6	15,000 " "
7	16,500 " "
8	18,000 " "
10	21,000 " "
12	23,500 " "
14	26,000 " "
16	28,000 " "

The source of alternating electro-motive force shall be a transformer of at least one kilowatt capacity. The application of the electro-motive force shall first be made at 4,000 volts for five minutes and then the voltage increased by steps of not over 3,000 volts, each held for five minutes, until the rupture of the insulation occurs. The test for dielectric strength shall be made on a sample of wire which has been immersed in

water for seventy-two hours. One foot of wire under test is to be submerged in a conducting liquid held in a metal trough, one of the transformer terminals being connected to the copper of the wire and the other to the metal of the trough.

Insulations for Voltages between 600 and 3,500.

e. The thickness of the insulating wall must not be less than that given in the following table:

B. & S. Gage.	Thickness.
14 to 1.....	3-32 inch.
0 to 0000.....	3-32 inch, covered by tape or braid.
Circular Mils.	
250,000 to 500,000.....	3-32 inch, covered by tape or braid.
Over 500,000.....	1-8 inch, covered by tape or braid.

f. The requirements as to insulation and break-down resistance for wires for low-potential systems shall apply, with the exception that an insulation resistance of not less than 300 megohms per mile shall be required.

Insulation for Voltage over 3,500.

g. Wire for arc-light circuits exceeding 3,500 volts potential must have an insulating wall not less than three-sixteenths of an inch in thickness, and shall withstand a break-down test of at least 23,500 volts and have an insulation of at least 500 megohms per mile.

The tests on this wire to be made under the same conditions as for low-potential wires.

Specifications for insulations for alternating currents exceeding 3,500 volts have been considered, but on account of the somewhat complex conditions in such work it has so far been deemed inexpedient to specify general insulations for this use.

General.

h. The rubber compound or other approved substance used as insulation must be sufficiently elastic to permit all wires smaller than No. 7 B. & S. gage and larger than No. 11 B. & S. gage to be bent without injury to the insulation

around a cylinder twice the diameter of the insulated wire measured over the outer covering. All wires No. 11 B. & S. gage and smaller to be bent without injury to the insulation around a cylinder equal to the diameter of the insulated wire measured over the outer covering.

i. All of the above insulations must be protected by a substantial braided covering, properly saturated with a preservative compound. This covering must be sufficiently strong to withstand all the abrasion likely to be met with in



Figure 138.

practice, and must substantially conform to approved samples submitted by the manufacturer.

42. Slow-burning Weatherproof Wire.

(See Figure 138.)

This wire is not as burnable as "weatherproof" nor as subject to softening under heat. It is not suitable for outside work.

a. The insulation must consist of two coatings, one to be fireproof in character and the other to be weatherproof. The fireproof coating must be on the outside and must comprise about six-tenths of the total thickness of the wall. The completed covering must be of a thickness not less than that given in the following table:

B. & S. Gage.	Thickness.
14 to 8.....	3-64 inch
7 to 2.....	1-16 "
1 to 0000.....	5-64 "
 Circular Mils.	
250,000 to 500,000.....	3-32 "
500,000 to 1,000,000.....	7-64 "
Over 1,000,000.....	1-8 "

Measurements of insulating wall are to be made at the thinnest portion of the dielectric.

b. The fireproof coating shall be of the same kind as that

required for "slow-burning wire," and must be finished with a hard, smooth surface.

c. The weatherproof coating shall consist of a stout braid, applied and treated as required for "weatherproof wire."

43. Slow-burning Wire.

a. The insulation must consist of three braids of cotton or other thread, all the interstices of which must be filled with the fireproofing compound or with material having equivalent resisting and insulating properties. The outer braid must be specially designed to withstand abrasion, and



Figure 139.

its surface must be finished smooth and hard. The completed covering must be of a thickness not less than that given in the table under No. 42 a.

The solid constituent of the fireproofing compound must not be susceptible to moisture, and must not burn even when ground in an oxidizable oil, making a compound which, while proof against fire and moisture, at the same time has considerable elasticity, and which when dry will suffer no change at a temperature of 250 degrees Fahrenheit (121 degrees Centigrade), and which will not burn at even a higher temperature.

This is practically the old so-called "underwriters" insulation. It is especially useful in hot, dry places where ordinary insulations would perish, and where wires are bunched, as on the back of a large switchboard or in wire tower, so that the accumulation of rubber insulation would result in an objectionably large mass of highly inflammable material.

44. Weatherproof Wire.

(See Figure 139.)

a. The insulating covering shall consist of at least three braids, all of which must be thoroughly saturated with a dense moisture-proof compound, applied in such a manner as to drive any atmospheric moisture from the cotton braiding,

thereby securing a covering to a great degree waterproof and of high insulating power. This compound must retain its elasticity at 0 deg. Fahr. and must not drip at 160 deg. Fahr. The thickness of insulation must not be less than that given in the table No. 42 A, and the outer surface must be thoroughly slicked down.

This wire is for use outdoors, where moisture is certain and where fireproof qualities are not necessary.

45. Flexible Cord.

(For installation rules, see No. 28.)

a. Must, except as required for portable heating apparatus (see section g), be made of stranded copper conductors, each strand to be not larger than No. 26 or smaller



Figure 140.

than No. 30 B. & S. gage, and each stranded conductor must be covered by an *approved* insulation and protected from mechanical injury by a tough, braided outer covering.

For Pendant Lamps.

(See Figure 140.)

In this class is to be included all flexible cord which, under usual conditions, hangs freely in air, and which is not likely to be moved sufficiently to come in contact with surrounding objects.

It should be noted that pendant lamps provided with long cords, so that they can be carried about or hung over nails or on machinery, etc., are not included in this class, even though they are usually allowed to hang freely in air.

b. Each stranded conductor must have a carrying capacity equivalent to not less than a No. 18 B. & S. gage wire.

c. The covering of each stranded conductor must be made up as follows:

1. A tight, close wind of fine cotton.
2. The insulation proper, which shall be waterproof.

3. An outer cover of silk or cotton.

The wind of cotton tends to prevent a broken strand puncturing the insulation and causing a short circuit. It also keeps the rubber from corroding the copper.

d. The insulation must be solid, at least one thirty-second of an inch thick, and must show an insulation resistance of fifty megohms per mile throughout two weeks' immersion in water at 70 degrees Fahrenheit, and stand the tests prescribed for low-tension wires as far as they apply.

e. The outer protecting braiding should be so put on and sealed in place that when cut it will not fray out and where cotton is used it should be impregnated with a flameproof paint, which will not have an injurious effect on the insulation.

For Portables.

(See Figure 141.)

In this class is included all cord used on portable lamps, small portable motors, or any device which is liable to be carried about.

f. Flexible cord for portable use except in offices, dwellings or similar places, where cord is not liable to rough usage and where appearance is an essential feature, must meet all the requirements for flexible cord for "pendant lamps," both



Figure 141.

as to construction and thickness of insulation, and in addition must have a tough braided cover over the whole. There must also be an extra layer of rubber between the outer cover and the flexible cord, and in moist places the outer cover must be saturated with a moisture-proof compound, thoroughly slicked down, as required for "weatherproof wire" in No. 44. In offices, dwellings, or in similar places where cord is not liable to rough usage and where appearance is an essential feature, flexible cord for portable use must meet all of the requirements for flexible cord for "pendant lamps,"

both as to construction and thickness of insulation, and in addition must have a tough, braided cover over the whole, or providing there is an extra layer of rubber between the flexible cord and the outer cover, the insulation proper on each stranded conductor of cord may be 1-64 of an inch in thickness instead of 1-32 of an inch as required for pendant cords.

Flexible cord for portable use may, instead of the outer coverings described above, have an approved metal flexible armor.

For Portable Heating Apparatus.

(See Figure 142.)

Applies to all smoothing and sad irons and to any other device requiring over 250 watts.

g. Must be made as follows:

1. Conductors must be of braided copper, each strand not to be larger than No. 30 or smaller than No. 36 B. & S. gage.

When conductors have a greater carrying capacity than No. 12 B. & S. gage they may be braided or stranded with each strand as large as No. 28 B. & S. gage. If stranded there must be a tight, close wind of cotton between the conductor and the insulation.



Figure 142.

2. An insulating covering of rubber or other *approved* material not less than one sixty-fourth inch in thickness.
3. A braided covering of not less than one thirty-second inch thick, composed of best quality long fiber asbestos, containing not over 5 per cent of vegetable fiber.
4. The several conductors comprising the cord to be enclosed by an outer reinforcing covering not less than one sixty-fourth inch thick, especially designed to resist abrasion, and so treated as to prevent the cover from fraying.

46. Fixture Wire.

(See Figure 143.)

(For installation rules, see No. 24 *v* to *y*.)

a. May be made of solid or stranded conductors, with no strands smaller than No. 30 B. & S. gage, and must have a carrying capacity not less than that of a No. 18 B. & S. gage wire.

b. Solid conductors must be thoroughly tinned. If a stranded conductor is used, it must be covered by a tight, close wind of fine cotton.

c. Must have a solid rubber insulation of a thickness not less than one thirty-second of an inch for Nos. 18 to 16 B. & S. gage, and three sixty-fourths of an inch for Nos. 14 to 8 B. & S. gage, except that in arms of fixtures not exceeding twenty-four inches in length and used to supply not more than one sixteen-candle-power lamp or its equivalent, which are



Figure 143.

so constructed as to render impracticable the use of a wire with one thirty-second of an inch thickness of rubber insulation, a thickness of one sixty-fourth of an inch will be permitted.

d. Must be protected with a covering at least one sixty-fourth of an inch in thickness, sufficiently tenacious to withstand the abrasion of being pulled into the fixture, and sufficiently elastic to permit the wire to be bent around a cylinder with twice the diameter of the wire without injury to the braid.

c. Must successfully withstand the tests specified in Nos. 41 *c* and 41 *d*.

In wiring certain designs of show-case fixtures, ceiling bulls-eyes and similar appliances in which the wiring is exposed to temperatures in excess of 120 degrees Fahrenheit (49 degrees Centigrade), from the heat of the lamps, slow-burning wire may be used (see No. 43). All such forms of fixtures must be submitted for examination, test and approval before being introduced for use.

47. Conduit Wire.

(For installation rules, see No. 24 n. to p.)

a. Single wire for lined conduits must comply with the requirements of No. 41 (Figure 144). For unlined conduits it must comply with the same requirements—except that



Figure 144.



Figure 145.



Figure 146.

tape may be substituted for braid—and in addition there must be a second outer fibrous covering, at least one thirty-second of an inch in thickness and sufficiently tenacious to withstand the abrasion of being hauled through the metal conduit (Figures 145 and 146).

b. For twin or duplex wires in lined conduit, each conductor must comply with the requirements of No. 41—except that tape may be substituted for braid on the separate conductors—and must have a substantial braid covering the whole. For unlined conduit, each conductor must comply with requirements of No. 41—except that tape may be substituted for braid—and in addition must have a braid covering the whole, at least one thirty-second of an inch in thickness and sufficiently tenacious to withstand the abrasion of being hauled through the metal conduit (Figure 147).

c. For concentric wire, the inner conductor must comply with the requirements of No. 41—except that tape may be



Figure 147.



Figure 148.

substituted for braid—and there must be outside of the outer conductor the same insulation as on the inner, the whole to be covered with a substantial braid, which for unlined conduits must be at least one thirty-second of an inch in thickness, and sufficiently tenacious to withstand the abrasion of being hauled through the metal conduit. (Figure 148).

The braid or tape required around each conductor in duplex, twin and concentric cables is to hold the rubber insulation in place and prevent jamming and flattening.

All the braids specified in this rule must be properly saturated with a preservative compound.

48. Armored Cable.

(See Figure 149.)

(For installation rules, see No. 24A.)

a. The armor of such cables must have at least as great strength to resist penetration of nails, etc., as is required for

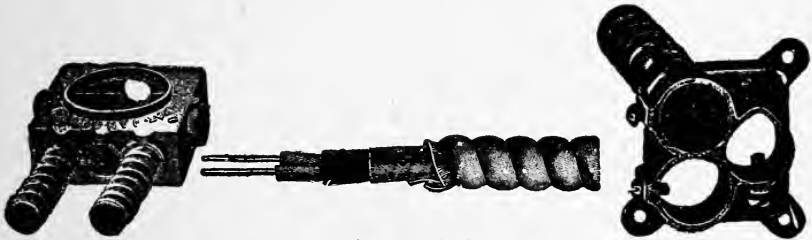

Figure 149.

metal conduits (see No. 49 b), and its thickness must not be less than that specified in the following table:

Nominal Internal Diameter. Inches.	Actual Internal Diameter. Inches.	Actual External Diameter. Inches.	Thickness of Wall. Inches.
1/8	.27	.40	.06
1/4	.36	.54	.08
3/8	.49	.67	.09
1/2	.62	.84	.10
3/4	.82	1.05	.11
1	1.04	1.31	.13
1 1/4	1.38	1.66	.14
1 1/2	1.61	1.90	.14
2	2.06	2.37	.15
2 1/2	2.46	2.87	.20
3	3.06	3.50	.21
3 1/2	3.54	4.00	.22
4	4.02	4.50	.23
4 1/2	4.50	5.00	.24
5	5.04	5.56	.25
6	6.06	6.62	.28

An allowance of two one-hundredths of an inch for variation in manufacturing and loss of thickness by cleaning will be permitted.

b. The conductors in same, single wire or twin conductors, must have an insulating covering as required by No. 41; if any filler is used to secure a round exterior, it must be impregnated with a moisture repellent, and the whole bunch of conductors and fillers must have a separate exterior covering.

49. Interior Conduits.

(For installation rules, see Nos. 24 *n* to *p* and 25.)

a. Each length of conduit, whether lined or unlined, must have the maker's name or initials stamped in the metal or attached thereto in a satisfactory manner, so that inspectors can readily see the same.

The use of paper stickers or tags cannot be considered satisfactory methods of marking, as they are readily loosened and lost off in the ordinary handling of the conduit.

Metal Conduits with Lining of Insulating Material.

(See Figure 150.)

b. The metal covering or pipe must be at least as strong as the ordinary commercial forms of gas pipe of the same

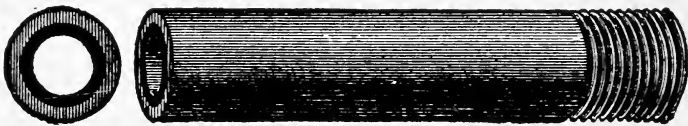

Figure 150.

size, and its thickness must be not less than that of standard gas pipe as specified in the table given in No. 48.

c. Must not be seriously affected externally by burning out a wire inside the tube when the iron pipe is connected to one side of the circuit.

d. Must have the insulating lining firmly secured to the pipe.

e. The insulating lining must not crack or break when a length of the conduit is uniformly bent at temperature of 212

degrees Fahrenheit to an angle of ninety degrees, with a curve having a radius of fifteen inches, for pipes of one inch and less, and fifteen times the diameter of pipe for larger sizes.

f. The insulating lining must not soften injuriously at a temperature below 212 degrees Fahrenheit and must leave water in which it is boiled practically neutral.

g. The insulating lining must be at least one thirty-second of an inch in thickness. The materials of which it is composed must be of such a nature as will not have a deteriorating effect on the insulation of the conductor and be sufficiently tough and tenacious to withstand the abrasion test of drawing long lengths of conductors in and out of same.

h. The insulating lining must not be mechanically weak after three days' submersion in water, and when removed from the pipe entire must not absorb more than ten per cent of its weight of water during 100 hours of submersion.

i. All elbows or bends must be so made that the conduit or lining of same will not be injured. The radius of the curve of the inner edge of any elbow must not be less than three and one-half inches.

Unlined Metal Conduits.

(See Figure 151.)

j. Pipe sizes to run as follows:

Trade Size. Inches.	Approximate Internal Diameter. Inches.	Minimum Thickness of Wall. Inches.
$\frac{1}{2}$.62	.100
$\frac{3}{4}$.82	.105
1	1.04	.125
$1\frac{1}{4}$	1.38	.135
$1\frac{1}{2}$	1.61	.140
2	2.06	.150
$2\frac{1}{2}$	2.46	.200
3	3.06	.210
$3\frac{1}{2}$	3.54	.220

At no point (except at screw thread) shall the thickness of wall of finished conduit be less than the minimum specified in last column of above table.

k. Pipe to be thoroughly cleaned to remove all scale.

Pipe should be of sufficiently true circular section to admit of cutting true, clean threads, and should be very closely the same in wall thickness at all points with clean square weld.



Figure 151.

l. Cleaned pipe to be protected against effects of oxidation, by baked enamel, zinc or other approved coating which will not soften at ordinary temperatures, and of sufficient weight and toughness to successfully withstand rough usage likely to be received during shipment and installation; and

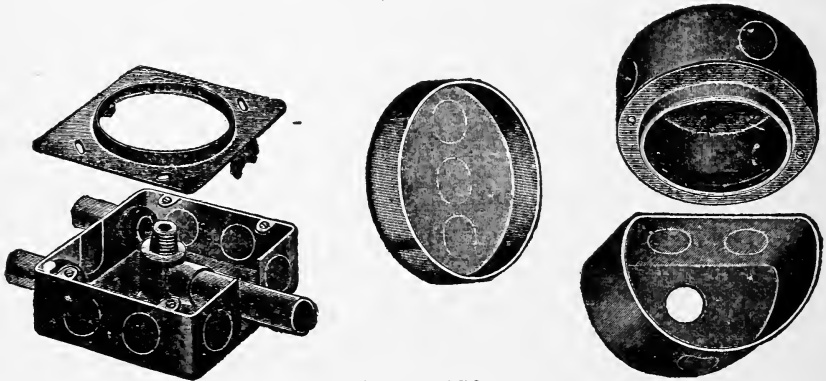

Figure 152.

of sufficient elasticity to prevent flaking when $\frac{1}{2}$ inch conduit is bent in a curve the inner edge of which has radius of $3\frac{1}{2}$ inches.

m. All elbows or bends must be so made that the conduit will not be injured. The radius of the curve of the inner edge of any elbow not to be less than $3\frac{1}{2}$ inches.

49 A. Switch and Outlet Boxes.

(See Figure 152.)

a. Must be of pressed steel having a wall thickness not

less than .081 in. (No. 12 B. & S. gage) or of cast metal having a wall thickness not less than 0.128 in. (No. 8 B. & S. gage.)

b. Must be well galvanized, enameled or otherwise properly coated, inside and out, to prevent oxidation.

c. Must be so made that all openings not in use will be effectively closed by metal which will afford protection substantially equivalent to the walls of the box.

d. Must be plainly marked, where it may readily be seen when installed, with the name or trade mark of the manufacturer.

e. Must be arranged to secure in position the conduit or flexible tubing protecting the wire.

This rule will be complied with if the conduit or tubing is firmly secured in position by means of some *approved* device which may or may not be a part of the box.

f. Boxes used with lined conduit must comply with the foregoing requirements, and in addition must have a tough and tenacious insulating lining at least 1-32 inch thick, firmly secured in position.

g. Switch and outlet boxes must be so arranged that they can be securely fastened in place independently of the support afforded by the conduit piping, except that when entirely exposed, *approved* boxes, which are threaded so as to be firmly supported by screwing on to the conduit pipe, may be used.

h. Switch boxes must completely enclose the switch on sides and back and must provide a thoroughly substantial support for it. The retaining screws for the box must not be used to secure the switch in position.

i. Covers for outlet boxes must be of metal equal in thickness to that specified for the walls of the box, or must be of metal lined with an insulating material not less than 1-32 inch in thickness, firmly and permanently secured to the metal.

50. Mouldings.

(For wiring rules, see No. 24 k to m.)

Wooden Mouldings.

a. Must have, both outside and inside, at least two coats of waterproof material, or be impregnated with a moisture repellent.

b. Must be made in two pieces, a backing and a capping and must afford suitable protection from abrasion. Must be so constructed as to thoroughly encase the wire, be provided with a tongue not less than 1-2 inch in thickness between the

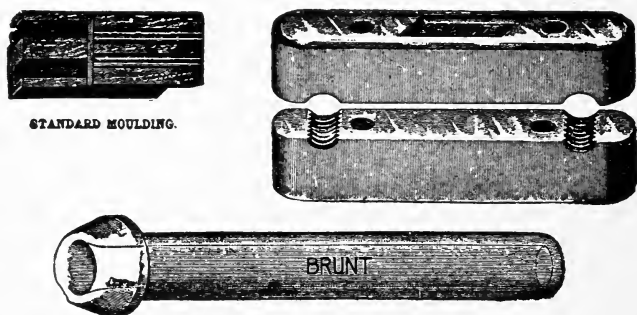

Figure 153.

conductors, and have exterior walls which under grooves shall not be less than 3-8 inch in thickness, and on the sides not less than 1-4 inch in thickness.

It is recommended that only hardwood moulding be used.

Metal Mouldings.

(For wiring rules, see Nos. 24, k to m, and 25 A.)

c. Each length of such moulding must have maker's name or trade mark stamped in the metal, or in some manner permanently attached thereto, in order that it may be readily identified in the field.

The use of paper stickers or tags cannot be considered

satisfactory methods of marking, as they are readily loosened and lost off in ordinary handling of the moulding.

d. Must be constructed of iron or steel with backing at least .050 inch in thickness, and with capping not less than .040 inch in thickness, and so constructed that when in place the raceway will be entirely closed; must be thoroughly galvanized or coated with an approved rust preventive both inside and out to prevent oxidation.

e. Elbows, couplings and all other similar fittings must be constructed of at least the same thickness and quality of metal as the moulding itself and so designed that they will both electrically and mechanically secure the different sections together and maintain the continuity of the raceway. The interior surfaces must be free from burrs or sharp corners which might cause abrasion of the wire coverings.

f. Must at all outlets be so arranged that the conductors cannot come in contact with the edges of the metal, either of capping or backing. Specially designed fittings which will interpose substantial barriers between conductors and the edges of metal are recommended.

g. When backing is secured in position by screws or bolts from the inside of the raceway, depressions must be provided to render the heads of the fastenings flush with the moulding.

h. Metal mouldings must be used for exposed work only and must be so constructed as to form an open raceway to be closed by the capping or cover after the wires are laid in.

50A. Tubes and Bushings.

(See *Figure 153.*)

a. **Construction.**—Must be made straight and free from checks or rough projections, with ends smooth and rounded to facilitate the drawing in of the wire and prevent abrasion of its covering.

b. **Material and Test.**—Must be made of non-combustible insulating material, which, when broken and submerged for 100 hours in pure water at 70 degrees Fahrenheit, will not absorb over one-half of one per cent of its weight.

c. **Marking.**—Must have the name, initials or trade mark of the manufacturer stamped in the ware.

d. **Sizes.**—Dimensions of walls and heads must be at least as great as those given in the following table:

Diameter of Hole. Inches.	External Diameter. Inches.	Thick-ness of Wall. Inches.	External Diameter of Head. Inches.	Length of Head. Inches.
$\frac{5}{16}$	$\frac{9}{16}$	$\frac{1}{8}$	$\frac{13}{16}$	$\frac{1}{2}$
$\frac{3}{8}$	$\frac{11}{16}$	$\frac{5}{32}$	$\frac{15}{16}$	$\frac{1}{2}$
$\frac{1}{2}$	$\frac{13}{16}$	$\frac{5}{32}$	$1\frac{3}{16}$	$\frac{1}{2}$
$\frac{5}{8}$	$\frac{15}{16}$	$\frac{5}{32}$	$1\frac{7}{16}$	$\frac{1}{2}$
$\frac{3}{4}$	$1\frac{3}{16}$	$\frac{7}{32}$	$1\frac{11}{16}$	$\frac{5}{8}$
1	$1\frac{7}{16}$	$\frac{7}{32}$	$1\frac{15}{16}$	$\frac{5}{8}$
$1\frac{1}{4}$	$1\frac{13}{16}$	$\frac{9}{32}$	$2\frac{5}{16}$	$\frac{5}{8}$
$1\frac{1}{2}$	$2\frac{3}{16}$	$\frac{11}{32}$	$2\frac{1}{16}$	$\frac{3}{4}$
$1\frac{3}{4}$	$2\frac{7}{16}$	$\frac{13}{32}$	$3\frac{1}{16}$	$\frac{3}{4}$
2	$2\frac{11}{16}$	$\frac{13}{32}$	$3\frac{7}{16}$	$\frac{3}{4}$
$2\frac{1}{4}$	$3\frac{5}{16}$	$\frac{17}{32}$	$3\frac{13}{16}$	1
$2\frac{1}{2}$	$3\frac{11}{16}$	$\frac{19}{32}$	$4\frac{5}{16}$	1

An allowance of one-sixty-fourth of an inch for variation in manufacturing will be permitted, except in the thickness of the wall.

50B. Cleats.

(See Figure 153.)

a. **Construction.**—Must hold the wire firmly in place without injury to its covering.

Sharp edges which may cut the wire should be avoided.

b. **Supports.**—Bearing points on the surface must be made by ridges or rings about the holes for supporting screws, in order to avoid cracking and breaking when screwed tight.

c. **Material and Test.**—Must be made of non-combustible insulating material, which, when broken and submerged for 100 hours in pure water at 70 degrees Fahrenheit, will not absorb over one-half of one per cent of its weight.

d. **Marking.**—Must have the name, initials or trade mark of the manufacturer stamped in the ware.

e. **Sizes.**—Must conform to the spacings given in the following table:

Voltage	Distance from Wire to Surface.	Distance between Wires.
0-300	$\frac{1}{2}$ inch.	$2\frac{1}{2}$ inches.

This rule will not be interpreted to forbid the placing of the neutral of an Edison three-wire system in the center of the three-wire cleat where the difference of potential between the outside wires is not over 300 volts, provided the outside wires are separated two and one-half inches.

50C. Flexible Tubing.

(See Figure 154.)

a. Must have a sufficiently smooth interior surface to allow the ready introduction of the wire.

b. Must be constructed of or treated with materials which will serve as moisture repellents.

c. The tube must be so designed that it will withstand all the abrasion likely to be met with in practice.

d. The linings, if any, must not be removable in lengths of over three feet.

e. The 1-4 inch tube must be so flexible that it will not crack or break when bent in a circle with 6-inch radius at 50 degrees Fahrenheit (10 degrees Centigrade), and the covering must be thoroughly saturated with a dense moisture-



Figure 154.

proof compound which will not slide at 150 degrees Fahrenheit (65 degrees Centigrade). Other sizes must be as well made.

f. Must not convey fire on the application of a flame from Bunsen burner to the exterior of the tube when held in a vertical position.

g. Must be sufficiently tough and tenacious to withstand severe tension without injury; the interior diameter must not be diminished or the tube opened up at any point by the application of a reasonable stretching force.

h. Must not close to prevent the insertion of the wire after the tube has been kinked or flattened and straightened out.

51. Switches.

(For installation rules, see Nos. 17 and 22.)

General Rules.

a. Must, when used for service switches, indicate, on inspection, whether the current be "on" or "off."

b. Must, for constant-current systems, close the main circuit and disconnect the branch wires when turned "off"; must be so constructed that they shall be automatic in action, not stopping between points when started, and must prevent an arc between the points under all circumstances. They must indicate whether the current be "on" or "off."

Knife Switches.

(See Figure 155.)

Knife switches must be made to comply with the following specifications, except in those few cases where peculiar design allows the switch to fulfill the general requirements in some other way, and where it can successfully withstand the test of Section *i*. In such cases, the switch should be submitted for special examination before being used.

c. **Base.**—Must be mounted on non-combustible, non-absorptive insulating bases, such as slate or porcelain. Bases with an area of over twenty-five square inches must have at least four supporting screws. Holes for the supporting screws must be so located or countersunk that there will be at least one-half inch space, measured over the surface, between the head of the screw or washer and the nearest live metal part, and in all cases when between parts of opposite polarity must be countersunk.

d. **Mounting.**—Pieces carrying the contact jaws and hinge clips must be secured to the base by at least two screws, or else made with a square shoulder or provided with dowelpins, to prevent possible turnings, and the nuts or screw heads on the under side of the base must be countersunk not less than one-eighth

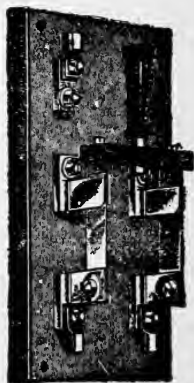

Fig. 155.

inch and covered with a waterproof compound which will not melt below 150 degrees Fahrenheit.

e. Hinges.—Hinges of knife switches must not be used to carry current unless they are equipped with spring washers, held by lock-nuts or pins, or their equivalent, so arranged that a firm and secure connection will be maintained at all positions of the switch blades.

Spring washers must be of sufficient strength to take up any wear in the hinge and maintain a good contact at all times.

f. Metal.—All switches must have ample metal for stiffness and to prevent rise in temperature of any part of over fifty degrees Fahrenheit at full load, the contacts being arranged so that a thoroughly good bearing at every point is obtained with contact surfaces advised for pure copper blades of about one square inch for each seventy-five amperes; the whole device must be mechanically well made throughout.

g. Cross-Bars.—All cross-bars less than three inches in length must be made of insulating material. Bars of three inches and over, which are made of metal, to insure greater mechanical strength, must be sufficiently separated from the jaws of the switch to prevent arcs following from the contacts to the bar on the opening of the switch under any circumstances. Metal bars should preferably be covered with insulating material.

To prevent possible turning or twisting the cross-bar must be secured to each blade by two screws, or the joints made with square shoulders or provided with dowel-pins.

h. Connections.—Switches for currents of over thirty amperes must be equipped with lugs, firmly screwed or bolted to the switch, and into which the conducting wires shall be soldered. For the smaller sized switches simple clamps can be employed, provided they are heavy enough to stand considerable hard usage.

Where lugs are not provided, a rugged double V groove clamp is advised. A set screw gives a contact at only one point, is more likely to become loosened, and is almost sure to cut into the wire. For the smaller sizes, a screw and washer connection with turned-up lugs on the switch terminal gives a satisfactory contact.

i. Test.—Must operate successfully at 50 per cent overload in amperes and 25 per cent excess voltage, under the most severe conditions with which they are liable to meet in practice.

This test is designed to give a reasonable margin between the ordinary rating of the switch and the breaking-down point, thus securing a switch which can always safely handle its normal load. Moreover, there is enough leeway so that a moderate amount of overloading would not injure the switch.

j. Marking.—Must be plainly marked where it will be visible, when the switch is installed, with the name of the maker and the current and voltage for which the switch is designed.

Switches designed for use on Edison three-wire systems must be marked with both voltages, that is the voltage between the outside wires and the neutral, and also that between the outside wires, followed by the ampere rating and the words "three wire." (For example, "125-250 v. 30 a, three-wire.")

k. Spacings.—Spacings must be at least as great as those given in the following table. The spacings specified are correct for switches to be used on direct-current systems, and can therefore be safely followed in devices designed for alternating currents.

125 volts or less:

Minimum Separation of Nearest Metal Parts of Opposite Polarity. Minimum Break-Distance.

For Switchboards and Panel Boards—

10 amperes or less.....	$\frac{3}{4}$ inch.	$\frac{1}{2}$ inch.
11-30 amperes	1 "	$\frac{3}{4}$ "
31-50 amperes	$1\frac{1}{4}$ "	1 "

For individual Switches—

10 amperes or less.....	1 inch.	$\frac{3}{4}$ inch.
11-30 "	$1\frac{1}{4}$ "	1 "
31-100 "	$1\frac{1}{2}$ "	$1\frac{1}{4}$ "
101-300 "	$2\frac{1}{4}$ "	2 "
301-600 "	$2\frac{3}{4}$ "	$2\frac{1}{2}$ "
601-1000 "	3 "	$2\frac{3}{4}$ "

126 to 250 volts:

For all Switches—

10 amperes or less.....	$1\frac{1}{2}$ inch.	$1\frac{1}{4}$ inch.
11-30 amperes	$1\frac{3}{4}$ "	$1\frac{1}{2}$ "
31-100 "	$2\frac{1}{4}$ "	2 "
101-300 "	$2\frac{1}{2}$ "	$2\frac{1}{4}$ "
301-600 "	$2\frac{3}{4}$ "	$2\frac{1}{2}$ "
601-1000 "	3 "	$2\frac{3}{4}$ "

For 100 ampere switches and larger, the above spacings for 250 volts direct current are also approved for 500 volts alternating current. Switches with these spacings intended for use on alternating-current systems with voltage above 250 volts must be stamped "250-volt D. C.," followed by the alternating current voltage for which they are designed, and the letters "A. C."

For all Switches—

10 amperes or less.....	3½ inch.	3 inch.
11-35 amperes	4 "	3½ "
36-100 "	4½ "	4 "

Auxiliary breaks or the equivalent are recommended for switches designed for over 300 volts and less than 100 amperes, and will be required on switches designed for use in breaking currents greater than 100 amperes at a pressure of more than 300 volts.

For three-wire Edison systems the separations and break distances for plain three-pole knife switches must not be less than those required in the above table for switches designed for the voltage between the neutral and outside wires.

Snap Switches.

(See Figures 156 and 157.)

Flush, push-button, door, fixture, and other snap switches used on constant-potential systems, must be constructed in accordance with the following specifications.

1. **Base.**—Current-carrying parts must be mounted on non-combustible, non-absorptive insulating bases, such as slate

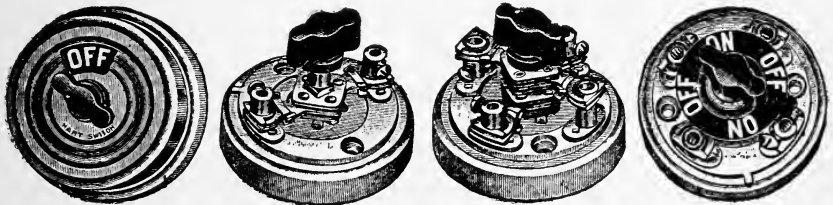

Figure 156.

or porcelain, and the holes for supporting screws should be countersunk not less than one-eighth of an inch. There must in no case be less than three sixty-fourths of an inch space between supporting screws and current-carrying parts.

Sub-bases of non-combustible, non-absorptive insulating

material, which will separate the wires at least one-half of an inch from the surface wired over, must be furnished with all snap switches used in exposed or moulding work.

m. **Mounting.**—Pieces carrying contact jaws must be secured to the base by at least two screws, or else made with a square shoulder, or provided with dowel-pins or otherwise arranged, to prevent possible turnings; and the nuts or screw heads on the under side of the base must be countersunk not less than one-eighth inch, and covered with a waterproof compound which will not melt below 150 degrees Fahrenheit.

n. **Metal.**—All switches must have ample metal for stiffness and to prevent rise in temperature of any part of over

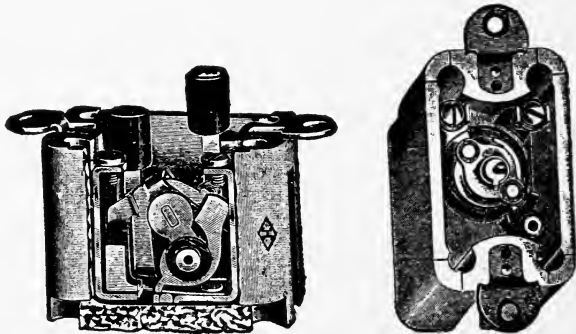

Figure 157.

50 degrees Fahrenheit at full load, the contacts being arranged so that a thoroughly good bearing at every point is obtained. The whole device must be mechanically well made throughout.

In order to meet the above requirements on temperature rise without causing excessive friction and wear on current-carrying parts, contact surfaces of from 0.1 to 0.15 square inch for each 10 amperes will be required, depending upon the metal used and the form of construction adopted.

o. **Insulating Material.**—Any material used for insulating current-carrying parts must retain its insulating and mechanical strength when subject to continued use, and must not soften at a temperature of 212 degrees Fahrenheit. It must also be non-absorptive.

p. **Binding Posts.**—Binding posts must be substantially

made, and the screws must be of such size that the threads will not strip when set up tight.

A set-screw is likely to become loosened and is almost sure to cut into the wire. A binding screw, under the head of which the wire may be clamped, and a terminal plate provided with upturned lugs or some other equivalent arrangement, afford reliable contact. After July 1, 1908, switches with the set-screw form of contact will not be approved.

q. **Covers.**—Covers made of conducting material, except face plates for flush switches, must be lined on sides and top with insulating, tough and tenacious material at least one-thirty-second inch in thickness, firmly secured so that it will not fall out with ordinary handling. The side lining must extend slightly beyond the lower edge of the cover.

r. **Handle or Button.**—The handle or button or any exposed parts must not be in electrical connection with the circuit.

s. **Test.**—Must “make” and “break” with a quick snap, and must not stop when motion has once been imparted by the button or handle.

Must operate successfully at 50 per cent over-load in amperes and at 125 volt direct current, for all 125 volt or less switches, and at 250 volts direct current, for all 126 to 250 volt switches under the most severe conditions which they are liable to meet in practice.

When slowly turned “on and off” at the rate of about two or three times per minute, while carrying the rated current at rated voltage, must “make and break” the circuit six thousand times before failing.

t. **Marking.**—Must be plainly marked, where it may be readily seen after the device is installed, with the name or trade mark of the maker and the current and voltage for which the switch is designed.

On flush switches these markings may be placed on the back of the face plate or on the sub-plate. On other types they must be placed on the *front* of the cap, cover, or plate.

Switches which indicate whether the current is “on” or “off” are recommended.

52. Cut-Outs and Circuit-Breakers.

(See Figure 158.)

(For installation rules, see Nos. 17 and 21.)

These requirements do not apply to rosettes, attachment plugs, car lighting cut-outs and protective devices for signaling systems.

General Rules.

a. Must be supported on bases of non-combustible, non-absorptive insulating material.

b. Cut-outs must be of plug or cartridge type, when not arranged in *approved* cabinets, so as to obviate any danger of the melted fuse metal coming in contact with any substance which might be ignited thereby.

c. Cut-outs must operate successfully on short-circuits, under the most severe conditions with which they are liable to

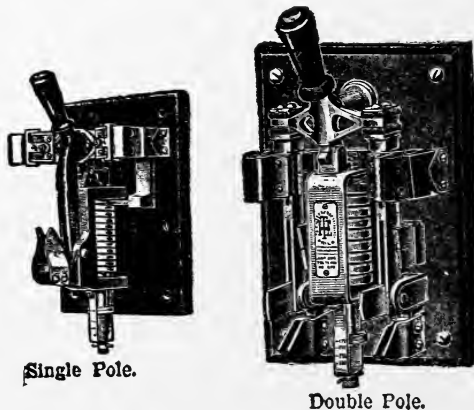

Figure 158.

meet in practice, at 25 per cent above their rate of voltage and the fuses rated at 50 per cent above the current for which the cut-out is designed, and for enclosed fuse cut-outs with the largest fuses for which the cut-out is designed.

With link fuse cut-outs there is always the possibility of a larger fuse being put into the cut-out than it was designed

for, which is not true of enclosed fuse cut-outs classified as required under No. 52 q. Again, the voltage in most plants can, under some conditions, rise considerably above the normal. The need of some margin, as a factor of safety to prevent the cut-outs from being ruined in ordinary service, is therefore evident.

The most severe service which can be required of a cut-out in practice is to open a "dead short-circuit" with only one fuse blowing, and it is with these conditions that all tests should be made. (See Section j.)

d. Circuit-breakers must operate successfully on short-circuits, under the most severe conditions with which they are liable to meet in practice, at 25 per cent above their rated voltage and with the circuit-breaker set at the highest possible opening point.

For the same reason as in Section c.

e. Must be plainly marked where it will always be visible, with the name of the maker, and current and voltage for which the device is designed.

Link-Fuse Cut-Outs.

(See Figure 159.)

(Cut-outs of porcelain are not approved for link fuses.)

The following rules are intended to cover open link fuses mounted on slate or marble bases, including switchboards, tablet-boards, and single fuse-blocks. They do not apply to fuses mounted on porcelain bases, to the ordinary porcelain cut-out blocks, enclosed fuses, or any special or covered type of fuse. When tablet-boards or single fuse-blocks with such open link fuses on them are used in general wiring, they must be enclosed in cabinet boxes made to meet the requirements of No. 54. This is necessary, because a severe flash may occur when such fuses melt, so that they would be dangerous if exposed in the neighborhood of any combustible material.

f. **Base.**—Must be mounted on slate or marble bases. Bases with an area of over twenty-five square inches must have at least four supporting screws. Holes for supporting screws must be kept outside of the area included by the outside edges of the fuse-block terminals and must be so located or countersunk that there will be at least one-half an inch space, measured over the surface, between the head of the screw or washer and the nearest live part.

g. **Mounting.**—Nuts or screw-heads on the under side

of the base must be countersunk not less than one-eighth inch, and covered with a waterproof compound which will not melt below 150 degrees Fahrenheit.

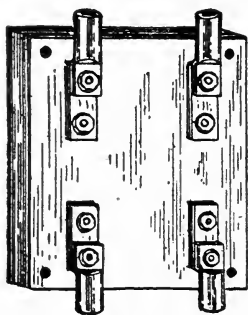

Figure 159

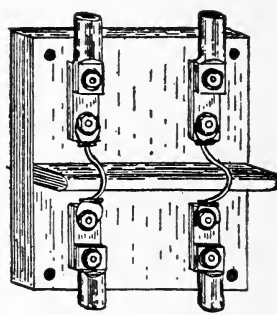

Figure 160.

h. Metal.—All fuse-block terminals must have ample metal for stiffness and to prevent rise in temperature of any part of over 50 degrees Fahrenheit at full load. Terminals, as far as practicable, should be made of compact form instead of being rolled out in thin strips; and sharp edges or thin projecting pieces as on winged thumb nuts and the like should be avoided. Thin metal, sharp edges and projecting pieces are much more likely to cause an arc to start than a more solid mass of metal. It is a good plan to round all corners of the terminals and to chamfer the edges.

i. Connections.—Clamps for connecting the wires to the fuse-block terminals must be of solid, rugged construction, so as to insure a thoroughly good connection and to withstand considerable hard usage. For fuses rated at over thirty amperes tugs firmly screwed or bolted to the terminals and into which the conducting wires are soldered must be used.

See note under No. 51 h.

j. Test.—Must operate successfully when blowing only one fuse at a time on short-circuits with fuses rated at 50 per cent above and with a voltage 25 per cent above the current and voltage for which the cut-out is designed.

k. Marking.—Must be plainly marked, where it will be

visible when the cut-off block is installed, with the name of the maker and the current and the voltage for which the block is designed.

l. **Spacings.**—Spacings must be at least as great as those given in the following table, which applies only to plain, open link-fuses mounted on slate or marble bases. The spacings given are correct for fuse-blocks to be used on direct-current systems, and can therefore be safely followed in devices designed for alternating currents. If the copper fuse-tips overhang the edges of the fuse-block terminals, the spacings should be measured between the nearest edges of the tips.

	Minimum Separation of Nearest Metal Parts of Opposite Polarity.	Minimum Break- Distance.
125 volts or less:		
10 amperes or less.....	$\frac{3}{4}$ inch.	$\frac{3}{4}$ inch.
11-100 amperes	1 " "	$\frac{3}{4}$ " "
101-103 "	1 " "	1 " "
301-1000 "	$1\frac{1}{4}$ " "	$1\frac{1}{4}$ " "
126 to 250 volts:		
10 amperes or less.....	$1\frac{1}{2}$ inch.	$1\frac{1}{4}$ inch.
11-100 amperes	$1\frac{3}{4}$ " "	$1\frac{1}{4}$ " "
101-300 "	2 " "	$1\frac{1}{2}$ " "
301-1000 "	$2\frac{1}{2}$ " "	2 " "

A space must be maintained between fuse terminals of the same polarity of at least one-half inch for voltages up to 125 and of at least three-quarter inch for voltages from 126 to 250. This is the minimum distance allowable, and greater separation should be provided when practicable.

For 250 volt boards or blocks with the ordinary front-connected terminals, except where these have a mass of compact form, equivalent to the back-connected terminals usually found in switchboard work, a substantial barrier of insulating material, not less than one-eighth of an inch in thickness, must be placed in the "break-gap"—this barrier to extend out from the base at least one-eighth of an inch farther than any bare live part of the fuse-block terminal, including binding screws, nuts and the like. (Figure 160.)

For three-wire systems cut-outs must have the break-distance required for circuits of the potential of the outside wires.

Enclosed-Fuse Cut-Outs—Plug and Cartridge Type.

(See Figure 161.)

m. **Base.**—Must be made of non-combustible, non-absorptive insulating material. Blocks with an area of over

twenty-five square inches must have at least four supporting screws. Holes for supporting screws must be so located or countersunk that there will be at least one-half of an inch space, measured over the surface, between the screw-head or washer and the nearest live metal part, and in all cases when between parts of opposite polarity must be countersunk.

n. **Mountings.**—Nuts or screw-heads on the under side of the base must be countersunk at least one-eighth of an inch and covered with a waterproof compound which will not melt below 150 degrees Fahrenheit.

o. **Terminals.**—Terminals must be of either the Edison plug, spring clip or knife blade type, of *approved* design, to take the corresponding standard enclosed fuses. They must be secured to the base by two screws or the equivalent, so as to prevent them from turning, and must be so made as to secure a thoroughly good contact with the fuse. End stops



Figure 161.

must be provided to insure the proper location of the cartridge fuse in the cut-out.

p. **Connections.**—Clamps for connecting wires to the terminals must be of a design which will insure a thoroughly good connection, and must be sufficiently strong and heavy to withstand considerable hard usage. For fuses rated to carry over thirty amperes, lugs firmly screwed or bolted to the terminals and into which the connecting wires shall be soldered must be used.

q. **Classification.**—Must be classified as regards both current and voltage as given in the following table, and must be so designed that the bases of one class cannot be used with fuses of another class rated for a higher current or voltage.

0-250 VOLTS.	251-600 VOLTS.
0- 30 amperes.	0- 30 amperes.
31- 60 "	31- 60 "
61-100 "	61-100 "
101-200 "	101-200 "
201-400 "	201-400 "
401-600 "	"

r. Design.—Must be of such a design that it will not be easy to form accidental short-circuits across live metal parts of opposite polarity on the block or on the fuses in the block.

s. Marking.—Must be marked, where it will be plainly visible when the block is installed, with the name of the maker and the voltage and range of current for which it is designed.

53. Fuses.

(For installation rules, see Nos. 17 and 21.)

Link Fuses.

a. Terminals.—Must have contact surfaces or tips of harder metal, having perfect electrical connections with the fusible part of the strip.

The use of the hard metal tip is to afford a strong mechanical bearing for the screws, clamps, or other devices provided for holding the fuse.

b. Rating.—Must be stamped with about 80 per cent of the maximum current which they can carry indefinitely, thus allowing about 25 per cent overload before the fuse melts.

With naked open fuses, of ordinary shapes and with not over 500 amperes capacity, the minimum current which will melt them in about five minutes may be safely taken as the melting point, as the fuse practically reaches its maximum temperature in this time. With larger fuses a longer time is necessary. This data are given to facilitate testing.

c. Marking.—Fuse terminals must be stamped with the maker's name or initials, or with some known trade mark.

Enclosed Fuses—Plug and Cartridge Type.

(See Figure 161.)

These requirements do not apply to fuses for rosettes, attachment plugs, car lighting, cut-outs and protective devices for signaling systems.

d. Construction.—The fuse plug or cartridge must be sufficiently dust-tight so that lint and dust cannot collect around the fusible wire and become ignited when the fuse is blown.

The fusible wire must be attached to the plug or cartridge terminals in such a way as to secure a thoroughly good connection and to make it difficult for it to be replaced when melted.

e. Classification.—Must be classified to correspond with the different classes of cut-out blocks, and must be so designed that it will be impossible to put any fuse of a given class into a cut-out block which is designed for a current or voltage lower than that of the class to which the fuse belongs.

f. Terminals.—The fuse terminals must be sufficiently heavy to ensure mechanical strength and rigidity.

The styles of terminals must be as follows:

0-250 Volts.

0-30 Amps.	$\left. \begin{array}{l} A \\ B \end{array} \right\}$	$\left. \begin{array}{l} \text{Cartridge fuse} \\ \text{(ferrule contact)} \end{array} \right\}$	$\left. \begin{array}{l} \text{to} \\ \text{fit} \end{array} \right\}$	$\left. \begin{array}{l} a, \text{ spring clip} \\ \text{terminals.} \\ b, \text{ Edison} \\ \text{plug casings.} \end{array} \right\}$	
					Approved plugs for Edison cut-outs.
31-60 "	$\left. \begin{array}{l} \\ \end{array} \right\}$	$\left. \begin{array}{l} \text{Cartridge fuse} \\ \text{(ferrule contact)} \end{array} \right\}$	$\left. \begin{array}{l} \text{to} \\ \text{fit} \end{array} \right\}$	$\left. \begin{array}{l} a, \text{ spring clip} \\ \text{terminals.} \\ b, \text{ Edison plug} \\ \text{casings.} \end{array} \right\}$	
61-100 "	$\left. \begin{array}{l} \\ \\ \\ \end{array} \right\}$	$\left. \begin{array}{l} \text{Cartridge fuse} \\ \text{(knife blade contact).} \end{array} \right\}$	$\left. \begin{array}{l} \text{to} \\ \text{fit} \end{array} \right\}$	$\left. \begin{array}{l} a, \text{ spring clip} \\ \text{terminals.} \\ b, \text{ Edison plug} \\ \text{casings.} \end{array} \right\}$	
101-200 "					
201-400 "					
400-600 "					

251-600 Volts.

0-30 Amps.	$\left. \begin{array}{l} \\ \end{array} \right\}$	$\left. \begin{array}{l} \text{Cartridge fuse} \\ \text{(ferrule contact).} \end{array} \right\}$	
31-60 "			
61-100 "	$\left. \begin{array}{l} \\ \\ \\ \end{array} \right\}$	$\left. \begin{array}{l} \text{Cartridge fuse} \\ \text{(knife contact).} \end{array} \right\}$	
101-200 "			
201-400 "			

g. Dimensions.—Cartridge enclosed fuses and corresponding cut-out blocks must conform to the dimensions given in the table attached.

h. Rating.—Fuses must be so constructed that with the surrounding atmosphere at a temperature of 75 degrees Fahrenheit (24 degrees Centigrade) they will carry indefinitely a current 10 per cent greater than that at which they are rated and at a current 25 per cent greater than the rating they will open the circuit without reaching a temperature which will injure the fuse tube or terminals of the fuse block. With a current 50 per cent greater than the rating and at room temperature of 75 degrees Fahrenheit (24 degrees Centigrade), the fuses starting cold, must blow within the time specified below :

0- 30 amperes,	30 seconds.
31- 60 "	1 minute.
61-100 "	2 minutes.
101-200 "	4 "
201-400 "	8 "
401-600 "	10 "

i. Marking.—Must be marked, where it will be plainly visible, with the name or trade-mark of the maker, the voltage and current for which the fuse is designed, and the words "National Electrical Code Standard." Each fuse must have a label, the color of which must be green for 250-volt fuses and red for 600-volt fuses.

It will be satisfactory to abbreviate the above designation to "N. E. Code St'd" where space is necessarily limited.

j. Temperature Rise.—The temperature of the exterior of the fuse enclosure must not rise more than 125 degrees Fahrenheit (70 degrees Centigrade) above that of the surrounding air when the fuse is carrying the current for which it is rated.

k. Test.—Must not hold an arc or throw out melted metal or sufficient flame to ignite easily inflammable material on or near the cut-out when only one fuse is blown at a time on a short circuit on a system of the voltage for which the fuse is rated.

The normal capacity of the system must be in excess of the load on it just previous to the test by at least five times the rated capacity of the fuse under test.

The resistance of the circuit up to the cut-out terminals must be such that the impressed voltage at the terminals will be decreased not more than 1 per cent when a current of 100 amperes is passed between them.

TABLE OF DIMENSIONS OF THE
STANDARD CARTRIDGE

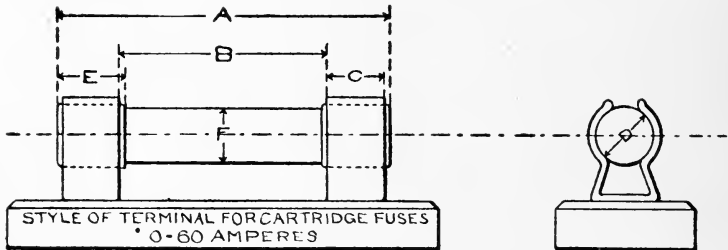

Form 1. **CARTRIDGE FUSE**—Ferrule Contact.

Voltage.	Rated Capacity. Amperes.	A	B	C
		Length over Terminals. Inches.	Distance between Contact Clips Inches.	Width of Contact Clips. Inches.
0-250	0-30	Form 1 2	1	$\frac{1}{2}$
	31-60	Form 1 3	$1\frac{3}{4}$	$\frac{5}{8}$
	61-100	Form 2 $5\frac{7}{8}$	4	$\frac{3}{8}$
	101-200	$7\frac{1}{8}$	$4\frac{1}{2}$	$1\frac{1}{4}$
	201-400	$8\frac{5}{8}$	5	$1\frac{3}{4}$
	401-600	$10\frac{3}{8}$	6	$2\frac{1}{8}$
251-600	0-30	Form 1 5	4	$\frac{1}{2}$
	31-60	Form 1 $5\frac{1}{2}$	$4\frac{1}{2}$	$\frac{5}{8}$
	61-100	Form 2 $7\frac{7}{8}$	6	$\frac{3}{8}$
	101-200	$9\frac{5}{8}$	7	$1\frac{1}{4}$
	201-400	$11\frac{1}{8}$	8	$1\frac{3}{4}$

NATIONAL ELECTRICAL CODE
ENCLOSED FUSE

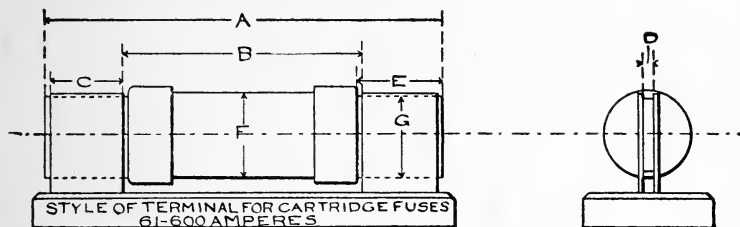

Form 2. **CARTRIDGE FUSE**—Knife Blade Contact.

D	E	F	G	Rated Capacity. Amperes.
Diameter of Ferrules or Thickness of Terminal Blades. Inches.	Min. Length of Ferrules or of Terminal Blades outside of Tube. Inches.	Dia. of Tube. Inches.	Width of Terminal Blades. Inches.	
$\frac{9}{16}$ $\frac{13}{16}$	$\frac{1}{2}$ $\frac{5}{8}$	$\frac{1}{2}$ $\frac{3}{4}$	Form 1	0-30 31-60
$\frac{1}{8}$ $\frac{3}{16}$ $\frac{1}{4}$ $\frac{1}{4}$	1 $1\frac{3}{8}$ $1\frac{1}{8}$ $2\frac{1}{4}$	1 $1\frac{1}{2}$ 2 $2\frac{1}{2}$	$\frac{3}{4}$ $1\frac{1}{8}$ $1\frac{5}{8}$ 2 Form 2	61-100 101-200 201-400 401-600
$\frac{13}{16}$ $1\frac{1}{16}$	$\frac{1}{2}$ $\frac{5}{8}$	$\frac{3}{4}$ 1	Form 1	0-30 31-60
$\frac{1}{8}$ $\frac{3}{16}$ $\frac{1}{4}$	1 $1\frac{3}{8}$ $1\frac{1}{8}$	$1\frac{1}{4}$ $1\frac{3}{4}$ $2\frac{1}{2}$	$\frac{3}{4}$ $1\frac{1}{8}$ $1\frac{5}{8}$ Form 2	61-100 101-200 201-400

For convenience a current of different value may be used, in which case the per cent drop in voltage allowable would vary in direct proportion to the difference in current used.

The above requirement regarding the capacity of the testing circuit is to guard against making the test on a system

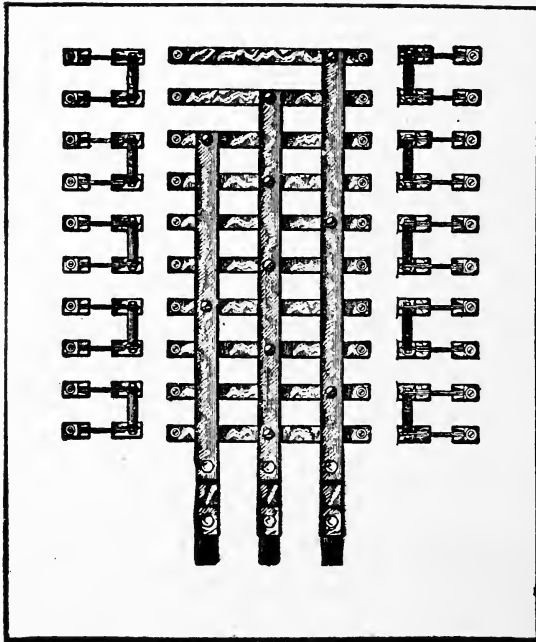

Three-Wire Mains

Figure 162.

of so small capacity that the conditions would be sufficiently favorable to allow really poor fuses to stand the test acceptably. On the other hand, it must be remembered that if the test is made on a system of very large capacity, and especially if there is but little resistance between the generators and fuse, the conditions may be more severe than are liable to be met with in practice outside of the large power stations, the result being that fuses entirely safe for general use may be rejected if such test is insisted upon.

53A. Tablet and Panel Boards.

(See Figure 162.)

The following minimum distance between bare live metal parts (bus-bars, etc.) must be maintained:

Between parts of opposite polarity except at switches and link fuses.		Between parts of same polarity.
When mounted on the same surface.	When held free in the air.	At link fuses.
0-125 volts $\frac{3}{4}$ inch.	$\frac{1}{2}$ inch.	$\frac{1}{2}$ inch.
126-250 volts $1\frac{1}{4}$ inch.	$\frac{3}{4}$ inch.	$\frac{3}{4}$ inch.

At switches or enclosed fuses, parts of the same polarity may be placed as close together as convenience in handling will allow.

It should be noted that the above distances are the minimum allowable, and it is urged that greater distances be adopted wherever the conditions will permit.

The spacings given in the first column apply to the branch conductors where enclosed fuses are used. Where link fuses or knife switches are used, the spacings must be at least as great as those required by Nos. 51 and 52.

The spacings given in the second column apply to the distance between the raised main bars and between these bars and the branch bars over which they pass.

The spacings given in the third column are intended to prevent the melting of a link fuse by the blowing of an adjacent fuse of the same polarity.

54. Cut-Out Cabinets.

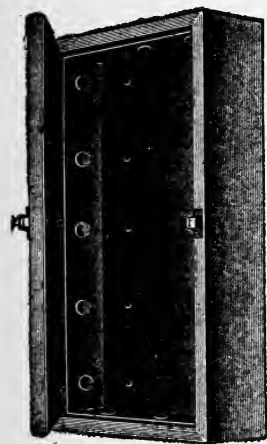

Fig. 163.

a. **Material.**—Cabinets must be substantially constructed of non-combustible, non-absorptive material, or of wood. When wood is used the inside of the cabinet must be completely lined with a non-combustible insulating material. Slate or marble at least one-quarter inch in thickness is strongly recommended for such lining, but, except with metal conduit systems, asbestos board at least one-eighth inch in thickness may be used in dry places if firmly secured by shellac and tacks.

With metal conduit systems the lining of either the box or the gutter must be one-sixteenth inch galvanized, painted or enameled steel, or, preferably, one-quarter inch slate or marble. (Figure 163.)

The object of the lining of such cut-out cabinets or gutters is to render the same approximately fireproof in case of short circuit after the wires leave the protecting metal conduits.

Two thicknesses of 1-32 inch steel may be used instead of one of 1-16 inch.

With wood cabinets the wood should be thoroughly filled and painted before the lining is put in place.

b. Door.—The door must close against a rabbet, so as to be perfectly dust-tight. Strong hinges and a strong hook or catch are required. Glass doors must be glazed with heavy glass, not less than $\frac{1}{8}$ inch in thickness, and panes should not exceed 300 square inches in area. A space of at least two inches must be allowed between the fuses and the door. This is necessary to prevent cracking or breaking by the severe blow and intense heat which may be produced under some conditions.

A cabinet is of little use unless the door is kept tightly closed, and especial attention is therefore called to the importance of having a strong and reliable catch or other fastening. A spring catch is advised if a good one can be obtained, but most of those sold for use on cupboards, etc., are so small that they fail to catch when the door shrinks a little, or are so weak that they soon give out.

It is advised that the bottoms of cabinets be given a decided slant to prevent their use as a shelf, as well as the accumulation of dust, etc.

c. Bushings.—Bushings through which wires enter must fit tightly the holes in the box, and must be of approved construction. The wires should completely fill the holes in the bushings, using tape to build up the wire, if necessary, so as to keep out the dust.

Rule 54A. Rosettes.

(See Figure 164.)

Ceiling rosettes, both fused and fuseless, must be constructed in accordance with the following specifications:

a. Base.—Current-carrying parts must be mounted on non-combustible, non-absorptive insulating bases. There should be no openings through the rosette base except those for the supporting screws and in the concealed type for the conductors also, and these openings should not be made any larger than necessary.

There must be at least one-quarter inch space, measured

over the surface, between supporting screws and current-carrying parts. The supporting screws must be so located or countersunk that the flexible cord cannot come in contact with them.

Bases for the knob and cleat type must have at least two holes for supporting screws; must be high enough to keep the wires and terminals at least one-half inch from the surface



Figure 164.

to which the rosette is attached, and must have a porcelain lug under each terminal to prevent the rosette from being placed over projections which would reduce the separation to less than one-half inch.

Bases for the moulding and conduit box types must be high enough to keep the wires and terminals at least three-eighths inch from the surface wired over.

b. Mounting.—Contact pieces and terminals must be secured in position by at least two screws, or made with a square shoulder, or otherwise arranged to prevent turning.

The nuts or screw heads on the under side of the base must be countersunk not less than one-eighth inch and covered with a waterproof compound which will not melt below 150 degrees Fahrenheit.

c. Terminals.—Line terminal plates must be at least .07 inch in thickness, and terminal screws must not be smaller than No. 6 standard screws with about 32 threads per inch.

Terminal plates for the flexible cord and for fuses must be at least .06 inch in thickness. The connection to these plates shall be by binding screws not smaller than No. 5

standard screw with about 40 threads per inch. At all binding screws for line wires and for flexible cord, up-turned lugs, or some equivalent arrangement, must be provided which will secure the wires being held under the screw heads.

d. Cord Inlet.—The diameter of the cord inlet hole should measure $13/32$ inch in order that standard portable cord may be used.

e. Knot Space.—Ample space must be provided for a substantial knot tied in the cord as a whole.

All parts of the rosette upon which the knot is likely to bear must be smooth and well rounded.

f. Cover.—When the rosette is made in two parts the cover must be secured to the base so that it will not work loose.

In fused rosettes, the cover must fit closely over the base so as to prevent the accumulation of dust or dirt on the inside, and also to prevent any flash or melted metal from being thrown out when the fuses melt.

g. Markings.—Must be plainly marked where it may readily be seen after the rosette has been installed, with the name or trade mark of the manufacturer, and the rating in amperes and volts. Fuseless rosettes may be rated 3 amperes, 250 volts; fused rosettes, with link fuses, not over 2 amperes, 125 volts.

h. Test.—Fused rosettes must have a fuse in each pole and must operate successfully when short-circuited on the voltage for which they are designed, the test being made with the two fuses in circuit.

NOTE.—When link fuses are used the test shall be made with fuse wire which melts at about 7 amperes in one inch lengths. The larger fuse is specified for the test in order to more nearly approximate the severe conditions obtained when only one 2-ampere fuse (the rating of the rosette) is blown at a time.

Fused rosettes equipped with enclosed fuses are much preferable to the link fuse rosettes.

55. Sockets.

(See Figure 165.)

(For installation rules, see No. 27.)

Sockets of all kinds, including wall receptacles, must be constructed in accordance with the following specifications:

a. Standard Sizes.—The standard lamp socket must be suitable for use on any voltage not exceeding 250 and with any size lamp up to 50 candle-power. For lamps larger than 50 candle-power a standard keyless socket may be used, or if a key is required a special socket designed for the current to be used must be made. Any special sockets must follow the general spirit of these specifications.

b. Marking.—All sockets must be marked with the manufacturer's name or trade-mark. The standard key socket must also be plainly marked 250 v. 50 c. p. Receptacles, keyless sockets and special sockets must be marked with the current and voltage for which they are designed.

c. Shell.—Metal used for shells must be moderately hard, but not hard enough to be brittle or so soft as to be

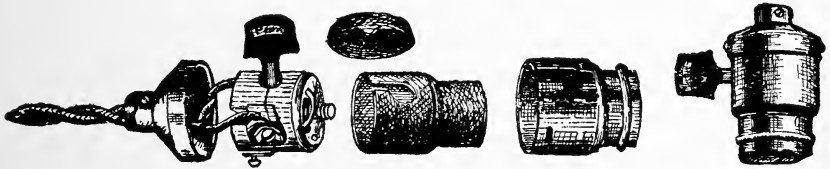

Figure 165.

easily dented or knocked out of shape. Brass shells must be at least thirteen one-thousandths of an inch in thickness, and shells of any other material must be thick enough to give the same stiffness and strength as the required thickness of brass.

d. Lining.—The inside of the shells must be lined with insulating material, which must absolutely prevent the shell from becoming a part of the circuit, even though the wires inside the socket should start from their position under the binding screws.

The material used for lining must be at least one thirty-second of an inch in thickness and must be tough and tenacious. It must not be injuriously affected by the heat from the largest lamp permitted in the socket, and must leave

water in which it is boiled practically neutral. It must be so firmly secured to the shell that it will not fall out with ordinary handling of the socket. It is preferable to have the lining in one piece.

The cap must also be lined, and this lining must comply with the requirements for shell linings.

The shell lining should extend beyond the shell far enough so that no part of the lamp base is exposed when a lamp is in the socket.

The standard Edison lamp base measures $\frac{1\frac{1}{8}}{8}$ inch, in a vertical plane from the bottom of the center contact to the upper edge of the screw shell.

In sockets and receptacles of standard forms a ring of any material inserted between an outer metal shell of the device and the inner screw shell for insulating purposes and separable from the device as a whole is considered an undesirable form of construction. This does not apply to the use of rings in lamp clusters or in devices where the outer shell is of porcelain, where such rings serve to hold the several porcelain parts together, and are thus a necessary part of the whole structure of the device.

e. Cap.—Caps, when of sheet brass, must be at least thirteen one-thousandths of an inch in thickness, and when cast or made of other metals must be of equivalent strength. The inlet piece, except for special sockets, must be tapped with a standard one-eighth-inch pipe thread. It must contain sufficient metal for a full, strong thread, and when not in one piece with the cap must be joined to it in such a way as to give the strength of a single piece.

There must be sufficient room in the cap to enable the ordinary wireman to easily and quickly make a knot in the cord and to push it into place in the cap without crowding. All parts of the cap upon which the knot is likely to bear must be smooth and well insulated.

The cap lining called for in the note to Section *d* will provide a sufficiently smooth and well-insulated surface for the knot to bear upon.

Sockets with an outlet threaded for three-eighths inch pipe will, of course, be approved where circumstances demand their use. This size outlet is necessary with most stiff pendants and for the proper use of reinforced flexible cord, as explained in the note to No. 28 *d*.

f. Frame and Screws.—The frame which holds the

moving parts must be sufficiently heavy to give ample strength and stiffness.

Brass pieces containing screw threads must be at least six one-hundredths of an inch in thickness.

Binding post screws must not be smaller than No. 5 standard screw with about 40 threads per inch.

g. Spacing.—Points of opposite polarity must everywhere be kept not less than three sixty-fourths of an inch apart, unless separated by a reliable insulation.

h. Connections.—The connecting points for the flexible cord must be made to very securely grip a No. 16 or 18 B. & S. gage conductor. A turned-up lug, arranged so that the cord may be gripped between the screw and the lug in such a way that it cannot possibly come out, is strongly advised.

i. Lamp Holder.—The socket must firmly hold the lamp in place so that it cannot be easily jarred out, and must provide a contact good enough to prevent undue heating with the maximum current allowed. The holding pieces, springs, and the like, if a part of the circuit, must not be sufficiently exposed to allow them to be brought in contact with anything outside of the lamp and socket.

j. Base.—With the exception of the lining all parts of insulating material inside the shell must be made of porcelain.

k. Key.—The socket key-handle must be of such a material that it will not soften from the heat of a fifty candle-power lamp hanging downwards from the socket in air at 70 degrees Fahrenheit, and must be securely, but not necessarily rigidly, attached to the metal spindle which it is designed to turn.

l. Sealing.—All screws in porcelain pieces, which can be firmly sealed in place, must be so sealed by a waterproof compound which will not melt below 200 degrees Fahrenheit.

m. Putting Together.—The socket as a whole must be so put together that it will not rattle to pieces. Bayonet joints or an equivalent are recommended.

n. Test.—The socket, when slowly turned "on and off" at the rate of about two or three times per minute,

while carrying a load of one ampere at 250 volts, must "make and break" the circuit 6,000 times before failing.

o. **Keyless Sockets.**—Keyless sockets of all kinds must comply with the requirements for key sockets as far as they apply.

p. **Sockets of Insulating Material.**—Sockets made of porcelain or other insulating material must conform to the above requirements as far as they apply, and all parts must be strong enough to withstand a moderate amount of hard usage without breaking.

Porcelain shell sockets being subject to breakage, and constituting a hazard when broken, will not be accepted for use in places where they would be exposed to hard usage.

q. **Inlet Bushing.**—When the socket is not attached to a fixture, the threaded inlet must be provided with a strong insulating bushing having a *smooth* hole at least nine thirty-seconds of an inch in diameter. The edges of the bushing must be rounded and all inside fins removed, so that in no place will the cord be subjected to the cutting or wearing action of a sharp edge.

Bushings for sockets having an outlet threaded for three-eighths-inch pipe should have a hole thirteen thirty-seconds of an inch in diameter, so that they will accommodate *approved* reinforced flexible cord.

56. Hanger-Boards.

(See Figure 166.)

a. Hanger-boards must be so constructed that all wires and current-carrying devices thereon will be exposed to view

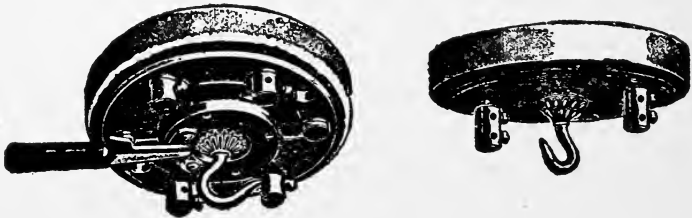

Figure 166.

and thoroughly insulated by being mounted on a non-combustible, non-absorptive insulating substance. All switches

attached to the same must be so constructed that they shall be automatic in their action, cutting off both poles to the lamp, not stopping between points when started and preventing an arc between points under all circumstances.

57. Arc Lamps.

(See Figure 167.)

(For installation rules, see Nos. 19 and 29.)

a. Must be provided with reliable stops to prevent carbons from falling out in case the lamps become loose.

b. All exposed parts must be carefully insulated from the circuit.

c. Must, for constant-current systems, be provided with an *approved* hand switch, and an automatic switch that will shunt the current around the carbons, should they fail to feed properly.

The hand switch to be approved, if placed anywhere except on the lamp itself, must comply with requirements for switches on hanger-boards as laid down in No. 56.

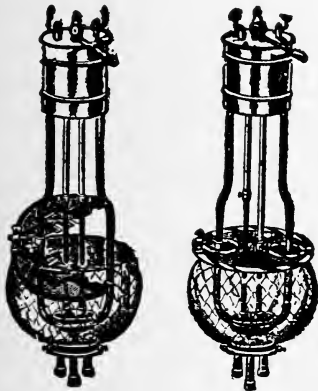

Figure 167

58. Spark Arresters.

(See Figure 167.)

(For installation rules, see Nos. 19 c and 29 c.)

a. Spark arresters must so close the upper orifice of the globe that it will be impossible for any sparks, thrown out by the carbons, to escape.

59. Insulating Joints.

(See No. 26 a.)

a. Must be entirely made of material that will resist the action of illuminating gases, and will not give way or soften under the heat of an ordinary gas flame or leak under a moderate pressure. Must be so arranged that a deposit of moisture will not destroy the insulating effect; must show a

dielectric strength between gas-pipe attachments sufficient to resist throughout five minutes the application of an electromotive force of 4,000 volts; and must be sufficiently strong to resist the strain to which they are liable to be subjected during installation.

b. Insulating joints having soft rubber in their construction will not be approved.

60. Rheostats.

(For installation rules, see Nos. 4 a and 8 c.)

a. **Materials.**—Must be made entirely of non-combustible materials, except such minor parts as handles, magnet insulation, etc.

All segments, lever arms, etc., must be mounted on non-combustible, non-absorptive insulating material.

Rheostats used in dusty or linty places or where exposed to flyings of combustible material must be so constructed that even if the resistive conductor be fused by excessive current the arc or any attendant flame will be quickly and safely extinguished. Rheostats used in places where the above conditions do not exist may be of any approved type.

b. **Construction.**—Must be so constructed that when mounted on a plane surface the casing will make contact with such surface only at the points of support. An air space of at least $\frac{1}{4}$ inch between the rheostat casing and the supporting surface will be required.

The construction throughout must be heavy, rugged and thoroughly workmanlike.

c. **Connections.**—Clamps for connecting wires to the terminals must be of a design which will ensure a thoroughly good connection, and must be sufficiently strong and heavy to withstand considerable hard usage. For currents above fifty amperes, lugs firmly screwed or bolted to the terminals, and into which the connecting wires shall be soldered, must be used.

Clamps or lugs will not be required where leads designed for soldered connections are provided.

d. **Marking.**—Must be plainly marked, where it may be readily seen after the device is installed, with the rating and the name of the maker; and the terminals of motor-starting

rheostats must be marked to indicate to what part of the circuit each is to be connected, as "line," "armature," and "field."

e. **Contacts.**—The design of the fixed and movable contacts and the resistance in each section must be such as to secure the least tendency toward arcing and roughening of the contacts, even with careless handling or the presence of dirt.

In motor-starting rheostats, the contact at which the circuit is broken by the lever arm when moving from the running to the starting position must be so designed that there will be no detrimental arcing. The final contact, if any, on which the arm is brought to rest in the starting position must have no electrical connection.

Experience has shown that sharp edges and segments of thin material help to maintain an arc, and it is recommended that these be avoided. Segments of heavy construction have a considerable cooling effect on the arc, and rounded corners tend to spread it out and thus dissipate it.

It is recommended that the circuit-breaking contacts be so constructed as to "break" with a quick snap, independently of the slowness of movement of the operator's hand, or that a magnetic blowout or equivalent device be used. For dial type rheostats the movable contact should be flexible in a plane at right angles to the plane of its movement, and for medium and larger sizes the stationary contacts should be readily renewable.

f. **No-voltage release.**—Motor-starting rheostats must be so designed that the contact arm cannot be left on intermediate segments, and must be provided with an automatic device which will interrupt the supply circuit before the speed of the motor falls to less than one-third of its normal value.

g. **Overload-release.**—Overload-release devices which are inoperative during the process of starting a motor will not be approved, unless other circuit-breakers or fuses are installed in connection with them.

If, for instance, the overload-release device simply releases the starting arm and allows it to fly back and break the circuit, it is inoperative while the arm is being moved from the starting to the running position.

h. **Test.**—Must, after 100 operations under the most severe normal conditions for which the device is designed, show no serious burning of the contacts or other faults, and

the release mechanism of motor-starting rheostats must not be impaired by such a test.

Field rheostats, or main-line regulators intended for continuous use, must not be burned out or depreciated by carrying the full normal current on any step for an indefinite period. Regulators intended for intermittent use (such as on electric cranes, elevators, etc.) must be able to carry their rated current on any step for as long a time as the character of the apparatus which they control will permit them to be used continuously.

61. Reactive Coils and Condensers.

a. Reactive coils must be made of non-combustible material, mounted on non-combustible bases and treated, in general, as sources of heat.

b. Condensers must be treated like other apparatus operating with equivalent voltage and currents. They must have non-combustible cases and supports, and must be isolated from all combustible materials and, in general, treated as sources of heat.

62. Transformers.

(For installation rules, see Nos. 11, 13, 13A and 36.)

a. Must not be placed in any but metallic or other non-combustible cases.

On account of the possible dangers from burn-outs in the coils. (See note under No. 11 a.)

It is advised that every transformer be so designed and connected that the middle point of the secondary coil can be reached if, at any future time, it should be desired to ground it.

b. Must be constructed to comply with the following tests:

1. Shall be run, for eight consecutive hours at full load in watts under conditions of service, and at the end of that time the rise in temperature, as measured by the increase of resistance of the primary coil, shall not exceed 175 degrees Fahrenheit (97 degrees Centigrade).

2. The insulation of transformers when heated shall withstand continuously for five minutes a difference of potential of 10,000 volts (alternating) between the primary and secondary coils and between the primary coils and core, and a no-load "run" at double voltage for thirty minutes.

63. Lightning Arresters.

(For installation rules, see No. 5.)

- a. Lightning arresters must be of *approved* construction. (See list of Electrical Fittings.)

CLASS E.

MISCELLANEOUS.

64. Signaling Systems.

Governing wiring for telephone, telegraph, district messenger and call-bell circuits, fire and burglar alarms, and all similar systems which are hazardous only because of their liability to become crossed with electric light, heat or power circuits.

a. Outside wires should be run in underground ducts or strung on poles, and, kept off of the roofs of buildings, except by special permission of the Inspection Department having jurisdiction, and must not be placed on the same cross-arm with electric light or power wires. They should not occupy the same duct, manhole or handhole of conduit systems with electric light or power wires.

Single manholes, or handholes, may be separated in sections by means of partitions of brick or tile so as to be considered as conforming with the above rule.

The liability of accidental crossing of overhead signaling circuits with electric light and power circuits may be guarded against to a considerable extent by endeavoring to keep the two classes of circuits on different sides of the same street.

When the entire circuit from Central Station to building is run in underground conduits, Sections b to m inclusive do not apply.

b. When outside wires are run on same pole with electric light or power wires, the distance between the two inside pins of each cross-arm must not be less than twenty-six inches.

Signaling wires being smaller and more liable to break and fall, should generally be placed on the lower cross-arms.

c. Where the wires are attached to the outside walls of buildings they must have an *approved* rubber insulating covering (see No. 41), and on frame buildings or frame portions of other buildings shall be supported on glass or porcelain insulators, or knobs.

d. The wires from last outside support to the cut-outs or

protectors must be of copper, and must have an *approved* rubber insulation (see No. 41); must be provided with drip loops immediately outside the buildings and at entrance; must be kept not less than two and one-half inches apart, except when brought in through approved metal-covered cables.

e. Wires must enter building through approved non-combustible, non-absorptive insulating bushings sloping upward from the outside.

Installations where the Current Carrying Parts of the Apparatus Installed are Capable of Carrying Indefinitely a Current of Ten Amperes.

f. An all-metallic circuit shall be provided, except in telegraph systems.

g. At the entrance of wires to buildings, *approved* single pole cut-outs, designed for 251-600 volts potential and containing fuses rated at not over ten amperes capacity, shall be provided for each wire. These cut-outs must not be placed in the immediate vicinity of easily ignitable stuff, or where exposed to inflammable gases, or dust or to flyings of combustible material.

h. The wires inside building shall be of copper not less than No. 16 B. & S. gage, and must have insulation and be supported, the same as would be required for an installation of electric light or power wiring, 0-600 volts potential.

i. The instruments shall be mounted on bases constructed of non-combustible, non-absorptive insulating material. Holes for the supporting screws must be so located, or countersunk, that there will be at least one-half inch space, measured over the surface, between the head of the screw and the nearest live metal part.

Installations where the Current Carrying Parts of the Apparatus Installed are Not Capable of Carrying Indefinitely a Current of Ten Amperes.

j. Must be provided with an approved protective device located as near as possible to the entrance of wires to building. The protector must not be placed in the immediate

vicinity of easily ignitable stuff, or where exposed to inflammable gases, or dust or flyings of combustible material.

k. Wires from entrance to building to protector must be supported on porcelain insulators, so that they will come in contact with nothing except their designed supports.

l. The ground wire of the protective device shall be run in accordance with the following requirements:

1. Shall be of copper and not smaller than No. 18 B. & S. gage.
2. Must have an *approved* insulating covering as described in No. 41, for voltages from 0 to 600, except that the preservative compound specified in No. 41, Section *h*, may be omitted.
3. Must run in as straight a line as possible to a good permanent ground. This may be obtained by connecting to a water or gas pipe connected to the street mains or to a ground rod or pipe driven in permanently damp earth. When connections are made to pipes, preference shall be given to water pipes. If attachment is made to gas pipe, the connection in all cases must be made between the meter and the street mains. In every case the connection shall be made as near as possible to the earth.

When the ground wire is attached to water or gas pipes, these pipes shall be thoroughly cleaned and tinned with resin flux solder, if such a method is practicable; the ground wire shall then be wrapped tightly around the pipe and thoroughly soldered to it.

When the above method is impracticable, then if there are fittings where a brass plug can be inserted, the ground wire shall be thoroughly soldered to it; if there are no such fittings, then the pipe shall be thoroughly cleaned and an approved ground clamp fastened to an exposed portion of the pipe and the ground wire well soldered to the ground clamp.

When the ground wire is attached to a ground rod driven into the earth, the ground wire shall be soldered to the rod in a similar manner.

Steam or hot-water pipes must not be used for a protector ground.

m. The protector to be approved must comply with the following requirements:

For Instrument Circuits of Telegraph Systems.

1. An *approved* single pole cut-out, in each wire, designed for 2,000 volts potential, and containing fuses rated at not over one ampere capacity. When main line cut-outs are installed as called for in section *g*, the instrument cut-outs may be placed between the switchboard and the instrument as near the switchboard as possible.

For All Other Systems.

1. Must be mounted on non-combustible, non-absorptive insulating bases, so designed that when the protector is in place all parts which may be alive will be thoroughly insulated from the wall to which the protector is attached.
2. Must have the following parts:
 - A lightning arrester which will operate with a difference of potential between wires of not over 500 volts, and so arranged that the chance of accidental grounding is reduced to a minimum.
 - A fuse designed to open the circuit in case the wires become crossed with light or power circuits. The fuse must be able to open the circuit without arcing or serious flashing when crossed with any ordinary commercial light or power circuit.
 - A heat coil, if the sensitiveness of the instrument demands it, which will operate before a sneak current can damage the instrument the protector is guarding.

Heat coils are necessary in all circuits normally closed through magnet windings, which cannot indefinitely carry a current of at least five amperes.

The heat coil is designed to warm up and melt out with a

current large enough to endanger the instruments if continued for a long time, but so small that it would not blow the fuses ordinarily found necessary for such instruments. The small currents are often called "sneak" currents.

3. The fuses must be so placed as to protect the arrester and heat coils, and the protector terminals must be plainly marked "line," "instrument," "ground."

An easily read abbreviation of the above words will be allowed.

The Following Rules Apply to All Systems whether the Wires from the Central Office to the Building are Overhead or Underground.

n. Wires beyond the protector, or wires inside buildings where no protector is used, must be neatly arranged and securely fastened in place in some convenient, workmanlike manner. They must not come nearer than six inches to any electric light or power wire in the building unless encased in *approved* tubing so secured as to prevent its slipping out of place.

The wires would ordinarily be insulated, but the kind of insulation is not specified, as the protector is relied upon to stop all dangerous currents. Porcelain tubing or *approved* flexible tubing may be used for encasing wires where required as above.

o. Wires where bunched together in a vertical run within any building must have a fire-resisting covering sufficient to prevent the wires from carrying fire from floor to floor unless they are run either in non-combustible tubing or in a fireproof shaft, which shaft shall be provided with fire stops at each floor.

Signaling wires and electric light or power wires may be run in the same shaft, provided that one of these classes of wires is run in non-combustible tubing, or provided that when run otherwise these two classes of wires shall be separated from each other by at least two inches.

In no case shall signaling wires be run in the same tube with electric light or power wires.

Ordinary rubber insulation is inflammable, and when a number of wires are contained in a shaft extending through a building they afford a ready means of carrying fire from floor to floor, unless they are covered with a fire-resisting

material, or unless the shaft is provided with fire stops at each floor.

65. Electric Gas Lighting.

a. Electric gas lighting must not be used on the same fixture with the electric light.

The above rule does not apply to *frictional* systems of gas lighting.

65 A. Moving Picture Machines.

a. Arc lamp used as a part of moving picture machines must be constructed similar to arc lamps of theaters and wiring of same must not be of less capacity than No. 6 B. & S. gage. (See No. 31A d. [1].)

b. Rheostats must conform to rheostat requirements for theater arcs. (See No. 31A d [1].)

c. Top reel must be encased in a steel box with hole at the bottom only large enough for film to pass through and cover so arranged that this hole can be instantly closed. No solder to be used in the construction of this box.

d. A steel box must be used for receiving the film after being shown, with a hole in the top only large enough for the film to pass through freely, with a cover so arranged that this hole can be instantly closed. An opening may be placed at the side of the box to take the film out, with a door hung at the top, so arranged that it cannot be entirely opened, and provided with spring catch to lock it closed. No solder to be used in the construction of this box.

e. The handle or crank used in operating the machine must be secured to the spindle or shaft, so that there will be no liability of its coming off and allowing the film to stop in front of lamp.

f. A shutter must be placed in front of the condenser, arranged so as to be readily closed.

g. Extra films must be kept in metal box with tight fitting cover.

h. Machines must be operated by hand (motor driven will not be permitted).

i. Picture machine must be placed in an enclosure or house made of suitable fireproof material, be thoroughly

ventilated and large enough for operator to walk freely on either side of or back of machine. All openings into this booth must be arranged so as to be entirely closed by doors or shutters constructed of the same or equally good fire-resisting material as the booth itself. Doors or covers must be arranged so as to be held normally closed by spring hinges or equivalent devices.

66. Insulation Resistance.

The wiring in any building must test free from grounds; *i. e.*, the complete installation must have an insulation between conductors and between all conductors and the ground (not including attachments, sockets, receptacles, etc.), not less than that given in the following table:

Up to	5 amperes.....	4,000,000	ohms.
"	10	"2,000,000
"	25	" 800,000
"	50	" 400,000
"	100	" 200,000
"	200	" 100,000
"	400	" 50,000
"	800	" 25,000
"	1,600	" 12,500

The test must be made with all cut-outs and safety devices in place. If the lamp sockets, receptacles, electrolliers, etc., are also connected, only one-half of the resistance specified in the table will be required.

CLASS F.

MARINE WORK.

68. Generators.

- a. Must be located in a dry place.
- b. Must have their frames insulated from their bed-plates.
- c. Must each be provided with a waterproof cover.
- d. Must each be provided with a name-plate, giving the maker's name, the capacity in volts and amperes, and the normal speed in revolutions per minute.

69. Wires.

a. Must be supported in *approved* moulding or conduit, except at switchboards and for portables.

Special permission may be given for deviation from this rule in dynamo-rooms.

b. Must have no single wire larger than No. 12 B. & S. gage. Wires to be stranded when greater carrying capacity is required. No single solid wire smaller than No. 14 B. & S. gage, except in fixture wiring, to be used.

Stranded wires must be soldered before being fastened under clamps or binding screws, and when they have a conductivity greater than that of No. 8 B. & S. gage copper wire they must be soldered into lugs.

c. Splices or taps in conductors must be avoided as far as possible. Where it is necessary to make them they must be so spliced or joined as to be both mechanically and electrically secure without solder. They must then be soldered, to insure preservation, covered with an insulating compound equal to the insulation of the wire, and further protected by a waterproof tape. The joint must then be coated or painted with a waterproof compound.

All joints must be soldered unless made with some form of *approved* splicing device.

For Moulding Work.

d. Must have an *approved* insulating covering.

The insulation for conductors, to be approved, must be at least 3-32 of an inch in thickness and be covered with a substantial waterproof braid.

The physical characteristics shall not be affected by any change in temperature up to 200 degrees Fahrenheit (93 degrees Centigrade). After two weeks' submersion in salt water at 70 degrees Fahrenheit (21 degrees Centigrade), it must show an insulation resistance of 100 megohms per mile after three minutes' electrification with 550 volts.

e. Must have, when passing through water-tight bulkheads and through all decks, a metallic stuffing tube lined with hard rubber. In case of deck tubes, they must be boxed near deck to prevent mechanical injury.

f. Must be bushed with hard rubber tubing, one-eighth of an inch in thickness, when passing through beams and non-water-tight bulkheads.

For Conduit Work.

g. Must have an *approved* insulating covering.

The insulation for conductors, for use in lined conduits, to be approved, must be at least 3-32 of an inch in thickness and be covered with a substantial waterproof braid. The physical characteristics shall not be affected by any change in temperature up to 200 degrees Fahrenheit (93 degrees Centigrade).

After two weeks' submersion in salt water at 70 degrees Fahrenheit (21 degrees Centigrade), it must show an insulation resistance of 100 megohms per mile after three minutes' electrification with 550 volts.

For unlined metal conduits, conductors must conform to the specifications given for lined conduits, and in addition have a second outer fibrous covering at least one thirty-second of an inch in thickness and sufficiently tenacious to withstand the abrasions of being hauled through the metal conduit.

h. Must not be drawn in until the mechanical work on the conduit is completed and same is in place.

i. Where run through coal bunkers, boiler rooms, and where they are exposed to severe mechanical injury, must be encased in *approved* conduit.

70. Portable Conductors.

a. Must be made of two stranded conductors each having a carrying capacity equivalent to not less than No. 14 B. & S. gage, and each covered with an *approved* insulation and covering.

Where not exposed to moisture or severe mechanical injury, each stranded conductor must have a solid insulation at least one thirty-second of an inch in thickness, and must show an insulation resistance between conductors, and between either conductor and the ground, of at least fifty megohms per mile after two weeks' submersion in water at 70 degrees Fahrenheit (21 degrees Centigrade), and be protected by a slow-burning, tough-braided outer covering.

Where exposed to moisture and mechanical injury (as for use on decks, holds and fire-rooms) each stranded conductor shall have a solid insulation, to be approved, of at least one-thirty-second of an inch in thickness and protected by a tough braid. The two conductors shall then be stranded together, using a jute filling. The whole shall then be covered with a layer of flax, either woven or braided, at least one thirty-second of an inch in thickness and treated with a non-inflammable waterproof compound. After one week's submersion in water at 70 degrees Fahrenheit (21 degrees Centigrade), it must show an insulation between the two conductors, or between either conductor and the ground, of fifty megohms per mile.

71. Bell or Other wires.

a. Must never be run in same duct with lighting or power wires.

72. Table of Capacity of Wires.

B. & S. G.	Actual Area C. M.	No. of Strands.	Strands Size of B. & S. G.	Amperes
19	1,288
18	1,624	3
17	2,048
16	2,583	6
15	3,257
14	4,107	12
12	6,530	17
..	9,016	7	19	21
..	11,368	7	18	25
..	14,336	7	17	30
..	18,081	7	16	35
..	22,799	7	15	40
..	30,856	19	18	50
..	38,912	19	17	60
..	49,077	19	16	70
..	60,088	37	18	85
..	75,776	37	17	100
..	99,064	61	18	120
..	124,928	61	17	145
..	157,563	61	16	170
..	198,677	61	15	200
..	250,527	61	14	235
..	296,387	91	15	270
..	373,737	91	14	320
..	413,639	127	15	340

When greater conducting area than that of 12 B. & S. gage is required, the conductor shall be stranded in a series of 7, 19, 37, 61, 91 or 127 wires, as may be required; the strand consisting of one central wire, the remainder laid around it concentrically, each layer to be twisted in the opposite direction from the preceding.

73. Switchboard.

a. Must be made of non-combustible, non-absorptive insulating material, such as marble or slate.

b. Must be kept free from moisture, and must be located so as to be accessible from all sides.

c. Must have a main switch, main cut-out and ammeter for each generator.

Must also have a voltmeter and ground detector.

d. Must have a cut-out and switch for each side of each current leading from board.

c. Must be wired with conductors having an insulation as required for moulding or conduit work and covered with a substantial flame-proof braid.

74. Resistance Boxes.

(For construction rules, see No. 60.)

a. Must be located on switchboard or away from combustible material. When not placed on switchboard they must be mounted on non-inflammable, non-absorptive insulating material.

75. Switches.

(For construction rules, see No. 51.)

a. When exposed to dampness, they must be enclosed in a water-tight case.

b. Must be of the knife pattern when located on switchboard.

c. Must be provided so that each freight compartment may be separately controlled.

76. Cut-Outs.

(For construction rules, see No. 52.)

a. Must be placed at every point where a change is made in the size of the wire (unless the cut-out in the larger wire will protect the smaller).

b. In such places as upper-decks, holds, cargo spaces and fire-rooms, a water-tight and fireproof cut-out may be used, connected directly to mains when such cut-out supplies circuits requiring not more than 660 watts energy.

c. When placed anywhere except on switchboards and certain places, as cargo spaces, holds, fire-rooms, etc., where it is impossible to run from center of distribution, they must be in a cabinet lined with fire-resisting material.

d. Except for motors, searchlights and diving lamps must be so placed that no group of lamps, requiring a current of more than 660 watts, shall ultimately be dependent upon one cut-out.

77. Fixtures.

a. Must be mounted on blocks made from well-seasoned lumber treated with two coats of white lead or shellac.

b. Where exposed to dampness, the lamp must be surrounded by a vapor-proof globe.

c. Where exposed to mechanical injury, the lamp must be surrounded by a globe protected by a stout wire guard.

d. Must be wired with same grade of insulation as portable conductors which are not exposed to moisture or mechanical injury.

e. Ceiling fixtures over two feet in length must be provided with stay chains.

78. Sockets.

(For construction rules, see No. 55.)

79. Wooden Mouldings.

(For construction rules, see No. 50.)

a. Where moulding is run over rivets, beams, etc., a backing strip must first be put up and the moulding secured to this.

b. Capping must be secured by brass screws.

80. Interior Conduits.

(For installation rules, see No. 25.)

(For construction rules, see No. 49.)

81. Signal Lights.

a. Must be provided with *approved* telltale board, located preferably in pilot house, which will immediately indicate a burned out lamp.

82. Motors.

a. Must be wired under the same precautions as with a current of same volume and potential for lighting. The motor and resistance box must be protected by a double-pole cut-out and controlled by a double-pole switch, except in cases where one-quarter horse power or less is used.

The motor leads or branch circuits must be designed to carry a current at least 25 per cent greater than that for which the motor is rated, in order to provide for the inevitable occasional overloading of the motor, and the increased current required in starting, without overfusing the wires, but where the wires under this rule would be overfused, in order to provide for the starting current, as in the case of many of the alternating current motors, the wires must be of such size as to be properly protected by these larger fuses.

In general, motors should preferably have no exposed live parts.

b. Must be thoroughly insulated. Where possible, should be set on base frames made from filled, hard, dry wood and raised above surrounding deck. On hoists and winches they must be insulated from bed-plates by hard rubber, fiber or similar insulating material.

c. Must be covered with a waterproof cover when not in use.

d. Must each be provided with a name-plate giving maker's name, the capacity in volts and amperes, and the normal speed in revolutions per minute.

83. Insulation Resistance.

The wiring in any vessel must test free from grounds; *i. e.*, the complete installation must have an insulation between conductors and between all conductors and the ground (not including attachments, sockets, receptacles, etc.) of not less than the following:

Up to	25 amperes	800,000 ohms.
"	50 "	400,000 "
"	100 "	200,000 "
"	200 "	100,000 "
"	400 "	50,000 "
"	800 "	25,000 "
"	1,600 "	12,500 "

All cut-outs and safety devices in place in the above.

Where lamp sockets, receptacles and electroliers, etc., are connected, one-half of the above will be required.

NEW RULES AND CHANGES IN RULES ADOPTED
IN "THE NATIONAL ELECTRICAL CODE"
FOR 1909.

In the following pages, all of the changes in rules of "The National Electrical Code" for the year 1909, are given. It is to be noted also that all of the fine print notes of the 1907 code, which were mainly in the form of suggestions, have been made mandatory and must now be considered as rules of equal standing with the rest.

CLASS A.

STATIONS AND DYNAMO ROOMS.

Fine print note on page 48, beginning "In case of a machine," is omitted.

Fine print note under section d, page 51, beginning "In general," is also omitted.

After section f, page 60, add section g reading, "The use of soft rubber bushings to protect the lead wires coming through the frames of generators is permitted, except when installed where oils, grease, oily vapors or other substances known to have rapidly deleterious effect on rubber, are present in such quantities and in such proximity with motor or dynamo as may cause such bushings to be liable to rapid destruction. In such cases hard wood properly filled, or preferably porcelain or micanite bushings must be used."

In place of fine print, note page 60 beginning, "Wires from generator to switchboard" read:

"Wires from generator to switchboard may, however, be placed in a runway in the brick or cement pier on which the

generator stands. When protection against moisture is necessary, lead-covered cable or iron conduit must be used.

In place of fine print note under rule b, read:

Where a number of wires are brought close together, as is generally the case in dynamo rooms, especially about the switchboard, they must be surrounded with a tight, non-combustible outer cover.

Flame proofing must be stripped back on all cables a sufficient amount to give the necessary insulation distances for the voltage of the circuit on which the cable is used.

Rule c, page 61, is changed to read:

Must, where not in conduit, be kept so rigidly supported that they cannot come in contact.

Fine print note page 61, beginning "Voltmeter switches having," is omitted.

In place of fine print note under a, page 62, beginning "Special attention is called," read:

"Switchboards must not be built up to the ceiling, a space of three feet being left, if possible, between the ceiling and the board. The space back of the board must be kept free of rubbish and not used for storage purposes.

In place of fine print note under c, read:

"If the wiring is on the back, there must be a clear space of at least eighteen inches between the wall and the apparatus on the board, and even if the wiring is entirely on the face, it is much better to have the board set out from the wall."

Rule a, concerning resistance boxes and equalizers page 64, also part of fine print note on page 65, is changed to read:

a. Must be placed on a switchboard, or at a distance of at least one foot from combustible material, or separated therefrom by a slab or panel of non-combustible, non-absorptive, insulating material such as slate, soapstone or marble, somewhat larger than the rheostat, which must be secured in position independently of the rheostat supports. Bolts for sup-

porting the rheostat shall be countersunk at least $\frac{1}{8}$ inch below the surface at the back of the slab and filled.

Fine print note under rule a, "Lightning arresters," is omitted.

Fine print note under b, beginning, "The switchboard does not," is also omitted.

To rule c, under lightning arresters, page 67, is added: "Ground wires for lightning arresters must not be attached to gas pipes within the building nor run in iron pipes."

Fine print note under b, page 69, "Care and attendance," is omitted.

Rule c and fine print note following under, "Testing of Insulation Resistance," are omitted.

Fine print note under motors, page 73, beginning, "The use of motors," has been changed to read:

"When motors operating at a potential in excess of 550 volts are to be installed, it is suggested that plans for such installation should be submitted to the inspection department having jurisdiction before any work is begun.

Rule c, under "Motors," page 76, and also fine print note following have been changed to read:

c. Each motor and resistance box must be protected by a cut-out and controlled by a switch (see No. 17a), said switch plainly indicating whether "on" or "off" (except as provided for electric cranes, see 34 A-c). With motors of one-fourth horsepower or less, on circuits where the voltage does not exceed 300, No. 21d must be complied with, and single pole switches may be used as allowed in No. 22c. The switch and rheostat must be located within sight of the motor, except in cases where special permission to locate them elsewhere is given, in writing, by the inspection department having jurisdiction.

Where the circuit-breaking device on the motor-starting rheostat disconnects all wires of the circuit, the switch called for in this section may be omitted.

Overload-release devices on motor-starting rheostats will not be considered to take the place of the cut-out required by this section if they are inoperative during the starting of the motor.

An automatic circuit-breaker disconnecting all wires of the circuit may, however, serve as both switch and cut-out.

Fine print note under d, page 78, has been changed to read:

Auto starters, unless equipped with tight casings enclosing all current-carrying parts, in all wet, dusty or linty places, must be enclosed in dust-tight, fireproof cabinets. Where there is any liability of short circuits across their exposed live parts being caused by accidental contacts, a railing must be erected around them.

Fine print note under f, pages 85-86, has been changed to read:

Such enclosures must be readily accessible, dust proof and sufficiently ventilated to prevent an excessive rise of temperature. Where practicable, the sides should be made largely of glass, so that the motor may be always plainly visible.

The use of enclosed type motor is recommended in dusty places, being preferable to wooden boxing.

Fine print note page 90, beginning, "If the insulation," has been omitted.

CLASS B. OUTSIDE WORK.

In rule a, page 91, make line seven read: "Support to the line, except when run in conduit, may have an approved weatherproof."

In rule b, page 91, make line two read: "connection between them, and except when run in conduit, not less than a foot apart and not."

To rule b also add: "For conduit work, wires must be

placed so as to conform to rules for unlined conduit, except that conduit system must be waterproof."

To rule c, page 92, add: "And roof structures must be substantially constructed." Omit fine print note under this rule entirely.

Rule d, page 93, is entirely stricken out.

Rule e has been changed to read:

e. Must, where exposed to the weather, be provided with petticoat insulators of glass or porcelain; porcelain knobs or cleats and rubber hooks will not be approved. Wires on the exterior walls of buildings must be supported at least every fifteen feet, the distance between supports to be shortened if wires are liable to be disturbed.

Where not exposed to the weather, low potential wires may be supported on glass or porcelain knobs which will separate the wires at least one inch from the surface wired over, supports to be placed at least every four and one-half feet.

Fine print note under rule g, page 94, has been changed to read:

For low potential systems the service wires may be brought into buildings through a single iron conduit. The conduit to be equipped with an *approved* service-head. The inner end must extend to the service cut-out, and if a cabinet is required by the Code, must properly enter the cabinet.

Rule a, page 103, has been changed to read: "Must not be placed inside of any building, excepting central stations and sub-stations, except as provided in No. 30A, unless by special permission of the inspection department having jurisdiction."

Fine print note under rule a, page 103, omitted.

To rule b, page 103, has been added: "Must not be attached to frame buildings when any other location is practicable."

CLASS C. INSIDE WORK.

Rules a and b, page 110 have been changed to read:

a. Must not be of smaller size than No. 14 B. & S. gauge, except as allowed for fixture work and pendant cord.

b. Tie wires must have an insulation equal to that of the conductors they confine. For wire smaller than No. 8 B. & S. gauge split knobs or cleats shall be used except at dead ends, and tie wires and knobs will not be approved.

Screws must be used for fastening all cleats and knobs which are arranged to grip the wire.

Rule c, beginning with "Stranded wires must," has been changed to read:

Stranded wires (except in flexible cords) must be soldered before being fastened under clamps or binding screws, and whether stranded or solid, when they have a conductivity greater than that of No. 8 B. & S. gauge, they must be soldered into lugs for all terminal connections, except where an *approved* solderless terminal connector is used.

First paragraph of rule d has been changed to read:

d. Must be separated from contact with walls, floors, timbers or partitions through which they may pass by non-combustible, non-absorptive, insulating tubes, such as glass or porcelain, except at outlets where approved flexible tubing is required.

Fine print note under rule e, page 120, has been omitted, and in its place is: Where tubes are used they must be securely fastened at the ends to keep them from moving along the wire.

Rule a, page 124, now reads:

a. On constant potential circuits, all service switches and all switches controlling circuits supplying current to motors or heating devices, and all fuses, unless otherwise provided (for exceptions as to switches see Nos. 8c, 23a and 34A-c;

for exceptions as to cuts-outs see No. 21a and b) must be so arranged that the fuses will protect and the opening of the switch will disconnect all of the wires; that is, in the two-wire system the two wires, and the three-wire system the three wires, must be protected by the fuses and disconnected by the operation of the switch.

When installed without other automatic overload protective devices automatic overload circuit breakers must have the poles and trip coils so arranged as to afford complete protection against overloads and short circuits, and if also used in place of the switch must be so arranged that no one pole can be opened manually without disconnecting all the wires.

This, of course, does not apply to the grounded circuit of street railway systems.

Rule d, page 127, is shortened and now reads: "Time switches, sign flashers and similar appliances must be of approved design and enclosed in approved cabinet."

CONSTANT CURRENT SYSTEMS.

Fine print note on page 132, beginning, "Except on joisted," has been omitted.

CONSTANT POTENTIAL SYSTEMS.

Fine print note on page 134, beginning, "Excepting on main switchboard," has been omitted.

Rule a, page 136, has been changed to read:

a. Must be placed on all service wires, either overhead or underground, in the nearest accessible place to the point where they enter the building and inside the walls, and arranged to cut off the entire current from the building.

From rule c, page 144, reference (see No. 54) has been omitted and fine print note has been changed to read: "Link fuses must be used only when mounted on approved slate

or marble bases, and must be enclosed in dust-tight, fireproof cabinets, except on switchboards.

Fine print note on page 145, beginning, "The idea is to," has been omitted.

To rule e on page 146 add: "In which event the circuit-breaker may be set as high as 100 per cent above such capacity."

Following rule e, add rule f, as follows:

f. Each phase of A. C. motor circuits, except on main switchboard or when otherwise subject to expert supervision, must be protected by an *approved* fuse whether automatic overload circuit-breakers are installed or not. Single phase motors may have one side protected by an *approved* automatic overload circuit-breaker only if the other side is protected by an *approved* fuse. For circuits having a maximum capacity greater than that for which enclosed fuses are approved circuit-breakers alone will be approved.

Paragraphs 1 and 2 of fine print note on page 147 now read:

When practicable, switches must be so wired that blades will be "dead" when switch is open.

When switches are used in rooms where combustible flyings would be likely to accumulate around them, they must be enclosed in dust-tight cabinets."

To rule f, page 152, add: "Or they may be omitted if the switch is approved for mounting-directly on the moulding.

On page 153 omit fine print note beginning, "An approved automatic."

LOW POTENTIAL SYSTEMS.

550 volts or less.

Rule a has been changed to read:

a. Where entering cabinets must be protected by approved bushings, which fit tightly the holes in the box and are well

secured in place. The wires should completely fill the holes in the bushings so as to keep out the dust, tape being used to build up the wires if necessary. On concealed knob and tube work approved flexible tubing will be accepted in lieu of bushings, providing it shall extend from the last porcelain support into the cabinet.

To rule h, page 159, add: "Must not be dead-ended at a rosette socket or receptacle unless the last support is within twelve inches of the same."

Rule k, page 163, has been changed to read:

k. Must have an *approved* rubber insulating covering, and must be in continuous lengths from outlet to outlet, or from fitting to fitting, no joints or taps to be made in moulding. Where branch taps are necessary in moulding work *approved* fittings for this purpose must be used.

Fine print note under i, page 163, has been omitted.

Fine print note, page 168, beginning, "The same conduit," has been changed to read:

The same conduit must not contain more than four two-wire, or three three-wire circuits of the same system, except by special permission of the inspection department having jurisdiction, and must never contain circuits of different systems.

Rules t and u, page 170, have been changed to read:

t. When using either conduit or armored cable in mixed concealed knob and tube work, the requirements for conduit work or armored cable work must be complied with as the case may be.

u. Must at all outlets, except where conduit is used, be protected by *approved* flexible tubing, extending in continuous lengths from the last porcelain support to at least one inch beyond the outlet. In the case of combination fixtures the tubes must extend at least flush with outer end of gas cap.

When the surface at any outlet is broken, it must be repaired so as to leave no holes or open spaces at such outlet. It is suggested that *approved* outlet boxes or plates be installed at all outlets in concealed "knob and tube" work, the wires to be protected by *approved* flexible tubing, extending in continuous lengths from the last porcelain support into the box.

To rule v, page 173, has been added: In wiring certain designs of show-case fixtures, ceiling bulls-eyes and similar appliances in which the wiring is exposed to temperatures in excess of 120 degrees Fahrenheit (49 degrees Centigrade), from the heat of the lamps, *approved* slow-burning wire may be used. All such forms of fixtures must be submitted for examination, test and approval before being introduced for use.

Rule y, page 173, has been changed to read:

y. Wires of different systems must never be contained in or attached to the same fixture and under no circumstances must there be a difference of potential of more than 300 volts between wires contained in or attached to the same fixture.

From note under a, page 173, the word "underground" has been omitted.

Fine print note under c, page 174, has been changed to read:

Armor of cables and gas pipes must be securely fastened in metal outlet boxes so as to secure good electrical connection. Where boxes used for centers of distribution do not afford good electrical connection the armor of the cables must be joined around them by suitable bond wires. Where sections of armored cable are installed without being fastened to the metal structure of buildings or grounded metal piping, they must be bonded together and joined to a permanent and efficient ground connection.

Rule d, page 174, has been changed to read:

d. When installed in so-called fireproof buildings in course of construction or afterward if exposed to moisture, or where it is exposed to the weather, or in damp places such as breweries, stables, etc., the cable must have a lead covering at least one thirty-second inch in thickness placed between the outer braid of the conductors and the steel armor.

The lead covering is not to be required when the cable is run against brick walls or laid in ordinary plaster walls unless same are continuously damp.

On page 174, following g, rule h has been added.

h. All bends must be so made that the armor of the cable will not be injured. The radius of the curve of the inner edge of any bend not to be less than $1\frac{1}{2}$ inches.

Fine print note under "Interior Conduits" has been omitted.

Fine print note under f, page 180, has been changed to read:

Conduits and gas pipes must be securely fastened in metal outlet boxes so as to secure good electrical connection. If conduit, couplings, outlet boxes or fittings having protective coating of non-conducting material, such as enamel, are used, such coating must be thoroughly removed from threads of both couplings and conduit and from surfaces of boxes and fittings where the conduit is secured in order to obtain the requisite good connection. Where boxes used for centers of distribution do not afford good electrical connection, the conduits must be joined around them by suitable bond wires. Where sections of metal conduit are installed without being fastened to the metal structure of buildings or grounded metal piping, they must be bonded together and joined to a permanent and efficient ground connection.

To fine print note under rule d, pages 186-187, has been added: "It is suggested that outlet boxes and fittings having conducting coatings be used in order to secure better

electrical contact at all points throughout the conduit system."

To rule a, page 187, has been added:

In straight electric fixtures where the insulation of conductors and the metal of fixtures are the equivalent of a conduit or armored cable system, or where used with approved wireless clusters or where the double-braided wire extends directly into an *approved* porcelain socket, the insulating joint may be omitted.

Rule c, page 190, has been changed to read:

"Must be free from contacts between conductors and fixtures, 'short circuits' and ground connection, and must be tested for such conditions before being connected to the circuit supply conductors."

Following rule d, page 193, the following have been added:

e. The so-called flat canopy sometimes used on electric and combination fixtures will not be approved except in connection with outlet boxes.

f. Must, when installed on the outside of frame buildings, be of water-tight construction.

g. Must not, when wired on the outside, be used in show windows or in the immediate vicinity of especially inflammable stuff.

In place of fine print note, page 195, the following is substituted:

"For all portable work, including those pendants which are liable to be moved about sufficiently to come in contact with surrounding objects, flexible wires and cables especially designed to withstand this severe service must be used.

When necessary to prevent portable lamps from coming in contact with inflammable materials, or to protect them from breakage, they must be surrounded with a substantial wire guard.

Rule e, page 196, has been changed to read: "Must not

be used in show windows or showcases, except when provided with an approved metal armor.

NEW RULE.

29A. MERCURY VAPOR LAMPS.

Enclosed Mercury Vapor Lamps.

a. Must have cut-out for each lamp or series of lamps, except when contained in single frame and lighted by a single operation, in which case not more than five lamps should be dependent upon single cut-out.

b. Must only be furnished with such resistances or regulators as are enclosed in non-combustible cases, such resistances to be treated as sources of heat. In locations where these resistances or regulators are subject to flyings of lint or combustible material, all openings through cases must be protected by fine wire gauze.

HIGH POTENTIAL VACUUM TUBE SYSTEMS.

c. The tube must be so installed as to be free from mechanical injury or liability to contact with inflammable material.

d. High potential coils and regulating apparatus must be installed in approved steel cabinet not less than 1-10 inch in thickness; same to be well ventilated in such a manner as to prevent the escape of any flame or sparks, in case of burnout in the various coils. All apparatus in this box must be mounted on slate base and the enclosing case positively grounded. Supplying conductors leading into this high potential case to be installed in accordance with the standard requirements governing low potential systems, where such wires do not carry a potential of over 300 volts.

NEW RULE.

30A. TRANSFORMERS.

Oil Transformers.

a. Must not be placed inside of any building except central stations and sub-stations, unless by special permission of the inspection department having jurisdiction.

Air-Cooled Transformers.

The following sections do not apply to apparatus or fittings, the operation of which depends either wholly or in part upon special transformers embodied in the devices, but all such apparatus or fittings must be submitted for special examination and approval before being used.

b. Must not be placed inside of any building excepting central stations and sub-stations, if the highest voltage of either primary or secondary exceeds 550 volts.

c. Must be so mounted that the case shall be at a distance of at least one foot from combustible material or separated therefrom by non-combustible, non-absorptive, insulating material, such as slate, marble or soapstone. This will require the use of a slab or panel somewhat larger than the transformer.

Fine print note on page 199, beginning, "No System of," is omitted.

THEATRE WIRING.

All rules requiring conduit exclusively have been changed to admit armored cable.

Rule e and fine print note on page 207 have been changed to read:

e. Cables must be made up of *approved*, stranded rubber-covered wires; conduit construction must be used from switchboard to point where cables must be flexible to per-

mit of the raising and lowering of border, and flexible portion must be enclosed in an *approved* fireproof hose or braid and be suitably supported.

An approved junction box must be installed at the end of the conduit where the flexible cable leaves for the border.

Rule c, page 215, has been changed to read:

1. "Must be wired in approved conduit or armored cable."
2. All pendant lamps must be equipped with approved reinforced cord, armored cable or steel armored flexible cord.
3. All lamps must be provided with approved guards.

Rule e, page 224, section 1, has been changed to read: "All wiring must be installed in approved conduit or armored cable."

NEW RULE.

31B. OUTLINE LIGHTING.

Wiring (other than signs on exterior of buildings):

- a. Must be connected only to low-potential systems.
- b. Open or conduit work may be used, but molding will not be permitted.
- c. For open work, wires must have an approved rubber insulating covering. Must be rigidly supported on non-combustible, non-absorptive insulators, which separate the wires at least one inch from the surface wired over, and must be kept apart at least two and one-half inches for voltages up to 300, and four inches for higher voltages.

Rigid supporting requires, under ordinary conditions where wiring over flat surfaces, supports at least every four and one-half feet. If the wires are liable to be disturbed, the distances between supports should be shortened.

d. Where flexible tubing is required, the ends must be sealed and painted with moisture repellent, and kept at least one-half inch from surface wired over.

e. Wires for use in rigid or flexible steel conduit must

comply with requirements for unlined conduit work. Where armored cable is used, the conductors must be protected from moisture by lead sheath between armor and insulation.

f. Must be protected by its own cut-out, and controlled by its own switch. Cut-outs, switches, time switches, flashers and similar appliances, must be of approved design, and must, if located inside the building, be installed as required by the code for such devices. If outside the building they must be enclosed in a steel or cast-iron box.

If a steel box is used, the minimum thickness of the steel must be 0.128 of an inch (No. 8 B. & S. gauge).

Boxes must be so constructed that when switch operates the blade shall clear the door by at least one inch, and they must be moisture proof.

h. Circuits must be so arranged that not more than 1,320 watts will be finally dependent upon a single cut-out; nor shall more than 66 sockets or receptacles be connected to single circuit.

i. Sockets and receptacles must be of the keyless porcelain type, and wires must be soldered to lugs on same.

To section 4 of rule b, page 226, add: "Except that when motors are so enclosed that flame cannot extend outside of the casing, the flame proof covering will not be required on the motor leads."

Section 6, rule b, page 227, has been changed to read:

6. All connections of cables to cut-outs, switches and fittings, except those to controller connection boards, when designed to carry over 25 amperes, must be provided with lugs or terminals soldered to the cable, and securely fastened to the device, by bolts, screws or by clamping; or, the end of the cable, after the insulation is removed, shall be dipped in solder and be fastened into the device by at least two set screws having check nuts.

All connections for conductors to fittings, etc., designed

to carry less than 25 amperes, must be provided with up-turned lugs that will grip the conductor between the screw and the lug, the screws being provided with flat washers; or by block terminals having two set screws, and the end of the conductors must be dipped in solder. Soldering, in addition to the connection of the binding screws, is strongly recommended, and will be insisted on when above requirements are not complied with.

This rule only to apply to circuits where the maximum potential is over 25 volts and current exceeds 5 amperes.

Rule f, page 229, has been changed to read:

"f. Each outlet to be provided with an *approved* receptacle, or an *approved* cluster. No lamp consuming more than 128 watts to be used."

To rule g, page 230, add:

Truss plank heaters to be mounted on not less than one-quarter inch fire-resisting insulating material, the legs or supports for the heaters providing an air space of not less than one-half inch between the back of the heater and the insulating material.

CAR HOUSES.

Section 3, of rule e, page 234, has been changed to read:

3. Must have all rails bonded at each joint with a conductor having a carrying capacity at least equivalent to No. 0 B. & S. gauge annealed copper wire, and all rails must be connected to the outside ground return circuit by a not less than No. 0 B. & S. gauge copper wire or by equivalent bonding through the track. All lighting and stationary motor circuits must be thoroughly and permanently connected to the rails or to the wire leading to the outside ground return circuit.

No. 34 has been changed as follows:

34. LIGHTING AND POWER FROM RAILWAY WIRES.

a. Must not be permitted, under any pretence, in the same circuit with trolley wires with a ground return, except in electric railway cars, electric car houses, power houses, passenger and freight stations connected with the operation of electric railways.

34A. ELECTRIC CRANES.

All wiring, apparatus, etc., not specifically covered by special rules herein given, must conform to the Standard Rules and Requirements of the National Electrical Code, except that the switch required by Rule 8c for each motor may be omitted.

A. WIRING.

1. All wires except bare collector wires, those between resistances and contact plates of rheostats and those subjected to severe external heat, must be approved, rubber-covered and not smaller in size than No. 12 B. & S. Insulation on wires between resistances and contact plates of rheostats must conform to Section d, while wires subjected to severe external heat must have approved slow-burning insulation.

2. All wires excepting collector wires and those run in metal conduit or approved flexible cable must be supported by knobs or cleats which separate them at least one inch from the surface wired over, but in dry places where space is limited the distance between wires as required by Rule 24-h cannot be obtained, each wire must be separately encased in approved flexible tubing securely fastened in place.

Collector wires must be supported by approved insulators so mounted that even with the extreme movement permitted the wires will be separated at all times at least 1 1-2 inches from the surface wired over. Collector wires must be held at the ends by approved strain insulators.

3. Main collector wires carried along the runways must be rigidly and securely attached to their insulating supports at least every 20 feet, and separated at least six inches when run in a horizontal plane; if not run in a horizontal plane, they must be separated at least 8 inches. If spans longer than 20 feet are necessary the distance between wires must be increased proportionately but in no case shall the span exceed 40 feet.

4. Where bridge collector wires are over 80 feet long, insulating supports on which the wires may loosely lie must be provided at least every 50 feet.

Bridge collector wires must be kept at least 2 1-2 inches apart, but a greater spacing should be used whenever it may be obtained.

5. Collector wires must not be smaller in size than specified in the following table for the various spans.

Distance between rigid supports. Feet.	Size wire required. B. & S.
0 to 30	6
31 to 60	4
Over 60	2

B. COLLECTORS.

Must be so designed that sparking between them and collector wires will be reduced to a minimum.

C. SWITCHES AND CUT-OUTS.

1. The main collector wires must be protected by a cut-out and the circuit controlled by a switch. Cut-out and switch to be so located as to be easy of access from the floor.

2. Cranes operated from cabs must have a cut-out and switch connected into the leads from the main collector

wires and so located in the cab as to be readily accessible to the operator.

3. Where there is more than one motor on a single crane, each motor lead must be protected by a cut-out located in the cab if there is one.

D. CONTROLLERS.

Must be installed according to No. 4, except that if the crane is located out doors the insulation on wires between resistances and contact plates of rheostats must be rubber where the wires are exposed to moisture and insulation is necessary and also where they are grouped. If the crane operates over readily combustible material, the resistances must be placed in an enclosure made of non-combustible material, thoroughly ventilated and so constructed that it will not permit any flame or molten metal to escape in the event of burning out the resistances. If the resistances are located in the cab, this result may be obtained by constructing the cab of non-combustible material and providing sides which enclose the cab from its floor to a height at least 6 inches above the top of the resistances.

E. GROUNDING OF IRON WORK.

The motor frames, the entire frame of the crane and the tracks must be permanently and effectively grounded.

HIGH POTENTIAL SYSTEMS.

To preliminary note page 234 has been added: "For 550 volt motor equipments a margin of ten per cent above the 550 volt limit will be allowed at the generator or transformer without coming under high potential systems."

CLASS E. MISCELLANEOUS.

Rule b, page 288, has been changed to allow separation of wires to be 24 inches instead of 26.

Above rule c, page 288, has been inserted: "When the wires are carried in approved cables the next three sections c, d and e do not apply."

Rule d, page 288, has been changed by omitting last line reading: "Except when brought in through approved metal covered cables."

Paragraph 2, of section 3, rule 7, page 290, has been changed to read:

When the ground wire is attached to a water pipe or a gas pipe, it may be connected by means of an approved ground clamp fastened to a thoroughly clean portion of said pipe, or the pipe shall be thoroughly cleaned and tinned with rosin flux solder, and the ground wire shall then be wrapped tightly around the pipe and thoroughly soldered to it.

Paragraph 3, in same rule has been entirely omitted.

Rule n, page 292, has been changed to read:

n. Wires beyond the protector, or wires inside buildings where no protector is used, must be neatly arranged and securely fastened in place in some convenient, workmanlike manner.

They must not come nearer than three inches to any electric light or power wire in the building, unless separated therefrom by some continuous and firmly fixed non-conductor creating a permanent separation; this non-conductor to be in addition to the regular insulation on the wire.

Fine print note at bottom of page 292 has been omitted.

PRACTICAL HINTS.

A full description of the Wheatstone bridge, the telephone, magneto and other instruments, as well as the many ways of their application in testing for defects and for circuits in electrical installations having been given in a previous work of the authors (*Wiring Diagrams and Descriptions*) it is not thought necessary to repeat them here, especially as a work of this kind is necessarily limited in diagrams which would be required to a full understanding of methods. This chapter will, therefore, consist only of such hints and instructions as apply to general work.

An electric light circuit may be tested for "short circuit" by connecting an incandescent lamp in place of one of the fuses. If the lamp burns while there are no lamps in circuit, there is sure to be a short circuit. A low candle-power lamp will indicate with less current than a high-candle-power lamp and is, therefore, better. If no lamp is available a small fuse should first be tried.

A test for "ground" may be made in the same way, but the lamp must be connected to both sides in turn and the fuse left

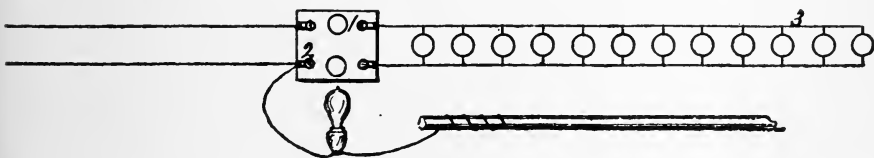

Figure 168

out. If the main system to which the circuit to be tested connects is not grounded, a temporary ground must be put on. This is best done by connecting a lamp with one wire to a gas or water pipe and the other to the "live" binding screw on the opposite side of cutout to that in which the other lamp is connected. Thus, in Figure 168, if a ground should exist at 3 and the lamp be connected to gas pipe, as shown, the test lamp at 1 would burn.

If a voltmeter were connected in place of either of the lamps, the test would be much more searching.

With 3-wire systems no ground need be put on, as the neutral wire will always be found grounded. The lamp need be tried in the outside fuses only. This test will be more searching if lamps are placed in all sockets connected.

In placing fuses in the 3-wire, 110-220 volt system, the neutral wire should always be fused first.

By reference to Figure 169 it will be seen that while the neutral fuse in main blocks *a* is out, the two circuits of lamps *c* and *d* must burn in series; that is, just as much current must pass through one circuit as through the other. So long as there is an equal number of lamps in each circuit there is no trouble; but should most of the lamps in one circuit be turned off, those remaining would have to carry all the current that passes through the lamps of the other circuit. This current would overheat them and break, or burn them out in a very short time. If the neutral fuse is in place, each circuit is independent of the other and the neutral wire only carries the difference in current between the two sets of lamps. In order to insure against a neutral fuse "blowing" first in case of trouble, it is generally made heavier than in the outside wires. When a 3-wire circuit is to be cut off, the outside fuses should be drawn first.

In order to find which is the "neutral" wire, two 110 volt lamps are connected in series and the wires from them brought in contact with two of the three wires. If both lamps burn at full candle power we have 220 volts, which is the pressure of the outside wires, and, therefore, the other wire must be the neutral. If the lamps burn only at half candle power, we have only 110 volts and one of the wires must be the neutral. That wire which gives 110 volts with either one of the other two wires is the neutral; this wire should always be run in the center between the other two.

A test for the neutral wire can also be made by connecting a lamp to ground. A lamp connected this way will burn from either of the outside wires, but not from the neutral.

If the neutral wire should be connected to any but the middle binding post of 3-wire cutouts and the outside wire to the other two, one-half of the lamps would be almost immediately destroyed, being subject to 220 volts, while the other half would burn properly.

If a short circuit occurs, say at *e*, Figure 169, on one side of a 3-wire system and blows the neutral fuse on that side of the circuit, we shall have 220 volts on the lamps on the opposite side. This will quickly burn them out. Most of these

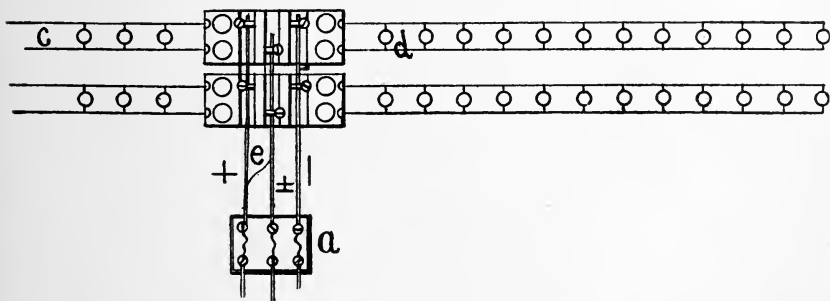

Figure 169

troubles are avoided to some extent by the use of such branch cutouts as shown. This confines trouble of this kind to the mains.

On any system having a neutral wire or a wire on one side grounded, if a ground on either of the other wires occurs, the trouble can be temporarily remedied by simply changing the two wires of that circuit at the cutout. This will transfer the ground to the side already grounded, so that it will not interfere with operation. The ground must, however, be cleared up at once as no grounding is ever allowed inside of any building.

When strip cutouts are set horizontally and there is no

bridge between opposite polarities, there will be the possibility of a partially melted upper fuse sagging down and forming a short circuit.

On panel boards where fuses are set too close together, the heat of one fuse while blowing will often blow the next fuse above it.

If large fuses are enclosed in small and very tight cabinets, the vapors formed by blowing will often cause short circuits.

Before installing fuses in a "loaded" circuit, it is advisable to disconnect as many lights and other devices as possible. If there is a main switch this can easily be done. If there is no such switch on that part of the system, the task of placing fuses is somewhat hazardous; for at the very instant that the second fuse touches its terminal a great rush of current will flow. If there happens to be a "short" on the line both fuses will probably blow and may burn the operator's hands and face severely. In order to avoid this, extremely careful manipulation is necessary. The first fuse can be placed without any difficulty, as there will be no current flow unless the circuits are grounded. Before attempting to place the second fuse the circuits may be tested for "shorts" by placing a "jumper" (a piece of wire heavy enough so that it will not be heated by the current it is to carry) with the ends on the other fuse terminals. This "jumper" will complete the circuit and, if all is in order the lights will burn. If there are two men, one may hold the jumper while the other places the fuse, but it should be placed as quickly as possible, especially if the circuit has a motor load, for these will be started very soon after the lights come on and will greatly increase the current. If there is but one man the jumper may be temporarily fastened to the mains.

A jumper is not absolutely necessary even with large fuses, for if the last contact is made quickly and held steady, there

will be very little arcing; one should, however, provide all protection possible. If a piece of asbestos is at hand, it may be used to cover the fuses, so as to protect the hands and face from melted metal.

Before attempting to re-fuse a circuit, note condition of cutout block. If there is evidence of a great flash, it is very likely that the fuse was blown by a short circuit. If the blowing was caused by a slight overload or loose contact, the destructive effect will be much less.

Much trouble can be prevented by cleaning terminals of fuse blocks occasionally and going over nuts and screws to see that they are tight.

In Figure 170, *a* shows the proper way of connecting small wires into such terminals. This method prevents the screw from cutting into the main wire and allowing it to break.

A wire should always be bent around the binding post of switch or cutout in the direction in which the nut which is to

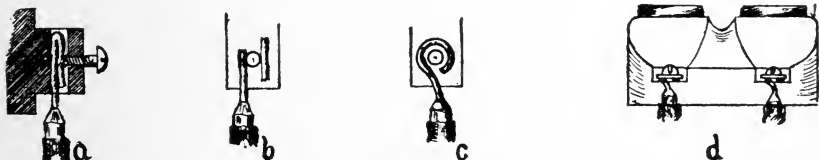

Figure 170

hold it must turn to be fastened as in *c*. If a wire is not long enough to be bent around the post or screw, a small piece of wire should be placed opposite it so as to give a level bearing to nut or washer. See *b*.

Plug cutouts having their metal parts projecting above the porcelain, as shown at *d*, should be connected, whenever possible, so that these metal parts are dead when fuses are withdrawn. This will prevent many accidental short circuits.

The positive and negative wires of a circuit can easily be determined by immersing both wires in a little water, keeping

them an inch or so apart. Small bubbles will soon appear at the negative wire.

If an arc lamp has been properly connected, the upper carbon will be heated much more than the lower and will remain red longer. An arc lamp improperly connected is said to be burning "upside down" and will at once manifest itself by the strong light thrown against the ceiling.

It is very often found necessary to determine the capacity of a cable which is already installed and where it is impossible to get at the separate wires of which it is formed. As cables are usually made up in a uniform manner, as shown in the table below, their capacity can be determined by the following method: To find the number of circular mils in a cable made up of wires of uniform size. Measure diameter of cable, count number of wires in outside layer, and, referring to the table below, find the same number in the first column; divide the diameter of cable by the number set opposite this in the second column. This will give the diameter of each wire. Multiply this diameter by itself and then by the number of wires contained in cable as given in the third column. All measurements should be expressed in mils ($1/1,000$ inch) and the result will be the circular mils contained in cable.

Outside layer	6 wires	3 times diameter	7 wires in cable
" "	12	" 5 "	" 19 " " "
" "	18	" 7 "	" 37 " " "
" "	24	" 9 "	" 61 " " "
" "	30	" 11 "	" 91 " " "
" "	36	" 13 "	" 127 " " "
" "	42	" 15 "	" 169 " " "

The various figures in Figure 171 are designed to show how many single wires may be run in one conduit. Under each figure is given a number which, if multiplied by the diameter of the wire to be used will give the smallest diameter of tube which can contain the corresponding number of wires. Thus, for instance, if 12 wires are run through

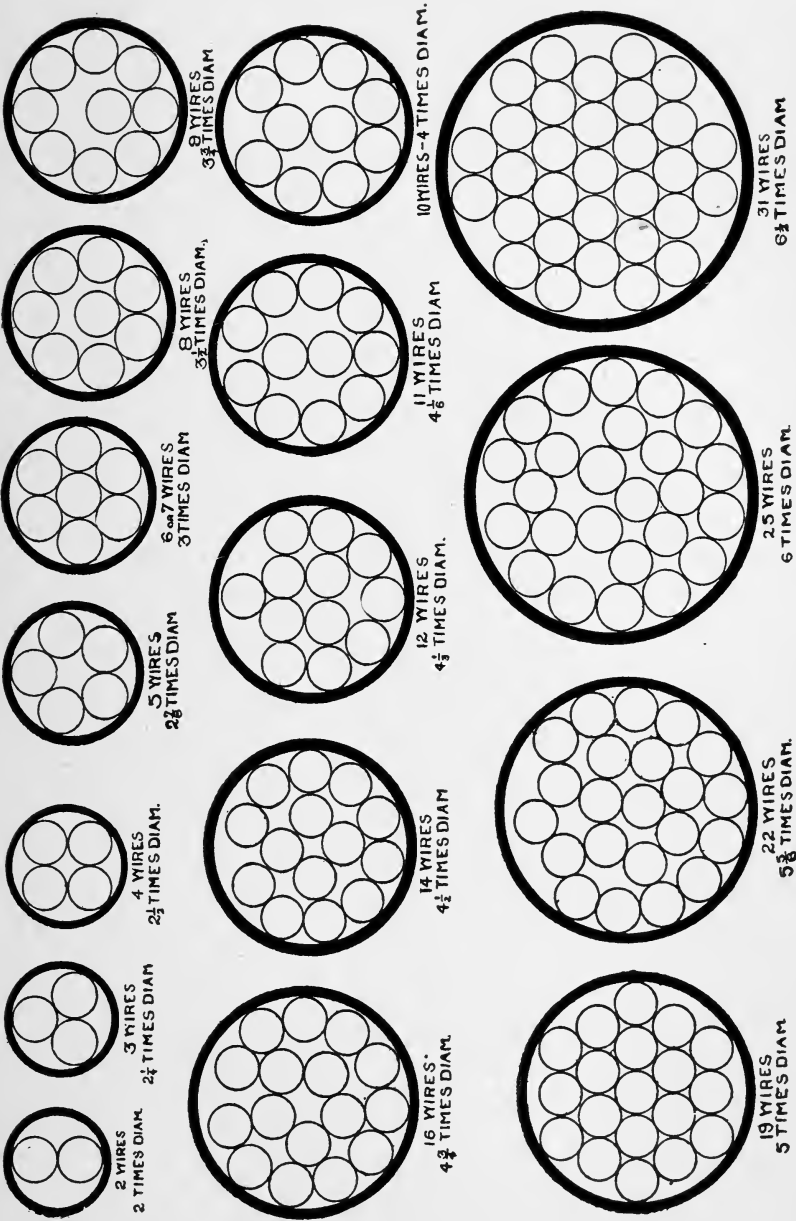

Figure 171

one tube or conduit, the diameter of that conduit must be at least $4 \frac{1}{3}$ times as great as the diameter of the wire to be used. Each figure illustrates the amount of spare room the corresponding number of wires leave, and it is necessary to use considerable judgment. Long runs will require more space, especially if the wires be quite large. Much also depends upon the nature of the insulation and the temperature. The figures are believed to be correct for single wires and can be followed for twin wires, as the same number of conductors arranged that way will not occupy as much space as single wires. The actual diameter of lined and unlined conduits are given in another table and may be referred to. The best way to accurately determine the diameter of small wire consists in cutting a number of short pieces and laying them together, then measuring over all and dividing the measurement by the number of wires.

TRICKS OF THE TRADE.

Cases have been known where it was requested to replace single pole switches by double pole, that the single pole switch was replaced as requested, but, instead of running both wires through it as required, only one wire had been properly brought into it and the other two binding posts filled out with short pieces of wire calculated to deceive the inspector. A test to detect this without disconnecting the switch is easily made. By reference to Figure 172 it will be seen that if a double pole snap switch is properly connected, current can be felt if the points *a* and *b* are touched with moistened fingers. If the switch is connected single pole, current can be felt at *b* and *c*, when the switch is open, only.

On one occasion a wireman had run some wires on insulators along a ceiling and instead of soldering joints had care-

fully, in many places above the joints, smoked the ceiling with a candle in order to deceive an inspector.

In several cases where an "over-all" test of insulation resistance was made, meter loops which had been run in continuous pieces were found with the wire "nicked" with a knife and then broken, leaving the insulation nearly intact, but the circuit open. A similar trick is often worked with the ground wire of ground detectors.

In other cases plugs with fuses removed were put in "bad" circuits. In one case the real circuit wires (concealed

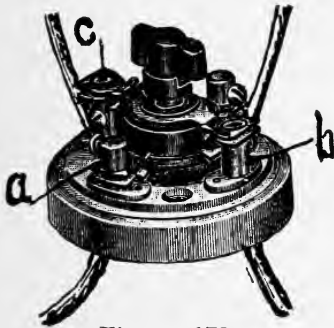

Figure 172

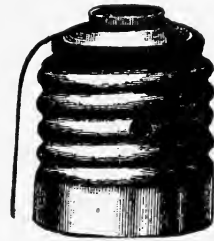

Figure 173

work) were disconnected from cutouts and pushed back into the wall and short pieces connected instead.

In another case where wire not up to requirements had been used and condemned, this wire, being run between joists and concealed by plastering, was pushed back and short pieces of approved wire stuck in at outlets.

Sometimes in fished work after inspection the long pieces of loom reaching from outlet to outlet are withdrawn and short pieces at the outlets substituted.

Lamp butts with wire terminals twisted together, or a strand of wire from lamp cord twisted around the base as shown in Figure 173 and screwed into the cutout are often used in place of fuses. The strand of cord is sometimes used to help out a fuse plug on an overloaded circuit.

Table of Carrying Capacity of Wires.

The following table, showing the allowable carrying capacity of copper wires and cables of ninety-eight per cent conductivity, according to the standard adopted by the American Institute of Electrical Engineers, must be followed in placing interior conductors.

For insulated aluminum wire the safe carrying capacity is eighty-four per cent of that given in the following tables for copper wire with the same kind of insulation

TABLE NO. I.

B. & S. G.	Table A.	Table B.	Circular Mils.
	Rubber Insulation. See No. 41.	Other Insulations. See Nos. 42 to 44.	
	Amperes.	Amperes.	
18.....	3.....	5.....	1,624
16.....	6.....	8.....	2,583
14.....	12.....	16.....	4,107
12.....	17.....	23.....	6,530
10.....	24.....	32.....	10,380
8.....	33.....	46.....	16,510
6.....	46.....	65.....	26,250
5.....	54.....	77.....	33,100
4.....	65.....	92.....	41,740
3.....	76.....	110.....	52,630
2.....	90.....	131.....	66,370
1.....	107.....	156.....	83,690
0.....	127.....	185.....	105,500
00.....	150.....	220.....	133,100
000.....	177.....	262.....	167,800
0000.....	210.....	312.....	211,600
Circular Mils.			
200,000.....	200.....	300	
300,000.....	270.....	400	
400,000.....	330.....	500	
500,000.....	390.....	590	
600,000.....	450.....	680	
700,000.....	500.....	760	
800,000.....	550.....	840	
900,000.....	600.....	920	
1,000,000.....	650.....	1,000	
1,100,000.....	690.....	1,080	
1,200,000.....	730.....	1,150	
1,300,000.....	770.....	1,220	
1,400,000.....	810.....	1,290	
1,500,000.....	850.....	1,360	
1,600,000.....	890.....	1,430	
1,700,000.....	930.....	1,490	
1,800,000.....	970.....	1,550	
1,900,000.....	1,010.....	1,610	
2,000,000.....	1,050.....	1,670	

The lower limit is specified for rubber-covered wires to prevent gradual deterioration of the high insulations by the heat of the wires, but not from fear of igniting the insulation. The question of drop is not taken into consideration in the above tables.

The carrying capacity of Nos. 16 and 18, B. & S. gage wire is given, but no smaller than No. 14 is to be used, except as allowed under Nos. 24 v and 45 b.

WIRING TABLES.

The wiring tables, II-VI, are arranged in the following manner: For each size of wire and voltage considered there is given (under the proper voltage and opposite the number of the wire under the heading B. & S.) the distance it will carry 1 ampere at a loss designated at top of page.

The same wire will carry 2 amperes only half as far at the same percentage of loss and again will carry 1 ampere twice as far at double the percentage of loss.

From these facts we deduce the rule of these tables, which is: Multiply the distance in feet (one leg only) by the number of amperes to be carried. Take the number so obtained and under the proper voltage find the number nearest equal to it. Opposite this number, under the heading B. & S., will be found the size of wire required. To illustrate: We have 22 amperes to carry a distance of 135 feet and the loss to be allowed is 3 per cent at 110 volts. We therefore multiply $135 \times 22 = 2970$, and turning to table IV., which is figured for 3 per cent loss, follow downward in the column under 110 until we reach the number nearest equal to 2970, which, in this case, is .3180 corresponding to a No. 7 wire. With this wire our loss will be slightly less than 3 per cent, while with No. 8 it would be somewhat in excess of 3 per cent.

For three-wire systems using 110 volts on each side the column marked 220 volts should be used. The column marked 440 volts is provided for three-wire systems using 220 volts

on each side. The sizes determined will be correct for all three wires in both cases.

The columns at the right, marked motors, are arranged in the same way, the only difference being, for greater convenience, they are figured in horse-power feet instead of ampere feet. For this reason we multiply the distance in feet by the number of horse-power to be transmitted and divide by the percentage of loss, all other operations remaining the same as under lights. When any considerable current is to be carried only a short distance the wire indicated by the desired loss will very likely not have sufficient carrying capacity; it is, therefore, always necessary to consult the table of carrying capacities.

RULE FOR WIRING TABLES.

For lights, find the ampere feet (one leg) and under the proper voltage find the number equal to this or the next larger; opposite this number, in the column marked B. & S., will be found the size of wire required.

For motors, proceed in the same way, using horse-power feet instead of ampere feet.

For alternating currents, the results obtained by multiplying the amperes (or horse-power) by the feet, should be multiplied by the following factors:

1.1 for single-phase systems, all lights.

1.5 for single-phase systems, all motors.

For two-phase, four-wire, or three-phase, three-wire systems, each wire need be only one-half as large as for single-phase systems and the number obtained may, therefore, be divided by two.

TABLE II.—WIRING TABLE FOR 1% LOSS.

LIGHTS IN AMPERES.				B. & S. Gauge	Car. Cap.	MOTORS IN H. P.				Resis. per foot.
VOLTAGE.						VOLTAGE.				
52	110	220	440			110	220	440	500	
98	209	418	836	14	12	112	448	579	.002628	
124	263	526	1052	13	..	35	560	724	.002084	
158	333	666	1332	12	17	44	704	910	.001653	
200	420	840	1680	11	..	56	896	1159	.001311	
250	529	1058	2116	10	24	70	1120	1449	.001040	
314	665	1330	2660	9	..	88	1408	1821	.000824	
397	841	1682	3364	8	33	112	1792	2318	.000654	
501	1060	2120	4240	7	..	141	2256	2918	.000519	
634	1338	2676	5352	6	46	178	2848	3684	.000411	
798	1687	3374	6748	5	54	224	3584	4636	.000326	
1000	2124	4248	8496	4	..	283	4528	5858	.000259	
1271	2683	5366	10732	3	65	357	5712	7389	.000205	
1595	3374	6748	13496	2	90	449	7184	9294	.000163	
2011	4264	8527	17054	1	107	568	9088	11757	.000129	
2543	5392	10784	21568	0	127	718	11488	14762	.000102	
3228	6790	13580	27160	00	150	905	14480	18733	.000081	
4053	8594	17188	34376	000	177	1145	18320	23701	.000064	
5090	10784	21568	43136	0000	210	1437	22992	29745	.000051	
6032	12790	25580	51160	250000	235	1696	27136	35107	.0000431	
7222	15277	30554	61108	300000	270	2036	32576	42145	.000036	
8441	17857	35714	71428	350000	300	2368	37888	49017	.0000308	
9629	20370	40740	81480	400000	330	2714	43424	56179	.000027	
10833	22916	45832	91664	450000	360	3054	48864	63217	.000024	
12093	25581	51162	102324	500000	390	3393	52888	70235	.0000215	
24074	50925	101850	203700	1000000	650	6786	108576	140470	.0000108	
48148	101851	203702	407404	2000000	1050	13573	217168	280961	.0000054	

TABLE III.—WIRING TABLE FOR 2% LOSS.

LIGHTS IN AMPERES.				B. & S. Gauge	Car. Cap.	MOTORS IN H. P.					Resis. per foot.
VOLTAGE.						VOLTAGE.					
52	110	220	440			110	220	440	500		
196	418	836	1672	14	12	56	224	896	1158	.002628	
248	526	1052	2104	13	...	70	280	1120	1448	.002084	
316	666	1332	2664	12	...17	88	352	1408	1820	.001653	
400	840	1680	3360	11	...24	112	448	1792	2318	.001311	
500	1058	2116	4232	10	...	140	560	2240	2898	.001040	
628	1330	2660	5320	9	...	176	704	2816	3642	.000824	
794	1682	3364	6728	8	...33	224	896	3584	4636	.000654	
1002	2120	4240	8480	7	...46	282	1128	4512	5836	.000519	
1268	2676	5352	10704	6	...54	356	1424	5696	7368	.000411	
1596	3374	6748	13496	5	...	448	1792	7168	9272	.000326	
2000	4248	8496	16992	4	65	566	2264	9056	11716	.000259	
2542	5366	10732	21464	3	76	714	2856	11424	14778	.000205	
3190	6748	13496	26992	2	90	898	3592	14368	18588	.000163	
4022	8528	17054	34108	1	107	1136	4544	18176	23514	.000129	
5086	10784	21568	43136	0	127	1436	5744	22976	29524	.000102	
6456	13580	27160	54320	00	150	1810	7240	28960	37466	.000081	
8106	17188	34376	68752	000	177	2290	9160	36640	47402	.000064	
10180	21568	43136	86272	0000	210	2874	11496	45984	59490	.000051	
12064	25580	51160	102320	250000	235	3392	13568	54272	70214	.0000431	
14444	30554	61108	122216	300000	270	4072	16288	65152	84290	.000036	
16882	33714	71428	142856	350000	300	4736	18944	75776	98034	.0000308	
19258	40740	81480	162960	400000	330	5428	21712	86848	112358	.000027	
21666	45832	91664	183328	450000	360	6108	24432	97728	126434	.000024	
24186	51162	102324	204648	500000	390	6786	27144	108576	140470	.0000215	
48148	101850	203700	407400	1000000	650	13572	54288	217152	280940	.0000108	
96296	203702	407404	814808	2000000	1050	27146	108584	434336	561922	.0000054	

TABLE IV.—WIRING TABLE FOR 3% LOSS.

LIGHTS IN AMPERES.				B. & S. Gauge.	Car. Cap.	MOTORS IN H. P.				Resis. per foot.
VOLTAGE.						VOLTAGE.				
52	110	220	440			110	220	440	500	
294	627	1254	2508	14	12	84	336	1344	1737	.002628
372	789	1578	3156	13	11	105	420	1680	2172	.002084
474	999	1998	3996	12	10	132	528	2112	2730	.001653
600	1260	2520	5040	11	9	168	672	2688	3477	.001311
750	1587	3174	6348	10	8	210	840	3360	4347	.001040
942	1995	3990	7980	9	7	264	1056	4224	5463	.000824
1191	2523	5046	10092	8	6	336	1344	5376	6954	.000654
1503	3180	6360	12720	7	5	423	1692	6768	8754	.000519
1902	4014	8028	16056	6	4	534	2136	8544	11052	.000411
2394	5061	10122	20244	5	3	672	2688	10752	13808	.000326
3000	6372	12744	25488	4	2	849	3396	13584	17574	.000259
3813	8049	16098	32196	3	1	1071	4284	17136	22167	.000205
4785	10122	20244	40458	2	0	1347	5388	21552	27882	.000163
6033	12792	25581	51162	1	0	1704	6816	27264	35271	.000129
7629	16176	32352	64704	0	0	2154	8616	34464	44286	.000102
9684	20370	40740	81480	00	00	2715	10860	43440	56199	.000081
12059	25782	51564	103128	000	000	3435	13740	54960	71103	.000064
15270	32352	64704	129408	0000	0000	4311	17244	68976	89235	.000051
18096	38370	76740	153480	250000	250000	5088	20352	81408	105321	.0000431
21666	45831	91662	183324	300000	300000	6108	24432	97728	126435	.000036
25323	53571	107142	214284	350000	350000	7104	28416	113664	147051	.0000308
28887	61110	122220	244440	400000	400000	8142	32568	130372	168537	.000027
32499	68748	137496	274992	450000	450000	9162	36648	146592	189651	.000024
36279	76743	153486	306972	500000	500000	10179	40716	162864	210705	.0000215
72222	152775	305550	611100	1000000	1000000	20358	81432	325728	421410	.0000108
144444	305553	611106	1222212	2000000	2000000	40719	162876	651504	842883	.0000054

TABLE V.—WIRING TABLE FOR 4% LOSS.

LIGHTS IN AMPERES.				MOTORS IN H. P.				Resis. per foot.
VOLTAGE.				VOLTAGE.				
52	110	220	440	110	220	440	500	
392	836	1672	3344	12	112	448	1792	2316
496	1052	2104	4208	14	140	560	2240	2896
632	1332	2664	5328	13	176	704	2816	3640
800	1680	3360	6720	12	224	896	3584	4636
1000	2116	4232	8464	11	280	720	4480	5796
1256	2660	5320	10640	10	352	1408	5632	7284
1588	3364	6728	13456	9	448	1792	7168	9272
2004	4240	8480	16960	8	562	2256	9024	11672
2536	5352	10704	21408	7	712	2848	11392	14736
3192	6748	13496	26992	6	896	3584	14336	18544
4000	8496	16992	33984	5	1132	4528	18112	23432
5084	10732	21464	42928	4	1428	5712	22848	29556
6380	13496	26992	53984	3	1796	7184	28736	37176
8044	17054	34108	68216	2	2272	9088	36352	47028
10172	21568	43136	86272	1	2872	11488	45952	59048
12912	27160	54320	108640	0	3620	14480	57920	74932
16212	34376	68752	137504	00	4580	18320	73280	94804
20360	43136	86272	172544	0000	5748	22992	91968	118980
24128	51160	102320	204640	00000	6784	27136	108544	140428
28888	61108	122216	244432	250000	8144	32576	130304	168580
33764	71428	142856	285712	3000000	9472	37888	151552	196068
38516	81480	162960	325920	4000000	10856	43424	173696	224716
43332	91604	183328	366656	4500000	12216	48864	195456	252868
48372	102324	204648	409296	5000000	13572	54288	217152	280940
96296	203700	407400	814800	10000000	27144	108576	434304	561880
192592	407404	818808	1629616	20000000	54292	217168	868672	1123844

TABLE VI.—WIRING TABLE FOR 5% LOSS.

TABLES.

33

LIGHTS IN AMPERES.				B. & S. Gauge.	Car. Cap.	MOTORS IN H. P.				Resis. per foot.
VOLTAGE.						VOLTAGE.				
52	110	220	440			110	220	440	500	
490	1045	2090	4180	14	140	560	2240	2895	.002628	
620	1315	2630	5260	13	175	700	2800	3620	.002084	
790	1665	3330	6660	12	220	880	3520	4550	.001653	
1000	2100	4200	8400	11	280	1120	4480	5795	.001311	
1250	2645	5290	10580	10	350	1400	5600	7245	.001040	
1570	3325	6650	13300	9	440	1760	7040	9105	.000824	
1985	4205	8410	16820	8	560	2240	8960	11590	.000654	
2505	5300	10600	21200	7	705	2820	11280	14590	.000519	
3170	6690	13380	26760	6	890	3560	14240	18420	.000411	
3990	8435	16870	33740	5	1120	4480	17920	23180	.000326	
5000	10620	21240	42480	4	1450	5660	22640	29290	.000259	
6355	13415	26830	53660	3	1785	7140	28560	36945	.000205	
7975	16870	33740	67480	2	2245	8980	35920	46470	.000163	
10055	21320	42635	85270	1	2840	11360	45440	58785	.000129	
12715	26960	53920	107840	0	3590	14360	57440	73810	.000102	
16140	33950	67900	135800	00	4525	18100	72400	93665	.000081	
20265	42970	85940	171880	000	5725	22900	91600	118505	.000064	
25450	53920	107840	215680	0000	7185	28740	114960	148725	.000051	
30160	63950	127900	255800	250000	8480	33920	135680	175535	.0000431	
36110	76385	152770	305540	3000000	10180	40720	162880	210725	.000036	
42205	89285	176570	357140	350000	11840	47360	189440	245085	.0000308	
48145	101850	203700	407400	400000	13570	54280	217120	280895	.000027	
54165	114580	229160	458320	450000	15270	61080	244320	316085	.000024	
60465	127905	255810	511620	500000	16965	67860	271440	351175	.0000215	
120370	254625	509250	1018500	1000000	33930	135720	542880	702350	.0000108	
240740	509255	1018510	2037020	2000000	67865	271460	1085640	1404805	.0000054	

It is often necessary to reinforce mains which have become overloaded. It is quite usual though often very incorrect, to choose by the table of carrying capacities a wire of such size that the rated capacity of it and the wire to be re-enforced shall be equal to the load. Small wires have proportionately a much greater radiating surface than larger ones and therefore their carrying capacity is proportionally greater. In order that a wire connected in parallel with another wire shall carry a certain current, its circular mils, must be equal $\frac{C. M. \times a}{A}$

where C. M. stands for the cross-section of the larger wire in circular mils and A for the current to be carried by it, while a is the current to be carried by the extra wire. Table No. VII is calculated from this rule and shows the size of wire necessary to re-enforce another overloaded to a certain per cent as indicated in the top row. For instance, a 0000 wire overloaded 40 per cent requires re-enforcement by a No. 1; a No. 3 wire overloaded 20 per cent requires a No. 10 wire. Where large wires are re-enforced in this way by smaller ones great care must be taken that the larger wire cannot be accidentally broken or disconnected, since in such a case the whole load would be forced over the smaller wire and would likely result in a fire. The two wires should be securely soldered together.

TABLE NO. VII.

Am- peres.	B. & S.	10%	20	30	40	50	60	70	80	90	100
210	0000	6	4	2	1	0	00	000	000	0000	0000
177	000	8	5	3	2	1	0	00	000	000	000
150	00	9	6	4	3	2	1	0	0	00	00
127	0	10	7	5	4	3	2	1	1	0	0
107	1	10	8	6	5	4	3	2	2	1	1
90	2	11	9	7	6	5	4	3	3	2	2
76	3	12	10	8	7	6	5	4	4	3	3
65	4	14	11	9	8	7	6	5	5	4	4

INDIVIDUAL SWITCHES AND OUT-OUTS.

	125 Volts or less		126-250 Volts	
	Minimum Separation of Opposite Polarity	Minimum Break Distance	Minimum Separation of Opposite Polarity	Minimum Break Distance
10 Amperes or less	1 inch	$\frac{3}{4}$ inch	$1\frac{1}{2}$ inch	$1\frac{1}{4}$ inch
11-35 Amperes	$1\frac{1}{4}$ "	1 "	$1\frac{3}{4}$ "	$1\frac{1}{2}$ "
36-100 "	$1\frac{1}{2}$ "	$1\frac{1}{4}$ "	$2\frac{1}{4}$ "	2 "
101-300 "	$2\frac{1}{4}$ "	2 "	$2\frac{1}{2}$ "	$2\frac{1}{4}$ "
301-600 "	$2\frac{3}{4}$ "	$2\frac{1}{2}$ "	$2\frac{1}{2}$ "	$2\frac{1}{2}$ "
601-1000 "	3 "	$2\frac{3}{4}$ "	3 "	$2\frac{3}{4}$ "
FUSES				
10 Amperes or less	$\frac{3}{4}$ "	$\frac{3}{4}$ "	$1\frac{1}{2}$ "	$1\frac{1}{4}$ "
11-100 Amperes	1 "	$\frac{3}{4}$ "	$1\frac{3}{4}$ "	$1\frac{1}{4}$ "
101-300 "	1 "	1 "	$2\frac{1}{4}$ "	$1\frac{1}{2}$ "
301-1000 "	$1\frac{1}{4}$ "	$1\frac{1}{4}$ "	$2\frac{1}{2}$ "	2 "

NOTE.—For spacings or Edison three-wire systems, see Note to Rule 51k.

PANEL BOARDS CONTAINING SWITCHES OR STRIP FUSES.

	125 Volts or less		126-250 Volts	
	Minimum Separation of Opposite Polarity	Minimum Break Distance	10 Amperes or less 11-35 Amperes... 36-100 "	Min. Sep. of Op. Polarity
10 Amperes or less	$\frac{3}{4}$ inch	$\frac{1}{2}$ inch	10 Amperes or less	$1\frac{1}{2}$ inch
11-25 Amperes.....	1 "	$\frac{3}{4}$ "	11-35 Amperes...	$1\frac{1}{2}$ "
26-50 "	$1\frac{1}{4}$ "	1 "	36-100 "	2 "
FUSES			10 Amperes or less	$1\frac{1}{4}$ "
10 Amperes or less	$\frac{3}{4}$ "	$\frac{3}{4}$ "	11-100 Amperes ..	$1\frac{1}{4}$ "
11-100 Amperes	1 "	$\frac{3}{4}$ "		$1\frac{1}{4}$ "
Separation of Strip Fuses— Same Polarity		$\frac{1}{2}$ inch		$\frac{3}{4}$ inch

PANEL BOARDS WITH ENCLOSED FUSES—NO SWITCHES.

	125 Volts or less	126-250 Volts
Separation of Branch Bars..	$\frac{3}{4}$ inch	$1\frac{1}{4}$ inch
Separation Between Main and Branch Bars	$\frac{1}{2}$ "	$\frac{3}{4}$ "

MODERN ELECTRICAL CONSTRUCTION.
DIMENSIONS OF COPPER WIRE

Numbers B. & S. Gauge	Diameters in Mils.	Areas in circular Mils. $C.M. = d^2$	Weights		Ohms per 1000 feet
			1000 feet	Mile	
0000	460.	211,600.	641.	3,382.	.051
000	410.	168,100.	509.	2,687.	.064
00	365.	133,225.	403.	2,129.	.081
0	325.	105,625.	320.	1,688.	.102
1	289.	83,521.	253.	1,335.	.129
2	258.	66,564.	202.	1,064.	.163
3	229.	52,441.	159.	838.	.205
4	204.	41,616.	126.	665.	.259
5	182.	33,124.	100.	529.	.326
6	162.	26,244.	79.	419.	.411
7	144.	20,736.	63.	331.	.519
8	128.	16,384.	50.	262.	.654
9	114.	12,996.	39.	208.	.824
10	102.	10,404.	32.	166.	1.040
11	91.	8,281.	25.	132.	1.311
12	81.	6,561.	20.	105.	1.653
13	72.	5,184.	15.7	83.	2.084
14	64.	4,096.	12.4	65.	2.628
15	57.	3,249.	9.8	52.	3.314
16	51.	2,601.	7.9	42.	4.179
17	45.	2,025.	6.1	32.	5.269
18	40.	1,600.	4.8	25.6	6.645
19	36.	1,296.	3.9	20.7	8.617
20	32.	1,024.	3.1	16.4	10.566
21	28.5	812.3	2.5	13.	13.283
22	25.3	640.1	1.9	10.2	16.85
23	22.6	510.8	1.5	8.2	21.10
24	20.1	404.	1.2	6.5	26.70
25	17.9	320.4	.97	5.1	33.67
26	15.9	252.8	.77	4.	42.68
27	14.2	201.6	.61	3.2	53.52
28	12.6	158.8	.48	2.5	67.84
29	11.3	127.7	.39	2.	84.49
30	10.	100.	.3	1.6	107.3
31	8.9	79.2	.24	1.27	136.2
32	8.	64.	.19	1.02	168.5
33	7.1	50.4	.15	.81	214.0
34	6.3	39.7	.12	.63	271.7
35	5.6	31.4	.095	.5	343.6
36	5.	25.	.076	.4	431.6

Table giving the outside diameters of rubber covered wires for use on voltages less than 600.

Size B. & S Gauge	Solid Wire Single Braid	Solid Wire Double Braid	Strand- ed Wire Single Braid	Strand- ed Wire Double Braid	Solid Twin Wire	Stranded Twin Wires
0000	47-64	54-64	52-64	59-64	54-64x101-64	59-64x111-64
000	41-64	46-64	48-64	55-64	46-64x 87-64	55-64x103-64
00	38-64	43-64	43-64	48-64	43-64x 81-64	48-64x 91-64
0	36-64	40-64	40-64	45-64	40-64x 75-64	45-64x 85-64
1	33-64	37-64	37-64	42-64	37-64x 70-64	42-64x 79-64
2	29-64	33-64	32-64	37-64	33-64x 62-64	37-64x 69-64
3	27-64	31-64	30-64	34-64	31-64x 58-64	34-64x 64-64
4	25-64	29-64	27-64	31-64	29-64x 54-64	31-64x 58-64
5	24-64	28-64			28-64x 52-64	
6	22-64	26-64	24-64	28-64	26-64x 49-64	28-64x 52-64
8	18-64	22-64	20-64	23-64	22-64x 41-64	23-64x 42-64
10	16-64	20-64	18-64	21-64	20-64x 37-64	21-64x 38-64
12	15-64	19-64	16-64	20-64	19-64x 35-64	20-64x 36-64
14	14-64	18-64	15-64	19-64	18-64x 33-64	19-64x 34-64
16	10-64	13-64			13-64x 24-64	
18	9-64	12-64			12-64x 22-64	

Table giving the outside diameters of rubber covered wires for use on Voltages between 600 and 3500.

Size B. & S. Gauge	Solid Wire Single Braid	Solid Wire Double Braid	Strand- ed Wire Single Braid	Strand- ed Wire Double Braid	Solid Twin Wire	Stranded Twin Wire
0000	49-64	56-64	53-64	61-64	56-64x105-64	61-64x114-64
000	46-64	53-64	50-64	57-64	53-64x 99-64	57-64x107-64
00	41-64	46-64	47-64	53-64	46-64x 87-64	53-64x 99-64
0	38-64	43-64	42-64	46-64	43-64x 81-64	46-64x 88-64
1	35-64	40-64	39-64	43-64	40-64x 75-64	43-64x 82-64
2	33-64	38-64	36-64	40-64	38-64x 71-64	40-64x 76-64
3	31-64	36-64	34-64	38-64	36-64x 67-64	38-64x 72-64
4	29-64	33-64	31-64	35-64	33-64x 62-64	35-64x 66-64
5	28-64	32-64			32-64x 60-64	
6	27-64	31-64	28-64	32-64	31-64x 58-64	32-64x 60-64
8	24-64	28-64	26-64	30-64	28-64x 52-64	30-64x 56-64
10	22-64	26-64	24-64	28-64	26-64x 48-64	28-64x 52-64
12	21-64	25-64	22-64	26-64	25-64x 46-64	26-64x 48-64
14	20-64	24-64	21-64	25-64	24-64x 44-64	25-64x 46-64

NOTE.—These figures are taken from data furnished by one of the largest manufacturers of wire and are believed to be of at least as great dimensions as any standard wire on the market. Judgement must be used in applying these dimensions as the same size wire B. & S. gauge, of different makes often varies considerably in outside diameter.

Outside Diameters of Rubber Covered Cables.

Capacity in Cir. Mils.	Diameter over Braid
1,500,000	113-64
1,250,000	107-64
1,000,000	97-64
950,000	95-64
900,000	94-64
850,000	93-64
800,000	89-64
750,000	87-64
700,000	83-64
650,000	81-64
600,000	79-64
550,000	76-64
500,000	73-64
450,000	68-64
400,000	66-64
350,000	64-64
300,000	61-64
250,000	59-64

Outside Diameters of Weather-proof Wire.

Size of Wire	Outside Diameters.	
	Solid	Stranded
1,000,000	-----	108-64
900,000	-----	103-64
800,000	-----	100-64
700,000	-----	94-64
600,000	-----	85-64
500,000	-----	80-64
450,000	-----	76-64
400,000	-----	73-64
350,000	-----	64-64
300,000	-----	62-64
250,000	-----	58-64
0000	50-64	55-64
000	47-64	51-64
00	39-64	43-64
0	36-64	39-64
1	32-64	35-64
2	30-64	33-64
3	27-64	30-64
4	25-64	28-64
5	22-64	24-64
6	20-64	22-64
8	17-64	18-64
10	16-64	
12	14-64	
14	12-64	
16	10-64	
18	8-64	

Dimensions of Unlined Conduit.

Nominal Internal Diam. Inches.	Actual Internal Diam. Inches.	Actual External Diam. Inches.	Thick-ness of Walls Nearest 64th
$\frac{1}{8}$	17-64	26-64	4-64
$\frac{1}{4}$	23-64	35-64	5-64
$\frac{3}{8}$	31-64	43-64	6-64
$\frac{1}{2}$	40-64	54-64	6-64
$\frac{3}{4}$	52-64	67-64	7-64
1	67-64	84-64	8-64
$1\frac{1}{4}$	88-64	106-64	9-64
$1\frac{1}{2}$	103-64	122-64	9-64
2	132-64	152-64	10-64
$2\frac{1}{2}$	157-64	184-64	13-64
3	196-64	224-64	13-64

Dimensions of Lined Conduit

Nominal Internal Diameter Inches	Actual Internal Diameter Inches	Actual External Diameter Inches
$\frac{1}{2}$	32-64	54-64
$\frac{3}{4}$	45-64	67-64
1	58-64	84-64
$1\frac{1}{4}$	80-64	106-64
$1\frac{1}{2}$	90-64	122-64
2	115-64	152-64
$2\frac{1}{2}$	144-64	184-64
3	176-64	224-64

TABLES.

DIMENSIONS OF PORCELAIN KNOBS.

Trade No.	Height	Diameters	Hole	Groove	Height of Wire
0	$2\frac{1}{4}$	3	$1\frac{1}{4}$	1	$\frac{1}{2}$
1	3	$2\frac{1}{8}$	$\frac{7}{16}$	$\frac{3}{4}$	$1\frac{3}{4}$
2	2	2	$\frac{1}{2}$	$\frac{1}{2}$	1
3	$1\frac{3}{4}$	2	$\frac{7}{16}$	$\frac{7}{16}$	$\frac{3}{4}$
$3\frac{1}{2}$	2	2	$\frac{7}{16}$	$\frac{7}{16}$	$\frac{1}{4}$
4	$1\frac{11}{16}$	$1\frac{1}{2}$	$\frac{3}{8}$	$\frac{3}{8}$	$\frac{7}{8}$
$4\frac{1}{2}$	$1\frac{7}{8}$	$1\frac{1}{2}$	$\frac{3}{8}$	$\frac{7}{16}$	1
5	$1\frac{1}{4}$	1	$\frac{1}{4}$	$\frac{5}{16}$	$\frac{3}{4}$
$5\frac{1}{2}$	$1\frac{9}{16}$	1	$\frac{1}{4}$	$\frac{5}{16}$	$\frac{1}{4}$
7	$1\frac{3}{4}$	$\frac{7}{8}$	$\frac{1}{4}$	$\frac{7}{16}$	$1\frac{1}{8}$
9	1	$\frac{5}{8}$	$\frac{3}{16}$	$\frac{3}{16}$	$\frac{3}{4}$
$10\frac{1}{2}$	$1\frac{3}{4}$	$1\frac{5}{8}$	$\frac{3}{8}$	$\frac{3}{8}$	1

DIMENSIONS OF GLASS KNOBS.

Trade Number	Height	Width	Size of Hole	Size of Groove
1	$1\frac{1}{2}$	$1\frac{1}{2}$	$\frac{3}{8}$	$\frac{3}{8}$
$1\frac{1}{2}$	$1\frac{7}{8}$	$1\frac{1}{2}$	$\frac{3}{8}$	$\frac{3}{8}$
2	$1\frac{3}{4}$	2	$\frac{3}{8}$	$\frac{9}{16}$
3	$2\frac{1}{4}$	2	$\frac{3}{8}$	$\frac{9}{16}$
7	$2\frac{3}{4}$	2	$\frac{3}{8}$	$\frac{9}{16}$
8	$3\frac{3}{4}$	$2\frac{3}{4}$	$\frac{3}{8}$	1" cable

SIZES OF PORCELAIN TUBES.

Internal Diameter Inches	Shortest Length Obtainable	Greatest Length Obtainable	Outside Diameter
$\frac{5}{16}$	$\frac{1}{2}$	24	$\frac{9}{16}$
$\frac{3}{8}$	$\frac{1}{2}$	24	$\frac{11}{16}$
$\frac{1}{2}$	1	24	$\frac{13}{16}$
$\frac{5}{8}$	1	24	$\frac{15}{16}$
$\frac{3}{4}$	1	24	$\frac{17}{16}$
1	$1\frac{1}{2}$	24	$1\frac{3}{16}$
$1\frac{1}{4}$	$2\frac{1}{2}$	24	$1\frac{7}{16}$
$1\frac{1}{2}$	$2\frac{1}{2}$	24	$1\frac{11}{16}$
$1\frac{3}{4}$	$2\frac{1}{2}$	24	$2\frac{3}{16}$
2	$2\frac{1}{2}$	24	$2\frac{7}{16}$
$2\frac{1}{4}$	$2\frac{1}{2}$	24	$2\frac{11}{16}$
$2\frac{1}{2}$	$2\frac{1}{2}$	24	$3\frac{5}{16}$
	$2\frac{1}{2}$	24	$3\frac{9}{16}$

DIMENSIONS OF MOULDINGS.

Size of Groove	Size of Wire	Size of Groove	Size of Wire
7-32	14-12 B. & S.	3-4	0-0000 Stranded
5-16	10-8 B. & S.	7-8	250.000 C. M.
13-32	6-5-4 B. & S.	1	500.000 C. M.
9-16	3-2-1-0 B. & S.	1 1-4	750.000 C. M.

MODERN ELECTRICAL CONSTRUCTION.
DIMENSIONS OF CLEATS.

ONE-WIRE CLEATS.

DUGGAN CLEAT.

No. 4 holds wires	16-8 B. & S.
No. 7 " "	6-2 "
No. 5 " "	2-00
No. 6 " "	000-300,000 C. M.
No. 8 " "	400,000-800,000 C. M.
No. 9 " "	900,000-1,200,000 C. M.

BRUNT CLEAT.

Stand. Number	Width	Length	Groove			
328	$\frac{3}{4}$	2	$\frac{3}{8}$	holds wires	16-5 B. & S
329	1	$2\frac{1}{4}$	$\frac{1}{2}$	" "	8-3
321	$\frac{13}{16}$	$2\frac{3}{4}$	$\frac{13}{16}$	" "	3-00
330	$1\frac{1}{8}$	$2\frac{1}{2}$	$\frac{1}{2}$	" "	4-1
332	$1\frac{1}{4}$	$2\frac{7}{8}$	$\frac{15}{16}$	" "	0-0000

TWO AND THREE-WIRE CLEATS.

BRUNT.

No. 334	2-wire holds wires	16-8 B. & S
No. 337	3 wire " "	16-8 B. & S

DUGGAN.

No. 3	2-wire holds wires	16-8 B. & S.
No. 2	2-wire " "	6-00 B. & S.
No. 1	3 wire " "	16-8 B. & S.

PASS & SEYMOUR.

No. A-3	2-wire holds wires	14-12 B. & S.
No. 3	2-wire " "	14- 6 B. & S
No. A-43	3-wire " "	14-12 B. & S
No. 43	3-wire " "	14- 6 B. & S.

DIMENSIONS OF IRON SCREWS. APPROXIMATE.

Trade Number	Diameter in Fractions	Nearest B. & S. Gauge	Greatest Length Obtainable
0	$\frac{7}{128}$	15	$\frac{3}{8}$
1	$\frac{19}{128}$	14	$\frac{1}{2}$
2	$\frac{5}{64}$	12	$\frac{7}{8}$
3	$\frac{7}{32}$	11	$1\frac{1}{2}$
4	$\frac{7}{64}$	9	$1\frac{1}{2}$
5	$\frac{4}{32}$	8	$2\frac{1}{2}$
6	$\frac{7}{128}$	7	3
7	$\frac{19}{128}$	7	3
8	$\frac{5}{32}$	6	4
9	$\frac{11}{64}$	5	4
10	$\frac{12}{64}$	5	4
11	$\frac{13}{64}$	4	4
12	$\frac{27}{128}$	4	6
13	$\frac{29}{128}$	3	6
14	$\frac{15}{64}$	3	6
15	$\frac{1}{4}$	2	6
16	$\frac{17}{64}$	2	6
17	$\frac{9}{32}$	1	6
18	$\frac{19}{64}$	1	6

DIMENSIONS OF COMMON NAILS. APPROXIMATE.

Trade Number	Diameter in Fractions	Nearest B. & S. Gauge	Length in Inches	No. per lb.
2d	$\frac{9}{128}$	13	1	875
3d	$\frac{5}{64}$	12	$1\frac{1}{4}$	565
4d	$\frac{7}{64}$	10	$1\frac{1}{2}$	315
5d	$\frac{7}{64}$	10	$1\frac{3}{4}$	270
6d	$\frac{7}{64}$	9	2	180
7d	$\frac{7}{64}$	9	$2\frac{1}{4}$	160
8d	$\frac{17}{128}$	8	$2\frac{1}{2}$	105
9d	$\frac{17}{128}$	8	$2\frac{3}{4}$	95
10d	$\frac{19}{128}$	7	3	70
12d	$\frac{19}{128}$	6	$3\frac{1}{4}$	60
16d	$\frac{5}{32}$	6	$3\frac{1}{2}$	50
20d	$\frac{25}{128}$	4	4	30

FINE NAILS

2d	$\frac{7}{128}$	15	1	1350
3d	$\frac{19}{128}$	13	$1\frac{1}{4}$	770
4d	$\frac{5}{64}$	12	$1\frac{1}{2}$	470

RATING OF MOTORS.
FULL LOAD CURRENTS.

H. P.	110 VOLTS	220 VOLTS	500 VOLTS
$\frac{1}{6}$	1.9	.95	.42
$\frac{1}{4}$	2.7	1.35	.62
$\frac{1}{2}$	5.	2.50	1.15
$\frac{3}{4}$	7.5	3.75	1.70
1	9.2	4.60	2.10
2	17.5	8.75	4.
3	24.6	12.30	5.60
4	32.	16.	7.50
5	40.	20.	9.20
$7\frac{1}{2}$	57.	28.5	13.
10	76.	38.	17.5
15	110.	55.	25.
20	144.	72.	34.
25	176.	88.	40.
30	210.	105.	49.
35	250.	125.	57.
40	280.	140.	65.
45	320.	160.	75.
50	350.	175.	80.
60	430.	215.	100.
75	520.	260.	120.
100	700.	350.	160.
125	880.	440.	210.
150	1056.	530.	245.
175	1230.	615.	280.
200	1400.	700.	325.

RATING OF INCANDESCENT LAMPS.

110 VOLTS			220 VOLTS		
C. P.	Watts	Amperes	C. P.	Watts	Amperes
4	18	.16	8	36	.16
6	24	.22	10	45	.20
8	30	.27	16	64	.29
10	35	.32	20	76	.35
12	40	.36	24	90	.41
16	56	.51	32	122	.55
20	70	.64	50	190	.86
24	84	.76			
32	112	1.00			
50	175	1.60			

The Hewitt-Cooper Mercury Vapor lamp requires a current of about 2.5 amperes.

The Nernst lamp consumes 88 watts per glower; for a 6 glower, 110 volt lamp, about 4.8 amperes.

Series miniature lamps, operated 8 in series, on 110 volts, require a current of about .33 amperes for 1 candle power lamps, and 1 ampere for 3 candle power lamps.

Tables showing the currents which will fuse wires of different substances.

B. & S. Gauge	Diam.	Copper	Aluminum	German Silver	Iron
10	102.	333.	246.5	170.	102.3
12	81.	236.	174.4	120.5	72.6
14	64.	165.7	122.8	84.6	50.9
16	51.	117.7	87.1	60.1	36.1
18	40.	81.9	60.7	41.8	25.2
20	32.	58.5	43.4	29.9	18.
22	25.3	41.1	30.5	21.0	12.4
24	20.	28.9	21.5	14.8	8.9
26	16.	20.7	15.3	10.6	6.4
28	12.6	14.5	10.7	7.4	4.5
30	10.	10.2	7.6	5.2	3.1
32	8.	7.3	5.4	3.7	2.3
34	6.3	5.1	3.8	2.6	1.6
36	5.	3.6	2.7	1.8	1.1

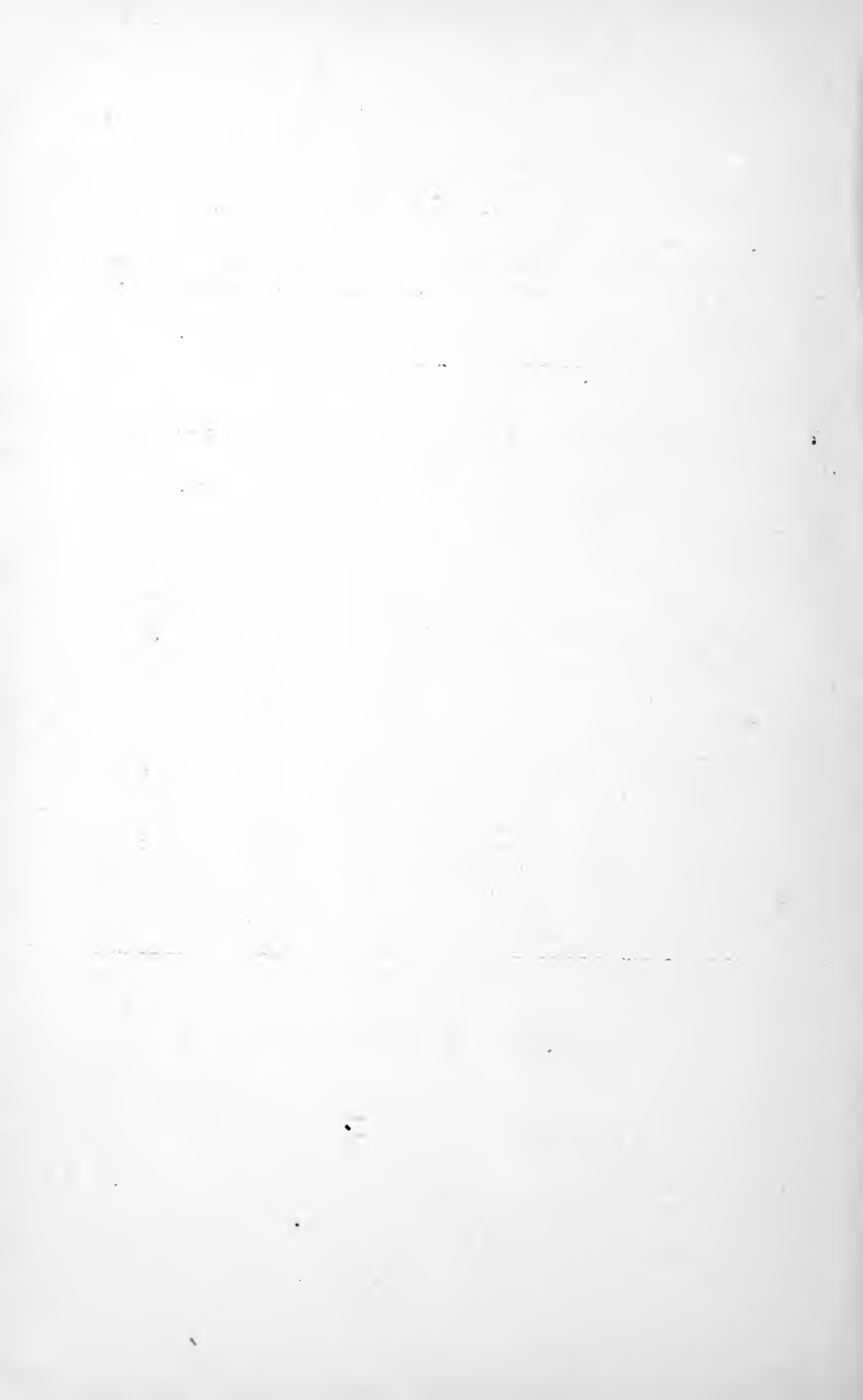

INDEX.

Acid fumes	89-161
Alternating current system	35
Amperes	13
Arc lamps, construction of	283
Arc lamps, installation of	127-132-197
Armored cable, construction of	249
Armored cable, installation of	168-173
Armored cable, metallic sheaths to be grounded...	95-173
Attendance	69
Auto-starters	78
Balancing coils on three-wire systems. (See Reactive Coils.)	
Base frames, generators and motors.....	47-73
Batteries, storage and primary	27-89
Bells	19
Bell wires	288
Blocks at fixtures and switch outlets.....	150
Bonds, rails in car houses	234
Boxing, where necessary	131-158-235
Burglar alarms	288
Burrs and finns, fixture work	190
Bushings at entrance to building.....	94-289
Bushings for wires	116-255
Bushings, lamp sockets	196
Bus bars	60-63
Cabinets, construction of	125-127-148-177-275
Cabinets, use of	125-144-147-177
Cabinets for rheostats and auto-starters.....	78
Cable, armored	249
Calculation of wires	40
Canopy insulators	187
Car wiring and equipment	225
Car houses	233
Care and attendance	69
Carrying capacity table	332

Ceiling fans	87-189
Ceiling rosettes, construction of.....	276
Ceiling rosettes, use of.....	145
Central stations	47
Changes in rules	302
Choke coils	67
Circuit breaker, construction of	264
Circuit breaker, installation of	50-76-84-88-124-134-146
Circuit breaker, how high may be set	146
Circuit, open	9
Circuit, closed	9
Circuit, divided	16
Circular mil	40
Cleats	256
Compensator coils	198
Concealed wiring	116-151-155-158
Concentric wire	248
Condensers	286
Conductors	10
Conductors. (See Wires.)	
Conduits, installation of	174
Conduits, metal, construction of	250
Conduits, wire for	248
Conduit work	166-174
Constant current systems	32-121
Constant potential systems	33-134
Converters. (See Transformers.)	
Convertible wiring systems	143
Coulomb	13
Crane wiring	319
Crossing of constant potential pole lines over 5,000 volts	98
Currents	7-13
Currents for motors	75-328
Cutout cabinets. (See Cabinets.)	
Cutouts, construction of	264
Cutouts, installation of	124-134-145
Cutouts, must protect all wires of the circuit.....	124
Damp places	121-126-161-193
Decorative lighting systems	198
Distance between conductors, inside	131-159-168-235
Distance between conductors, outside.....	91
Divided circuits	16
Drip loops at service entrance	94-137

Dynamo rooms	47
Economy coils	198
Electric bells	19
Electric gas lighting	293
Electric heaters	152
Electrolytic corrosion of underground metal work....	96
Electrolysis	96-118
Electro-magnetic devices for switches.....	134
Electro-motive force	11
Electro-plating	10
Elevator shafts, wires in	123
Equalizers	64
Extra high potential systems	236
Fan motors hung from ceilings	87-189
Feeders, railway	233
Fished wires	156-168
Fittings and materials	238
Fixtures	187
Fixtures, canopies	187
Fixture wire	247
Fixture wiring	173
Flexible cord, construction of	244
Flexible cord, construction of, heaters.....	246
Flexible cord, construction of, pendants.....	244
Flexible cord, construction of, portables.....	245
Flexible cord, use of	195
Flexible tubing, construction of	257
Flexible tubing, where permitted	168
Foreign currents, protection against	288
Formula for soldering fluid	113
Fuses, construction of	269
Fuses, installation of	134-145-327
Fuse protection for generators	50
Gas lighting, electric	293
Generators	47
Ground connections	103-182
Ground connections for transformers	104
Ground detectors	61-69
Ground plates, construction of	108
Ground return wires, trolley systems.....	96
Ground wire for lightning arresters.....	67-288
Grounded trolley circuits	96

Grounding interior conduits	182
Grounding low potential circuits	106
Grounding of dynamo and motor frames.....	47-73
Grounding sheaths of cable	95
Grounds, testing for	69
Guards, irons or wires, use of	93-96-98
Guard strips, inside work, where required.....	131-158
Hanger boards, construction of	282
Hanger boards, when not used	133
Heaters, electric	152
High constant potential systems	234
Incandescent lamps as resistance.....	66-198
Incandescent lamps in series circuits.....	134-236
Incandescent lamps, where inflammable gas exists....	193
Induced currents	26
Induction coil	25
Inside work	110
Insulated platforms at high potential machines....	47-73
Insulating joints, construction of.....	283
Insulating joints, when required	187
Insulation of fixture canopies, when required.....	187
Insulation of trolley wires	96
Insulation resistance	71-294
Insulators	10-111
Insulator spacing, inside work.....	131-159-168-235
Interior conduits. (See Conduits.)	
Joints in conductors	94-112
Joints, insulating. (See Insulating Joints.)	
Junction boxes	174
Junction boxes, conduit, installation of.....	174-183
Knob and tube work	110
Knots in flexible cord required in sockets and rosettes.	196
Lamps, arc. (See Arc Lamps.)	
Lamps, incandescent, rating of.....	328
Lightning arresters, construction of	287
Lightning arresters, installation of	66
Lights from trolley circuits	234
Loop system	169
Loss in voltage	36
Low potential systems	155
Lugs for terminal connections, when required.....	
.....	113-259-266-268-284

Magnets	9
Marine work	295
Mechanical injury, protection against	131-158-235
Mercury vapor lamps	314
Mils, definition of	40
Motors	73
Motors, enclosure for	86
Moulding, construction of	254
Moulding work	156-163-186
Moving picture machines	293
Multiple-series systems	85
Neutral wire	33
Ohms	12
Ohm's law	13
Oily waste	69
Open wiring	159
Outlet and switch boxes, construction of	252
Outlet boxes or plates, conduit, when required....	173-179
Outline lighting	316
Outside work	91
Panel boards, construction of	274
Picture moving machines	293
Pole lines	95
Pole line, constant potential, over 5,000 volts.....	97
Pole lines, high pressure, near buildings	102
Portable conductors	195
Portable lamps, installation of	195
Power	14
Power from trolley circuits	234
Power, transformer and switch stations	47
Protection for gas outlet pipes	187
Protective devices on signal circuits, construction of..	291
Protective devices on signal circuits, installation of...	289
Practical hints	323
Railway power plants	88
Railway wires. (See Trolley Wires.)	
Reactive coils	286
Receptacles. (See Sockets.)	
Reinforcing wires	142
Resistance	12-17-41
Resistance boxes. (See Rheostats.)	
Resistance for arc lamps, low potential	198
Rheostats, construction of	284
Rheostats, installation of	64-78

Roof wiring	92
Rosettes, construction of	276
Rosettes, use of	145
Running boards, construction of.....	158
Sag in outside wires.....	93
Series arc system	32-127
Series incandescent lamps.....	236
Series-multiple system	35-85
Service blocks and wires	91
Service switches	146-148
Service wires, underground	123
Signaling systems	288
Sockets, construction of	278
Sockets, installation of	193
Soldering fluid, formula	113
Soldering stranded wires	113
Spark arresters, construction of.....	283
Spark arresters, when required	132-198
Speed controller	83
Square mil	40
Starting boxes	64-78
Static electricity, overcoming	50-73
Stations and dynamo rooms	47
Storage battery rooms	89
Switchboards	62
Switch boxes, conduit, construction of.....	252
Switches, construction of, knife	258
Switches, construction of, snap	261
Switches, electro-magnetic	134
Switches, flush, installation of	150
Switches, installation of	146
Switches, when may be single pole.....	76-148
Switches, time	127
Systems, alternating current	35
Systems, constant current	32-127
Systems, constant potential, general rules.....	134
Systems, extra high constant potential.....	236
Systems, high constant potential.....	234
Systems, low constant potential	155
Systems, multiple-series	85
Systems of wiring	32
Systems, series-multiple	85

Systems, signalling	288
Tables	335 to 349
Tablet boards	274
Telegraph, telephones and other signal circuits.....	288
Telephones	23
Testing	69-190-323
Theater wiring	199
Three-wire system	136-143-155-324
Transformers, grounding of secondary	107
Transformers, installation of, inside	90-103-235
Transformers, installation of, outside	103
Transformers, oil and air cooled.....	315
Transformer stations	47
Transmission, electric	36
Transmission lines, constant potential, over 5,000 volts	97
Tree system of wiring.....	139
Tricks of the trade	330
Trolley wires	96
Tubes, insulating	116-255
Underground conductors	123
Vacuum tube systems	314
Volt	11
Voltmeter, switchboard, circuit for	61
Waterproof construction	161
Waterproof pendants	194
Watt	15
Wire, concentric	248
Wire conduit	248
Wire, construction, general rules	238
Wire, fixtures	247
Wire netting required on arc lamps	132-168-198
Wire, rubber covered	238
Wire, slow burning	243
Wire, slow burning, weatherproof	242
Wire, weatherproof	243
Wires, calculation of	40
Wires, car work	225
Wires, carrying capacity table	332
Wires, central station	60
Wires, concealed knob and tube work	168
Wires, conduit work	166-248
Wires, constant current systems	127
Wires in parallel	142
Wires in stations and dynamo rooms	61

Wires, number in conduit	328
Wires, extra high potential	236
Wires, finished	156-168
Wires, fixture work	247
Wires, low potential, general rules	155
Wires, high potential	234
Wires, inside, constant current	127
Wires, inside, general rules	110
Wires, moulding work	163
Wires, open work, damp places	161
Wires, open work, dry places	159
Wires, outside, overhead	91
Wires, service	91
Wires, signal	288
Wires, trolley	96
Wires, underground	123
Wiring systems	32-143
Wiring tables	333

THE KING OF ALL—The Companion Volume to Modern
Wiring Diagrams—Just from the Press

Electrical Wiring and Construction Tables

By Henry C. Horstmann and Victor H. Tousley

Contains hundreds of easy up-to-date tables covering everything on
Electric Wiring. Bound in full Persian Morocco.
Pocket size. Round corners, red edges.

PRICE, NET, \$1.50

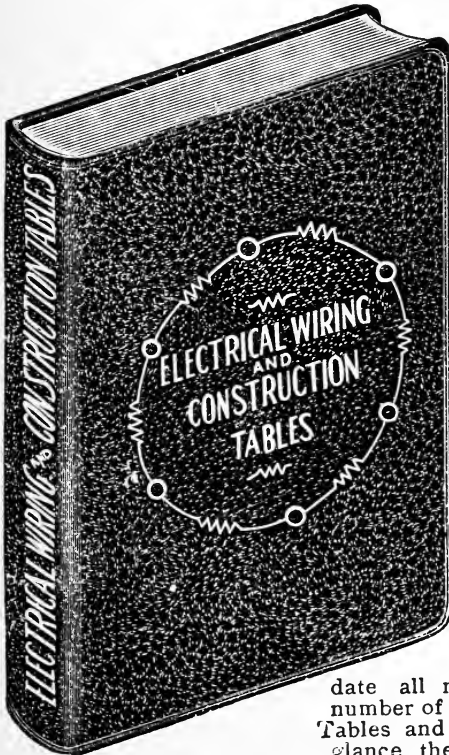

Partial Table of Contents

*This Book contains
among others:*

Tables for direct current calculations.

Tables for alternating current calculations.

These tables show at a glance the currents required with any of the systems in general use, for any voltage, efficiency, or power-factor, and by a very simple calculation (which can be mentally made), also the proper wire for any loss.

Tables showing the smallest wire permissible with any system or number of H. P. or lights under "National Electrical Code" or Chicago rules. Very convenient for contractors.

Tables for calculating the most economical loss.

Tables and diagrams showing proper size of conduits to accommo-

date all necessary combinations or number of wires.

Tables and data for estimating at a glance the quantity of material required in different lines of work.

AS this is intended for a pocket-hand-book everything that would make it unnecessarily cumbersome is omitted. There is no padding. Every page is valuable and a time saver. This book will be used every day by the wireman, the contractor, engineer and architect. All parts are so simple that very little electrical knowledge is required to understand them.

Sent, all charges paid to any address, upon receipt of price.

FREDERICK J. DRAKE & CO., Publishers,

Chicago

DYNAMO TENDING

for

ENGINEERS

Or, ELECTRICITY
FOR STEAM ENGINEERS

By HENRY C. FORSTMANN and
VICTOR H. TOUSLEY,
Authors of "Modern Wiring Diagrams and
Descriptions for Electrical Workers."

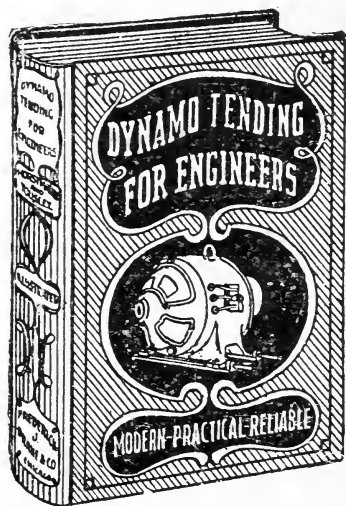

This excellent treatise is written by engineers for engineers, and is a clear and comprehensive treatise on the principles, construction and operation of Dynamos, Motors, Lamps, Storage Batteries, Indicators and Measuring Instruments, as well as full explanations of the principles governing the generation of alternating currents and a descrip-

tion of alternating current instruments and machinery. There are perhaps but few engineers who have not in the course of their labors come in contact with the electrical apparatus such as pertains to light and power distribution and generation. At the present rate of increase in the use of Electricity it is but a question of time when every steam installation will have in connection with it an electrical generator, even in such buildings where light and power are supplied by some central station. It is essential that the man in charge of Engines, Boilers, Elevators, etc., be familiar with electrical matters, and it cannot well be other than an advantage to him and his employers. It is with a view to assisting engineers and others to obtain such knowledge as will enable them to intelligently manage such electrical apparatus as will ordinarily come under their control that this book has been written. The authors have had the co-operation of the best authorities, each in his chosen field, and the information given is just such as a steam engineer should know,

To further this information, and to more carefully explain the text, nearly 100 illustrations are used, which, with perhaps a very few exceptions, have been especially made for this book. There are many tables covering all sorts of electrical matters, so that immediate reference can be made without resorting to figuring. It covers the subject thoroughly, but so simply that any one can understand it fully. Any one making a pretense to electrical engineering needs this book. Nothing keeps a man down like the lack of training; nothing lifts him up as quickly or as surely as a thorough, practical knowledge of the work he has to do. This book was written for the man without an opportunity. No matter what he is, or what work he has to do, it gives him just such information and training as are required to attain success. It teaches just what the steam engineer should know in his engine room about electricity.

12mo, Cloth, 100 Illustrations. Size $5\frac{1}{2} \times 7\frac{3}{4}$. PRICE NET **\$1.50**
Sold by booksellers generally, or sent, all charges paid, upon receipt of price

FREDERICK J. DRAKE & CO., Publishers
CHICAGO, ILL.

Easy Electrical Experiments and How to Make Them

By L. P. DICKINSON

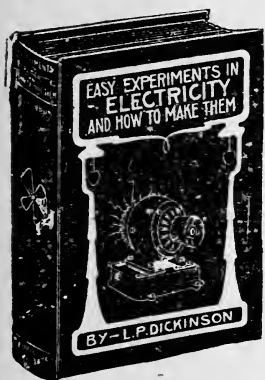

This is the very latest and most valuable work on Electricity for the amateur or practical Electrician published. It gives in a simple and easily understood language every thing you should know about Galvanometers, Batteries, Magnets, Induction, Coils, Motors, Voltmeters, Dynamos, Storage Batteries, Simple and Practical Telephones, Telegraph Instruments, Rheostat, Condensers, Electrophorous, Resistance, Electro Plating, Electric Toy Making, etc.

The book is an elementary hand book of lessons, experiments and inventions. It is a hand book for beginners, though it includes, as well, examples for the advanced students. The author stands second to none in the scientific world, and this exhaustive work will be found an invaluable assistant to either the student or mechanic.

Illustrated with hundreds of fine drawings; printed on a superior quality of paper.

12mo Cloth. Price, \$1.25.

Sent postpaid to any address upon receipt of price

FREDERICK J. DRAKE & CO., Publishers,
CHICAGO, ILL.

ALL TECHNICAL TERMS AVOIDED

Practical Telephone Hand Book and Guide to Telephonic Exchange

HOW TO CONSTRUCT AND MAINTAIN TELEPHONE LINES

By T. S. BALDWIN, M. A. Illustrated.

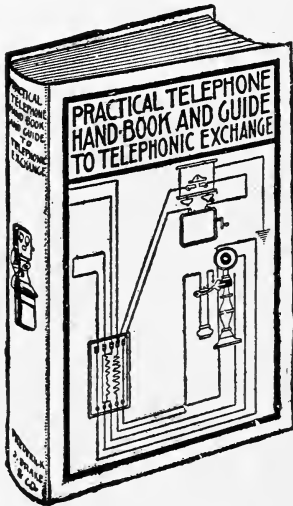

Containing chapters on "The Use of the Telephone, Series and Bridging Phones, Line Construction, Materials to be used, Locating and Correction of Faults in Instruments and Lines."

This is the best book ever published on Farm Telephones and has been the sensation of the past year in telephone circles. It is the only book ever issued which treats the subject exhaustively and comprehensively. It is of inestimable value to promoters of rural party lines, because it contains all of the arguments that are necessary to show the advantages of rural party lines. It also tells how such lines should be constructed and cared for.

The great growth of the telephone industry during the past few years, and in response to the demand for a comprehensive book, giving a clear, terse idea of the different principles governing the construction, installation, care and management of the various telephones and their appliances, the Practical Telephone Hand Book has been compiled. It is written in a most clear and careful style and aims to give a complete review of the subject of telephony.

No expense has been spared in gathering valuable information, and it has been the aim of the author to make this treatise the most complete elementary book ever written on this subject for all persons interested in this great achievement of modern science.

The text is profusely illustrated by cuts of commercial apparatus and carefully prepared diagrams of circuits. No diagram is given without a full explanation. The apparatus and methods used in making all the tests required in commercial telephone work, including the exchange, are fully treated.

Price, \$1.00 Postpaid.

FREDERICK J. DRAKE & CO.

CHICAGO.

**JUST THE BOOK FOR BEGINNERS AND ELECTRICAL WORKERS
WHOSE OPPORTUNITIES FOR GAINING INFORMATION ON
THE BRANCHES OF ELECTRICITY HAVE BEEN LIMITED**

ELECTRICITY

Made Simple

BY CLARK CARYL HASKINS

**A BOOK DEVOID OF
TECHNICALITIES
SIMPLE, PLAIN AND
UNDERSTANDABLE**

There are many elementary books about electricity upon the market but this is the first one presenting the matter in such shape that the layman may understand it, and at the same time, not written in a childish manner.

**FOR ENGINEERS, DYNAMO MEN,
FIREMEN, LINEMEN, WIREMEN AND
LEARNERS. FOR STUDY OR
REFERENCE.**

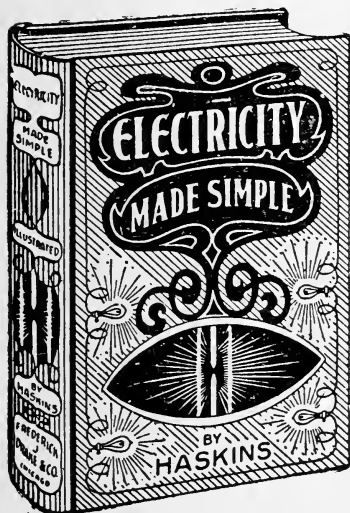

This little work is not intended for the instruction of experts, nor as a guide for professors. The author has endeavored throughout the book to bring the matter down to the level of those whose opportunities for gaining information on the branches treated have been limited.

Four chapters are devoted to Static Electricity; three each to Chemical Batteries and Light and Power; two each to Terrestrial Magnetism and Electro-Magnetism; one each to Atmospheric Electricity; Lightning Rods; Electro-Chemistry; Applied Electro-Magnetism; Force, Work and Energy; Practical Application of Ohm's Law; also a chapter upon Methods of Developing Electricity, other than Chemical.

The large number of examples that are given to illustrate the practical application of elementary principles is gaining for it a reputation as a text book for schools and colleges.

In reviewing this book an eminent electrician says of it:

"All that 999 men out of 1000 want to know can be imparted in plain language and arithmetic. I therefore think that such a book as yours is the kind that does the greatest good to the greatest number."

12mo, Cloth, 233 Pages, 108 Illustrations **PRICE Net \$1.00**

For Sale by booksellers generally or sent postpaid to any address upon receipt of price,

FREDERICK J. DRAKE & CO., Publishers
CHICAGO, ILL.

THE MOST IMPORTANT BOOK ON ELECTRICAL CONSTRUCTION
WORK FOR ELECTRICAL WORKERS EVER PUBLISHED.

REVISED AND ENLARGED EDITION

MODERN WIRING DIAGRAMS AND DESCRIPTIONS

A Hand Book of practical diagrams and
information for Electrical Workers.

By HENRY C. HORSTMANN and
VICTOR H. TOUSLEY
Expert Electricians.

**This grand little volume not only tells
you how to do it, but it shows you.**

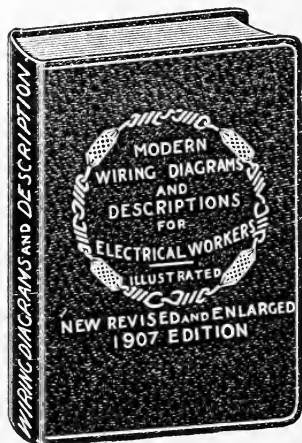

The book contains no pictures of bells,
batteries or other fittings; you can see
those anywhere.

It contains no Fire Underwriters' rules;
you can get those free anywhere.

It contains no elementary consider-
ations; you are supposed to know what
an **ampere**, a **volt** or a "short circuit"
is. And it contains no historical matter.

All of these have been omitted to make
room for "**diagrams and descriptions**"
of just such a character as **workers** need.
We claim to give all that ordinary elec-
trical workers need and nothing that they
do not need.

It shows you how to wire for call and alarm bells.

For burglar and fire alarm.

How to run bells from dynamo current.

How to install and manage batteries.

How to test batteries.

How to test circuits.

How to wire for annunciators; for telegraph and gas lighting.

It tells how to locate "trouble" and "ring out" circuits.

It tells about meters and transformers.

It contains 30 diagrams of electric lighting circuits alone.

It explains dynamos and motors; alternating and direct currents.

It gives ten diagrams of ground detectors alone.

It gives "**Compensator**" and storage battery installation.

It gives simple and explicit explanation of the "**Wheatstone**" Bridge
and its uses as well as volt-meter and other testing.

It gives a new and simple wiring table covering all voltages and all
losses or distances.

16mo., 160 pages, 200 illustrations; full leather binding,
round corners, red edges. Size 4x6, pocket edition. PRICE

\$1.50

Sold by booksellers generally or sent postpaid to any address
upon receipt of price.

FREDERICK J. DRAKE & CO., Publishers
CHICAGO, ILL.

Practical Telephone Testing

By W. G. and D. R. MIDDLETON

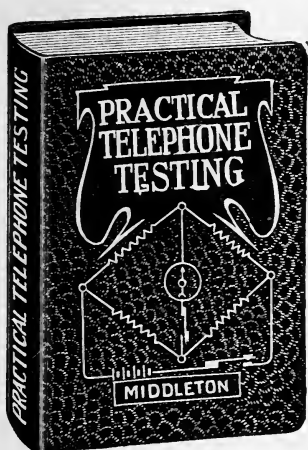

WHILE many of the tests incorporated in this book have hitherto been treated technically, this work explains in detail the practical methods in common use and in such a way that the men in charge of apparatus and lines can readily understand and make the tests.

A detailed description is given of Telephone and Telegraph lines, circuits and apparatus and of the principles and use of modern testing equipment.

The errors commonly made in testing are guarded against and the reasons for using certain methods for speed, accuracy and the elimination of errors, are fully shown.

Information indispensable to the wire chief, including the testing of Toll and Rural lines and Magneto, Central Battery and Automatic Switchboards is given. All standard testing apparatus is illustrated in detail so that there is no chance of failure in following the instructions.

There is a chapter on the calibration of instruments and several chapters are given to cable testing, presenting original and unpublished methods of locating faults.

The chapter on voltmeter testing is well worth the price of the book and no one in charge of electrical lines or apparatus should be without a copy.

An effort has been made to present the matter in logical sequence so that even the inexperienced reader can successfully make valuable fault locations.

The book was written after years of practical experience and situations commonly encountered are outlined. It is profusely illustrated with photographs of apparatus, circuit drawings and diagrams of tests. These drawings are so made that the principles of the tests are obvious and in many cases it will not be necessary to refer to the text.

Formulas have been simplified and each step of the derivation is carefully explained. A little practice in the manipulation of testing apparatus after a thorough comprehension of the principles set forth in this treatise will satisfactorily equip one for testing work.

**Sold by booksellers generally or sent postpaid
to any address upon receipt of price :: :: ::**

**16mo. Full Leather. Round Corners. Red
Edges. Pocket Size :: :: :: :: Price, \$1.50**

FREDERICK J. DRAKE & CO.

PUBLISHERS :: :: :: CHICAGO, ILLINOIS

ELEMENTARY ELECTRICITY

UP TO DATE

By SIDNEY AYLMER-SMALL, M. A. I. E. E.

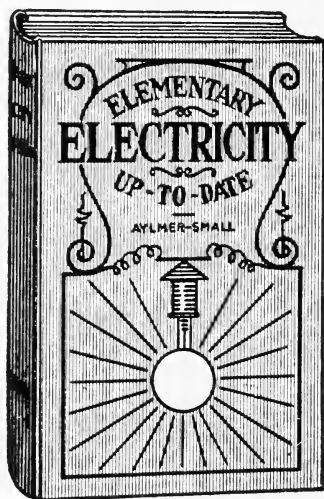

THIS book opens up the way for anyone who desires an accurate and complete knowledge of electricity as a useful agent, in the hands of man, for the transmission of mechanical energy, and the creation of light.

In addition to opening up the way as referred to above, the book also serves as a guide and instructor to the seeker after knowledge along these lines.

Beginning in the form of a simple catechism on the primary aspects of the subject it conducts the student by easy stages through the various aspects of static electricity, the different types of apparatus for producing it, all of which are plainly described and

illustrated and their action made plain and easy of comprehension.

Quite a large space is devoted to this important topic, although no more than is actually necessary, as the subjects of condensers and simple electrical machines are also thoroughly handled, and the principles governing their action clearly explained and illustrated. The subject of atmospheric electricity is next dealt with, and lightning arresters treated upon, especially in their relation to electric power stations, sub-stations and line wires. The wonderful and mysterious subject of magnetism is next treated upon at length and clearly explained—the explanations being accompanied by illustrations.

Primary batteries of all types, storage batteries and the effects of electrolysis each and all receive a large share of attention. Electric circuits and the laws governing the flow of current, including Ohm's law, are all clearly explained. The student has now arrived at the point where electrical work, power and efficiency is the topic, and where the generation and transmission of electrical currents of high potential and large volume are explained.

Sold by booksellers generally or sent postpaid to any address upon receipt of price.
12mo. Cloth, 500 Pages, Fully Illustrated : Price, \$1.00

FREDERICK J. DRAKE & CO.
PUBLISHERS : : : : CHICAGO, ILLINOIS

THE AUTOMOBILE HAND-BOOK

OVER 100,000 SOLD

By ELLIOTT BROOKES, Assisted by Other Well-Known Experts

Revised and Enlarged 1911 Edition—The largest and most practical work published. Used by all up-to-date automobile schools as their every-day text-book. 16mo, over 650 pages and over 320 illustrations. Full Leather Limp, Round Corners, Red Edges. Price, \$2.00.

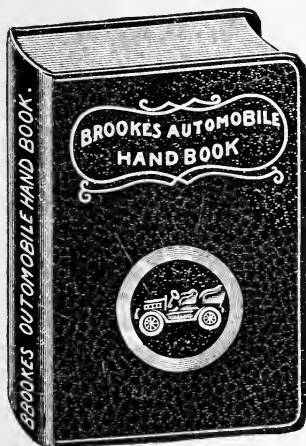

At the present time nearly all automobile troubles or breakdowns may, in almost every case, be traced to the lack of knowledge or carelessness of the owner or operator of the car, rather than to the car itself.

The automobile hand book is a work of practical information for the use of owners, operators and automobile mechanics, giving full and concise information on all questions relating to the construction, care and operation of gasoline and electric automobiles, including road troubles, motor troubles, carbureter troubles, ignition troubles, battery troubles, clutch troubles, starting troubles. With numerous tables, useful rules and formulæ, wiring diagrams and over 320 illustrations.

Special efforts have been put forth to treat the subjects of ignition, and ignition devices, in a manner befitting their importance. A large section has been devoted to these subjects, including batteries, primary and secondary, magnetos, carburetors, spark plugs, and in fact all devices used in connection with the production of the spark. Power transmission is thoroughly discussed, and the various systems of transmitting the power from the motor to the driving axle are analyzed and compared.

The perusal of this work for a few minutes when troubles occur, will often not only save time, money, and worry, but give greater confidence in the car, with regard to its going qualities on the road, when properly and intelligently cared for.

A WORD TO THE WISE

The time is at hand when any person caring for and operating any kind of self-propelling vehicle in a public or private capacity, will have to undergo a rigid examination before a state board of examiners and secure a license before they can collect their salary or get employment.

Already New York State has enacted such a law and before long, with a positive certainty every state in the Union will pass such an ordinance for the protection of life and property.

Remember this is a brand new book from cover to cover, just from the press—1911 Edition—and must not be confounded with any former editions of this popular work.

Sent prepaid to any address upon receipt of price

FREDERICK J. DRAKE & CO., Publisher

1325 Michigan Avenue, . . . CHICAGO, U. S. A.

The Automobile Mechanician's Catechism

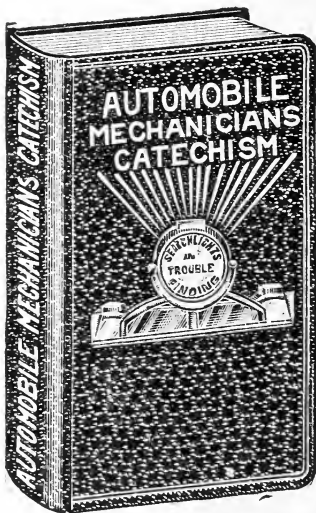

Over 400 Questions and Answers. Illustrated with three large folding charts with all parts fully and correctly numbered.

By
CALVIN F. SWINGLE, M. E.
Pocket Edition, 16mo. Full Leather, Round Corners, Red Edges, Stamped in Gold. Over 100 Pages.

Price, \$1.25

Adapted for use in the technical school, the work shop, or on the road. The questions asked and the answers given in this catechism will be found to be an indispensable guide to quicker and better work by the automobile student, no matter whether that work be in the school, the shop, on the road or before the examining board of engineers.

The subject matter is not made up of cuts and advertising eulogies from the catalogues of manufacturers and dealers, but consists of a plain, practical course of instruction, containing at the same time sufficient theory to enable the student to become thoroughly familiar with the basic principles controlling the design, construction and operation of modern automobiles of all types, whether gasoline, electric, or steam driven. The questions and answers have been carefully compiled, and they are presented in a clear and concise form, covering every detail of automobile work; a reliable instructor and assistant to the student and mechanic, while to the chauffeur the book is a most valuable guide and helper, giving correct method for handling the machine under all conditions of service, and what to do in case of breakdowns. The demand for skilled mechanics in the field of automobile work is constantly increasing, and especially so regarding the operation of the machines, quite a number of the states and larger cities already having rigid laws requiring chauffeurs to undergo a strict examination before a board of mechanical experts before being licensed as automobile chauffeurs or drivers.

Sent prepaid to any address upon receipt of price.

FREDERICK J. DRAKE & CO., Publishers
1325 Michigan Avenue - - CHICAGO, U. S. A.





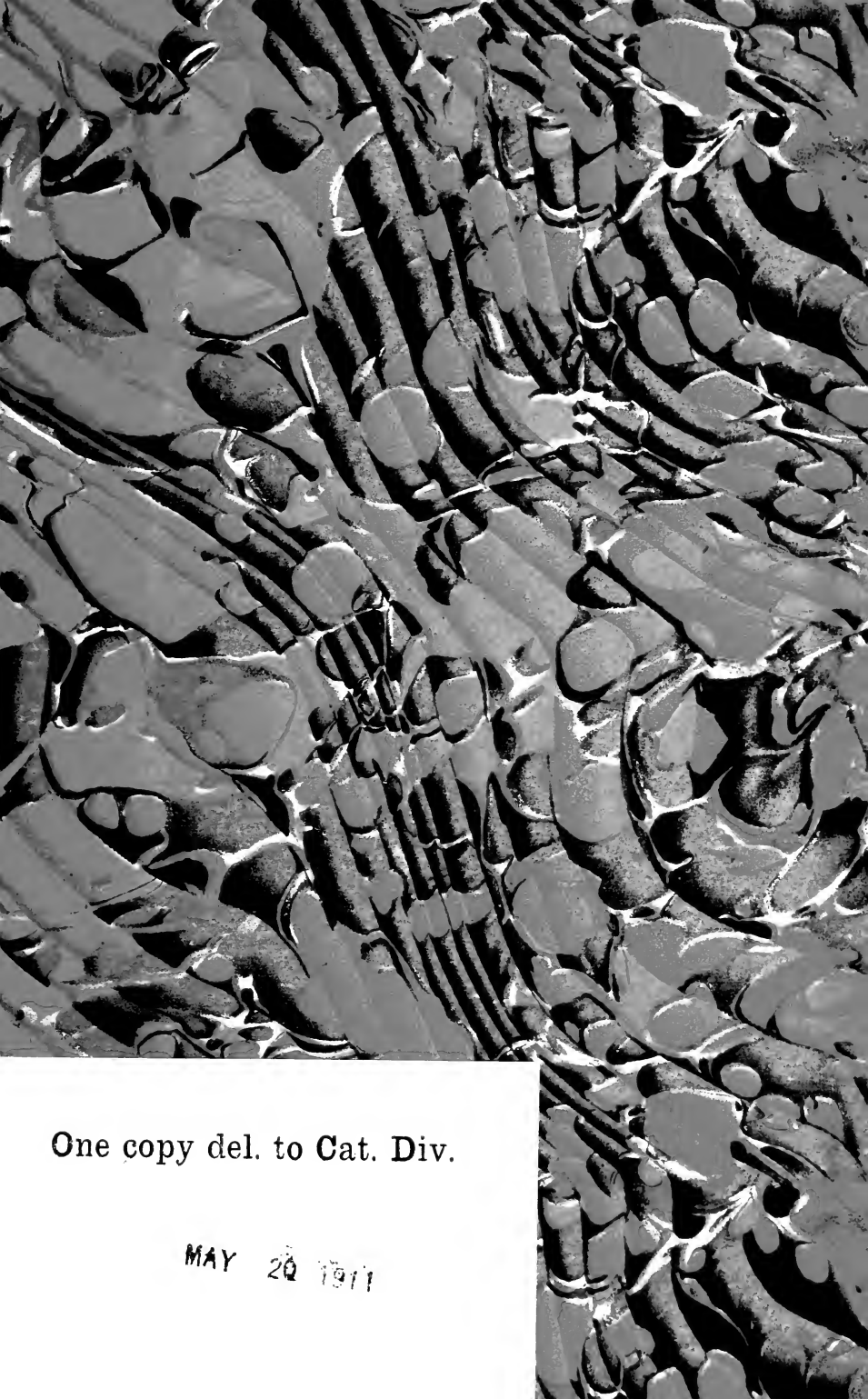

One copy del. to Cat. Div.

MAY 20 1971

LIBRARY OF CONGRESS



0 021 225 291 8