BRNO 98

Bolt Action Rifle

WARNING & INSTRUCTION MANUAL

European American Armory Corp.
3855 North U.S. Highway One
Cocoa, Florida 32926
(321) 639-4842
www.eaacorp.com
E-mail: eaacorp@bv.net

EAA MODEL: BRNO 98

Bolt Action Rifle

WARNING AND INSTRUCTION MANUAL

PLEASE READ THESE INSTRUCTIONS

MODEL NUMBER	BARREL LENGTH	CALIBERS	FINISH
BRNO 98	23.6 Inches	7.62 X 39, 308, 243 222, 223, 30-06 270, 7mm, 300WM	BLUE

GENERAL INFORMATION:

Weight (average) - 6.9 Lbs.
Overall Length - 44.5 Inches

FOR YOUR SAFETY AND THE SAFETY OF OTHERS, this owner's manual contains important warnings and safety procedures which must be understood BEFORE using this firearm. Read the entire manual and if you do not understand any part of it or the operation of your Bolt Action Rifle, stop and seek professional firearms instructions. You can get a copy of this manual from European American Armory Corp. on request.

Record the serial number of your firearm

and a description of it:

Make a copy of this manual, proof of purchase/sales record for safekeeping in a secure safe or fireproof container. Such proof is necessary if the firearm is stolen or for warranty repair. Before handling any firearm, make sure you know the safety procedures and most importantly, keep the firearm pointed in a safe direction.

WARNING

****YOU RISK INJURY OR DEATH BY HANDLING THIS FIREARM****

Before handling this firearm, read, understand and follow the instructions in this manual. Always keep this manual with the firearm. If you lend, give or sell this firearm, be sure the manual goes with it. If there is anything you do not understand, seek advice from someone qualified in safe handling of firearms.

WARNING

This firearm should always be transported and stored unloaded in its case.

Type Of Ammunition To Be Used:

It is suggested that high quality commercially manufactured ammunition be used in this firearm. Some factory ammunition works better than others and you should stick with the brand you find works well in your Bolt Action Rifle. Avoid military surplus or hot loaded ammo. The use of reloaded, high pressure or hand loaded ammunition will void the warranty.

NOTICE

BOLT ACTION RIFLES ARE CLASSIFIED AS FIREARMS OR DANGEROUS WEAPONS and are sold by European American Armory Corporation with the specific understanding that we are not responsible in any manner what-so-ever for their safe handling or resale under local laws and regulations.

European American Armory shall not be responsible in any manner whatsoever for malfunctioning of the firearm, for physical injury or for property damage resulting in whole or in part from (1) intentional or negligent discharge, (2) improper or careless handling, (3) unauthorized modifications and/or alteration to the internal/safety mechanisms, (4) defective, improper, high pressure, hand-loaded, or reloaded ammunition, (5) corrosion and/or lack of proper maintenance (6) neglect, or (7) other influences beyond our direct and immediate control. This limitation applies regardless of whether liability is asserted on the basis of contract, negligence or strict liability (including any failure to warn). Under no circumstance shall European American Armory Corporation be liable for incidental or consequential damages, such as loss of use of property, commercial loss and loss of earnings or profits.

Safety Procedures:

1. We recommend that you get competent firearms instruction in safe handling before using this firearm. Please ask your dealer. All guns are extremely dangerous if carelessly handled or used. Remember that the firearm user is the primary "safety" and to depend on any mechanical devices is to be only half safe.
2. This firearm will fire if a cartridge is in the chamber and the trigger is pulled and the safety is disengaged.

3. DO NOT LOAD THIS BOLT ACTION RIFLE UNTIL YOU UNDERSTAND HOW THIS BOLT ACTION RIFLE OPERATES. KEEP this Bolt Action Rifle unloaded at all times except when ready to fire and you are sure of your target.

4. ALWAYS carry this Bolt Action Rifle in a case or original box unloaded.

5. NEVER point this Bolt Action Rifle at anything that is not your intended target even if this Bolt Action Rifle is unloaded. When loading, cleaning, unloading or handling, always be sure the muzzle is pointed in a safe direction and always keep your finger off the trigger.

6. NEVER assume any gun is unloaded. Before handling, check to make sure the chamber is empty. See unloading Instructions and then unload any ammunition. Make sure you know that this or any firearm is fully unloaded before displaying or handling it. When handling any firearm, keep your fingers away from the trigger at all times until you intend to fire.

7. **WARNING:** The actual firearm does not contain any lead; however, it does fire ammunition containing lead or lead compounds known to the State of California to cause cancer, birth defects, reproductive toxicity, and other serious physical injury. Those who discharge a firearm, stand near someone who discharges a firearm or cleans firearms are hereby warned of the dangers presented by lead and lead compounds and should take protective health measures. Avoid exposure to lead while handling and wash your hands after contact. Proper air ventilation is absolutely necessary when shooting indoors.

AMMUNITION WARNING

Old, Hot-loaded and/or re-loaded ammunition may be dangerous. Because of the poor or nonexistent quality control standards among some companies or people who make reloaded ammunition and the dangers of overloads and under loads (squib loads) which may occur, we recommend that only good quality new factory ammunition be fired in our firearms. [If you prepare your own hand loads, do NOT exceed recommended pressures in line with those generated by standard factory loads as manufactured by Remington, Winchester, Federal, PMC or other reputable companies.] Old ammunition may not fire with sufficient force to expel the projectile from the barrel.

READING THESE SAFETY RULES WILL SAVE YOUR LIFE OR THE LIFE OF SOMEONE ELSE

Get instructions from a competent firearms instructor before using this or any firearm. Learn from a professional how to handle, load, unload, operate, fire and care for your gun.

NEVER PLAY with your firearm. It is not a toy and can be a very dangerous weapon that can cause serious personal injury or death.

Always keep the gun pointed in a safe direction. Treat every gun as if it is loaded...all the time. NEVER point any firearm (loaded or unloaded) at any person or anything you do not intend to shoot. Always keep your gun unloaded

until ready to use and make sure that it is unloaded before cleaning.

Keep your finger OFF the trigger until you are actually aiming at the target and ready to shoot. Learn to rest your finger outside of the trigger guard.

Never rely on a gun's "safety" to protect you from unsafe gun handling. A safety is only a mechanical device, not a substitute for common sense and gun safety procedures.

Never leave a gun unattended or where it could fall and fire.

Store guns and ammunition separately **beyond the reach of children**. Make sure that they are properly secured so untrained individuals and children will be denied access to your guns and ammo.

Test your gun's operation and safeties only at a shooting range while the firearm is pointed in a safe direction.

Know your target and what is beyond. Ask yourself what your bullet will hit if it misses the target or passes through the intended target. Remember, a fired projectile can travel over a mile (including a ricochet) and is capable of going through walls.

Guns and alcohol or drugs do not mix. Don't take any alcoholic beverages and/ or drugs before or during shooting activities.

Never pull a gun toward you by the muzzle. Don't climb a tree, cross a ditch or fence with a loaded gun.

Always empty guns before entering a house, car, truck, boat, RV, camp or any building.

When receiving a gun, always open the action and check to make sure the chamber is unloaded.

NEVER accept anyone's word that a gun is "unloaded" or "empty". You should immediately open the action and check to make sure it is unloaded.

Be careful with ALL ammunition. Even "blank" cartridges are deadly at close range due to the muzzle blast. Make sure your ammunition is in new and in good clean condition. Do NOT oil or grease ammo as this may damage the cartridge primer. Do NOT tamper with or alter the standard factory ammunition.

Keep firearms unloaded when not actually in use. Load the gun only when on the range preparing to fire and unload it before leaving the range.

Never put your hand over the muzzle of a gun.

ALWAYS WEAR protective shooting glasses and hearing protection when using firearms.

Spectators should be at least 10 feet behind and away from the shooter while the shooter is loading, shooting and unloading. Spectators should wear protection for hearing and sight loss and they should avoid distracting those shooting their firearms.

**READING THESE SAFETY RULES WILL SAVE YOUR LIFE
OR THE LIFE OF SOMEONE ELSE**

Never drop your gun. If you do drop it, unload it and check it for proper function before using it again.

Do NOT alter or modify your gun. Don't try to change your gun's trigger pull, because it may affect sear engagement and thereby cause accidental firing.

Do NOT remove any internal safety or safety device on the firearm. Safety mechanisms are designed to protect you from injury or death.

Do maintain and keep your gun clean. Keep in a dry place away from other metals and water. If your gun shows sign of corrosion or improper operation, have it serviced by a competent gunsmith.

Keep the muzzle pointed in a safe direction when loading and unloading your gun. Never point the muzzle at anyone.

Never shoot at hard flat surfaces or water....bullets ricochet.

If a gun fails to fire when the trigger is pulled, keep it pointed down range at the target for 60 seconds. Sometimes slow primer ignition will cause a "hang fire" and the cartridge will go off after a short pause. If it still fails to fire, keep muzzle pointed in safe direction and avoid exposure to the breech, as you attempt to unload your firearm.

Never let water, snow, mud or other material enter the barrel. Always be sure the barrel is free of any obstruction.

Since many ammunition identifications sound similar, be sure that you use only the correct ammunition for your gun. Do NOT use the wrong size or wrong strength ammunition in your firearm.

Repeated and prolonged exposure to gunfire may cause toxic levels of lead in your body. High levels of lead in the blood may result in cancer, impotency, birth defects and other serious physical injury. When shooting indoors, make sure there is proper fresh air ventilation.

Teach children: 1. NOT to touch guns, bullets, cartridges, shells, flares or any explosive device and 2. If they discover such a dangerous item or weapon, they must immediately report its location to their parents, school teacher or police.

Remember a firearm has the capability of taking your life or the life of someone else. Be careful with your firearm -- an accident is almost always the result of not following basic safety rules.

HOME SAFETY IS PROBABLY YOUR BIGGEST CONCERN. We suggest a gun lock such as Master Gun Locks. They work on most firearms and are available in gun shops and sporting goods departments. For more information write: Master Gun Locks; Master Lock Company, P.O. Box 10367, Milwaukee. WI 53210. You have invested this much in your new firearm, now invest a little more in your family's safety.

USED FIREARMS - If you got your European American Armory firearm as a used gun, BEFORE USING IT you should unload it and check all its functions to be sure it works correctly. Firearms are sometimes altered to work incorrectly, or parts may be removed, lost or replaced with incorrect parts. First, unload it and check it yourself and then take it to a good gunsmith who knows European American Armory firearms, and have him examine it.

WRITE US concerning any items or circumstances which you don't understand and which might relate to your safety and the operation of your firearm.

WARNING

BEFORE LOADING or firing a Bolt Action Rifle, examine the bore and the firing chamber to be certain they are clean and free of any obstruction. Even a heavy coat of oil, grease, snow or water may result in damage to the firearm and injury to the shooter and/or persons near the firearm. A misfire or unusual sound upon firing is a signal to cease firing and to examine the chamber and bore. If there is any obstruction, clear the obstruction and clean the bore and chamber before firing.

FIRING WARNING

When shooting, full eye and ear protection is mandatory at all times. Shooters and spectators must wear shooting glasses and sound suppressor to prevent eye injury and hearing loss. ***Vision loss and hearing impairment can occur with only one moment of non-protection.***

WARNING

Any bore obstruction, even if it is only partly blocked, may cause the gun to blow up if it is fired, or may cause damage to the gun such as a bulged barrel. To avoid injury or death to the shooter or bystanders, check the barrel before shooting or if a shot does not sound normal.

WARNING

Always keep the muzzle pointed in a safe direction! Never attempt to load or unload any firearm inside a vehicle, building or other confined space (except a properly constructed shooting range). Enclosed areas frequently offer no completely safe direction in which to point the firearm. If an accidental discharge occurs, there is great risk of injury or property damage. Before loading, always clean all, grease and oil from the bore and chamber, and check to be certain that no obstruction is in the barrel. Any foreign matter in the barrel could result in a bulged or burst barrel or other damage to the firearm and could cause serious injury to the shooter or to others.

WARNING

If there is any reason to suspect that a bullet or projectile is obstructing the barrel, immediately unload the firearm (See Unloading Instructions) and check the chamber and the bore. A bullet may be lodged some distance down the barrel where it can not easily be seen. Check the bore by using a cleaning rod

to pass through the barrel. If a blockage is in the bore, **DO NOT ATTEMPT TO SHOOT IT OUT WITH ANOTHER CARTRIDGE, OR BLOW IT OUT WITH A BLANK CARTRIDGE OR A CARTRIDGE FROM WHICH THE BULLET HAS BEEN REMOVED.** SUCH TECHNIQUE(S) CAN GENERATE EXCESSIVE PRESSURE, DAMAGE THE FIREARM AND CAUSE SERIOUS PERSONAL INJURY. If the blockage can be removed with a cleaning rod, clean any unburned powder grains from the bore, chambers & mechanism before resuming shooting. If the blockage can not be dislodged by tapping it with a cleaning rod, take the firearm to a gunsmith.

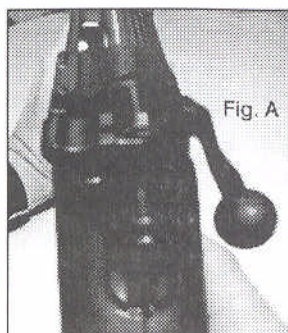

WARNING (Mechanical Malfunctions)

STOP SHOOTING IMMEDIATELY AND UNLOAD YOUR FIREARM if your firearm develops: a mechanical malfunction; binding or stoppage; spitting powder/gas; a cartridge primer is punctured; a cartridge case is bulged or ruptured; or the sound on firing does not sound quite right. Do NOT try one more shot but unload your firearm and take it and the ammunition to a qualified gunsmith or send it back to EAA for examination. Do not assume that the Bolt Action Rifle is empty merely because you checked the chamber. You must also check the bore for any fired cartridge jammed inside the barrel.

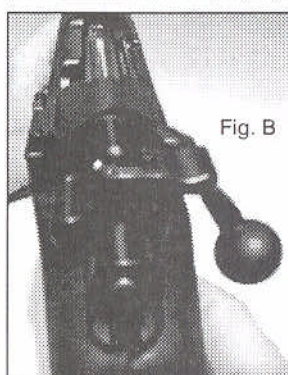

External Control Parts:

Safety : You rifle has a large flip lever, located at the rear of the bolt. Moving the lever clockwise in a rotating motion engages the safety or puts it on. Moving the lever counter clockwise in a rotating motion disengages the safety or puts the rifle in the ready to fire position. When your safety is in the fire position the safety pivot rod notch will align with a notch in the bolt and both sections of the notch will now be red. Simply: Safety lever rotated all the way to the left (counter clockwise) and flat is in the ready to fire position, safety lever rotated all the way to the right (clockwise) and flat is in the safe position. To load and unload the rifle put safety lever straight up or perpendicular to barrel axis, this will allow you to function the bolt but keeps trigger disengage. **WARNING....KEEP FINGERS AWAY FROM TRIGGER DURING ALL SAFETY MOVEMENT.....MAKE SURE YOU UNDERSTAND HOW THE SAFETY WORKS BEFORE YOU LOAD OR USE THE BOLT ACTION RIFLE)....NOTE: WITH SAFETY ENGAGED OR "ON" THE BOLT HANDLE IS LOCKED.** See Fig A (engaged), Fig B (disengaged) Fig C (load / unload position)

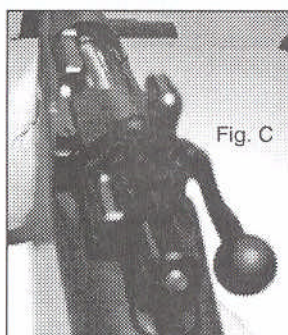

Trigger: Located in the trigger guard. If the safety is disengaged and the mechanism has been cocked and the trigger is pulled to the rear the Bolt Action Rifle will discharge, if there is a live cartridge in the chamber.

Rear Sight: Optional: Windage or Windage and Elevation adjustable

Scope Mount Rail: Optional "Weaver Rail Type" WEAVER IS A TRADE MARK OF BLOUNT, All scope mounts must be extended or tall so as to allow safety lever to clear scope, **WarningDo not block safety lever movement with scope , See Fig 8**

HOLES FOR SCOPE MOUNT: Your rifle receiver is drilled and tap for a scope mount, obtain Mauser 98K style scope mounts from most major scope mount companies

Bolt Stop: Located on left hand side of receiver, Pull out to remove or install bolt

Bolt: Located in center of receiver after assembly, Used to load and unload round and houses firing pin assembly and is the firing mechanism

Cocking Indicator: Protrudes out back of Bolt and is extended when gun is cocked and moves forward when trigger is pulled or gun is not cocked. **See Fig D**

Directions For Assembly Of Bolt Action Rifle:

- 1) Remove protective wrapping from rifle and bolt
- Fig 1: While keeping the rifle pointed in a safe direction at all times, make sure the rifle receiver and action are free of debris....While the bolt is out look inside barrel from the receiver end to assure that the gun is free of debris, if you find debris clean before firing and assembly
- 2) Fig 2: Your rifle is shipped with the bolt removed from the receiver. Move bolt stop out, align bolt lugs on receiver, insert bolt into the rear of the receiver while holding bolt stop out, push bolt forward with bolt handle.
- 3) Fig 3 & 4: If your rifle was equipped with optional scope mounts or scope rail, install mounts or rail in holes on top of the receiver, make sure that safety

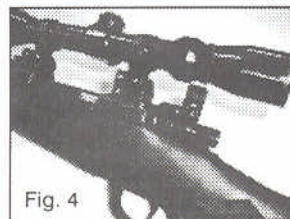
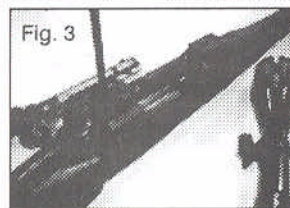
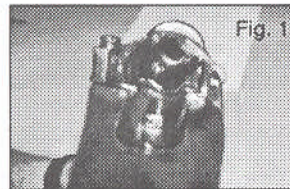
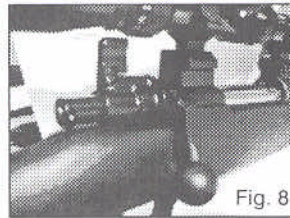

lever has complete movement, do not block safety lever movement with scope.

- 6) Fig 5: Make sure the safety is engaged after completion of assembly. (See Safety Notes above)

To Load Bolt Action Rifle:

- 1) Make sure the Bolt Action Rifle is pointed in a safe direction at all times, the safety is engaged, and never allow fingers or objects to contact trigger during loading.

Warning * Do not load Bolt Action Rifle until you are ready to fire**

- 2) Move safety lever to load / unload position (lever is up or perpendicular to the barrel axis) to load the rifle, once loaded re-engage the safety and do not disengage safety until you are ready to fire. Once loaded always keep rifle with safety fully engaged so as to lock bolt and trigger.

- 3) Make sure the ammo that you are using is the correct caliber as identified on the receiver or barrel.

- 4) Visually inspect the chambers and barrel for obstructions. The chamber and barrel should be free of oil or grease or obstructions.

• **WARNING ...ONCE YOU HAVE COMPLETED STEP 5 OR 5a YOUR RIFLE HAS A CARTRIDGE IN THE CHAMBER AND WITH THE SAFETY DISENGAGED COULD FIRE, MAKE SURE YOU HAVE SELECTED THE CORRECT AMMUNITION BEFORE YOU ATTEMPTING STEP 5 OR 5a**

- 5) Fig 9 (a,b,c,d): To load one cartridge only a) Make sure safety lever is in the load / unload position b) Raise the bolt handle c) Pull the bolt handle all the way back d) Put a cartridge on the magazine follower or in the chamber e) Slide the bolt handle forward, then push the bolt handle down to lock the cartridge into the chamber f) Engage safety or rotate safety lever fully clockwise.

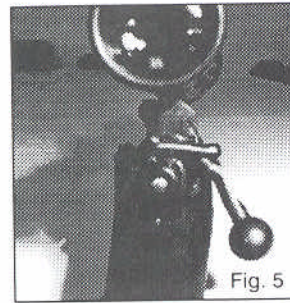

Fig. 5

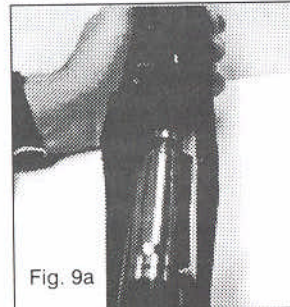

Fig. 9a

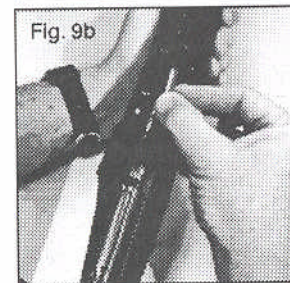

Fig. 9b

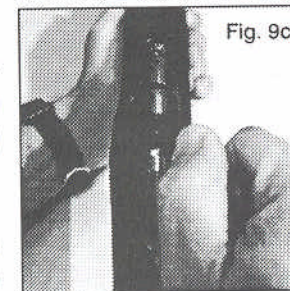

Fig. 9c

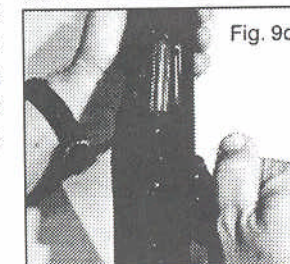
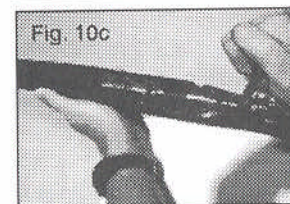
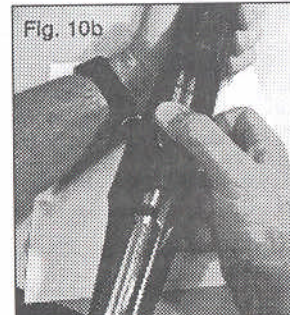
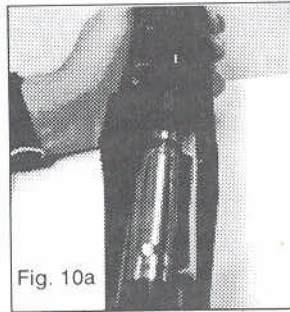

Fig. 9d

- 5a) Fig 10 (a,b,c): To load the chamber and the magazine a) Make sure safety lever is in the load / unload position b) Raise the bolt handle c) Pull the bolt handle all the way back d) Put a cartridge on the magazine follower and push down, repeat step "d" four more times or until you have five cartridges in the magazine e) Put a cartridge into the chamber f) Use a finger to push the cartridges in the magazine all the way down and then slowly slide the bolt forward over the top of the cartridges g) Then push the bolt handle down to lock the cartridge into the chamber h) Engage safety (rotate safety lever fully clockwise until it is parallel to the barrel axis).



WARNING

Never keep or store your rifle loaded..... There is no excuse for not being careful.....

WARNING

Never load a shell or cartridge into the chamber until you are ready to fire the Bolt Action Rifle...

To Fire Bolt Action Rifle:

WARNING

- Do not disengage the safety until the Bolt Action Rifle is pointed in a safe direction and you are ready to fire.
- If a cartridge does not fire and the trigger has been pulled and the safety is disengaged...Stop! and do the following: a) Make sure the gun is pointed in a safe direction b) Engage the safety c) Wait 60 seconds d) Follow the instruction below for unloading the Bolt Action Rifle.
- If during firing the sound of any cartridge is noticeably softer or louder than the previous cartridge fired, Stop! Do not load another cartridge or fire another cartridge and do the following: a) Make sure the gun is pointed in a safe direction b) Engage the safety c) Follow the instruction below for unloading the Bolt Action Rifle d) With the Bolt Action Rifle unloaded visually inspect the Bolt Action Rifle for barrel blockage or damage and inspect the mechanical portion and receiver of the Bolt Action Rifle for damage before continuing.

PLEASE READ AND UNDERSTAND ALL WARNINGS IN THIS MANUAL BEFORE FIRING YOUR BOLT ACTION RIFLE, MAKE SURE YOU KNOW WHAT YOU ARE SHOOTING AT

- 1) Make sure the gun is pointed in a safe direction and that you are **wearing ear and eye protection and keep fingers away from triggers.**

- 2) Engage safety if not already engaged
- 4) Disengage the safety and begin firing only when you are ready to fire and the Bolt Action Rifle is pointed in a safe direction to be fired. At this point the Bolt Action Rifle will fire if the trigger is pulled.

To Unload Bolt Action Rifle:

- 1) Make sure the gun is pointed in safe direction and the safety is engaged and your fingers are away from the trigger

There is no excuse for not being careful.....

There is no excuse for not being careful.....

- 2) Move safety lever to load / unload position (perpendicular to barrel axis)
- 3) Raise the bolt handle and put one hand over the ejection port.
- 4) Slowly pull the bolt handle rearward to remove the cartridge from the chamber
- 5) Remove the released cartridge
- 6) Repeat step four and five until the magazine and gun are completely empty
- 7) Visually check that the barrel and chamber so that they are empty and free of obstructions
- 8) Re-engage safety once firearm is empty

To Disassemble The Bolt Action Rifle:

- 1) Make sure the Bolt Action Rifle is unloaded (FOLLOW UNLOADING INSTRUCTIONS) and pointed in a safe direction and the safety is engaged.
- 2) Make sure your fingers are away from the trigger.

There is no excuse for not being careful.....

- 3) Move safety lever to load / unload position (perpendicular to barrel axis)
- 4) Fig 11: Raise the bolt handle and move the bolt stop out or away from the receiver
- 4) Fig 12: Pull the bolt handle all the way back and out of the receiver. Check the barrel for damage and blockage after removal of the bolt

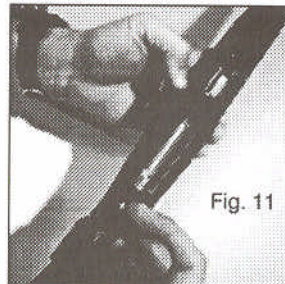

Fig. 11



Fig. 12

MANUFACTURER'S WARNING

This firearm was manufactured to properly perform with the original parts as designed. It is your duty to make sure any parts you buy are correctly installed and that neither replacements nor originals are altered or changed. Your gun is a complex tool with many parts that must relate correctly to other parts for safe and accurate operation. Putting a gun together wrong or with modified parts can result in a damaged gun, injury or death to you or others through malfunction. Always let a qualified gunsmith work on your gun or at least, check any work not performed by a gunsmith. Firearms safety is your primary concern. **THE GUN OWNER MUST ACCEPT FULL RESPONSIBILITY FOR THE CORRECT REASSEMBLY AND FUNCTIONING OF THE FIREARM AFTER ANY DISASSEMBLY OR REPLACEMENT OF PARTS.**

Cleaning and Maintenance Of Bolt Action Rifle:

Warning : Check to make sure the rifle is fully unloaded, see unloading instructions

- A) Follow procedures for unloading Bolt Action Rifle as described previously
- B) Follow procedures for disassembly of Bolt Action Rifle as described previously
- C) Materials needed to clean this Bolt Action Rifle are: a cleaning rod, cotton bore patches, brass bore brush, powder solvent, a small soft brush and good quality gun oil.

WARNING: Lead or lead compounds are known to the State of California to cause cancer, birth defects, reproductive toxicity, and other serious physical injury. Those who clean firearms should take protective measures to avoid contact or exposure to such chemicals.

There is no excuse for not being careful.....

- D) Using the bore brush with powder solvent scrub the barrel and chamber to remove any powder and lead residue in the bore. Always and lastly, swab with cotton patch with gun oil to coat and protect the bore and chambers from rust and corrosion.
- E) Any powder fowling on the firing wall, barrel, etc. can be easily cleaned with a brush and powder solvent.
- F) All external surfaces should be wiped down with a light coat of rust preventative. Avoid using too much oil as dust and/or debris can get trapped in the oil creating a gum that in time will cause misfires.
- G) CAUTION in using solvents in gun bore cleaning. Prolonged or excess contact with finish or bluing can damage the gun's finish. Be sure to wipe away all excess solvent and then lubricate with oil.
- H) A gun should be cleaned after firing. In addition, external parts should be wiped with an oiled cloth after handling. A light oil is ordinarily all that is

necessary in cleaning if the gun has not been fired or fired very little. If a gun is used frequently, it must be cleaned after each firing and regularly serviced by a professional gunsmith. If the gun has been stored, remove all excess oil and/or grease before firing. Always check to be sure that no cleaning patch or other obstruction remains in the bore or chambers before firing.

DANGER -- AMMUNITION WARNING

Firearms may be damaged and serious injury or death to the shooter or bystander may result from any condition which contributes to the generation of excessive pressure or uncontrolled release of gas within the firearm. Such adverse conditions can be caused by bore or chamber obstruction, propellant powder overloads or by defective, incorrect or improperly loaded and assembled cartridge components. Even the strongest firearm can be blown up as a result of excessive pressure. It is extremely dangerous to use a cartridge whose pressure is greater than that developed by cartridges loaded to industry standards.

AMMUNITION (CARTRIDGES) NOTICE

We specifically disclaim responsibility for any damage, injury or death occurring in connection with or as the result of the use of European American Armory Bolt Action Rifle of faulty, non-standard, remanufactured, hand loaded or reloaded ammunition, used cartridges or cartridges other than factory cartridges for which the firearm was originally chambered.

LUBRICATION WARNING

Firing a Bolt Action Rifle with oil, grease or any other material even partially obstructing the bore may result in damage to the Bolt Action Rifle and injury to the shooter and those nearby. Do not spray or apply lubricants directly on ammunition. If the powder charge of a cartridge is affected by the lubricant, it may not be ignited, but the energy from the primer may be sufficient to push the bullet into the bore where it may become lodged. Firing a subsequent bullet into the obstructed bore will damage the Bolt Action Rifle and may cause injury to the shooter and those nearby. Use lubricants properly. You are responsible for the proper care and maintenance of your firearm and ammunition.

ONE YEAR LIMITED WARRANTY

This European American Armory Corp. firearms is warranted to the original retail customer for One Year from date of purchase against defects in material and workmanship. All parts and labor or replacement **at our option** are covered. Wood Stock and Wood Forend are not covered by the One Year Warranty. The warranty on the wood stock and forend is 60 days from purchase and only covers manufactured and material defects.

Transportation to and from our repair facilities, government fees, damage caused by failure to perform normal maintenance, sales outside the United

States, damage due to use of high velocity, high pressure, reloaded or other nonstandard ammunition, or any unauthorized repair, modification, misuse, abuse, or alteration of the product is not covered by this Limited Warranty.

Any implied warranties, including the implied warranties of merchantability and fitness for a particular purpose, are limited to one year from date of original retail purchase. Consequential or incidental damages and/or expenses, or any other expenses are not covered by this warranty.

To obtain warranty performance send your firearm with proof of retail purchase, freight prepaid to:

European American Armory Corp.
3855 North U.S. Highway One
Cocoa, Florida 32926

WARNING

Altering or modifying parts and/or internal safeties is dangerous and will void the warranty. This Bolt Action Rifle was manufactured to perform properly with the original parts as designed. It is your duty to make sure any parts you buy are made for this firearm and are installed correctly and that neither the replacements nor originals are altered or changed. Your gun is a complex precision tool with many parts that must relate correctly to other parts in order for proper and safe operation. Putting a gun together wrong or with incorrect or modified parts can result in a damaged gun, danger, and injury or death to you and others through malfunction. Always have a qualified gunsmith work on your gun or at least check any work not performed by a gunsmith.

PARTS LIST BRNO 98 Bolt Action Rifle

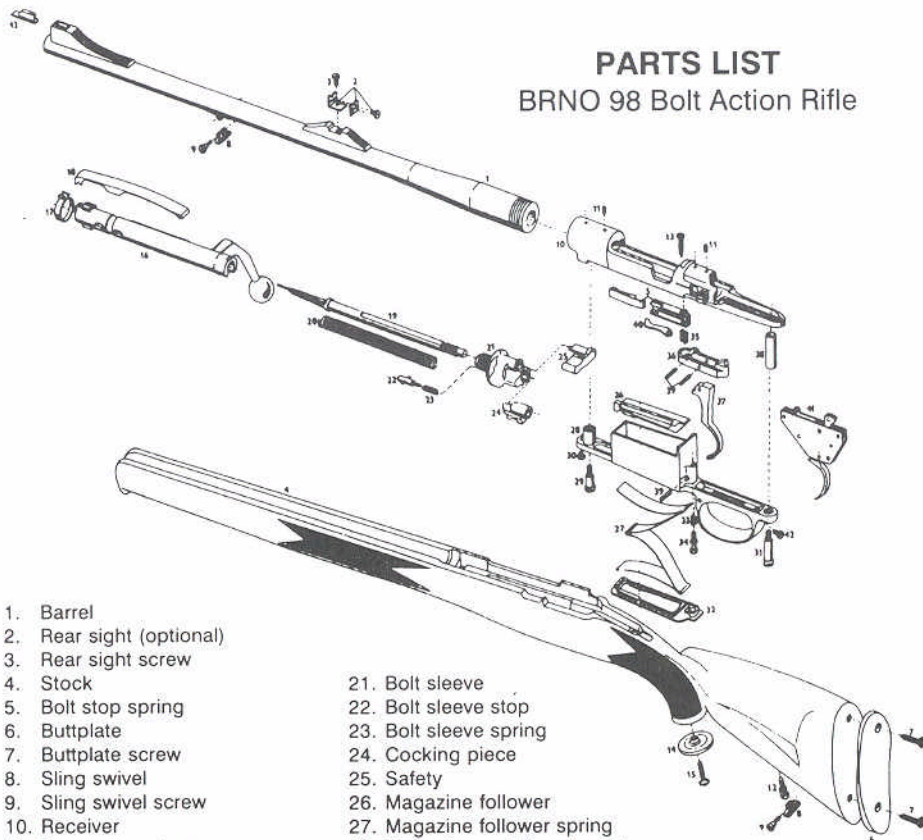

- | | | |
|--|---|---|
| <ul style="list-style-type: none"> 1. Barrel 2. Rear sight (optional) 3. Rear sight screw 4. Stock 5. Bolt stop spring 6. Buttplate 7. Buttplate screw 8. Sling swivel 9. Sling swivel screw 10. Receiver 11. Scope mount screw 12. Lower joint 13. Bolt stop screw 14. Grip-plate pad 15. Grip-plate screw 16. Bolt 17. Extractor collar 18. Extractor 19. Firing pin 20. Firing pin spring | <ul style="list-style-type: none"> 21. Bolt sleeve 22. Bolt sleeve stop 23. Bolt sleeve spring 24. Cocking piece 25. Safety 26. Magazine follower 27. Magazine follower spring 28. Magazine and trigger guard 29. Front guard screw 30. Lock screw 31. Rear guard screw 32. Magazine floor plate 33. Magazine latch spring 34. Magazine latch 35. Sear spring 36. Sear 37. Trigger | <ul style="list-style-type: none"> 38. Spacer 39. Sear and trigger pin 40. Ejector 41. Trigger system with set trigger 42. Adjusting screw 43. Front sight (optional) |
|--|---|---|

YOUR BRNO 98:

Is a copy of a Mauser 98 K. Many after market accessories will fit the Mauser 98 K and should fit your BRNO 98. Below you will find various after market items that should fit your BRNO 98 rifle. European American Armory Corp does not recommend these products or endorse these products. All after market items should be installed by a qualified gunsmith. Installation of some after market parts can void your warranty or cause your gun to become unsafe or malfunction.

MANUFACTURER'S WARNING

This firearm was manufactured to properly perform with the original parts as designed. It is your duty to make sure any parts you buy are correctly installed and that neither replacements nor originals are altered or changed. Your gun is a complex tool with many parts that must relate correctly to other parts for safe and accurate operation. Putting a gun together wrong or with modified parts can result in a damaged gun, injury or death to you or others through malfunction. Always let a qualified gunsmith work on your gun or at least, check any work not performed by a gunsmith. Firearms safety is your primary concern. **THE GUN OWNER MUST ACCEPT FULL RESPONSIBILITY FOR THE CORRECT REASSEMBLY AND FUNCTIONING OF THE FIREARM AFTER ANY DISASSEMBLY OR REPLACEMENT OF PARTS.**

SCOPE MOUNTS: There are various scope mounts and bases that will fit your rifle.

B-SQUARE
P.O. BOX 11281
FORT WORTH, TX 76110-0281
817-923-0964

B-SQUARE Weaver Rings and Base model numbers:
Rings: 20524 or 21524 (Low), 20515 or 21515 (Med), 20525 or 21525 (High) /
Base: 14904

B-SQUARE LYNX STEEL STUD Rings and Base:
Rings: 1872 or 4101 or 2872 (low), 1873 or 4102 or 2873 (Med), 1874 or 4103
or 2874 (High) / Base: BSS - 1904

B-SQUARE Floor Plate Release Button: T1806

Brownells, Inc.
200 South Front Street
Montezuma, IA 50171
641-623-5401

LOW STYLE SAFETY: Brownells Part numbers: 883-804-098 or 240-001-980
or 100-000-232

YOUR OWNERS' MANUAL

Always keep this manual with your firearm. Make sure you understand all the warnings, operation instructions and safety procedures. When you lend, give or sell the firearm, be sure this manual goes with it. You can get a copy of this manual from European American Armory on request.

ALL PARTS ORDERS ARE SUBJECT TO A \$10.00 CHARGE FOR SHIPPING AND HANDLING. Please state Model, Caliber, Serial Number, and Finish Color when ordering. For parts, information and service contact: European American Armory Corp., 3855 North U.S. Highway One, Cocoa, Florida 32926 Phone: (321) 639-4842.

WARNING

Children are attracted to and can operate firearms that can cause severe injuries or death. Prevent child access by always keeping guns locked away and unloaded when not in use. If you keep a loaded firearm where a child obtains and improperly uses it, you may be fined or sent to prison.

ADVERTENCIA

A los niños les atraen las armas de fuego y los pueden hacer funcionar. Ellos pueden causarse lesiones graves y la muerte. Evite que los niños tengan acceso a las armas de fuego guardándolas siempre con llave y descargadas cuando no las esté utilizando. Si usted tiene un arma de fuego cargada en un lugar en que un niño tiene acceso a ella y la usa indebidamente, le pueden dar una multa a enviarlo a la cárcel.

