

— DRAFT —
(CONTACT H&K FOR FINAL VERSION)



HECKLER & KOCH, INC.
21480 Pacific Boulevard
Sterling, Virginia 20166-8903
TEL. (703) 450-1900

HECKLER & KOCH MP5 SUBMACHINE GUN FAMILY



OPERATOR'S MANUAL

— DRAFT —
(CONTACT H&K FOR FINAL VERSION)

HKI-TD-4/92 (5/93)
(J. Schatz)

SAFETY RULES

- Safety Rule # 1** Treat every weapon as if it were loaded.
- Safety Rule # 2** Never point a weapon at anything or anybody that you do not intend to shoot, or in a direction where an unintentional discharge may result in damage to property, injury or death.
- Safety Rule # 3** Never place your finger into the trigger guard until you are ready to fire the weapon.
- Safety Rule # 4** Be sure of your target and of what's behind it before firing! At 25 meters, even a 9mm projectile can easily penetrate wood or plasterboard walls or a car door and may travel more than 1 mile!
- Safety Rule # 5** Ensure that all parts of your hands and body are kept away from the muzzle of the weapon **at all times!**
- Safety Rule # 6** Always wear eye protection (with side protection when firing on steel targets) and ear protection when firing any firearm.
- Safety Rule # 7** Clear every weapon **before handling it.**

CLEAR THE WEAPON!

1. Before handling the weapon, "**CLEAR IT!**"! Do so by:
 - A. Make sure fingers are outside of the trigger guard and the weapon is pointed in a safe direction at all times!
 - B. **ON SAFE** - Rotate the safety/selector lever to the "Safe" position. (With the safety/selector lever set at the white box with a white bullet symbol inside or at the white "S". See illustrations on pages 16 - 18.)
 - C. **REMOVE MAGAZINE** - Depress the magazine release lever or button and remove the magazine from the magazine well.
 - D. **COCKING HANDLE** - Rotate the ejection port towards the ground and pull the cocking handle rearward one or more times to insure the chamber is empty. Watch for a live round or empty case to be ejected.

Rotate the cocking handle upward slightly and lock it into the indent in the cocking lever housing to lock the bolt open.

E. **INSPECT CHAMBER** - Inspect chamber for the presence of a live round or empty case.

A. Visually - View chamber through open ejection port.

B. Physically - Insert index finger through magazine well and feel for the presence of a round or cartridge case in the chamber.

Remove any live rounds or empty cases from the chamber or from within the weapon or magazine before handling the weapon further.

The H&K MP5 submachine gun is now considered "Clear".

2. **REVIEW THE SAFETY RULES LISTED ABOVE AND ON PAGE 27 BEFORE HANDLING THE WEAPON FURTHER.**

3. **OBEY THE SAFETY RULES LISTED ON PAGE 27 EACH AND EVERY TIME YOU HANDLE ANY FIREARM.**

TABLE OF CONTENTS

<u>Page Number</u>	<u>Subject(s)</u>
4	Introduction
4Description
5	Models and Variants
11History
13	Technical Specifications
15Nomenclature
15	Operating Controls and their Use
22Advantages of the Weapon System
23	Clearing Procedure
25Filling the Magazine
25	Loading procedure
27Safety Rules
28	Firing Procedure
29Immediate Action
30	Operator Disassembly
37Operator Reassembly
44	Function Check
45Operating Principle
51	Safeties
52Operator Cleaning
58	Operator Inspection
59Correct Locking Piece
60	Lubrication
62Special Use and Maintenance of H&K Sound Suppressed Weapons
67	Ammunition
68Sight Alignment/Sight Picture
70	Sight Adjustment
75Use of the Multi-purpose Carrying Sling
84	Transitioning to the Back-up Weapon
85Covering the Suspect
85	Optimum Firing Position
88Tactical Reload
90	Storage of the Weapon
90Use of Optional Accessories
98	Trouble Shooting
103Parts List
113	Exploded Diagram
115Weapon Service Record

INTRODUCTION

In the U.S. law enforcement environment, the select-fire submachine gun (smg) is primarily issued as a supplement to the duty handgun or as a replacement for the shotgun. The submachine gun, being shoulder-fired, generally provides a higher degree of precision and "firepower" compared to a handgun for the average user. The longer barrel and sight radius increase the submachine gun users ability to engage all targets, both of a smaller size and at a greater distance (out to 150 meters), with an increased probability of hit, and thus decreasing the incidence of stray rounds.

The submachine gun, with it's detachable large capacity magazine and select-fire operation, provides the user with an enhanced measure of firepower not available from a conventional handgun while still sharing commonality of ammunition. The small size and weight of the submachine gun also makes it easy to store and transport. Submachine guns are often preferred over heavier recoiling shotguns by users of a smaller stature, thus increasing their ability to successfully engage single and multiple targets.

Relatively speaking, the modern select-fire submachine gun of today is the lever-action Winchester rifle of a century ago.

DESCRIPTION

The Heckler & Koch MP5 Submachine gun is a lightweight, air-cooled, magazine-fed, delayed blowback operated, select-fire weapon that can be shoulder or hand fired. The H&K MP5 submachine gun is chambered for various pistol cartridges to include 9 X 19mm Luger, .40 S&W, and 10mm Auto. It fires from a closed-bolt position in semi-automatic, 2 or 3-round burst, and sustained fire modes. The weapon utilizes the unique H&K roller-locked bolt system used commonly throughout the H&K family of small arms.

The unique features of the H&K MP5 submachine gun include a free floating cold hammer-forged barrel, stamped sheet steel receiver, fluted chamber, straight-line stock and a pistol grip with ambidextrous safety/selector lever.

The modular design of the weapon consists of six (6) assembly groups, not including the carrying sling (see page 15). This design provides an unmatched degree of flexibility as these groups can be exchanged with optional groups to create various styles of weapons for numerous operational requirements. This design also allows assemblies to be repaired separately from the weapon which can be fitted with a new group and immediately returned to service.

The serial number of the MP5 submachine gun is located on top of the weapon's receiver just forward of the rear sight assembly. On pre-1989 sound suppressed MP5SD models the sound suppressor and weapon serial numbers match. Serial numbers on the newly manufactured (post-1989) MP5SD or on the MP5-N, MP5K-N, MP5K-PDW, MP5/10 and MP5/40 are not matched to the sound suppressor.

The bare metal surfaces of the MP5 are first phosphated and then a black lacquer paint is applied over the phosphating. This dry lacquer coating is applied using a magnetic charge and then baked onto the metal in an oven. The resulting finish is highly resistant to salt water corrosion and surface wear.

MODELS AND VARIANTS

There are four (4) officially recognized models of the H&K MP5 submachine gun. Each model has numerous variations within it's family.

MP5
(model # 1)

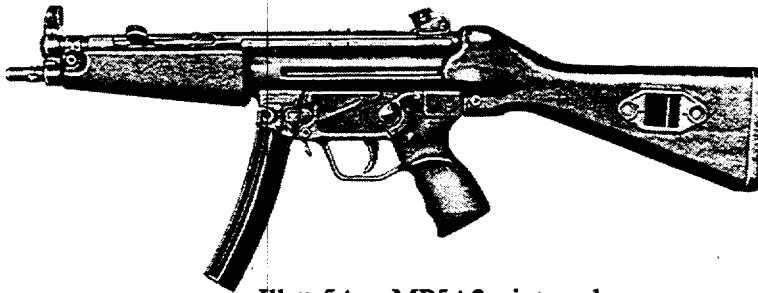

Ill.# 5A - MP5A2 pictured

Variant

- MP5A2** **A2** denotes weapon is fitted a with fixed buttstock. Select-fire model in caliber 9 x 19mm Luger (also referred to as 9 X 19 mm NATO or Parabellum) with 8.85 inch barrel, "SEF" trigger group and fixed buttstock. Developed in 1965 for the West German Police and Border Guard.
- MP5A3** **A3** denotes weapon is fitted a with retractable buttstock. Same as MP5A2 but fitted with retractable buttstock.
- MP5A4** Same as MP5A2 but with 3-round burst firing mode and ambidextrous safety/selector levers.
- MP5A5** Same as MP5A3 but with 3-round burst firing mode and ambidextrous safety/selector levers.

MP5-N N stands for "Navy" model. Select-fire model in caliber 9 X 19mm Luger with 8.85 inch barrel, ambidextrous trigger group with safe, semi and fully-automatic firing modes and retractable buttstock. Has threaded barrel to mount optional H&K stainless steel sound suppressor and front sight post with tritium dot as standard features. Intended to be used with or without the sound suppressor attached and with subsonic or supersonic ammunition. Developed in 1986 for the U.S. Navy Special Warfare community.

NSN: 1005-01-360-7146

MP5SFA2 SF stands for "Single-fire". Same as MP5A2 but is fitted with an ambidextrous trigger group with safe and semi-automatic only firing modes.

Normally termed a semi-automatic carbine, the MP5SF comes standard with H&K's detachable flash hider. Versions delivered after 1 December 1991 are assembled with select-fire bolt carriers allowing select-fire operation if fitted with a select-fire trigger group. Developed in 1986 in response to the American FBI solicitation for "9mm Single-fire Carbines". While they fire only in semi-automatic mode, MP5SF's are still considered to be NFA (National Firearms Act) weapons by the Bureau of Alcohol, Tobacco and Firearms and are therefore considered machine guns and treated as such.

MP5SFA3 Same as MP5SFA2 but is fitted with a retractable buttstock.

MP5PT PT stands for "Plastic Training". Special training version of the MP5. Designed to shoot plastic bullets produced by Dynamit Nobel of Germany. Weapon operates like standard MP5 but has a floating chamber and no bolt rollers to function properly when firing the lighter plastic projectiles. Weapon is marked with light blue cocking handle and lettering. Is also available with various buttstocks and trigger groups. Developed for use by the West German Police and Border Guard.

MP5SD
(model # 2)

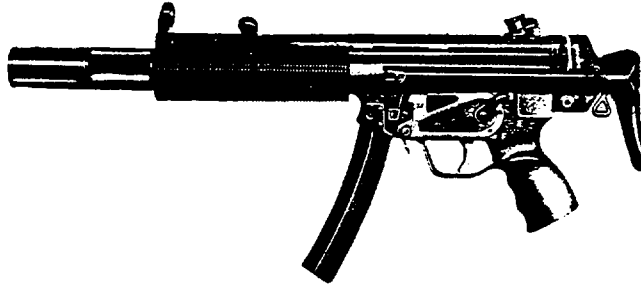

Ill.# 7A - MP5SD3 pictured

Variant

- MP5SD1** SD stands for "Suppressed". 1 denotes weapon fitted with a receiver cap, no buttstock. Select-fire model in caliber 9 X 19mm Luger with ported 5.73 inch barrel, "SEF" trigger group, receiver cap, and an integral but detachable aluminum sound suppressor. Designed to be used exclusively with standard supersonic ammunition with the suppressor on at all times. Developed in 1971 for the West German Police and Border Guard.
- MP5SD2** Same as MP5SD1 but fitted with a fixed buttstock.
- MP5SD3** Same as MP5SD2 but fitted with a retractable buttstock.
- NSN: 1005-01-144-3036
- MP5SD4** Same as MP5SD1 but with 3-round burst firing mode and ambidextrous safety/selector levers.
- MP5SD5** Same as MP5SD2 but with 3-round burst firing mode and ambidextrous safety/selector levers.
- MP5SD6** Same as MP5SD3 but with 3-round burst firing mode with ambidextrous safety/selector levers.
- MP5SD-N** N denotes "Navy" version. Same as MP5SD3 but fitted with ambidextrous trigger group, front sight post with tritium dot and a stainless steel suppressor. Developed in 1986 for the U.S. Navy Special Warfare community.

Has a modified cocking lever support to account for the slightly larger outside diameter of the stainless steel sound suppressor used exclusively on the MP5SD-N.

MP5-K
(model # 3)

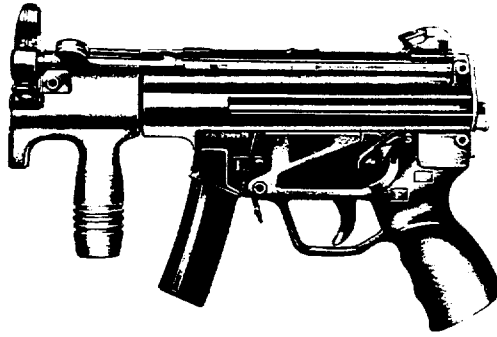

Ill.# 8A - MP5-K pictured

Variant

MP5K **K** stands for "kurz" which means short in German. Select-fire model in caliber 9 X 19mm Luger with 4.50 inch barrel, "SEF" trigger group and buttcap (no buttstock). Developed in 1978 for the West German Police and Border Guard for one handed use or for concealed carry in shoulder rigs or special firing attache cases.

MP5KA1 **A1** in MP5K nomenclature denotes weapon without adjustable sights. Otherwise the MP5KA1 is identical to the MP5K. Developed for use exclusively with optional aiming devices or for use within the special firing attache cases.

MP5KA4 Same as the MP5K but with 3-round burst firing mode and ambidextrous safety/selector levers.

NSN: 1005-01-259-2895

MP5KA5 Same as MP5KA1 but with 3-round burst firing mode and ambidextrous safety/selector levers.

MP5K-N

N denotes "Navy" version. Same as MP5K but is fitted with a longer 5.50 inch threaded barrel with the 3-lugs found on the MP5A2. Allows the weapon to be fitted with the optional H&K screw-on stainless steel sound suppressor or muzzle mounted accessories.

The MP5K-N also comes standard with ambidextrous safety/selector lever and a front sight post with a tritium dot.

Developed in 1986 for the U.S. Navy Special Warfare community. Because of it's longer 5.5 inch barrel and ambidextrous safety/selector lever, the MP5K-N will not fit in the special firing attache case made for the standard MP5-K without modification of the case.

MP5K-PDW

PDW stands for "Personal Defense Weapon". Same as MP5K-N but fitted with a folding buttstock. This weapon is marked "MP5K-N" on the top of the receiver, not MP5K-PDW as it is an MP5K-N modified in the U.S. simply by adding the folding buttstock. Allows the shorter MP5-K to be fired from the shoulder. Can be used with the optional muzzle-mounted accessories to include the flash hider, blank firing attachment or screw-on sound suppressor. Developed in 1991 by HK-Inc in the U.S. for personal defense and VIP protection details. The rigid folding buttstock of the MP5K-PDW can be fitted to any MP5-K variant without modification.

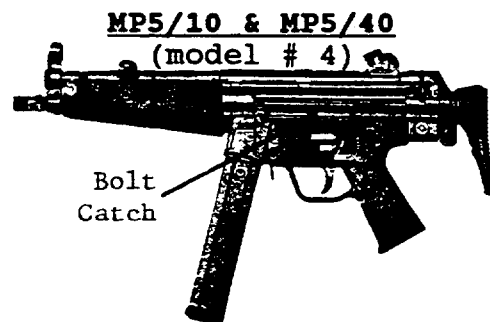

Ill.# 9A - MP5/40 pictured

Variant

MP5/10 Select-fire model in caliber 10mm Auto with 8.85 inch barrel. Available in a variety of trigger group and buttstock variations to include the MP5/10A2 with fixed buttstock and the MP5/10A3 with retractable buttstock.

Comes standard with threaded barrel, ambidextrous safety/selector levers and carrying sling, synthetic magazines, LO impulse locking piece, and bolt catch.

Available with optional 2 or 3 round burst firing mode. Developed in 1991 for U.S. Federal Law Enforcement sale. First production weapons imported into the U.S. after March 1993.

MP5/40 Same as MP5/10 but chambered for the .40 S&W cartridge.

MP5 submachine guns equipped with fixed or retractable buttstocks are normally delivered with wide forearms, one 30-round magazine, one multi-purpose carrying sling and an operators manual. All MP5K models are delivered with one 15-round magazine and an operators manual (no sling).

All MP5's can be fitted with optional ambidextrous trigger groups providing firing modes of semi-automatic (single-fire) only, semi-automatic and two-round burst only, semi-automatic and three-round burst only, semi-automatic with two or three round burst and fully-automatic (sustained fire), or semi-automatic and fully-automatic (no burst fire). These complete trigger groups are interchangeable during operator disassembly and reassembly without special tools. Complete trigger groups are interchangeable between all variants of the MP5 and MP5SD, between all variants of the MP5-K, and all variants of the MP5/10 and MP5/40. Trigger groups should not be mixed between the above specified models except where noted as some of the component parts (ejectors, plastic grip) are different between models.

HISTORY

The H&K MP5 submachine gun was first produced in the mid-1960's as the "HK54". H&K's internal Protocol Department established this acronym "HK54" for it's first 9mm submachine gun based on the following code.

<u>First Letter</u>	<u>Type of weapon</u>	<u>Second Letter</u>	<u>Caliber</u>
1	Box-fed light machine gun	1	7.62 X 51 mm
2	Belt-fed machine gun	2	7.62 X 39 mm
3	Select-fire assault rifle	3	5.56 X 45 mm
4	Paramilitary rifle (German)	4	9 X 19 mm
5	Submachine gun	5	(not used)
6	Grenade launcher, complete weapon	6	4.6 X 36 mm
7	Grenade launcher, add-on weapon	7	(not used)
8	(not used)	8	(not used)
9	Semi-automatic paramilitary rifle (USA)	9	40 mm

The H&K HK54 received it's current acronym "MP5" when it was officially adopted by the West German government for use by it's Police and Border Guard as the "Machine Pistol 5", or MP5.



The first MP5's were imported into the U.S. in the very early 1970's. Original HK-Oberndorf produced MP5's were imported into the U.S. and thus marked with "Harrington & Richardson", "Saco", "HK-Inc., Arlington, VA", "HK-Inc., Chantilly, VA", and the present marking "HK-Inc., Sterling, VA". This stamp is located on the right side of the magazine well. All 23 or more of the officially recognized variants of the MP5 submachine gun have been imported into the U.S. The MP5 submachine gun is imported into the U.S. exclusively by Heckler & Koch, Incorporated (HK-Inc.), located in Sterling, Virginia, for law enforcement and military sale.

The MP5 submachine gun is manufactured by Heckler & Koch, GmbH. ("Inc." in German) in the town of Oberndorf in the Federal Republic of Germany. The town of Oberndorf, located approximately one hours drive south of the city of Stuttgart, is also the same town where the famous arms manufacturer **Mauser** is located.

Heckler & Koch was founded in 1949 by three engineers, Messrs. Heckler, Koch and Seidel as a manufacturer of machine tools, gauges and precision parts. H&K became famous in the 1959 when the new West German Army adopted the H&K G3 assault rifle in caliber 7.62 X 51 mm NATO (.308 Winchester). Since then H&K has designed and manufactured more than one hundred different types of firearms and devices for the most elite and respected military and law enforcement organizations in the world.

There are at present 14 licensed manufacturing plants in the world producing H&K weapons for the host country. H&K MP5's are produced under license in Saudi Arabia, Mexico, Greece, Pakistan, the United Kingdom, and elsewhere. **Only those weapons produced at HK-GmbH are sold, serviced, supported or guaranteed in the U.S. by HK-Inc.**

TECHNICAL SPECIFICATIONS

	MP5A2	MP5A3	MP5-N	MP5SFA2	MP5SFA3	MP5PT	MP5SD1
Caliber	9x19mm Parabelum	9x19mm Parabelum	9x19mm Parabelum	9x19mm Parabelum	9x19mm Parabelum	9x19mm Plastic Trng	9x19mm Parabelum
Operating Principal	Delayed Blowback	Delayed Blowback	Delayed Blowback	Delayed Blowback	Delayed Blowback	Simple Blowback	Delayed Blowback
Bolt System	Roller- Locked	Roller- Locked	Roller- Locked	Roller- Locked	Roller- Locked	Inertia Bolt	Roller- Locked
Ammunition Feed	Curved metal 15 or 30-rd  box magazine						
Modes of Fire 0 - Safe 3 - 3-rd Burst 1 - Semi-auto S - Sustained 2 - 2-rd Burst	0,1,S	0,1,S	0,1,S	0,1	0,1	0,1,S	0,1,S
Cyclic Rate of Fire	725 - 800	725 - 800	725 - 800	N/A	N/A	700	725 - 800
Rifling	6 Grooves R.H.;  1 turn in 9.86"						
Sights Mechanical	Rotary rear sight w/4 peep apertures, adjustable for windage & elevation, fixed front sight post						
Optical	Any optical device using H&K's claw lock-on scope mounts						
Weight							
w/o Magazine (b(kg))							6.17 (2.79)
w/ Buttcap							
w/ Fixed stock	5.59 (2.54)				5.59 (2.54)	5.59 (2.54)	
w/ Retractable stock		6.34 (2.88)	6.34 (2.88)		6.34 (2.88)	6.34 (2.88)	
w/ Folding stock							
Empty magazine oz(g)							
15 round	4.23 (119)	4.23 (119)	4.23 (119)	4.23 (119)	4.23 (119)	4.23 (119)	4.23 (119)
30 round	6.0 (170)	6.0 (170)	6.0 (170)	6.0 (170)	6.0 (170)	6.0 (170)	6.0 (170)
Cartridge oz(g)	.42 (12)	.42 (12)	.42 (12)	.42 (12)	.42 (12)	.07 (2)	.42 (12)
Trigger pull lb(N)	5.6 - 7.9 (25 - 35)	5.6 - 7.9 (25 - 35)	5.6 - 7.9 (25 - 35)	5.6 - 7.9 (25 - 35)	5.6 - 7.9 (25 - 35)	5.6 - 7.9 (25 - 35)	5.6 - 7.9 (25 - 35)
Length in(mm)							
Barrel	8.85 (225)	8.85 (225)	8.85 (225)	8.85 (225)	8.85 (225)	8.85 (225)	5.73 (146)
w/ Buttcap							21.67 (550)
w/ Fixed stock	26.77 (680)				26.77 (680)	26.77 (680)	
w/ Retractable stock		25.98 (660)/	25.98 (660)/		25.98 (660)/	25.98 (660)/	
extended/retracted		19.29 (490)	19.29 (490)		19.29 (490)	19.29 (490)	
w/ Folding stock							
extended/folded							
Sight radius	13.38 (340)	13.38 (340)	13.38 (340)	13.38 (340)	13.38 (340)	13.38 (340)	13.38 (340)
Width in(mm)							
w/ Stock folded	1.96 (50)	1.96 (50)	1.96 (50)	1.96 (50)	1.96 (50)	1.96 (50)	2.36 (60)
Height in(mm)	8.26 (210)	8.26 (210)	8.26 (210)	8.26 (210)	8.26 (210)	8.26 (210)	8.26 (210)
Locking piece Degree/Marking	100 / None	100 / None	100 / None	100 / None	100 / None	100 / None	120 / 5

TECHNICAL SPECIFICATIONS (cont.)

	MP5SD2	MP5SD3	MP5K	MP5K-W	MP5K-POW	MP5/10A2 & MP5/40A2	MP5/10A3 & MP5/40A3
Caliber	9x19mm Parabelum	9x19mm Parabelum	9x19mm Parabelum	9x19mm Parabelum	9x19mm Parabelum	10mm Auto/.40 S&W	10mm Auto/.40 S&W
Operating Principal	Delayed Blowback	Delayed Blowback	Delayed Blowback	Delayed Blowback	Delayed Blowback	Delayed Blowback	Delayed Blowback
Bolt System	Roller-Locked	Roller-Locked	Roller-Locked	Roller-Locked	Roller-Locked	Roller-Locked	Roller-Locked
Ammunition Feed	Curved metal 15 or 30-rd box magazine					Straight synthetic 30-rd box magazine	
Modes of Fire 0 - Safe 3 - 3-rd Burst 1 - Semi-auto S - Sustained 2 - 2-rd Burst	0,1,S	0,1,S	0,1,S	0,1,S	0,1,S	0,1,S	0,1,S
Cyclic Rate of Fire	725 - 800	725 - 800	900	900	900	800	800
Rifling	6 Grooves R.H.; 1 turn in 9.86"					6 Grooves R.H.; 1 turn in 15"	6 Grooves R.H.; 1 turn in 15"
Sights Mechanical	Same as MP5A2		Rotary rear w/4 U-shaped apertures, adjustable for windage/elevation			Same as MP5A2	
Optical	Any optical device using M&K's claw lock-on scope mounts						
Weight							
w/o Magazine lb(kg)			4.4 (2.0)	4.4 (2.0)	4.4 (2.0)		
w/ Buttcap							
w/ Fixed stock	6.83 (3.1)					5.88 (2.67)	
w/ Retractable stock		7.5 (3.4)					6.28 (2.85)
w/ Folding stock					6.14 (2.79)		
Empty magazine oz(g)							
15 round	4.23 (119)	4.23 (119)	4.23 (119)	4.23 (119)	4.23 (119)		
30 round	6.0 (170)	6.0 (170)	6.0 (170)	6.0 (170)	6.0 (170)	4.0 (113)	4.0 (113)
Cartridge oz (g)	.42 (12)	.42 (12)	.42 (12)	.42 (12)	.42 (12)	.61 (17.3)	.61 (17.3)
Trigger pull lb(N)	5.6 - 7.9 (25 - 35)	5.6 - 7.9 (25 - 35)	5.6 - 7.9 (25 - 35)	5.6 - 7.9 (25 - 35)	5.6 - 7.9 (25 - 35)	5.6 - 7.9 (25 - 35)	5.6 - 7.9 (25 - 35)
Length in(mm)							
Barrel	5.73 (146)	5.73 (146)	4.5 (114)	5.5 (140)	5.5 (140)	8.85 (225)	8.85 (225)
w/ Buttcap			12.8 (325)	13.8 (351)			
w/ Fixed stock	30.42 (773)					26.77 (680)	
w/ Retractable stock extended/retracted		30.42 (773)/23.97 (609)					25.98 (660)/19.29 (490)
w/ Folding stock extended/folded					23.75 (603)/14.50 (368)		
Sight radius	13.38 (340)	13.38 (340)	10.25 (260)	10.25 (260)	10.25 (260)	13.38 (340)	13.38 (340)
Width in(mm)							
w/ Stock folded	2.36 (60)	2.36 (60)	1.96 (50)	1.96 (50)	1.96 (50)	1.96 (50)	1.96 (50)
					2.80 (71)		
Height in(mm)	8.26 (210)	8.26 (210)	8.26 (210)	8.26 (210)	8.26 (210)	8.26 (210)	8.26 (210)
Locking piece Degree/Marking	120 / 5	120 / 5	110 / 16	110 / 16	80 w/ SS/80 110 w/oSS/16	60 / H1 25	90 / L0 24

NOMENCLATURE

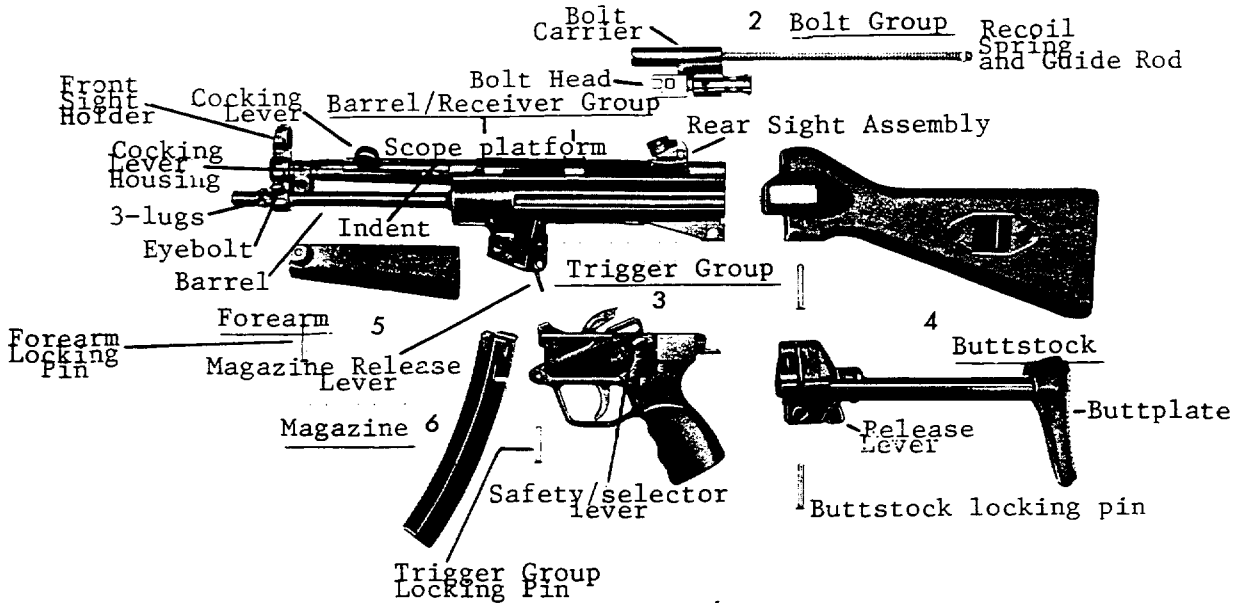

Ill.# 15A - Assembly Groups (MP5A2/A3 pictured)

Note: 1. Assembly Groups (includes carrying sling where applicable)

OPERATING CONTROLS AND THEIR USE

Safety/selector lever - This control is arguably the most important control found on the MP5. Located on the trigger group (pistol grip) of the weapon, actuation of this lever determines whether the weapon will fire and if so in what mode. It therefore acts as both a safety lever and a selector lever on the MP5. This control is normally actuated with the thumb of the firing hand and is located only on the left side of the original "SEF" trigger group or on both sides of the ambidextrous trigger groups. The safety/selector is rotated into the various firing modes or safe position by depressing the tail end of the lever. Tactile clicks (stops) are present at each position to provide a positive stop and to prevent inadvertent rotation.

When rotated into the "safe" position the release of the hammer is blocked by the solid portion of the safety axle located inside the trigger group. Rotating the safety/selector lever into any of the firing modes will allow the hammer to be released and the weapon to fire in the selected mode of operation.

The safety/selector lever should be set at "safe" position at all times unless the weapon is being fired.

Mode of Fire Symbols - Symbols denoting the mode of fire of the MP5 submachine guns are located on the trigger group of the weapon. There are three basic versions of these symbols used over the years on the MP5 in the U.S. They are commonly referred to as the "SEF", the "pictogram" and "numerical" trigger groups symbols, or markings. The common rule of thumb with all H&K trigger groups is white is "safe", red is "fire", or danger. All safety/selector levers can be removed from the trigger group without tools during field stripping.

SEF - Original German markings and very common in the U.S. and world wide. In use from 1960's through the present.

- S - in white denotes **safe** and stands for "Sicher" in German.
- E - in red denotes **semiautomatic** and stands for "Einzelfeuer" in German.
- F - in red denotes **fully automatic** and stands for "Feuerstoss" in German.

The SEF symbols appear on both side of the plastic trigger group. The tail end of the safety/selector lever along with the white indicator line, located on the right side of the axle, is moved into alignment with the appropriate firing mode symbol by the operator prior to squeezing the trigger to fire the weapon. The SEF trigger group is often a bad choice for the left handed shooter as a thumb rest is molded into the left side of the pistol grip for the right handed operator. A better choice for the left handed operator is the ambidextrous trigger group which has a left and right side safety/selector levers and no thumb rest.

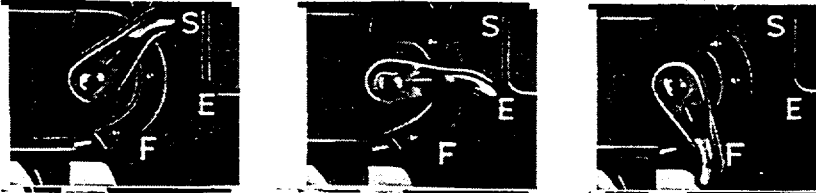



Ill.# 16A - SEF Markings

Pictogram - Newer style markings available on the MP5 beginning in the early 1980's. Often referred to as international symbols for obvious reasons, they are the simplest for all persons to understand as each symbol represents the number of rounds that will be fired when the trigger is pulled and held rearward with a full magazine inserted in the weapon.

 One white bullet in a closed white box denote **safe**.

 One red bullet in a closed red box denotes **semiautomatic**, or one bullet only with each pull of the trigger.

 Two or three red bullets in a closed red box denotes **two or three round burst**, or two or three rounds respectfully with each pull of the trigger.

 Seven red bullets in an open ended red box denotes **fully automatic**, or as many rounds that can be fired before the trigger is released or the magazine is emptied.

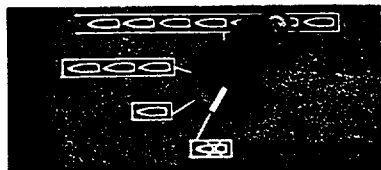

from left

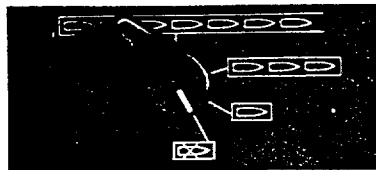

from right

Ill.# 17A - Pictogram Markings

As with the SEF symbols, the pictogram symbols also appear on both sides of the trigger group. To place the weapon in one of the firing modes the tail end of the safety/selector lever is rotated to bring the white indicator line in line with the appropriate symbol. All trigger groups marked with the pictogram symbols are ambidextrous groups without a thumb rest for use by right and left handed operators.

Numerical - The numerical symbols are the least common encountered in the U.S. and could be considered an interim and special order symbol, more often seen overseas. They combine the letter/number symbols similar to the SEF group but provide ambidextrous safety/selector levers and pistol grip.

- S** - in white denotes **safe** and stands for "Sicher" in German.
- E** - in red denotes **semiautomatic** and stands for "Einzelfeuer" in German.
- 3F** - in red denotes **three-shot burst** and stands for "Drei-Schuss-Feuerstoss" in German.
- F** - in red denotes **fully automatic (unlimited)** and stands for "Unbegrenzter Feuerstoss" in German.

The numerical symbols appear on both right and left sides of the trigger group. As is done with the ambidextrous trigger groups with pictogram symbols, the tail end of the safety/selector lever is rotated to bring the white indicator lines into alignment with the desired firing mode.



Ill.# 18A - Numerical Markings

The various modes of fire and their applicable symbols appear in different combinations on the host of optional trigger groups available for the MP5. An individual may find other types of foreign country or user specific symbols on H&K MP5 trigger groups throughout the world that are not mentioned here. Generally the location of the various modes of fire are the same on similar style trigger groups, only the symbol at that position would vary based on the native language or preference of the specific customer for which that item was made.

Cocking Lever - The cocking lever is located above the forearm/foregrip of the MP5 and protrudes from the cocking lever housing (tube) at approximately a 45 degree angle. This solid control is attached to a tubular piece within the cocking lever housing called the cocking lever support which, in turn, makes contact with the forward extension of the bolt group.

The cocking lever is generally operated with the non-firing hand, allowing the firing hand to remain on the trigger group. The position of the cocking lever allows easy actuation without the need to break out of the firing position.

The cocking lever on the MP5 is non-reciprocating and thus does not move with the bolt as it cycles in the weapon. The cocking lever is held in a forward position by a spring detent located in the front end of the cocking lever support which engages in the cocking lever housing. The cocking lever only travels rearward when it is manually operated by the operator.

To lock the bolt rearward, the cocking lever is pulled fully to the rear and rotated slightly clockwise where it can be hooked into the indent in the cocking lever housing. To properly release the bolt forward it is recommended that the cocking lever be "slapped" forward by passing the palm of the non-firing hand from right to left across the top of the weapon and pushing the cocking lever out of the indent. The compressed recoil spring will drive the bolt group forward with more than sufficient force to chamber a round.

Do not ride the cocking lever forward by hooking the fingers around the cocking lever. Slap the cocking lever forward as described above.

The cocking lever is not attached to the bolt group and therefore cannot be used as a forward assist to fully seat the bolt group.

Bolt Catch - The bolt catch, positioned on the left side of the receiver of the weapon above the trigger (see ill. # 9A), is available only on the MP5/10 and MP5/40 submachine guns. This device performs the same function as any conventional bolt catch found on other weapons in the world. That function is to hold the bolt group to the rear anytime the bolt catch release lever is engaged by the operator or by the follower of an empty magazine and the bolt is cycled rearward.

To engage the bolt catch, the bolt catch release lever is pressed upward by a small tab located on the magazine follower. This action in turn positions a metal tab in the way of the bolt as it returns forward. This tab holds the bolt group rearward and the chamber open until the bolt catch release lever is pressed downward by the operator.

Generally, the operator uses his/her non-firing hand to depress the bolt catch release lever to close the bolt of the weapon. The bolt can also be released by removing the empty magazine or replacing it with a loaded magazine and pulling the cocking lever fully rearward and releasing.

While the bolt catch may also be engaged by the operator to lock the bolt open, it is a much similar operation to simply retract and lock the cocking lever into the notch in the cocking lever housing as is done with the 9mm MP5.

There has been a great deal of discussion about the usefulness of a bolt catch on a weapon and the obvious absence of such a device on some H&K weapons, specifically in this case the MP5 in caliber 9mm Parabellum. There are many good, valid reasons that this simple device was not incorporated into the design of the 9mm MP5. These same reasons apply as to why a bolt catch has not been incorporated into the 9mm MP5 even though it exists on the 10mm Auto and .40 S&W caliber MP5's, the H&K G41 rifle and at least three prototype weapons designed by H&K over the past 15 years.

The MP5 submachine gun was designed, like most H&K rifles, without the bolt catch that the American user has grown accustomed to since the M1 Garand rifle was first issued in the 1940's. Since that time the bolt catch has appeared on most, if not all, American service rifles.

Many users of the MP5 have grown up with this feature and feel the MP5 is incomplete without it.

The MP5 was designed for the West German Police and Border guard along the same specifications as the 7.62 X 51 mm NATO G3 rifle issued to the West German Army. The German Army did not want the bolt of the G3 to lock to the rear at any time and leave the most important areas of the weapon, the breech and receiver, open to the intrusion of any debris (sand, dust, water, etc.) that may find its way into the weapon and affect the reliability of the rifle.

Many of us believe that when the bolt locks to the rear it is an immediate indicator that the weapon is empty. Experience, however, has shown that in most cases it is not the bolt but the trigger that tells the firer that the magazine is empty. Most shooters, especially those placed under stress in a shooting scenario, attempt to pull the trigger two or more times before they glance up at the open ejection port to learn that the weapon's empty magazine has locked the bolt to the rear. Pulling the trigger on an empty H&K chamber provides the same indication to the firer that the weapon is empty.

Magazine exchanges with the MP5 are as easily and as quickly accomplished as with any weapon fitted with a bolt catch, especially with proper training and with the use of the optional dual magazine clamps. H&K prefers to train it's students to reload the weapon before the magazine is run dry, thus never leaving the chamber empty and the operator more or less defenseless. Like speedy magazine changes, this is also a learned behavior with proper training.

Why then did H&K add this feature to the other H&K weapons noted above? For no other reason than because so many American users have grown accustomed to this feature on other weapons and some desire it on a submachine gun. With the required changes to the receiver, magazine, magazine well, trigger group and bolt group to chamber the MP5 in calibers 10mm Auto and .40 S&W it was possible to incorporate a bolt catch into the design of these weapons as part of that redesign and in a cost effective manner. Such a modification to the 9mm MP5's to simply add a bolt catch, a feature that offers questionable benefits to an already excellent weapon, would not be cost effective, nor would it be a feature that many MP5 users desire.

Magazine Release - The magazine release on the 9mm MP5's is a redundant control, that is there are two separate controls that can be actuated to disengage the magazine from the weapon. On all MP5's, there is a magazine release lever (paddle) located on the rear side of the magazine housing. This spring actuated lever is normally operated with the non-firing hand. The lever is depressed and held forward with the thumb while the magazine is withdrawn down and out of the magazine well using the four fingers of that same hand. The magazine release lever springs back into position once it is released to engage the newly inserted magazine. The magazine release lever is most often used to remove the magazine over the other magazine release control, the magazine release button.

The magazine release button is located on the right side of the magazine well just above the trigger group locking pin. This textured button only exists on the 9mm MP5's and is not found, for simplicity sake, on the newer 10mm and .40 S&W MP5's. The magazine release button activates the same locking mechanism that this actuated by the magazine release lever. This control is normally depressed with the index finger of the firing hand (right hand shooter) while the firing hand is on the trigger group, if the operators finger is long enough to reach. This gives the right hand user the ability to drop the empty magazine with the firing hand as the non-firing hand retrieves a full magazine, again only if his/her index finger is long enough to reach the button.

Many operators fingers are not and thus this button is seldom used but would be available in the event that something would happen to the magazine release lever and it was not available to release the magazine.

The left hand operator would generally use the thumb of the non-firing hand to depress the magazine release button as the fingers of that same hand remove the magazine from the magazine well. As with the magazine release lever, the magazine release button springs back into position once it is released to engage the newly inserted magazine.

Experienced users of the 9mm MP5's will install the trigger group locking pin from right to left to avoid the chance of the operator depressing the locking pin instead of the magazine release button during a magazine exchange.

ADVANTAGES OF THE WEAPONS SYSTEM

1. Modular Construction
 - * Versatility to reconfigure weapon
 - * Simplified repair and/or replacement of assembly groups
2. Closed-bolt firing position
 - * Higher degree of accuracy and controlability
 - * Greater safety compared to open-bolt designs
 - * Reduced fouling of breech area
3. Recoil operated, delayed roller-locked bolt system
 - * Locked breech. Strong and safe
 - * Reduction of felt recoil
4. Fluted chamber
 - * Equalized pressure on cases. Increased reliability
5. Free-floating, cold hammer forged barrel
 - * Increased accuracy
 - * Longer barrel life. Much higher strength. Safer
6. Light weight and handy
7. True weapons "system"
8. Large number of accessories and options, to include a choice of three calibers
9. Interchangeability of parts without hand fitting

CLEARING PROCEDURE/UNLOAD

The H&K MP5 is not considered "CLEAR" unless the weapon is on "safe", the magazine is removed, the bolt and cocking handle are locked rearward and the chamber is free of any brass or ammunition. NEVER ASSUME THE WEAPON IS CLEAR!!

To clear the MP5:

1. Make certain fingers are outside of the trigger guard and the weapon is pointed in a safe direction at all times!
2. ON SAFE - Rotate the safety/selector lever to the "Safe" position. (With the safety/selector lever set at the white box with a white bullet symbol inside or the white "S". See illustrations on page 16 - 18.)

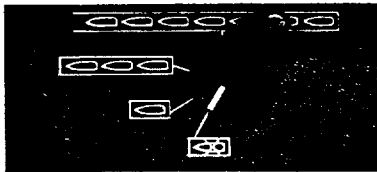

from left

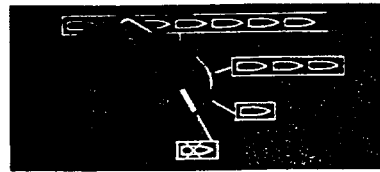

from right

Ill.# 23A - Safety/selector lever set on "SAFE"

3. REMOVE MAGAZINE - Depress the magazine release lever or button and remove the magazine from the magazine well.



Ill.# 23B - Removing the magazine

4. COCKING LEVER - Rotate the ejection port towards the ground and pull the cocking lever rearward one or more times to insure the chamber is empty. Watch for live round or empty case to be ejected.

Rotate the cocking lever upward slightly and lock it into the detent in the cocking lever housing to lock the bolt open.



Ill.# 24A - Retracting the cocking lever

5. **INSPECT CHAMBER** - Inspect chamber for presence of live round or empty case.
 - A. Visually - View chamber through open ejection port.
 - B. Physically - Insert index finger through magazine well and check for presence of a round or cartridge case in chamber.

(Add photo of index finger checking chamber thru mag well)

Ill.# 24B - Physically checking the chamber

Remove any live rounds or empty cases from the chamber or from within the weapon or magazine before handling further.

The H&K MP5 submachine gun is now considered "Clear".

FILLING THE MAGAZINE

- Note:
1. Insert only 30 rounds in the 30-round magazine, 15 rounds in the 15-round magazine! The 30-round magazine will accept 31 rounds. However it cannot be fully seated into the magazine well when the weapon is loaded with the bolt group in a forward position. To insure that only the right number of rounds are loaded:
 - A. Count the rounds as they are loaded and/or;
 - B. Look for only the bottom half of the first loaded round through the bottom ammunition viewing window located on the rear side of the magazine housing and/or;
 - C. Load the magazine to capacity and remove one round.
 2. The ammunition viewing windows, located in the back of the magazine housing, denote the number of rounds inside when the bottom half of the first loaded round is visible through a given hole. In the 30-round magazines each hole represents increments of 10 rounds, 5 rounds in the 15-round magazine.

LOADING PROCEDURE

1. Administrative Loading - Method A (Weapon in "Clear" condition, cocking lever locked rearward, safety-selector lever in "Safe" position.)

Used to initially load the weapon before it is to be fired.

- A. **Make certain fingers are outside of trigger guard and the weapon is pointed in a safe direction at all times!**
- B. Insert magazine firmly into magazine well. Tug on magazine to ensure that it is fully seated and engaged.

- C. With the open palm of the non-firing hand, slap the cocking lever out of the engagement notch and forward in one motion. **DO NOT** ride the cocking lever forward when loading or the round may not fully chamber!

CAUTION: The weapon is now loaded!

2. **Administrative Reloading** - Method B (Weapon with cocking lever and bolt group in a forward position.)

Used to quickly reload the weapon once firing has begun.

- A. **Make certain that fingers are outside of trigger guard and the weapon is pointed in a safe direction at all times!**
- B. Depress magazine release and remove empty or partially loaded magazine from weapon.
- C. Insert full magazine firmly into magazine well. Tug on magazine to ensure that it is fully seated and engaged.
- D. Using the non-firing hand, pull the cocking lever fully to the rear and release. **DO NOT** ride the cocking lever forward when loading or the round may not fully chamber!

CAUTION: The weapon is now loaded!

Note:

1. Practice exchanging magazines before they become empty. Doing so and using the Tactical Reloading method will allow you to reload the weapon while still having a round immediately available in the chamber.
2. Due to the unique design of the H&K MP5 submachine gun, the bolt will not lock to the rear when the magazine is empty, except on the MP5/10 and MP5/40.

SAFETY RULES

- Safety Rule # 1** Treat every weapon as if it were loaded.
- Safety Rule # 2** Never point a weapon at anything or anybody that you do not intend to shoot, or in a direction where an unintentional discharge may result in damage to property, injury or death.
- Safety Rule # 3** Never place your finger into the trigger guard until you are ready to fire the weapon.
- Safety Rule # 4** Be sure of your target and of what's behind it before firing! At 25 meters, even a 9mm projectile can easily penetrate wood or plasterboard walls or a car door and may travel more than 1 mile!
- Safety Rule # 5** Ensure that all parts of your hands and body are kept away from the muzzle of the weapon **at all times!**
- Safety Rule # 6** Always wear eye (with side protection when firing on steel targets) and ear protection when firing any firearm.
- Safety Rule # 7** Clear every weapon **before handling it.**

FIRING PROCEDURE

1. **SELECT FIRING MODE** - Using the firing thumb, rotate the safety/selector lever into the firing position of choice. (Marked with a red bullet(s) in a closed red box or a red letter "E" for semi-automatic or "F" for fully-automatic.)
2. **PLACE FINGER ON TRIGGER** - Place the finger on the trigger only once you have decided to actually fire a round down range. Place the pad of the index finger (the meaty portion located between the tip and the first joint) on the center of the trigger.
3. **TAKE UP SLACK AND PRESS** - Take up the slack. Press the trigger straight to the rear at an even pace and with consistent pressure until the hammer falls. (A new MP5 has a trigger pull ranging between 6.2 - 7.9 pounds.)
4. **REMOVE FINGER FROM TRIGGER GUARD** - Remove the finger from the trigger and outside of the trigger guard once you have finished firing or anytime you are moving.

IMMEDIATE ACTION

Immediate Action is the action performed immediately by the firer any time there is an unscheduled or unanticipated interruption of the weapons operation when a back-up weapon is unavailable to transition to. Immediate Action should be practiced to the point that it occurs as a reflex action.

The "SPORT" method of immediate action, described below, is one method to quickly remedy most stoppages that may occur with the H&K MP5 submachine gun or other small arms. These steps must be performed in the sequence shown below.

S - SEEK COVER & SLAP the base of the magazine with the non-firing palm to fully seat the magazine.

P - PULL the cocking lever rearward and hold back.

O - OBSERVE through the open ejection port for:

1. Ejected round or empty case
2. Obstruction in chamber or receiver
3. Next round(s) waiting in magazine

If the chamber and receiver are clear, chamber a new round. If they are not, remove the magazine and clear the obstruction by working the cocking lever. If the magazine is simply empty, exchange it for a full one and chamber a round.

R - RELEASE the cocking lever to chamber a fresh round.

T - TRY AGAIN to fire the weapon.

If the weapon still fails to fire check for:

1. Obstruction in the chamber and/or receiver, i.e., empty case, ruptured case, foreign matter, etc.
2. Faulty magazine. Bent feeding lips or cracked housing.
3. Bad ammunition
4. Improperly assembled or incomplete weapon or magazine.

Correct any deficiencies found and resume firing.

OPERATOR DISASSEMBLY

Weapon

1. **CLEAR WEAPON!**
2. **BOLT FORWARD** - Place bolt group and cocking lever in the forward position.
3. **REMOVE SOUND SUPPRESSOR** - Remove suppressor. Attach thread cap. (where applicable)
4. **REMOVE SLING** - Remove multi-purpose carrying sling. (where applicable)
5. **REMOVE PIN AND BUTTSTOCK** - Remove buttstock locking pin(s) and buttstock or buttcap.

NOTE: **DO NOT lay the locking pins down!** To prevent misplacing them, place them back in the hole(s) in the receiver once the assembly group has been removed.

6. **LOWER TRIGGER GROUP** - Pivot the rear end of the trigger group downward away from receiver and slide the complete bolt group out of the back of the receiver.
7. **REMOVE PIN AND TRIGGER GROUP** - Remove trigger group locking pin and trigger group. Store locking pin in receiver.
8. **REMOVE PIN AND FOREARM/FOREGRIP** - Remove forearm (handguard) locking pin (except MP5SD) and forearm/foregrip. Store locking pin in receiver.

Remove the forearm of the MP5SD by lifting up the springsteel forearm with a taped flathead screwdriver inserted between the forearm and the sound suppressor casing (metal bird cage) above the oval depression located at the forearms mid-point. Gently pry the forearm off the receiver using the screwdriver.

9. **REMOVE ACCESSORIES** - Remove any accessories, where applicable, such as a flash hider or blank firing attachment. (See page 90 "Use of Optional Accessories".)

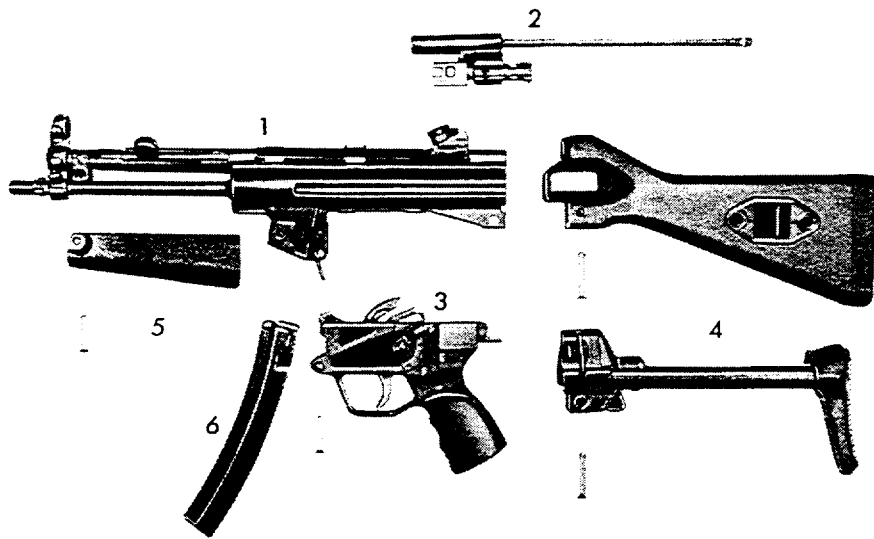

Ill.# 31A - Assembly Groups - MP5A2/A3 pictured

Assembly Groups

1. Bolt Group -

- Notes: A. **DO NOT** remove the recoil spring and guide rod from the bolt carrier as it unnecessarily wears out the nylon washers that are difficult to replace.
- B. **DO NOT** remove the extractor spring, extractor, locking rollers or locking roller holder from the bolt head! Only an H&K factory trained armorer should remove these parts.

- 1.) **Remove Bolt Head** - Viewing the bolt group from the front, rotate the bolt head in a clockwise direction approximately 1/8 turn and lift off of locking piece.
- 2.) **Remove Locking Piece** - Continue rotating locking piece in a clockwise direction about 1/8 of a turn until it can be lifted from the bolt carrier.

Note the number, if any, engraved on the top side of the locking piece. This same numbered locking piece should be reinstalled in the weapon during reassembly. (See the list on page 13 "Technical Specifications" for the correct numbered locking piece for each model and variation of the MP5.

- 3.) **Remove firing pin and firing pin spring** - Lift the firing pin with spring out of the oval recess in the front of the bolt carrier.

OPERATOR DISASSEMBLY OF THE BOLT GROUP IS COMPLETE.

2. **Trigger Group -**

A. **"SEF" Group**

- 1.) **Rotate safety/selector lever** - Rotate the safety/selector lever in a counter clockwise direction past the "safe" position until the lever is point up at a 12 o'clock position.
- 2.) **Remove safety/selector lever** - Lift the safety/selector out of the left side of the trigger group.
- 3.) **Remove trigger mechanism** - Grasp the top of the trigger mechanism by the hammer, ejector and release lever and pull the entire subassembly from the plastic grip.

OPERATOR DISASSEMBLY OF THE "SEF" TRIGGER GROUP IS NOW COMPLETE.

B. **Ambidextrous Groups (Navy, SF, 2 or 3-round burst)**

- Note:
- A. H&K strongly recommends that this trigger group **not be disassembled by the operator** unless absolutely necessary due to the ease that the trigger group can be damaged when incorrectly assembled. Clean the ambidextrous trigger groups using solvent, brushes, compressed air and cotton swabs.

The entire group can be immersed in solvent for cleaning. Disassemble the trigger group only if normal methods of cleaning the interior of the unit prove ineffective.

- B. **DO NOT** force any of these parts in place as they may be damaged in the process! Damage to the components of this item due to incorrect disassembly/reassembly will void the warranty on the item and may result in the need for costly repairs.

- C. **BEFORE DISASSEMBLING THE TRIGGER GROUP WITH 2 or 3-ROUND BURST FIRING MODES**, take notice of the position of the burst counting wheel and its return spring and guide rod. (See numeral 1 in illustration below)

Before and during reassembly of the trigger groups **WITH BURST MODE** make certain that these parts remain parallel with the edge of the trigger housing and hooked on the metal stud. (See numeral 2 in illustration below)

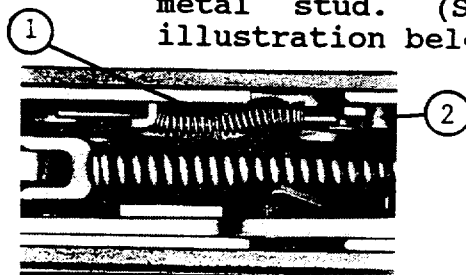

Ill.# 33A - Correct position of burst counting wheel

- 1) **Depress release lever** - Depress the release lever (the lever protruding at an angle from the right side of the trigger group) and allow the hammer to spring up into firing position.
- 2) **On fire and pull trigger** - Place the safety/selector lever in the "fire" position. Pull the trigger and allow the hammer to snap forward.
- 3) **Locate and depress disassembly lever** - Locate the disassembly lever. (See numeral 3 in illustration # 33B below) It is located inside the trigger mechanism above the safety axle and to the left of the long hammer spring. It is bent inward and under considerable spring pressure.

Depress **and hold** the disassembly lever **all the way down** with the right thumb.

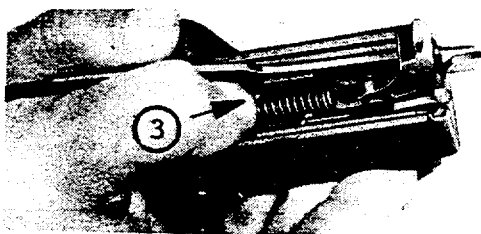

Ill.# 33B - Depressing disassembly lever

- 4) Rotate safety/selector lever - Looking at the left side of the plastic grip, rotate the safety/selector lever in a clockwise direction nearly one complete turn until it stops with the white indicator line pointing down.

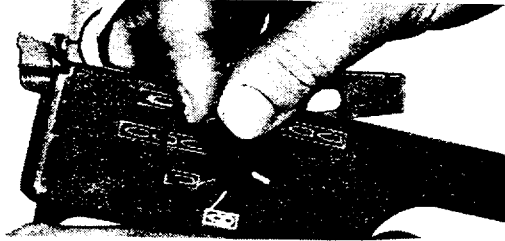

Ill.# 34A - Rotating the safety/selector lever clockwise

- 5) Remove safety/selector lever with axle (left side) - Still depressing the disassembly lever, pull the safety/selector lever with axle (left side) out of the trigger group. Now you can release the disassembly lever.
- 6) Remove safety/selector lever (right side) - Remove the safety/selector lever from the right side of the trigger group.
- 7) Pull trigger mechanism from plastic grip - Grasp the hammer and ejector and pull the interior trigger mechanism out of the plastic grip.

DISASSEMBLY OF THE AMBIDEXTROUS TRIGGER GROUP IS NOW COMPLETE

DO NOT disassemble this assembly group any further! Only an H&K factory trained armorer can disassemble this mechanism.

3. Magazine -

Note: The magazine need not be disassembled for every cleaning. However it should be disassembled and cleaned during Major cleaning, when immersed in water or if there is appreciable fouling inside. You'll need a cleaning rod handle and a small flathead screw driver for disassembly of the 9mm magazine.

CAUTION

SOME COMPONENTS OF THE MAGAZINES (FLOOR PLATE, LOCKING PLATE AND MAGAZINE SPRING) ARE HELD IN PLACE UNDER CONSIDERABLE SPRING PRESSURE. INSURE THE MAGAZINE IS POINTED IN A SAFE DIRECTION (AWAY FROM THE FACE AND EYES) AT ALL TIMES DURING DISASSEMBLY AND ASSEMBLY.

9mm Magazine -

- A. Position magazine - Hold the magazine in the left hand with the floor plate pointing up and the lips resting on the table.
- B. Depress and hold locking plate - Pointing the magazine away from your face insert the cleaning rod into the hole in the base of the floor plate, push down on the locking plate about 2 inches and hold there. Shift your grip so that the left hand is holding the cleaning rod and magazine in place.
- C. Remove floor plate - Take the flathead screwdriver in the right hand and push both floor plate tabs, located on the front and back of the magazine housing, inward to disengage the floor plate.

Remove the floor plate from the base of the housing.
- D. Release locking plate - Slowly and carefully release pressure on the cleaning rod and allow the locking plate and magazine spring to exit the bottom of the housing.

- E. Remove magazine spring, locking plate and follower - Remove the magazine spring with locking plate and follower attached from the housing.

DO NOT remove the locking plate from the magazine spring!

10mm/.40 Magazine -

- A. Depress locking feature - Pointing the magazine away from your face, depress the serrated locking feature located on the bottom of the floor plate.
- B. Partially remove floor plate - While the locking feature is depressed, begin to slide the magazine floor plate off of the magazine housing towards the rear of the magazine.
- C. Contain magazine spring - Use the other hand to keep the magazine spring from shooting out of the magazine housing.
- D. Remove floor plate - Slide the floor plate completely out of the magazine housing.
- E. Remove magazine spring and follower - Remove the magazine spring and follower from the housing.

OPERATOR DISASSEMBLY OF THE MAGAZINE IS NOW COMPLETE

OPERATOR DISASSEMBLY OF THE H&K MP5 SUBMACHINE GUN IS NOW COMPLETE. ONLY A H&K FACTORY TRAINED ARMORER MAY PROCEED BEYOND THIS LEVEL OF DISASSEMBLY.

REASSEMBLY

The H&K MP5 submachine gun is basically reassembled in the reverse sequence of which it was disassembled.

Assembly Groups

1. Magazine - 9MM

- A. Place magazine follower on magazine spring - Place the magazine follower over the top of the magazine spring as pictured below.
- B. Insert follower and spring - Slide the magazine follower with magazine spring and locking plate attached into the magazine housing.



Ill.# 37A - Correct assembly of the 9mm magazine components

- C. Insert cleaning rod - Insert the cleaning rod handle through the bottom of the floor plate. Push the locking plate down against spring pressure into the magazine housing to a point approximately one inch below the bottom of the housing and hold it in that position.
- D. Install floor plate - Slide the floor plate down the cleaning rod and insert the tabs of the floor plate into the magazine housing until they engage in the slots provided on the front and rear edges of the housing.
- E. Carefully remove cleaning rod - Taking care that the floor plate is secure, slowly release pressure on the cleaning rod allowing the locking plate to come to rest on the floor plate.

- Note:
- A. When properly assembled, the locking plate should rest directly against the inside of the floor plate thus preventing the tabs of the floor plate from disengaging from the slots in the housing. Tap the base of the magazine on the table to fully seat a sticky locking plate. A drop of lubricant will also help.
 - B. Using the cleaning rod handle, push down on the follower. It should move freely and return under spring pressure.

Magazine - 10mm/.40

- A. Place magazine follower on magazine spring - Place either end of the magazine spring onto the base of the follower.
- B. Insert follower and spring - Slide the entire assembly into the magazine housing. Make sure that the tab located on the rear left corner of the follower, used to actuate the bolt catch, is inserted at the rear left corner of the housing.
- C. Compress spring - Compress and hold the spring into the housing.
- D. Install floor plate - With the other hand, insert the floor plate into the groove provided in the base of the housing so that the serrated locking feature is positioned closest to the rear edge of the magazine housing. Push the floor plate into position until the serrated locking feature snaps into place on the housing.
- E. Check for proper assembly - Check that the floor plate is positively engaged, that the magazine follower moves freely in the housing and rests against the lips of the magazine, and that the tab on the follower that actuates the bolt catch is visible through the slot provided at the rear left corner of the magazine housing.

2. Trigger Group -

Note: **DO NOT** use force to assemble the trigger groups or damage to the components may occur. Read through the instructions completely before beginning the procedure. Follow these instructions carefully and you will have no problem reassembling this device.

A. "SEF" Group -

- 1.) **Insert trigger mechanism** - Fully insert the trigger mechanism down into the plastic grip until the hole for the safety/selector lever lines up.
- 2.) **Install safety/selector lever** - Insuring that the hammer is forward, insert the axle of the safety/selector lever from left to right fully into the trigger group with the lever pointing up at a 12 o'clock position.
- 3.) **Press and rotate safety/selector lever** - Press in on the safety/selector lever against spring tension and rotate it in a clockwise direction (as viewed from the left side) into the safe position.

B. **Ambidextrous Group** - (Review the disassembly procedure for this item found earlier in this document **before** reassembly.)

Note: **DO NOT** force any of the components of the ambidextrous trigger group into place or try to rotate the safety/selector lever using any force at all during reassembly **or damage to the unit will occur.**

- 1) **Release hammer** - Start this procedure with the hammer in the forward position (at rest).
- 2) **Insert the trigger mechanism** - Push the trigger mechanism into the plastic grip all the way until the hole for the safety axle is aligned.

- 3) Check burst counting wheel - BURST GROUPS ONLY - Make certain that the burst counting wheel, return spring and guide rod are correctly positioned in the mechanism as described in the procedure for disassembly.
- 4) Depress disassembly lever and hold - Push all the way down on the disassembly lever with the right thumb and hold it in that position.
- 5) Insert the safety lever with axle (left side) - With the left hand gently insert the safety lever with axle (left side) into the hole in the left side of the plastic grip ensuring that the white indicator line points down. Jiggle the safety lever with axle as you push it all the way in and flush with the plastic grip.

Make certain the burst counting wheel, found only in 2 and 3 round burst groups, stays properly positioned at all times during reassembly!
- 6) Press in on left safety lever and hold - Hold the safety lever with axle tight and flush against the plastic grip by applying inward pressure with the left thumb. (There should be no gap between the plastic safety lever and the plastic grip!) DO NOT release inward pressure on the safety lever!
- 7) Release disassembly lever - Only now can you release the disassembly lever once the safety lever with axle (left side) is fully installed in the trigger group.
- 8) Insert the safety lever (right side) - Still applying pressure on the safety lever with the left thumb, insert the right side safety lever in the hole on the right side of the plastic grip with the white indicator line also pointing down.

- 9) Press in on and rotate safety levers - Pushing in on the right and left side levers with the right and left thumbs, rotate the two levers together in a counter clockwise direction (viewing the trigger group from the left side) always applying that inward pressure.

Note: Do not force the safety/selector levers to rotate or damage will occur. These levers should rotate freely and easily when assembled correctly. See your unit armorer if they do not.

Continue to rotate the safety levers until they stop with the white indicator lines pointing to the "safe" position.

Note: If the levers do not rotate easily, remove them and start again at step 4). The plastic safety levers must rest directly against the plastic grip before you attempt to rotate them into position.

3. Bolt group -

- A. Place firing pin spring on firing pin - Place the firing pin spring over the long end of the firing pin.
- B. Install firing pin with spring in bolt carrier Place the firing pin with spring into the large opening in the front lower portion of the bolt carrier. The pointed end of the firing pin should point out of the front of the bolt carrier.
- C. Install correct locking piece in bolt carrier Place the correct locking piece (see "Correct Locking Piece", page 59) over the firing pin. Push down against the firing pin spring and insert the tab, located on the cylindrical portion of the locking piece, into the oblong notch provided at the 6 o'clock position. Push all the way in on and rotate the locking piece in a counter clockwise direction about an eighth of a turn.

- D. **Install the bolt head** - Place the bolt head over the locking piece and fully rotate the bolt head and locking piece counter clockwise until they are in a locked, upright position.

Note: If you removed the recoil spring and guide rod from the bolt group, **YOU'RE WRONG!** Do not remove this component from the bolt group during operator disassembly or cleaning.

Weapon

1. **Install accessories** - Install any accessories in accordance with the instructions found in the section "Use of Optional Accessories" which begins on page 90.
2. **Install forearm/foregrip** - Install forearm (handguard or foregrip). **Remove stowed locking pin!** Insert small locking pin to secure the forearm or foregrip.

(H&K's International Training Division suggests installing these locking pins from left to right to reduce the chances of these pins being accidentally pushed out when the weapon is slung against the operators body and/or equipment.)

To reinstall the MP5SD springsteel forearm, expand either end of the forearm with your hands and slip the end over the front of the receiver below the front sight holder. **Insuring your fingers and palms stay away from the edges of the forearm**, slide the handguard down into position until it snaps in place on the receiver.

3. **Insert the bolt group** - Hold the bolt group in the palm of the hand. Hold the locking rollers in with the index finger and thumb. Slide the entire group into the rear of the receiver all the way in until the recoil spring and guide rod disappear.
4. **Attach the trigger group** - **Remove stowed locking pin!** **Cock the hammer back** and align the locking pin hole in the trigger group with the corresponding hole located at the rear of the magazine well. Insert small locking pin to secure the trigger group.

5. **Install the buttstock/buttcap** - Remove stowed locking pin(s)! (Retractable buttstocks come off and go on more easily when retracted!) Place the thumb of the left hand through the trigger guard and pull and hold the trigger group up towards the top of the receiver. Align the forks of the buttstock with the grooves in the receiver and push it fully into place. Install the large locking pin to secure the buttstock.

Buttcaps of the MP5-K's are installed into the back end of the receiver and retained with the two small locking pins.

6. **Attach the sound suppressor** - Attach the sound suppressor, where applicable, to the weapon and hand tighten only. Store the protective thread cap of the "Navy" model MP5's, MP5/10 and MP5/40 in the cavity of the pistol grip on the optional **holder for thread cap**, available from H&K under ID# 205483, or in a secure, dry place in your personal equipment.
7. **Attach the carrying sling** - (See page 75, "Use of the Multi-purpose Carrying Sling")

Reassembly of the H&K MP5 submachine gun is now complete.

Clear the weapon and perform a Function Check to ensure that the weapon is assembled properly.

How many locking pins did you lay down during disassembly and reassembly? The only right answer is 0.

FUNCTION CHECK

Note: A. A Function Check should be performed anytime the weapon is reassembled. This quick check indicates whether or not the weapon has been properly assembled and/or assembled with all components. A properly executed Function Check can also reveal many of the more obvious malfunctions that could occur between the interactive components of the weapon.

B. **ALWAYS** clear the weapon before performing the Function Check! **Don't ASS U ME the weapon is clear!**

1. Clear the weapon.
2. Place the cocking handle and bolt group in the forward position.
3. With the weapon on "Safe", pull the trigger. **Hammer should not fall.**
4. Place the weapon on "Semi-automatic". Pull the trigger **and hold the trigger back.** **Hammer should fall.**
5. **Still holding the trigger back,** recock the weapon. Release the trigger. Listen for the "click" of the trigger and sear resetting. Pull the trigger. **Hammer should fall.**
6. Place the weapon on "Burst", if applicable. Recock the weapon. Pull the trigger **and hold the trigger back.** **Hammer should fall.**
7. **Still holding the trigger back,** recock the weapon. Release the trigger. You **should not** hear the hammer fall. (The hammer should already be forward.)
8. Place the weapon on "Fully-automatic", if applicable. Recock the weapon. Pull the trigger **and hold the trigger back.** **Hammer should fall.**
9. **Still holding the trigger back,** recock the weapon. Release the trigger. You **should not** hear the hammer fall. (Again, the hammer should already be forward.)

The Function Check is now complete.

Note: You may check the function of the burst mode of the trigger group when the group is off of the weapon before reassembly. Perform the same steps list above but you will manipulate the hammer and release lever with your hand instead of with the bolt group through the cocking handle when the weapon is assembled.

When checking the 2-round burst mode, you will want the hammer to move forward (when you press down on the release lever) only two times between every release of the trigger. On the 3-round burst mode, the hammer should move forward three times.

OPERATING PRINCIPLE

General - The MP5 submachine gun is a delayed blowback operated weapon utilizing a roller-locked bolt. The weapon fires from a closed bolt (bolt forward) position and employs a fixed barrel. At the moment of cartridge ignition the bolt is positively locked to the barrel extension, the cylindrical component that the barrel is pressed and pinned into, which in turn is welded to the receiver.

The weapon's operating principle is often described as "recoil operation". Loosely speaking, this is the German translation of "blowback operation". The bolt group of the MP5 is driven rearward as a result of the pressure created by the expanding propellant gases produced from the burning powder in the cartridge case and the recoil energy produced by that gas pressure which acts upon components of the weapon not directly exposed to the actual propellant gases. It is therefore easy to understand why this style operating principle might be termed as recoil operation by the German designers as the recoil energy does contribute greatly to the actuation of the weapon and it's component parts beyond the point where the gas pressure directly contacts the operating parts.

In the English language, using the definition of "recoil operation" to describe the operating principle of the MP5 is often misleading as the typical English description of "recoil operation" includes a barrel that recoils rearward along with the bolt group during the unlocking stage. The barrel of the MP5 is of course fixed and does not recoil with the bolt group. The difference is strictly the definition of the type of operation.

As a "delayed blowback" weapon the MP5 differs from a "simple blowback" weapon in the important difference that the bolt group of the MP5 is, at the moment of cartridge ignition, rigidly locked to the barrel extension of the weapon, and thus the chamber is sealed, until the projectile has left the barrel and the gas pressure within the bore has dropped to a safe level. This delay is caused by the pair of locking rollers positioned within the bolt group of the MP5.

Operating Cycle - There are eight steps in the operating cycle of the MP5 submachine gun. They are listed in the text below in bold print and in parenthesis. They are:

- * **Firing** - Ignition of the cartridge.
- * **Unlocking** - Actuation of the breech mechanism that results in the opening of the chamber.
- * **Extraction** - Removal of the cartridge case from the chamber.
- * **Ejection** - Expulsion of the cartridge case from the weapon.
- * **Cocking** - The resetting of and storage of energy in the mechanism which provides the energy to ignite the primer of a live cartridge.
- * **Feeding** - The transference of the live cartridge from the feed mechanism in the direction of the chamber.
- * **Chambering** - The insertion of the live cartridge into the chamber of the weapon.
- * **Locking** - The actuation of the breech mechanism that results in the closing, and sealing, of the chamber.

MP5 Bolt Group Operation - The weapon is loaded, the hammer is cocked and the safety/selector lever is set on "fire".

Pulling the trigger releases the cocked hammer, which strikes the firing pin. The firing pin is driven forward against the resistance of the inertia style firing pin. If the bolt group is fully forward and locked to the barrel extension, the firing pin will possess sufficient length to reach the primer of the chambered round through the bolt head. If the bolt group is not fully forward, the firing pin will not strike the primer. Assuming that the firing pin does strike the primer the primer will in turn ignite the propellant powder within the cartridge case (**Firing**).

The propellant gases generated force the projectile through the barrel. Gas fills the shallow flutes cut along the length of the chamber to prevent the cartridge case from expanding and sticking to the inside walls of the chamber.

Propellant gases exert pressure on the cartridge case in all directions. This force is transferred through the base of the cartridge case to the bolt head. (See illustration # 47A below)

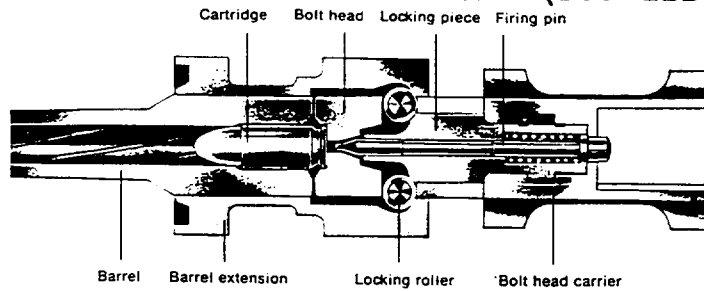

Ill.# 47A - Bolt group in locked (closed) position, ready for firing

A portion of these forces is transmitted through the locking rollers to the locking recesses in the barrel extension and to the angled shoulders of the locking piece. The balanced angular ratio of the locking piece and the locking recesses transfer a portion of the total recoil force into the receiver through the locking recesses and, more importantly, into the bolt carrier which is attached to the locking piece. There is a calculated delay to allow the projectile to exit the barrel and the gas pressure to drop to a safe level before the chamber opens. The delay results from the amount of time it takes for enough recoil energy to be transferred through to the bolt carrier in a sufficient quantity for it to be driven to the rear against the forces of inertia of the bolt carrier and the forward pressure exerted against the bolt group by the recoil spring.

As the bolt carrier is forced rearward the locking piece is withdrawn from the bolt head and the locking rollers can be cammed into the bolt head by the locking roller recesses in the barrel extension. Only once the locking rollers are fully cammed into the bolt head can the entire bolt group begin its rearward movement in the receiver. At that same time the seal is broken on the chamber. (Unlocking) See illustration # 47B below.

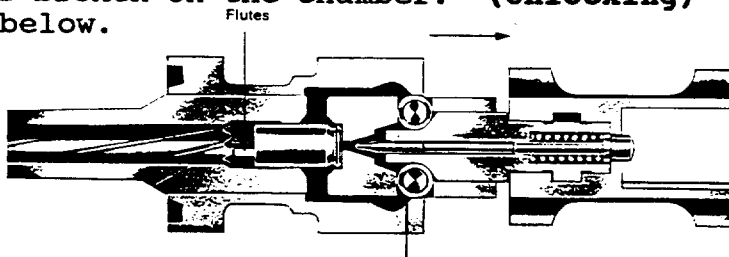

Ill.# 47B - Bolt group in unlocked position

In the course of the rearward movement of the bolt group the cartridge case is pushed from the chamber of the weapon by residual gas pressure. (Extraction)

The cartridge case is held securely in place on the bolt head by the extractor until the front tip of the ejector strikes the rim of the cartridge case as the bolt recoils rearward. The front end of the ejector is pivoted up into position through the bottom of the bolt head to strike the cartridge case as a result of the rear of the ejector being pushed down by the recoiling bolt carrier. At that moment the case is propelled from the weapon through the open ejection port. (Ejection)

As the bolt group travels rearward energy is stored in the recoil spring as it is compressed by the bolt group. At the same time the hammer is depressed to a point where it can be retained by the sear or catch. (Cocking)

Once the bolt has reached its rearward most position, it begins its forward travel as a result of the energy stored in the compressed recoil spring. As the bolt nears the magazine, the ejector spring that was compressed during the ejection stage now forces the rear of the ejector up and the front of the ejector down and out of the way of the bolt group. If a cartridge is present in the magazine the compressed magazine spring will lift the cartridge into a position under the magazine lips. The lower portion of the bolt head drives the cartridge from the magazine. (Feeding)

In the 9mm MP5, when the magazine is empty, the bolt travels forward over the magazine follower. In the 10mm and .40 S&W caliber MP5's, the small tab located on the rear left corner of the magazine follower lifts the bolt catch into a position where it can impede the forward progress of the bolt group, thus locking the bolt open.

The cartridge, pushed from the magazine by the bolt group, is directed into the open chamber. (Chambering) As the cartridge assumes a horizontal position during feeding the rim of the cartridge cases snaps in under the lip of the extractor and is therefore held securely in place on the face of the bolt head.

As the front edge of the cartridge case makes contact with the shoulder in the chamber the face of the bolt head contacts the rear of the chamber which stops its forward movement. The bolt carrier, however, is still free to move forward as a result of the gap that exists between it and the bolt head.

The forward movement of the bolt carrier pushes the locking piece through the bolt head. The angles located on the front shoulders of the locking piece force the locking rollers into the locking recesses in the barrel extension.

Once the locking rollers are fully engaged in these recesses the locking piece and bolt carrier stop their forward progress. (Locking)

The cartridge is now chambered, the bolt locked and the weapon is ready for the firing.

MP5 Trigger Group Operation -

Safe - When the safety/selector lever is set in the safe position, the solid portion of the safety axle is presented to the rear extension of the trigger. The safety axle blocks the movement of the trigger which in turn prevents the sear from being disengaged from the sear notch located in the hammer.

Semiautomatic mode - The safety/selector lever is rotated into the semiautomatic position. The hammer is held rearward in a cocked position by the engagement of the front top corner of the sear in the rearmost notch (sear notch) of the hammer. The hammer spring is compressed on the hammer strut. The rear end of the sear rests on the top shelf of the trigger. The sear is held rearward by the hammer spring through the hammer and upward by the elbow spring.

As the trigger is pulled a notch located in the rear extension of the trigger passes into a cut out in the safety axle. This cut out allows for sufficient depression of the front of the sear. The sear disengages from the sear notch on the hammer. The hammer begins to rotate on its axis to strike the firing pin due to the energy stored in the compressed hammer spring. Simultaneously, the sear spring pushes the sear forward. As it does the rear end of the sear drops down onto the lower shelf on the trigger thus raising the front top corner of the sear into a position where it can engage the hammer as it is recoiled by the bolt group. As the bolt travels forward the hammer is held in a cocked position by the engagement of the sear in the sear notch on the hammer.

Once the trigger is released, the hammer presses rearward on the sear against the weaker sear spring which causes the rear end of the sear to reset on the top shelf of the trigger. The trigger mechanism is now ready to release the hammer to fire the next round with the next squeeze of the trigger.

Ill.# 49A - Semiautomatic fire

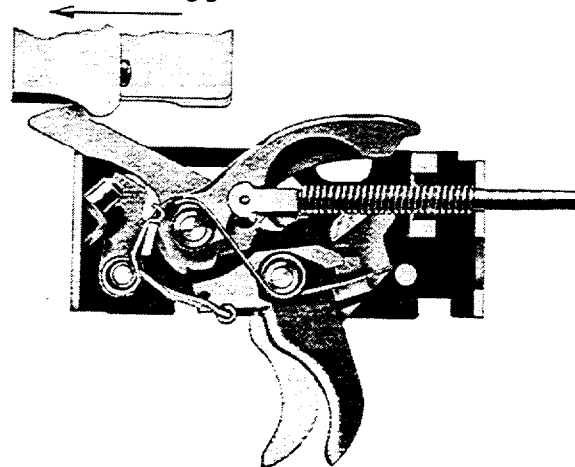

Fully automatic Mode - The first round of fully automatic fire is fired in the same manner as a semiautomatic shot described above. When the safety/selector lever is rotated into the fully automatic mode, the cut out in the safety axle is fully presented to the rear extension of the trigger. This allows the trigger to be pulled further to the rear than in the semiautomatic mode. This drops the front top corner of the sear below the point where the hammer can reengage it as it is recoiled, even when the rear end of the sear jumps down onto the lower shelf on the trigger.

At this point when the bolt group travels forward the hammer is not held rearward by the sear. It is momentarily held rearward by the engagement of the catch in the forward most notch (catch notch) in the hammer. The hammer will be held in that cocked position until the release lever is depressed by the forward moving bolt carrier. Once the bolt group is fully locked the release lever has been depressed to the point where the catch is pressed forward and disengages from the catch notch in the hammer. The hammer is then automatically free to strike the firing pin and fire the weapon. This process continues until the trigger is released or the magazine is emptied.

If the trigger is released the sear is repositioned to reengage in the sear notch, as described above in the description of the semiautomatic mode of fire, and firing is interrupted.

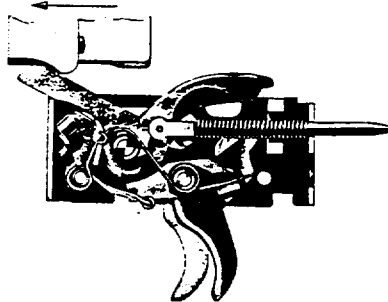

Ill.# 50A - Fully automatic fire

Burst mode - When the safety/selector lever is set on the burst firing position, the axle rotates a toothed counting wheel into position. This toothed count wheel will hold the sear out of engagement with the hammer for the total number of rounds in the burst provided the operator holds the trigger rearward long enough for all rounds to fire. After the last round of the burst is fired the sear is automatically released to engage with and hold the hammer in the cocked position.

Each time the trigger is released, whether the entire burst has been fired or not, the toothed counting wheel will automatically reset at zero to begin the full count over again. Thus, the H&K style burst device is described as having "no memory". It always provides the full burst as long as the trigger is held rearward long enough to allow all two or three rounds to fire.

Advantages of the delayed blowback, roller-locked bolt system

- * Closed bolt operation - safe, accurate, reliable
- * Locked breech - safe
- * Simple, straight-line breech opening and closing
- * Geometrical transmission of recoil energy - less felt recoil
- * Push vs Pull extraction - more reliable
- * Lightweight breech bolt - lightweight weapon
- * Incorporates firing pin safety by design - safe
- * Strong and simple construction - trouble free use
- * Insensitive to ammunition variances
- * Fluted Chamber - more positive extraction, ejection

SAFETIES

1. **Safety/selector lever** - The safety axle, when rotated into the safe position, blocks the movement of the trigger. This in turn prevents the disengagement of the sear from the sear notch on the hammer, thus preventing the weapon from firing should the trigger be pulled or the weapon dropped.
2. **Sear Disconnect** - The sear disconnect prevents the weapon from firing more than one round in the semiautomatic mode of fire. The function of the sear, as described above in section entitled "Trigger Group Operation, Semiautomatic Mode", ensures that even if the trigger is held rearward after the round is fired the sear will catch the hammer and prevent it from riding forward on the bolt carrier where it could possibly strike the firing pin firing.

The design of the trigger mechanism of the MP5 incorporates two strong springs that keep the sear in positive engagement with the hammer notch at all times in the event the weapon is dropped with a round chambered and the safety/selector lever set on "fire".

The sear spring holds the sear forward. The catch spring, and to a lesser extent the trigger spring, hold the sear upwards into engagement with the hammer. This design thus acts as a drop safety function.

The H&K factory requires that the MP5 pass a drop safety test of 1.9 meters (6.23 feet) with a live round in the chamber, the safety-selector lever set at "fire" and the hammer cocked.

3. **Firing pin/bolt group design** - The design of the bolt group, consisting of a separate bolt head and bolt carrier separated by a small gap when unlocked, prevents the firing pin from striking the primer of the cartridge unless the bolt is fully locked forward. This prevents the weapon from firing if the hammer follows the bolt forward, if the bolt is not fully locked or during manual release of the bolt group.

OPERATOR CLEANING

The functional performance of any mechanical device varies greatly on the quality and frequency of the maintenance performed on that item. Firearms are no exception. The operator spends most of the time with the weapon and therefore has the best opportunity to perform the necessary upkeep required to insure top performance at all times.

New MP5's are coated in a thick, oily preservative that should be removed prior to the weapon being used or fired. This preservative oil, applied by H&K personnel prior to the shipment of the weapons from the manufacturing facility in Germany, guarantees that the weapons and accessories will remain corrosion-free during storage and transport. However, this preservative fluid is not considered a lubricant and therefore should be removed and replaced with a high-quality weapons lubricant whenever possible. This preservative fluid attracts debris and dirt and possesses little or no lubricating qualities.

Cleaning the MP5 need not take hours and a great deal of effort. With the right equipment a very fouled MP5 should be able to be thoroughly cleaned in less than 10-12 minutes. A solvent tank where the parts can be immersed in and scrubbed will save a great deal of time and effort as will compressed air to blow off the fouling and solvent or to spread the lubricant. There are companies, such as "Safety-Kleen", that sell or rent such solvent tanks and will exchange the solvent on a regular basis at a reasonable price.

If such a set up is not available to you, a complete weapons cleaning kit specially designed for the H&K MP5 will reduce your cleaning time and make the job easier.

H&K's own "Modular Weapons Cleaning Kit" contains all of the specialty brushes (chamber, bore, and chamber face) designed specifically for thorough cleaning of the H&K MP5. The following cleaning procedures are based on the use of this kit.

Any quality weapons solvent or oil can be used to clean the MP5. Basically, if it's safe to put your bare hands into it won't hurt the surfaces of the weapon. "Break-Free" (CLP), "Ballistol", or any of the other brand-name cleaners or lubricants specifically designed for use with weapons will work well on the MP5.

At H&K we recommend two types of operator cleaning. **Normal** cleaning and **Major** cleaning.

Normal cleaning - Performed after each firing or every twelve (12) months.

Major cleaning - Often referred to as "detailed cleaning". Performed on an unsuppressed MP5 after 1,000 rounds (500 for a suppressed MP5) or when the weapon is exposed to or excessively laden with sand, dust, water or other visible contaminants or foreign matter.

(The cleaning intervals listed here are recommendations only! Your intervals between cleaning will vary greatly depending on many factors to include the type of ammunition used, the environment in which the weapon is operated, and the thoroughness of your cleaning, etc.)

Normal Cleaning -

1. **CLEAR THE WEAPON !**
2. Disassemble the weapon into the major assembly groups.
3. A. **Sound Suppressor**, aluminum or stainless steel (where applicable)

On the MP5SD only, attach the optional Barrel Cleaning Device (H&K ID # 225376) to the end of the sound suppressor body. Push the entire assembly over the end of the barrel all the way down until the cleaning device (similar to a battery terminal cleaning brush used on car batteries) makes contact with the base of the barrel. Rotate the sound suppressor and the cleaning device in a clockwise direction 6-7 complete turns and remove.

This will clean the exterior of the barrel and the thirty (30) barrel ports that vent the propellant gases (and carbon) into the sound suppressor when the weapon is fired.

In a weapon with a severe buildup of carbon on the outside surface of the barrel the sound suppressor may be difficult to unscrew or remove from the barrel. This excessive buildup occurs when the barrel cleaning device is not used frequently enough during and/or after firing. The carbon has accumulated to the point where it bonds the sound suppressor to the threads of the barrel.

At this point a more aggressive cleaning method must be taken. Remove the sound suppressor without using tools. Have one person hold the weapon down while the other unscrews the sound suppressor. For a sound suppressor that is impossible to remove immerse the upper portion of the sound suppressor and barrel in solvent to help loosen the carbon bond. Let the solvent work for one hour. Try again to remove the sound suppressor, with your bare hands only. The use of tools to try and remove the sound suppressor will damage the aluminum housing and destroy the unit. If at this point you can still not unscrew the sound suppressor, contact H&K's Repair Department for further assistance.

Once the sound suppressor is unscrewed it may be difficult to slide it off of the barrel over the ring of carbon built up around the gas ports. Work the sound suppressor back and forth along the length of the barrel to break up the ring of carbon so that it can be removed.

Once the sound suppressor is removed, use a large, flat head screwdriver to scrape away the build up of carbon on the exterior of the barrel only. If possible, cut a dull concave shape into the end of the screwdriver so that it conforms to the outside radius of the barrel to prevent gouging of the barrel's surface. Keep the screwdriver away from the threads and the front one inch of the barrel, which acts as a bearing surface for the sound suppressor. Remove the carbon by holding the screwdriver on a shallow angle attaching the barrel through the slots in the barrel casing. Do not use too much force. Take care only to remove the carbon build up. Once you have finished with the flathead screwdriver, use the barrel cleaning device as described above to clean off the remaining carbon particles.

For all H&K Sound Suppressors - Use a nylon bristle toothbrush and rag or swab to remove all fouling from the threads of the sound suppressor. Tap the sound suppressor lightly on a padded surface or blow it out with compressed air to remove any loose fouling from inside the suppressor body. (Do Not immerse the sound suppressor in solvent or insert any rods, brushes or patches into the sound suppressor body!

Wipe the outside of the sound suppressor off with a clean, oil-free rag. Do not apply oil to the outside of the sound suppressor or it will burn off during firing and obscure the firers view of the target.

B. Multi-purpose carrying sling

The cotton webbing of the multi-purpose carrying sling can be cleaned using warm soap and water and a soft bristled brush. Allow the sling material to dry completely before storage or use.

The metal components of the sling and the ambidextrous sling mounting pins can be cleaned using standard weapons solvents and oils.

C. Buttstock or buttcap

Simply remove any foreign debris from the exterior of these parts using a toothbrush, rag, swabs or compressed air when available.

D. Trigger group

Remove any foreign debris from the plastic pistol grip using a toothbrush, rag, swabs or compressed air.

Scrub the top of the hammer, ejector and the area around the front of the ejector and release lever with a small amount of solvent or oil to break up the carbon fouling.

Remove the loose fouling and debris by rinsing the metal components in the a solvent tank or by using rags, swabs, or compressed air.

E. Forearm or foregrip

Remove any foreign debris from the forearm or foregrip using a toothbrush, rag or compressed air.

F. Receiver/barrel group

Start with the bore and chamber.

Bore - Apply a liberal amount of solvent to a bronze bristle bore brush of the appropriate caliber. Always insert the bore brush from the chamber end and push it all the way through the barrel in the direction that the bullet travels. Pull the brush back through the barrel. DO NOT allow the brush to stop in the bore or it may get stuck! Repeat this in/out procedure for a minimum of three complete trips. Remove the bore brush and let the solvent work in the bore for a few minutes while you clean other components.

Chamber and flutes - Apply a liberal amount of solvent to the appropriate chamber brush. Insert the chamber brush through the back of the receiver into the chamber. DO NOT push the chamber brush past the chamber! Work the chamber brush back and forth in the chamber at least three times. Remove the chamber brush and let the solvent go to work on the fouling for a few minutes while you work on other components.

Chamber face and barrel extension - Often considered the hardest area to clean in the MP5, it is easily tackled using the special Chamber Face brush available in the H&K Modular Weapons Cleaning Kit for submachine gun. Attach this brush to the cleaning rod and lock the handle so that the rod and brush can be turned together. Apply a liberal amount of solvent to the bristles of the brush. Insert the brush through the back of the receiver until it makes contact with the area surrounding the opening to the chamber and bore and the solid cylindrical metal piece that the barrel is pressed into (called the barrel extension).

With slight inward pressure, rotate the brush in a clockwise direction to break up the carbon fouling built-up on the inside radius of the barrel extension and on the face of the chamber. Use the same procedure through the magazine well and bottom of the receiver to reach the entire radius of the barrel extension. Continue this procedure until you are satisfied with your efforts.

Receiver - Apply a few drops of solvent to a toothbrush and scrub the area around the barrel extension and along the length of the receiver rails to break-up the carbon fouling.

Muzzle threads on "Navy" models, MP5K-PDW, MP5/10 and MP5/40 - Use a nylon bristle toothbrush and a small amount of solvent to remove any fouling from the muzzle threads where the screw-on suppressor attaches and from the protective cap that covers the threads when the suppressor is not attached.

Remove all of the fouling, carbon, and visible debris from the entire receiver/barrel group using a solvent tank and compressed air or swabs, patches, rags etc.

Run at least three clean patches of the appropriate size all the way through the bore in the direction of bullet travel to remove the loose fouling and solvent.

G. Bolt group

Scrub all parts of the bolt group with a toothbrush and solvent where carbon is visible, especially around the extractor and the bolt rollers. Insure that the rollers are clean enough that they move in and out easily. Use the locking piece to force the rollers out of the bolt head for easier cleaning with the toothbrush.

DO NOT remove the extractor for cleaning! You may damage the extractor spring. There is no functional need to remove the extractor for **Normal** cleaning.

Remove the loose fouling from all parts using a rag, swabs or compressed air.

H. Magazine

Don't forget the magazines! They are very important and very often overlooked during cleaning. Many stoppages occur as a result of improperly maintained magazines.

Apply a few drops of solvent to a toothbrush and scrub the top of the magazine to remove any visible carbon fouling or loose debris. Pay special attention to the front edge of the housing, the feed lips and the follower.

Remove the solvent and loose fouling from the magazine using a rag, swabs, or compressed air.

Major Cleaning -

As mentioned earlier, **Major** cleaning should be performed after 1,000 rounds are fired through an unsuppressed MP5 or 500 rounds through a suppressed MP5. Major cleaning is also performed when the weapon has been immersed in water or is laden with large amounts of visible foreign matter or fouling.

During Major cleaning, all weapon components except the suppressor and the carrying sling, should be rinsed with or immersed in solvent and scrubbed thoroughly with a brush. This includes the magazine and it's parts. The components can then be dried using a rag or swabs, though compressed air is preferable for major cleaning.

If any assembly groups require a more thorough cleaning, an "Ultra-sonic" cleaning machine can be used containing any solvent that it is safe to place your bare hands in, as a general rule. Further disassembly of any assembly group(s) beyond the level described above must be performed by, or at a minimum supervised by, an H&K factory-trained armorer.

OPERATOR INSPECTION

During or after cleaning the operator should inspect the weapon and it's components for any irregularities that may causes problems during it's operation. If any potential deficiencies are noted, they should be corrected immediately and/or brought to the attention of the unit armorer.

In general, the operator should keep a watchful eye out for the following discrepancies both in the weapon as a whole and in each assembly group.

1. Improper function
2. Missing parts
3. Cosmetic flaws (cracks, dents, burrs, rust, etc.)
4. Improper assembly
5. Loss of spring tension (where applicable)
6. Uncustomary looseness (where applicable)
7. Cracked welds
8. Excessive wear
9. Absence of protective finish (where applicable)
10. Absence of proper lubrication

Also check these more common areas where problems may begin in the H&K MP5.

A. Magazine housing -

- * Bent feed lips - replace magazine
- * Split or bowing appearing in top of front seam above oval reinforcement plate. - replace magazine

B. Bolt head -

- * Loose extractor (easily moved with finger) - replace extractor spring
- * Broken or missing locking roller holder (rollers fall out of bolt head) - replace locking roller holder and locking rollers (Note: In an emergency the locking rollers can be replaced without the locking roller holder and the weapon used as normal. Replace the locking roller holder as soon as possible. Never shoot the weapon without two locking rollers installed.)
- * Cracks appearing near corners of roller openings - replace bolt head
- * Broken or missing firing pin spring - replace firing pin spring

C. Recoil spring and guide rod -

- * Worn or missing nylon washers - reverse guide rod. Replace nylon washers as soon as possible

D. Correct locking piece -

Marking should appear on top side of locking piece. DO NOT interchange different locking pieces between different model MP5's.

<u>Model(s)</u>	<u>Marking</u>
MP5K/KA1/K-N/PDW	16
MP5K-N & MP5K-PDW with folding stock and sound suppressor attached	80 ^o
MP5A2/A3/SF/N/PT	No Marking
MP5SD/SD-N	5
MP5/10 & MP5/40	HI 25 (High impulse ammo*) LO 24 (Low impulse ammo**)

- * High Impulse - Generally ammunition with a muzzle velocity exceeding 1,100 feet per second.
- ** Low Impulse - Generally ammunition with a muzzle velocity below 1,100 feet per second.

The different locking pieces have different angles on the forward shoulders where they make contact with the locking rollers. The various angles control how quickly the bolt opens after ignition of the cartridge. Locking pieces are selected for a particular variation of the MP5 based on the length of it's barrel (including the integral sound suppressor of the MP5SD), it's caliber and it's unique functional characteristics. The bolt must stay locked closed until the projectile has left the bore and the gases drop to a safe level. Exchanging locking pieces does not represent a safety hazard but may change the functional characteristics of the weapon slightly. Therefore, do not mix locking pieces in different models of the MP5.

E. Rear sight -

- * Insure that the drum turns freely and with tactile clicks and that the locking screw, located in the top of the sight assembly, is tight.

F. Carrying sling -

- * Insure that the cotton webbing is not rotted or frayed and that the metal hardware is secure and free of cracks.
- * That the rubber O-rings on the mounting pins for the ambidextrous carrying sling are present on the threaded shaft and complete.

LUBRICATION

Any type of high-quality, medium-weight lubricant (oil) specifically designed for use on firearms such as "Break-Free" (C.L.P.) or "Ballistol" will work well on the H&K MP5 submachine gun.

DO NOT use lubricants/cleaners that boast of their ability to penetrate metal (i.e. "WD-40", "Tri-Flow", etc.) as these substances may deaden primers.

Where and how much?

NO Lube - (surface is dry and not slippery to the touch)

- * Suppressor body
- * Sling webbing
- * Plastic components

LIGHT Lube - (finger run across surface yields little or no lube)

- * Bore and chamber
- * All metal parts (except suppressor)
- * Muzzle and suppressor threads
- * Trigger mechanism and safety axle
- * Metal buttstock
- * Magazine (interior and exterior)
- * All operating controls (cocking lever, bolt catch, magazine catch, etc.)
- * Rear sight assembly
- * Cocking lever support detent (located at front end)
- * All metal accessories

MEDIUM Lube - (finger run across surface yields some lube but lube does not run down surface when held in a vertical position)

- * Bolt group with recoil spring and guide rod

HEAVY Lube - (Lube runs down surface when held in a vertical position)

NO HEAVY Lube is required on the H&K MP5 submachine gun!

Reapply lubrication to the MP5 periodically during firing as it burns off from the heat. Suppressed weapons generate more smoke and noxious gases especially when over lubricated.

Apply lubricant using a shaving brush, swabs, patches, or rag. A spray bottle also works well using compressed air to circulate the lubricant into all parts and to remove the excess.

SPECIAL USE AND MAINTENANCE OF H&K SOUND SUPPRESSED WEAPONS

In addition to the basic maintenance instructions provided earlier, sound suppressed weapons require additional special attention from the operator.

All weapons with sound suppressors require more cleaning than the same type of weapon without a sound suppressor. This is because the sound suppressor is designed to capture or "suppress" the expanding propellant gases that exit the muzzle of the weapon behind the projectile. These gases exit the weapon at a supersonic velocity causing a "muzzle blast". The sound suppressor captures these propellant gases, contains them within a series of baffles or chambers and allows them to escape at a slower velocity thus eliminating the muzzle blast.

At the same time that the gases are contained, so is the carbon fouling and propellant debris that would normally be blown out of an unsuppressed weapon with the propellant gases. More fouling and debris stays behind in a sound suppressed weapon and thus there is more for the operator to remove during his cleaning.

In order to be effective, a sound suppressed weapon must also provide some means to reduce or eliminate the supersonic "crack" of the projectile as it leaves the muzzle at a supersonic velocity (above 1,088 feet/second at sea level). This can be accomplished in two ways. One. By venting gases from behind the projectile as it passes through the bore and sound suppressor thus lowering the exit velocity of the bullet below 1,088 feet/second. Or two, by firing ammunition in the weapon that is down-loaded to a velocity below the supersonic range. For this reason this ammunition is termed "subsonic" and usually falls into the range between 875 - 1,050 feet/second. Both methods are effective but each has it's own disadvantages and advantages.

There are two different styles of sound suppressed MP5's currently available from H&K. The integrally sound suppressed weapon like the MP5SD and the screw-on style sound suppressed weapon like the MP5-N. Both versions are of the "wipeless" design, meaning they have no rubber or synthetic membranes (wipes) that the bullet must penetrate. The projectile does not touch any portion of the H&K wipeless sound suppressor. Wipeless designs are far more durable than other designs and generally give the best accuracy results.

1. **MP5SD/SD-N with integral suppressor -**

The MP5SD was designed to be used exclusively with supersonic ammunition with a muzzle velocity of at least 1,088 feet/second at sea level. It should not be used with subsonic ammunition with a projectile weight of less than 140 grains! While subsonic ammunition with a projectile weight of less than 140 grains fired in the MP5SD may provide enough recoil energy to cycle the action of the weapon it may not provide sufficient terminal ballistics downrange to incapacitate the target.

The use of subsonic ammunition in the MP5SD will not result in an appreciable increase in the sound reduction of the weapon (only about 1 dB in fact). Thus there is little or no reduction in the report of the weapon yet there will be a considerable (16 - 24 %) reduction in the velocity of the projectile and subsequently the terminal effect of that projectile on target.

The advantage of the MP5SD is that the user can use standard supersonic ammunition, available worldwide, and have an effective sound suppressed weapon without the need for special subsonic ammunition. The disadvantage to the MP5SD is that it should not be used with the subsonic loads with projectile weighing less than 140 grains and it must be used at all times with the sound suppressor attached.

Attached to the MP5SD is a 12 inch long, sealed, all aluminum sound suppressor that can be removed by the operator for cleaning. This integral sound suppressor surrounds the weapon's 5.73 inch barrel which has thirty (30) gas ports drilled into it close to the receiver. Like all MP5 barrels the MP5SD barrel is cold hammer forged with six conventional lands and grooves arranged in a constant right hand twist and is pressed and pinned into the receiver.

The thirty gas ports in the MP5SD barrel vent propellant gases into the sound suppressor and lower the velocity of the bullet anywhere from 16 to 26 percent. This reduction depends greatly on the cartridge used.

Located at the base of the attached sound suppressor is a 1 3/8 inch rubber O-ring that seals off the back end of the sound suppressor. This O-ring should be checked for serviceability (complete and pliable) during inspection and should be replaced when the sound suppressor is replaced.

The sound suppressor of the MP5SD was not designed to be fired full of water. The MP5SD-N "Navy" incorporates a stainless steel sound suppressor of nearly the same dimensions as the standard aluminum version that does allow it to be fired with water inside, should water enter the unit during an operation in or near water.

Fitting the stainless steel MP5SD-N sound suppressor to the standard MP5SD requires the modification of the cocking lever support to account for the slightly larger diameter (@ .50 mm) of the "Navy" MP5SD sound suppressor.

The special Barrel Cleaning Device (H&K ID # 225376) should be used to clean the barrel and gas ports of the MP5SD after every firing or every 500 rounds. If it is not used regularly the sound suppressor may become hard to unscrew or remove due to the excessive buildup of carbon fouling during firing, especially when using excessively dirty ammunition. (See "Normal Cleaning" of the sound suppressor on page 53)

2. **MP5-N "Navy", MP5K-N, MP5/10 and MP5/40 with screw-on sound suppressor -**

These weapons are designed to be fired using supersonic or subsonic ammunition with any weight projectile and with or without the sound suppressor attached. There lies their major advantage over the more specialized, integrally suppressed MP5SD. The H&K MP5K-N and MP5K-PDW use the same screw-on stainless steel suppressor designed for the MP5-N. The MP5/10 and MP5/40 use the same aluminum sound suppressor which will not withstand the pressure of being fired if full of water.

The MP5-N/K-N/PDW sound suppressor is 7 1/4 inches long and weighs @ 1.70 pounds. It is intended to be used with subsonic ammunition for maximum sound suppression. The MP5-N/K-N/PDW and MP5/10 and MP5/40 do not have vented barrels as is found on the MP5SD and therefore do not lower the velocity of the ammunition fired in them. These screw-on sound suppressors can be used with supersonic ammunition but the supersonic "crack" of the projectile will still remain even though the sound suppressor does eliminate the "muzzle blast" caused by the propellant gases.

Accuracy from the screw-on sound suppressor is excellent, often better than the weapon without the sound suppressor attached, though there is sometimes a slight change in zero when the sound suppressor is attached. This is mostly due to the longer distance that the projectile must pass through (similar to firing through a longer barrel) on it's way to the target.

Effectiveness and service life of the H&K sound suppressors varies greatly due to countless variables. Some of these variables include the type and quantity of ammunition used, the predominant mode of fire used, the operational environment in which the weapons are employed, etc. Generally, the aluminum MP5SD and MP5/10 and MP5/40 sound suppressors and the stainless steel "Navy" sound suppressors, when used with the recommended ammunition, provide @ 30 - 35 decibels sound reduction when compared to an unsuppressed weapon.

However, the service life of the stainless steel and aluminum versions vary greatly. An aluminum sound suppressor will generally maintain it's effectiveness to @ 20,000 rounds. The stainless steel sound suppressors, being made of a much harder and more durable and heat resistant material, generally maintain their effectiveness in excess of 40,000 rounds.

Older H&K sound suppressors can be replaced by the operator for a reasonable cost without the need for factory fitting. Many teams will keep the older sound suppressor for training and maintain the newer one for operational use where peak performance is desired.

Observe the following recommendations

- * DO NOT use subsonic ammunition in the MP5SD with a bullet weight of less than 140 grains
- * DO NOT attempt to open the sound suppressor body
- * DO NOT allow the gas ports to become clogged. Use the MP5SD Barrel Cleaning Device every 500 rounds to clean the barrel and gas ports.
- * DO NOT allow the sound suppressor to loosen during use. Do not use any form of tool or wrench to install or remove the sound suppressor. Sound suppressors should be hand tightened only. If the sound suppressor will not unscrew from the weapon, consult the section entitled "Normal Cleaning" of the sound suppressor on page 53 or call Heckler & Koch for guidance.
- * DO NOT fire the MP5SD, MP5/10 or MP5/40 with the standard aluminum sound suppressor full of water. Allow the water to drain from the sound suppressor before attempting to fire the weapon.

- * DO NOT fire the MP5SD without the sound suppressor attached.
- * DO NOT fire the MP5SD if the rubber O-ring is not present around the base of the barrel.
- * DO NOT attempt to fire the weapon if the sound suppressor has been dented or damaged or fits loosely on the weapon.
- * DO NOT exchange locking pieces between various models of the MP5.
- * DO NOT insert anything into the body of the sound suppressor such as a cleaning rod or brush.
- * DO NOT add to or fire the weapon with oil, grease or any foreign matter inside.
- * Keep the protective cap for the muzzle threads of the MP5-N, MP5K-N, MP5K-PDW, MP5/10 and MP5/40 on the barrel at all times when the sound suppressor is not attached. Store the cap on the optional holder in the pistol grip (H&K ID# 205483) when the sound suppressor is attached.
- * Keep the muzzle threads and threads of the sound suppressors and protective cap as clean as possible at all time to insure that the sound suppressor can be easily attached when required. Clean the threads with a nylon toothbrush or patch soaked in oil or solvent. Lightly lube the clean threads once they are clean. Dirty threads make it very difficult to attach the sound suppressor.

AMMUNITION

The MP5 submachine gun was designed to use ammunition designed to NATO specifications. Like an automobile engine, you cannot expect top performance by using poor quality fuel. The same applies to firearms. There are a number of general considerations that should be made when choosing the type of ammunition your organization plans to use in their MP5's.

DO USE

- * 9 X 19mm NATO, Parabellum or Luger ammunition of recent manufacture, preferably with a projectile weight of at least 100 grains for optimum reliability
- * Clean burning ammunition
- * Non-corrosive ammunition
- * Jacketed Hollow Point (JHP), "Silver-Tip", ball, truncated cone, "Hydra Shok", +P, +P+ etc.
- * Subsonic ammunition (in the MP5SD with a projectile weight of at least 140 grains)

DO NOT USE

- * Reloads or remanufactured ammunition. Beware of military surplus, foreign or outdated ammunition.
- * Aluminum cased ammunition
- * Non-jacketed or exposed lead ammunition
- * Corrosive ammunition (primer and/or propellant)
- * Any ammunition that exceeds NATO pressure limits (maximum 38,000 p.s.i.)
- * Empty cases as "dummy" (inert) rounds, as damage may result to the weapon, especially the synthetic magazines employed in the MP5/10 and MP5/40. Use complete dummy rounds available for training purposes.

SIGHT ALIGNMENT/SIGHT PICTURE

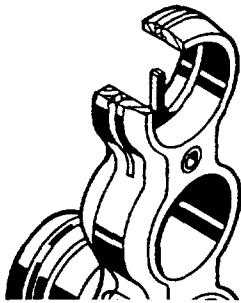

Front

Ill.# 68A - MP5 Diopter sights

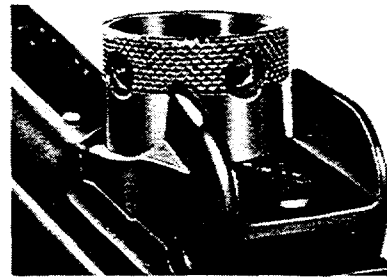

Rear

The sighting arrangement on the H&K MP5 takes advantage of the natural ability of the eye and the brain to easily align concentric circles (circles all having a common center). These sights are both fast and accurate and are considered the best and easiest to use in the industry.

H&K calls the sights found on the MP5 "diopter" sights. Diopter meaning "as seen through". All MP5's have a rotating rear sight drum that provides four various width apertures. Rotating this drum does not change the impact of the rounds downrange. As a result of the trajectory of the pistol cartridges chambered in the MP5 submachine guns, the bullet strike is generally the same at 25 and 100 meters, when zeroed at 25 meters. The maximum midrange trajectory height above the line of sight is approximately 4 - 5 inches, depending on the load used. Consequently, elevation markings are not required on the rear sight drum as they are on the H&K assault rifle.

The four different size apertures found on the MP5 are provided for the convenience of each individual shooter, their various shooting styles, and changing lighting conditions.

Selection of the appropriate size aperture is usually done according to shooter preference. However, for precise shooting the firer should select the smallest aperture that still allows a circle of light between the rear sight aperture and the outside of the front sight holder.

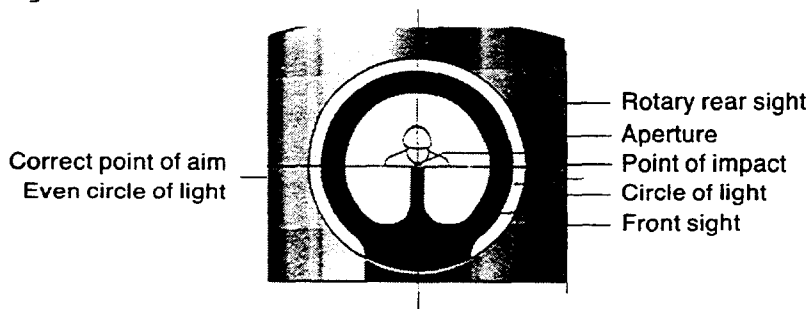

Ill.# 68B - Correct sight alignment/sight picture

Assuming correct sight alignment -

Peep aperture (MP5A2/A3/N/SD/SF/ & MP5/10 and MP5/40 - To correctly align the sights on the above listed MP5's, select the appropriate sized rear sight aperture as discussed above. Assume a comfortable firing position and place your cheek on the buttstock within 2 - 4 inches to the rear of the rear sight aperture. Maintain a consistent cheek position (cheek weld) on the weapon during firing.

Looking through the rear sight aperture, center the front sight holder (the ring that protects the front sight post) within the rear sight aperture with an equal circle of light around the front sight holder.

The sights are now properly aligned. Maintain that correct alignment throughout firing by making fine corrections in the relationship of the front and rear sights.

U-shaped aperture (MP5-K/K-N/PDW) - The rear sight drum on the K Models of the MP5 differs from that of the other models of the MP5 due to the fact that, with the exception of the MP5K-PDW, the MP5-K was originally designed to be used without a buttstock. Therefore, the small peep apertures have been replaced with open U-shaped notches so that the sights can be aligned as the weapon is shot like a pistol, held at arms length. As in the standard MP5 rear sight drum, the MP5-K rear sight provides four various sized apertures to meet the personal preference of each individual shooter. Rotation of the MP5-K rear sight drum does not change the impact of the rounds downrange.

The two drums can be interchanged so that the MP5K-PDW shooter can fire the weapon with the same degree of precision as the standard MP5 with a buttstock. The sights are exchanged by using the sight adjustment tool to remove the rear sight drum and retain the detents and springs as the other rear sight drum is screwed into place.

To assume the correct sight alignment with open MP5-K rear sight drum, follow the same procedure used when aligning the patridge sights of a handgun. Select the appropriate aperture by rotating the rear sight drum. Looking through the U-shaped rear sight aperture, center the front sight post within the rear sight so that there is equal light to the right and left of the front sight post. Align the top of the front sight post with the top edge of the rear sight drum.

Maintain that correct alignment to the best of your ability as you aim and fire the weapon. Errors in sight alignment as the round fires will result in an angular deflection of the projectile away from the aiming point in the direction of the misaligned front sight post. Some examples of the results of poor sight alignment are shown below.

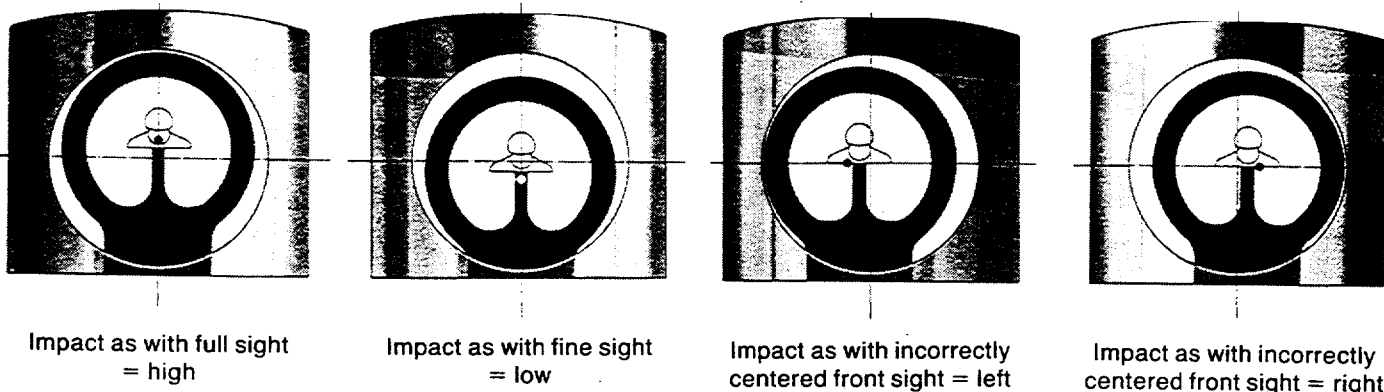

III.# 70A - Results of incorrect sight alignment

Correct sight picture - The only difference between sight alignment and sight picture is the addition of the target to the image seen when aligning the sights. In all variants of the MP5, the top of the front sight post is used to select the aiming point of the weapon. As depicted above in illustration # 68B, the target is centered on the very top of the front sight post (referred to as a "center hold". An option to a center hold would be a "6 o'clock hold where the top of the front sight post is positioned along the bottom of the target.

Regardless of the hold used, the sights must be properly adjusted so that the projectiles impact at the desired location on the target, irrespective of the position of the front sight post to the target.

SIGHT ADJUSTMENT

General information - All H&K MP5 submachine guns are zeroed before leaving the factory in Germany. The weapon is fired from a machine rest at a target at 25 meters (27.5 yards). Ammunition used is standard 9 X 19mm NATO 124 grain ball, commercial 10mm Auto 180 grain Jacketed Hollow Point, or commercial .40 S&W 180 grain Jacketed Hollow Point loads. The weapons are zeroed using a 6 o'clock hold. All five (5) rounds fired must fall within a circle no larger than 1.58 inches or the weapon is rejected and returned for reworking.

In addition to zeroing, each MP5 is proof fired using two over-pressure proof rounds and function fired with fifteen (15) rounds of ball using all modes of fire.

Depending on the type of ammunition and the brand used, you may realize a sizeable difference in zero with a new weapon even though it was zeroed at the factory. This difference is strictly due to the different type of ammunition fired.

Background - The special sight adjustment tool, available as an accessory from H&K under ID # 300009, is used to adjust the rear sight of the MP5 and to exchange the rear sight drum. The sight of the MP5 is intentionally designed so that it cannot be adjusted without this special tool because the West German government wrote this into the specifications for the weapon.

This specification dates back to when the father of the MP5 submachine gun, the G3 rifle, was designed. All H&K G3 rifles in the West German army are zeroed at the factory using a machine rest with an optical sighting device. Each weapon is shipped with the same battlesight zero.

The German soldier does not adjust the sights of his assigned weapon for his individual zero, as is done in the U.S. He simply learns the necessary hold off to bring his rounds to the center of the target. In this way any German soldier can pick up any G3 rifle and be assured of having a battlesight zero because all weapons possess the same battlesight zero, as opposed to in the U.S. where each weapon zero is different.

This cultural difference spills over into the MP5 submachine gun. Sight adjustment tools are not provided with each weapon as many users find the factory zero to be appropriate for their use or they already have at least one sight adjustment tool to make any small adjustments. Adding a sight adjustment tool to each MP5 would increase the price of the weapon, even to the users that already have the tools.

Adjusting the Rotary Rear Sight - The procedure for adjusting the rotary rear sight on all H&K MP5 submachine guns is the same and can be accomplished using nothing more than a sight adjustment tool. The sight adjustment tool consists of two separate parts, a phillips head screwdriver and a lever cylinder. The lever cylinder can be stored on the top of the phillips head screwdriver and is comprised of two spring actuated levers.

All elevation and windage adjustments are made through the rear sight assembly.

Adjustment procedure -

Before attempting to adjust the sight:

1. **CLEAR THE WEAPON!**
2. Secure the weapon in a stable position so that the sights point up and the rear sight is easily accessible. Keep the weapon from flopping around to make this job easier and quicker.

Elevation Adjustment -

- A. Insert the lever cylinder into the rear sight drum with the two spring actuated levers projecting into the two slots, located on the inside of the rear sight drum, that have the spring detents in them. (There are a total of four slots, but only two with spring detents.)

Do not allow the lever cylinder to rock back and forth inside the rear sight cylinder during your adjustment. It must remain immobile.

- B. **Holding lever cylinder in place** slowly and carefully insert the phillips head screwdriver into the top of the lever cylinder until it is fully inside.

At this point the levers in the lever cylinder should be depressed inward and should be compressing the spring detents in the rear sight drum.



Ill.# 72A - Making an elevation adjustment

- C. **Holding the sight adjustment tool in place** you should be able to easily rotate the rear sight drum independently of the rest of the sight assembly and the sight adjustment tool.

If any part of the sight adjustment tool rotates with the rear sight cylinder as it is turned or the rear sight cylinder cannot be rotated, remove just the phillips head screwdriver from the lever

cylinder and start again at step B above.

- D. Once the rear sight cylinder is free to rotate independently each movement of the drum is changing the elevation adjustment of the rear sight.

Once the elevation adjustment is made and the sight adjustment tool is removed from the rear sight the spring detents will snap back into place as the operator selects his preferred aperture.

Direction of Elevation Adjustment - Rotating the rear sight drum clockwise as viewed from the top of the weapon moves the impact of the projectiles down on target. Counterclockwise rotation moves the impact of the projectiles up on target.

Clockwise = Down

Counterclockwise = Up

Elevation Adjustment Value - For all MP5 submachine guns, one full revolution of the rear sight drum moves the impact of the projectile on target approximately 2.25 inches (56 mm) at a range of 27.5 yards (25 meters).

1 complete revolution = 2.25 " at 27.5 yards (25 meters)

Windage Adjustment -

- A. Check the rear sight lock screw (located behind the rear sight drum) for tightness using the sight adjustment tool.
- B. Decide which direction you need to move the rear sight. The general rule of thumb is that you always move the rear sight in the direction you wish the projectiles to move on the target downrange.
- C. Use the sight adjustment tool to remove the slack (free rotation) from the windage adjustment screw in the direction you intend to move the rear sight BEFORE loosening the rear sight locking screw. The rear sight adjustment screw is located on the right side of the rear sight assembly.
- D. Rotate the rear sight locking screw, using the sight adjustment tool, one complete turn in a counterclockwise direction to loosen the rear sight assembly.

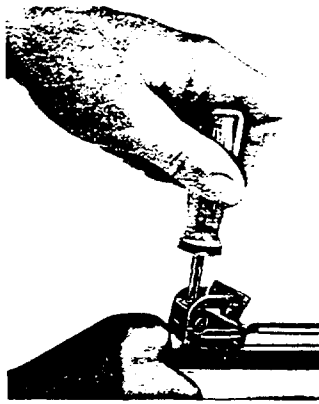

Loosening the clamping screw

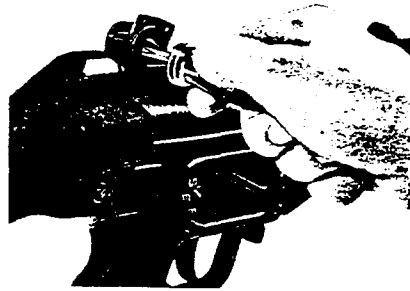

Rotating the adjusting screw

Ill.# 74A - Making a windage adjustment

- E. Rotate the rear sight adjustment screw in the desired direction.

Direction of Windage Adjustment - Viewing the rear sight assembly from the right hand side, rotate the rear sight adjustment screw using the sight adjustment tool as follows.

COUNTERCLOCKWISE moves impact RIGHT

CLOCKWISE moves impact LEFT

Windage Adjustment Value - For all MP5 submachine guns, one full revolution of the windage adjustment screw moves the impact of the projectiles on target approximately 2.16 inches (55 mm) at a range of 27.5 yards (25 meters).

1 complete revolution = 2.16 " at 27.5 yards (25 meters)

USE OF THE MULTI-PURPOSE CARRYING SLINGS

Description - The unique H&K Multi-purpose slings allow the weapon to be carried one-handed or hands-free and prevents the loss of the weapon should the operator fall or an assailant try to take the weapon away. Due to their design the multi-purpose carrying slings also allow the firer the ability to transition immediately to a back-up weapon should the need arise without the worry of losing control or possession of the submachine gun.

There are two different multi-purpose carrying slings available from H&K for use on the MP5 submachine gun. The standard multi-purpose sling for use by right hand users and the newer ambidextrous multi-purpose carrying sling designed for use by both right and left hand users.

Standard multi-purpose carrying sling - The standard multi-purpose carrying sling consists of two lengths of green cotton one inch webbing with various metal attachments. (See illustration # 75A below.

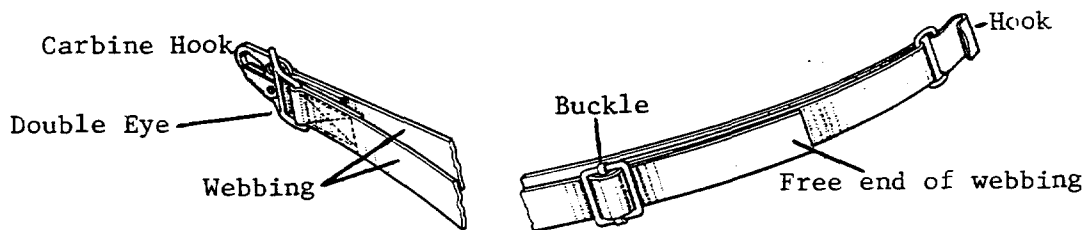

Ill.# 75A - Standard multi-purpose carrying sling

The standard multi-purpose sling attaches only to the left side of the weapon and requires no addition mounting hardware other than that which is incorporated into the webbing of the sling.

A longer standard multi-purpose carrying sling (designed for the larger G3 rifle) is available for larger operators who find the webbing of the MP5 sling too short to allow the weapon to be worn comfortably. It is marked with one vertical hash mark on the webbing near the carbine hook (The MP5 sling is marked with three hash marks.) It is available from H&K under ID# 205501.

Ambidextrous multi-purpose carrying sling - For left handed operators, H&K offers an ambidextrous multi-purpose carrying sling (ID# 205213) that can be attached to the right side of the weapon for left handed carry. This sling requires two of the ambidextrous sling mounting pins (ID# 700148 for buttstock and ID# 700154 for the forearm).

These mounting pins are comprised of a pin with eyelet where the carbine hooks are attached, a knurled locking knob to secure the pin to the weapon and a small mil-spec rubber O-ring that acts as a lock washer to secure the locking knob in place on the mounting pin. The ambidextrous multi-purpose carrying sling and mounting pins come standard with the MP5/10 and MP5/40 submachine guns.

The ambidextrous multi-purpose sling is assembled using wider 1 1/4 inch green cotton webbing for greater comfort and has two carbine hooks instead of the rear hook that sometimes comes off of the buttstock or breaks. It also has a clip similar to that found on the left side of the magazine well on the MP5 to allow the weapon to be carried in the High Port Arms carrying position. Finally, this sling has velcro on the free end of the webbing to secure the loose strap that is often taped down or cut off.

As well as being used for left handed carry, these ambidextrous pins and slings can also be used to lower the rear position of the sling away from the face of the right handed shooter and can be used on the early MP5K-PDW's that did not have the front eyebolt to attach the sling to.

When using the ambidextrous multi-purpose carrying sling on an MP5 fitted with a fixed buttstock, one large mounting pin must be installed in the rear of the receiver for the rear attachment point as the rear carbine hook on the sling will not attach to the standard mounting point which is molded into the buttstock. This sling will fit on a MP5 with a retractable buttstock without the need for a rear mounting pin.

When mounted on the right or left sides of the weapon, the ambidextrous multi-purpose carrying sling is designed not to interfere or block the operating controls of the weapon or the ejection port.

Assembly and routing of the multi-purpose carrying slings - The H&K multi-purpose carrying slings are properly assembled as they are received from the factory. If they are not disassembled, they are quickly attached to the weapon. If they have been disassembled, they must be properly assembled before attachment to the weapon.

To properly assemble the multi-purpose carrying sling follow the procedure below.

1. Separate the two lengths of webbing.
2. Lay the bottom length of webbing (that which has the carbine hook(s) attached to it) on a flat surface. Position the bottom length of webbing with:
 - * the carbine hook that is sewn in a stationary position at the end of the webbing facing to your left and the buckle to your right.
 - * The spring actuated gate of the carbine hook(s) facing down.
 - * No twists in the webbing.
3. Position the top length of the webbing (that which has the double eye sewn into the end of the webbing) on top of the bottom length of the webbing so that:
 - * The double eye faces to your left.
 - * The free end of the webbing faces to your right.
 - * The double eye forms a "bridge" over the webbing instead of a "bowl".
 - * There are no twists in the webbing.
4. Route the free end of the webbing of the top length through the buckle (under and through) so that 2 -3 three inches of the end of the webbing are visible to the right of the buckle.
5. Insert just the tip of the carbine hook on the far left through the front (furthest from the webbing) opening in the double eye.

The sling is now ready to be attached to the weapon.

Attachment of the multi-purpose carrying slings -

Standard multi-purpose carrying sling - This carrying sling will be attached to the left side of the weapon for use by right hand users only.

1. CLEAR THE WEAPON!
2. Position the weapon above the carrying sling which should still be laid out on a flat surface as described above. The weapon should be laying on it's right side with the barrel pointing to your left and the sights pointing up.
3. With the gate of the carbine hook on the left facing down snap the carbine hook onto the eyebolt, the circular metal loop located on the left side of the front sight holder below the front sight.
4. Attach the hook (the free metal attachment on the bottom length of webbing) to the sling attachment bar on the buttstock. This bar is located on the backplate of the retractable buttstock or molded into the plastic material towards the rear of the fixed buttstock.

Once attached, insure that the opening of the hook faces out and to the rear of the weapon.

5. To silence and further secure the sling to the weapon, place a piece of tape through the hook and the sling attachment bar located on the buttstock.

The standard multi-purpose carrying sling is now ready for use.

Ambidextrous multi-purpose carrying sling - This carrying sling is generally attached to the right or left side of the weapon for use by right or left hand users.

CLEAR THE WEAPON!

For Left Hand Use -

1. Remove the front locking pin from the forearm/foregrip and replace it with a small ambidextrous sling mounting pin so that the circular metal loop is positioned on the right side of the weapon. Insure that the rubber O-ring is present at the base of the pin threads and attach and tighten the locking knob to secure the pin to the weapon.

2. Remove the rear locking pin from the buttstock of the weapon and replace it with a large ambidextrous sling mounting pin using the same procedure described in paragraph 1 above.
3. Lay the weapon on it's left side on a flat surface with the barrel pointing to your right.
4. Position the assembled sling below the weapon making sure that:
 - * The front carbine hook that is sewn into the end of the webbing faces to your right.
 - * The free carbine hook, located on the bottom length of webbing, is positioned at the left end of the sling.
 - * The spring actuated gates of the carbine hooks face up.
 - * There are no twists in the webbing.
5. Snap the carbine hooks to the circular metal loops located on the ends of the sling mounting pins, with the spring actuated gates facing up.

The ambidextrous multi-purpose carrying sling is now ready for use by the left hand user.

For Right Hand Use -

1. Lay the weapon on it's right side with the barrel pointing to your left and the sights facing up.
2. Positioned the assembled sling below the weapon making sure that:
 - * The front carbine hook that is sewn into the end of the webbing faces to your left.
 - * The free carbine hook, located on the bottom length of webbing, is positioned at the right end of the sling.
 - * The spring actuated gates of the carbine hooks face down.
 - * There are no twists in the webbing.

3. Snap the front carbine hook onto the eyelet located on the left side of the front sight holder with the spring actuated gate facing down.
4. Snap the rear carbine hook onto the sling attachment bar, located on the left side of the backplate of the retractable buttstock, with the spring actuated gate facing down.

NOTE: When attaching the ambidextrous sling to a weapon with a fixed buttstock or to lower the rear of the sling away from the face, install one of the large ambidextrous sling mounting pins into the hole in the rear of the receiver where the normal locking pin is located. The rear carbine hook of the ambidextrous multi-purpose carrying sling is then attached to that mounting pin.

The ambidextrous multi-purpose carrying sling is now ready for use by a right hand user.

Donning the MP5 fitted with a multi-purpose carrying sling -

CLEAR THE WEAPON!

1. Pull the double eye over the carbine hook by angling the double slightly in a clockwise direction. (See illustration # 80A)

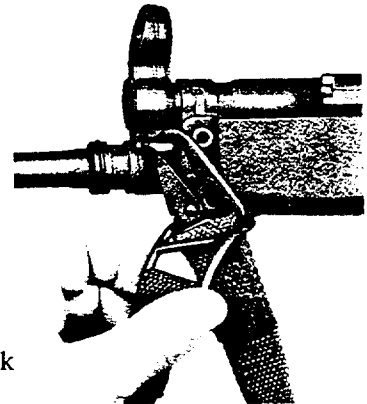

Ill.# 80A - Pulling the double eye over the carbine hook

2. Grasp the top length of webbing and pull the slack out the sling to form a large loop. (See illustration # 80B)

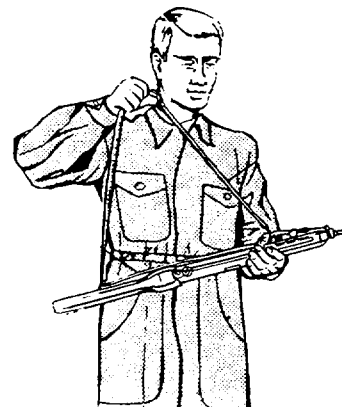

Ill.# 80B - Forming a loop in the sling

3. Place the large loop of the sling over your head and under your firing arm.
4. Adjust the size of the loop by adjusting the length of the free end of the webbing through the buckle.

Generally, you want to easily be able to shoulder the weapon with little or no slack in the sling. The weapon should hang across your lower chest or abdomen when you release your hold on the weapon.

5. Secure the free end of the webbing by looping it back through the far side of the buckle and/or taping the end in place. The free end of the webbing on the ambidextrous multi-purpose carrying sling provides velcro to secure the end of the sling.

Carrying Positions -

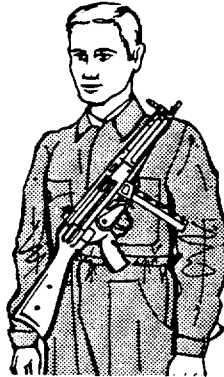

Ill.# 81A - High Port Arms Carry

High Port Arms Carry - (See illustration # 81A) Used to administratively carry the weapon high across the chest in a military "port arms" position, hands free. Allows the users to use his or her hands for other tasks without the weapon getting in the way. Yet, in this position, the weapon can easily and quickly be deployed into a firing position.

To place the weapon in the High Port Arms carrying position, the center bar of the double eye is inserted into the metal clip which is riveted onto the left side of the magazine well on the MP5A2/A3/SD/N/SF submachine guns. On the MP5/10 and MP5/40, this clip is not present on the magazine well. It is sewn into the webbing of the ambidextrous multi-purpose carrying sling but functions in the same manner as the metal clip on the magazine well.

Once the double eye is inserted into the metal clip (some force is required) the weapon will hang slightly higher and closer to the chest of the operator.



To deploy the weapon into a firing position the shooter grasps the weapon by the forearm and trigger group and, with a quick aggressive thrust, shoves the weapon forward in the direction of the muzzle. The double eye will detach from the metal clip, allowing the weapon to be fired from the hip or shoulder. To return the weapon to the High Port Arms carrying position, reinsert the double eye into the metal clip.

Ill.# 82A - Hip Carry

Hip Carry - (See illustration # 82A) The hip carrying position allows the weapon to be carried along the shooters firing side or slightly across the his or her front. Generally, the weapon should be controlled with the firing hand when carried in this position. The double eye is not inserted into the metal clip when in the hip carrying position.

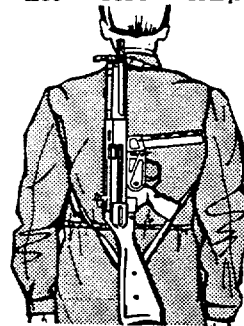

Ill.# 82B - Back Carry

Back Carry - (See illustration # 82B) The back carrying position is an administrative carrying position used only when the use of the weapon is not immediately required. This carrying position is convenient for use to carry the weapon on the back when not required, such as when climbing, running, skiing or while using another weapon. The weapon can be carried on the back muzzle up or muzzle down.

The weapon is placed in the back carrying position as follows. Stand the weapon on a flat surface on the buttstock with it's muzzle pointing up or down. Grasp one length of the webbing in one hand, the other in the other hand. Spread your hands open to form a large loop. Place your arms into the loop as though you were slipping into a coat, positioning the weapon vertically on your back. Remove any twists in the webbing and adjust the size of the loop by manipulating the length of the free end of the webbing to make the weapon ride comfortably on your back.

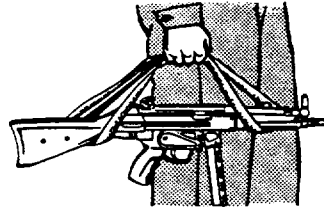

Ill.# 83A - Carrying Handle

Carrying Handle - (See illustration # 83A) This carrying method can be used to administratively carry the weapon when immediate use of the weapon is unnecessary. It can also be used to easily carry more than one weapon or as a safe (non-firing) carrying position off of the firing range.

Place the weapon in the carrying handle configuration in the same manner as described above for the back carrying position. However, in this case instead of slips your arms into the loop, bring one length of the webbing under neath the weapon. Join the two lengths together above the weapon. Adjust the lengths of the webbing as required to place the weapon in a stable horizontal carrying position, as pictured above in illustration # 83A.

Firing Positions -

Shoulder and Hip Firing Positions - (See illustration 83B and 83C) Both hip and shoulder firing positions can be assumed with the weapon slung as described earlier without any restrictions. The unique design of the H&K multi-purpose carrying slings secure the weapon to the shooter, allow hands free carry of the weapon without restricting the aiming or firing of the weapon.

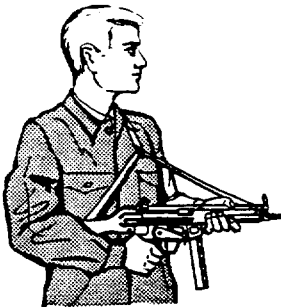

Ill.# 83B - Hip Firing Position

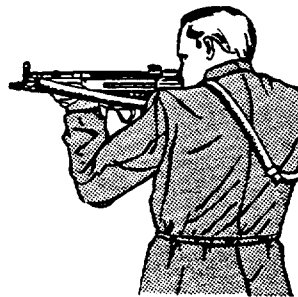

Ill.# 83C - Shoulder Firing Position

TRANSITIONING TO THE BACK-UP WEAPON

While wearing the MP5 submachine gun with the multi-purpose carrying sling it is simple and fast to transition to the back-up weapon in the event that the submachine gun malfunctions or runs dry.

To transition to the back-up weapon follow the following steps.

1. Keep your eyes on the target and take cover if possible.
2. Remove your finger from the trigger and outside of the trigger guard!
3. Drop the firing hand from the pistol grip of the submachine gun and deploy the back-up weapon.
4. In conjunction with step number 3, use the non-firing hand to depress the muzzle of the submachine gun diagonally across the body in the direction opposite of the firing hand.

Insure the weapon does not point at any portion of the body or at other individuals.

5. Once the threat no longer remains, scan the area for any additional threats. Once the area is clear, secure the back-up weapon (to include thumb break, if applicable).
6. Recover the submachine gun and place it back into operation.

COVERING THE SUSPECT

1. Keep the sights aligned on the lower extremities of suspect so that you can see his hands. Keep both eyes open to watch the suspect for any threatening actions and to watch the surrounding area for additional threats.
2. Keep your fingers off of the trigger and outside of the trigger guard!
3. The weapons safety/selector lever should be set on one of the available firing modes, not on safe. A round should be chambered.

WARNING

DO NOT place the finger inside the trigger guard or onto the trigger until you must actually fire the weapon. DO NOT allow fellow team members to pass between you and the suspect(s) while you are providing cover.

OPTIMUM FIRING POSITION

Your proficiency with the MP5, especially in burst or fully-automatic firing modes, is greatly dependent on your ability to master the necessary skills described below.

Contrary to popular belief, the muzzle of the MP5 in fully-automatic fire does not rise. The weapon simply pushes straight back into the shooters shoulder. However, the vertical and horizontal rotation of the shooters body causes the muzzle of the weapon to move upward and outward away from the initial point of aim.

While the first round may strike the intended aiming point, the recoil from each subsequent round pushes the shooters shoulder back further and further and the sights farther away from the center of the target. For example. A right handed firer's rounds will impact in a diagonal line from the initial point of aim in the direction of 2 o'clock (high and right). A left handed shooters rounds will climb high and to the left towards the 10 o'clock position.

It is impossible to prevent this rearward push that starts this rotation, regardless of how large or strong the firer may be. It is a simple law of physics that cannot be overcome by simple brute strength. This rearward push can only be countered through the use of the proper techniques, as described below.

The three (3) key elements for controlling the MP5 or any fully-automatic weapon are:

1. A **stable position** that allows the firer to resist (counter) the rearward push of the weapon caused by recoil.
2. **Concentration** on sight alignment and sight picture.
3. **Conscious redirection** of the weapon by making fine adjustments with the body.

Stable Position (stance) -

The stance should be a natural position to hold, and a position that is realistic to the tactics usually employed with a submachine gun. Range training and operational use of the weapon should be the same, so the shooter should train what he or she will do on the day of an actual operation.

Ultimately there will be occasions when forward movement by the firer will be required, either to close in on a suspect or during clearing rooms in a building. During this movement the necessity to open fire may become necessary. The stance should be one that allows the firer to shoot while still on the move and without having to stop. Therefore, the stance should be logical and as close to a natural position as possible to give the firer the best possible option when confronted in a deadly situation. It should also be a position that he or she will naturally assume instinctually.

The correct stance is also described as a "boxers stance", denoting it's aggressive, stable appearance when properly assumed. To properly assume this position follow the steps listed below, starting at the feet.

1. **Position feet** - Face square on to the target, feet shoulder width apart. Drop the strongside foot back about 6 inches (right foot for a right hand shooter, left foot for a left hand shooter).
2. **Flex the knees** - Slightly bend your knees to allow flexibility in the body (like shock absorbers). Your weight should be evenly distributed on both feet.
3. **Position the head and body** - Your hips and shoulders should be square to the front with the head upright. Tilting the head will result in a loss of balance, especially in a darkened environment.

4. **Bend forward** - Bend the upper portion of the body forward from the rib cage to give the back a slightly rounded appearance. (NEVER bend backward from the waist or keep the back straight as this will force the firer to go off balance and the rounds he or she is firing could miss the target.)

Be aggressive with your stance! Remember, you're a boxer!

5. **Position firing hand** - Once you have assumed the correct stance, pull the weapon firmly back into the pocket of the shoulder with the firing hand via the pistol grip. The firing hand pulls, and holds, the weapon back into the body. (At this point the grip of the firing hand on the weapon should be able to fully support the weight of the weapon without the assistance of the non-firing hand. Check your ability to do just that.)
6. **Position non-firing hand** - The non-firing hand should grasp the forearm/foregrip in a comfortable position, keeping all parts of the hand well clear of the muzzle. The non-firing hand is the control hand used to make the minor adjustments in the direction of the weapon prior to and during firing. Therefore, only a moderate amount of pressure is exerted on the forearm/foregrip of the weapon with the non-firing hand. Just enough so that the weapon never slips out of the palm during movement or firing.
7. **Tuck in elbows** - Pull the elbows in close to the body to lock in the weapon and to prevent them from getting knocked about during movement.

Concentration - Concentrate on the sights during firing, constantly striving to maintain correct sight alignment and sight picture as the weapon fires. Focus your concentration on the front sight. Your secondary vision (often referred to as peripheral vision) will allow you to "see" the rear sight and target without focusing directly on them.

As the sights move out of alignment and drift away from the initial aiming point, reacquire them and force them back into the center of the target using fine adjustments of the arms and body. Work to keep them there until the burst is complete.

Conscious Redirection - Immediately resist the tendency of the weapon to push your shoulder back during recoil. This movement becomes very pronounced by the time the second or third shot is fired.

Consciously redirect the sights to the initial aiming point on the target through minor adjustments with the non-firing hand and body. If you do not act to consciously redirect the weapon at the aiming point the weapon will unconsciously direct you away from the aiming point.

Control the weapon. Do not let the weapon control you!

As a drill using a "Clear" weapon, have someone slap the muzzle of the weapon back into your shoulder with their palm. When the position is correct, the muzzle of the weapon should move very little to the rear (less than 1/2 inch) and should immediately spring back into it's original position. The body should appear almost rigid to the observer.

As with any weapon, good steady-building trigger control is also important to good machine gun shooting.

TACTICAL RELOAD

Tactical magazine changes are the same whether using a single magazine or two magazines locked together using the optional dual magazine clamps. In training, avoid dropping the magazines onto hard surfaces that may damage them. Pad any hard surfaces with carpet or cardboard to soften their impact. Specifically assigned training magazines are also a good idea.

The steps for a good Tactical Reload for the H&K MP5 are as follows.

NOTE 1: Remember that if the 30-round MP5 magazine has been over filled with 31 rounds, you will not be able to seat the magazine in the weapon with the bolt forward.

NOTE 2: If the action of exchanging magazines is not carried out with some degree of controlled aggression, a magazine loaded with 30 rounds may prove difficult to seat in the weapon with the bolt forward.

1. **Transition to back up weapon, if necessary** - Transition to the back-up weapon if an immediate threat is present.
2. **Stay alert-** Keep your eyes open and scan the area for any threats.
3. **Signal your partner** - Notify your partner, in code, that you must reload.
4. **Seek cover** - Seek cover if it is immediately available or drop to one knee if no cover is available. (Remember, cover is protection against incoming fire, concealment only hides you from sight and affords no protection from incoming fire.)
5. **Tilt, rack and lock** - Tilt the ejection port towards the ground and rack the action back and forth one or more times. Watch for a live round or empty cases to be expelled from the weapon. Don't pick up the live round, leave it!

Lock the cocking handle back into the indent to hold the bolt to the rear.

6. **Secure a loaded magazine** - Locate and secure a loaded magazine **before removing the empty one from the weapon.**
7. **Remove empty magazine** - Depress the magazine release lever and remove the empty magazine. Let it drop to the floor.
8. **Load the full magazine** - Insert a fresh magazine or reposition the second magazine on the dual magazine arrangement into the magazine well of the weapon.

Tug on the magazine to make sure that it is securely engaged.
9. **Release the bolt** - Slap the cocking handle forward (or depress the bolt catch release lever on the MP5/10 or MP5/40) to chamber a new round. DO NOT ride the bolt forward.
10. **Signal your partner** - Notify your partner, in code, that you have finished your reload.
11. **Scan and continue** - Scan the area and continue your mission.

STORAGE OF THE WEAPON

1. Store the weapon clean and lubricated.
2. Store the weapon without a round in the chamber.
3. Store the weapon with the cocking lever forward and the hammer down (at rest).
4. After no more than twelve (12) months unload all loaded magazines and replace the ammunition with fresh ammunition.
5. Clean and lubricate the weapon and magazines every twelve (12) months while in storage.
6. Store the weapon in a clean, dry environment with regulated temperature controls.

USE OF OPTIONAL ACCESSORIES

Only the more commonly used accessories available from H&K are covered in this section. Refer any questions you may have about accessories not covered here directly to H&K or to the after market supplier of that item. H&K accepts no responsibility for injuries or damage to the weapon that may result in the incorrect use of the H&K-produced accessories or for those accessories not produced or sold by Heckler & Koch.

Multi-purpose Carrying Slings - See page 75 for the use and attachment of the standard and ambidextrous multi-purpose carrying slings available for the MP5 submachine gun.

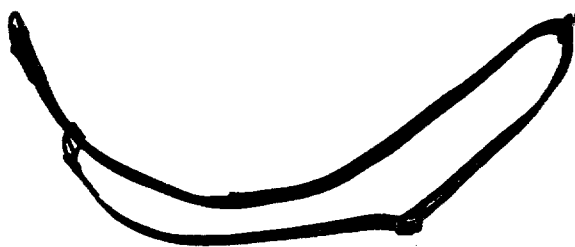

Ill.# 90A - Multi-purpose Carrying Sling (standard pictured)

Dual Magazine Clamp -

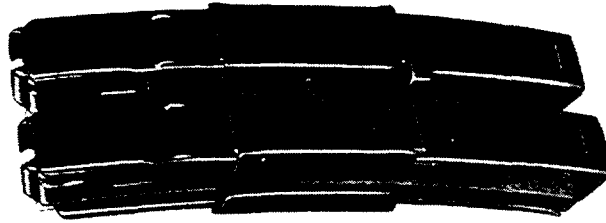

Ill.# 91A - Dual Magazine Clamp (9mm pictured)

1. Place the locking lever in it's unlocked position, perpendicular to the clamp itself.
2. Insert two magazines into the clamp, both facing up and in the same direction.
3. Position the clamp below the mid-point of the magazines with the bottom of the clamp just above the lowest round count hole located in the rear of the magazine housing.
4. Depress the locking lever in either direction to secure the magazines in the clamp.
5. Check the positioning of the magazines in the clamp by insuring that each magazine can be fully inserted and locked into place in the magazine well of the weapon.
6. Remove the magazine from the clamp during cleaning.

Magazine loader -

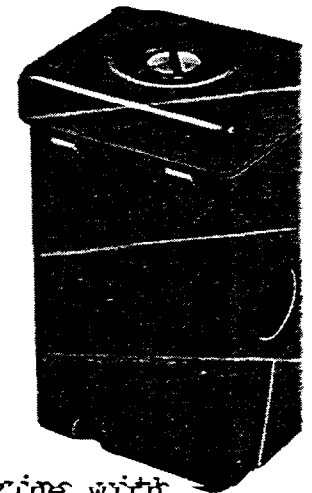

Ill.# 91B - Magazine Loader

1. Place the magazine loader onto the top of the magazine with the hole positioned along the rear side of the magazine.
2. Hold the magazine in your non-firing hand. Using your non-firing hand, grasp the magazine loader in your four fingers and place your thumb on top of the loader. Place the base of the magazine against a fixed surface or your body.
3. Insert one round into the loader through the hole in the rear, projectile forward.
4. Fully depress the loader with the non-firing thumb to insert the round into the magazine.

5. Repeat steps 3 and 4 above until the magazine has been filled. DO NOT fill the magazine with more than the prescribed number of rounds, i.e. 30 rounds in a 30-round magazine, 15 in a 15-round magazine.
6. Remove the magazine loader from the magazine once the magazine has been filled.

Magazine Unloader -

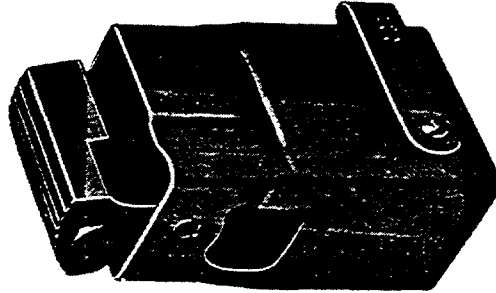

III.# 92A- Magazine Unloader

1. Press the unloader down onto the top of the loaded magazine with the hole positioned along the front side of the magazine. Insure that the locking lever on the unloader engages in the slot on the magazine housing. Point the hole in the unloader down.
2. With your palm, rock the serrated lever, located on the top of the unloader, to the left and right. A round should spill out of the unloader with each movement of the serrated lever. Continue this action until the magazine is empty.
3. Once the magazine is empty, lift the locking lever away from the magazine housing and lift the unloader off of the top of the magazine.

Muzzle Mounted Accessories -

CAUTION

Insure that all of the muzzle mounted accessories are properly attached to the weapon before use. Periodically check the accessories for secure attachment throughout use to insure that they remain securely attached to the weapon. Beware that these accessories may be hot as a result of firing. Failure to properly attach the muzzle mounted accessories and to recheck that attachment periodically may result in injury to the operator or bystanders, and/or damage to the accessory and/or weapon.

NOTE: All muzzle mounted attachments listed below must be removed, cleaned and lubricated each time the weapon is cleaned or after firing 1,000 rounds. Failure to do so will result in the creation of a carbon fouling bond that may make it difficult to remove the accessory from the muzzle of the weapon.

Sound Suppressor - See page 62 for use and attachment of the sound suppressor.

Flash Hider - There is a detachable flash hider for the 9mm MP5 and a different model for the 10mm/.40 S&W MP5's. The difference is the diameter of the bore of the flash hider to correspond to the diameter of the projectile. The 9mm flash hider will not fit on the 10mm/.40 S&W MP5.

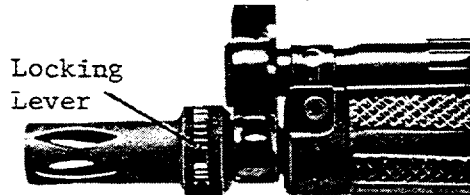

Ill.# 93A - Flash Hider

1. Prior to attaching the flash hider, insure that the flash hider and the muzzle of the weapon with it's 3 lugs are clean and lightly lubricated.
2. Disengage the locking lever by pressing it against it's spring tension along it's length. Use your finger nail or a small flat object to depress and lift the locking lever away from the body of the flash hider. The flash hider is now ready to be installed on the weapon.
3. Place the flash hider fully over the muzzle of the weapon and it's 3 lugs with the locking lever positioned away from the bottom of the flash hider.

4. Reengage the locking lever until it is retained by spring pressure and the notch, located at the front end of the locking lever, is securely engaged on the engagement pin found in the slot in the body of the flash hider.

You may find it necessary to slightly rotate the flash hider to fully engage the locking lever.

5. Check for secure attachment of the flash hider by pulling forward and twisting the flash hider. Check again for the complete engagement of the locking lever.

Grenade Launcher - The detachable grenade launcher is attached to and removed from the MP5 in the same manner as the flash hider described above. The grenade launcher is used to launch rifle-style grenades with an inside diameter of 22 mm using a special grenade launching cartridge.

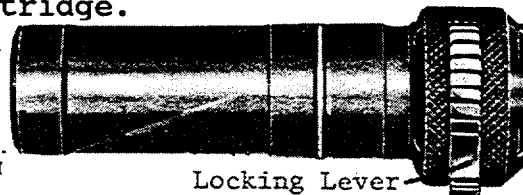

Ill.# 94A - Grenade Launcher

Locking Lever

Blank Firing Attachment (adaptor) - Often referred to as the "BFA", the blank firing attachment for the MP5 is attached and removed from the weapon in the same manner as the flash hider described above. The BFA is marked with a red painted band denoting it is for use with blank ammunition only. The BFA will work on all 9mm models of the MP5 submachine gun that have the 3-lug barrel, which excludes the MP5K and MP5KA1.

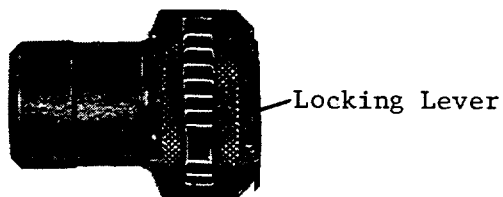

Ill.# 94B - Blank Firing Attachment

WARNINGS

1. NEVER FIRE THE MP5 WITH LIVE AMMUNITION WITH THE BLANK FIRING ATTACHMENT IN PLACE.
2. ALWAYS INSURE THAT BLANK AND LIVE AMMUNITION IS NOT MIXED IN THE MAGAZINE, ESPECIALLY WHEN THE BFA IS ATTACHED TO THE WEAPON.
3. INSURE AT ALL TIMES THAT THE BFA IS SECURELY ATTACHED TO THE WEAPON.
4. DO NOT ATTEMPT TO MODIFY THE BFA IN ANY WAY.

The recommended blank ammunition for use in the 9mm MP5's in conjunction with the H&K blank firing attachment is the Dynamit Nobel "Plastic Manoeuvre" cartridge. This special round, designed for use in the MP5 submachine gun, contains a black pre-fragmented "projectile" that insures optimum feeding in automatic weapons. When fired this black plastic tip opens up and releases the propellant gases in the bore but stays securely attached to the cartridge case. These blank cartridges are loaded and fired in the same manner as live rounds and allow the MP5 to be fired in all modes of fire.

The Dynamit Nobel Plastic Manoeuvre round provides sufficient gas pressure and recoil impulse to reliably operate the roller-locked bolt employed in the MP5 without modification to the weapon or the BFA. Other types of blank rounds available may not provide sufficient recoil impulse to reliably work the bolt of the MP5, though they may function well in other types of 9mm weapons that are not roller-locked.

The Dynamit Nobel Plastic Manoeuvre (blank) ammunition is manufactured in Germany but is available in the U.S. through their U.S. office located in Northvane, New Jersey. Their telephone number is (201) 767-1995.

Detachable Scope Mounts - There are various versions of the unique H&K quick-detachable scope mounts. These mounts can be used to affix all manner of targeting devices (lasers, lights, scopes, etc.) to the all models and variants of the MP5. They provide the MP5 user with the ability to zero one or more types of targeting devices to a single weapon. The user can then select the appropriate targeting device at any moment for the mission at hand with the assurance that that device will still be zeroed to the weapon once reattached. Two spring actuated bolts, positioned along the base of the mount, exert pressure on the receiver to hold the mount in the same position at all times. All versions of the quick-detachable scope mounts provide a tunnel through the scope mount so that the firer can use the iron sights while the scope mount is attached to the top of the receiver.

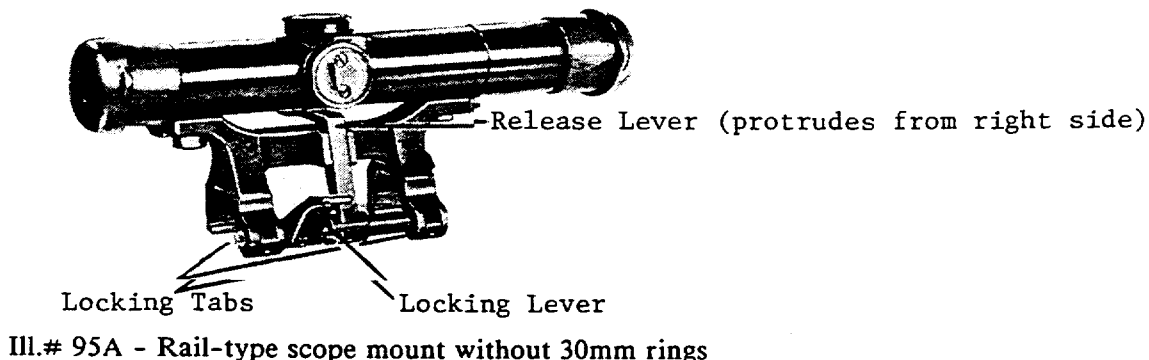

To attach the scope mounts, follow the procedure as listed below.

1. **CLEAR THE WEAPON!**
2. Locate the arrow on the base of the mount that points in the direction of projectile travel. Face the mount with that arrow pointing away from you with the mount in an upright position.
3. Locate the release lever on the right side of the mount. It is a paddle shaped lever with serrations that protrudes horizontally from the right side of the mount. Depress and hold the release lever down.
4. Locate the locking lever on the left side of the mount. It is a beaver tail shaped lever that lays in a vertical position along the left side of the mount. Pull the locking lever away from the mount and fully depress it as you hold down on the release lever. In doing so the locking tabs attached to the locking lever and located on the bottom of the mount are withdrawn.

At this point the mount can be positioned on the weapon.

5. Locate the scope mounting platform located on the top of the receiver about two inches forward of the rear sight assembly. Set the mount onto the receiver by tilting into place from right to left with the rear bridge of the mount positioned in the scope mounting platform.
6. Holding the mount in place, pull down on the locking lever until you hear a "click" (the sound of the release lever snapping into the locking lever). Rotate the locking lever back into an upright stored position.

To remove the scope mounts, grasp the targeting device and/or mount and depress the release lever. The locking tabs will disengage from the receiver and the mount can now be removed from the weapon.

Sight Adjustment Tool - See page 70 for the use of the sight adjustment tool.

Buttcap for MP5A2/A3 - This plastic buttcap replaces the fixed or retractable buttstocks on the 9mm MP5A2/A3/N/SF when the buttstock is not required. The buttcap has a sling swivel attached to it's back side for use with a carrying sling or rig.

To attach the buttcap to the weapon first **CLEAR THE WEAPON!** **Slap the cocking lever and bolt forward.** Remove the buttstock from the weapon. Align the rails of the buttcap with the grooves in the left and right sides of the receiver. Firmly press the buttcap into place on the receiver and insert the locking pin to secure it. These caps fit very tightly on the weapon so some controlled force may be necessary to mount the buttcap.

Remove the buttcap by pulling it from the receiver after the locking pin has been removed.

Tactical Forearm with Light ("Sure-Fire") - The standard forearm of the MP5A2/A3/N/SF and the MP5/10 and MP5/40 can be replaced with a molded forearm assembly that has a flashlight built into it. The current design of this forearm does not allow it to be used on the MP5-N with the screw-on sound suppressor installed. Other models of the Sure-Fire Tactical Light are available to attach to all models and variants of the MP5 submachine gun.

To attach the Tactical Forearm with Light, first **CLEAR THE WEAPON!** Next, remove the locking pin from the standard forearm and remove the standard forearm. Install the tactical Forearm with Light in the same manner as is done with the standard forearm.

It may be necessary to slightly spread the front of the forearm using a screwdriver, as these accessories are designed to fit snugly on the weapon. Align the pin hole and install the locking pin. If applicable, attach the second remote pressure switch to the pistol grip of the weapon in accordance with the instructions provided with the accessory.

All other accessories for the MP5 submachine guns should be installed in accordance with the instructions provided with that particular item. If no instructions are received, contact the manufacturer for guidance.

TROUBLE SHOOTING

Maintaining detailed records, in the form of a **Weapon Record Book**, will help the unit armorer or H&K diagnose problems that may occur in your MP5 submachine gun. This book should include a running tally of the total rounds fired through the weapon, any problems experienced, all work performed to include parts that are replaced, dates, and initials of the person responsible for the action listed. Such books are available from H&K under ID# 700587. Records can also be kept on individual weapons in the back of the operators manual.

Maintaining this type of record will eventually provide the user with a history of parts failures that can be used to predict future deficiencies **before they occur!** In this way the operator can perform preventive maintenance instead of corrective maintenance.

These books should be available to the armorer and operator at all times so that the data may be entered as it is generated.

However, even with detailed record keeping problems may still occur, even in a high-quality weapon like the MP5. If they do, first eliminate these general causes that are often to blame.

1. Operator error (incorrect use or maintenance)
2. Ammunition (bad lot, poor quality or condition, wrong type)
3. Magazines (damaged or fouled)
4. Fouled or poorly lubricated weapon.
5. Weapon is assembled incorrectly or with wrong components.

If after investigating these general areas the problems still occur, refer to the more detailed common stoppages listed below.

Weapons may be sent to HK-Inc. in Sterling for repair, rebarreling or refinishing in house. **Contact your customer service representative or H&K's Repair Department BEFORE sending your MP5 in for service!** Please send along the magazines used with the weapon.

Rebarreling an MP5 cost @ \$250 - \$300 and can be done at HK-Inc. in two weeks or less for military or law enforcement customers. Unless the barrel is damaged or excessively worn, H&K generally would not recommend having a barrel replaced that has less than 30,000 rounds fired through it. Refinishing can also be performed by HK-Inc. and takes @ 4-6 weeks. Call H&K's Repair Department for current pricing and turn-around time for such work.

Complete reconditioning (inspection, rebarreling, refinishing, replacement of worn parts, etc.) can be done on the same receiver up to three times for about one half of the cost of a new weapon. This procedure is done at the HK-GmbH factory in Germany and takes about 4-8 weeks once the import and export permits are in place. Coordinate this action with your customer service representative at H&K before sending in your weapon(s). Reconditioning is a great way to extend the service life of even the most used MP5 for @ one half of the cost of a new weapon.

Trouble Shooting the more common MP5 stoppages

SYMPTOM	CAUSE	REMEDY
* Cartridge cases will not eject from weapon.	Worn extractor spring.	Replace extractor spring. Clean and lube under extractor first.
	Dirty chamber	Clean and lubricate
	Defective magazine (split seam or bent feed lips)	Replace magazine housing
	Defective ejector or ejector spring	Replace ejector and/or ejector spring
	Ammunition inconsistency/quality	Use different ammunition or lot
	Wrong locking piece installed	Install correct locking piece

* Locking rollers fall from bolt head	Broken locking roller holder	Replace rollers and install new locking roller holder

NOTE: In an emergency when spare parts are not readily available, reinstall the locking rollers into the bolt head and without the holder, insuring that all parts of the broken holder are removed from the weapon. The weapon will function normally without the holder, though the holder must be replaced at the first opportunity to prevent the locking rollers from being lost and the weapon from being fired without them in place. The rollers can only come out of the bolt and thus out of the weapon once the bolt group is removed from the receiver.

* Bolt will not lock closed	Obstruction in chamber	Remove obstruction, clean and lube chamber
	Improper loading procedure	Use correct procedure
	Dent in receiver or cocking lever housing	Return to unit armorer or H&K for repair

* Sound suppressor of MP5SD will not unscrew or come off weapon	Carbon build-up between sound suppressor and barrel. Too many rounds between cleaning using MP5SD Barrel Cleaning Device (ID# 225376)	Remove and clean weapon as described on page 53
---	---	---

* Recoil spring guide rod falls off bolt group	Worn nylon guide rings. Recoil spring guide rod removed unnecessarily during operator dis-assembly; or excessive use	Replace nylon guide rings and retrain operator not to remove the recoil spring guide rod from the bolt group
--	--	--

NOTE: In the field the recoil spring guide rod can be reversed and the weapon used in a normal fashion until the nylon guide rings can be replaced by an armorer.

* Rubber buffer on MP5/10 and MP5/40 retractable stock is cracked and/or shows signs of deep impressions from the impact of the bolt carrier.	Overfunction of bolt group from use of HI impulse ammunition in a weapon assembled with a LO impulse locking piece.	Install "HI" impulse locking piece. Replace rubber buffer.
---	---	--

* MP5K-PDW used with optional sound suppressor. Failures to feed and/or eject. Excessively high rate of fire (@ 1,200 rpm)	Worn extractor spring caused by overfunction of bolt group when using a sound suppressor	Install 80 degree locking piece and new extractor spring for regular use with sound suppressor
--	--	--

* Ambidextrous trigger group safety/selector lever will not rotate into place during reassembly.	Damaged trigger housing on opening on right side of trigger group. Burr at 7:00 position in metal trigger mechanism housing from being forced during reassembly.	Remove burr in opening in trigger group housing using jewelers file.
--	--	--

NOTE: The remedy for this problem should only be performed by a qualified H&K armorer once the trigger mechanism has been removed from the pistol grip.

* Weapon doubles (fires more than one shot per trigger pull when set on semiautomatic firing mode)	Broken or missing firing pin spring	Install new firing pin spring
--	-------------------------------------	-------------------------------

* Empty cases will not extract from chamber	Excessive chamber pressure of ammunition characterized by pronounced flute marks along length of cartridge case	Discontinue using that type of ammunition
	Fouled chamber	Clean and lube chamber
	Damaged or missing extractor and/or extractor spring	Replace with new extractor and/or extractor spring

* Cocking handle
is difficult to
pull rearward

Lack of lubrication Lubricate detente
on detente located
in front end of
cocking lever
support

PARTS LIST

EXPLODED DIAGRAM #	ITEM #	ITEM DESCRIPTION	PART #
<u>ASSEMBLY GROUPS</u>			
1	1	Receiver w/ barrel, cocking lever and sights (MP5A2/A3)	206233
1	2	Bolt group, compl. (MP5A2/A3/N)	201502
	*	Bolt group, compl. (MP5K/KN)	206414
1	3	Grip w/ trigger mechanism and fire selector, SEF (MP5A2/A3/SD)	206229
	*	Grip w/ trigger mechanism and selector, SEF (MP5K)	206542
1	4	Buttstock, fixed	205586
1	5	Buttstock, retractable (9mm)	225558
	*	Buttstock, retractable (10mm/.40 S&W)	214278
		Note: can also be used on 9mm MP5's	
	*	Buttstock, folding (MP5KPDW)	701212
1	6	Forearm, slimline (MP5A2/A3)	224007
2	6.1	Forearm, wide (standard for MP5A2/A3/N/SF)	206657
5	3	Handguard (MP5SD)	206472
3	2	Handgrip (MP5K/KN/PDW)	206421
1	7	Magazine, 30 round (9mm)	206349
	*	Magazine, 30 round (10mm/.40 S&W)	205131
	*	Magazine, 15 round (9mm)	206477
	*	Multi-purpose sling (MP5A2/A3/SD/N/SF)	205506
	*	Ambidextrous carrying sling (MP5/10 & MP5/40)	205213
		Note: requires mounting pins #700148 & #700154	
	*	Leather carrying sling	200574
5	2	Sound suppressor, aluminum (MP5SD)	928878
	*	Sound suppressor, stainless steel (MP5SD-N)	700135
	*	Sound suppressor, stainless steel (MP5N/KN/PDW)	700134
	*	Sound suppressor (MP5/10 & MP5/40)	701600
	*	Flash hider (MP5SF)	221127
		(also fits MP5A2/A3/N/K-N/PDW)	

PARTS LIST (cont.)

EXPLODED DIAGRAM #	ITEM #	ITEM DESCRIPTION	PART #
-----------------------	--------	------------------	--------

BARREL WITH RECEIVER

2	1.1	Receiver w/ barrel, cocking lever housing and front sight holder (MP5A2/A3)	206234
	*	Receiver w/ barrel, cocking lever housing and front sight holder (MP5N)	225219
5	1	Receiver w/ barrel, cocking lever housing and front sight holder (MP5SD)	206722
3	1	Receiver w/ barrel, cocking lever housing and front sight holder (MP5K)	206541
	*	Receiver w/ barrel, cocking lever housing and front sight holder (MP5/10)	205098
	*	Receiver w/ barrel, cocking lever housing and front sight holder (MP5/40)	205272
2	1.2	Barrel (MP5A2/A3)	201590
	*	Barrel (MP5SD)	205920
	*	Barrel (MP5K)	206420
	*	Barrel w/ front sight holder, thread cap and eyebolt, black (MP5N)	214426
	*	Barrel w/ front sight holder, thread cap and eyebolt, black (MP5KN)	214428
	*	Barrel w/ front sight holder, thread cap and eyebolt, black (MP5/10)	214142
	*	Barrel w/ front sight holder, thread cap and eyebolt, black (MP5/40)	214422
2	1.3	Barrel pin, 5.0mm (stnd)	200437
		Barrel pin, 5.015mm	201262
		Barrel pin, 5.03mm	225161
		Barrel pin, blank, 5.1mm	922019
2	1.4	Cocking lever housing, compl.	201573
2	1.5	Holding clip with bush	200418
2	1.6	Front sight holder w/ front sight	201561
2	1.7	Front sight	200415
	*	Front sight w/ tritium dot and ring (MP5N/KN/SDN/PDW)	700126
2	1.8	Clamping sleeve	922609
2	1.9	Eyebolt 104	201241

PARTS LIST (cont.)

EXPLODED DIAGRAM #	ITEM #	ITEM DESCRIPTION	PART #
-----------------------	--------	------------------	--------

BARREL WITH RECEIVER (cont.)

2	1.10	Cocking lever support, compl. (MP5A2/A3/SD)	205906
	*	Cocking lever support, compl. (MP5K)	206423
2	1.11	Cocking lever, complete (MP5A2/A3/SD/N/SF)	205905
2	1.12	Clamping sleeve	922609
2	1.13	Catch bolt	205910
2	1.14	Spring for catch bolt	202495
2	1.15	Cap, compl., cocking tube (aluminum)	200385
	1.15	Cap, compl., cocking tube (steel)	206497
2	1.16	Cartridge case deflector	201526
2	1.17	Rivet for cartridge case deflector	201527
2	1.18	Adjusting screw	200384
2	1.19	Ball spring	200383
2	1.20	Ball (3mm)	929897
2	1.21	Catch bolt	200381
2	1.22	Spring for catch bolt	200382
2	1.23	Rear sight support	200375
2	1.24	Rear sight cylinder (MP5A2/A3/SD/N/MP5/10 & MP5/40)	201542
	*	Rear sight cylinder (MP5K/KN/PDW)	206415
	*	Rear sight, compl. (MP5A2/A3/SD/MP5/10 & MP5/40)	201515
	*	Rear sight, compl. (MP5K/KN/PDW)	206407
	*	Spare parts set for rotary rear sight	200988
2	1.25	Washer	200371
2	1.26	Toothed lock washer	922617
2	1.27	Clamping screw	200372
2	1.28	Magazine catch, compl.	206228
2	1.29	Compression spring for magazine catch (MP5A2/A3/SD/N/K)	200393
	*	Compression spring for magazine catch (MP5/10 & MP5/40)	205100
2	1.30	Contact piece for magazine catch	201517
2	1.31	Push button for magazine catch	200396
2	1.32	Clamping sleeve	922608
2	1.33	Magazine release lever, compl. (MP5A2/A3/SD/N/K)	201513
	*	Magazine release lever (MP5/10 & MP5/40)	205099
2	1.34	Bushing for mag. release lever	200397

PARTS LIST (cont.)

EXPLODED DIAGRAM #	ITEM #	ITEM DESCRIPTION	PART #
-----------------------	--------	------------------	--------

BARREL WITH RECEIVER (cont.)

4	11	Axle, bolt catch, 2 X 8mm (MP5/10 & MP5/40)	205101
	*	Clamping sleeve, 2 X 8 mm	980717
4	13	Bolt catch lever (MP5/10 & MP5/40)	205102
4	14	Clamping sleeve, 2 X 6mm (MP5/10 & MP5/40)	928574
4	15	Elbow spring (MP5/10 & MP5/40)	205103
	*	Cocking lever support (MP5/10 & MP5/40)	205310
	*	Compression spring (MP5/10 & MP5/40)	205314
	*	Cocking lever (MP5/10 & MP5/40)	205308
	*	Clamping sleeve, 4 X 12mm (MP5/10 & MP5/40)	922609
2	16	Protective cap for muzzle threads, 9mm (MP5N/KN/PDW)	225217
2	16	Protective cap for muzzle threads, 10mm/.40 S&W (MP5/10 & MP5/40)	205283
5	4	Seal ring, rubber, for MP5SD sound suppressor	206469

BOLT GROUP

2	2.1	Carrier, bolt head (MP5A2/A3/SD/N/SF)	201594
	*	Carrier, bolt head (MP5K/KN)	206413
	*	Carrier, bolt head (MP5/10 & MP5/40)	205117
2	2.2	Stop pin	201597
2	2.3	Clamping sleeve 2X5	205597
2	2.4	Bolt head, incompl. w/o rollers, extractor, etc. (MP5A2/A3/K/SD/N/SF)	201609
	*	Bolt head, compl. w/ all parts (MP5A2/A3/K/SD/N/SF)	201595
	*	Bolt head, new for Action 3 ammo, compl. (uses wire roller holder #221125)(MP5A2/A3/K/SD/N/SF)	205489

PARTS LIST (cont.)

EXPLODED DIAGRAM #	ITEM #	ITEM DESCRIPTION	PART #
-----------------------	--------	------------------	--------

BOLT GROUP (cont.)

	*	Bolt head, compl. w/ all parts (MP5/10 & MP5/40)	205121
2	2.5	Extractor (9mm)	201610
	*	Extractor (10mm/.40 S&W)	205123
2	2.6	Spring, extractor	206645
2	2.7	Roller, locking, 7.96mm	200007
2	2.7	Roller, locking, 7.98mm	222232
2	2.7	Roller, locking, 8.00mm (standard size)	200446
2	2.7	Roller, locking, 8.02mm	200447
2	2.7	Roller, locking, 8.04mm	200448
	*	Roller, locking (MP5/10 & MP5/40)	205124
2	2.8	Holder for locking rollers, plate (for bolt heads #201609 & 201595)	200449
	*	Holder for locking rollers, wire (for Action 3 bolt head #205489 and for MP5/10 & MP5/40 bolt head #205121)	221125
2	2.9	Clamping sleeve	200450
2	2.10	Locking piece (MP5A2/A3/N/SF)	201599
2	2.10	Locking piece (MP5K/KN & PDW w/o sound suppressor)	224786
2	2.10	Locking piece, 80°, for MP5K-PDW w/ sound suppressor	214292
2	2.10	Locking piece (MP5SD)	205929
2	2.10	Locking piece, HI impulse 60° (MP5/10 & MP5/40)	205282
2	2.10	Locking piece, LO impulse 90° (MP5/10 & MP5/40)	205189
2	2.11	Spring, firing pin	201601
2	2.12	Firing pin	201600
	*	Recoil spring assembly, compl. (MP5A2/A3/SD/N/SF/MP5/10 & MP5/40)	205596
	*	Recoil spring assembly, compl. (MP5K/KN)	206400
2	2.13	Recoil spring (MP5A2/A3/SD/N/SF)	201603
	*	Recoil spring (MP5K/KN)	206391
2	2.14	Recoil spring guide rod (MP5A2/A3/SD/N/SF)	201604
	*	Recoil spring guide rod (MP5K/KN)	206401
2	2.15	Guide ring	200524
2	2.16	Stop pin for recoil spring	205603
2	2.17	Rivet (2 each)	200526

PARTS LIST (cont.)

EXPLODED DIAGRAM #	ITEM #	ITEM DESCRIPTION	PART #
-----------------------	--------	------------------	--------

GRIP WITH TRIGGER AND SAFETY MECHANISM
(SEF)

2	3.1	Grip only (MP5A2/A3&SD)	201628
	*	Trigger mechanism, compl.w/o grip	206235
2	3.3	Locking pin, compl.	200459
2	3.4	Fire selector lever, compl.	221202

TRIGGER MECHANISM
(SEF)

2	3.2.1	Trigger housing	205657
2	3.2.2	Hammer w/pressure shank, compl.	205569
2	3.2.5	Hammer spring	201638
2	3.2.6	Hammer axle	200494
2	3.2.7	Axle for trigger and catch	200482
2	3.2.8	Trigger, complete	205629
2	3.2.9	Sear	200490
2	3.2.10	Trigger bolt	200492
2	3.2.11	Compression spring to sear	200493
2	3.2.12	Clamping sleeve	200450
2	3.2.13	Elbow spring for trigger	200483
2	3.2.14	Catch with roller	200871
2	3.2.15	Elbow spring w/roller	200505
2	3.2.16	Distance sleeve for catch	200504
2	3.2.17	Ejector axle	200480
2	3.2.18	Spring ring for ejector axle	200481
2	3.2.19	Ejector (9mm)	201639
	*	Ejector (10mm/.40 S&W)	205128
2	3.2.20	Ejector spring	200478
2	3.2.21	Release lever, complete	202054

PARTS LIST (cont.)

EXPLODED DIAGRAM #	ITEM #	ITEM DESCRIPTION	PART #
-----------------------	--------	------------------	--------

AMBIDEXTROUS TRIGGER GROUP
WITH TRIGGER, SAFETY MECHANISM
AND TRIGGER HOUSING

6	1	Trigger Group, compl. (MP5N & SDN)	225188
	*	Trigger Group, compl. (MP5KN)	225218
6	2	Grip only (MP5N & SDN)	225204
	*	Grip only (MP5KN)	225230
	*	Grip only (MP5SF)	225523
6	3	Axle, safety (left)	225211
	*	Axle, safety, left (MP5SF)	225526
6	4	Switch, safety (right)	225089
6	5	Trigger mechanism, compl.	225205
	*	Trigger mechanism, compl. (MP5SF)	225524
	*	Trigger mechanism, compl. (MP5/10 & MP5/40)	205299
6	6	Hammer w/pressure shank	205569
6	8	Trigger, compl.	225209
	*	Trigger, compl. (MP5SF)	225525
6	12	Sear, compl.	200489
6	14	Bushing	225206
6	15	Trigger housing (bare)	225207
	*	Trigger housing, bare (MP5SF)	225530
6	16	Elbow spring w/rollers	200505
	*	Elbow spring w/ rollers (MP5SF)	202545
6	17	Axle, ejector	200479
6	19	Ejector (9mm)	201639
	*	Ejector (10mm/.40 S&W)	205128
6	20	Spring, ejector	200478
6	21	Distance sleeve (for elbow spring w/rollers/catch)	200504
	*	Distance sleeve (MP5SF)	221022
6	23	Axle, hammer	200494
6	24	Spring, hammer	201638
6	25	Axle for trigger & catch	200482
6	26	Release lever	202054
6	28	Catch w/roller	200871
6	29	Axle, catch lever	224423
6	30	Axle, catch lever spring	224424
6	31	Catch, lever	224425
6	32	Spring, catch lever	224426
6	33	Spring, trigger	200483
6	34	Holder for thread cap, compl. (MP5N/KN/PDW/MP5/10 & MP5/40)	205483

PARTS LIST (cont.)

EXPLODED DIAGRAM #	ITEM #	ITEM DESCRIPTION	PART #
-----------------------	--------	------------------	--------

**3-ROUND BURST TRIGGER GROUP
WITH TRIGGER, SAFETY MECHANISM
AND TRIGGER HOUSING**

7	1	Trigger group, compl, fits MP5A2/A3/N/SD	225002
	*	Trigger group, compl, fits MP5K/KA1/KN	224818
7	2	Grip only (MP5A2/A3/N/SD)	225003
	*	Grip only (MP5K/KA1/KN)	224819
7	3	Axle, safety (left)	225087
7	4	Switch, safety (right)	225089
7	5	Trigger mechanism, compl, (MP5A2/A3/N/SD/K/KA1/KN)	224811
7	6	Hammer w/ pressure shank, compl	224813
7	7	Shifter rod	224429
7	8	Trigger	224436
7	9	Sear release latch	224435
7	10	Elbow spring for sear latch	224434
7	11	Axle for sear release latch	224433
7	12	Sear, compl	224439
7	13	Counting wheel	224441
7	14	Stop latch	224445
7	15	Trigger housing (bare)	224448
7	16	Elbow spring w/ roller	200505
7	17	Ejector axle, compl	200479
7	18	Eccentric bushing	224418
7	19	Ejector	201639
7	20	Spring for ejector	200478
7	21	Distance sleeve for catch	200504
7	22	Disk (Deleted)	224419
7	23	Hammer axle	200494
7	24	Hammer spring	201638
7	25	Axle for trigger and catch	200482
7	26	Compression spring for shifter rod	224420
7	27	Compression spring rod	224421
7	28	Catch	225107
7	29	Axle for catch lever	224423
7	30	Axle for stop latch	224424
7	31	Catch lever	224425
7	32	Elbow spring for stop latch	224426
7	33	Elbow spring for trigger	224480
7	34	Hammer spring bushing	224996
7	35	Catch release lever	225111

PARTS LIST (cont.)

EXPLODED DIAGRAM #	ITEM#	ITEM DESCRIPTION	PART #
-----------------------	-------	------------------	--------

BUTTSTOCK, FIXED

2	4.1	Buttstock, compl.	205586
2	4.2	Back plate (MP5A2/A3/SD)	205590
2	4.3	Locking pin, compl.	200520
	*	Buttcap, compl. (MP5K/KN)	206409
3	3	Buttcap, incompl. w/o swivel or circlip (MP5K/N)	206416
3	4	Swivel with bushing	205935
3	5	Circlip, 4.0mm	971748

BUTTSTOCK, RETRACTABLE

2	5.1	Buffer	206689
2	5.2	Back plate	202038
2	5.3	Compression spring	200985
2	5.4	Compression bolt	200984
2	5.5	Buffer screw	200983
2	5.6	Clamping sleeve	200959
2	5.7	Ratchet	200951
2	5.8	Protective cover w/plug	205839
2	5.9	Clamping lever	205838
2	5.10	Spring ring w/catch	200952
2	5.11	Retractable buttstock, end only (see diagram)	201183
2	5.12	Circlip	922622
2	5.13	Locking pin, compl.	200520

HANDGUARD

1	6	Forearm, slimline(MP5A2/A3)	224007
2	6.1	Forearm, wide (standard for MP5A2/A3/N/SF/MP5/10 & MP5/40)	206657
5	3	Handguard (MP5SD)	206472
3	2	Vertical foregrip (MP5K/KN/PDW)	206421
2	6.2	Locking pin, compl.	200459

PARTS LIST (cont.)

EXPLODED DIAGRAM #	ITEM #	ITEM DESCRIPTION	PART #
<u>MAGAZINE</u>			
2	7.1	Magazine housing, 30rd. (9mm)	206305
	*	Magazine housing, 30rd. (10mm & .40 S&W)	205135
2	7.2	Follower (9mm)	206675
	*	Follower (10mm & .40 S&W)	205132
2	7.3	Follower spring (9mm)	206677
	*	Follower spring (10mm & .40 S&W)	205133
2	7.4	Locking plate, compl.	206680
2	7.5	Magazine floor plate (9mm)	201654
	*	Magazine floor plate (10mm & .40 S&W)	205134
	*	Magazine housing, 15rd.	206478
	*	Follower spring	206679

MULTI-PURPOSE CARRYING SLING

2	*	Multi-purpose carrying sling (MP5A2/A3/SD/N/SF) (includes part 8.2 to 8.5)	205506
	*	Ambidextrous carrying sling (requires sling pins listed below)	205213
	*	Leather carrying sling (includes part 8.2 to 8.5)	200574
2	8.2	Carbine hook, compl.	200581
2	8.3	Double eye	205511
2	8.4	Buckle	201730
2	8.5	Hook	200217
	*	Sling pin, ambidextrous, large for buttstock, compl. (with locking knob)	700148
	*	Sling pin, ambidextrous, small for forearm, compl. (with locking knob)	700154
	*	Spare locking knob for sling pin (#700148 & 700154)	205119
	*	Spare rubber O-ring for sling pin (#700148 & 700154)	982311

OPTIONAL ITEM

*		Spare retaining spring for holder for thread cap (#205483)	224650
---	--	---	--------

EXPLODED DIAGRAM

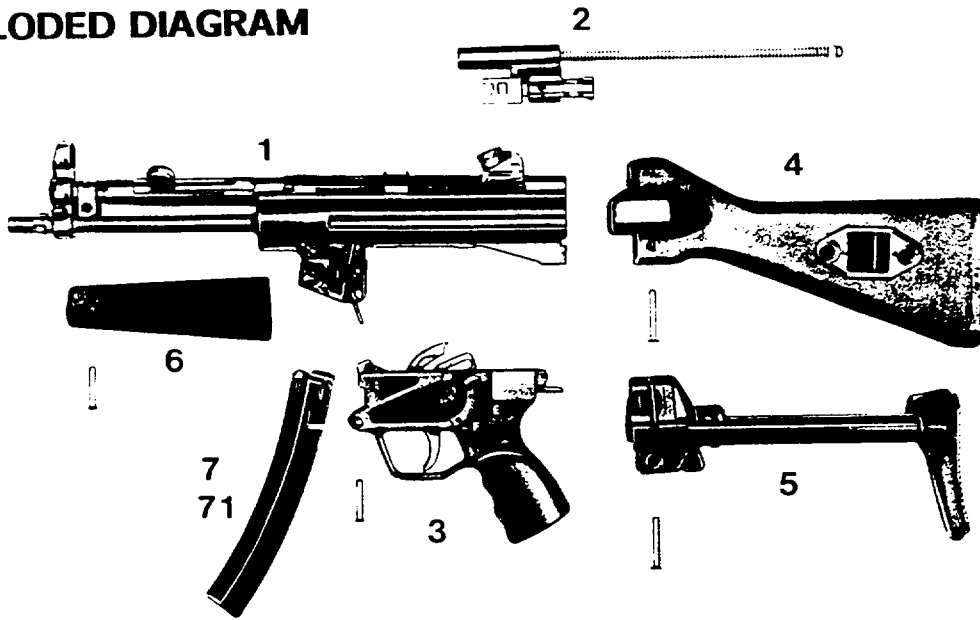

Exploded Diagram # 1 - Assembly Groups

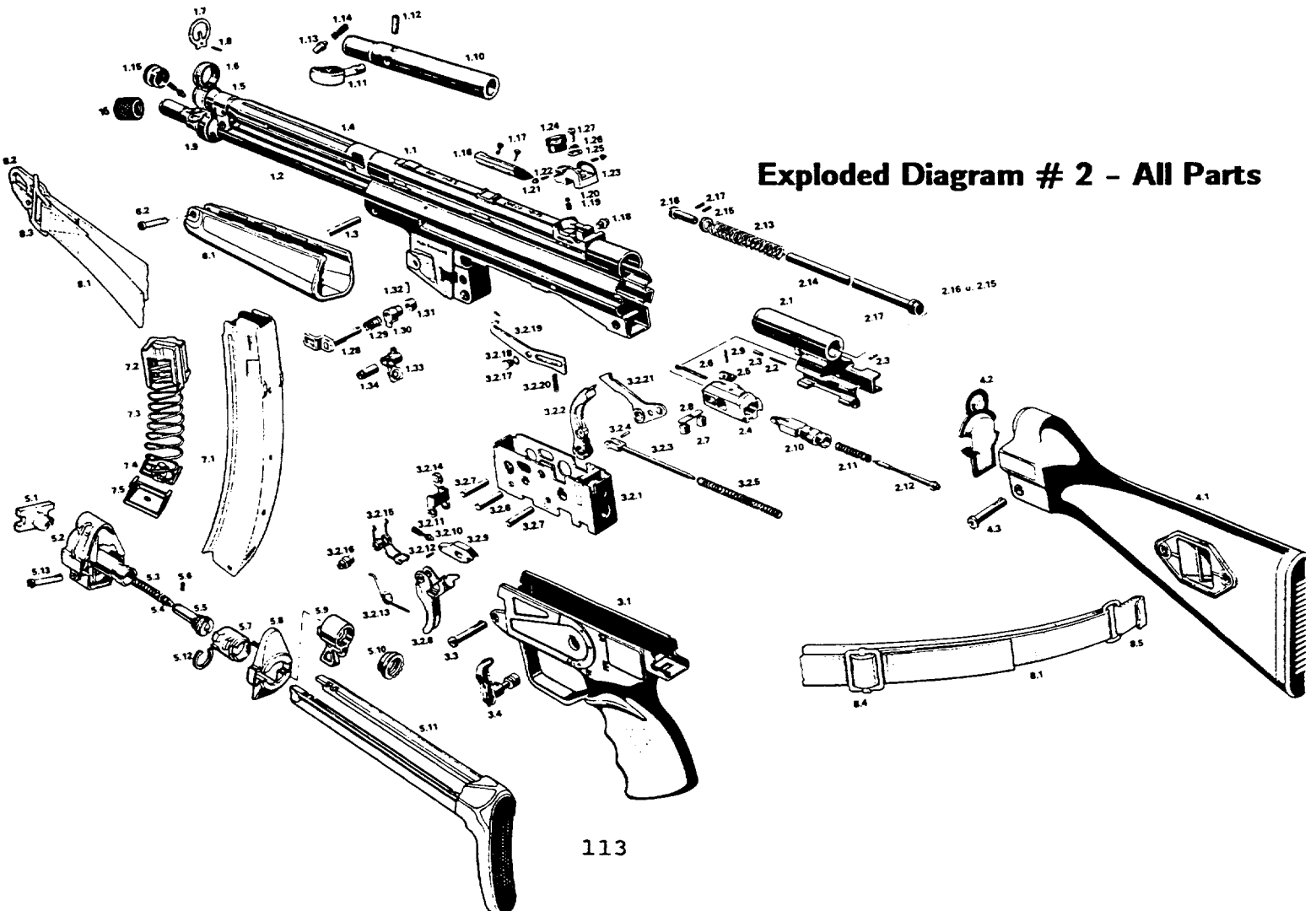

Exploded Diagram # 2 - All Parts

**EXPLODED DIAGRAM
(cont.)**

Exploded Diagram # 3 - MP5-K

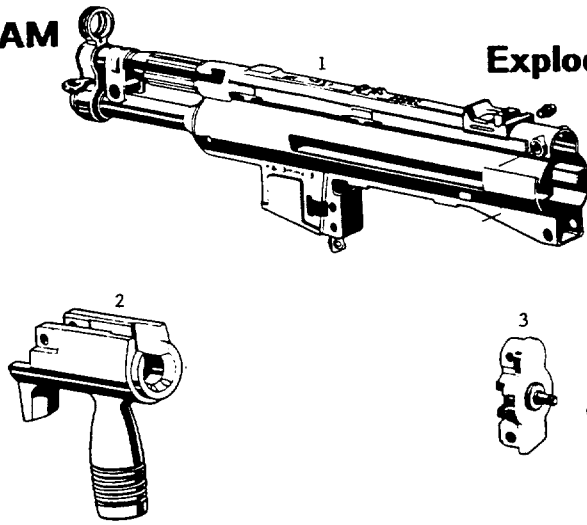

**Exploded Diagram # 4
MP5/10 and MP5/40**

Exploded Diagram # 5 - MP5SD

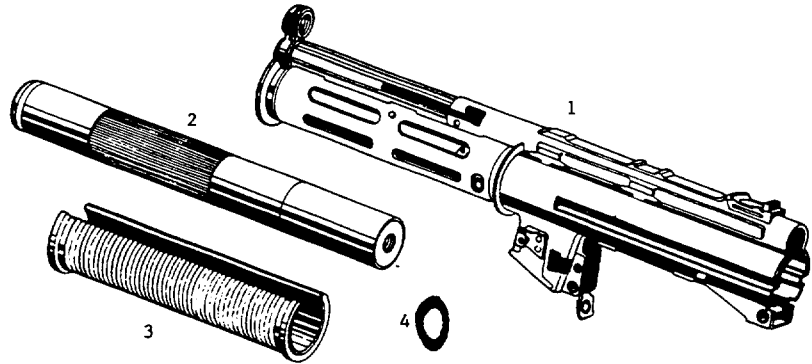
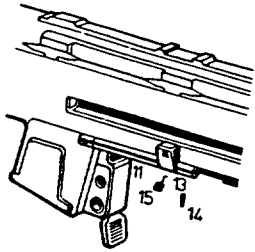

Exploded Diagram # 6

Exploded Diagram # 7

Ambidextrous Trigger Group

Burst Trigger Group

