



In a world of compromise, some don't.

Pistol P9S

Cal. 9 mm x 19

Description of the Weapon and  
Accessories

Instructions for Maintenance and  
Repair

<b>Contents</b>		<b>Page</b>
<b>1</b>	<b>Basic aspects of repair</b> .....	<b>5</b>
1.1	General .....	5
1.2	Repair .....	5
1.3	Special notes on the treatment of pistols .....	5
<b>2</b>	<b>Description of maintenance work</b> .....	<b>5</b>
2.1	General .....	5
2.2	Normal cleaning .....	6
2.2.1	Barrel .....	6
2.2.2	Slide .....	6
2.2.3	Bolt head .....	6
2.2.4	Receiver .....	6
2.2.5	Magazine .....	7
2.3	Major cleaning .....	7
2.3.1	Barrel .....	7
2.3.2	Slide .....	7
2.3.3	Bolt head .....	7
2.3.4	Receiver .....	7
2.3.5	Magazine .....	7
<b>3</b>	<b>Stripping and reassembling the pistol</b> .....	<b>8</b>
3.1	General .....	8
3.2	Stripping the pistol .....	8
3.3	Reassembling the pistol .....	9
3.4	Stripping and reassembling the magazine .....	10
3.5	Faults, causes, rectification .....	10
3.6	Checks .....	11
3.6.1	Slide .....	11
3.6.2	Receiver, complete .....	12
3.6.3	Magazine, complete .....	12
3.7	Functional testing of the pistol .....	12
3.8	Set of assembly tools for P9S pistol .....	13
<b>4</b>	<b>Repair</b> .....	<b>13</b>
4.1	Basic aspects of repair .....	13
4.2	General .....	13
4.3	Slide .....	14
4.3.1	Stripping the slide .....	14
4.3.2	Checking the individual components .....	16
4.3.3	Reassembling the slide .....	17
4.4	Receiver .....	18
4.4.1	Stripping the receiver .....	19
4.4.2	Checking the individual components .....	23
4.4.3	Reassembling the receiver .....	23
4.5	Assembling the pistol .....	31
4.6	Correction of sight alignment .....	31
4.7	Conduct of tests after repair .....	33
4.7.1	Gap between bolt head and bolt head carrier .....	33
4.7.2	Functional testing .....	33
4.7.3	Cocking and trigger action .....	33
4.7.4	Safety devices .....	33

5	<b>Spare parts catalogue</b> .....	35
5.1	Assemblies .....	35
5.2	Slide .....	36
5.3	Receiver .....	38
5.4	Grip .....	40
5.5	Magazine .....	42
5.6	Set of assembly tools for P9S Pistol .....	44

### **Preface**

1. This manual contains all the necessary instructions relating to the maintenance of the P9S pistol.
2. In most cases the pistol is illustrated with the barrel pointing to the left, as viewed by the reader. Variations are explained in relevant notes, or can be seen from the necessary illustrations.
3. Part numbers contained in the text relate to the exploded diagram for the assembly concerned.

**Subject to modification if warranted by technical progress**

## **1. Basic aspects of repair**

### **1.1 General**

Weapons in need of repair are normally detected during the course of routine examination, musters or parades and during technical and practical service use.

Unserviceable weapons are to be repaired by the authorized armament personnel without delay.

### **1.2 Repair**

When the action of a weapon is faulty or it provides poor shooting results, it must first be examined to determine the cause of the unserviceability.

The armament personnel carrying out repairs must be well instructed on the weapon concerned. They must be fully conversant with the following:

1. Construction of the weapon and the actions.
2. Purpose, stress and the limits of acceptable wear on the individual components.
3. The use of related gauges and testing equipment.
4. The correct procedure for systematic examination of the weapon.

Replacement parts are only to be incorporated if, after elimination of all other faults, the weapon cannot be brought up to the required condition.

### **1.3 Special notes on the treatment of pistols**

Pistols and magazines are to be lightly oiled, and the receiver tracks lightly greased. Ammunition may be oiled. Wherever possible, the magazine is to be cleaned weekly, emptied and refilled, at the same time examining it carefully for distortion such as buckling and bending. Buckled and corroded cartridges discovered in the course of cleaning are to be removed. After the magazine has been filled, the topmost round must be pressed down several times and then allowed to rise again so as to ensure that the remaining rounds are correctly positioned in the magazine.

Whilst carrying out this action, ensure that the rounds do not jam in the magazine. The pistol holster provides no protection for the weapon and magazine against damage resulting from abrupt changes in temperature.

## **2. Description of maintenance work**

### **2.1 General**

The user to whom the weapon is issued is fully responsible for cleaning, general care and the condition of the pistol. Damage and unserviceabilities are to be immediately reported to the responsible armament personnel. Cleaning is divided into the following categories to be carried out as shown:

#### **Normal cleaning**

- At regular intervals when the weapon is not in use.
- After each period of use for which major cleaning is not required.

#### **Major cleaning**

- Each time the pistol has been fired.
- If the pistol has become wet or particularly dirty.

Each time the pistol is cleaned and subsequently reassembled it must be examined for its condition and perfect functioning.

The following items are to be used for **cleaning** and **general maintenance** of the pistol:

- Cleaning kit, calibre 7.62 to 9 mm
- Clean pull-throughs and cleaning cloths
- Chlorine-free and acid-free gun oil and gun grease
- Piece of wood, if needed.

- 1 Storage case
- 2 Oil tube
- 3 Cleaning brush
- 4 Oil brush
- 5 Cleaning brush
- 6 Cleaning chain
- 7 Pull-throughs

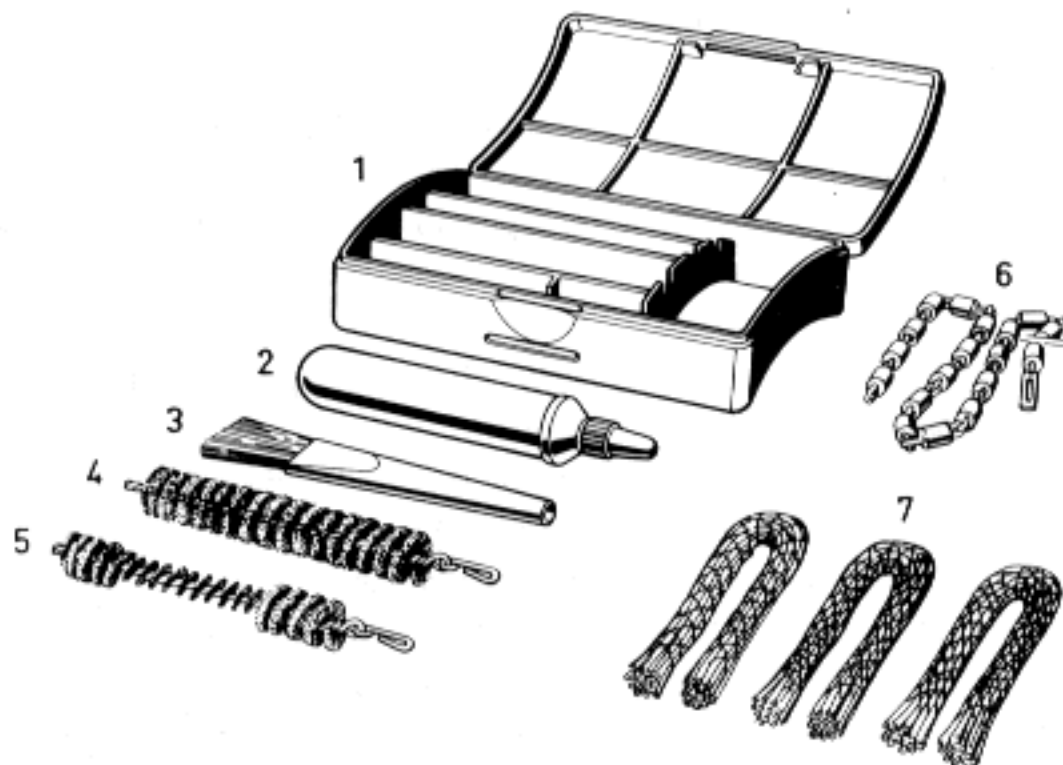

Fig. 1 Cleaning kit

It is **forbidden** to use any of the following items to clean the pistol:

- Metal implements
- Nylon, perlon or other synthetic fibres
- Chemicals e. g., petroleum ether etc.
- Hot or cold water

## 2.2 Normal cleaning

Normal cleaning must be carried out each time the pistol is used. In this case the pistol must be stripped only to the extent necessitated by the amount of dirt accumulated (see Section 3.2).

The dirty components must be cleaned and oiled using a clean cloth.

### 2.2.1 Barrel

- Clean the chamber and interior of the barrel with a pullthrough, and subsequently lightly oil.
- Clean and lightly oil the slide.

### 2.2.2 Slide

- Use the cleaning brush or cloth to clean it out, lightly oil.

### 2.2.3 Bolt head

- Clean the dismantled bolt head together with the internal tracks, and lightly oil.
- The locking rollers must be caused to move slightly when the bolt head is shaken.

#### Note:

Before inserting the bolt head into the slide, allow a few drops of gun oil to drip into the recess square.

### 2.2.4 Receiver

- Use the cleaning brush or cloths to clean the receiver, removing any dirt from the entrance to the chamber.
- Lightly oil.

### 2.2.5 Magazine

- Remove accumulations of dirt from the magazine lips and from the follower.
- Lightly oil.

Varying amounts of contamination can accumulate inside the pistol, depending on the number of shots fired and the nature of the propellant charge. It is thus recommended to carry out major cleaning of the pistol after a certain period of use although no interval can be specified.

## 2.3 Major cleaning

- Strip the pistol first removing the magazine, detach the slide, and take out the barrel and bolt head (see Section 3.2, or brief description „Stripping and cleaning“ of P9S).

### 2.3.1 Barrel

- Draw an oil-soaked cleaning brush through the barrel from chamber to muzzle with the cleaning chain (if possible, this should be done for the first time immediately after firing, and while the barrel is still warm to the touch).
- Allow the gun oil to take effect for several hours.
- Afterwards again draw the oil-soaked brush through the barrel.
- Subsequently draw a dry pull-through down the barrel; it must remain clean.
- Lightly oil the barrel.
- Clean and lightly oil the locking system.

#### Note:

Each time that the weapon is fired, the process of cleaning and oiling the barrel must be repeated on the three consecutive days following use.

### 2.3.2 Slide

- Wash in paraffin (kerosene) pushing the firing pin forwards and cleaning it.
- Wipe the slide and lightly oil it.

### 2.3.3 Bolt head

- Place in paraffin and use the brush to remove powder deposits, at the same time moving the extractor.
- Use wooden chips to thoroughly clean the internal tracks in the bolt head as well as the locking roller bearings.
- Wipe the bolt head and lightly oil it.

#### Note:

Before inserting the bolt head into the slide, allow a few drops of gun oil to drip into the recess square.

### 2.3.4 Receiver

- Undo the moulded grip and wash out the receiver with paraffin, wipe dry and lightly oil.
- Lightly smear both guide grooves for the slide with gun grease.

### 2.3.5 Magazine

- Where contamination is heavy, strip the magazine (see Section 3.4) and wash out with paraffin, wipe dry and lightly oil the individual components.

### 3 Stripping and reassembling the pistol

#### 3.1 General

The pistol is stripped for cleaning. If several pistols are being cleaned simultaneously in the same place, then care must be taken to ensure that the parts are not inadvertently interchanged.

**Before stripping the pistol, the safety catch must be applied and the weapon examined to prove that the magazine is empty and that there is no round left in the chamber.**

No tools are required for stripping or reassembling the pistol.

The use of force is absolutely **prohibited**.

#### 3.2 Stripping the pistol

- Remove the magazine (Fig. 2).



- Take off the slide by pressing the barrel clamp in the trigger guard forwards (Fig. 3).
- Push the slide forwards to the stop and lift it off upwards.



Fig. 3

- Remove the barrel by pushing it forwards against the pressure of the spring until it can be lifted rearwards and upwards out of the slide (Fig. 4).

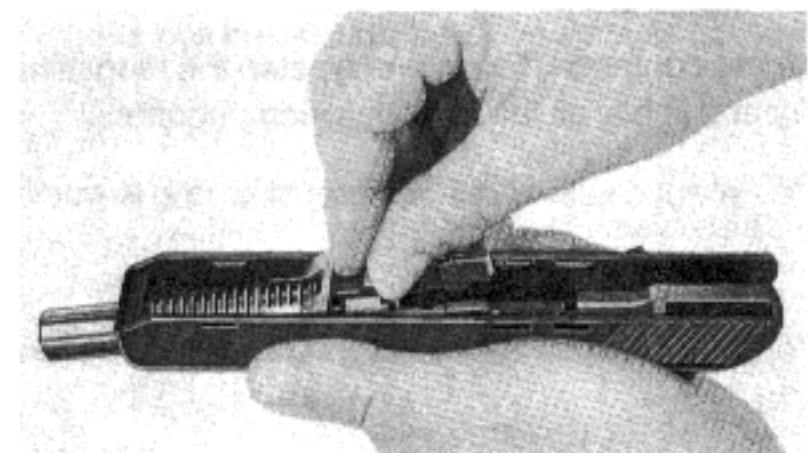

Fig. 4

- To extract the bolt head, use one shank end of the barrel extension to press down between the bolt head and the slide onto the locking catch, until the bolt head springs forward (Fig. 5).
- Remove the bolt head from the slide.

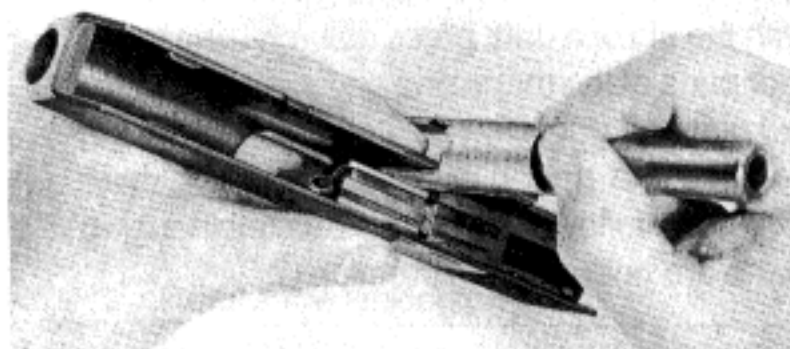

Fig. 5

It is not necessary to strip the pistol any further for major cleaning.

### 3.3 Reassembling the pistol

When inserting the bolt head, position it with its rectangular opening over the locking piece (extractor to ejection port) and, as when extracting the bolt head, press down the locking catch with one shank of the barrel extension, at the same time sliding the bolt head further back until it engages.

Push the barrel complete with recoil spring (larger diameter end of the spring to the front) at an angle through the barrel hole in the slide against the pressure of the spring (Fig. 6). Then position it fully into the slide, allowing it to move back until the locking rollers engage.

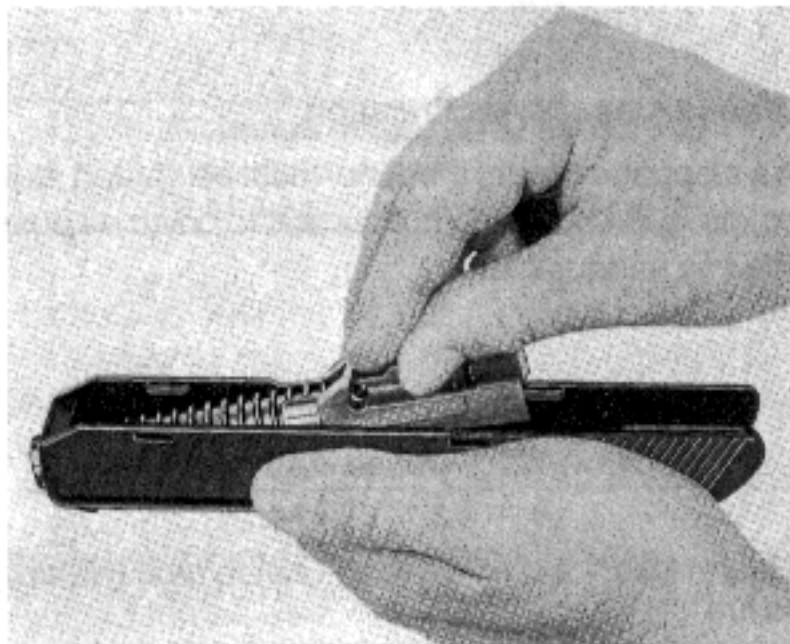

Fig. 6

Mount the slide onto the receiver so that the front guide lugs can engage in the corresponding notches in the receiver body. Press the slide down onto the top of the receiver, draw it to the rear and then allow it to travel rapidly forward (Fig. 7). Uncock the pistol, and insert the magazine.



Fig. 7



### 3.4 Stripping and reassembling the magazine

- With the aid of a drift, press down the lug in the floor plate of the magazine and slide the released plate off (Fig. 8).
- Remove the spring locating piece, follower spring and follower from the magazine housing (parts are under spring pressure).

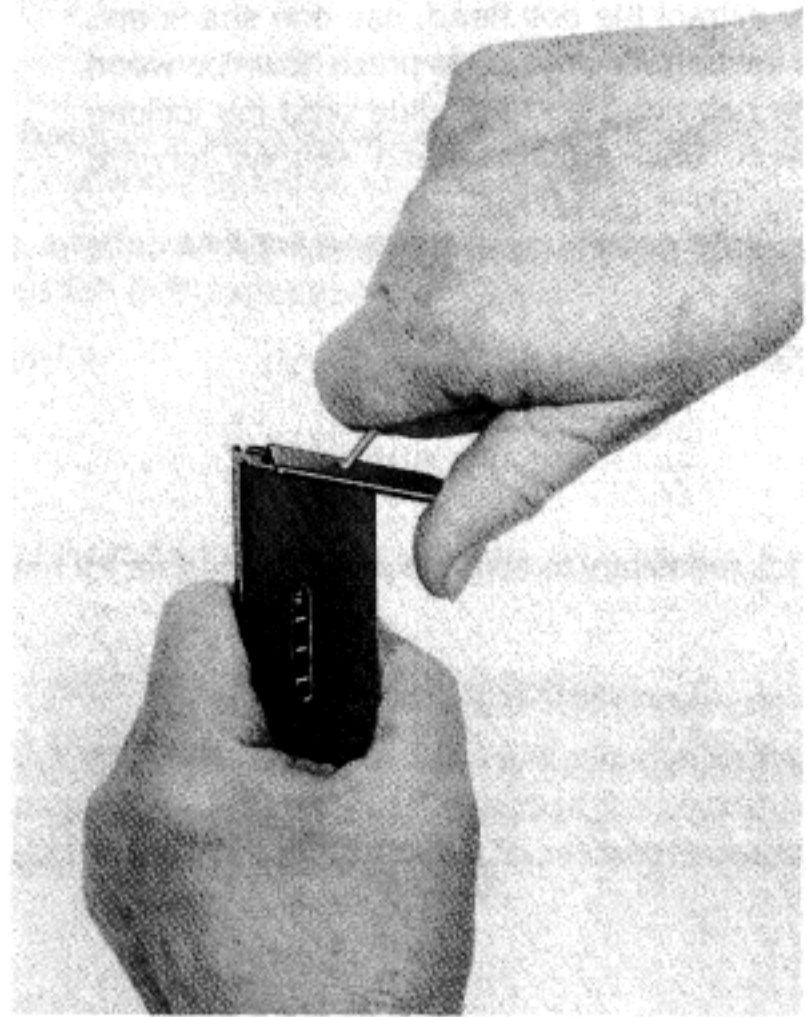

Fig. 8

The magazine is reassembled in the reverse order.

### 3.5 Faults, causes, rectification

When a stoppage occurs the pistol must be treated as if it is still loaded until conclusively proven otherwise. The points listed below do not purport to cover all possible faults. Similarly, the listed causes must not be regarded as exhaustive.

Fault	Cause	Rectification
1 (1) Round fails to fire	2 a) Ammunition fault (misfire)	3 Remain in the aiming position, squeeze the trigger again and, if round again fails to fire, apply safety catch, cock, examine cartridge, uncock and continue firing
Next round also misfires	b) Firing pin broken c) Weak firing pin spring d) Firing pin jams or is distorted	Unload and return to the armoury for repair
(2) Pistol fails to open after a shot is fired	Cartridge jammed in chamber because round distorted or chamber dirty	Unload, drawing back the slide to eject empty cartridge; clean weapon if dirty
(3) Cartridge remains jammed between barrel and slide after firing	a) Slide rearward travel limited, restricted movement, has not reached ejector b) Extractor, extractor spring or ejector damaged c) Weak firing charge providing insufficient recoil action	Unload, draw back slide and remove cartridge. Check for smooth running, clean if dirty Return to armoury for repair Use other ammunition
(4) Cartridges are not ejected	Ejector distorted or broken	Return to armoury for repair

(5) Round is not fully chambered, fails to lock	a) Chamber dirty b) Round distorted c) Guide rails and grooves dirty d) Guide rails and grooves damaged e) Recoil spring for barrel weak or damaged f) Locking rollers jammed g) Locking catch damaged	Unload! Clean Discard round Clean, lubricate Return to armoury for repair Renew recoil spring  Fit a new bolt head Renew the locking catch
(6) Rounds are not fed	a) Magazine dirty b) Follower spring weak  c) Magazine distorted d) Magazine lips bent	Unload! Clean Replace with serviceable magazine, return other for repair
(7) Slide fails to remain open after firing last shot	a) Follower spring weak b) Catch damaged	Unload! Exchange magazine Return to armoury for repair
(8) Slide fails to travel forward	Recoil spring weak or broken	Return to armoury for repair
(9) Catch fails to disengage	Catch damaged Cocking lever damaged	Return to armoury for repair
(10) Weapon cannot be cocked with cocking lever	Elbow lever broken	Unload! Return to armoury for repair
(11) Pistol cannot be fired with hammer cocked	Pull-bar spring broken or disengaged	Unload! Return to armoury for repair
(12) Pistol gives consistently poor shooting results	Front sight displaced	Return to armoury for adjustment
(13) Magazine jammed in magazine well	a) Magazine distorted b) Magazine catch faulty	Exchange magazine and return to armoury for repair Return pistol to armoury for repair

### 3.6 Checks

Before returning a pistol to the armoury for repair, the following points must be checked:

- (1) Cleanliness
- (2) Examine front, rear sights and grip for firm attachment
- (3) Examine the subassemblies for deposits of dirt, for damage and for function
- (4) Examine the complete pistol for accumulations of dirt, for damage and for dents
- (5) Check functioning of the fully assembled pistol
- (6) Check functioning and condition of the magazine

#### 3.6.1 Slide (Exploded diagram 1)

##### Bolt head

- The extractor must lift freely and return to its initial position.
- The locking rollers must move freely when the bolt is shaken.

##### Bolt head carrier

- The locking catch (16) must move freely when pressed down.
- It must be possible to push the pressure pin (13) down to the stop and for it to return under spring pressure.
- The catch bolt (9) must be adjusted by moving the set screw (11) so as to allow unrestricted engagement and changeover of the safety catch.

### **Barrel with barrel extension**

- The play between the barrel with the barrel extension (4) and the barrel clamp must be maintained as low as possible. A new barrel clamp must be fitted if the play becomes excessive.

### **Slide, complete**

- The safety lever must engage positively in both its end positions. Adjust on the set screw (11), if necessary.
- With the safety catch released, it must be possible to push the firing pin (18) forward and for it to return unhindered under spring pressure. In the safed condition the firing pin must not protrude beyond the safety catch (3) to the rear, and be restricted to approx. 0.2 mm play at the front end.

### **3.6.2 Receiver, complete (Exploded diagram 2)**

- In the uncocked condition, the trigger (4) must travel so far to the rear that the pull bar (18) engages behind the intermediate lever (30) carrying it with it when it travels forwards.
- The double action trigger must move back smoothly. It must be possible to draw back the hammer (20) against spring pressure to the upper edge of the disconnecter (22); the hammer must not catch in the notch during the counter recoil action.  
(If the hammer responds prematurely, then the intermediate lever (30) and/or the pull-bar must be exchanged).
- Movement of the trigger must be unrestricted and it must not catch at the limit of its travel.  
The trigger force for normal action (single) must not be less than 1.4 kg (if necessary, exchange the catch lever (17) and the hammer (20)).  
With a full magazine loaded into the pistol, the trigger bar (19) must drop in perfectly behind the catch lever and carry it with it (receiver possibly too narrow, i. e., sides pressed together).
- When uncocking the pistol correctly, the hammer must be retained by the notch.
- The catch (2) must be positively lifted when an empty magazine is inserted.
- The magazine catch (25) must retain the magazine securely. When engaged, the magazine must have a minimum of 0.2 mm play along its lengthwise axis. The magazine must spring slightly out when the magazine catch is operated. (This action can be inhibited if the sides of the magazine well have been pressed together, or if the magazine itself is distorted).
- It must be possible to press down the cocking lever (27) (both with and without a filled magazine) so far that the hammer engages positively. (Grip must be in position).
- Use of the cocking lever must allow the catch to be pushed upwards through its full travel so that on release it falls back into its original position.
- The axle for hammer must be correctly located in the slot provided for the purpose.
- In the assembled condition it must be possible to push the buffer housing (13) to the rear stop, and for it to return to the front stop under its own power.

### **3.6.3 Magazine, complete (Exploded diagram 4)**

- The magazine must accommodate a total of 9 rounds.
- The movement of the follower (3) must be unrestricted.

### **3.7 Functional testing of the pistol**

- The slide must move without any restriction on the receiver.
- During the loading action the slide must feed and eject the rounds perfectly.
- With an empty magazine fitted, the slide must be retained perfectly by the latch when the slide is drawn back to the buffer stop. The cocking action must release the slide properly.
- After removing the magazine, the catch must disengage when the slide is drawn back, and must not hold the slide during the subsequent loading actions.
- The hammer must engage when the slide is drawn back. When it is engaged (hammer cocked), the indicator pin must be both seen and felt to project.

### 3.8 Set of assembly tools for P9S pistol

This set of assembly tools is used for maintenance and repair of the P9S pistol (see diagram 5). Each individual tool should be used as itemized below.

Item	Tool designation	Application
1	Screwdriver 2 mm x 180	for set screw (10) in the slide, Fig. 13
2	Screwdriver 5.5 mm x 120	for lens head countersunk screws (3 and 4) of the grip (exploded diagram 3); for lens head countersunk screw (11) in the receiver, Fig. 27
3	Screwdriver 4 mm x 100	for countersunk screw (29) in the receiver, Fig. 19 and 47
4	Assembly mandrel for safety catch	for pressing-in of firing pin (17) and safety catch (3) into the slide, Fig. 10
5	Assembly mandrel Ø 16 x 200	for bolt head carrier (7) in the slide, Fig. 15
6	Pincers	for catch spring (3), Fig. 30, insert piece (9), Fig. 32 and indicator pin (21) in the receiver, Fig. 43
7	Assembly mandrel Ø 5 x 100	for bolt head carrier (7), Fig. 11
8	Backing-out punch Ø 2.8	for cylindrical pin (16) in the bolt head carrier, Fig. 12; for cylindrical pin (6) in the receiver, Fig. 18, 22, 24 and 25; for hammer axle (23), Fig. 21
9	Backing-out punch Ø 1.8	for clamping sleeve (13), Fig. 14
10	Assembly pin Ø 3.85	for hammer axle (20), Fig. 45; for indicator pin (21) and disconnector (22) in the receiver
11	Assembly pin Ø 2.85	for trigger (4), trigger spring (5), Fig. 34; barrel clamp (7), Fig. 35; safety latch (16), catch lever (17) and magazine catch (25) in the receiver
12	Supporting surface	for resting on it slide and receiver whilst carrying out the various disassembly and reassembly operations
13	Hammer	according to requirement
14	Cleaning kit, cal. 7.62 - 9 mm	for cleaning the pistol according to these instructions

## 4 Repair

### 4.1 Basic aspects of repair (see Section 1)

#### 4.2 General

- (1) Pistols which are damaged or give poor shooting results are to be examined by the armourer responsible for maintaining the pistol who is to:
  - Ascertain the cause and extent of the unserviceability.
  - Check spare parts if required.
  - Determine whether the specified special tools or test equipment needed are available.
- (2) Damaged components must be replaced with new ones.
- (3) Each time that the pistol is repaired it must be subjected to a full functional check.

### 4.3 Slide (Fig. 9)

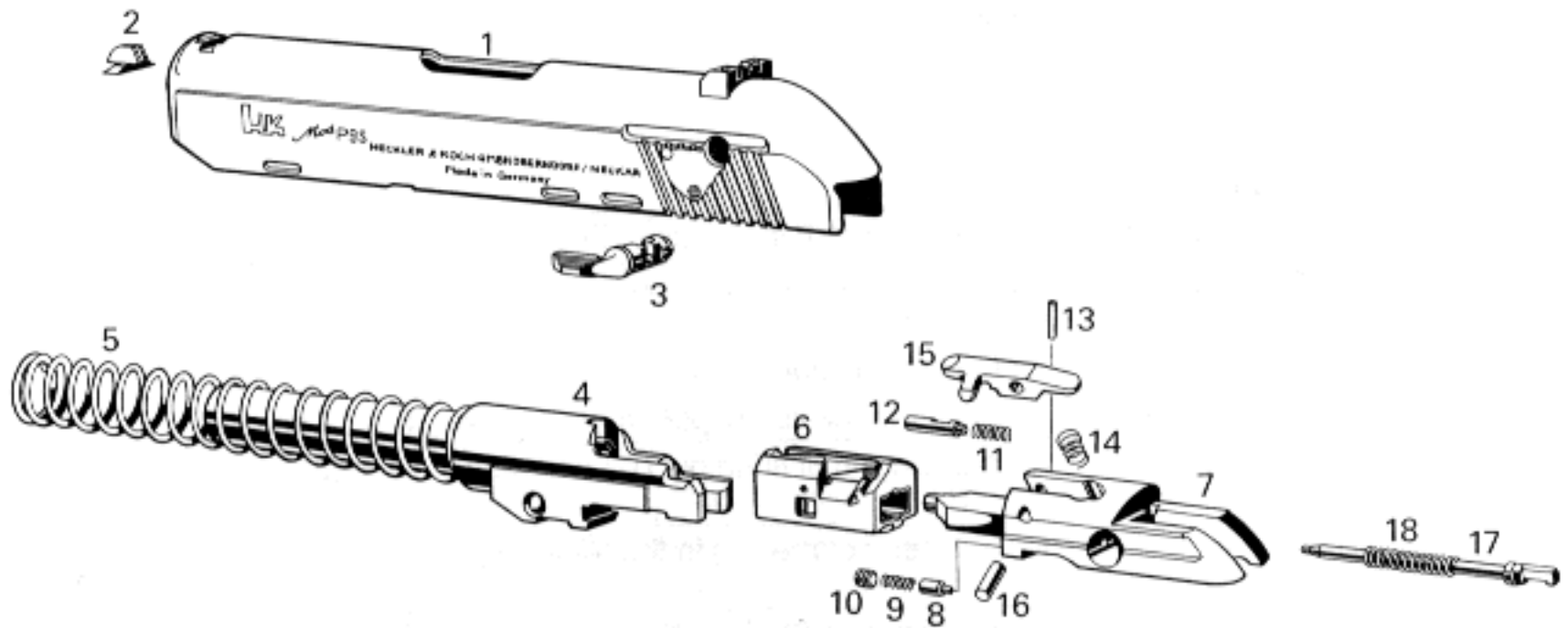

Fig. 9

- |                                 |   |
|---------------------------------|---|
| 1 Slide                         | 10 Set screw                            |
| 2 Front sight                   | 11 Compression spring for pressure pin  |
| 3 Safety catch                  | 12 Pressure pin                         |
| 4 Barrel                        | 13 Pin                                  |
| 5 Recoil spring                 | 14 Compression spring for locking catch |
| 6 Bolt head                     | 15 Locking catch                        |
| 7 Bolt head carrier             | 16 Cylindrical pin                      |
| 8 Catch bolt                    | 17 Firing pin                           |
| 9 Catch bolt compression spring | 18 Compression spring for firing pin    |

#### 4.3.1 Stripping the slide

- Strip the pistol as described in Section 3.2.
- Remove the safety catch (3) using an assembly mandrel to push the firing pin (18) forwards, at the same time pushing out the safety catch with a sideways motion of the mandrel and removing it (Fig. 10).

Fig. 10

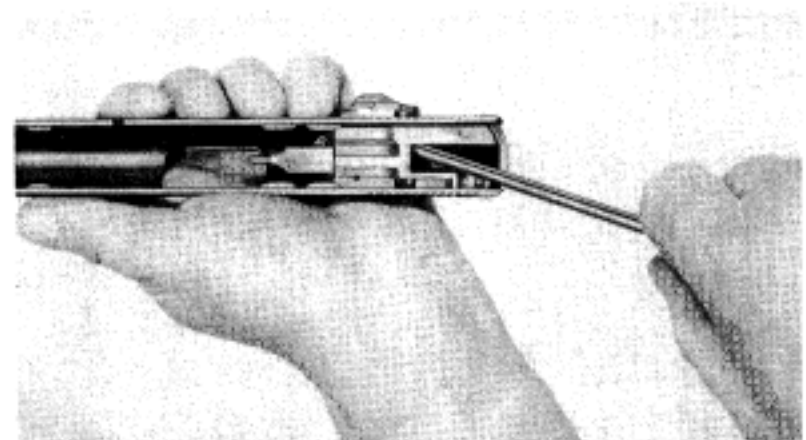

- By lightly tapping a mandrel dia. 5 mm, drive the bolt head carrier approx. 10 mm forwards until the firing pin and the compression spring (18) can be removed (Fig. 11).

Fig. 11

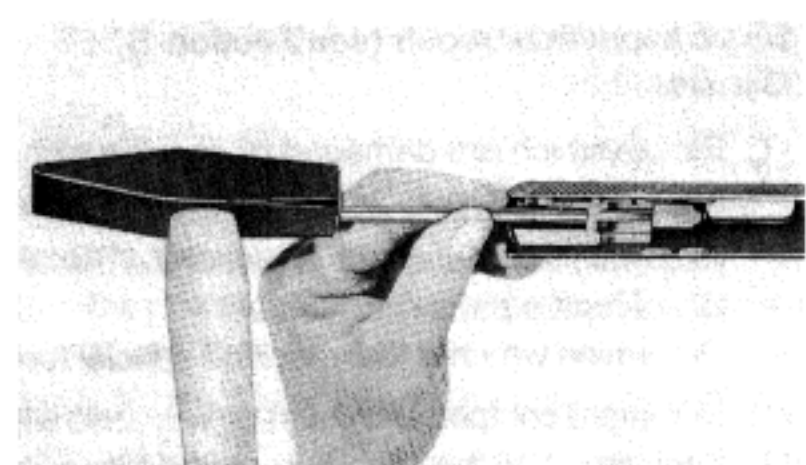

- Drive the bolt head carrier further towards the front and remove it.
- Press out the cylindrical pin (16) and remove the locking catch (15) together with its compression spring (14) (Fig. 12).

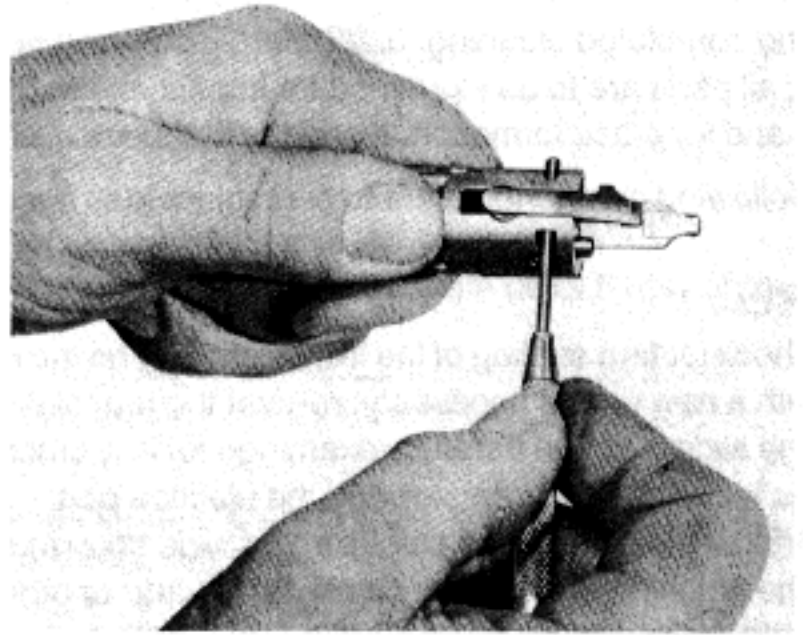

Fig. 12

- Undo the set screw (10) (Fig. 13) and remove the compression spring (9) together with the catch bolt (8).

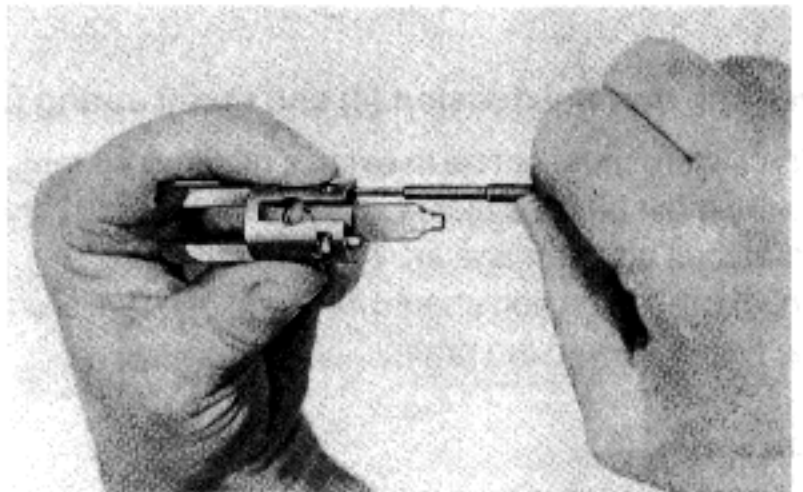

Fig. 13

- Press out the clamping sleeve (13) (Fig. 14).

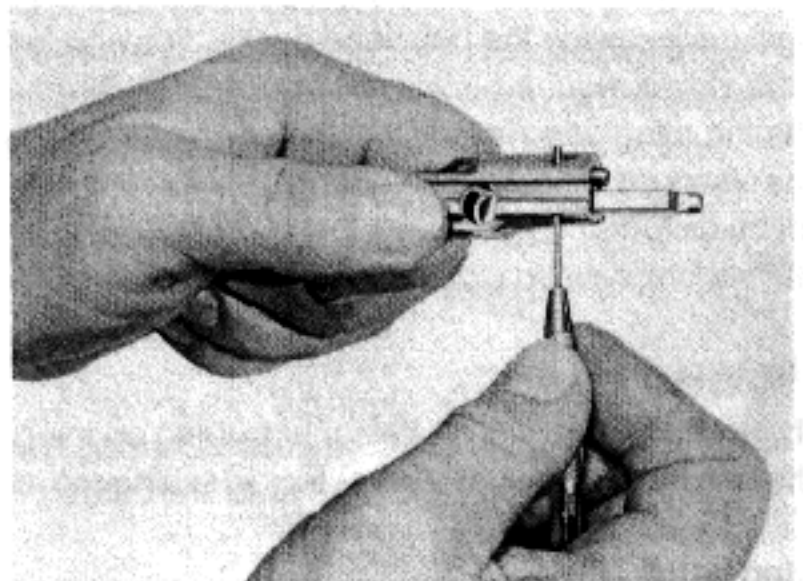

Fig. 14

- Remove the pressure pin (12) with the compression spring (11).

### 4.3.2 Checking the individual components

Having completed cleaning, and before incorporating new individual components and reassembling the slide, all parts are to be examined for impact marks (distortion), the formation of burrs, heavily worn positions and for crack formation. If serious faults are detected, then the parts concerned must be replaced.

The following components are to be subjected to special examination:

#### **Slide (1)**

- Check for firm seating of the front sight (2) and the rear sight. A loose front sight blade must be replaced with a new one. If necessary, re-rivet the rear sight on the hollow rivets (visible from within).
- The slide must be carefully examined for any cracks – above all, on the side surfaces in the region of the locking system and around the ejection port.
- Brazed insert and stop pieces in the slide body must be examined for tight fit.
- The notch must not show any signs of wear or other damage.
- Guide rail surfaces must remain straight. The dimension between the rails must not exceed 17.6 mm (paying due regard to the sliding action on the receiver).

#### **Safety catch (3)**

The retainer edge for the firing pin and the edge of the notch depression (safety action too smooth) must not display any signs of excessive wear.

#### **Barrel with barrel extension (4) and recoil spring (5)**

- The calibre must not be in excess of dia. 8.76 mm.
- There must be no major damage present inside the barrel, and particularly not in the chamber. Minor scratches and damage are of no significance.
- The barrel extension should be examined for cracks, especially in the region of the locking recess and the transition into the pronged section.

#### **Recoil spring (5)**

The minimum length of the uncompressed recoil spring must be at least 130 mm.

#### **Bolt head (6)**

- Examine the bolt head for cracks and other damage.
- Using a wedge, it must not be possible to force the sliding rollers any further than 16.6 mm apart. The rollers must not be caused to jam as a result of this action; they must release under their own centrifugal force (swing the bolt head backwards and forwards).
- If the above requirement is not met, the bolt head must be renewed.
- The thrusting edge for the locking catch must not be distorted.
- The claws on the extractor must not exhibit any signs of damage or wear; the rear leg of the spring must not be distorted.
- The uncompressed extractor spring must have a minimum length of 6.8 mm.

#### **Bolt head carrier (7)**

- There must be no signs of wear or burring on the guide surfaces of the bolt head carrier.
- The bolt head must have unrestricted sliding movement on the bolt head carrier.

#### **Locking catch (15)**

- The locking catch must be examined for cracks; the thrusting edge on the locking catch must not be worn or distorted.

#### **Compression spring (14)**

- The uncompressed compression spring must have a length of at least 7.00 mm.

### Firing pin (17)

- The hooked rear end of the firing pin (17) must be free from wear or damage.
- The tip of the firing pin must be free from any signs of erosion.

### Compression spring for firing pin (18)

- The firing pin compression spring must be undistorted and have a minimum length of 18.5 mm when uncompressed.

### Note:

Damage to the firing pin is frequently caused by incorrect dry training and frequent dry snapping with the pistol put at safe.

### Caution:

Dry firing practice is only to be carried out with the safety catch released!

### 4.3.3 Reassembling the slide

The bolt head carrier is reassembled in the reverse order of stripping.

- Insert the bolt head carrier into the slide, drive it slightly to the rear with a copper mandrel dia. 15 mm, and introduce the firing pin complete with compression spring (Fig. 15).

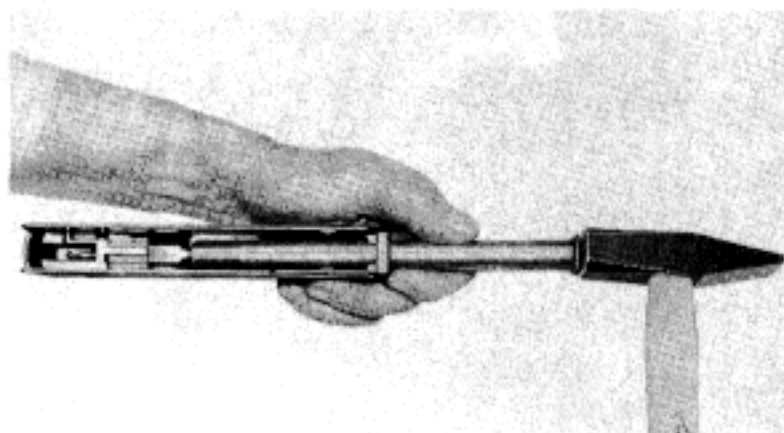

Fig. 15

- Using the copper mandrel, drive the bolt head carrier to the rear until the drill holes in the bolt head carrier and those in the slide are aligned.
- Insert the safety catch, push the firing pin fully forward ensuring that the nose on the end of the firing pin is visible (Fig. 16).

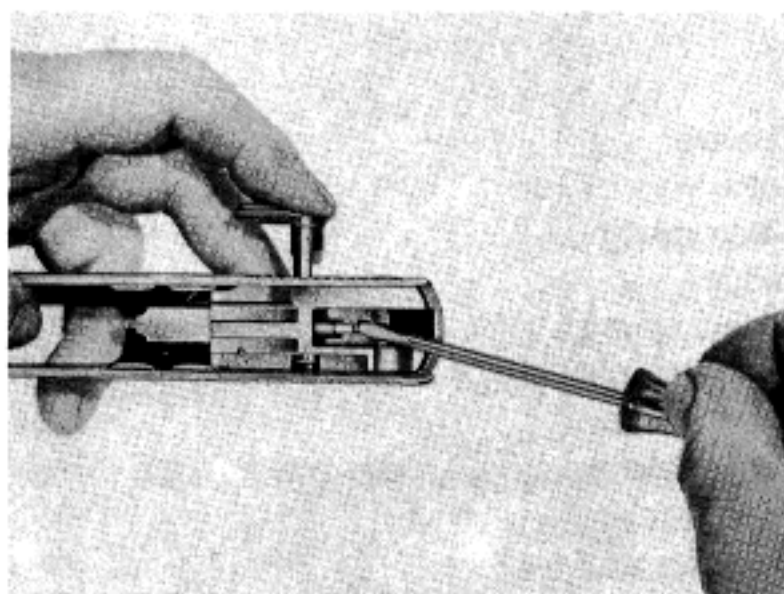

Fig. 16

- Press the safety catch fully home, and check its action by rotating it into the „Safe” and „Fire” positions.



#### 4.4 Receiver (Fig. 17)

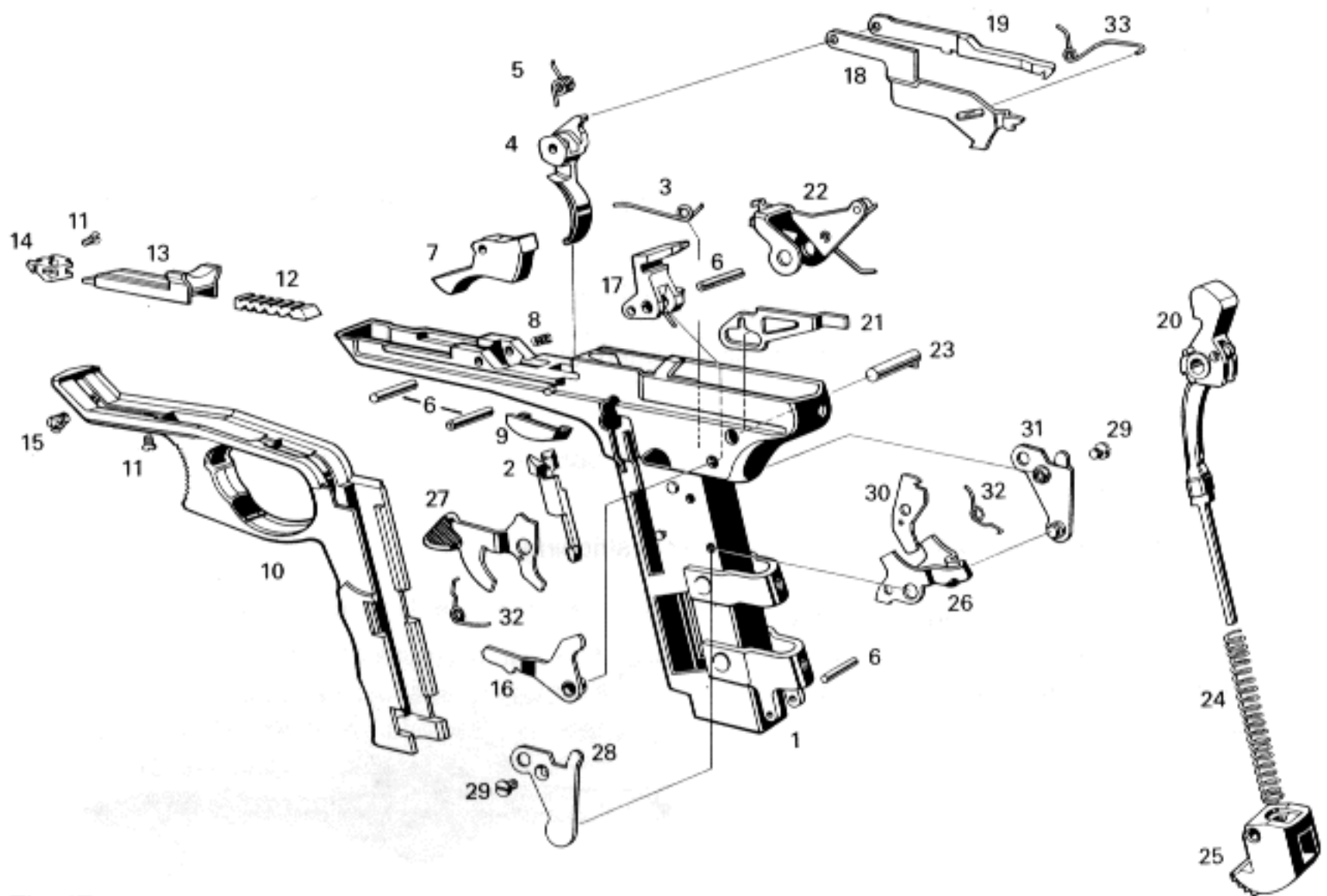

Fig. 17

- |                                       |  |
|---------------------------------------|--|
| 1 Receiver                            | 18 Pull bar  |
| 2 Catch                               | 19 Trigger bar   |
| 3 Catch spring                        | 20 Hammer, compl.  |
| 4 Trigger                             | 21 Indicator pin   |
| 5 Trigger spring                      | 22 Disconnecter, assembled   |
| 6 Cylindrical pin                     | 23 Hammer axle   |
| 7 Barrel clamp                        | 24 Compression spring for shank  |
| 8 Compression spring for barrel clamp | 25 Magazine catch  |
| 9 Insert piece                        | 26 Angle lever   |
| 10 Trigger guard                      | 27 Cocking lever   |
| 11 Lens head countersunk screw        | 28 Bearing plate, left   |
| 12 Elastic buffer                     | 29 Countersunk screw for bearing plate                                   |
| 13 Buffer housing                     | 30 Intermediate lever  |
| 14 Support                            | 31 Bearing plate, right  |
| 15 Threaded bush                      | 32 Elbow spring for cocking lever, angle lever<br>and intermediate lever |
| 16 Safety latch                       | 33 Spring for pull bar   |
| 17 Catch lever, assembled             |  |

#### 4.4.1 Stripping the receiver

- Strip the pistol as described in Section 3.2.
- Undo the lenshead countersunk screws on the moulded grip and then remove the grip from the receiver.

#### Note:

The moulded grip can only be removed when the pistol is not cocked.

- Remove the magazine catch (25) by pressing out the cylindrical pin (6) (Fig. 18) and removing the compression spring (24).

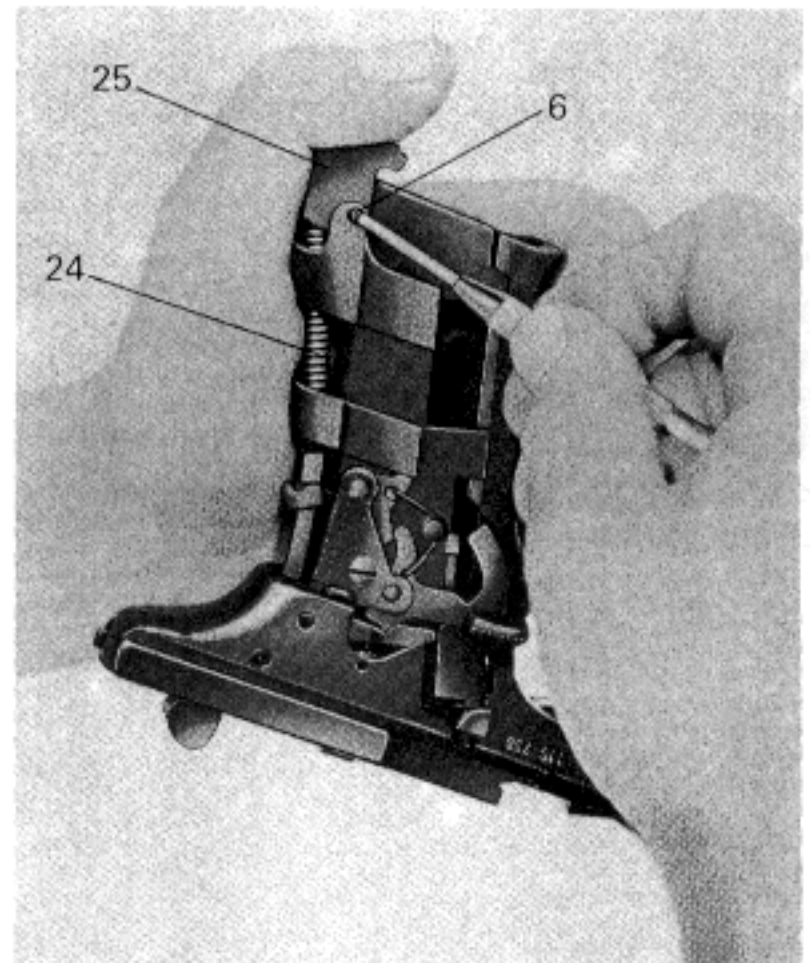

Fig. 18

- Undo the countersunk screws (29) (Fig. 19) and then take off the left-hand bearing plate (28) followed by the right-hand bearing plate (31).



Fig. 19

- Lift off the elbow spring (32), and remove angle lever (26), cocking lever (27) and the intermediate lever (30) (Fig. 20).

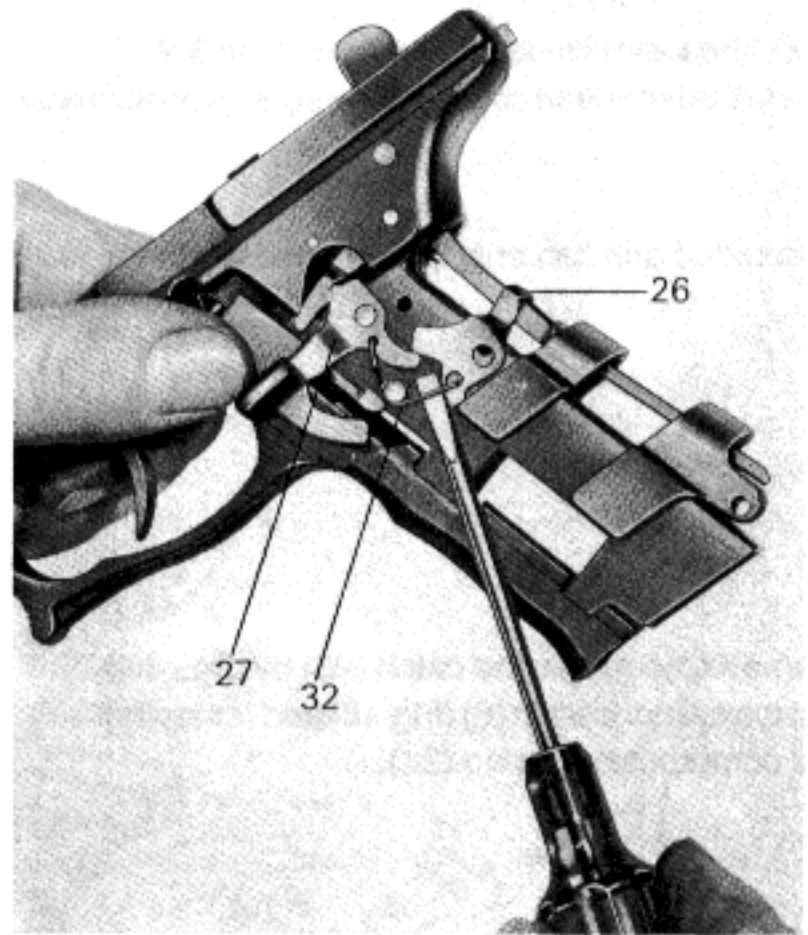

Fig. 20

- Draw the trigger back approx. 10 mm.
- Press out the hammer axle (23) (Fig. 21) and then remove the hammer (20), disconnecter (22) and the indicator pin (21).

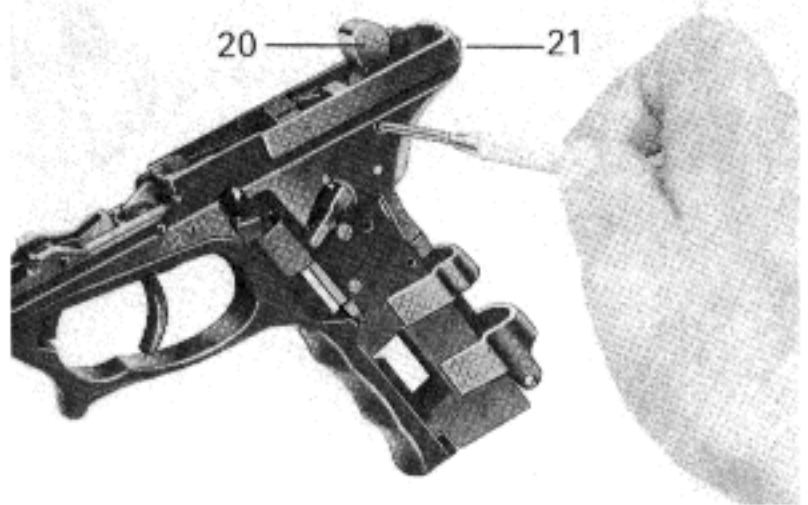

Fig. 21

- Drive out cylindrical pin (6) (Fig. 22), remove the safety latch (16) and the catch lever (17).

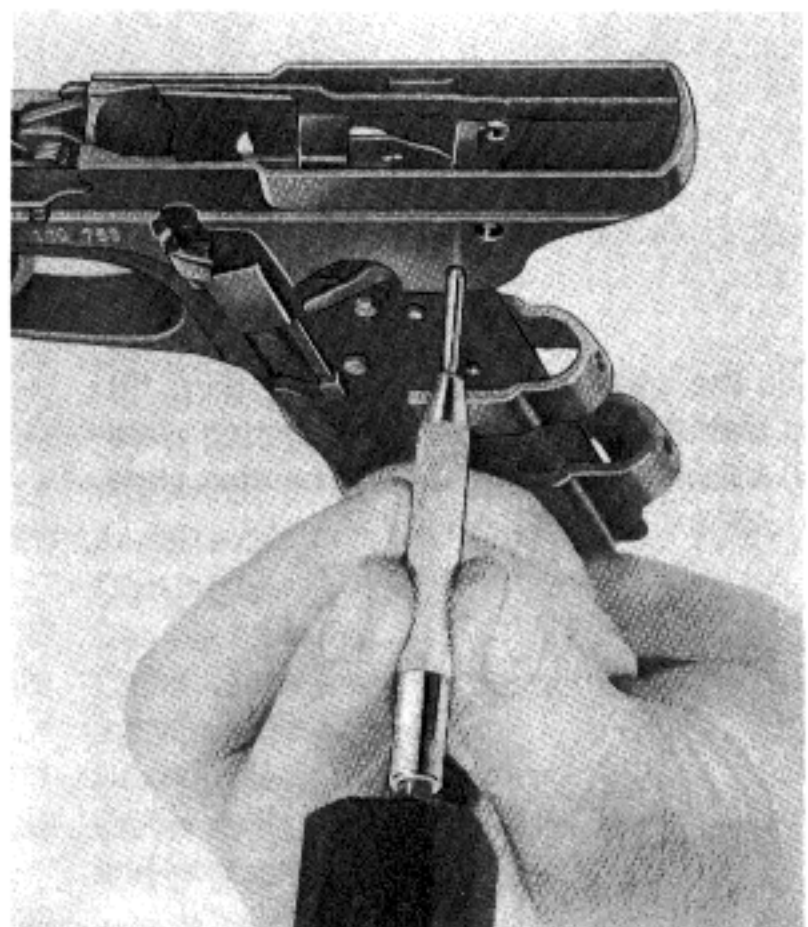

Fig. 22

- Disengage the pull bar spring (33) from the pull bar (18) (Fig. 23).



Fig. 23

- Release the catch spring (3) from the pin and disengage from the catch (2) (Fig. 24), then remove the catch together with the spring. (Do not distort the spring).



Fig. 24

- Drive out cylindrical pin (6) for the trigger (Fig. 25), remove the trigger spring (5), disconnect the pull bar (18) and the trigger bar (19) from the trigger (4) and remove.

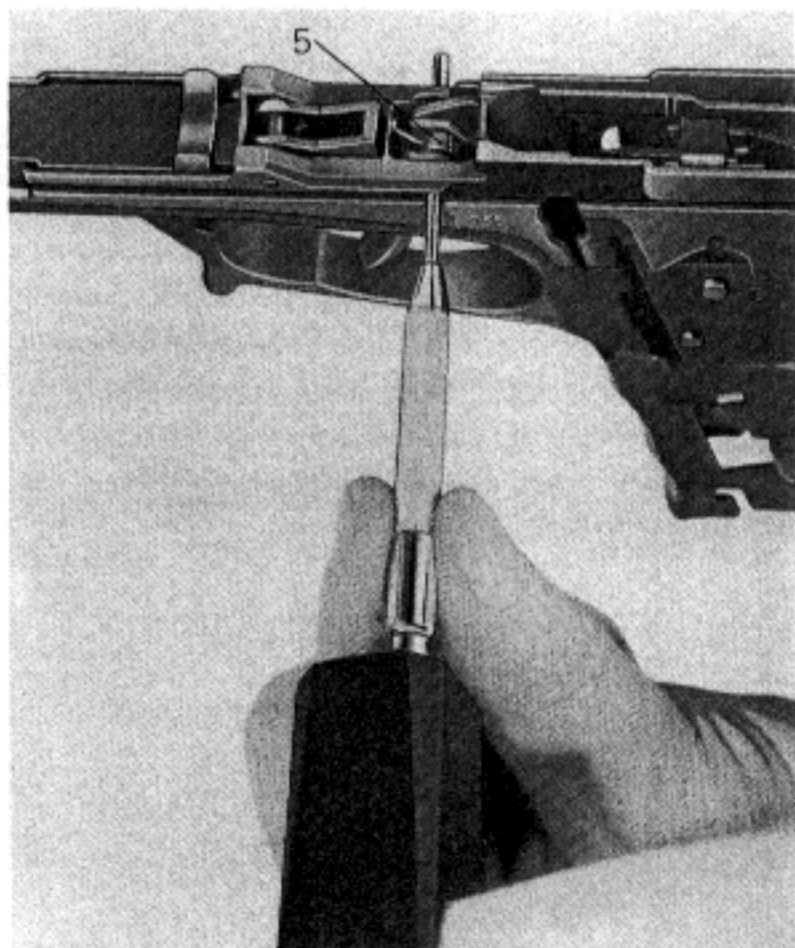

Fig. 25

- Drive out cylindrical pin (6) for the barrel clamp (Fig. 26), remove the barrel clamp (7) and compression spring (8).

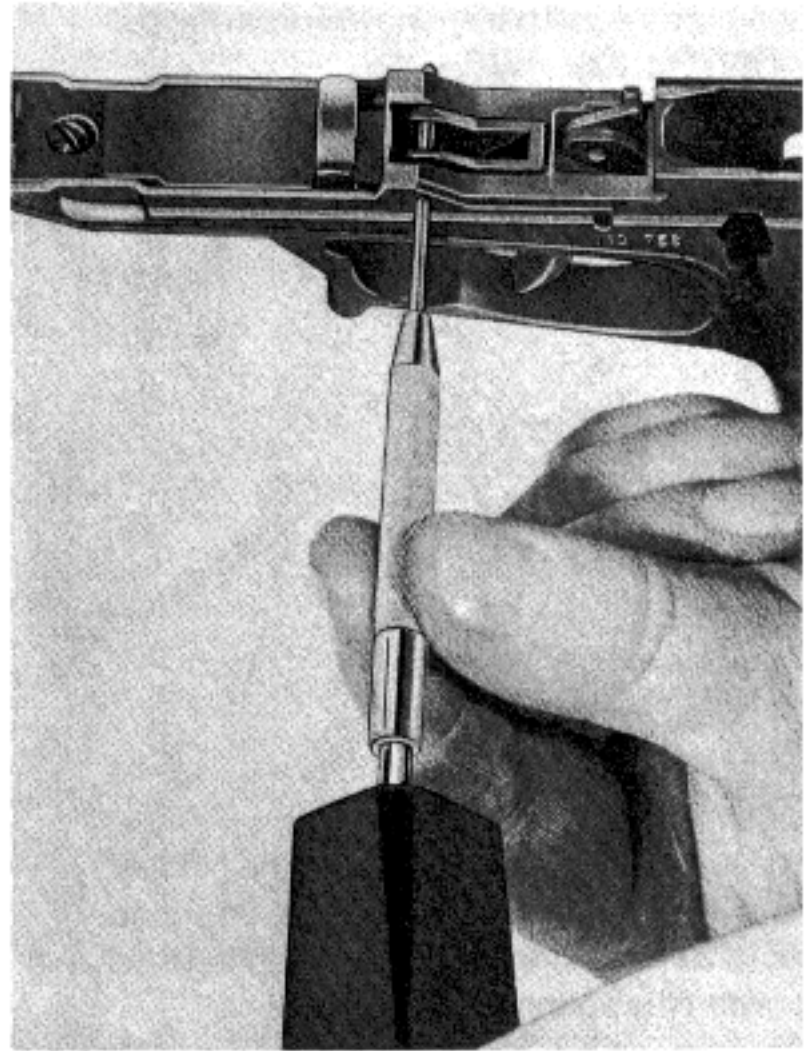

Fig. 26

- Unscrew the threaded insert (15) and the lens head countersunk screw (11) applying counter torque to the insert (15), and remove (Fig. 27).

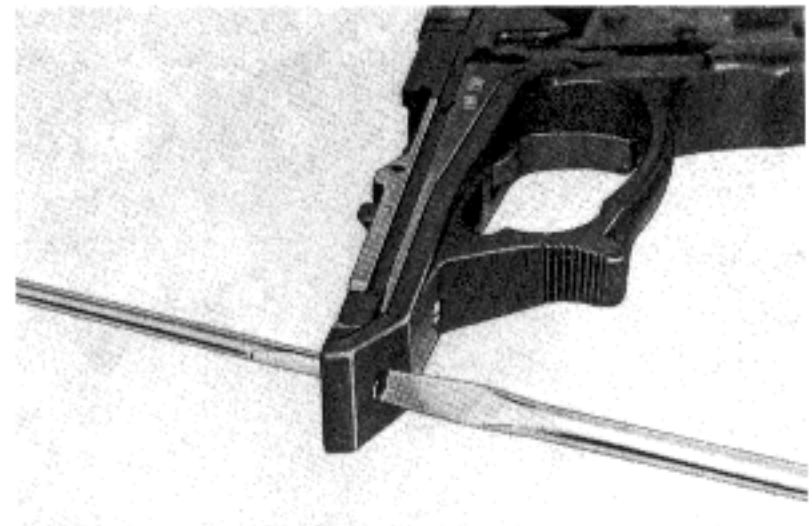

Fig. 27

- Remove support (14), buffer housing (13) and the elastic buffer (12).
- Unscrew and remove oval head countersunk screw (11) from the trigger guard (10).
- Lift the trigger guard (10) on both sides with a screwdriver (once on the left-hand side and twice on the right), then unlatch from the receiver (1) and draw off forwards (Fig. 28).
- Remove insert piece (9) downwards and the trigger (4) upwards.

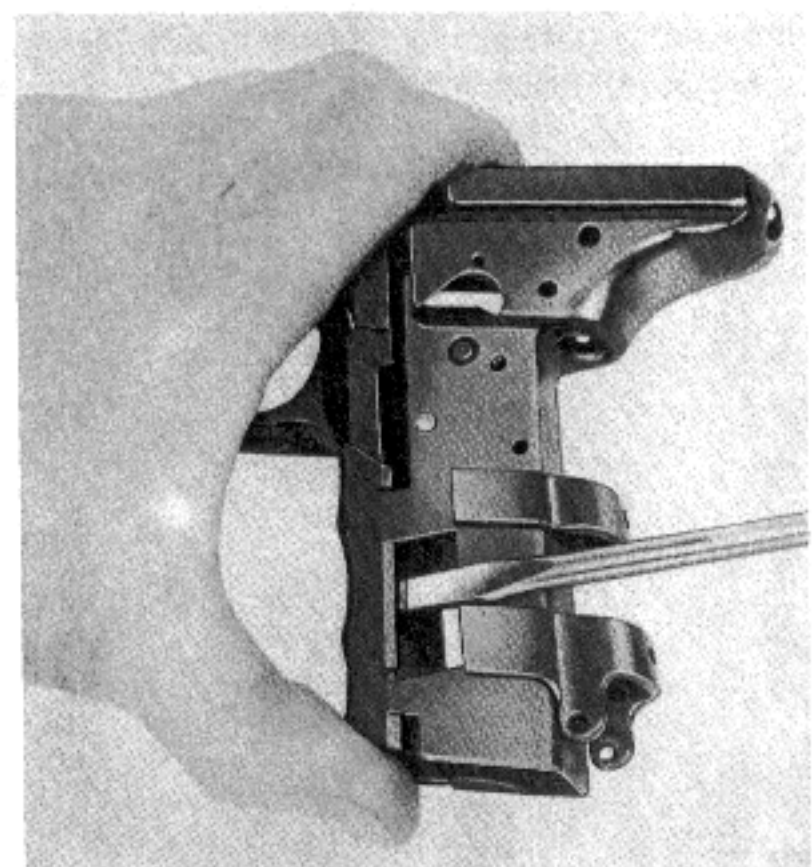

Fig. 28

#### 4.4.2 Checking the individual components

Before incorporating new individual components and reassembling the receiver, and after having cleaned and examined the bores for perfect condition, carry out the following checks:

- Examine the receiver (1) for cracks; the guide grooves must be correctly aligned and devoid of any distortion.
- The ejector must protrude above the upper edge of the receiver by between 2.9 mm and 3.1 mm.
- The buffer housing (13) must be examined for crack formation and bulging.
- The elastic buffer (12) must not be squashed.
- The functional hook on the pull bar (18) must not have excessively rounded-off points.
- The catches on the intermediate lever (30), hammer (20), and catch lever (17) must not show any signs of heavy wear or damage.
- The compression spring for the shank must have an uncompressed length of 59.5 mm.

#### 4.4.3 Reassembling the receiver

- Insert the catch (2) into the receiver (1) and push it up through its full travel (Fig. 29).

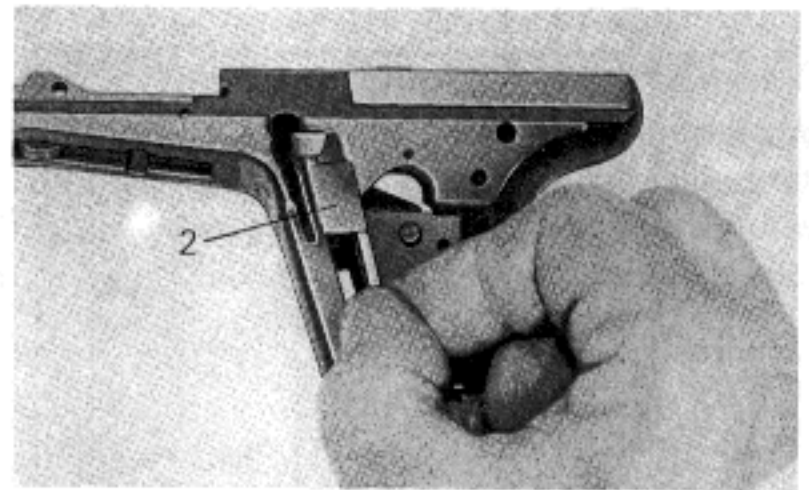

Fig. 29

- With its short leg pointing upwards, introduce the longer leg of the catch spring (3) into the drill hole provided in the fitted catch (Fig. 30).

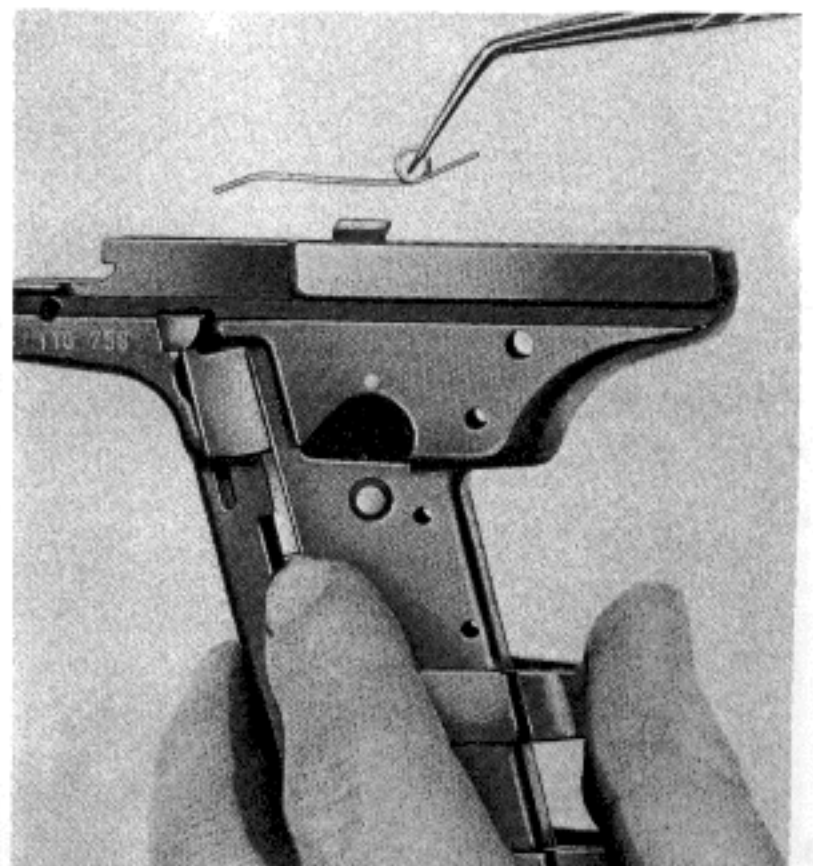

Fig. 30

- Press the eye of the catch spring over the permanently incorporated pin on the left-hand side of the receiver, pulling the shorter end of the spring upwards until the spring end locates against the fixed stop abutment. This action places the catch spring under tension so that it is pressed downwards.
- Insert the trigger (4) from above (Fig. 31).

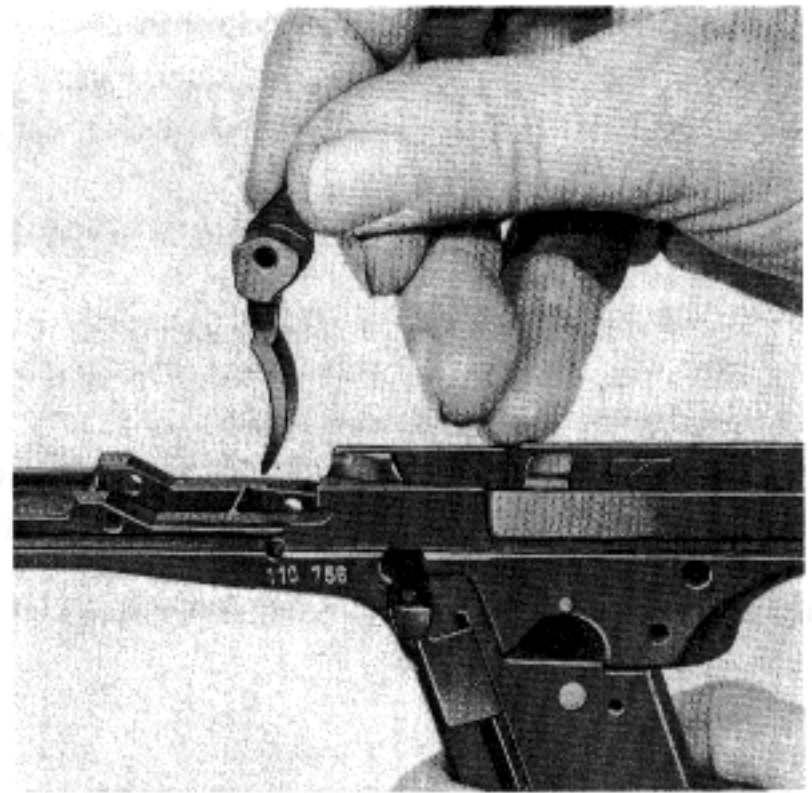

Fig. 31

- Introduce the insert piece (9) with its semi-circular surface downwards so that both lugs are towards the right-hand side of the receiver, looking towards the muzzle end (Fig. 32).

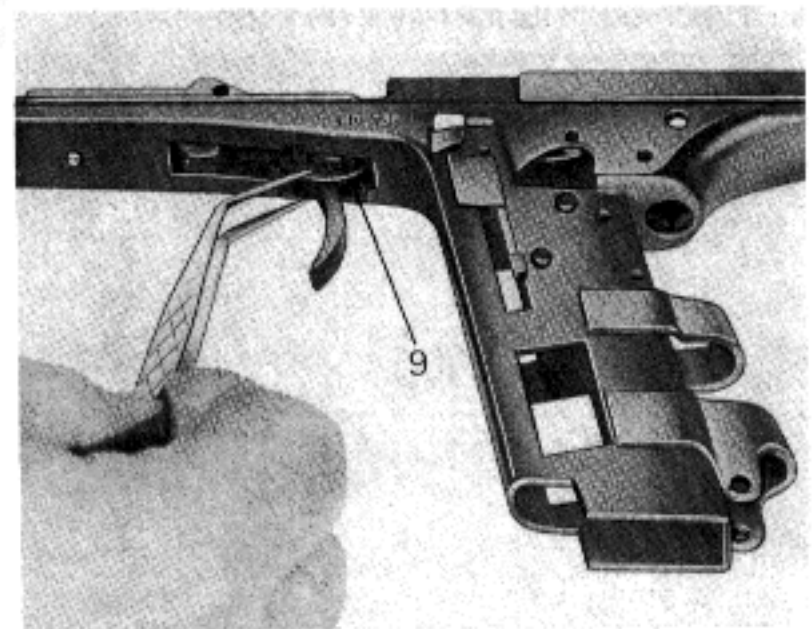

Fig. 32

- Mount the trigger guard (10) on the receiver pushing it up and pressing it until the trigger guard engages on both sides in the receiver (Fig. 33).

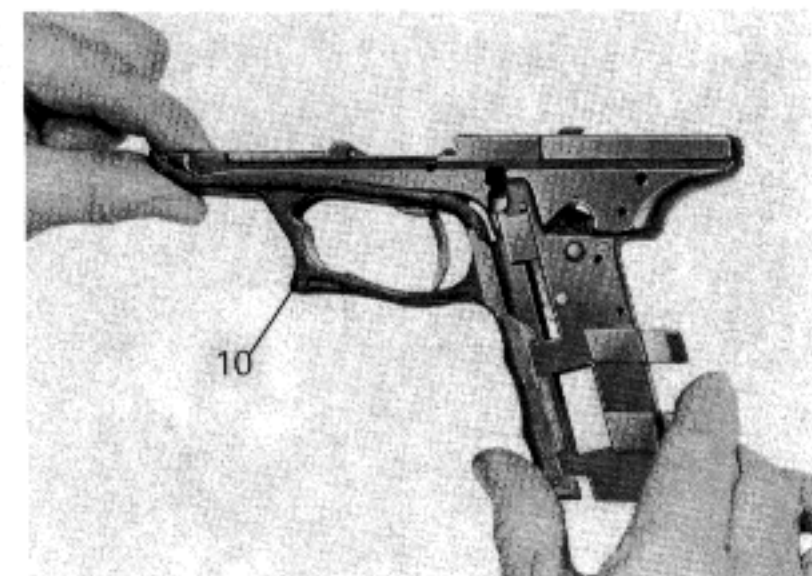

Fig. 33

- Position the trigger spring (5) in the trigger so that the longer end of the spring points towards the muzzle end. Retain the trigger and the trigger spring in the receiver with the assembly pin (Fig. 34), follow up with cylindrical pin (6) until it fits flush with both sides of the receiver.

**Note:**

The trigger is now under spring tension.

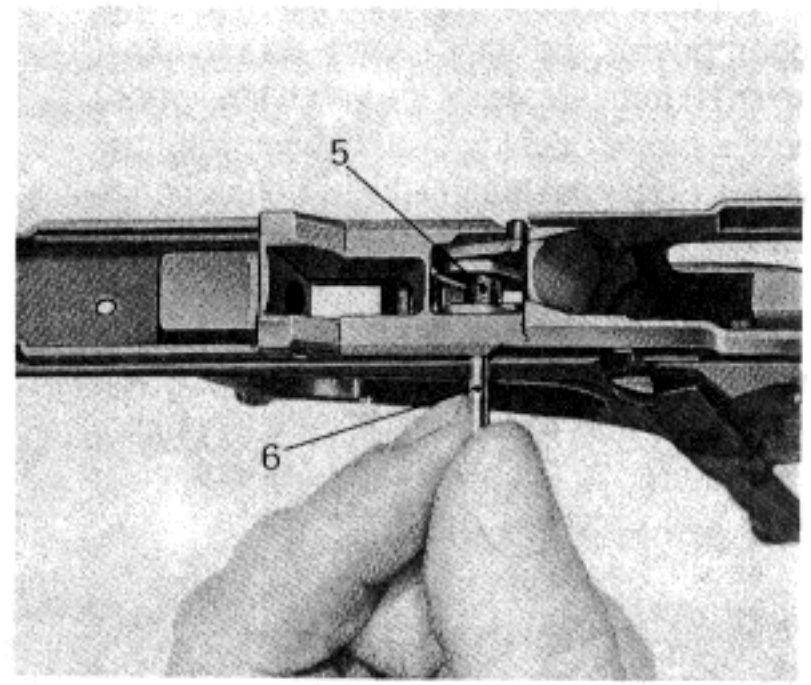

Fig. 34

- Insert compression spring (8) into the barrel clamp (7).
- Introduce both components into the receiver, retaining them in position with assembly pin dia 2.85 x 30 (Fig. 35), follow up with cylindrical pin (6) until it fits flush with both sides of the receiver.

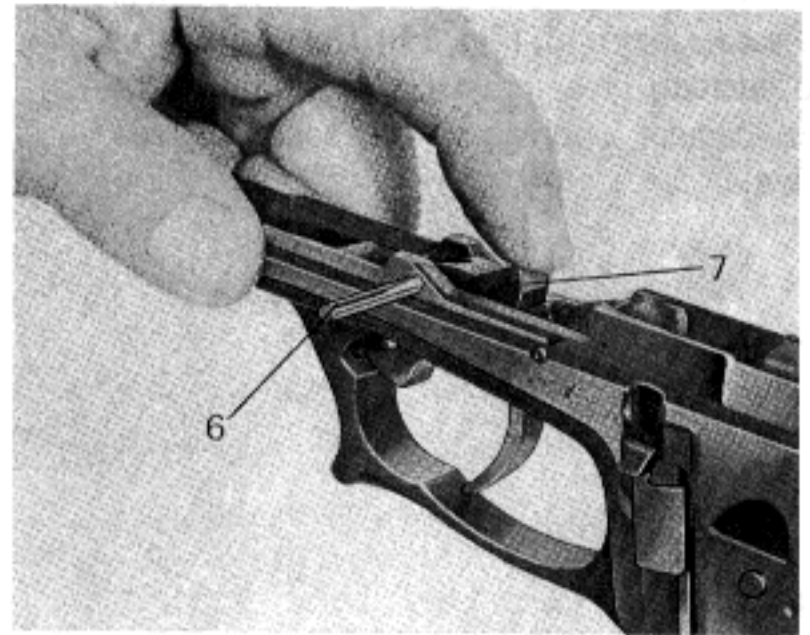

Fig. 35

- Insert elastic buffer (12) into the buffer housing (13).
- Place the support (14) onto the buffer housing and insert both components into the receiver (Fig. 36).

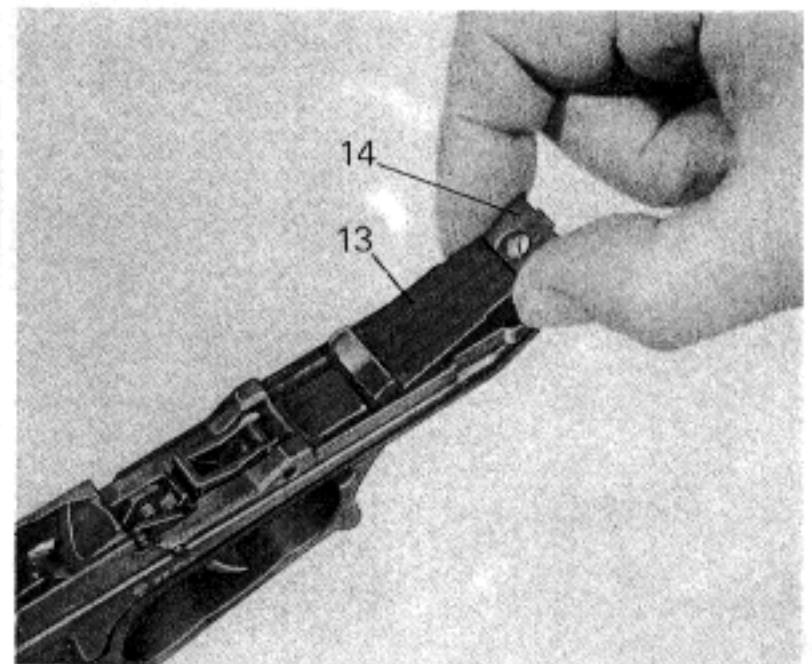

Fig. 36



- Fit the threaded insert (15) from below into the trigger guard and lens head countersunk screw (11) from above, at the same time pressing the buffer housing slightly back with the support. Screw the insert and the countersunk screw together (counter screw).
- Thread lens head countersunk screw (11) into the receiver and tighten firmly.
- Introduce the catch lever (17) into the receiver (Fig. 37) so that the end of the elbow spring projects through the small drill hole in the receiver (see arrow).

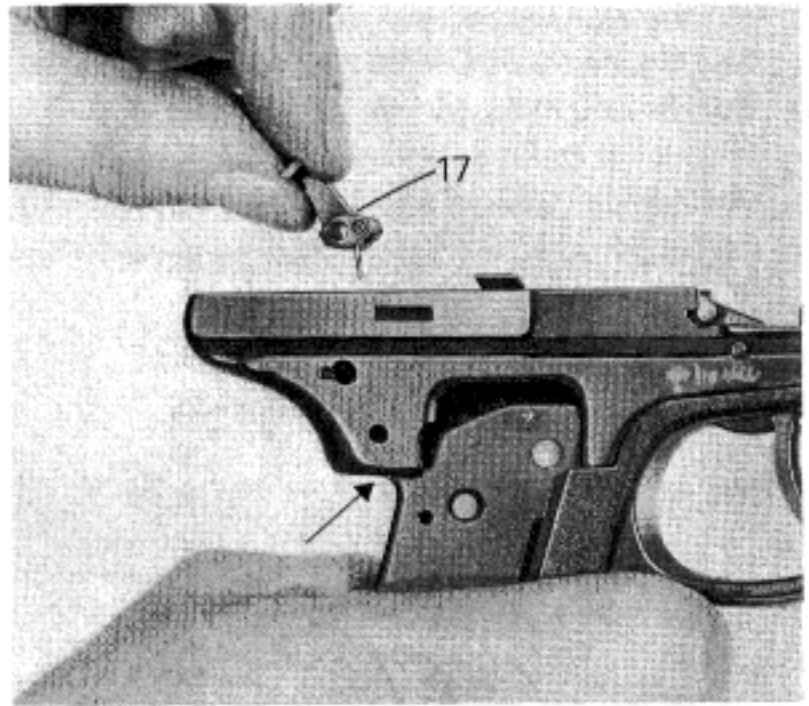

Fig. 37

- Introduce the assembly pin from the right-hand side of the receiver, lock the catch lever and fit the safety latch (16) (Fig. 38). The long arm of the latching lever must project through the semi-circular opening in the receiver (see arrow).



Fig. 38

- Follow up with cylindrical pin (6) until it fits flush on both sides of the receiver; the longer arm of the latch must be free to move (Fig. 39).



Fig. 39

- Fit the pull bar (18) and trigger bar (19) on over the projections on the trigger (Fig. 40).

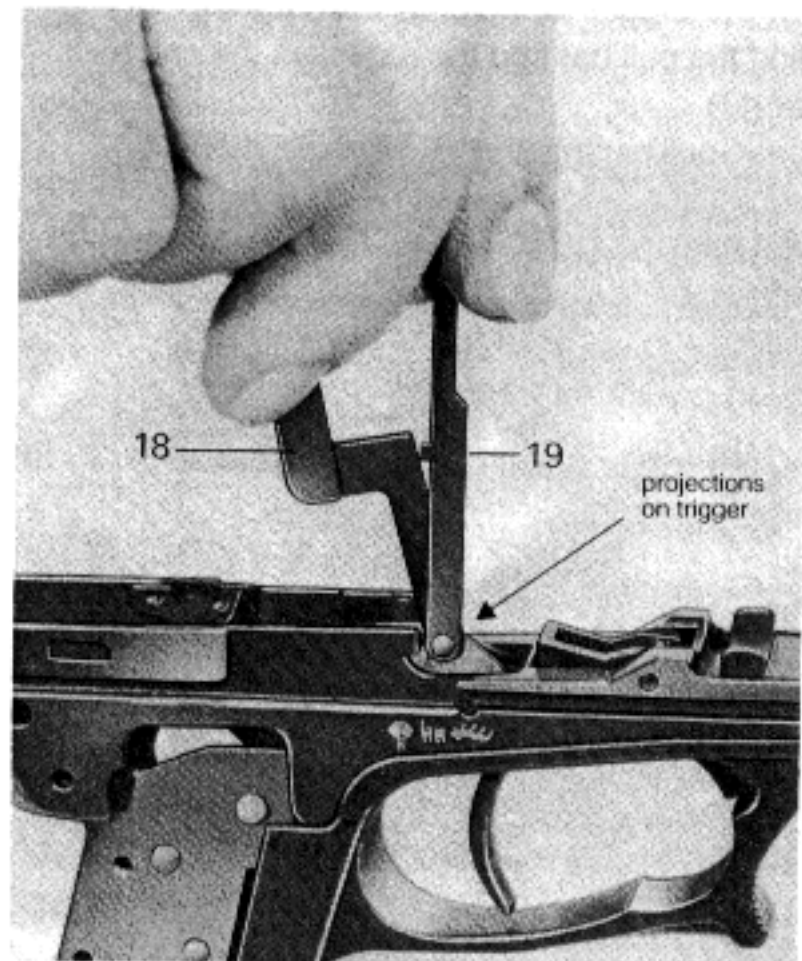

Fig. 40

- Pull the trigger fully back, swivel the pull bar into position in the receiver and follow it with the trigger bar (Fig. 41).

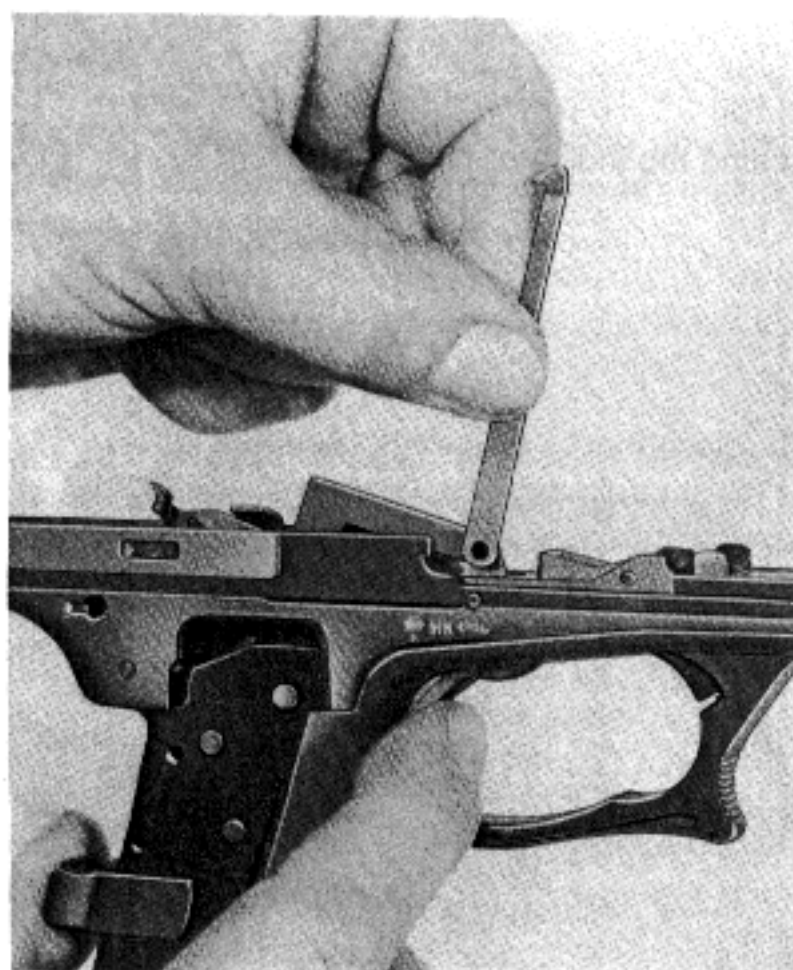

Fig. 41

- Allow the trigger to travel forward again, swivelling the pull bar into the recess in the catch lever (17).
- Trigger, pull bar and trigger bar must move unrestrictedly.
- Fit the hammer (20) (Fig. 42), feeding it downwards until it is correctly positioned.

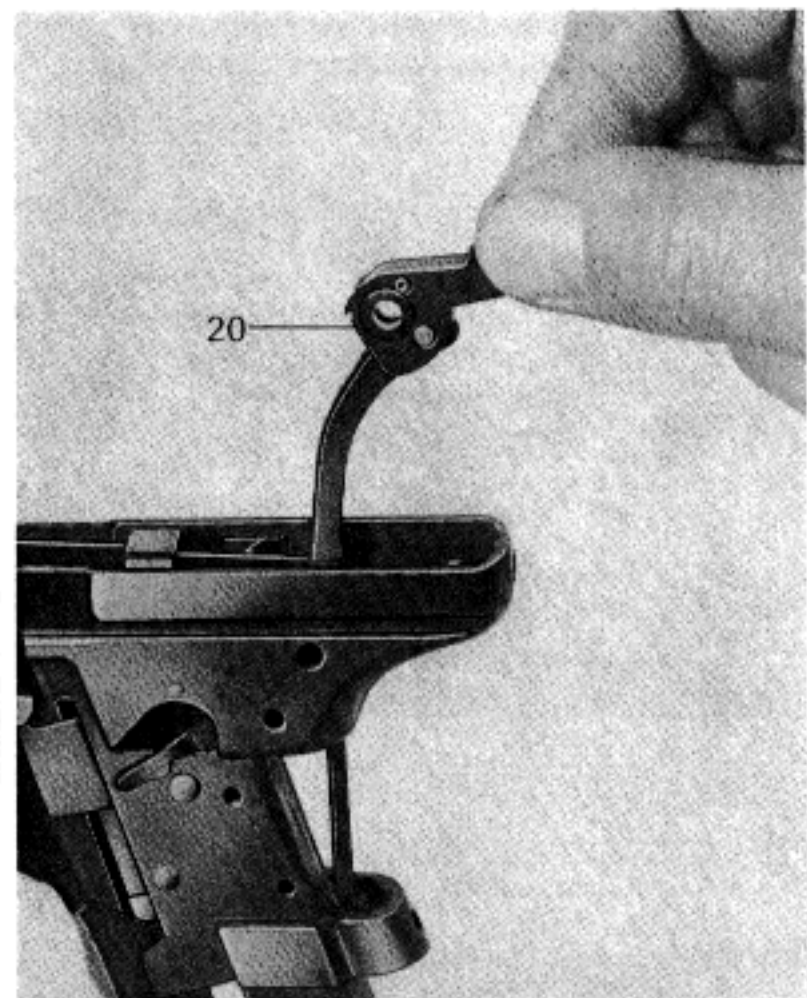

Fig. 42

- With the trigger operated, fit the indicator pin (21), feeding the shorter leg through the rear recess in the receiver (Fig. 43).

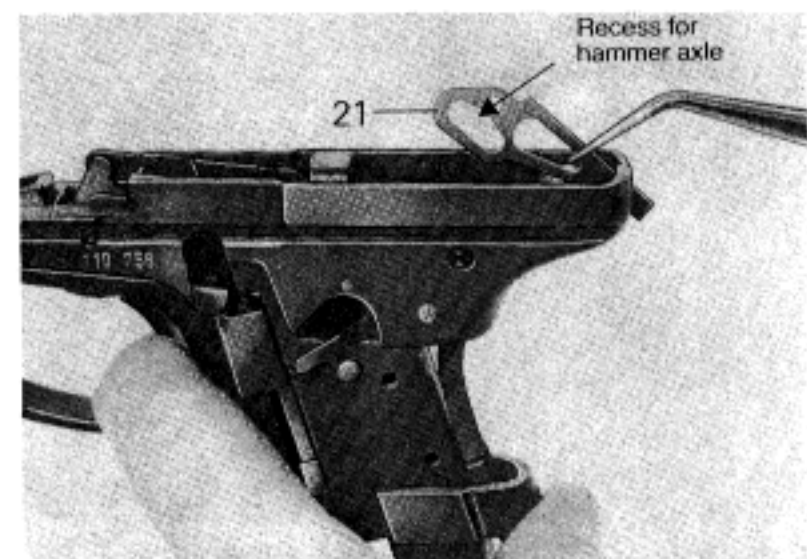

Fig. 43

**Note:**

When fitting the indicator pin, ensure that the pin on the hammer engages into the recess indicated by arrow.

- Fit the disconnecter (22) with its spring (Fig. 44) over the centrally positioned hammer and indicator pin, making sure that the trigger bar comes to rest between the short jaws of the disconnecter.



Fig. 44

- Align the drill holes in the disconnecter and the hammer as well as the recess for the hammer axle (23), and retain in position by inserting assembly pin dia. 3.85 x 35 from the right-hand side of the receiver.
- Introduce the hammer axle from the right, taking care that the projection on the axle engages in the recess provided for it in the receiver (Fig. 45).

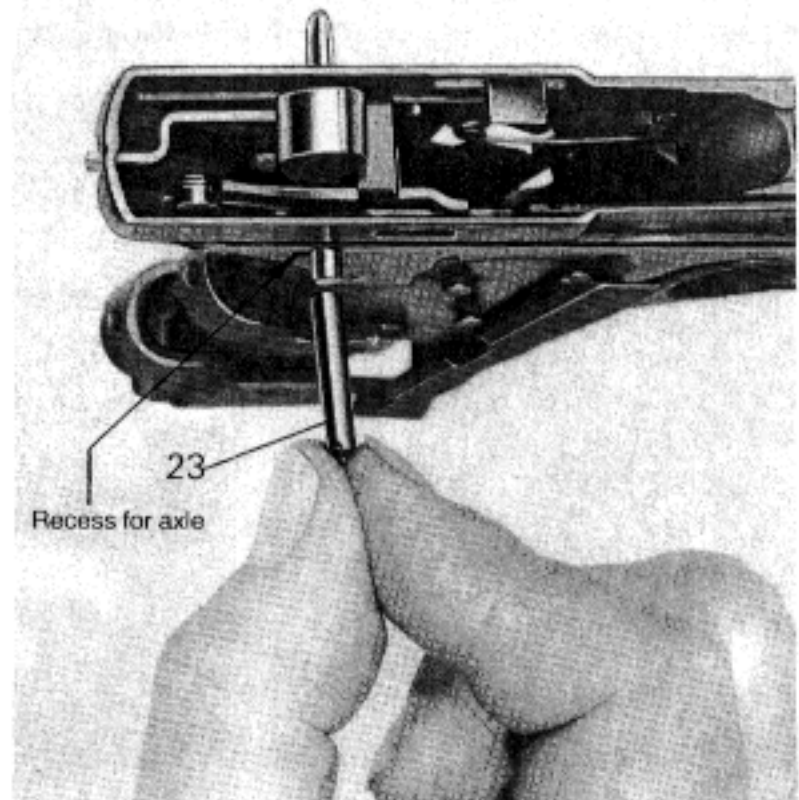

Fig. 45.

- Mount the angle lever (26), cocking lever (27) and the left-hand bearing plate (28) onto the receiver and attach the bearing plate to the **left-hand side of the receiver** with countersunk screws (29) (Fig. 46).

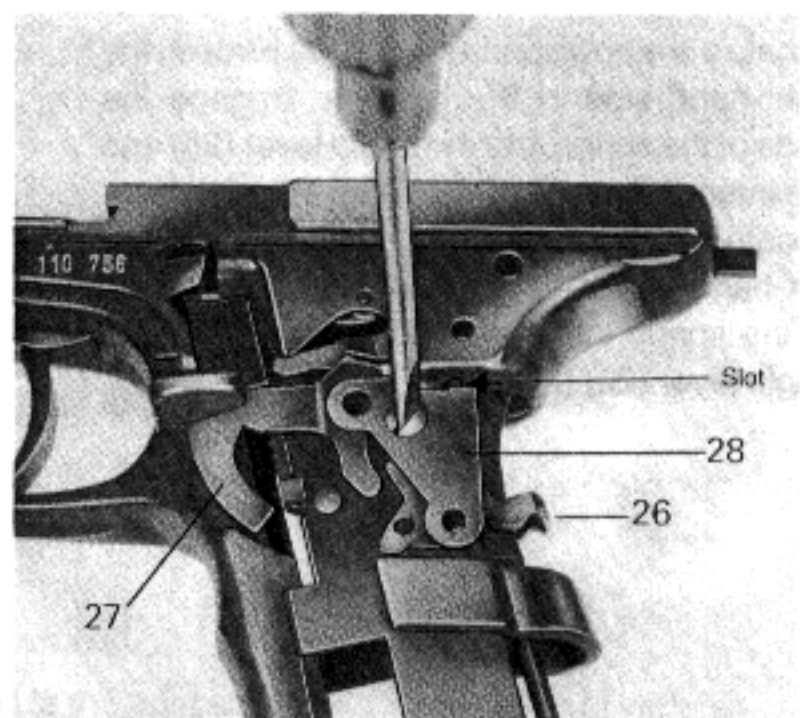

Fig. 46

**Note:**

When inserting the cocking lever, press catch (2) and the arm of the safety latch (16) slightly upwards. Engage the short nose of the bearing plate into the slot provided in the receiver (see arrow, Fig. 46), making certain that the pin on the carrier also locates in the drill hole in the angle lever.

- When inserting the intermediate lever (30), push the pull bar (18) slightly upwards and locate it on the pivot in the receiver.
- Introduce the short nose of the right-hand bearing plate (31) into the slot on the other side of the receiver (see arrow, Fig. 47) and one pin into the drill hole in the angle lever.
- Attach the bearing plate with countersunk screw (29) (Fig. 47).

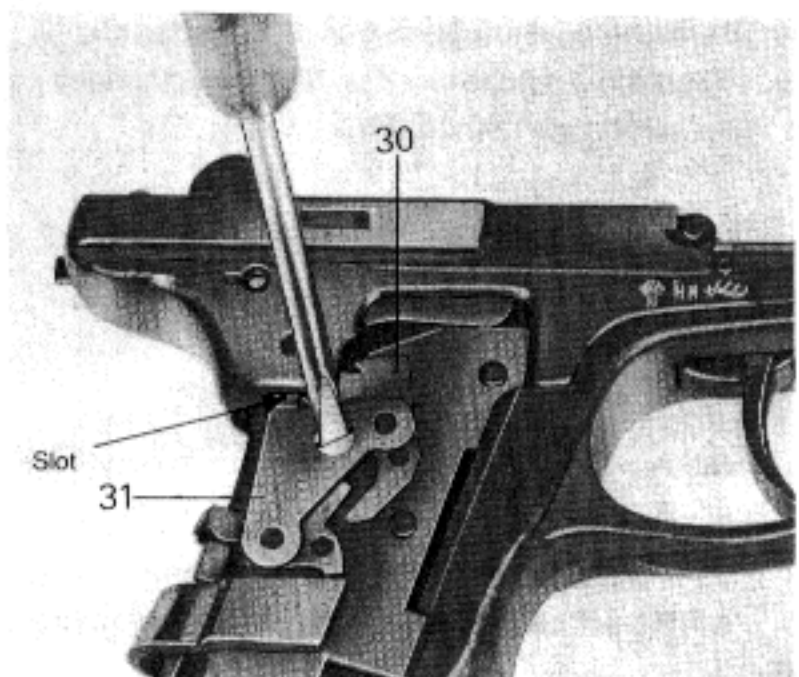

Fig. 47

- Engage the pull bar spring (33) on the right-hand side of the receiver – short leg towards the muzzle end, long leg located in the slot in the pull bar – (Fig. 48).



Fig. 48

- Locate the elbow spring (32) on the pivot on the right-hand side of the receiver; engage the ends of the spring into the angle lever (26) and the intermediate lever (30) (Fig. 48).
- Locate the elbow spring (32) on the pivot on the left-hand side of the receiver; engage the ends of the spring into the cocking lever (27) and angle lever (26) (Fig. 49).

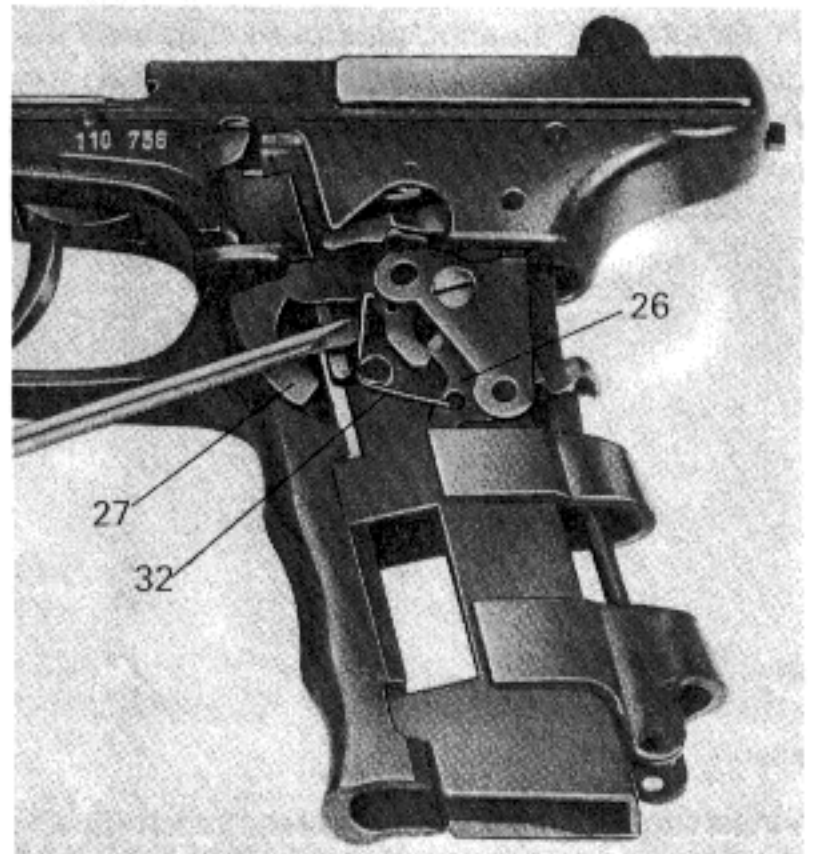

Fig. 49

- Uncock hammer (20) prior to inserting the compression spring for the shank (24).
- Feed the compression spring over the shank.
- Place the magazine catch (25) over the end of the spring and push upwards (Fig. 50).

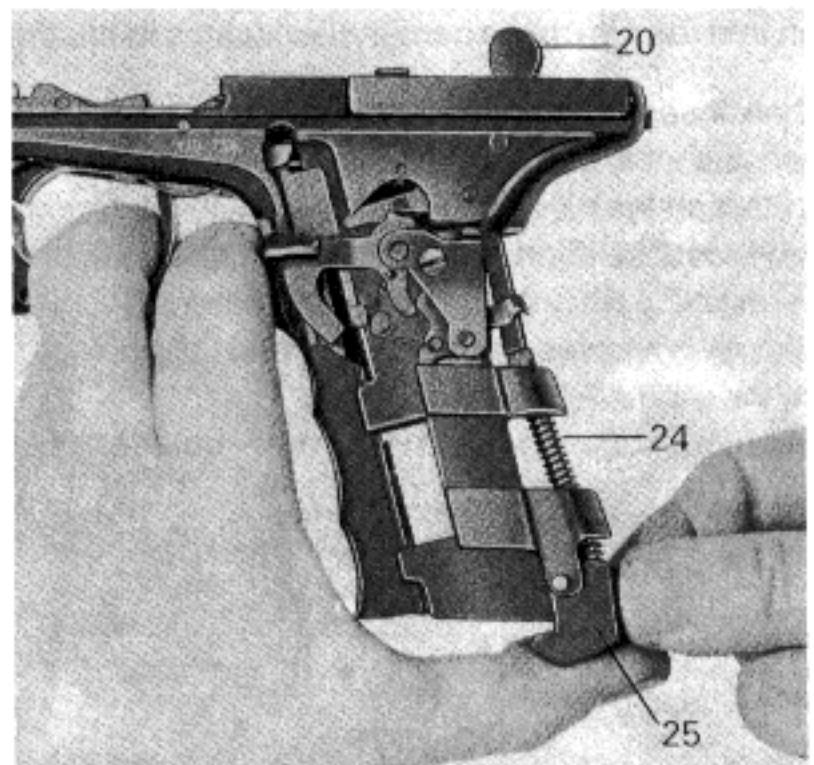

Fig. 50

- Maintain the alignment of the drill holes through the magazine catch and the receiver with an assembly pin.
- Follow up with cylindrical pin (6), pressing it in until it is centrally positioned in the receiver.
- To fit the moulded grip, uncock the hammer.
- Push the grip onto the receiver so that the indicator pin (21) passes through the slot in the grip (Fig. 51).



Fig. 51

- Without resorting to force, push the grip onto the receiver as far as it will go.
- Screw the grip firmly to the receiver with lens head countersunk screws – the shorter screw fits into the upper of the two holes in the rear of the grip.

**Note:**

If the moulded grip is properly fitted, then the catch must lie against it.

**4.5 Assembling the pistol**

- The barrel clamp must be fully engaged when fitting the slide to the receiver.
- Insert the magazine.
- Carry out functional testing in accordance with Section 4.7.

**4.6 Correction of sight alignment**

Corrections to the alignment of the sights are to be confined to the front sight only. Front sights of various heights are available for this purpose.

**(1) Changing the front sight**

- Remove the barrel and bolt head from the slide.
- Using a drift, drive out the front sight from right to left. (Fig. 52).

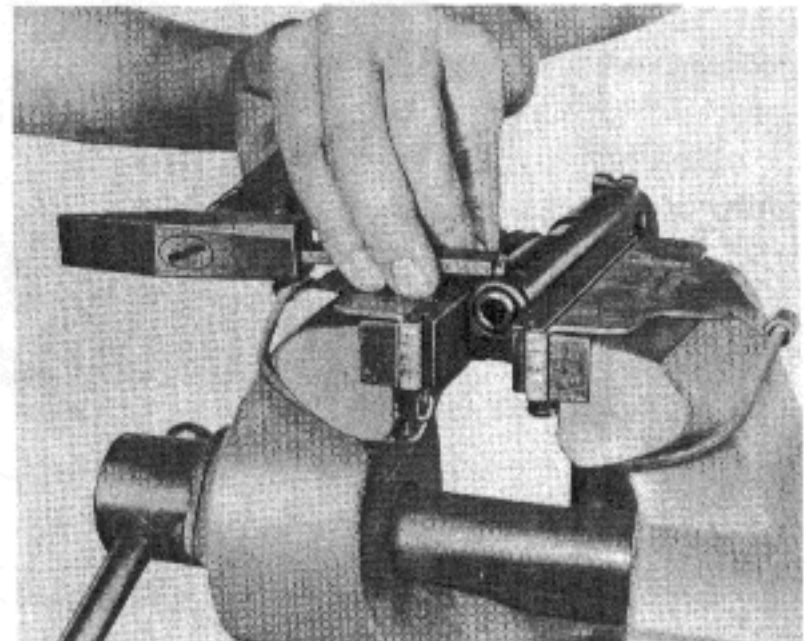

Fig. 52

- Determine the height of the front sight needed – the size is stamped into the base of each sight.
- Depending on the point of impact, drive the new sight blade in from the left or right relative to the centre line of the slide.

(2) Elevation corrections

Point of impact too low:

- Insert a shorter front sight.

Point of impact too high:

- Insert a taller front sight.

(3) Lateral corrections

Lateral corrections to sight alignment can **only** be carried out by displacing the front sight.

- The displacement of the sight relative to the central axis of the slide must not exceed 1 mm.
- A 0.1 mm displacement of the front sight results in a shift of approx. 17 mm in the point of impact over a range of 25 metres (27.3 yds).

Point of impact too far left:

- Move the front sight to the left.

Point of impact too far right:

- Move the front sight to the right.

The sight alignment is checked by firing the P9S pistol over a range of 25 metres (27.3 yds) in accordance with the details on the target illustrated at Fig. 53.

**Note:**

Point of aim = point of impact (see triangle on the target's outer 7 ring).

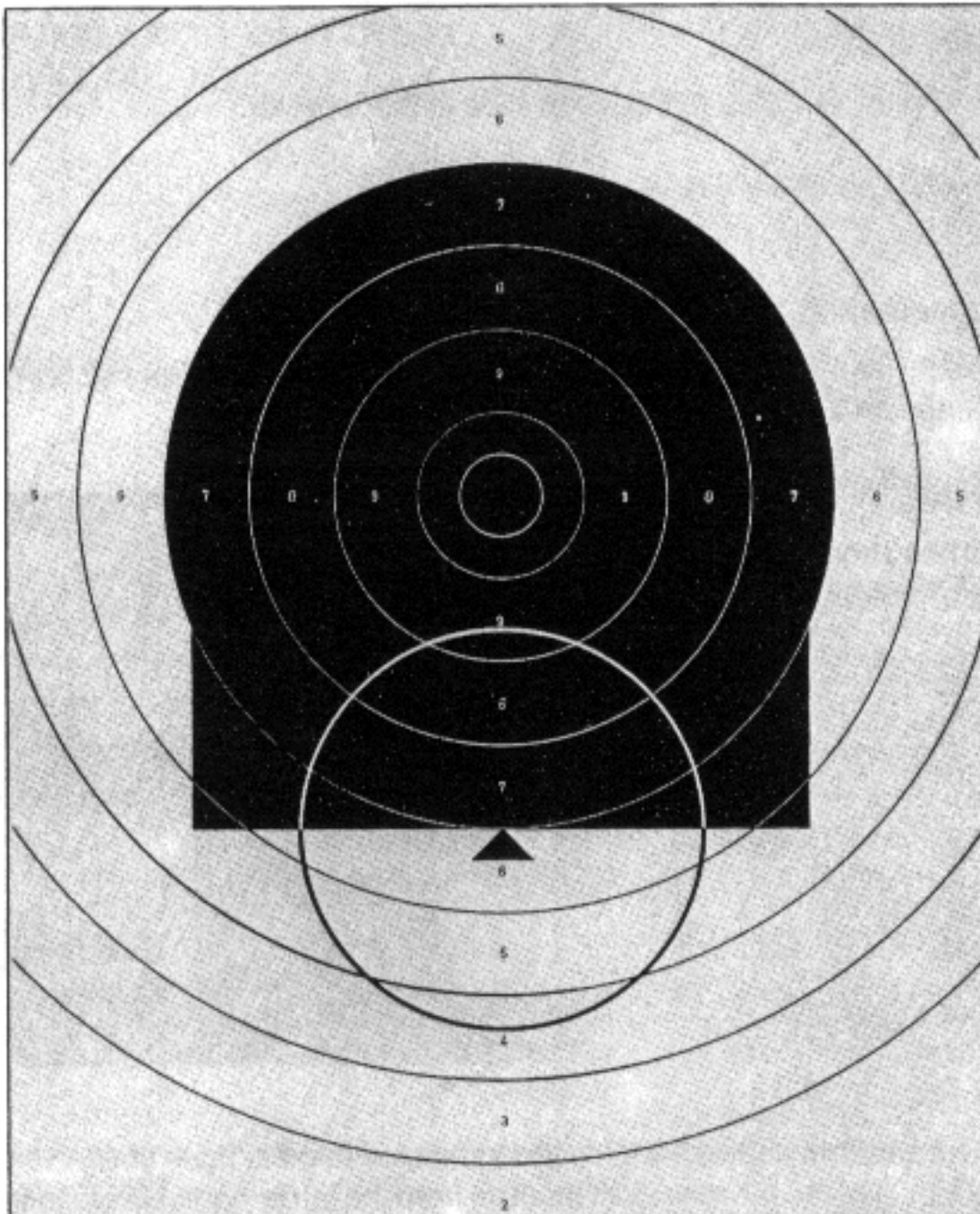

Fig. 53

## **4.7 Conduct of tests after repair**

### **4.7.1 Gap between bolt head and bolt head carrier**

- (1) The gap between bolt head and bolt head carrier is measured with the aid of a 0.15 mm feeler gauge.
  - Remove the slide.
  - Measure the gap between bolt head and bolt head carrier with the feeler gauge.

#### **Note:**

When closed, the gap between bolt head and bolt head carrier must not be less than 0.15 mm; the result of wear is invariably a decrease in the gap.

Powder and other deposits can cause the gap between bolt head and bolt head carrier to increase.

- (2) Correction of the gap between bolt head and bolt head carrier.

A below-limits gap between bolt head and bolt head carrier can be rectified by exchanging the bolt head, bolt head carrier or the barrel complete with the barrel extension.

### **4.7.2 Functional testing**

- Fully load the magazine with dummy training rounds and insert it into the receiver.
- Check the security of attachment in the magazine well.
- Put the pistol on „safe“.
- Draw the slide back to the stop several times allowing it to snap forward each time. This action must cause all the dummy rounds to be fed, extracted and ejected perfectly.  
The indicator pin must show whether the weapon is loaded and the slide must be held on the catch after the last cartridge has been ejected.
- Operate the magazine catch; it must be possible to remove the magazine unhindered.
- When the slide is drawn back, the cocking lever must allow the catch to engage perfectly and lock the slide with the catch lever.

### **4.7.3 Cocking and trigger action**

- Release the safety catch.
- Operate the trigger with the hammer uncocked. In so doing the hammer must move to the rear and automatically snap forwards when the trigger is squeezed through.
- Tension the hammer with the cocking lever; the indicator pin must visibly protrude from the drill hole. Squeeze the trigger until the pressure point is reached; the hammer must not operate.
- With the hammer cocked, the trigger force must lie between 1.4 and 1.8 kg – and approx. 4.5 kg using the double action trigger.
- Press the cocking lever downwards and hold it in this position, squeeze the trigger and maintain it in the rearmost position, allow the cocking lever to move slowly upwards.
- Release the pressure on the trigger, the pistol must be uncocked (the hammer is held on the retention notch) and the trigger must not catch.
- Press the cocking lever fully down, the pistol must now be fully cocked and the indicator pin visible.
- Squeeze the trigger and hold it in the rearmost position, pull back the slide and allow it to ease forward; the hammer must thereby remain cocked.
- Actuating the hammer again should be possible only after releasing the trigger.

### **4.7.4 Safety devices**

- (1) Safety of the weapon

- The safety lever must move unrestrictedly and engage positively in both positions.
- Release the safety catch.
- Cock the hammer.
- Squeeze the trigger; the hammer must now snap forward.
- Apply the safety catch.
- Cock the hammer.
- Squeeze the trigger; the hammer moves forward and is checked by the safety axle (use an emptied cartridge to test this action – the primer must not be detonated).



**(2) Safety of the shooter**

- **Apply the safety catch.**
- **Cock the hammer.**
- **With the slide, draw the bolt head approx. 1 mm to the rear.**
- **Squeeze the trigger; it must pull through off-load without operating the hammer.**



Fig. 54 Assemblies

5.1 Assemblies

Item	Parts Designation	Part No.	Ident. No.
1	2	3	4
1	Slide	2811-10.00	210 151
2	Receiver	2812-01.00	210 152
3	Grip	2812-13.00	210 226
4	Magazine	2801-20.00	200 606

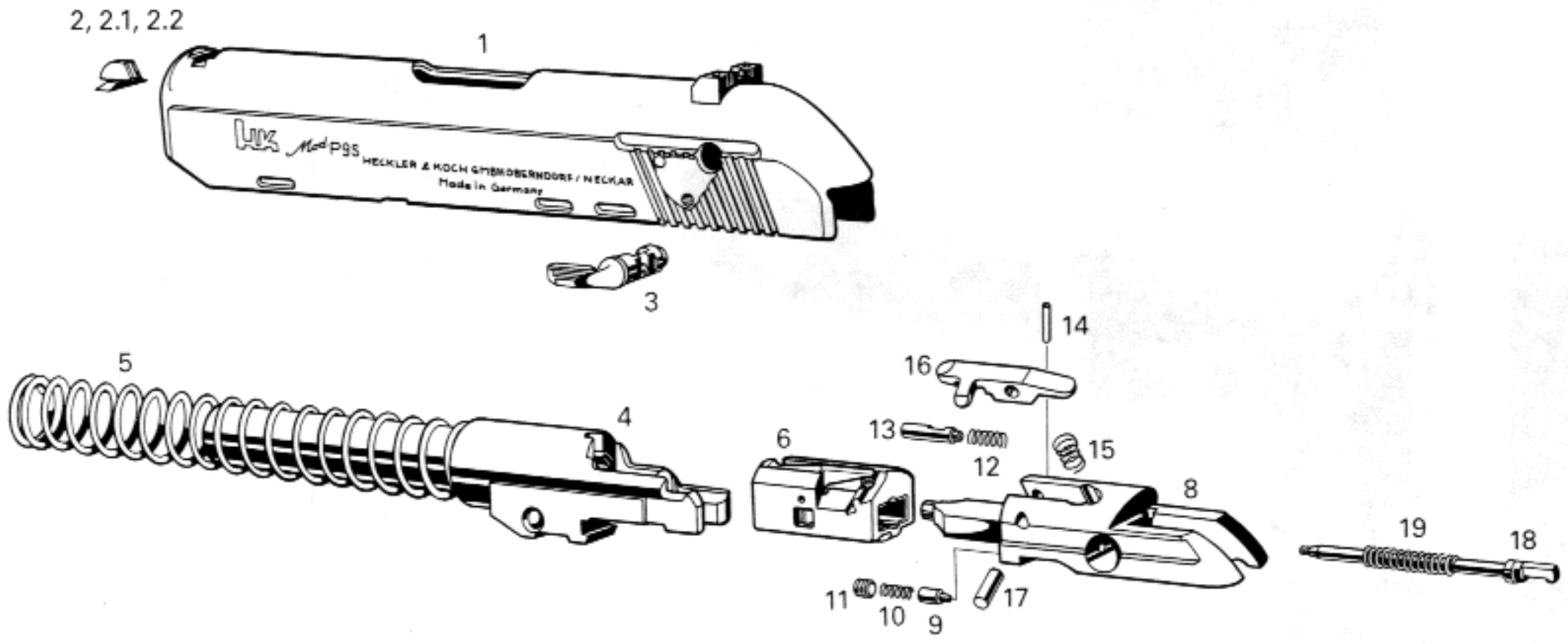

Item	Parts Designation	Part No.	Ident. No.			Remarks
1	2	3	4	5	6	7
1	Slide with sights	2811-10.01	210 209			
2	Front sight 7.1	2801-10.16 (08)	210 423			
2.1	Front sight 7.5	2801-10.16 (10)	210 434			
2.2	Front sight 7.9	2801-10.16 (12)	210 436			
3	Safety catch	2801-10.15	210 013			
4	Barrel	2801-14.00	200 654			
5	Compression spring for barrel	2821-10.07	210 345			
6	Bolt head, compl.	2801-13.00	200 653			
7	Bolt head carrier, compl.	2821-22.00	210 359			
8	Bolt head carrier	2821-22.01	210 358			
9	Catch bolt	2801-12.02	200 663			
10	Compression spring	1013-101.09	200 383			
11	Set screw	2803-01.08	210 272			
12	Compression spring for locking catch	2801-12.10	200 670			
13	Pressure pin	2801-12.03	200 664			
14	Pin	2 x 8 DIN 7344	928 029			
15	Compression spring for locking catch	2801-12.04	200 665			
16	Locking catch	2801-12.05	200 666			
17	Cylindrical pin	3 M 6 x 10 DIN 6325	922 692			
18	Firing pin	2801-10.13	210 012			
19	Compression spring	2801-10.04	200 656			
					without illustr.	comprises Item 8-17

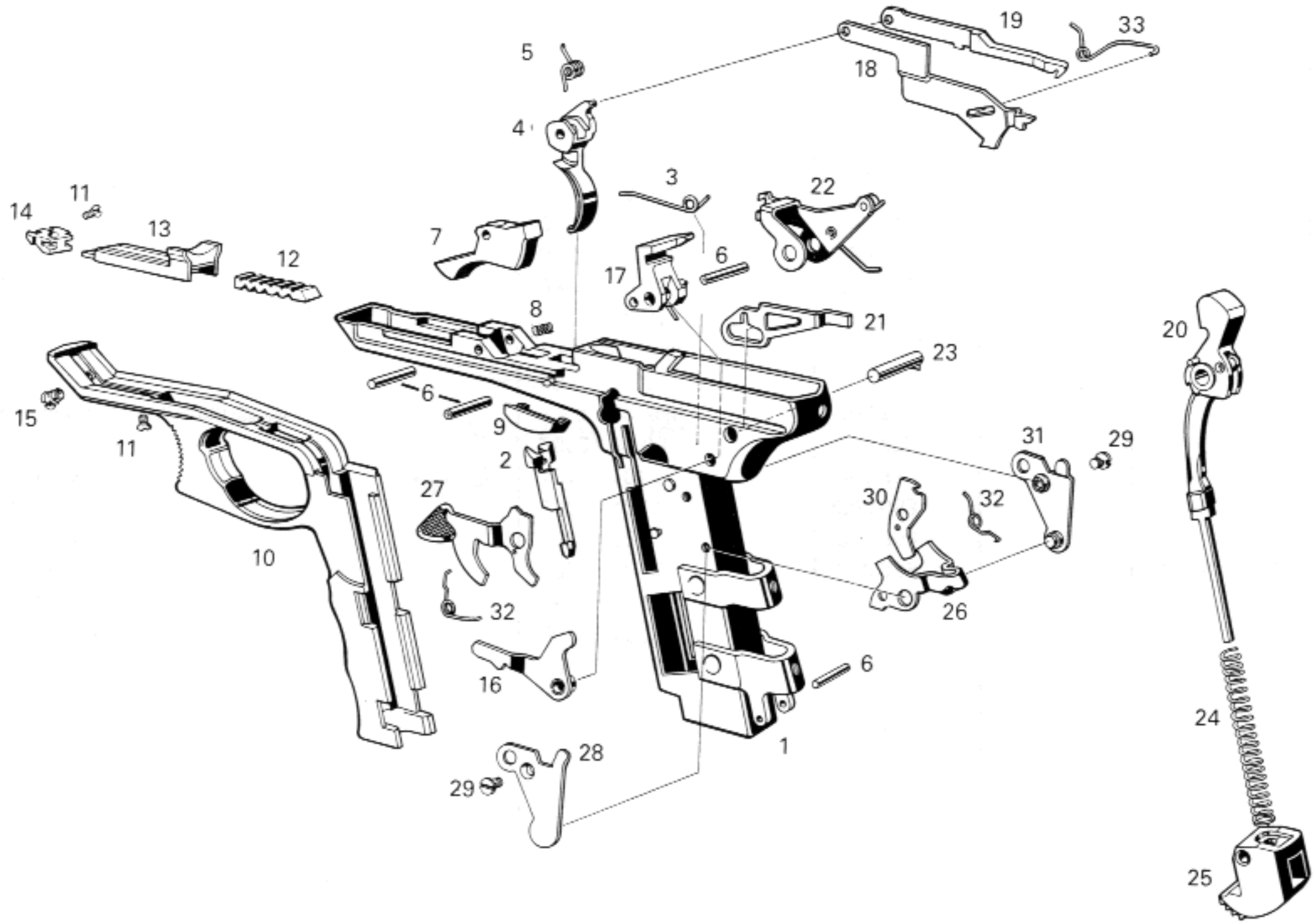

Item	Parts Designation	Part No.	Ident. No.	5	6	Remarks
1	2	3	4	5	6	7
1	Receiver	2802-02.00	201 292			
2	Catch	2821-01.06	210 319			
3	Spring for catch	2802-01.20	201 367			
4	Trigger	2802-01.01	201 279			
5	Trigger spring	2802-01.13	201 289			
6	Cylindrical pin	2801-01.10	200 619			
7	Barrel clamp	2802.01-14	201 290			
8	Compression spring for barrel clamp	24.120.071	201 150			
9	Insert piece	2802-01.08	201 285			
10	Trigger guard	2802-01.05	201 282			
11	Lens head countersunk screw	2803-01.07	210 271			
12	Elastic buffer	2801-01.29	201 318			
13	Buffer housing	2801-16.00	201 326			
14	Support	2801-01.30	201 319			
15	Threaded insert	2803-01.05	201 321			
16	Safety latch	2802-10.00	202 203			
17	Catch lever, assembled	2802-11.00	210 006			
18	Pull bar	2802-01.23	210 018			
19	Trigger bar	2802-19.01	210 015			
20	Hammer, compl.	2802-03.00	210 297			
21	Indicator pin	2801-01.25	200 621			
22	Disconnecter, assembled	2802-12.00	210 007			
23	Axle for hammer	2802-01.07	201 284			
24	Compression spring for shank	2801-01.15	200 623			
25	Magazine catch	2801-01.31	202 177			
26	Angle lever	2821-02.06	210 320			
27	Cocking lever	2801-06.00	200 609			
28	Bearing plate, left	2821-25.00	210 377			
29	Countersunk screw for bearing plate	2802-01.19	202 202			
30	Intermediate lever	2802-01.11	201 287			
31	Bearing plate, right	2821-24.00	210 376			
32	Elbow spring for cocking lever, angle lever and intermediate lever	2801-01.21	200 628			
33	Spring for pull bar	2802-01.15	201 291			

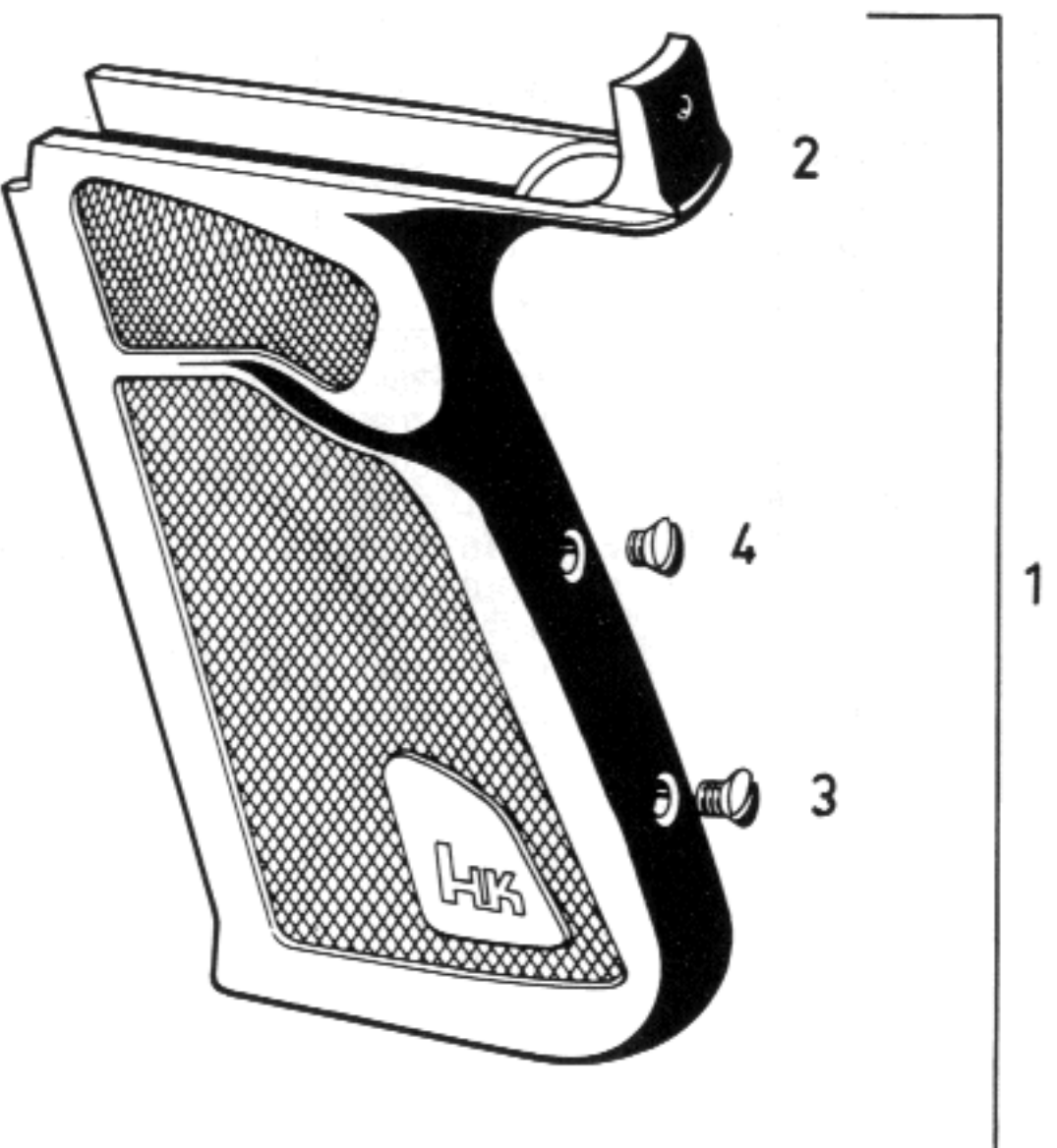

Item	Parts Designation	Part No.	Ident. No.	5	6	Remarks
1	2	3	4	5	6	7
1	Grip, right compl.	2812-13.00	210 226			
2	Grip, right	2802-01.21	201 797			
3	Lens head countersunk screw	AM 4 x 7 DIN 91	928 017			
4	Lens head countersunk screw	AM 4 x 5 DIN 91	929 371			



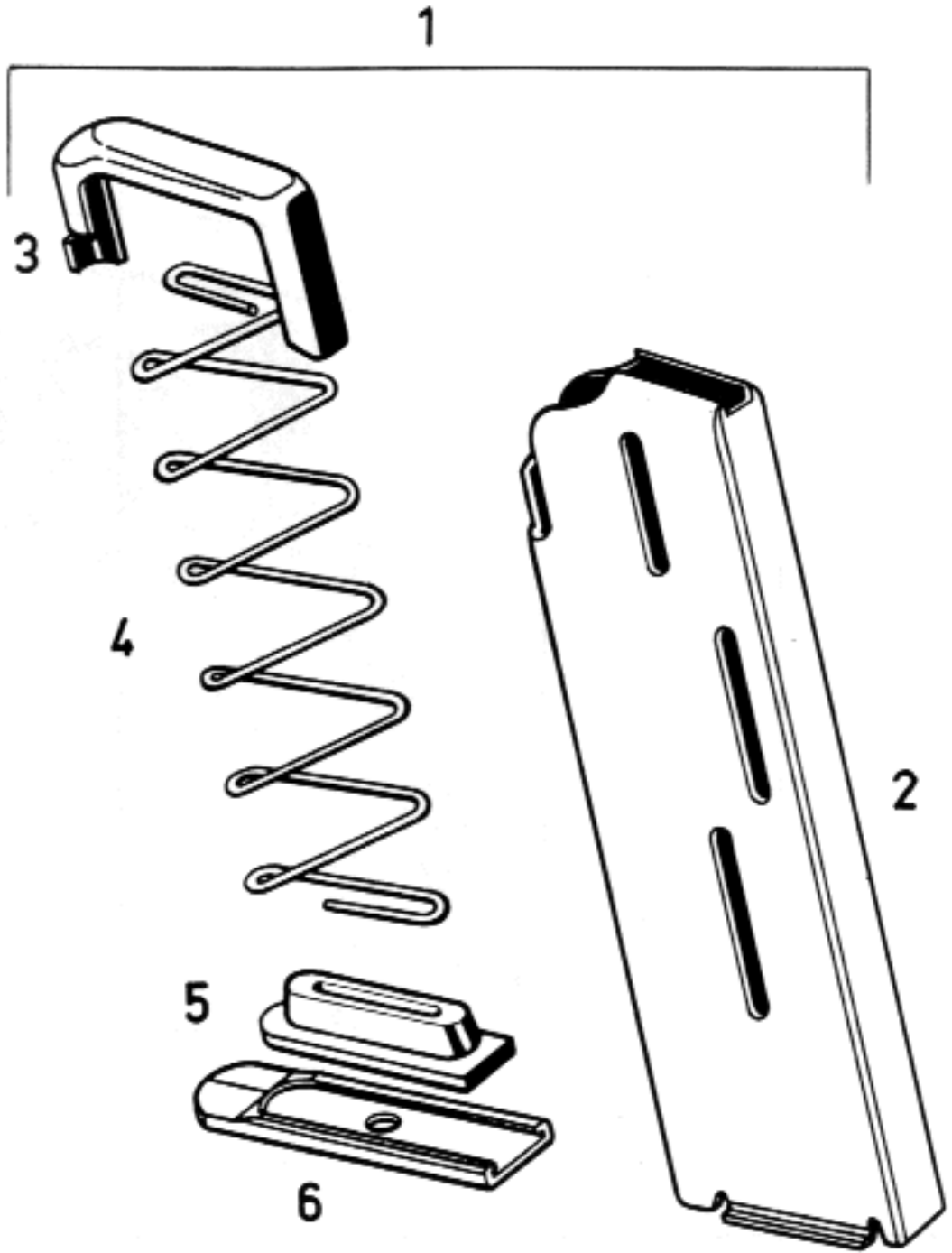

Item	Parts Designation	Part No.	Ident. No.	5	6	Remarks
1	2	3	4	5	6	7
1	Magazine, compl.	2801-20.00	200 606			
2	Magazine housing	2801-20.01	200 681			
3	Follower	2801-20.03	200 683			
4	Follower spring	2801-20.02	200 682			
5	Support for follower spring	2801-20.04	200 684			
6	Magazine floor plate	2801-20.05	200 685			
6	Pins					
7	Arms					
8	Backs					
9	Backs					
10	Assemblies					
11	Assemblies					
12	Supports					
13	Hammers					
14	Closures					

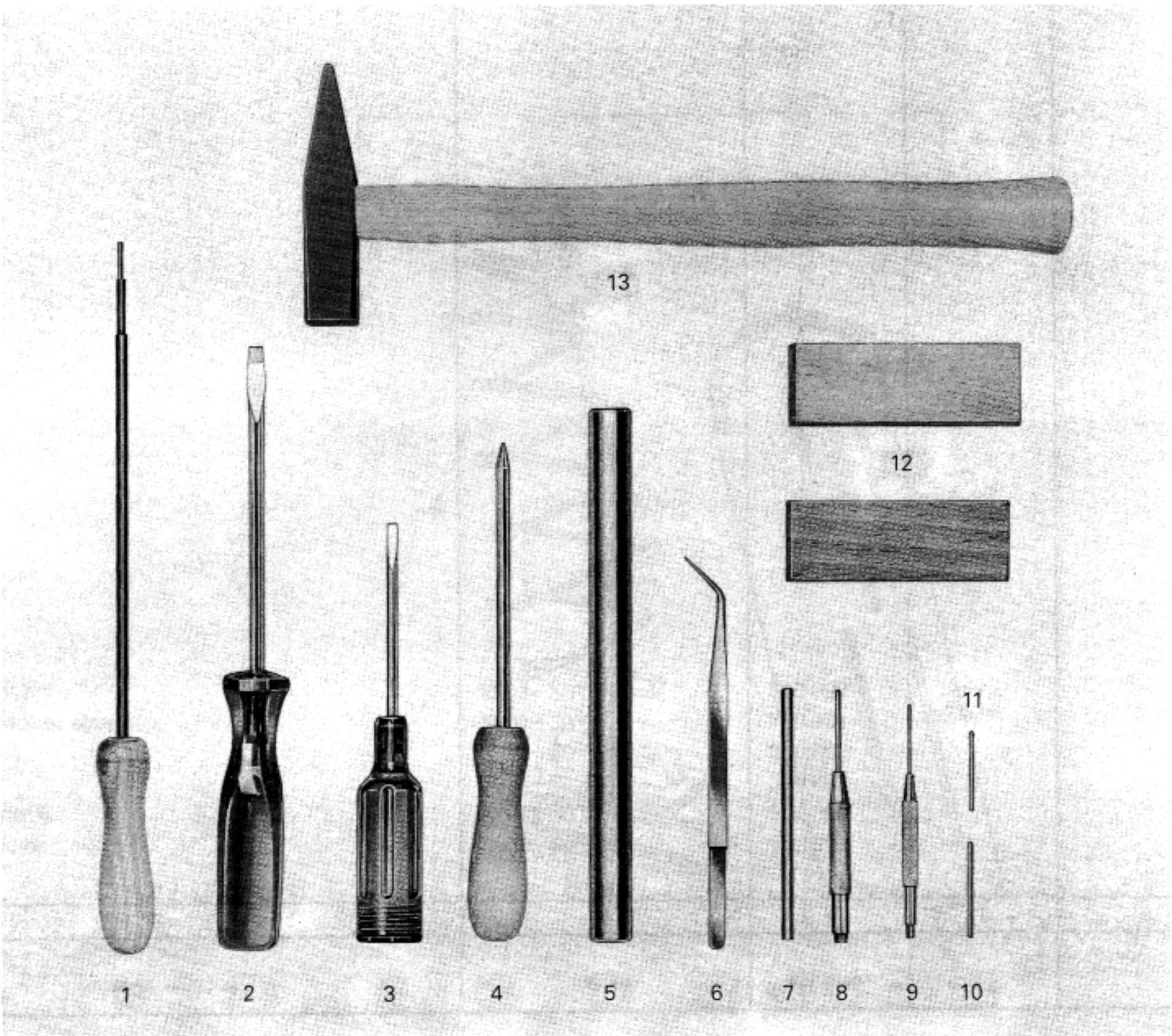

Item	Parts Designation	Part No.	Ident. No.			Remarks
1	2	3	4	5	6	7
1	Screwdriver 2 mm x 180	961 641	323 061			
2	Screwdriver 5.5 mm x 120	52 750 040	952 655			
3	Screwdriver 4 mm x 100	52 729 020	955 086			
4	Assembly mandrel for safety catch $\varnothing$ 5 x 180 with top 30°	961 642	323 060			
5	Assembly mandrel $\varnothing$ 16 x 200	961 639	323 063			
6	Pincers	53 014-010	957 288			
7	Assembly mandrel $\varnothing$ 5 x 100	961 640	323 062			
8	Backing-out punch $\varnothing$ 2.8	51287-028	957 312			
9	Backing-out punch $\varnothing$ 1.8	51287-018	957 310			
10	Assembly pin $\varnothing$ 3.85 x 35	961 643	323 059			
11	Assembly pin $\varnothing$ 2.85 x 30	961 644	323 058			
12	Supporting surface 30 x 20 x 80	961 645	323 057			
13	Hammer, 200 g	51 180 020	957 416			
14	Cleaning kit, cal. 7.62 - 9 mm	St 100 200	211 022			see Fig. 1