

M10-M11 Suppressor

RPB has recently been sold. The current owners now produce both guns and suppressors to original MAC/Sionic specifications. They have also arranged to rename the company Sionics Inc. Insurgents and counter-subversives take notice, Sionic/MAC is back.

General Description:

The M-10/M-11 silencers are machined entirely from T6 #6061 Aluminum tubing and round stock. The only non aluminum pieces are the two polyurethane baffles in the replaceable endwipe assemblies.

The silencer consists of three sections; a rear expansion chamber, a front diffusion chamber and the removable end wipe assembly. NOTE: Please refer to the exploded parts drawings for the following.

SUPPRESSOR M11 9MM AUTO (.380)

ITEM	PART
1.	SLEEVE
2.	BAFFLE 280/ASSY
3.	COVER
4.	TUBE
5.	BUSHING
6.	BAFFLE
7.	SPIRAL
8.	SPIRAL
9.	COVER
10.	TUBE
11.	ENCAPSULATOR
12.	WASHER
13.	DISC
14.	SPACER
15.	DISC
16.	END CAP

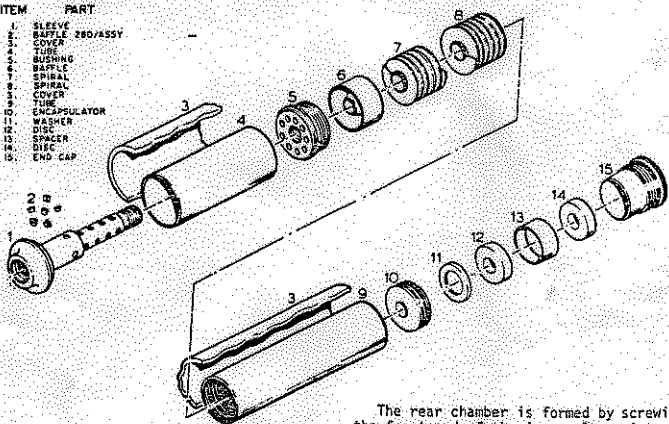

These suppressors were designed and produced to be used in conjunction with the M-10 submachine gun and the M-11 mini-machine pistol, designed by Gordon Ingram.

MAC built and marketed these guns and suppressors until the company was dissolved in 1975.

In 1977, RPB Industries began production of the Ingram SMG's, but not the Sionic suppressor. RPB sold the guns with a suppressor of their own design. This silencer was reportedly inferior to the original Sionics unit and was discontinued.

The rear chamber is formed by screwing the front end of the inner sleeve into the bushing, capturing the rear outer tube between them. The space between the inner sleeve and outer tube is packed with aluminum eyelets. As the powder gas leaves the muzzle, it bleeds through holes drilled along the inner sleeve and passes into the rear chamber. The eyelets reduce gas volume by heat absorption and slow the release of the remaining gas with a baffling action.

The front chamber consists of the front outer tube, closed at the rear by the threaded bushing and at the front by a threaded disc (encapsulator). A cone shaped

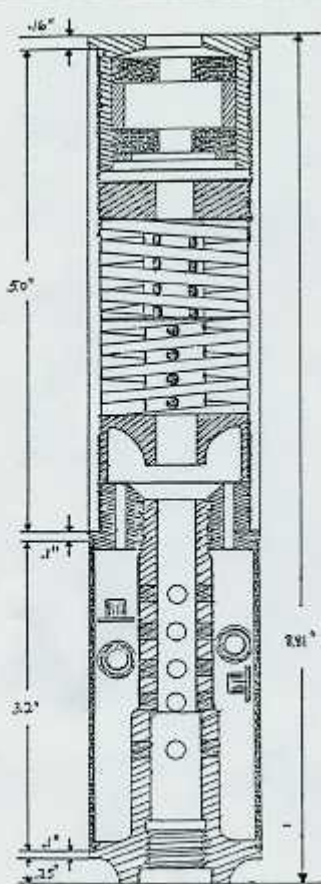

M11 sound suppressor assembled

baffle and two "spiral" diffusers are contained in this section. The gas from the rear chamber passes through holes in the threaded bushing and contacts the cone shaped baffle. The swirling motion created by the baffle delays the passage of gas into the spiral area. The two spirals, one with a left hand and one with a right hand twist, spin the gas Maxin style. Centrifugal force causes the spinning gases to move towards the outer edge of the spiral tube. The result of all of these dissimilar movements is a reverberation effect that dissipates, cools, and slows the release of gas from the front chamber into the endwiper assembly. The bullet's restricted passage through the undersized endwiper baffles further slows the release of gas into the atmosphere.

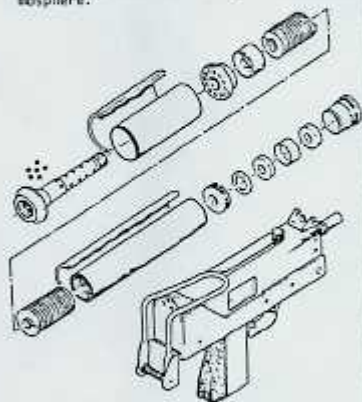

SUPPRESSOR
M11 3MM PARA. C
45ACP

If the above is a bit vague, I'm sorry. The remainder of this issue could be filled with info on the precursor wave, sound pulse curve, harmonics, blow by, pressure differentials, etc. I don't claim to understand all of that any more than you do. I do know that I've never heard anyone downgrade Werbell's basic design which is accepted as better than any of its predecessors. I know of no recent designs that can equal or better the Sionic's performance.

Individual Parts Specs:

Refer to exploded parts view for reference.

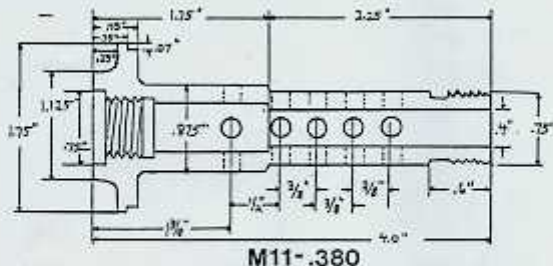
Part #1- Inner Sleeve

Each caliber gun has its own sleeve, threaded to screw onto that model gun barrel only. This prevents destroying a 9mm unit by installing it on a 45 cal gun or rupturing an M-11 380 suppressor with the more powerful 9mm para round fired from the M-10.

Individual barrel thread sizes are as follows:

M 10/45 - 7/8" NC - 9TPI (threads per inch)

M 10/9mm - 3/4" NC - 10 TPI

M 11/380 ACP - 5/8" NC - 11 TPI

Each sleeve is also counter bored for barrel clearance as follows:

M 10/45 - 11/16" x 2" deep

M 10/9mm - 9/16" x 2" deep

M 11/380 ACP - 1/2" x 1 3/4" deep

The rear of each sleeve carries a recessed, flat face that contacts a corresponding shoulder on the gun's barrel, automatically aligning the suppressor with the gun's bore. The front ends of all three model sleeves are threaded 3/4" x 16 TPI (NF).

The rear of the M-10 sleeves are 2.13" OD with the shoulder cut to fit into the back of the 2" ID rear tube. The M-11 sleeve is 1.75" OD with the shoulder cut to fit into the back of the 1.62" ID rear tube. The M-10/45 sleeve is bored .5" ID. The M-10/9mm and M-11/380 versions are both bored .4" ID. All three sleeves are drilled with four rows of five 3/16" diameter holes (a total of twenty) for passage of gas into the rear chamber. See individual full size part drawings for remaining specs.

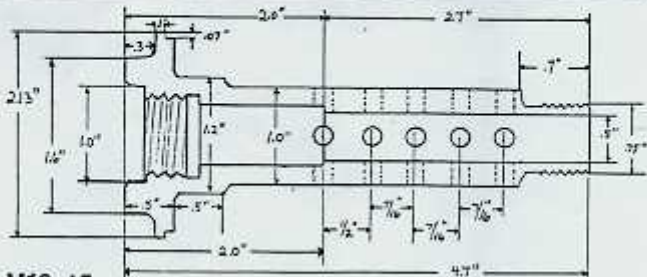

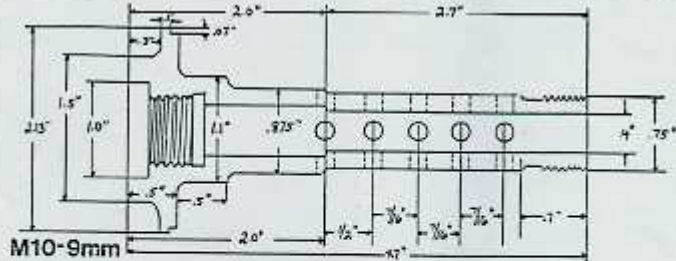

Part #2 - Baffle Assembly:

These baffles are aluminum eyelets, about pop rivet size, which are packed into the rear chamber during assembly. Original factory specs called for 280 eyelets in the M-11 suppressor and 410 in the M-10 units. This number will vary due to eyelet size, sleeve outer diameter, etc. Pack baffle assembly as tight as possible. The completed unit should not rattle if packed correctly.

Part #5 - Baffles:

Two sizes of baffles are used, both are 1.5" OD x .7" Long. The baffle for both the M-11 and M-10/9mm is bored to .4" ID to allow clearance for the .355" diameter bullet. The 45 caliber version is bored to .5" ID.

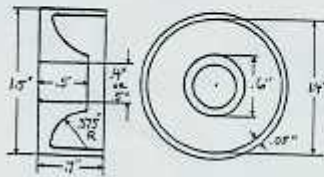

Part #3 - Cover:

This assembly is a removable heat resistant cover made of Nomex firesuit material. In addition to protecting the firer's hand from heat, the cover dampens the resonating or 'ringing' within the silencer during firing. Spring clasp holds the cover in place.

Part #10 - Encapsulator

Each encapsulator is a .4" thick disc, 1 9/16" OD x 20 TPI. The 9mm/380 version is bored to .4" ID and the 45 version to .5" ID. Each encapsulator is drilled to allow installation and removal by spanner wrench.

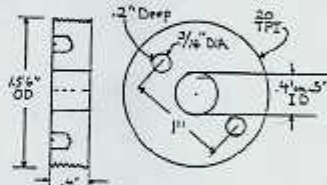

Drill two holes, 3/16" diameter, 1" apart as shown. Install encapsulator at 25 ft/lbs torque.

Part #5 - Threaded/Vented Bushing

All three bushings are .7" thick with center holes threaded 3/4" x 16 TPI to fit the fronts of the inner sleeves. The front shoulders of all three bushings are 1 9/16" OD x 20 TPI to accept the threaded front

tubes. The OD and shoulder cuts for both bushings are the same as their counterpart in parts #1. Each bushing has a series of 3/16" diameter holes to allow movement of gas from the rear to the front chambers. See drawings for specific hole pattern.

M11

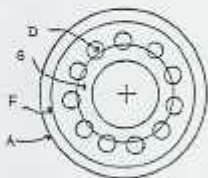
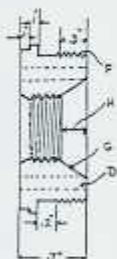
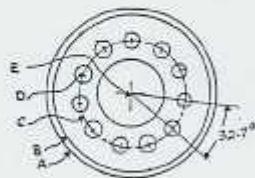

M 11 BUSHING SPECS

- A. 1.75" OD x .1" long
- B. Shoulder 1.62" OD x .1" long
- C. 1.0625" DIA circle
- D. 11 Holes / .1075" DIA

- E. Centerhole 3/8" ID (3/4" x 16 TPI)
- F. 1.56" OD x .3" long (1 9/16" x 20 TPI)
- G. Taper 3/16" inside to 1" outside
- H. Tapered area .25" deep
- I. 1.5" OD x .2" long

M10

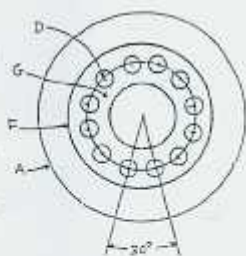
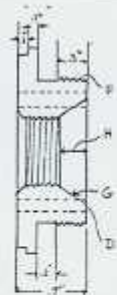
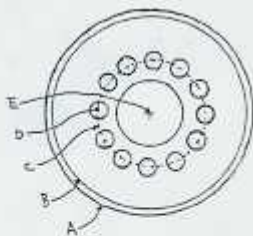

M 10 BUSHING SPECS

- A. 2.13" OD x .1" long
- B. Shoulder 2" OD x .1" long
- C. 1.125" DIA Circle
- D. 12 Holes/.1075" DIA

- E. Centerhole 3/8" ID (3/4" x 16 TPI)
- F. 1.56" OD x .3" long (1 9/16" x 20 TPI)
- G. Taper 3/16" inside to 1" outside
- H. Tapered area .25" deep
- I. 1.5" OD x .2" long

Parts #7 & 8 - Spirals

The spiral baffles are 1.5" OD x 2" long in the M-10 models and 1.5" OD x 1" long for the M-11. Each suppressor uses one left and one right hand twist "spiral". These units are actually helical, as there is no taper along their length. The fins are cut to a depth of .4375" leaving a .625" OD core section. There are four fins per inch, with a .125" space between fins. Four rows of 1/8" diameter holes are drilled in the spaces between the fins. M-10/3mm and M-11 spirals are bored .4" ID. The M-10/45 units are bored to .5" ID.

The preferred method for cutting the helical baffles is to use a milling machine with an indexing head and a 1/8" thick disc cutter. The tangent table angle is set to 87° for proper cutter clearance. Depth of cut is set to .4375". Spiral pitch is .25" (one turn in .25"). Gear change (velocity ratio) is 1/40 for machines with a standard pitch of 10 inches. For other machines, use the following formula:

$$\text{velocity ratio} = \frac{\text{pitch of helix}}{\text{lead of machine}}$$

$$\text{example: (standard machine)} = \frac{.25}{10} = 1/40$$

These units can also be cut by hand. The 1.5" OD round stock should be held in a padded vise during the cutting procedure to avoid damaging the delicate fins.

1. Wrap the 1.5" OD round stock with 1/4" wide masking tape or better yet, two side by side strips of 1/8" automotive pin stripping tape. Start the tape at an angle of 87° as shown (figure one).

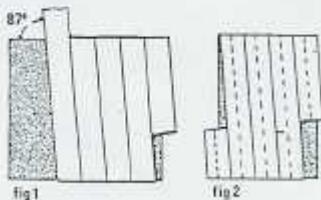

2. Mark along the center of the 1/4" wide tape and cut with a razor blade. (fig. two)

3. Remove one of the continuous 1/8" wide strips. (figure three)

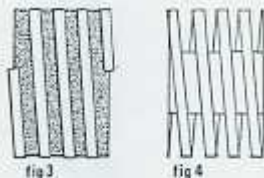

4. Centerpunch and drill a series of 1/8" diameter holes along the entire length of exposed metal. Install a stop on the drill bit to limit hole depth to .4375".

Use a file, Dremel tool or hacksaw to remove the remaining metal between fins. If a hacksaw is used, extend the length of the mount pins and install five blades on the frame. This should cut the correct width slot in one pass. Hacksaw blades are .5" high, so epoxy a .0625" wide strip along the side of the top edge to limit the depth of the cut to .4375". If a niter box is available, set angle to 87°

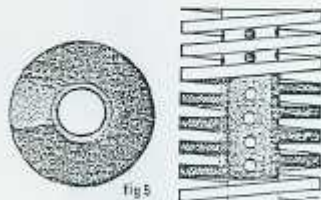

5. Drill 1/8" diameter vent holes and bore the centers as indicated. (fig. five)

Part #4 - Rear Tube

Material is .065" wall aluminum tubing

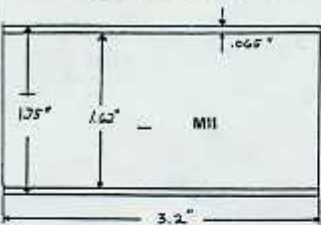

The tube for both models of the M-10 is 2" ID, 2.13" OD and 3.8" long. The M-11 tube is 1.62" ID, 1.75" OD and 3.2" long.

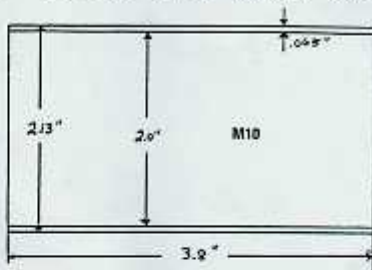

Part #9 - Front Tube

Both M-10 front tubes are 7" long. The length of the M-11 version is 5". All three tubes are 1.74" OD, 1.50" ID. Wall

thickness is .120". The tubes are threaded 1 9/16" x 20 TPI. Threads extend one inch into the rear and two inches into the front of all front tubes.

