DROZD



AIR RIFLE INSTRUCTION MANUAL

European American Armory Corp.
3855 North U.S. Highway One
Cocoa, Florida 32926
(321) 639-4842
www.eaacorp.com
E-mail: eaacorp@eaacorp.com

© Copyright EAA Corp. 12/02

EAA MODEL: Drozd AIR GUN INSTRUCTION MANUAL

WARNING AND INSTRUCTION MANUAL PLEASE READ THESE INSTRUCTIONS

CAUTION: Air Guns are not toys. This Air Gun is **recommended for adult use only**. Misuse or careless use may cause serious injury or death. This Air Gun is dangerous within 500 yards.

Do charge your Air Gun before you read and understand the instructions and warnings contained in this manual.

FOR YOUR SAFETY AND THE SAFETY OF OTHERS, this owner's manual contains important warnings and safety procedures which must be understood BEFORE using this Air Gun. Read the entire manual and if you do not understand any part of it or the operation of your Air Gun, stop and seek professional instructions. You can get a copy of this manual from European American Armory Corp. on request.

Record the serial number of your Air Gun

and a description of it:

Make a copy of this manual, proof of purchase/sales record for safekeeping in a secure safe or fireproof container. Such proof is necessary if the Air Gun is stolen or for warranty repair. Before handling any Air Gun, make sure you know the safety procedures and most importantly, keep the Air Gun pointed in a safe direction.

WARNING

****YOU RISK INJURY OR DEATH BY HANDLING THIS AIR GUN ****

Before handling this Air Gun, read, understand and follow the instructions in this manual. Always keep this manual with the Air Gun. If you lend, give or sell this Air Gun, be sure the manual goes with it. If there is anything you do not understand, seek advice from someone qualified in safe handling of Air Guns.

WARNING

This Air Gun should always be transported unloaded in its case.

10 LIFE SAVING WARNINGS

1. Thinking the Air Gun is unloaded does not mean it is unloaded. If a BB is in the magazine and the Air Gun has a pressurized CO2 cartridge, this Air Gun can be fired. Always treat your Air Gun as if it is loaded.
2. Always point the muzzle of any Air Gun in a safe direction whether the Air Gun is loaded or unloaded...
3. No hands over the muzzle / no way / no time / no how.
4. Only use .177/ 4.5mm BBs manufactured to industry standards. If the BBs do not feed into the magazine, don't force them - there is a reason - determine the reason before continuing.
5. Never alter your Air Gun or allow anyone not connected with or authorized to represent the manufacturer to modify, change, or adjust any of the working parts of your Air Gun .
6. Learn to regularly clean and inspect your Air Gun .
7. Wear eye protection whenever you shoot your Air Gun or when around others using Air Guns. You only get one set of eyes.
8. This Air Gun is extremely powerful and is not designed for the beginner. This class of Air Gun is intended for use by experienced adult shooters.
9. Your Air Gun can not think. You must be alert and thoughtful at all times to insure your safety and the safety of the people and property near you... no drugs... no drinking... no horse play... never shoot a BB at water or a hard surface...

HEALTH WARNING:

This Air Gun fires BBs. Lead and lead compounds are known to the State of California to cause cancer, birth defects and reproductive toxicity. Discharging, handling or cleaning an Air Gun may result in lead exposure. Have adequate ventilation at all times. Do not put BBs in your mouth. Wash hands thoroughly after exposure.

GENERAL INFORMATION:

CALIBER:	.177 / 4.5mm BBs
BARREL LENGTH:	10"
OVERALL LENGTH:	13.75" W/O STOCK 19..5" W/ STOCK
WEIGHT:	3.5LBS
VELOCITY AT MUZZLE:	360FT / SECOND

This is a Air Gun . It is powered by compressed CO2 in the cylinder located in the grip. Avoid leaving the Air Gun with compressed CO2 for extended periods.

EXTERNAL CONTROL PARTS:

1. The **Trigger** is used for discharging the compressed CO2 so as to expel the BB. The trigger in this Air Gun is really a contact switch for an electrical assembly. (See Fig 1)

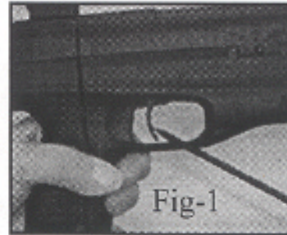

2. The **Barrel** of your Air Gun is made of steel and has groove rifling. Never put the barrel in a position where it could be bent or damaged. A bent barrel will lead to accuracy problems or could even lead to a BB being stuck in the barrel. After shooting, always clean the barrel. (See Fig 2)

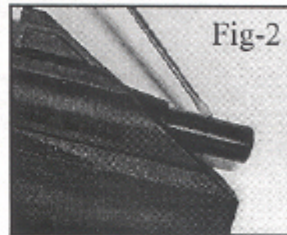

3. The **Sights** on your Air Gun are designed for accuracy. The rear sight has a screw in the top that controls elevation, you may remove the sight and install a scope ring that is made clamp a 11mm rail. (See Fig 3)

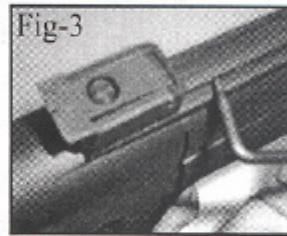

4. The **Magazine** is located inside the grip and is released with the magazine release, capacity one CO2 cylinder and 30 BBs. (See Fig 4)

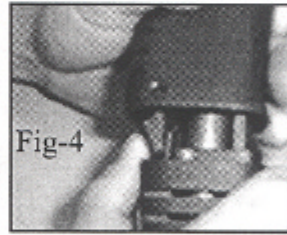

5. The **CO2 Cylinder** is located in the magazine and is used to pressurize the Air Gun. (See Fig 5)

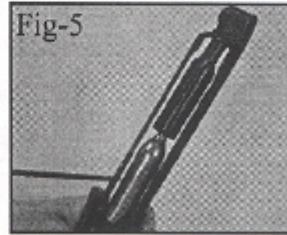

6. The **On / Off Switch** is located on the left hand side of the frame and moves up and down. In the down position the firing system has been energized and the LED is illuminated. Do not leave the on / off switch in the on position unless you are ready to fire the Air Gun or are firing the Air Gun. When the switch is off the power is removed from the firing system and the LED is no longer illuminated. Since the Drozd has an electrical firing system the on / off switch acts as a safety. Switch on or firing system energized, the Air Gun is in the fire mode. Switch off or firing system not energized, Air Gun is in the safe mode.... It is good Air Gun safety procedure to never relay on any mechanical or electrical safety, so we recommend to remove the magazine when you are not using or ready to fire the Air Gun. (See Fig 6)

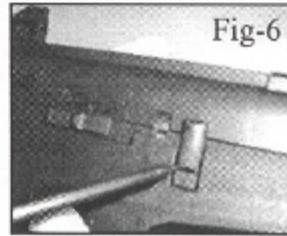

7. The **BB Loading Pusher** located on the front side of the magazine moves back / down to load BBs and returns by spring pressure upward. (See Fig 7)

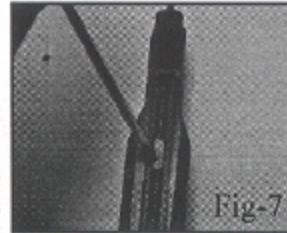

8. The **Magazine Release** located on the bottom back of the grip and pushed in will release the magazine. Warning: the Drozd magazine is heavy so have your hand on it while pushing the magazine release. We recommend that you grip the lower portion of the magazine and depress the magazine release with your thumb. (See Fig 8)

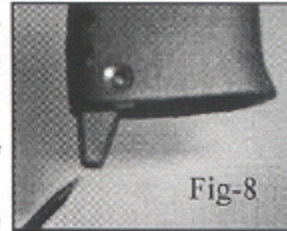

9. The **Selector for Fire Switch** is located forward of the On / Off switch on the left hand side of the Drozd. The switch moves fore and aft and has three positions. Aligning the switch to position marked one is for single round fire, aligning the switch to the position marked three is for three round burst and aligning the switch to the position marked six is for six round burst. Depending on what position you set your selector for fire to, will determine how many BBs will be release when the trigger is pulled and held for a full cycle and the on / off is in the on position. Thus, if you pull the trigger and the selector for fire is set at six the Drozd Air Gun will fire six BBs. If you do not hold the trigger down for the all six BBs to be fired the firing will stop when the trigger is release. Once the trigger is released the selection of fire will reset back to what ever number the selector for fire switch is set to. Thus, If the selector for fire switch is set at six and you held the trigger long enough for four BBs to be fired and then you released the trigger and then pulled the trigger again, up to six BBs would be fired depending on how long you held the trigger to the rearward position. (See Fig 9)

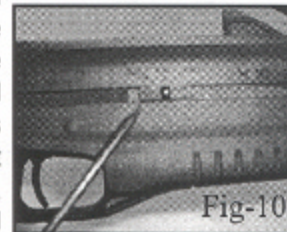
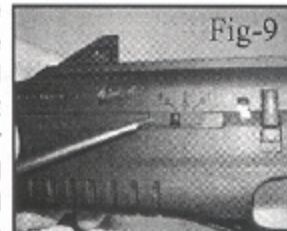

10. The **Cycle Speed Switch** is located on the right hand side of the Drozd and determines how fast the Air Gun will cycle. If the switch is set at 300 the Air Gun will cycle at 300 BBs per minute, 450 would be 450 BBs per minute and 600 would be 600BBs per minute. (See Fig 10)

-- WARNINGS --
READING THESE SAFETY RULES WILL SAVE YOUR LIFE
OR THE LIFE OF SOMEONE ELSE

11. Your Drozd has a **BATTERY LOADING AREA / COVER**. It has an orange cover that slides down (away from the barrel) and then pivots up (away from the front of the Air Gun). The Air Gun requires six AA batteries, three facing into the Air Gun (Positive side in) and three facing out of the Air Gun (Positive side out). The batteries that face out of the Drozd are on the side which has the On / Off switch. Thus, the batteries that face into the Drozd are on the cycle seed side. (See Fig 11, 11a, 11b)



12. BUTT STOCK is removal-able and fits into the back of the receiver of the Air Gun. The Butt Stock is to be pushed into place by inserting the end that matches the hole in the holes in the back of the receiver. To remove the Butt Stock just pull the stock away from the receiver. Your Air Gun will work with or without the Butt Stock. (See Fig 12)

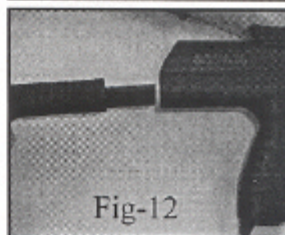

CHARGING/ PRESSURIZING YOUR AIR GUN:

A. Make sure that the Air Gun is pointed in a safe direction and the on / off switch is on off and your fingers are away from the trigger. Remove the magazine by depressing magazine release and removing the magazine in a down ward direction. See (Fig 13)



B. **Warning:** Before you preform this step make sure that if there is a CO2 cylinder in the magazine that all the pressure has been released, please wear eye protection during this operation. If pressure is not completely release and the pressure remaining in the cylinder is not strong enough for the BBs to be accurate, then you must fire the pistol until there is no more pressure in the cylinder.... We suggest you fire the air gun without BBs until all pressure is dispensed from the CO2 cylinder . At the bottom of the magazine you will find that a plastic cover is over the lower portion of the magazine. This cover pivots about a pin and swings down to fully reveal the cylinder locking lever. Swing down the plastic magazine extension cover and then slowly swing down the cylinder locking lever..... Warning if all the pressure has not been release from the CO2 cylinder then gas pressure will be released at the top of the cylinder and could freeze objects in the way of the gas during it's release or expel objects in it's path or the rubber seal in the magazine may be

damaged... (at the end of the cylinder locking lever's free travel there is a safety area that requires force to move the cylinder locking lever down, do not move the lever into the safety area until you are sure there is no pressure in the cylinder... the safety area is when the lever is moved passed the perpendicular point in relation to the magazine body) (See Fig 14)

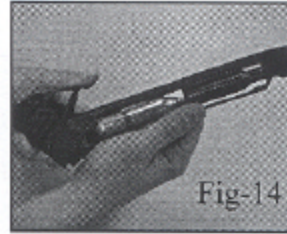

C. Once you are sure there is no pressure in the cylinder, move the cylinder locking lever fully into the safety area until it will not move any more. This will allow the CO2 cylinder to be removed from the left hand side of the magazine. With the cylinder removed inspect the o-ring that is in the gas chamber which is at the top of the magazine, make sure the o-ring is not deformed (if it is replace it). (See Fig 15 & 16)

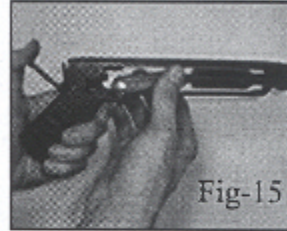

D. Take a new cylinder and inset the neck into the gas chamber and align the round base with the cylinder holding base, the cylinder must be put in from the left hand side of the magazine and must be pushed in so that it hits the stop on the right hand side of the magazine. Now move the magazine away from your body and face, then move the cylinder locking lever up so that it is parallel to the magazine and stops its movement on the magazine body. You should hear the sound of the CO2 gas moving into the gas chamber.... make certain there are no leaks between the cylinder mouth and the o ring seal. Warning... Be careful during this step because pressure will leak out when the metal tube breaks the seal on the cylinder surface. **We suggest you wear eye protection during this operation .** (See Fig 15 & 17)

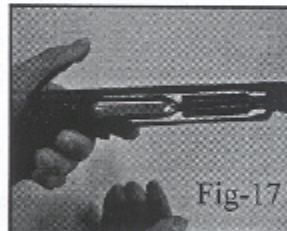
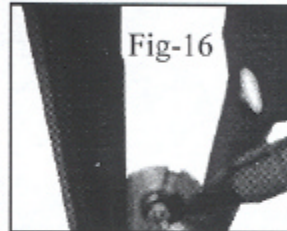

E. Re-insert the magazine into the Air Gun when you are ready to fire. (See Fig 18)

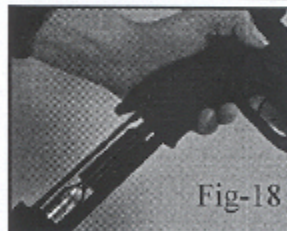

WARNING - IF THERE IS NOT ENOUGH PRESSURE TO EXPEL THE BBs THEN YOU MUST REPLACE THE CO2 CYLINDER BEFORE TRYING TO FIRE THE GUN WITH BBs..... YOU DO NOT WANT TO HAVE BBs STUCK IN THE BARREL DUE TO LACK OF PRESSURE TO EXPEL THEM....

-- WARNINGS --
**READING THESE SAFETY RULES WILL SAVE YOUR LIFE
OR THE LIFE OF SOMEONE ELSE
LOADING YOUR AIR GUN:**

A) Make sure that the Air Gun is pointed in a safe direction and the on / off switch is off and your hand and fingers are away from the trigger.

B) Make sure there are six batteries in the Air Gun and that they are charged.

C) Remove the magazine if it is not already removed

D) Move the BB loading pusher to the bottom of the magazine. Hold the pusher down and load up to 30 BBs in the magazine via the round hole on the front side of the top of the magazine and then release the pusher. (See Fig 19)

E) Reinsert the magazine only when you are ready to fire. Make sure you have inserted the magazine into the Air Gun so that until the magazine release locks the magazine in place. (See Fig 20)

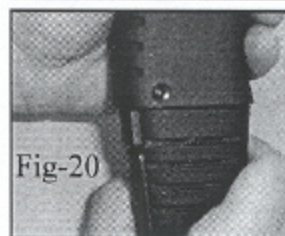
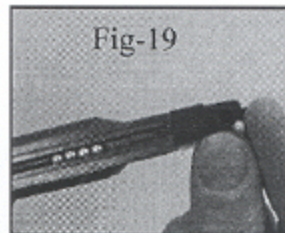

FIRING THE AIR GUN:

After completing the above loading step make sure that the Air Gun is pointed at what you intend to shoot then turn A) set the Select for Fire Switch to the number of rounds you wish dispersed per trigger pull B) Set the Cycle Speed Switch to the number of rounds you wish to fire per minute C) turn the On / Off switch to on and slowly pull the trigger to the rear. The Air Gun will discharge the desired number of BBs from the barrel as long as there is enough pressure in the CO2 cylinder. If you wish to fire another round of BBs pull the trigger again until all the BBs have been used up in the magazine.

UNLOADING YOUR AIR GUN:

IF YOU HAVE LOADED YOUR AIR GUN and you wish to unload the Air Gun. Make sure the Air Gun is pointed in a safe direction, turn off the On / Off and then remove the magazine. Slide the BB Pusher down and turn the magazine up side down and shake all the BBs out of the magazine. Make sure that all BBs have been removed from the magazine and do not reinstall the magazine until you are ready to reload and fire the Air Gun. (See Fig 21)



Caution: Never fire damaged or used BBs.

Caution: Use only factory new Air Gun BBs. Use only the correct size BBs (.177 / 4.5mm caliber). Do not use steel shot or darts which may damage the Air Gun bore and which cause greater re-bounce and ricochet.

-- WARNINGS --
READING THESE SAFETY RULES WILL SAVE YOUR LIFE
OR THE LIFE OF SOMEONE ELSE

Learn how to handle, load, unload, operate, fire and care for your Air Gun .

NEVER PLAY with your Air Gun . It is a potentially dangerous weapon that can cause serious personal injury or death.

Always keep the Air Gun pointed in a safe direction. NEVER point any weapon (loaded or unloaded) at any person or anything you do not intend to shoot.

Always keep your Air Gun unloaded until ready to fire and make sure that it is unloaded before cleaning.

Keep your finger OFF the trigger until you are actually aiming at the target and ready to shoot.

Never rely on a Air Gun's "On / Off Switch - safety" to protect you from unsafe handling. A safety is only a mechanical device, not a substitute for common sense and good safety procedures.

Never leave a Air Gun unattended or where it could fall and fire.

If an Air Gun is hit sharply or dropped, damage to the internal precision mechanism may result and consequently an accidental firing.

Store Air Guns and BBs separately **beyond the reach of children**. Make sure the Air Gun and BBs are properly locked and secured so children and un-trained individuals will be denied access.

Test your Air Gun's operation ONLY at a shooting location while the Air Gun barrel is pointed in a safe direction.

Know your target and what is beyond. Ask yourself what your BB will hit if it misses the target or passes through the intended target. Remember, a fired BB can travel over 400 yards (including a ricochet).

Never pull an Air Gun toward you by the muzzle. Don't climb a tree, cross a ditch or fence with a loaded Air Gun .

Do NOT leave your Air Gun PRESSURIZED for long periods of time or store pressurized.

Always empty Air Guns before entering a house, car, truck, boat, RV, camp or any building.

When receiving a Air Gun, always open the action and make sure it is unloaded. NEVER accept anyone's word that an Air Gun is "unloaded" or "empty". You should also inspect it by passing a cleaning rod through the bore to make sure it is clear.

Avoid exposure to lead by firing where there is adequate ventilation. After cleaning your Air Gun and/or handling BBs, wash your hands.

Keep Air Guns unloaded when not actually in use. Load the Air Gun only when preparing to fire.

Never fire a BB to clear a barrel.

ALWAYS WEAR protective shooting glasses when firing Air Guns.

Never drop your Air Gun. If you do drop it, unload it and check it for proper function before using it again.

Don't alter or modify your Air Gun .

Do not remove any internal safety or safety device on the Air Gun . Safety mechanisms are designed to protect you from injury or death.

Do maintain and keep your Air Gun clean. Keep in a dry place away from other metals and water. If your Air Gun shows sign of corrosion or improper operation, have it serviced by a competent gunsmith.

Keep the muzzle pointed in a safe direction when loading and unloading your Air Gun. Never point the muzzle at any person or any animal.

Never shoot at hard flat surfaces or water.... bullets ricochet.

Never let water, snow, mud or other material enter the barrel. Keep the barrel free of any obstruction.

Use only the correct size BBs for your Air Gun . Do NOT use steel shot or darts.

Teach children NOT to touch an Air Gun or BBs.

Remember an Air Gun has the capability of taking your life or the life of someone else. Be careful with your Air Gun -- an accident is almost always the result of not following basic safety rules.

WRITE US concerning any items or circumstances which you don't understand and which might relate to your safety and the operation of your Air Gun .

CARE AND PROBLEMS:

Caution: It is better to under lubricate than to over lubricate. Only use high flash point lubricants. Do not use firearms cleaners or low flash point lubricants. Every 700 rounds put no more than one drop of oil on the BB loading pusher. Do not lubricate any other area of the air gun.

Caution: Clean Battery contacts every battery change.

Caution: Failure to release all pressure in the CO2 cartridge before removing the CO2 cylinder could damage the seal between the CO2 cylinder and the gas expansion chamber.

Problems:

1) If a new CO2 cylinder is installed and there is a leak between the cylinder and gas chamber there are two possible reasons: A) The seal between the CO2 cylinder and gas expansion chamber must be replaced (Part Number 52). Or B) If the seal is not damaged then the square lifting block (Part Number 62) that is below the CO2 cylinder and pushes the CO2 cylinder up, needs to be adjusted up. Do not adjust this block by yourself. Take the magazine to you local gunsmith and have them adjust the block. There is a pin in the magazine that prevents the block from rotating. This pin must be removed and then the block is unscrewed (turned counter clockwise) so as to increase pressure on the cylinder in the locked position. Before inserting the pin back into the magazine make sure that when the cylinder locking lever is in the released position the CO2 cylinder can be removed. (See Page 15 Diagram B)

2) Power is turned on, led does not light up. A) Make sure batteries are installed correct Or B) Replace all batteries.... Make sure Power is turned off after each use. Always clean battery contacts when replacing batteries, use pencil eraser to clean contacts. (See Page 13)

3) Magazine Leaks: If the CO2 is leaking from the top of the magazine you will need to replace seals 38 and 39 and 41. Take the magazine to your local gunsmith and have them preform the work. (See Page 15 Diagram A)

4) Magazine Leaks: If the CO2 is leaking from the Gas expansion area (Part Number 46) Replace seal 45 and 49. (See Page 15 Diagram A)

5) CO2 does not flow easy and you have replaced the CO2 cylinder with a new cylinder, check filter (Part number 48) or check to see that the needle or puncture tube is not damaged. (See Page 15 Diagram A)

LIMITED REPAIR WARRANTY

European American Armory Corp. Air Guns are warranted to the original retail customer for 90 days from date of purchase against factory defects in metal parts. All metal parts and labor or replacement **at our option** are covered. Seals are warranted to the original retail customer for a period of 30 days from the verified purchase date against defects. Parts and labor to repair seals will be provided for 30 days from the verified purchase date.

Evidence of proof of purchase is necessary for all warranty repair service. Transportation to and from our repair facilities, governmental fees, damage caused by failure to perform normal maintenance, sales outside the United States, damage due to non factory BBs, steel shot or darts, or any unauthorized repair, modification, misuse, abuse, or alteration of the product is not covered by this Limited Repair Warranty.

Any implied warranties, including the implied warranties of merchantability and fitness for a particular purpose, are limited to 90 Days from date of original retail purchase. Consequential or incidental damages and/or expenses, or any other expenses are not covered by this warranty.

To obtain warranty performance send your product with proof of retail purchase, freight prepaid to:

European American Armory Corp.
3855 North U.S. Highway One
Cocoa, Florida 32926

Note: It is a violation of federal law to ship a loaded weapon.

WARNING

Altering or modifying parts is dangerous and will void the warranty. This Air Gun was manufactured to perform properly with the original parts as designed. It is your duty to make sure any parts you buy are made for this Air Gun and are installed correctly and that neither the replacements nor originals are altered or changed. Your Air Gun is a complex precision tool with many parts that must relate correctly to other parts in order for proper and safe operation. Putting an Air Gun together wrong or with incorrect or modified parts can result in a damaged Air Gun, serious injury or death to you and others through malfunction. Always have a qualified gunsmith work on your Air Gun or at least check any work not performed by a gunsmith.

PARTS ORDERS

ALL PARTS ORDERS ARE SUBJECT TO A \$10.00 CHARGE FOR SHIPPING AND HANDLING. For parts and service contact: European American Armory Corp., 3855 North U.S. Highway One, Cocoa, Florida 32926 Phone: (321) 639-4842.

STATEMENT OF NON-LIABILITY

Air Guns are not classified as firearms by the U.S. Gun Control Act of 1968. Air Guns are not generally considered to be weapons; however, they can cause serious injury, death and property damage. Thus, they should be handled with great care. Safety is your responsibility. Neither the manufacturer, nor European American Armory Corporation, assume any responsibility for personal injury, death or property damage resulting from either intentional or accidental discharge or for the function of any air rifle subjected to influences beyond our control.

KEEP THIS BOOKLET AND PROOF OF PURCHASE IN A SECURE LOCATION.

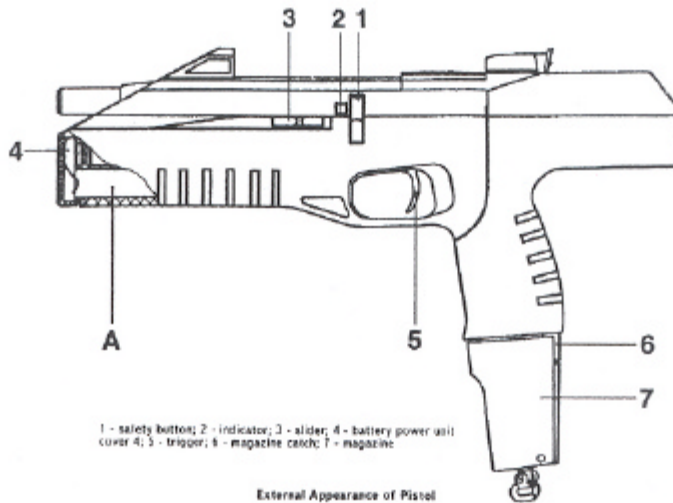

FRONT OF GUN

ON / OFF
SWITCH SIDE

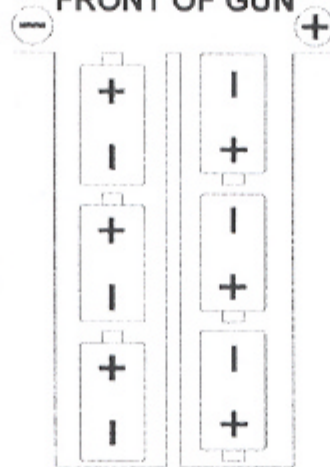

CYCLE
SPEED SIDE

Layout of batteries

REVISED BATTERY CONFIGURATION

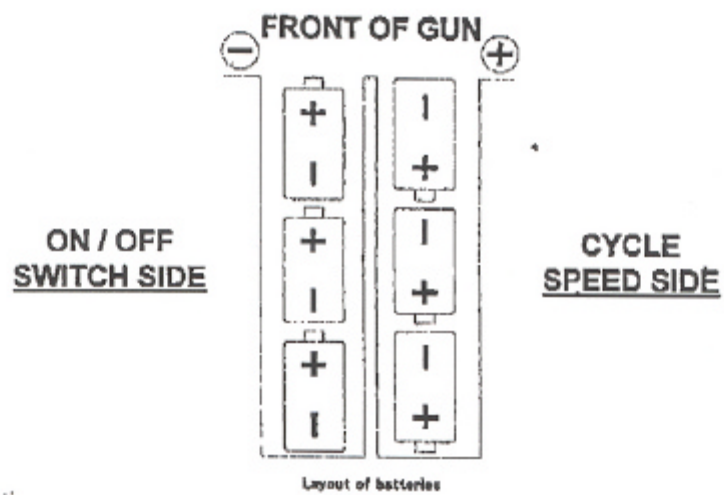

Exploded View DROZD

NOTICE: When ordering parts, must specify caliber.

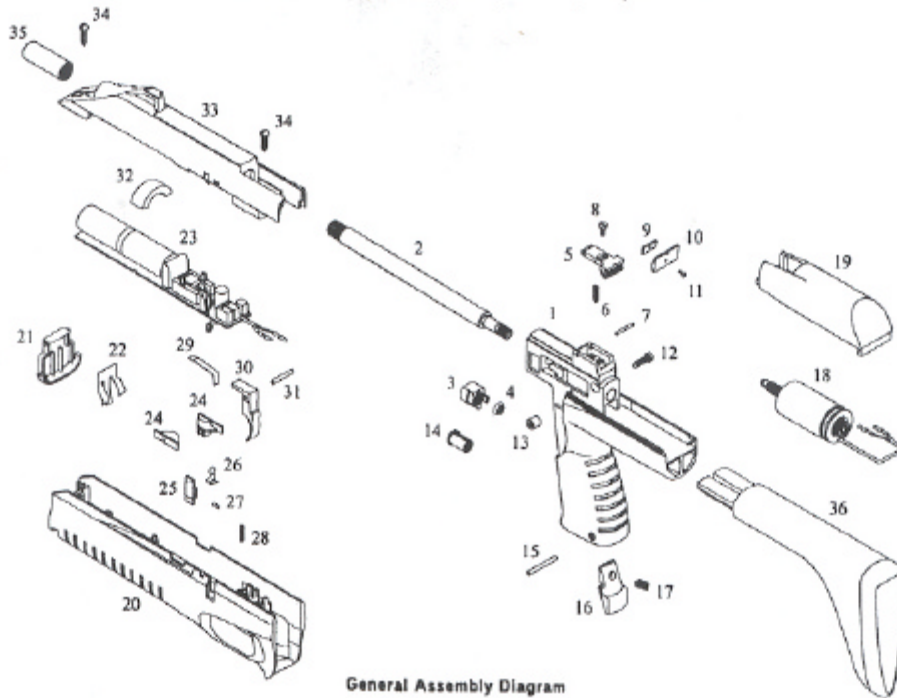

General Assembly Diagram

List of DROZD Components

NOTE. HAVING AN ASTERISK "*" ARE NOT SUBJECT TO ORDER

- | | | |
|----------------------|---------------------------|-------------------|
| 1. Frame* | 13. Nut | 25. Button |
| 2. Barrel | 14. Insert | 26. Safety Spring |
| 3. Bushing | 15. Pin | 27. Pin |
| 4. Barrel Gasket | 16. Catch | 28. Ring Spring |
| 5. Sight leaf | 17. Spring | 29. Clamp |
| 6. Spring | 18. Electromagnet | 30. Trigger |
| 7. Pin | 19. Electromagnet Cover | 31. Pin |
| 8. Screw | 20. Housing | 32. Gasket |
| 9. Plate | 21. Cover | 33. Slide |
| 10. Rear Sight Blade | 22. Spring Contact | 34. Screw |
| 11. Screw | 23. Electronic Unit Board | 35. Muzzle Device |
| 12. Screw | 24. Slider | 36. Shoulder Rest |

Exploded View DROZD MAGAZINE

NOTICE: When ordering parts, must specify caliber.

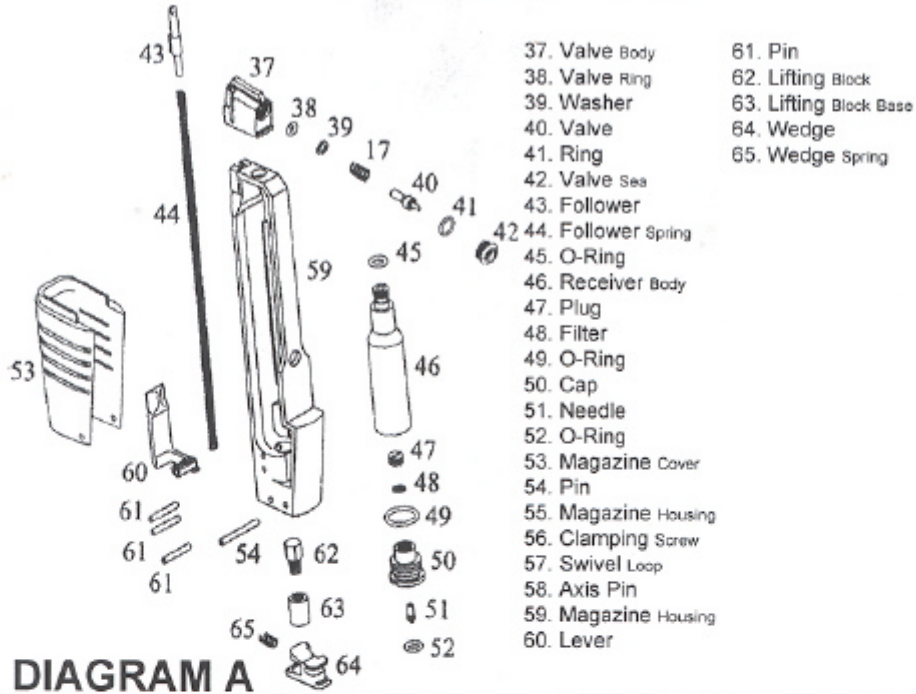
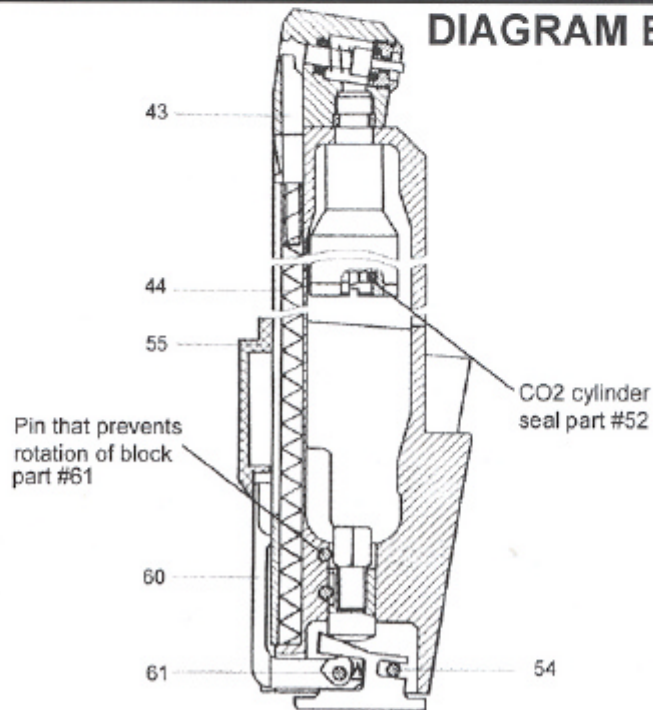

DIAGRAM A

DIAGRAM B

- 43. Follower
- 44. Follower Spring
- 54. Pin
- 55. Magazine Cover
- 60. Lever
- 61. Pin



 **WARNING**

Children are attracted to and can operate firearms that can cause severe injuries or death.

Prevent child access by always keeping guns locked away and unloaded when not in use. If you keep a loaded firearm where a child obtains and improperly uses it, you may be fined or sent to prison.

 **ADVERTENCIA**

A los niños les atraen las armas de fuego y los pueden hacer funcionar. Ellos pueden causarse lesiones graves y la muerte.

Evite que los niños tengan acceso a las armas de fuego guardándolas siempre con llave y descargadas cuando no las esté utilizando. Si usted tiene un arma de fuego cargada en un lugar en que un niño tiene acceso a ella y la usa indebidamente. Le pueden dar una multa o enviarlo a la cárcel.

Importer:

European American Armory Corp.
3855 North US. Hwy. 1
Cocoa, FL 32926

Manufacturer:

Izhevsky Mekhanichesky Zavod
8, Promyshlennaya Str.
Izhevsk, Russia 426063