EAA MODEL MP153 SEMI-AUTO SHOTGUN



WARNINGS AND INSTRUCTION MANUAL

**European American Armory Corp.
3855 North U.S. Highway 1
Cocoa, Florida 32926
(321) 639-4842
www.eaacorp.com
E-mail: eaacorp@eaacorp.com**

© Copyright 2004

EAA MODEL: MP153 SEMI-AUTO SHOTGUN

WARNINGS AND INSTRUCTION MANUAL PLEASE READ THESE INSTRUCTIONS

MODEL NUMBER	BARREL LENGTHS	GAUGE/SIZES
MP153	20", 24", 26", 28", 30"	12 / 2.75", 3", and 3.5"
	TYPE	FINISH
	SEMI-AUTO SHOTGUN	BLUE

GENERAL INFORMATION:

Weight (average) - 28" = 8.5 Lbs

Overall Length - 41" to 52"

FOR YOUR SAFETY AND THE SAFETY OF OTHERS, this owner's manual contains important warnings, instructions and safety procedures which must be understood **BEFORE** using this firearm. Read the **ENTIRE MANUAL** and if you do not understand any part of it or the operation of your shotgun, stop and seek professional firearms instructions. You can get a copy of this manual from European American Armory Corp. upon request.

Record the serial number of your firearm (located on the left bottom side of the receiver):

and a description of it:

Make a copy of this manual, proof of purchase/sales record for safekeeping in a secure safe or fireproof container. Such proof is necessary if the firearm is damaged, stolen or sent in for warranty repair.

 **WARNING**

****YOU RISK PERSONAL INJURY OR DEATH BY HANDLING THIS FIREARM****

Before handling any firearm, make sure you know the safety procedures and most importantly, keep the firearm pointed in a safe direction.

Before handling this firearm, read, understand and follow the instructions in this manual. Always keep this manual with the firearm. If you lend, give or sell this firearm, be sure the manual goes with it. If there is anything you do not understand, seek advice from someone qualified in safe handling of firearms. You must **ALWAYS** obey the following warnings, instructions and safety procedures:

1. Always keep the muzzle pointed in a safe direction.
2. Firearms should be unloaded and secured when not actually in use.
3. Don't rely on your firearm's safety.
4. Be sure of your target and what's beyond it.
5. Use only proper ammunition matching the precise gauge of your specific shotgun.
6. If your shotgun fails to fire when the trigger is pulled, handle with care.
7. Always wear ear and eye protection when shooting.
8. Be sure the barrel is clear of obstructions before shooting.
9. Don't alter or modify your firearm and have it serviced regularly.
10. Learn the mechanical and handling characteristics of your shotgun.
11. Shoot sober!

Type Of Ammunition To Be Used

It is suggested that high quality commercially manufactured ammunition be used in this firearm. Avoid military surplus or old ammunition as it may not fire with sufficient force to expel the projectile or wad from the barrel. **The use of reloaded, high pressure or hand-loaded ammunition can be dangerous and will void the warranty.**

LEAD WARNING: The actual firearm does not contain any lead; however, it does fire ammunition which contains lead or lead compounds known to the State of California to cause cancer, birth defects, reproductive toxicity, and other serious physical injury. Those who discharge a firearm, stand near someone who discharges a firearm or clean firearms are hereby warned of the dangers presented by lead and lead compounds and should take protective health measures. Avoid exposure to lead while handling and wash your hands after contact. Proper air ventilation is absolutely necessary when shooting indoors.

N O T I C E

SEMI-AUTO SHOTGUNS ARE CLASSIFIED AS FIREARMS OR DANGEROUS WEAPONS and are sold by European American Armory Corp. with the specific understanding that we are not responsible in any manner whatsoever for their safe handling or resale under local laws and regulations.

European American Armory Corp. shall not be responsible in any manner whatsoever for malfunctioning of the firearm, for physical injury or for property damage resulting in whole or in part from **(1)** intentional or negligent discharge, **(2)** improper or careless handling, **(3)** unauthorized modification and/or alteration of the internal/safety mechanisms, **(4)** defective, improper, high pressure, hand-loaded, or reloaded ammunition, **(5)** corrosion and/or lack of proper maintenance, **(6)** neglect, or **(7)** other influences beyond our direct and immediate control. This limitation applies regardless of whether liability is asserted on the basis of contract, negligence or strict liability (including any failure to warn). Under no circumstance shall European American Armory Corp. be liable for incidental or consequential damages, such as loss of use of property, commercial loss and loss of earnings or profits.

FOLLOWING THESE SAFETY RULES CAN SAVE YOUR LIFE OR THE LIFE OF SOMEONE ELSE

Get competent firearms instruction in safe handling before using this firearm. Please ask your dealer for names of qualified instructors near you. All guns are extremely dangerous if carelessly handled or used. Remember that the firearm user is the primary “safety” and that reliance on any mechanical safety device should never replace safe handling procedures.

This firearm **WILL FIRE** if a shell is in the chamber and the trigger is pulled while the safety is disengaged.

DO NOT LOAD THIS SEMI-AUTO SHOTGUN UNTIL YOU UNDERSTAND HOW IT OPERATES. KEEP this semi-auto shotgun unloaded at all times except when you are ready to fire and are sure of your target.

ALWAYS carry this semi-auto shotgun in a case or original box unloaded.

NEVER point this semi-auto shotgun at anything that is not your intended target even if the semi-auto shotgun is unloaded. When loading, unloading, cleaning or handling, always be sure the muzzle is pointed in a safe direction and always keep your finger off the trigger.

NEVER assume any gun is unloaded. Before handling, check to make sure the chamber is empty. See Unloading Instructions. Make sure you know that this or any firearm is fully unloaded before displaying or handling it. When handling any firearm, keep your fingers away from the trigger at all times until you intend to fire.

Get instructions from a competent firearms instructor before using this or any firearm. Learn from a professional how to handle, load, unload, operate, fire and care for your gun.

NEVER PLAY with your firearm. It is not a toy and can be a very dangerous weapon that can cause serious personal injury or death.

Always keep the gun pointed in a safe direction. Treat every gun as if it is loaded...all the time. **NEVER** point any firearm (loaded or unloaded) at any person or anything you do not intend to shoot. Always keep your gun unloaded until ready to use and make sure that it is unloaded before cleaning.

Keep your finger **OFF** the trigger until you are actually aiming at the target and ready to shoot. Learn to rest your finger outside of the trigger guard.

Never rely on a gun’s “safety” to protect you from unsafe gun handling. A safety is only a mechanical device, not a substitute for using common sense and following gun safety procedures.

FOLLOWING THESE SAFETY RULES CAN SAVE YOUR LIFE OR THE LIFE OF SOMEONE ELSE

Never leave a gun unattended or where it could fall.

Store guns and ammunition separately **beyond the reach of children**. Make sure that they are properly secured so untrained individuals and children will be denied access to your guns and ammunition.

Test your gun's operation and safeties only at a shooting range while the firearm is pointed in a safe direction.

Know your target and what is beyond. Ask yourself what your projectile will hit if it misses the target or passes through the intended target. Remember, a fired projectile can travel over a mile (including a ricochet) and is capable of going through walls. Never shoot at hard flat surfaces or water. . . shot will ricochet.

Guns and alcohol or drugs do not mix. Don't take any alcoholic beverages and/or drugs before or during shooting activities.

Never pull a gun toward you by the muzzle. Don't climb a tree, cross a ditch or fence with a loaded gun.

Always empty guns before entering a house, car, truck, boat, RV, camp or any building.

When receiving a gun, always open the action and check to make sure the chamber is unloaded.

NEVER accept anyone's word that a gun is "unloaded" or "empty." You should immediately open the action and check to make sure it is unloaded.

Be careful with **ALL** ammunition. Even "blank" cartridges are deadly at close range due to the muzzle blast. Make sure your ammunition is new and in good clean condition. Do **NOT** oil or grease ammunition as this may damage the cartridge primer. Do **NOT** tamper with or alter the standard factory ammunition.

Keep firearms unloaded when not actually in use. Load the gun only when on the range preparing to fire and unload it before leaving the range.

Never put your hand over the muzzle of a gun.

ALWAYS WEAR protective shooting glasses and hearing protection when using firearms.

FOLLOWING THESE SAFETY RULES CAN SAVE YOUR LIFE OR THE LIFE OF SOMEONE ELSE

Spectators should be at least 10 feet behind and away from the shooter while the shooter is loading, shooting and unloading. Spectators should wear ear and eye protection and they should avoid distracting those shooting their firearms.

Never drop your gun. If you do drop it, unload it and check it for proper function before using it again.

Do **NOT** alter or modify your gun. Don't try to change your gun's trigger pull, because it may affect sear engagement and thereby cause accidental firing.

Do **NOT** remove any internal safety or safety device on the firearm. Safety mechanisms are designed to help protect you from injury or death.

Properly maintain and keep your gun clean. Keep in a dry place away from other metals and water. If your gun shows sign of corrosion or improper operation, have it serviced by a competent gunsmith.

Keep the muzzle pointed in a safe direction when loading and unloading your gun. Never point the muzzle at anyone.

If a gun fails to fire when the trigger is pulled, keep it pointed down range at the target for 60 seconds. Sometimes slow primer ignition may cause a delay in full ignition of a cartridge. If after 60 seconds the cartridge does not fire, keep the muzzle pointed in safe direction and avoid exposure to the breech, as you attempt to unload your firearm.

Never let water, snow, mud or other material enter the barrel. Always be sure the barrel is free of any obstruction.

Since many ammunition identifications sound similar, be sure that you use only the correct ammunition for your gun. Do **NOT** use the wrong size or wrong strength ammunition in your firearm.

Teach children: 1. **NOT** to touch guns, bullets, cartridges, shells, flares or any explosive device and 2. That if they discovery such a dangerous item or weapon, they must immediately report its location to their parents, school teacher or police.

Remember a firearm has the capability of taking your life or the life of someone else. Be careful with your firearm — an accident is almost always the result of not following basic safety rules.

Use the Security Lock Provided with your Semi-auto shotgun

This semi-auto shotgun comes with a security lock to assist in protecting against unauthorized use. See **Figure 1**. The semi-auto shotgun must be unloaded when the security lock is in place. **WARNING:** Using the security lock cannot substitute for securing your firearm and ammunition in separate, locked locations.

The security lock operates as follows:

1. To open the Trigger Lock put the Key into the notches of the Trigger Lock Nut and unscrew it counter-clockwise. See **Figure 2**. Remove the Trigger Lock Screw.



Figure 1

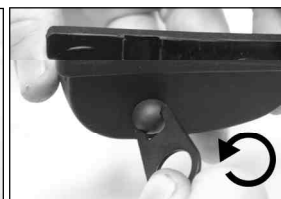

Figure 2

2. To install the Trigger Lock on a semi-auto shotgun put the Trigger Lock over the trigger guard with the smaller end of the Trigger Lock shroud pointing toward the muzzle. Then place the Trigger Lock Screw through the cross-slotted hole on the side of the Trigger Lock shroud. See **Figures 3a, 3b**.



Figure 3a



Figure 3b

3. Screw the Trigger Lock Nut on the Trigger Lock Screw (clockwise) and tighten the nut with the key. **DO NOT TIGHTEN THE NUT TOO TIGHT OR YOU COULD DAMAGE THE LOCK SCREW.** See **Figure 4**.



Figure 4

4. To remove the Trigger Lock, unscrew the Trigger Lock Nut counter-clockwise with the key and detach the Trigger Lock Screw. See **Figure 5**.

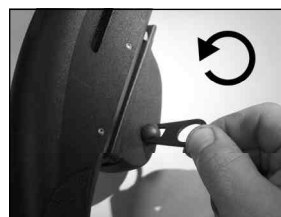

Figure 5

****WARNING****

Always store the key to the security lock: (1) in a separate location away from the semi-auto shotgun; (2) in a secure location unknown and not accessible to others, especially children. Whether you secure your firearms by using the supplied security lock, a gun lock or safe or some other mechanism, it is **YOUR RESPONSIBILITY** to store your firearms in such a manner that children and other unauthorized persons cannot gain access to them.

USED FIREARMS - Firearms are sometimes altered to work incorrectly, or parts may be removed, lost or replaced with incorrect parts. If you got your European American Armory Corp. firearm as a used gun, **BEFORE USING IT** you should take it to a good gunsmith who knows European American Armory Corp. firearms, and have him examine it.

WRITE EUROPEAN AMERICAN ARMORY CORP. concerning any items or circumstances which you don't understand and which might relate to your safety and the operation of your firearm at: European American Armory Corp., 402 Richard Road, Rockledge, Florida 32955 (321) 639-4842.

 **W A R N I N G (POTENTIAL OBSTRUCTIONS)**

BEFORE LOADING or firing a semi-auto shotgun, examine the bore and the firing chamber to be certain they are clean and free of any obstruction. Even a heavy coat of oil, grease, snow or water may result in damage to the firearm and injury to the shooter and/or persons near the firearm. A misfire or unusual sound upon firing is a signal to cease firing and to examine the chamber and bore. If there is any obstruction, clear the obstruction and clean the bore and chamber before firing.

Any bore obstruction, even if it is only partly blocked, may cause the gun to blow up if it is fired, or may cause damage to the gun such as a bulged barrel. To avoid injury or death to the shooter or bystanders, check the barrel before shooting or if a shot does not sound normal.

 **W A R N I N G**

Always keep the muzzle pointed in a safe direction! Never attempt to load or unload any firearm inside a vehicle, building or other confined space (except a properly constructed shooting range). Enclosed areas frequently offer no completely safe direction in which to point the firearm. If an accidental discharge occurs, there is great risk of death, personal injury or property damage. Before loading, always clean all, grease and oil from the bore and chamber, and check to be certain that no obstruction is in the barrel. Any foreign matter in the barrel could result in a bulged or burst barrel or other damage to the firearm and could cause serious injury to the shooter or to others.

 **W A R N I N G**

If there is any reason to suspect that a projectile or any other object is obstructing the barrel, immediately unload the firearm (See Unloading Instructions) and check the chamber and the bore. A wad, shot or some other matter that may be lodged some distance down the barrel where it can not easily be seen. Check the bore by using a cleaning rod to pass through the barrel. If a blockage is in the bore, **DO NOT ATTEMPT TO SHOOT IT OUT WITH ANOTHER CARTRIDGE, OR BLOW IT OUT WITH A BLANK CARTRIDGE OR A CARTRIDGE FROM WHICH THE SHOT HAS BEEN REMOVED. SUCH TECHNIQUE(S) CAN GENERATE EXCESSIVE PRESSURE, DAMAGE THE FIREARM AND CAUSE SERIOUS**

PERSONAL INJURY. If the blockage can be removed with a cleaning rod, clean any unburned powder grains from the bore, chambers and mechanism before resuming shooting. If the blockage cannot be dislodged by tapping it with a cleaning rod, take the firearm to a gunsmith.

⚠ WARNING (EYE AND EAR PROTECTION)

When shooting, full eye and ear protection is mandatory at all times. Shooters and spectators must wear shooting glasses and hearing protection to prevent eye injury and hearing loss. Vision and hearing impairment can occur with only one moment of non-protection.

⚠ WARNING (Mechanical Malfunctions)

STOP SHOOTING IMMEDIATELY AND UNLOAD YOUR FIREARM if your firearm develops: a mechanical malfunction; binding or stoppage; spitting powder/gas; a punctured cartridge primer; a bulged or ruptured cartridge case; or a sound on firing does not sound quite right. Do **NOT** try one more shot but unload your firearm and take it and the ammunition to a qualified gunsmith or send the firearm back to European American Armory Corp. for examination. Do not assume that the semi-auto shotgun is empty merely because you checked the chamber. You must also check the bore for any fired shot or wad jammed inside the barrel.

BASIC PARTS OF YOUR SEMI-AUTO SHOTGUN

EXTERNAL CONTROL PARTS:

Cross Trigger Block Safety: The safety mechanism of the semi-auto shotgun provides protection against accidental and unintentional discharge under normal usage when properly engaged and in good working order. The safety mechanism is not a substitute for following the rules of safe gun handling. Do not disengage the safety unless you are ready to fire the semi-auto shotgun. ***MAKE SURE YOU UNDERSTAND HOW THE SAFETY WORKS BEFORE YOU LOAD OR USE THE SEMI-AUTO SHOTGUN.***

The safety mechanism is a push-button-style safety located on the trigger housing behind the trigger. See **Figure 6**. To place the safety in the “on” or “safe” position, push the button all the way to the right. When in the “on” or “safe” position, the safety blocks the rearward motion of the trigger. To place the safety in the “off” or “fire” position, push the slide button all the way to the left. When in the “off” or “fire” position, a red ring is exposed behind the slide button. You have now disengaged the safety and the semi-auto shotgun is in the ready-to-fire position. See **Figure 7**.



Figure 6



Figure 7

⚠ WARNING

Do not touch the trigger while moving the safety. When operating the safety, make sure you push it to the full extent of its travel in the desired direction, either fully “on” or fully “off.” Half-safe or partially-safe is **UNSAFE**.

Carrier Latch/Bolt Release Button: The carrier latch/bolt release button is located on the right side of the shotgun and protrudes out of the forward right hand side of the receiver. See **Figure 8**. Pushing in the button will release the carrier latch as well as release the bolt if it is in the rearward position.



Figure 8

Carrier Latch: The carrier latch is located under the receiver in front of the trigger guard. See **Figure 9**. Depressing the carrier latch will release the lock on the latch so that it can be moved for loading the semi-auto shotgun.



Figure 9

Trigger: The trigger is located in the trigger guard. See **Figure 10**.



Figure 10

⚠ WARNING!

Never pull the trigger until you are actually ready to fire. Keep your fingers off the trigger and outside of the trigger guard until you are ready to pull the trigger and fire the semi-auto shotgun. When opening and closing the action and when engaging or disengaging the safety mechanism, make sure your fingers are outside the trigger guard and away from the trigger.

Bolt Cocking Handle: The bolt cocking handle is located on the right side of the shotgun and protrudes from the bolt and is used for pulling the bolt rearward. See **Figure 11**. Please note that if the shotgun has been cocked and the bolt has been released to the forward position, the bolt will not lock back in the rearward position unless the carrier stop button has been moved rearward.

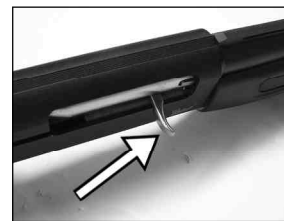

Figure 11

Carrier Stop Button: The carrier stop button is located on the right hand of the receiver at the forward end of the trigger housing. See **Figure 12**. The carrier stop button is a flat button that moves forward and rearward and resets the bolt catch and locks the carrier latch in the down position. If the shotgun has been



Figure 12

cocked, the bolt will not lock back in the rearward position unless this button has been pushed rearward.

The Fore End Cap: The fore end cap is located on the end of the magazine tube at the front of the fore end and under the barrel. See **Figure 13**. The fore end cap screws onto the magazine tube using a right-hand thread.

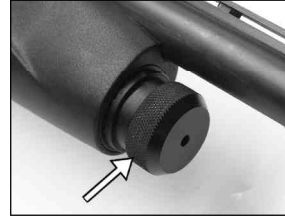

Figure 13

⚠ WARNING!

The fore end cap is under spring pressure. Use caution when screwing and unscrewing the fore end cap onto the end of the magazine.

The Serial Number: The semi-auto shotgun's serial number is located on the left bottom side of the receiver.

The Cocking Indicator:

The cocking indicator is located in the front inside of the trigger guard. See **Figure 14a**. When cocked the indicator is visible. When fired or uncocked, the indicator is not visible. See **Figure 14b**.

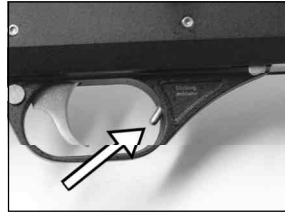

Figure 14a

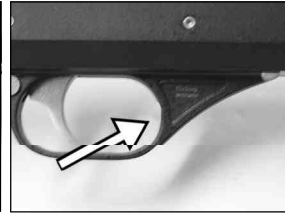

Figure 14b

Directions For Assembly Of Semi-Auto Shotgun:

⚠ WARNING

Before you begin to assemble the semi-auto shotgun, you **MUST** (1) look down the barrel from the breech end toward the muzzle end to make sure there is no ammunition in the chamber or obstruction in the barrel (See **Figure 15**), and (2) make sure the safety is in the "safe" position.



Figure 15

Your semi-auto shotgun was shipped with the barrel detached from the main portion of the shotgun. To assemble the semi-auto shotgun, follow these instructions:

- 1) When you open the box of your new MP153 shotgun, the barrel is separated from the main portion of the shotgun. To attach the barrel, first remove the stock and receiver from the plastic bag. Then unscrew the fore end cap. See

Figures 16a, 16b.

⚠ WARNING!

The magazine cap is under spring pressure. Note: After assembly of the shotgun the spring in the magazine tube may become twisted. This will cause a decrease in magazine tube capacity. If you load and unload the magazine tube the spring will untwist and the capacity should be as defined in the manual.



Figure 16a



Figure 16b

- 2) If the plastic spring cap is not installed in the magazine tube, use a small pin in the hole in the end of the magazine tube to hold the spring during removal of the cap. Unscrew the cap until you see the hole in the tube. Then insert the pin through the hole and hold the spring. See **Figure 17**.

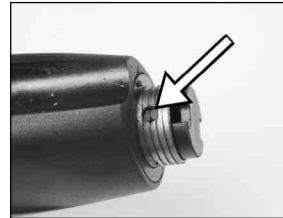

Figure 17

- 3) Remove the fore end from the magazine tube. See **Figure 18**.



Figure 18

- 4) Remove the barrel from the box and remove the plastic bag from the barrel. Insert the barrel extension into the receiver (between the bolt and the receiver) while making sure the barrel lug is aligned with the magazine tube. Continue sliding the barrel extension into the receiver and allow the barrel lug to slide over the magazine tube. With the barrel extension partially inserted into the receiver between the bolt and the receiver, pull the bolt cocking handle to the rear so that the bolt is locked back. Now completely insert the barrel extension into the receiver. See **Figure 19**.



Figure 19

- 5) Slide the fore end over the magazine tube. Do **NOT** force the fore end. Make sure that the fore end is completely seated around the magazine tube, barrel, and the receiver. The fore end **MUST** be flush with the receiver. See **Figure 20**.



Figure 20

- 6) Screw on the fore end cap so that the fore end is held firmly in place and flush against the receiver. See **Figure 21**.



Figure 21

- 7) With the fore end and the barrel in place and the

fore end cap securely in place, depress the carrier latch button and the bolt will slide into the barrel extension (Note: If you see any portion of the barrel extension protruding from the receiver after you released the bolt or if there is a gap between the fore end and the receiver you have not properly assembled the shotgun). If the bolt does not slide forward or you have gaps or the barrel extension protrudes from the receiver, reverse the assembly procedures and start over again making sure that the barrel is fully inserted into the receiver and that the fore end is fully in place. If you still cannot assemble the shotgun correctly, take the shotgun to the dealer where you bought the shotgun or a qualified gunsmith for assistance.

- 8) Once the shotgun is assembled (or if you can not fully assemble the shotgun and plan to carry it somewhere for assistance) activate the cross trigger block safety and keep it activated until you are ready to fire the shotgun. Keep the safety "on" no matter if the gun is loaded or unloaded.

LOCKING BLOCK PLACEMENT: During assembly or reassembly make sure the locking lug is in place as pictured. See **Figure 22a**. Make sure that the firing pin spring and firing pin washer are held rearward by the locking lug. See **Figure 22b**.

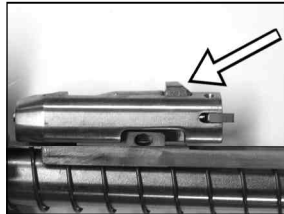

Figure 22a

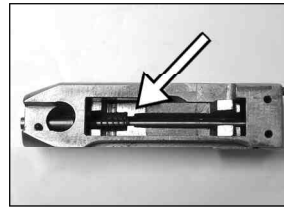

Figure 22b

LOADING AND UNLOADING YOUR SEMI-AUTO SHOTGUN



WARNING

Never load or fire the semi-auto shotgun unless the barrel is properly attached to the receiver, and the fore end is locked into the receiver.



WARNING

Make sure the semi-auto shotgun is pointed in a safe direction and the cross trigger block safety is engaged at all times while loading and unloading. NEVER allow your finger or other objects to contact the trigger while loading or unloading.



WARNING

Do not disengage the cross trigger block safety until you are ready to fire and have the shotgun pointed safely downrange.

***** Warning *****

Do not load the semi-auto shotgun until you are ready to fire.

TO LOAD:

1) Make sure the ammunition that you are using is the correct size and gauge.

2) Visually inspect the chamber and barrel for obstructions by pulling back the bolt until it locks back. Note that if the bolt will not lock back then push the Carrier Stop Button rearward and retry locking the bolt rearward. The chamber and barrel should be free of oil or grease or obstructions. See **Figure 23**.



Figure 23

3) After inspection, release the bolt by depressing the carrier latch button.

4) Turn the shotgun upside down so that the barrel is pointing toward the ground and you are looking at the carrier latch. Now depress the carrier latch and insert up to five (5) - 2 3/4" cartridges or five (5) - 3" cartridges or (4) - 3.5" cartridges into the magazine tube. Note that if the plastic spring cap is in the magazine tube then all capacities are decreased by one round. See **Figure 24**.



Figure 24

TO UNLOAD:

1) Make sure the cross trigger block safety is engaged and your fingers are away from the trigger. Draw back the bolt until a cartridge is ejected or the bolt has traveled to the rear fully. If there was no cartridge in the chamber, nothing will be ejected. Slide the bolt back forward until it is fully closed. Repeat the drawing back of the bolt while depressing the carrier stop button until no more rounds are ejected from the shotgun. The bolt will lock back when the last round is ejected. See **Figure 25**.



Figure 25

2) Now lock the bolt in the rearward position. (Note: You must move the Carrier Stop Button rearward for the bolt to lock in the rearward position). With the bolt locked back, visually inspect the chamber to insure that it is empty. You should also look down into the receiver through the ejection port and verify that the magazine tube is empty. See **Figure 26**.



Figure 26

If for some reason the cartridge in the magazine tube will not rise up into the chamber after repeated attempts to manually cycle the shotgun, perform the following steps:

- A) Manually close the bolt.
- B) Turn over the shotgun so that the trigger guard is facing you (upward). Depress the carrier latch button and then depress the carrier latch. See **Figure 27**.



Figure 27

- C) With the same finger that you are depressing the carrier latch, depress the Shell Latch. The Shell Latch is located on your left hand side with the shotgun in the upside down position. It is the piece of metal that should be holding the round in the magazine tube. The cartridge should slide up and out of the shotgun with your guidance. Note: the cartridge is under spring tension. Repeat this process until the magazine tube is empty. Turn the shotgun over and lock the bolt back and verify that the gun is empty. If you had to follow the procedure for a cartridge that was not being released from the magazine tube, make sure the shotgun is empty and let a qualified gunsmith inspect the shotgun before you load or use the shotgun again.

FIRING YOUR SEMI-AUTO SHOTGUN

⚠ WARNING

Never load a cartridge into the chamber until you are ready to fire the semi-auto shotgun.

⚠ WARNING

Do not disengage the cross trigger block safety until the semi-auto shotgun is pointed in a safe direction and you are ready to fire.

⚠ WARNING

If a cartridge does not fire and the trigger has been pulled and the cross trigger block safety is disengaged, Stop! Then do the following: **a)** Make sure the gun is pointed in a safe direction **b)** Engage the cross trigger block safety **c)** Wait 60 seconds **d)** Follow the instructions above for unloading the semi-auto shotgun.

⚠ WARNING

If during firing the sound of any cartridge is noticeably softer or louder than the previous cartridge fired, Stop! Then do the following: **a)** Make sure the gun is

pointed in a safe direction **b)** Engage the cross trigger block safety **c)** Follow the instructions above for unloading the semi-auto shotgun and **d)** With the semi-auto shotgun unloaded visually inspect the semi-auto shotgun for barrel blockage or damage. Then inspect the receiver of the semi-auto shotgun for damage before continuing.

READ, UNDERSTAND AND FOLLOW ALL WARNINGS AND INSTRUCTIONS IN THIS MANUAL BEFORE FIRING THE SEMI-AUTO SHOTGUN.

TO FIRE THE SEMI-AUTO SHOTGUN:

- 1) Make sure you are wearing eye and ear protection.
- 2) Make sure the semi-auto shotgun is pointed in a safe direction with the trigger block safety engaged. See **Figure 28**.
- 3) Keeping your fingers away from the trigger, push the cross trigger block safety to the “off” or “fire” position with the red ring showing. See **Figure 29**.



Figure 28

- 4) With the butt stock held firmly against your shoulder and the barrel pointed towards your intended target, place your trigger finger on the trigger. The semi-auto shotgun will fire when you pull or squeeze the trigger with the requisite force. See **Figure 30**. Semi-auto shotguns automatically feed the next live round from the magazine tube into the chamber each time the shotgun fires. No mechanical force is required for the shotgun to complete the chambering operation.



Figure 29

 WARNING

You must be aware that the firearm will be ready to fire another round after the previous round has been ejected and the new round has been chambered.



Figure 30

- 5) During firing, the bolt cocking handle travels rearward with considerable force and velocity. Do not allow any object to enter or obstruct its path.
- 6) After the last round has been fired, the shotgun should lock open. Never rely on the locked back bolt as a signal that the gun is empty. ALWAYS visually check the chamber. It is also possible that the bolt will not lock back after

the firing of the last cartridge. If this occurs, open the bolt manually and lock it to the rear. Note: If the bolt will not lock back then push the Carrier Stop Button rearward and retry locking the bolt rearward. Use your eyes to verify that the gun is empty.

⚠ WARNING

Once you have stopped firing the semi-auto shotgun, immediately push the cross trigger block safety back to the "on" or "safe" position. Then follow the unloading instructions above while keeping the muzzle pointed in a safe direction.

GAS SYSTEM ADJUSTMENT: The MP153 shotgun has a unique self-regulating gas system. It is preset at the factory to function with 12 Ga./2 3/4" (1 1/4 oz.) to 12 Ga./3.5" (steel shot). This system also allows you to fine tune the function of the shotgun with the gas system nut. By adjusting the gas system nut, you can make your shotgun function over the complete range of 12 Ga. ammunition and set the shotgun for optimum function for the user. The gas system nut allows you to customize the function of the shotgun to your requirements without additional parts or kits (unlike our competition).

Gas Cylinder Nut: The gas cylinder nut is located under the barrel on the front end of the gas cylinder. See **Figure 31**. The gas cylinder nut retains the valve spring with the valve, which provide the action of the shotgun with light loads as well as with heavy loads.

NOTE: For the first 100 rounds, use loads 1 1/4 oz. or greater. Your shotgun was set at the factory to use 12 Ga./3.5" steel shot to 12 Ga./2 3/4" (1 1/4 oz.). If you wish to use lead shot 12 Ga./3.5" rounds, then you must adjust the gas cylinder nut two turns counter-clockwise. If you wish to use loads lower than 12 Ga./2 3/4" (1 1/4 oz.) you must adjust the gas cylinder nut as required by turning it clockwise.

Never adjust the gas cylinder nut more than two complete turns in any direction. For reference use the notch on front of the gas cylinder. The nut should be visible through the notch and at most should fit flush the front end of the gas cylinder. To set the shotgun back to factory setting, see the mark on the gas cylinder and adjust as required. See **Figure 31**.

NOTE: Screw the gas cylinder nut but do not detach the barrel from the receiver. See **Figure 32**.

DUCK PLUG PLACEMENT: The wooden or plastic rod enclosed with your shotgun is a duck plug and can be placed inside the magazine tube spring from the cap end. The rod prevents

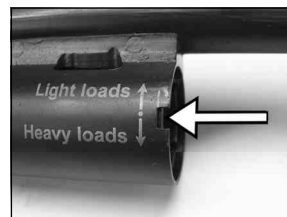

Figure 31



Figure 32

the magazine follower from moving the full length of travel.

It is preset for one round in the magazine without the plastic spring cap. You will see a mark on the rod which is where you would cut the rod if you want two rounds in the magazine without the plastic spring cap. If you want to use the plastic spring cap and the duck plug you will have to cut the rod at the mark.

DIRECTIONS FOR DISASSEMBLY OF THE SEMI-AUTO SHOTGUN:

- 1) Make sure the semi-auto shotgun is unloaded (**FOLLOW UNLOADING INSTRUCTIONS**) and pointed in a safe direction.
- 2) Make sure the cross trigger block safety is engaged in the “on” or “safe” position. See **Figure 33**.
- 3) With the bolt in the forward position, unscrew the fore end cap and remove the fore end. Push the Carrier Stop Button rearward and move the bolt to the rear slightly and hold it out of battery. Then grasp the barrel and remove the barrel by pulling the barrel and barrel extension out of the receiver. See **Figure 34**.
- 4) Use the back end of an empty cartridge or a flathead screwdriver or your fingers to remove the Bolt Cocking Handle. Insert the screwdriver or back of empty cartridge into the notch and pry up handle and remove from the bolt or grasp the handle firmly and pull out and away from receiver. See **Figure 35**.
- 5) With the cocking handle removed from the bolt you now can grasp the gas piston and slide the bolt and action bar forward and remove the assembly from the magazine tube and receiver. Be careful because once the bolt is removed from the receiver all the pieces from the assembly are free to separate. We suggest you keep the gun with the **bolt up** when you remove the assembly so the assembly does not separate. See locking block placement section. See **Figure 36**.

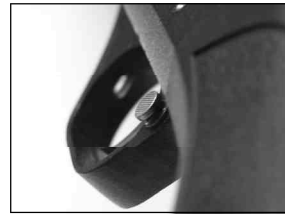

Figure 33



Figure 34



Figure 35



Figure 36

- 6) The trigger assembly can be removed with the barrel and bolt removed or without the barrel and bolt removed. To remove the trigger assembly all you do is remove the two pins that hold the trigger assembly in place and pull the trigger assembly from the receiver. The pins can be removed with a hammer and a punch. See **Figure 37**.



Figure 37

MANUFACTURER'S WARNING:

This firearm was manufactured to properly perform with the original parts as designed. It is your duty to make sure any parts you buy are correctly installed and that neither replacements nor originals are altered or changed. Your gun is a complex tool with many parts that must relate correctly to other parts for safe and accurate operation. Putting a gun together wrong or with modified parts can result in a damaged gun, or personal injury or death to you or others. Always let a qualified gunsmith work on your gun or at least, check any work not performed by a gunsmith. Firearms safety is your primary concern. **THE GUN OWNER MUST ACCEPT FULL RESPONSIBILITY FOR THE CORRECT REASSEMBLY AND FUNCTIONING OF THE FIREARM AFTER ANY DISASSEMBLY OR REPLACEMENT OF PARTS.**

TO CLEAN AND MAINTAIN YOUR SEMI-AUTO SHOTGUN:

- A) Follow procedures for unloading semi-auto shotgun as described previously.
- B) Follow procedures for disassembly of semi-auto shotgun as described previously.
- C) Materials needed to clean this semi-auto shotgun are: a cleaning rod, cotton bore patches, brass bore brush, powder solvent, a small soft brush and good quality gun oil.

WARNING: Lead or lead compounds are known to the State of California to cause cancer, birth defects, reproductive toxicity, and other serious physical injury. Those who clean firearms should take protective measures to avoid contact or exposure to such chemicals.

- D) Using the bore brush with powder solvent, scrub the interior of the barrel and chamber to remove any powder and lead residue in the bore. Always and lastly, swab the interior of the barrel with cotton patch with gun oil to coat and protect the bore and chambers from rust and corrosion.
- E) Any powder fouling on the firing wall, barrel, etc. can be easily cleaned with a brush and powder solvent.

- F) All external surfaces should be wiped down with a light coat of rust preventative. Avoid using too much oil as powder, dust or other foreign material may get trapped in the oil. This could lead to congealed deposits which may interfere with the safe and reliable operation of the semi-auto shotgun.
- G) **USE CAUTION** while using solvents in gun bore cleaning. Prolonged or excess contact with solvents can damage the gun's bluing and finish. Be sure to wipe away all excess solvent and then lubricate with oil.
- H) A gun should be cleaned after firing. In addition, external parts should be wiped with an oiled cloth after handling. A light oil is ordinarily all that is necessary in cleaning if the gun has not been fired or fired very little. If a gun is used frequently, it must be cleaned after each firing and regularly serviced by a professional gunsmith. If the gun has been stored, remove all excess oil and/or grease before firing. Always check to be sure that no cleaning patch or other obstruction remains in the bore or chambers before firing.

Figure 38: Pictures the two holes in the barrel gas porting ring which must remain open and clear for the shotgun to function properly. Make sure these two holes are cleaned after each use as well as clean the barrel gas porting ring.



Figure 38

Figure 39: Pictures the gas piston assembly on the magazine tube. These parts must be cleaned and lightly oiled after each use.

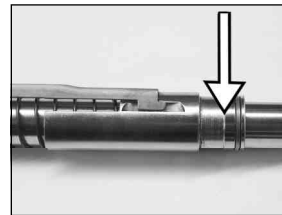

Figure 39

DANGER – AMMUNITION WARNING

Firearms may be damaged and serious personal injury or death to the shooter or bystanders may result from any condition which contributes to the generation of excessive pressure or uncontrolled release of gas within the firearm. Such adverse conditions can be caused by bore or chamber obstruction, propellant powder overloads or by defective, incorrect or improperly loaded and assembled cartridge components. Even the strongest firearm can be blown up as a result of excessive pressure. It is extremely dangerous to use a cartridge whose pressure is greater than that developed by cartridges loaded to industry standards.

AMMUNITION (CARTRIDGES) NOTICE

We specifically disclaim responsibility for any damage, personal injury or death occurring in connection with or as the result of the use of European American Armory Corp. semi-auto shotguns with faulty, nonstandard, remanufactured, hand-loaded or reloaded ammunition, used cartridges or cartridges other than factory cartridges for which the firearm was originally chambered.

LUBRICATION WARNING

Firing a semi-auto shotgun with oil, grease or any other material even partially obstructing the bore may result in damage to the semi-auto shotgun and personal injury to the shooter and those nearby. Do not spray or apply lubricants directly on ammunition. If the powder charge of a cartridge is affected by the lubricant, it may not fully ignite yet the energy from the primer and/or powder may be sufficient to push the projectile or wad into the bore where it may become lodged. Firing a subsequent cartridge into the obstructed bore will damage the semi-auto shotgun and may cause personal injury to the shooter and those nearby. Use lubricants properly. You are responsible for the proper care and maintenance of your firearm and ammunition.

ONE YEAR LIMITED WARRANTY

This European American Armory Corp. firearm is warranted to the original retail customer for One Year from date of purchase against defects in material and workmanship. All parts and labor or replacement **at our option** are covered. Wood Stock and Wood Fore end are not covered by the One Year Warranty. The warranty on the wood stock and fore end is 60 days from purchase and only covers manufactured and material defects.

Transportation to and from our repair facilities, government fees, damage caused by failure to perform normal maintenance, sales outside the United States, damage due to use of high velocity, high pressure, reloaded or other nonstandard ammunition, or any unauthorized repair, modification, misuse, abuse, or alteration of the product are not covered by this Limited Warranty.

Any implied warranties, including the implied warranties of merchantability and fitness for a particular purpose, are limited to one year from date of original retail purchase. Consequential or incidental damages and/or expenses, or any other expenses are not covered by this warranty.

To obtain warranty performance send your firearm with proof of retail purchase, freight prepaid to:

**European American Armory Corp.
3855 North U.S. Highway 1
Cocoa, Florida 32926**

NOTICE: It is illegal to ship a firearm with ammunition in the firearm or in the same packaging. Firearms and ammunition must be shipped separately. For information about shipping ammunition, call European American Armory Corp. at (321) 639-4842.

WARNING—ALTERATIONS OR MODIFICATIONS

Altering or modifying parts and/or internal safeties is dangerous and will void the warranty. This semi-auto shotgun was manufactured to perform properly with the

original parts as designed. It is your duty to make sure any parts you buy are made for this firearm and are installed correctly and that neither the replacements nor originals are altered or changed. Your gun is a complex precision tool with many parts that must relate correctly to other parts in order for proper and safe operation. Putting a gun together wrong or with incorrect or modified parts can result in a damaged gun, danger, and personal injury or death to you and others through malfunction. Always have a qualified gunsmith work on your gun or at least check any work not performed by a gunsmith.

YOUR OWNER'S MANUAL

Always keep this manual with your firearm. Make sure you understand all the warnings, operation instructions and safety procedures. When you lend, give or sell the firearm, be sure this manual goes with it. You can get a copy of this manual from European American Armory Corp. upon request.

ALL PARTS ORDERS ARE SUBJECT TO A \$10.00 CHARGE FOR SHIPPING AND HANDLING. Please state Model, Caliber, Serial Number, and Finish Color when ordering. For parts, information and service contact: European American Armory Corp., 402 Richard Road, Rockledge, Florida 32955 Phone: (321) 639-4842.

MP153 Exploded View

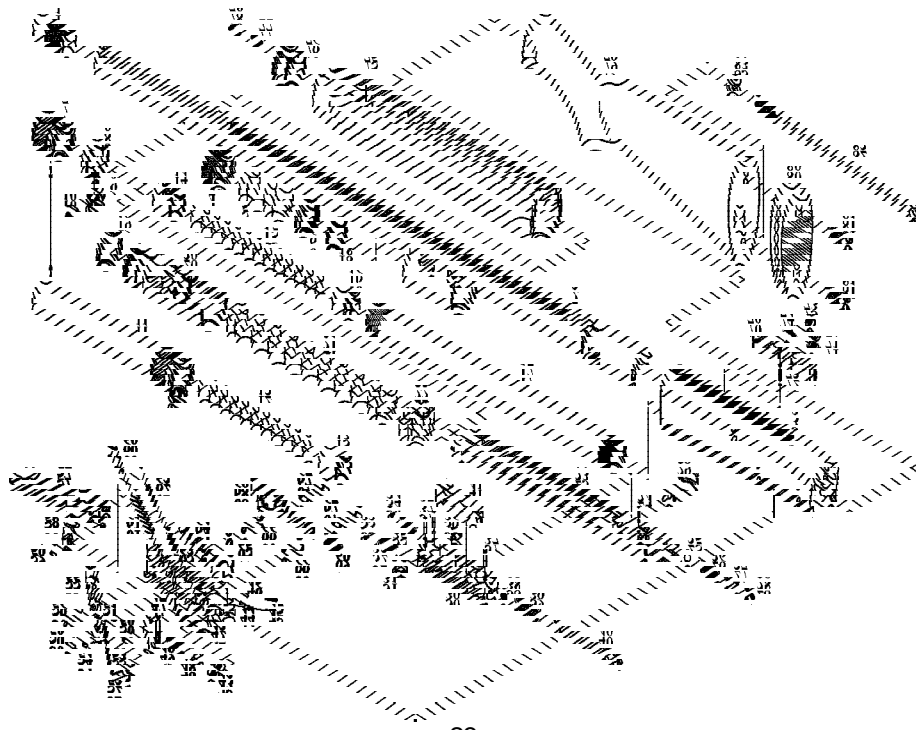

PARTS LIST

1. Choke tube
2. Barrel
3. Receiver
4. Gas cylinder nut
5. Valve spring
6. Valve
7. Fore end cap
8. Sling swivel band
9. Sling swivel ring
10. Sling swivel screw
11. Magazine tube extension
12. Magazine tube extension spring
13. Magazine tube extension insert
14. Magazine spring retainer
15. Magazine spring
16. Magazine follower
17. Magazine tube
19. External seal
20. Piston / Action bar sleeve
21. Recoil spring
22. Fore end support
23. Action bar assembly
24. Pin
25. Bolt cocking handle detent ball
26. Spring
27. Plunger
28. Bushing
29. Bolt cocking handle
30. Bolt
31. Left extractor
32. Left extractor spring
33. Left extractor plunger
34. Right extractor plunger
35. Right extractor spring
36. Right extractor
37. Firing pin retaining pin
38. Firing pin retractor spring washer
39. Firing pin retractor spring
40. Firing pin
41. Locking block
42. Trigger housing
43. Safety
44. Safety plunger
45. Safety spring
46. Pin
47. Trigger
48. Trigger plunger
49. Trigger spring
50. Pivot
51. Sear
52. Trigger bar
53. Sear spring
54. Trigger bar pivot
55. Hammer
56. Hammer pivot
57. Carrier latch
58. Carrier latch dog
59. Carrier latch dog pivot
60. Hammer plunger
61. Main spring
62. Carrier latch dog plunger
63. Carrier latch spring
64. Disconnecter
65. Disconnecter busing
66. Pin tube
67. Trigger housing retaining pin
68. Carrier stop catch
69. Carrier stop catch spring
70. Shell stop
71. Shell stop spring
72. Shell stop pivot
73. Bolt release button
74. Bolt release button spring
75. Forend
76. Cap retaining pin bushing
77. Cap retaining pin spring
78. Cap retaining pin
79. Buttstock
80. Buttplate
81. Buttplate woodscrew
82. Buttstock screw
83. Buttstock washer

OPTIONAL CHOKE TUBES



WARNING

Never install or remove choke tubes while the firearm is loaded. Only install or remove choke tubes with the firearm unloaded, the action open and the trigger block safety engaged.

Screw in Chokes Symbols/Markings

The end of the choke tubes are marked with slashes to identify the choke constriction:

/	- Full
//	- Improved Modified
///	- Modified
////	- Improved Cylinder
CI	- Cylinder

WARNING!

MAKE SURE YOU FULLY TIGHTEN THE CHOKE TUBE

Shooting with a loose choke tube can cause damage to your semi-auto shotgun.

Additional information on screw choke tubes:

- A) Only tighten or loosen choke tubes with flat key wrench supplied with semi-auto shotgun. Note: wrench (and extra choke tube or tubes if supplied) are under the cardboard in front of the semi-auto shotgun receiver in the box.
- B) Never shoot the semi-auto shotgun with a partially installed choke tube.
- C) MP153 semi-auto shotguns are available with fixed choke or screw choke barrels. There are two types of screw chokes available: lead shot choke tubes and steel shot choke tubes. When installed, steel shot choke tubes protrude approximately 3/4" from the muzzle end of the barrel and the mating lip will be flush with the end of the barrel. When installed, lead shot choke tubes fit flush with or slightly below the muzzle end of the barrel. If you have lead shot choke tubes and intend to shoot steel shot cartridges or slugs, then you must use only the IC or Cylinder tubes. If you have steel shot choke tubes, you may fire steel shot cartridges through any of those choke tubes. DO NOT fire slugs in Modified, Improved Modified or Full lead shot choke tubes or steel shot choke tubes.
- D) Correctly install choke tubes. Lead shot choke tubes should fit flush or slightly below the muzzle end of the barrel. Steel shot choke tubes will protrude out from the barrel about 3/4" and the mating lip will be flush with barrel end.
- E) Before using the semi-auto shotgun make sure that the choke tubes are installed correctly.
- F) Keep choke tubes lubricated and installed. Never fire the gun without a choke tube installed. Handle choke tubes carefully since the leading edge is very thin.

Notes on Shot Material and Chokes:

- 1) Shells using Bismuth or Tungsten-Matrix shot are subject to the same barrel and choke tube limitations as lead shot. Shells using Tungsten-Iron shot or Hevi-Shot are subject to the same barrel and choke tube limitations as steel shot.
- 2) On fixed choke guns, shells loaded with steel, Tungsten-Iron or Hevi-Shot should be fired only in IC or Cylinder barrels. **DO NOT** fire steel, Tungsten-Iron or Hevi-Shot shells in fixed barrels with Modified, Improved Modified or Full choke barrels. Lead, Bismuth and Tungsten-Matrix may be fired in all fixed choke barrels.
- 3) On fixed choke guns, slugs may be fired in only IC and Cylinder barrels. **DO NOT** fire slugs in fixed choke barrels with Modified, Improved Modified or Full chokes.

If you would like to buy extra choke tubes (skeet, trap, extra full, etc.) call (321) 639-4842.

 **WARNING**

Children are attracted to and can operate firearms that can cause severe injuries or death.

Prevent child access by always keeping guns locked away and unloaded when not in use. If you keep a loaded firearm where a child obtains and improperly uses it, you may be fined or sent to prison.

 **ADVERTENCIA**

A los niños les atraen las armas de fuego y los pueden hacer funcionar. Ellos pueden causarse lesiones graves y la muerte.

Evite que los niños tengan acceso a las armas de fuego guardándolas siempre con llave y descargadas cuando no las esté utilizando. Si usted tiene un arma de fuego cargada en un lugar en que un niño tiene acceso a ella y la usa indebidamente, le pueden dar una multa o enviarlo a la cárcel.

Importer:

European American Armory Corp.
3855 North U.S. Highway 1
Cocoa, FL 32926

Manufacturer:

Izhevsky Mekhanichesky Zavod
8, Promyshlennaya str.,
426063 Izhevsk, Russia