

# INSTRUCTION MANUAL FOR

BLUED &  
STAINLESS  
STEEL



CALIBERS  
.17 HMR, .22 Long Rifle,  
.22 Magnum, .22 Hornet  
& .44 Magnum

## **RUGER®** **MODEL 77/22®**, **MODEL 77/17**, **& MODEL 77/44™**

**BOLT-ACTION RIFLES**  
**RIMFIRE & CENTERFIRE MODELS**



Model 77/22 & 77/17



Model 77/44



**READ THE INSTRUCTIONS AND  
WARNINGS IN THIS MANUAL CAREFULLY  
BEFORE USING THIS FIREARM**

**For Product Service on This Model Please Call:**  
**(603) 865-2442 (See p. 30)**

**STURM, RUGER & Company, Inc.**  
**Southport, Connecticut 06890 U.S.A.**

THIS INSTRUCTION MANUAL SHOULD ALWAYS ACCOMPANY THIS FIREARM AND BE  
TRANSFERRED WITH IT UPON CHANGE OF OWNERSHIP, OR WHEN THE FIREARM IS LOANED OR  
PRESENTED TO ANOTHER PERSON.

## State-By-State Warnings

Certain states require by law that their own specified warning notices in larger-than-normal type be conspicuously included by the manufacturer, distributor, or retail dealer with firearms sold in that state. Sturm, Ruger sells its products in compliance with applicable laws and regulations. Because our products may be sold in these states, we include the following:

### California:

#### **⚠ WARNING**

“Children are attracted to and can operate firearms that can cause severe injuries or death. Prevent child access by always keeping guns locked away and unloaded when not in use. If you keep a loaded firearm where a child obtains and improperly uses it, you can be fined or sent to prison.”

#### **⚠ ADVERTENCIA**

“A los niños los atraen las armas de fuego y las pueden hacer funcionar. Ellos pueden causarse lesiones graves y la muerte. Evite que los niños tengan acceso a las armas de fuego guardándolas siempre con llave y descargadas cuando no las esté utilizando. Si usted tiene un arma de fuego cargada en un lugar en que un niño tiene acceso a ella y la usa indebidamente, le pueden dar una multa o enviarlo a la cárcel.”

### Connecticut:

“UNLAWFUL STORAGE OF A LOADED FIREARM MAY RESULT IN IMPRISONMENT OR FINE.”

### Florida:

“IT IS UNLAWFUL, AND PUNISHABLE BY IMPRISONMENT AND FINE, FOR ANY ADULT TO STORE OR LEAVE A FIREARM IN ANY PLACE WITHIN THE REACH OR EASY ACCESS OF A MINOR UNDER 18 YEARS OF AGE OR TO KNOWINGLY SELL OR OTHERWISE TRANSFER OWNERSHIP OR POSSESSION OF A FIREARM TO A MINOR OR A PERSON OF UNSOUND MIND.”

## **Maine:**

“ENDANGERING THE WELFARE OF A CHILD IS A CRIME. IF YOU LEAVE A FIREARM AND AMMUNITION WITHIN EASY ACCESS OF A CHILD, YOU MAY BE SUBJECT TO FINE, IMPRISONMENT OR BOTH. KEEP FIREARMS AND AMMUNITION SEPARATE. KEEP FIREARMS AND AMMUNITION LOCKED UP. USE TRIGGER LOCKS.”

## **Maryland:**

“WARNING: Children can operate firearms which may cause death or serious injury. It is a crime to store or leave a loaded firearm in any location where an individual knew or should have known that an unsupervised minor would gain access to the firearm. Store your firearm responsibly!”

## **Massachusetts:**

“WARNING FROM THE MASSACHUSETTS ATTORNEY GENERAL: This handgun is not equipped with a device that fully blocks use by unauthorized users. More than 200,000 firearms like this one are stolen from their owners every year in the United States. In addition, there are more than a thousand suicides each year by younger children and teenagers who get access to firearms. Hundreds more die from accidental discharge. It is likely that many more children sustain serious wounds, or inflict such wounds accidentally on others. In order to limit the chance of such misuse, it is imperative that you keep this weapon locked in a secure place and take other steps necessary to limit the possibility of theft or accident. Failure to take reasonable preventive steps may result in innocent lives being lost, and in some circumstances may result in your liability for these deaths.”

“IT IS UNLAWFUL TO STORE OR KEEP A FIREARM, RIFLE, SHOTGUN OR MACHINE GUN IN ANY PLACE UNLESS THAT WEAPON IS EQUIPPED WITH A TAMPER-RESISTANT SAFETY DEVICE OR IS STORED OR KEPT IN A SECURELY LOCKED CONTAINER.”

**New Jersey:**

“IT IS A CRIMINAL OFFENSE TO LEAVE A LOADED FIREARM WITHIN EASY ACCESS OF A MINOR.”

**New York City:**

“THE USE OF A LOCKING DEVICE OR SAFETY LOCK IS ONLY ONE ASPECT OF RESPONSIBLE WEAPONS STORAGE. ALL WEAPONS SHOULD BE STORED UNLOADED AND LOCKED IN A LOCATION THAT IS BOTH SEPARATE FROM THEIR AMMUNITION AND INACCESSIBLE TO CHILDREN AND ANY OTHER UNAUTHORIZED PERSONS.”

**North Carolina:**

“IT IS UNLAWFUL TO STORE OR LEAVE A FIREARM THAT CAN BE DISCHARGED IN A MANNER THAT A REASONABLE PERSON SHOULD KNOW IS ACCESSIBLE TO A MINOR.”

**Texas:**

“IT IS UNLAWFUL TO STORE, TRANSPORT, OR ABANDON AN UNSECURED FIREARM IN A PLACE WHERE CHILDREN ARE LIKELY TO BE AND CAN OBTAIN ACCESS TO THE FIREARM.”

**Wisconsin:**

“IF YOU LEAVE A LOADED FIREARM WITHIN THE REACH OR EASY ACCESS OF A CHILD YOU MAY BE FINED OR IMPRISONED OR BOTH IF THE CHILD IMPROPERLY DISCHARGES, POSSESSES, OR EXHIBITS THE FIREARM.”

\* \* \* \* \*

Please check with your licensed retailer or state police for additional warnings which may be required by local law or regulation. Such regulations change constantly, and local authorities are in the best position to advise you on such legal matters.



## WARNING – LOCKING DEVICES

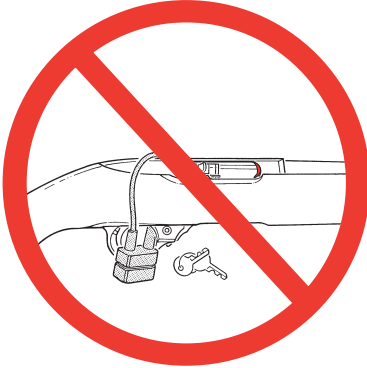

**DO NOT INSTALL  
INSIDE TRIGGER GUARD**

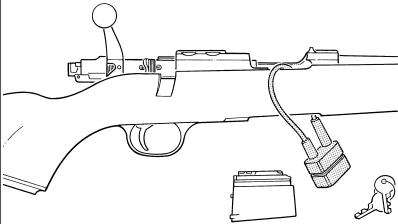

**INSTALL LOCK  
AS SHOWN HERE**

This firearm was originally sold with a key-operated locking device. While it can help provide secure storage for your **unloaded** firearm, any locking device can fail. All guns are designed to fire if they are loaded and the trigger is pulled. Therefore, **never install the locking device inside the trigger guard or in any way that it can possibly pull the trigger!** Do not leave the keys in the lock.

The ultimate responsibility for secure storage of any firearm must depend upon its owner and his or her individual circumstances.

**Guns should be securely stored unloaded, in a secure location, separate from their ammunition.**

See “Storage Warning”, page 27.

**NEVER INSTALL  
LOCKING DEVICE  
INSIDE TRIGGER GUARD**

# **FIREARMS SAFETY-YOUR RESPONSIBILITY**

## **SAFETY MUST BE THE FIRST AND CONSTANT CONSIDERATION OF EVERY PERSON WHO HANDLES FIREARMS AND AMMUNITION.**

This Instruction Manual is designed to assist you in learning how to use and care for your **RUGER MODEL 77/22®**, **MODEL 77/17** & **MODEL 77/44™** rifles properly.

Only when you are certain you fully understand the Manual and can properly carry out its instructions should you practice loading, etc. with live ammunition.

If you have any doubts about your ability to handle or use a particular type of gun safely, then you should seek supervised instruction.

Such personalized instruction is often available from gun dealers, gun clubs or police departments. If none of these sources can help you, write to the National Rifle Association, 11250 Waples Mill Road, Fairfax, VA 22030-7406. They will assist you.

The person with a gun in their possession has a full-time job. You cannot guess; you cannot forget. You must know how to use your firearm safely. **Do not use any firearm without having a complete understanding of its particular characteristics and safe use.**

Remember: There is no such thing as a foolproof gun.

### **TABLE OF CONTENTS**

	Page
General Information .....	8
Operation of Safety .....	9
Ammunition .....	11
To Load and Fire (With Magazine) .....	13
To Unload Rifle and Magazine .....	16
To Extract and Eject a Chambered Cartridge .....	18
To Clear a Malfunction ("Jam") .....	18
To Minimize Malfunctions ("Jams") .....	19
Basic Disassembly and Reassembly .....	20
Magazine Inspection and Care .....	24
Care and Cleaning .....	25
Storage .....	27
Maintenance of Stainless Steel Rifles .....	28
Attaching Scope Rings .....	29
Sight Adjustment .....	29
Service and Parts Policy .....	30
Parts Drawing .....	38, 39, 44 & 45
<b>The Basic Rules of Safe Firearms Handling .....</b>	<b>46</b>
Warranty Information .....	52

"Ruger", "77/22", & "77/44" are registered U.S. trademarks.  
"77/17" is a Sturm, Ruger trademark.



## WARNINGS OF GREAT IMPORTANCE ARE FOUND ON THE FOLLOWING PAGES:

Locking Devices	6	Handling	16
Alterations	8	Unloading	17
Manual Safety	10	Malfunctions	19
Lead Exposure	12	Disassembly	20
Ammunition	12	Lubrication	26
Loading	15	Storage	27
Firing	15	Parts Purchasers	31

**OTHER CAUTIONS AND WARNINGS APPEAR THROUGHOUT THE MANUAL.**

**FIREARMS ARE DANGEROUS WEAPONS—  
READ THE INSTRUCTIONS AND WARNINGS IN THIS  
MANUAL THOROUGHLY AND CAREFULLY BEFORE USING.**



## WARNING—ALTERATIONS



This product was designed to function properly in its original condition. Alterations can make it unsafe. Do not alter any part or add or substitute parts or accessories not made by Sturm, Ruger & Co. Inc.

**DO NOT ALTER ANY GUN**

## GENERAL INFORMATION AND MECHANICAL CHARACTERISTICS

The **RUGER MODEL 77/22®**, **MODEL 77/17** & **MODEL 77/44™** are bolt-action, magazine fed, repeating rifles. The capacity of the rotary magazine is ten .22 Long Rifle cartridges, nine .22 WMR cartridges in the **77/22® MAGNUM** and nine .17 HMR cartridges in the **77/17**, six cartridges in the **77/22® HORNET only**, and four cartridges in the **77/44™ only**.

Other notable features of the **RUGER MODEL 77/22®**, **MODEL 77/17** & **MODEL 77/44™** rifles include: A three-position safety, two bolt lugs locking into matching channels in the receiver, a fast lock-time trigger mechanism (non-adjustable), a flush positioned bolt stop (bolt release), an American walnut stock, hand checkered, with a polyurethane finish, nylon butt-plate and studs to which sling swivels can be attached.

The receiver on all versions of the Model 77/22<sup>®</sup>, Model 77/17, and the 77/44<sup>™</sup> rifle incorporates integral scope mount bases (see illustration below). The Model 77/22<sup>®</sup>, Model 77/17, and the 77/44<sup>™</sup> rifles come with a set of two Ruger 1" steel scope rings. The **R** model does *not* have open sights. The 77/22<sup>®</sup>RS and 77/44<sup>™</sup>RS come with open sights - a gold bead front sight and a folding leaf rear sight which is adjustable for elevation and windage. The corresponding 77/22<sup>®</sup> Hornet models are the 77/22<sup>®</sup>RH & the 77/22<sup>®</sup>RSH. The **K77/22<sup>®</sup>RP & RSP** All-Weather models come in stainless steel and have synthetic stocks with integral trigger guard assemblies.

The **77/22<sup>®</sup>** Varmint Rifle in .22 Long Rifle and .22 Rimfire Magnum calibers and the **77/17** Varmint rifle, feature a stainless-steel heavyweight varmint barrel and a laminated American hardwood stock.

Disassembly of the rifle to its major components is readily accomplished by removal of two screws. The bolt assembly can be quickly disassembled for cleaning.

All mechanical components are made of heat-treated chrome-molybdenum or stainless steel, with music wire coil springs throughout the mechanism.

## NOMENCLATURE

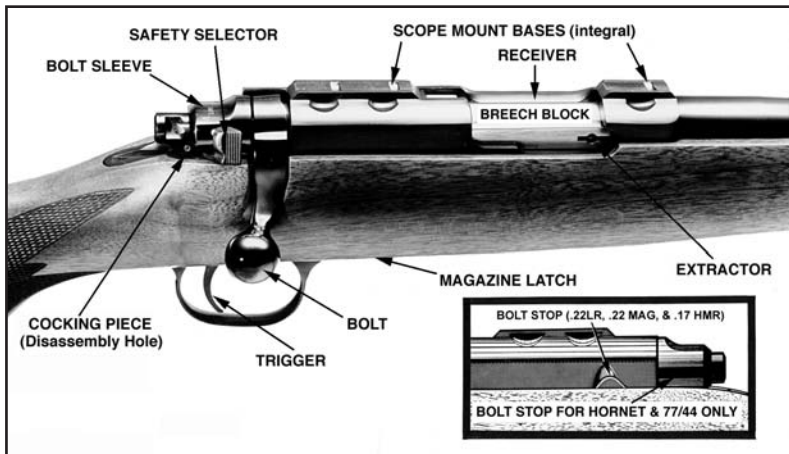

**Figure 1.** Components frequently referred to are identified. In this illustration the cocking piece is shown cocked (protruding from the rear of the bolt sleeve) revealing the disassembly hole in the lower portion of the cocked piece. The bolt stop (on the left side of the receiver) permits the bolt to be withdrawn simply by pressing down lightly with the thumbnail. **The safety selector (shown in the "Fire" position) should be in the "Load-Unload" position when the bolt is being removed or being installed.**

## OPERATION OF SAFETY

The **RUGER MODEL 77/22<sup>®</sup>, MODEL 77/17 & MODEL 77/44<sup>™</sup>** rifles have a three position safety. The safety selector is located at the right of the bolt sleeve.

The safety selector can be moved from the "Fire" position to its two other positions ("Load-Unload" and "Safe") only when the firing pin is cocked. Fully raising the bolt handle cocks the firing pin.

The bolt handle can be raised and lowered only when the safety selector is in either the "Fire" or the "Load-Unload" position. When the safety selector is in the



“Safe” position, the bolt handle is locked in the closed (full down) position in order to prevent inadvertent lifting of the bolt handle and to ensure that the rifle will be ready to fire when the safety is taken “off”.

Practice (with an unloaded rifle) moving the safety selector to the three positions until you know the position of the safety selector for the three modes– “Fire,” “Load-Unload,” and “Safe.” **WARNING: When manipulating the safety selector, DO NOT HAVE ANY FINGER INSIDE THE TRIGGER GUARD! When the safety selector is in the “Fire” position and the trigger is pulled, the rifle will fire.**

The safety selector should always be in the “Safe” position except when the gun user is actually firing or unloading the rifle. The safety selector should unfailingly be moved to the “Safe” position when the gun user ceases firing.

## SAFETY POSITIONS

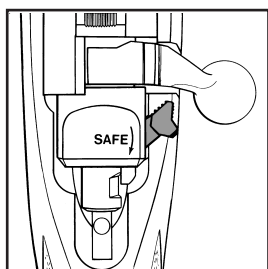

Figure 2. Safety selector in “FIRE” (full forward) position. The safety selector should be moved to this position only when the gun user is actually firing the rifle. When the safety is in the fire position, it is referred to as being “off.” (When the safety is in the “SAFE” position, it is referred to as being “on.”)

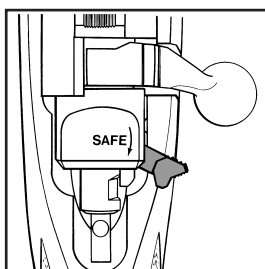

Figure 3. Safety selector in “LOAD-UNLOAD” (middle) position. The safety selector should be in this position when the bolt is being cycled to load a cartridge, or to unload a live round. As soon as a cartridge is chambered, the safety selector should be moved to the “SAFE” position unless the rifle is to be fired immediately.

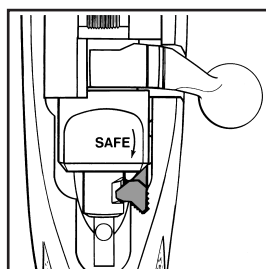

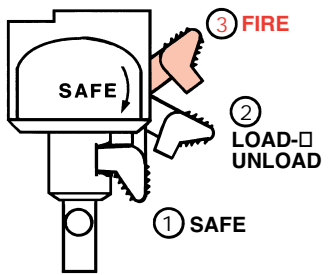

Figure 4. Safety selector in “SAFE” (full rearward) position. The safety selector is fully nested in the groove in the cocking piece. When the safety selector is in this position, the bolt handle cannot be raised. The curved arrow on the bolt sleeve indicates the direction and motion of the safety selector to bring it to the “SAFE” position. **Keep the safety in this position except when actually loading, unloading, or firing.**

	
<h3>WARNING – MANUAL SAFETY</h3>	
	<p>Keep the safety on unless actually firing. Always move the safety fully to its intended position and check it. The safety has three positions –“SAFE,” “LOAD-UNLOAD,” and “FIRE.” Never depend on a safety mechanism or any other mechanical device to justify careless handling or permitting the rifle to point in an unsafe direction. The only “safe” rifle is one in which the bolt is open and the chamber and magazine are empty.</p>
<h4>KNOW HOW TO USE THE SAFETY</h4>	

This safety selector is held in each of its positions by a plunger that is under spring tension. Therefore, the gun user should frequently check the position of the safety selector to be certain it has not been inadvertently moved. If the safety does not function properly, or if the selector seems to move too easily, or if the safety selector does not seem firmly positioned in any of its three positions, the rifle should be discontinued from use and returned to the Newport Product Service Department for repair (see p. 30).

## AMMUNITION

**RUGER MODEL 77/22**<sup>®</sup> rifles are chambered for many of the most popular factory-loaded cartridges manufactured in accordance with U.S. industry practice. The particular caliber for each rifle is rollmarked on the barrel. Use cartridges only of the designated caliber that is marked on the barrel. Please see AMMUNITION WARNING, p. 12 and LOADING WARNING on p. 15.

The **RUGER MODEL 77/22**<sup>®</sup> is chambered for, and designed to properly function as a repeating rifle with the .22 caliber Long Rifle rimfire cartridge, standard, high velocity or hyper-velocity, manufactured to industry standards.

The .22 Short, .22 Long and .22 SHOT cartridges can be fired in the model **77/22**<sup>®</sup> rifle, but such cartridges must be introduced by hand directly into the chamber. It should be noted that extensive use of the .22 Short cartridge can cause a 'ring' to be cut in the chamber which may interfere with the extraction of Long Rifle cartridges.

The **RUGER MODEL 77/17** is chambered for the .17 HMR Hornady Magnum Rimfire cartridge *only*. Do not use any other rimfire ammunition in this rifle!

The **RUGER MODEL 77/22**<sup>®</sup> **MAGNUM** is chambered for the .22 Winchester Magnum Rimfire cartridge *only*, both jacketed and hollow point. Do not use any other .22 caliber or any other rimfire ammunition in this rifle, as burst cases and the release of hot powder gases can result.

The **RUGER MODEL 77/22**<sup>®</sup> **HORNET** is chambered *only* for the centerfire .22 Hornet cartridge. Do not attempt to use any .22 rimfire (short, long, long rifle, or magnum) ammunition nor *any* other centerfire .22 ammunition (.222, .223, etc.) in this model.



**WARNING: DO NOT ATTEMPT TO LOAD .22 SHORT, .22 LONG, .22 SHOT OR ANY OTHER TYPE OF .22 CALIBER CARTRIDGE (OTHER THAN THE .22 LONG RIFLE) INTO THE MAGAZINE**

**OF THE 77/22<sup>®</sup> RIFLE. THE USE OF OTHER CARTRIDGES IN THE MAGAZINE CAN CAUSE POTENTIALLY DANGEROUS JAMS AND MALFUNCTIONS RESULTING IN DAMAGE TO THE FIREARM AND INJURY TO THE SHOOTER AND OTHER PERSONS. TAKE CARE TO USE THE CORRECT CARTRIDGES. DO NOT ATTEMPT TO LOAD ANY .22 RIMFIRE AMMUNITION INTO THE .22 HORNET MAGAZINE. DO NOT FIRE .17 HMR CARTRIDGES IN .22 MAGNUM RIFLES!**

The **RUGER MODEL 77/44™** is chambered *only* for the centerfire .44 Magnum cartridge and should not be used with any other .44 caliber ammunition. Most .44 Magnum ammunition factory loaded to U.S. industry specifications is suitable for use. However, “Medium Velocity” non-jacketed ammunition may not give optimum accuracy and is not recommended.



**WARNING: SOME TYPES OF LONG RIFLE CARTRIDGES HAVE BLUNT-NOSE OR SHARP-SHOULDER BULLETS WHICH CAN INTERFERE WITH SMOOTH AND RELIABLE FEEDING FROM MAGAZINE TO CHAMBER. SUCH CARTRIDGES SHOULD *NOT* BE USED BECAUSE THEY MAY DISCHARGE BEFORE BEING FULLY CHAMBERED AND THEREBY POSSIBLY INJURE THE SHOOTER AND THOSE NEARBY. THE SHOOTER MUST BE ALERT TO THIS POTENTIALLY DANGEROUS SITUATION AND SHOULD AT ONCE DISCONTINUE THE USE OF ANY CARTRIDGE WHICH APPEARS TO BE THE CAUSE OF FEEDING PROBLEMS OR JAMMING.**



## WARNING – LEAD EXPOSURE



Discharging firearms in poorly ventilated areas, cleaning firearms, or handling ammunition may result in exposure to lead and other substances known to the state of California to cause birth defects, reproductive harm, and other serious physical injury. Have adequate ventilation at all times. Wash hands thoroughly after exposure.

**SHOOTING OR CLEANING GUNS  
MAY EXPOSE YOU TO LEAD**



## WARNING – AMMUNITION



Death, serious injury, and damage can result from the use of wrong ammunition, bore obstructions, powder overloads, or incorrect cartridge components. Even the strongest gun can be blown up by excess pressure. Only use correct ammunition loaded to U.S. Industry Standards. Always wear shooting glasses and hearing protectors.



**IMPROPER AMMUNITION  
DESTROYS GUNS**

## AMMUNITION (CARTRIDGES) NOTICE

WE SPECIFICALLY DISCLAIM RESPONSIBILITY FOR ANY DAMAGE OR INJURY WHATSOEVER OCCURRING IN CONNECTION WITH, OR AS A RESULT OF, THE USE IN ANY RUGER FIREARMS OF FAULTY, OR NON-STANDARD, OR "REMANUFACTURED" OR HAND-LOADED (RELOADED) AMMUNITION, OR OF CARTRIDGES OTHER THAN THOSE FOR WHICH THE FIREARM WAS ORIGINALLY CHAMBERED.

## TO LOAD AND FIRE (WITH MAGAZINE)

Practice this important aspect of gun handling (with an unloaded rifle) until you can perform each of the steps – described below – with skill and confidence. **But before loading the rifle, please read completely through this manual, and be certain the muzzle is pointing in a safe direction. Do not load the rifle until you are ready to use it!**

(The following procedure assumes a new rifle with the bolt out.)

1. **Be certain the chamber is empty, the muzzle is pointing in a safe direction, and keep your fingers off the trigger until you are actually ready to fire.** (See Rule 2, p. 46).
2. Remove the magazine from the rifle (See Figure 5, below).



**Figure 5.** The safety should be in the "Load-Unload" position or the "Safe" position when the magazine is being removed or inserted. When the forward section of the magazine latch is pushed in (pivoted upward), the magazine is released. One way of removing the magazine is to cradle the rifle in the left hand with the palm under - but not against - the magazine. Use the right forefinger to fully depress the magazine latch and the magazine will drop free. Another way (illustrated) is to depress the latch with the thumb and at the same time grasp the magazine between the thumb and forefinger and draw it out of the gun.

3. **Position the safety selector in the "Load-Unload" position** (see Figure 3, p. 10).
4. Make certain the bolt is ready to be inserted in the receiver. If there is any doubt, see numbered paragraph 7, p. 23 (To Assemble the Bolt) in the Reassembly section of this manual.
5. Depress the bolt-stop and insert the bolt into the receiver, closing the bolt handle fully down.
6. **Move the safety selector fully rearward to the "Safe" position.** This will also lock the bolt closed (see Figure 4, p. 10).
7. Load the magazine with the cartridges (see Figure 6, p. 14).
8. Insert magazine into the magazine well of the rifle with the bullet end of the cartridges in the direction of the barrel muzzle. (The magazine cannot be seated if it is reversed.)
9. Assuming the rifle is now to be fired, move the safety selector to the "Load-Unload" position.

10. Raise the bolt handle, draw the bolt fully to the rear, then smoothly push the bolt forward so that a cartridge is stripped from the magazine and chambered. (Note: If the cartridge does not readily strip from the magazine, or if the cartridge tends to jam while being chambered, discontinue the loading procedure. Extract and eject the ‘problem’ cartridge and remove the loaded magazine from the rifle. Then, read the “Ammunition” and “Magazine Inspection and Care” sections of this manual) Now, lower the bolt handle.

**Figure 6.** To load the magazine, press the rim of the cartridge against the magazine rotor at the widest section of the magazine throat until the cartridge enters far enough to be pushed to the rear end of the magazine. With the first cartridge in place, each succeeding cartridge is pressed against the body of the top cartridge and slid to the rear of the magazine until a maximum of ten .22 LR cartridges (or nine .22 WMR or .17 HMR cartridges, or six .22 Hornet cartridges, or four .44 Magnum cartridges, depending upon the magazine being loaded) are in the magazine. The Ruger 77/22 & 77/44 rifles are designed to function properly only with the correct Ruger rotary magazine loaded with cartridges of the correct caliber and type.

The magazine must at all times be in good condition or malfunctions can occur. Please carefully read the sections in this manual on “Magazine Inspection and Care” and the section and warning on “Malfunctions”.

NOTE: The Ruger 10/22 magazine (BX-1) will fit in the model 77/22 rifle, but the bottom section of the 10/22 magazine will not be flush with the trigger guard assembly of the 77/22. The 9 shot Ruger 77/22 Magnum and .17 HMR magazine is **not** interchangeable with any other magazine, **nor** is the 6 shot 77/22 Hornet magazine. The .44 magnum magazines for the Ruger 96/44 lever action rifle and the Deerfield Carbine rifle will **not** fit into the Ruger 77/44 bolt action rifle due to dimensional differences. Do not attempt to use either of them in the Ruger 77/44.

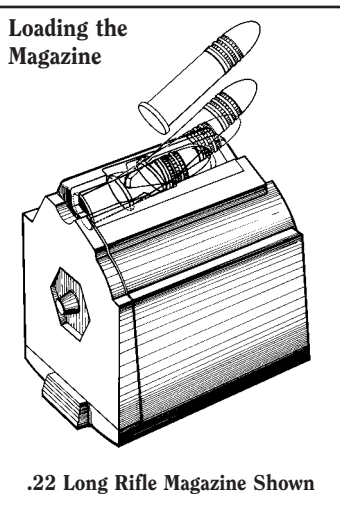

**WARNING: DO NOT TOUCH THE TRIGGER UNTIL YOU ARE ACTUALLY READY TO FIRE THE RIFLE.**

11. The rifle is now fully loaded. Unless the rifle is to be immediately fired, move the safety selector fully rearward to the “Safe” position.
12. To Fire the Rifle: Move the safety selector to the “Fire” position (see Figure 2, p. 10), and pull (squeeze) the trigger. A cartridge will be discharged. Always be certain that you know where the bullet will strike when you fire the rifle. (See “Handling Warning”, p. 16) Never allow the thumb to touch the cocking piece as it can be pinched when the striker moves forward.
13. After the chambered cartridge has been fired, the bolt handle is raised and the bolt is drawn to the rear in a firm, smooth stroke. This will extract and eject the fired cartridge case. To chamber another cartridge, repeat the procedure detailed directly above.



**WARNING:** REMEMBER THAT EACH TIME A CARTRIDGE IS FIRED AND A NEW ONE IS CHAMBERED. **THE SAFETY SELECTOR IS IN THE “FIRE” POSITION.** THEREFORE, IF THE RIFLE IS NOT GOING TO BE DISCHARGED IMMEDIATELY AFTER THE CARTRIDGE IS CHAMBERED, MOVE THE SAFETY SELECTOR FULLY BACK TO THE “SAFE” POSITION.

14. **To Single Load:** The rifle can be used as a single shot rifle in the absence of a magazine or for safety or training purposes. To do so, follow steps 1 - 3, p. 13. Then load a cartridge into the chamber, and follow steps 10 - 13, p. 14. See “Unloading Warning”, p. 17.



## WARNING – LOADING



Know the caliber of your rifle you are loading and load cartridges of only that caliber into it!

Before loading, be certain the primer of each cartridge is seated flush with, or below, the surface of the cartridge case base. A cartridge discharged by the closing of the bolt can result in possible serious injury to the shooter and those nearby.

If a cartridge does not chamber readily, do not force it. Check the bore and chamber to be certain that each cartridge is the proper caliber and of correct dimensions. If you cannot determine why the cartridge will not fit, clear the rifle of all cartridges and write or call the factory.

**The wrong ammunition can destroy your gun and result in serious injury.**



**BE SURE WHAT YOU LOAD  
IS CORRECT**



## WARNING – FIRING

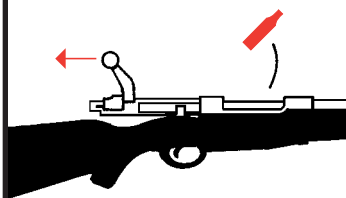

When firing the Model 77/22®, 77/17, or 77/44™ be sure that bystanders are well clear of the shooter and standing a safe distance to the rear. Empty cartridge cases are hot and are normally ejected from the rifle to the right. They could cause injury to any person who is standing too closely alongside the shooter. Shooters who fire right-hand rifles from their left shoulder should be particularly cautious concerning ejected cartridge cases and the back of the bolt as it is drawn rearward.

**EJECTED BRASS IS HOT**

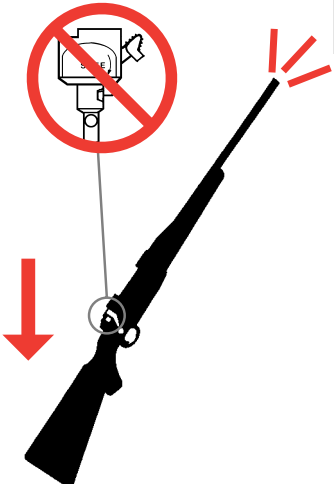
 <b>WARNING – HANDLING</b>	
	<p>Never carry the rifle loaded with the safety selector in the “FIRE” position. If dropped or struck with the safety off, the rifle may fire. Such a discharge can occur with or without the trigger being directly struck or touched. <b>Never rest a loaded rifle against any object (wall, fence, vehicle, tree, etc.)</b> because there is always the possibility that the rifle will be jarred or slide from its position and fall with sufficient force to discharge. <b>Keep safety on unless actually firing.</b></p> <p>Never lower (uncock) the firing pin with a loaded cartridge in the chamber. Under such circumstances the firing pin will be in direct contact with the primer of the loaded cartridge and a light accidental blow to the firing pin can readily cause the gun to discharge.</p>
<b>ANY GUN MAY FIRE IF DROPPED</b>	

## TO UNLOAD RIFLE AND MAGAZINE

(Rifle Must be Pointing in a Safe Direction)



**UNLOAD THE RIFLE IMMEDIATELY WHEN YOU ARE FINISHED SHOOTING.**

If it has been desired to discontinue shooting before all of the cartridges in the magazine and the chamber have been fired, proceed as follows (**Keep your fingers away from the trigger at all times during unloading**):

1. **Move the safety selector to the “Load-Unload” position.**
2. Remove the magazine.
3. Open the bolt carefully so the extracted live cartridge is not ejected forcibly.
4. Inspect the chamber to be certain the cartridge *has been* extracted.
5. Close the bolt fully.
6. Move the safety selector to the “Fire” position and *with the rifle pointed in a safe direction*, pull the trigger.
7. If necessary, cartridges can be removed from the magazine by simply pushing them lightly downward and forward with the thumb or forefinger. But, a better and safer procedure is to place the rubber eraser end of a pencil against the rim of the top cartridge and press lightly downward while pushing forward. **WARNING: Do not use a loaded cartridge as a “tool” to strip cartridges from the magazine.**

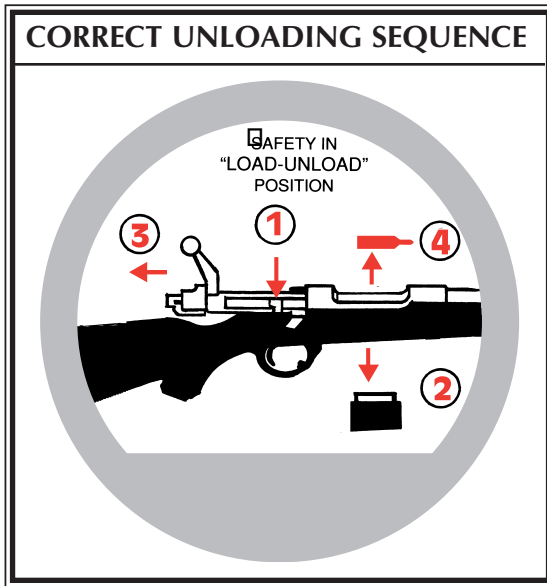
8. If the rifle is not cocked, as when a fired cartridge case is in the chamber or in the event of a misfire, carefully raise the bolt handle fully upward to cock it. (Do not retract the bolt at this point). Now, put the safety in the “Load-Unload” position, and repeat steps 3 - 6, p. 16.



	
<b>WARNING – UNLOADING</b>	
	Removing the magazine does not prevent the rifle from being fired! When there is a cartridge in the chamber and the safety selector is in the “Fire” position, the cartridge will discharge if the trigger is pulled. It is absolutely essential for the user to know how to completely unload it. “Completely” means removing the magazine <u>and</u> then removing a chambered cartridge. <b>The safety selector should always be in the “Load-Unload” position when the rifle is being loaded or unloaded.</b> See the “Operation of Safety” section of this manual.
	<b>GUN WILL FIRE WITH MAGAZINE OUT</b>



## TO EXTRACT AND EJECT A CHAMBERED CARTRIDGE

When the bolt is operated by hand, there can be a failure to extract the cartridge from the chamber, or a failure to eject the cartridge clear of the rifle. These failures usually are the result of the bolt not being pulled rearward vigorously, coupled with an accumulation of bullet lubricant in the chamber. From the foregoing it is clear that the gun user must:

1. **Always visually check the chamber after opening the bolt to eject a chambered cartridge.** If the bolt is not vigorously retracted when being operated by hand, the extracted cartridge can be 'ejected' into the magazine area, instead of outside the rifle.
2. Thoroughly clean the chamber and the extractor as often as necessary to prevent the accumulation of grease and dirt.
3. If an empty magazine is in the rifle when the bolt is being hand retracted to extract a cartridge, the cartridge may drop on top of the magazine. Then when the bolt goes forward, the cartridge will be chambered again! **Always remove the magazine before clearing the chamber, and visually ensure that no cartridges remain in the gun.**

## TO CLEAR A MALFUNCTION ("JAM")

**If a jam occurs, immediately put the safety selector in the "Load-Unload" position and be certain the muzzle of the rifle is at all times pointing in a safe direction.**

Then study the situation to determine the nature of the jam and how best to clear it.

- If a cartridge or fired case is caught between the bolt and the barrel, or against a cartridge that is in the chamber, open the magazine. Then retract the bolt fully and remove the jammed cartridge or case.
- When attempting to extract a cartridge that is "stuck" in the chamber do not use any type of tool that is likely to act as a "firing pin" and discharge the cartridge should the tool impact on the primer or rim of a rimfire cartridge.
- After clearing a jam, inspect the gun mechanism to determine if dirt might be the cause of the problem. Excess lubricant or grease can cause cartridges to feed sluggishly or fail to extract. An accumulation of grease or dirt on the face of the bolt, under the extractor, in the chamber, or in the magazine can contribute to cartridge feeding problems. (See sections on "Care and Cleaning", pp. 24 - 26).



## WARNING – MALFUNCTIONS



If a cartridge hangs up, jams, or binds when being chambered or when being fed from the magazine into the chamber, **do not attempt to force it into the chamber by pushing or striking the bolt handle.**

Most failures of a cartridge to feed or to chamber are caused by improper loading of the magazine or ammunition that is incorrect or defective.

Whatever the cause, the gun user must, above all, recognize that jams can result in the very potentially dangerous situation of a cartridge discharging before it is chambered. If this occurs, the cartridge case will rupture and its fragments will fly out of the gun with sufficient force to cause injury. Always wear shooting glasses and hearing protectors!



### STRIKING RIM OR PRIMER CAN BURST CARTRIDGE

- After clearing a jam, inspect all cartridges that have been removed from the gun. Safely dispose of any cartridges which are in any way damaged.
- If it appears that the rifle is not at fault and that the jam was caused by the type of cartridge being used, then try another type.
- Examine your fired cartridge cases. If they have split, blown or bulged heads, stop using that ammunition and promptly return the rifle to the factory for examination.
- If the above procedures do not result in a smooth and reliably functioning firearm, don't use the rifle. The **RUGER MODEL 77/22®**, **MODEL 77/17** or **MODEL 77/44™** can be returned directly to our Newport Product Service Department for inspection and repair, if required. See the “Service and Parts Policy”, p. 30, for packing and shipping information.

## TO MINIMIZE MALFUNCTIONS (“JAMS”)

Firearms of all makes and types are susceptible to occasional malfunctioning due to a cartridge not feeding from the magazine to the chamber, or due to a cartridge or fired case not being extracted and ejected.

To minimize the possibility of such occurrences the gun user should:

- Use ammunition of the correct caliber and type which is loaded to U.S. Industry Specifications. Do not use cartridges that are deformed, or cartridges that have been reloaded.
- Clean and lubricate the gun in accordance with the instructions in this manual.
- Learn to correctly operate the bolt and how to properly load and empty the chamber and magazine.
- If the mechanism shows signs of not functioning correctly, or if a part is damaged or broken – don't use the rifle. Have it inspected and repaired.

For most repairs we recommend that Ruger guns be returned to the factory, However, if a gun has a cartridge in it which cannot be removed, then it is a violation of Federal Regulations to ship that loaded gun whether it be by U.S. Mail or by common carrier. Contact our Newport Product Service Department at (603) 865-2442.

## BASIC DISASSEMBLY AND REASSEMBLY

 <b>WARNING – DISASSEMBLY</b>	
	Always unload a firearm before cleaning, lubrication, disassembly or assembly.
<b>UNLOAD BEFORE CLEANING</b>	

It is preferable to carry out these procedures on a workbench or table which has a covered top. A piece of shallow nap rug or an old, coarse blanket is an ideal covering. Such a covering not only reduces the chances of the rifle slipping and being scratched, but it serves also to trap pins, plungers and springs that may otherwise get lost. It is advisable to have a container – such as a shoebox – in which each part can be placed as it is removed from the gun.

Before attempting to disassemble the rifle for the first time, study the parts drawing and parts list so as to be familiar with the relative position, appearance and name of each part. Carry out the disassembly slowly, and carefully note the position of the part in the gun before starting to remove it. If a part is under spring tension (such as, the Safety Selector, Bolt Stop, Trigger) remove it cautiously and anticipate the direction the spring and plunger are most likely to “jump.”

**WARNING:** If a spring or plunger become lost do not use a substitute. Springs of correct tension are vital to the safe and reliable performance of firearms. Before starting disassembly, remove the sling, scope and rings and place the rear sight blade in its down flat position.

## **DISASSEMBLY**

**(Rifle Must Be Unloaded Prior To Disassembly)**

1. **Keep the rifle pointed in a safe direction! Put the safety in the “load-unload” position, then, remove the magazine.**
2. **OPEN THE BOLT AND CHECK TO BE CERTAIN THAT THE CHAMBER IS EMPTY.**
3. **To remove the bolt:** Before starting bolt disassembly, study Figure 10, below.  
Lift the bolt handle up. Depress the bolt stop on the left side of the receiver.  
Remove the bolt from the rifle.
4. **To disassemble the bolt:**
  - a. While holding the bolt handle, rotate the bolt sleeve clock-wise (as viewed from the rear of the rifle) to position shown in Figure 7.
  - b. Rotate the breech block until the head of the breech block retaining pin is aligned with the larger holes in the bolt. (Figure 7).
  - c. Push out the breech block retaining pin by inserting a pin through the small hole on the side opposite from the larger hole. The alignment must be precise to remove the retainer. (Figure 7).
  - d. Remove the breech block assembly by sliding it forward out of the bolt (Figure 8).
  - e. Insert a small pin (or suitable nail) into the “disassembly hole” in the striker/cocking piece assembly to hold it in the rear position (Figure 8). **NOTE:** The pin should be as close as possible in size to the hole diameter, and at least 2 inches long so that it can be used to ‘lever’ the cocking piece to the rear when reassembling the bolt stop assembly into the bolt.
  - f. Unscrew the bolt sleeve (Figure 9). Remove the bolt sleeve assembly. Firing pin can now be removed from the bolt sleeve assembly (Figure 10).

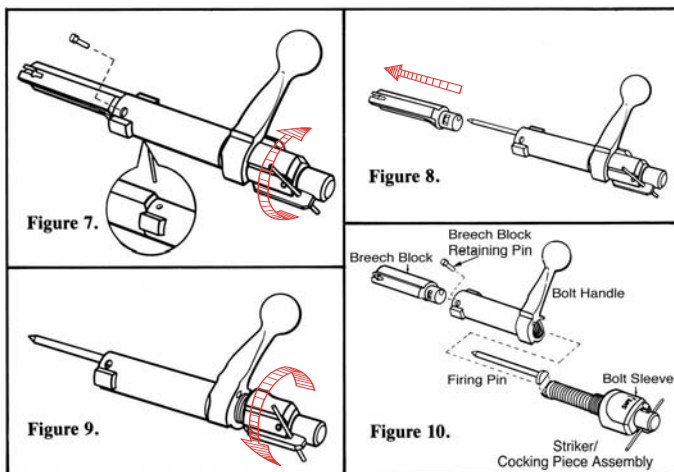



**CAUTION:** The bolt sleeve assembly is intended to be a permanent assembly and should not be disassembled. The parts are under great spring pressure and if disassembled could fly apart with sufficient force to cause serious injury. Also, special tools are required to correctly reassemble this part.

5. To remove the stock: (Be certain the bolt and magazine have been removed from the rifle.)

NOTE: On the K77/22RP & RSP models, disregard step “b” and magazine well liner in step “c”, below.

- a. Remove the rear mounting screw in the trigger guard.
- b. Swing the rear of the trigger guard out of the stock to clear trigger. Unhook trigger guard assembly from the receiver. Remove the trigger guard assembly.
- c. Remove the front mounting screw and magazine well liner.
- d. VERY CAREFULLY lift the barrel/receiver assembly from the stock.

6. To remove the barrel: (.22 LR, .22 Magnum, and .17 HMR Rifles Only)

- a. Remove the (2) barrel retainer screws and barrel retainer.
- b. Slide the barrel forward to remove it from the receiver.

**NOTE:** .22 Hornet and .44 Magnum caliber barrels are threaded into the receiver and should *not* be removed except by the factory.

7. To remove the trigger: (Safety Selector should be in the “Fire” position).

- a. While holding the trigger in place, press out the trigger pivot pin. (Caution: Trigger is spring loaded and under tension --- be careful!)
- b. Remove the trigger and trigger/sear spring.

8. To remove the sear:

- a. Press out the sear pivot pin.
- b. Turn receiver upside down and slide sear forward. Sear will drop out of the top slot in the receiver.

9. To remove safety assembly:

- a. Rotate the safety selector so that the upper section is positioned fully over the center of the receiver tang.
- b. While holding the safety selector in place with thumb and forefinger, slide the retainer up out of receiver. (Caution: Safety Selector is under spring tension from a spring and plunger acting against the lower section of the safety selector. The spring and plunger will jump out if not contained).
- c. Lift out the safety selector.
- d. Remove the safety selector detent and safety selector detent spring.

10. To remove the bolt stop:

- a. Depress the bolt stop plunger (with the tip of a jewelers screwdriver blade or similar tool) and remove the bolt stop from the pivot. (Caution: This spring and plunger will jump out.)
- b. Remove the bolt stop plunger and bolt stop plunger spring.

# REASSEMBLY

(Again, Be Sure Rifle Is Unloaded)

1. To replace the bolt stop:
  - a. Replace the bolt stop plunger and bolt stop plunger spring. (Be certain that the step flats on the plunger match the flats on the mating surface of the bolt stop.)
  - b. Depress the bolt stop plunger and replace the bolt stop on the pivot.
2. To replace the safety assembly:
  - a. Place the safety selector detent and safety selector detent spring into the hole in the receiver.
  - b. Set the safety selector in place with its upper section positioned over the center of the receiver tang.
  - c. While holding the safety selector in place with thumb and forefinger, slide the safety selector retainer into dovetail from the top. Align the notch in the safety selector retainer with the sear pivot pin hole.
3. To replace the sear:
  - a. Place the rear end (the end with the hole in it) of the sear into the slot from the top of the receiver. Swing the rear end of the sear up and slide the sear into position until the hole in the sear is aligned with the mating holes in the receiver.
  - b. Insert the sear pivot pin.
4. To replace the trigger:
  - a. Place the trigger/sear spring over the dimple in the trigger.
  - b. Assemble the trigger while aligning the spring with the dimple on the sear.
  - c. While holding the trigger in position, replace the trigger pivot pin.
5. To replace the barrel: (.22 LR, .22 Magnum, and .17 HMR Rifles Only)
  - a. Assemble the barrel into the receiver assembly.
  - b. Replace the barrel retainer and barrel retainer screws.
6. To replace the barrel/receiver assembly into the stock: (Caution: Be certain that the pivot pins are not protruding from either side of the receiver.)

NOTE: On the K77/22RP & RSP models, disregard magazine well liner installation in step “b”, and all of steps “c” & “d”, below.

  - a. Carefully install the barrel/receiver assembly into the stock, making sure the barrel/receiver assembly is in the most rearward position.
  - b. Install the magazine well liner and front mounting screw.
  - c. Hook the forward end of the trigger guard assembly into the receiver.
  - d. Swing the rear of the trigger guard into position.
  - e. Install the rear mounting screw.
7. To assemble the bolt:
  - a. Place the firing pin into the mating slot in bolt sleeve assembly.
  - b. Slide the bolt sleeve assembly into the bolt from the rear.
  - c. Screw the bolt sleeve into the bolt to position shown.
  - d. Install the breech block into the front end of the bolt.
  - e. Align the holes in the breech block with the hole in the bolt.

- f. Replace the breech block retaining pin. Flats on the breech block retaining pin must align with the slot in the breech block when the retaining pin is installed.
- g. Rotate the bolt sleeve assembly in counter-clockwise position until the cocking piece engages **small notch** in the bolt.
- h. Remove the pin or nail from the cocking piece. If the breech block does not rotate freely about 1/16" in both directions, then reinsert the pin or nail in the cocking piece hole and check to be certain that the breech block retaining pin is fully seated. Only when the bolt is correctly assembled should it be inserted into the receiver.
- i. Insert the bolt into the receiver.

**REGARDING ACCURACY:** The accuracy of any rifle can vary depending upon the make and type of cartridges used in it. Such being the case, if your **RUGER MODEL 77/22<sup>®</sup>, MODEL 77/17, or MODEL 77/44<sup>™</sup>** rifle does not perform to expectations, it is advisable to try several brands and types of cartridges to determine which one delivers the best accuracy, before proceeding further. If your rifle is not as "accurate" as you believe it should be, before concluding that some serious fault exists, run the following checks:

1. Be certain the front mounting screw and the rear mounting screw are snugly tightened.
2. Be certain the bore is clean and free from accumulated fouling (deposited by powder and lead bullets). See the "Care and Cleaning" section of this Manual, pp. 25 - 26.
3. Check the sights, or scope mounting system, for tightness, setting and alignment.
4. Be certain the two barrel retainer screws are fully tightened.

If everything is tight, the bore is clean, the sights are properly aligned and secure but the accuracy problem persists, **DO NOT alter the stock bedding in any way.** Do not scrape away wood, and do not bed with "glass," plastic, epoxy, etc. Once a rifle stock has been altered, it cannot be reworked by our Product Service Department. If you still have an accuracy problem, write a brief letter to our Product Service Department, 411 Sunapee Street, Newport, New Hampshire 03773 and describe the nature of the problem based on the use of factory-loaded cartridges – not reloads. You will receive a prompt response from us and if indicated, detailed instructions with regard to the return of the rifle.

## MAGAZINE INSPECTION AND CARE

Check the magazine frequently. The rotor must move freely and have adequate tension so that each cartridge is quickly raised to the feeding position. At the time of manufacture, proper rotor tension is set by rotating the magazine cap nut until the rotor stops turning. Then the nut is turned an additional 1 1/4 turns beyond the 'stop' position.

To test the rotor tension, load one cartridge into the magazine and then firmly press against the side of the cartridge case. Remove your finger quickly. The cartridge should instantly and fully move into the feeding position. If it does not, the magazine should be cleaned. **If cleaning does not restore proper rotor tension, do not use the magazine.** (NOTE: After testing, remove the test cartridge).

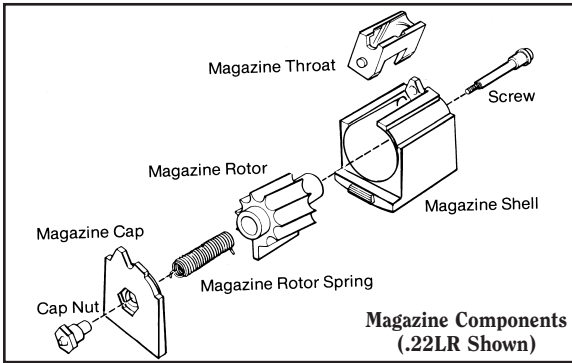

Exploded view of the 77/22<sup>®</sup> Long Rifle magazine components. This illustration is included to show the relationship and names of the magazine components. The 77/22<sup>®</sup> Magnum, .17 HMR, 77/22<sup>®</sup> Hornet, and 77/44<sup>™</sup> magazines are similar. As noted in the text above, the magazine should not be disassembled.

When cleaning is necessary, use a solvent that will not rust the metal components or adversely affect the plastic magazine box. After the magazine has been soaked in solvent to loosen foreign matter, be certain to shake it vigorously (with the loading opening away from you) to remove solvent or residue from within the magazine.

After cleaning, always check to be certain that rotor movement and tension are correct, and that no solvent or debris remain. Do not disassemble the magazine. **Improper reassembly or improper tensioning of the rotor spring can cause a potentially dangerous malfunction. If you experience a problem with the magazine, don't use it. Get a new one.**

**DAMAGED, NON-STANDARD, OR IMPROPERLY ASSEMBLED MAGAZINES SHOULD NOT BE USED. THEY CAN CAUSE THE RIFLE TO MALFUNCTION.**

## CARE AND CLEANING



**WARNING: BEFORE CLEANING, BE CERTAIN THE RIFLE AND ITS MAGAZINE CONTAIN NO CARTRIDGES.**



A firearm must be free of rust, dirt, grease and firing residues to function safely and reliably. Periodic maintenance, which includes inspection of components to determine if they are in proper working order, is absolutely essential. Firing deposits particles of bullet lubricant and powder in the bore, chamber, bolt, receiver, magazine and other parts of the rifle. There is no fixed rule as to how frequently the cleaning should be carried out, but the alert gun owner soon learns that any firearm functions most reliably and accurately when it is free of accumulations of grease and other firing residues.

Basic cleaning equipment includes: A correct size cleaning rod equipped with bore brushes (fiber and brass) and a tip in which a cloth patch can be inserted, patches, powder solvent, lubricant, small lint-free cloths and a toothbrush. Use correct size patches and brushes. Larger sizes will bind in the bore and can be very difficult to remove!



Insert rod from the chamber end of the barrel and push firmly so the patch or brush emerges from the muzzle. Don't reverse the rod when a brush or patch is being used – it may bind. Don't use patches or brushes dripping with solvent or oil. Use rod and brushes with care so as not to damage gun.

1. Disassemble (field-strip) the rifle to the extent described on pages 21 - 22.
2. Push-pull a solvent-wetted patch through the bore several times. Next, using a solvent-wetted brush, run it the full length of the bore as many times as is necessary to completely remove all foreign matter from the bore and chamber. Dry the bore with clean patches and examine it. If bore remains fouled, repeat the brushing. Complete the cleaning by dry-patch wiping of bore and chamber.
3. Use a clean, solvent-wetted patch to remove firing residue and dirt from all "reachable" surfaces inside the receiver. Use the solvent-wetted toothbrush to dislodge caked dirt from all parts of the bolt assembly and from surfaces inside the receiver that can't be reached with a patch. Use cleaning patches or the cloth to remove the solvent.
4. Wipe all surfaces – internal and external – with a very light coat of oil. Oil and similar preparations "collect" dirt particles which can interfere with reliable functioning of the rifle. Therefore, use these preparations very sparingly. A drop of oil applied to the bolt assembly components, the pivot points of the trigger mechanism, the safety, the bolt stop, and the magazine latch, will work into all the parts that need lubrication.
5. Reassemble the rifle and carefully wipe all solvent, lubricating and preservative preparations from the stock.
6. If the rifle is to be stored for an extended period, clean the rifle thoroughly. Disassemble to the extent described elsewhere in this manual, taking care to put pins and similar easily mislaid and "rolling" components in a tray. Rewipe all surfaces with preservative oil. Reassemble and store properly.

 <b>WARNING – LUBRICATION</b>	
	<p>Firing a rifle with oil, grease, or any other material even partially obstructing the bore may result in damage to the rifle and serious injury to the shooter and those nearby. Do not spray or apply lubricants directly on ammunition. If the powder charge of a cartridge is affected by the lubricant, it may not be ignited, but the energy from the primer may be sufficient to push the bullet into the bore where it may become lodged. Firing a subsequent bullet onto the obstructed bore may damage the revolver and cause serious injury or death to the shooter and those nearby. Use lubricants properly. You are responsible for the proper care and maintenance of your firearm.</p>
	<b>IMPROPER LUBRICATION DESTROYS GUNS</b>

# STORAGE

**GUNS SHOULD NOT BE STORED LOADED!**

**USE THE LOCKING DEVICE SUPPLIED WITH THE RIFLE FOR STORAGE.  
(SEE PAGE 6)**

*Do not* store the rifle in a leather case or scabbard. Leather attracts moisture, even though the case may appear to be perfectly dry.

## TO RENDER THE RIFLE INOPERATIVE FOR SAFE STORAGE

With the muzzle pointed in a safe direction, remove the magazine (if applicable), open the bolt, and check the chamber and the magazine to be sure the rifle is completely unloaded! Depress the bolt latch, located at the left rear of the receiver. Now pull the bolt fully to the rear. The bolt will come out the rear of the receiver.

Store the rifle and the bolt in different locations. When disassembled in this manner, the rifle is inoperable. It is impossible to fire the rifle until the bolt has been correctly replaced into the rifle's receiver.

To reassemble the rifle for firing, reinsert the bolt into the receiver from the rear. With the muzzle pointed in a safe direction, close the bolt. Check to be sure that the bolt can be operated fully and freely. The rifle is now reassembled and can be loaded and fired normally.

**While the rifle is less likely to be used by unauthorized persons when disassembled in the above manner, it is always safest to store any firearm with the supplied locking device correctly installed, or to store the firearm in a gun safe or other secure location away from children and unauthorized adults. Guns should always be stored securely, unloaded and separate from their ammunition.**

 <b>WARNING – STORAGE</b>	
	<p>Never place or store any firearm in such a manner that it may be dislodged. Firearms should always be stored securely and unloaded, away from children and careless adults. Use the locking device supplied with the rifle for storage.</p> <p>The use of a locking device or safety lock is only one aspect of responsible firearms storage. For increased safety, firearms should be stored unloaded in a location that is both separate from their ammunition and inaccessible to children and any other unauthorized person.</p>
<b>STORE SECURELY &amp; UNLOADED</b>	

## MAINTENANCE OF STAINLESS STEEL RIFLES

Firearms and components made of stainless steel are relatively more resistant to corrosion than those of blued steel. However, in the interest of proper operation and long life of a stainless steel firearm, inspect it frequently and clean, lubricate and apply an appropriate rust preventative.

Sometimes discoloration occurs from perspiration or from contact with some types of gun cases. Rusting may occur as a result of the firearm being exposed to moisture, salt air or chemicals.

Minor discoloration can usually be removed by rubbing the stainless area with an abrasive ink eraser, crocus cloth, or a "metal polishing" compound. When using any of these abrasives, proceed with care and use light pressure to achieve a blending of "color" with those areas that are not discolored.

External surfaces most subject to rusting from handling, or from exposure to the elements should be cleaned and wiped dry after use or after exposure to adverse conditions. If the rifle is to be stored, coat it with a light film of oil or preservative. Where the rifle is in continuing use, and the presence of oil or grease would be objectionable, then the external surfaces can be coated (after cleaning and drying) with a paste wax formulated for use on metals. Apply the wax sparingly, allow time for it to dry hard, then buff lightly with a soft cloth. When applying the wax, take care that it does not get into the mechanism or on the functioning parts or in the bore.

## ATTACHING RUGER SCOPE RINGS

Each Ruger telescope ring is a mated assembly of a top and a base. Do not mix the parts of the two ring assemblies as they are not interchangeable. On the underside of each mounting ring assembly there is an integral lug, located off center with respect to the front and back sides of the mount. The lug is nearer to the front surface. By reference to the lug, the mounting ring can be correctly assembled with the front of the ring toward the muzzle of the rifle.

1. Disassemble one ring and reassemble over the scope body between the turret and the eyepiece. Remember - the lug on the base should be on the front side of the scope.
2. Install the four top screws. Do not tighten.
3. Disassemble the other ring and install it on the forward section of the scope tube with the lug forwardly also. Install the four top screws. Again, do not tighten.
4. Assemble the rings to the receiver with the lugs engaging the recesses in the top surface of the receiver. Tighten the clamp nuts so that the rings are locked to the semicircular cuts on the sides of the receiver.
5. Rotate the scope until cross-hairs are aligned properly and slide scope to desired eye relief. Then tighten the eight top screws each a bit at a time to grip the scope body.
6. Sight in according to the directions with your scope.

## SIGHT ADJUSTMENT

(For Rifles Equipped With Open Sights)

The folding leaf rear sight is adjustable for elevation. The slide must be moved one graduation to change the point of impact by approximately one inch at 25 yards. Shooting to determine the slide setting for 'zero' at a particular distance should be done from a bench rest and over a measured distance. Use only a small screwdriver with a blade tip that exactly fits the screw-head. Loosen the screws only slightly so the slide doesn't move too freely. Move the slide in the direction you want the point of impact of the bullet to move. When the slide is positioned at the desired height, carefully tighten both screws.

Lateral (windage) adjustment is made by "drifting" the sight base in its slot. Place a short brass rod against the sight base (and only the base) and tap the sight in the direction you wish to move the point of impact.

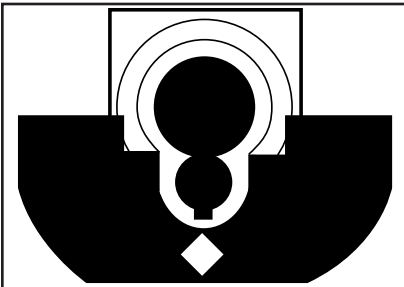

### SUGGESTED SIGHT PICTURE

Top of front sight even with top of rear sight slide. Front sight centered in notch of rear sight slide. Target bull's-eye centered on top of front sight.

## SERVICE AND PARTS POLICY

If you have any question with regard to the performance of your **RUGER MODEL 77/22®**, **MODEL 77/17**, or **MODEL 77/44™** rifle please write or call (603-865-2442) our Product Service Department, 411 Sunapee Street, Newport, New Hampshire 03773, fully describing all circumstances and conditions involved. If you should return your rifle to the factory for repair, or order parts for it, please comply with the following suggestions for prompt service:



**WARNING: BEFORE SHIPPING ANY FIREARM, BE ABSOLUTELY CERTAIN THAT IT AND ITS MAGAZINE ARE UNLOADED. DO NOT SHIP CARTRIDGES WITH A FIREARM.**

### SHIPPING FIREARMS FOR REPAIR

**RUGER MODEL 77/22®**, **MODEL 77/17**, or **MODEL 77/44™** rifles returned to the factory for repair should be sent to: Sturm Ruger & Company, Inc., Product Service Department, 411 Sunapee Street, Newport, New Hampshire 03773. Telephone (603) 865-2442. Guns should be sent prepaid. We will not accept collect shipments.

The Federal Gun Control Act, as well as the laws of most States and localities, do not prohibit an individual (who is not otherwise barred from purchasing or possessing a firearm) from shipping a firearm directly to the manufacturer for repair. However, before you ship your rifle to us, be certain that your State or locality does not have a law or regulation which will prohibit you from receiving the rifle from us after it has been repaired. If such receiving is prohibited, then please have a Federally Licensed firearms dealer ship the gun to us. If your rifle is sent to us by a dealer, it will be returned to him after being repaired. If a handgun (pistol or revolver) is shipped by an individual who does not hold a Federal Firearms License, it must be shipped via U.P.S. (Next Day Air) Persons who do not hold a Federal Firearms License are prohibited by Federal law from shipping a handgun by Mail. Handguns mailed in violation of the law are impounded by the Post Office.

Please do not include rifle case, sling, telescopic sights or custom accessories with a firearm being shipped to the factory for service. **DO NOT SEND GUN BOXES OR LITERATURE THAT YOU CONSIDER TO BE COLLECTOR'S ITEMS – THESE ARE INVARIABLY DAMAGED OR DESTROYED IN SHIPMENT.** Rifles and shotguns may be shipped your Parcel Post. Always insure your shipment.

Enclose a letter which includes your name, address, telephone number, serial number and model of the firearm. Describe in detail the trouble you have experienced with your firearm, or the work you wish to have done. Merely stating that the firearm "needs repair" is inadequate information.

Work performed will bear a net minimum labor charge of \$20.00 plus a \$12.00 shipping and handling charge. The charge for rebluing the **MODEL 77/22®**, **MODEL 77/17**, or **MODEL 77/44™** rifle is \$50.00 plus a \$12.00 shipping and handling charge. Custom gunsmithing service or non-standard alterations are NOT AVAILABLE from Ruger Product Service Departments.



## WARNING – PARTS PURCHASERS



It is the purchaser's responsibility to be absolutely certain that any parts ordered from the factory are correctly fitted and installed. Firearms are complicated mechanisms and **IMPROPER FITTING OF PARTS MAY RESULT IN A DANGEROUS MALFUNCTION, DAMAGE TO THE FIREARM, AND SERIOUS INJURY TO THE SHOOTER AND OTHER PERSONS.** The purchaser and installer of parts must accept full responsibility for the correct adjustment and functioning of the firearm after such installation.

**PARTS MUST FIT CORRECTLY**

## ORDERING PARTS

Please contact the New Hampshire Product Service Department for parts availability and current prices. All parts orders for the **MODEL 77/22<sup>®</sup>**, **MODEL 77/17**, or **MODEL 77/44<sup>™</sup>** should be sent to: Sturm, Ruger & Co., Inc., Product Service Department, 411 Sunapee Street, Newport, New Hampshire, 03773, (603) 865-2442.

We cannot comply with open account or C.O.D. requests. Payment in the form of a check, money order, Visa or Mastercard must accompany your order. Credit Card orders must include the account number, expiration date and whether it is a Visa or Mastercard account. Minimum parts order is \$1.00 plus a \$3.50 shipping and handling charge. Order parts by Part Number and Part Name and include the entire serial number of the firearm for which the parts are being ordered. There is a minimum net labor charge of \$20.00 plus \$12.00 shipping and handling charge if the parts are factory fitted. All factory-fitted parts are fitted on an exchange basis only. We will not return the replaced parts.

Because the receiver of the **MODEL 77/22<sup>®</sup>**, **MODEL 77/17**, and **MODEL 77/44<sup>™</sup>** rifles is a serial numbered component, it is defined as a "firearm" by Federal law and is not sold as a separate component.

\*Parts designated by an asterisk must be factory fitted. These parts are fitted on an exchange basis only. We will not return the replaced parts. We will not return any part that is broken, malfunctioning, badly worn or has been modified. See "Warning — Parts Purchasers", above.



**CAUTION: A gun containing modified, broken, malfunctioning, or badly worn parts should not be fired.**

# **RUGER® MODEL 77/22® LR & MAG. & MODEL 77/17 RIFLES**

## **PARTS LIST**

Design, prices and specifications subject to change without notice.

SPECIFY MODEL AND CALIBER WHEN ORDERING

(See Exploded Views on Pages 38 & 39)

<b>Part Name</b>	<b>Part No.</b>	<b>Model</b>
* Barrel 20" - .22 LR	0J8001	Standard 77/22 - without Sights
* Barrel 20" - .22 LR	K0J8001	All-Weather 77/22 - without Sights
* Barrel 20" - .22 Mag.	0J8002	Standard 77/22 - without Sights
* Barrel 20" - .22 Mag.	K0J8002	All-Weather 77/22 - without Sights
* Barrel 20" - .22 LR	0J8003	Standard 77/22 - with Sights
* Barrel 20" - .22 LR	K0J8003	All-Weather 77/22 - with Sights
* Barrel 20" - .22 Mag.	0J8004	Standard 77/22 - with Sights
* Barrel 20" - .22 Mag.	K0J8004	All-Weather 77/22 - with Sights
* Barrel 24" - .22 LR	K0J8010	Varmint 77/22
* Barrel 24" - .22 Mag.	K0J8005	Varmint 77/22
* Barrel 22" - .17 HMR	0J8017	Standard & All-Weather 77/17
* Barrel 24" - .17 HMR	K0J8007	Varmint 77/17
Barrel Retainer, V-Block	B-66	All Models
Barrel Retainer Screw, 2 Req'd.	J05100	All Models
* Bolt Handle	J01001	Standard 77/22
* Bolt Handle	KJ01001	All-Weather 77/22; Standard & All-Weather 77/17
* Bolt Handle	KJ01001T	Varmint 77/22; Varmint 77/17
Bolt Lock Plunger	J02600	Standard 77/22

<b>Part Name</b>	<b>Part No.</b>	<b>Model</b>
Bolt Lock Plunger	KJ02600	All-Weather 77/22; Standard & All-Weather 77/17
Bolt Lock Plunger	KJ02600T	Varmint 77/22; Varmint 77/17
Bolt Lock Plunger Retainer	J04600	All Models
Bolt Lock Plunger Spring	J04500	All Models
Bolt Sleeve	J01700	Standard 77/22
Bolt Sleeve	KJ01700	All-Weather 77/22; Standard & All-Weather 77/17
Bolt Sleeve	KJ01700T	Varmint 77/22; Varmint 77/17
Bolt Stop	J05300	Standard 77/22; Standard & All-Weather 77/17
Bolt Stop	KJ05300	All-Weather 77/22
Bolt Stop	KJ05300T	Varmint 77/22; Varmint 77/17
Bolt Stop Plunger	J05200	All Models
Bolt Stop Plunger Spring	J05400	All Models
* Breech Block Assembly - .22 LR	J20900	Standard 77/22
* Breech Block Assembly - .22 LR	KJ20900	All-Weather 77/22
* Breech Block Assembly - .22 Mag.	J20901	Standard 77/22
* Breech Block Assembly - .22 Mag. & .17 HMR	KJ20901	All-Weather 77/22; Standard & All-Weather 77/17
* Breech Block Assembly - .22 LR	KJ20900T	Varmint 77/22
* Breech Block Assembly - .22 Mag. & .17 HMR	KJ20901T	Varmint 77/22; Varmint 77/17
Breech Block Retainer	J00800	All Models
Butt Plate Screw, 2 Req'd.	B-91	All-Weather 77/22; All-Weather 77/17
Cartridge Support	KJ01500	All Models
Cartridge Support Plunger	KJ01600	All Models
Cartridge Support Spring	J00700	All Models
Cocking Piece	KJ01800	Standard & All-Weather 77/22; Standard & All-Weather 77/17



<b>Part Name</b>	<b>Part No.</b>	<b>Model</b>
Cocking Piece	KJ01800T	Varmint 77/22; Varmint 77/17
Escutcheon, Not Illustrated, 2 Req'd.	B-51	All-Weather 77/22; All-Weather 77/17
* Extractor	KJ01402	All Models
Extractor Plunger	KJ01600	All Models
Extractor Spring	J01900	All Models
Ferrule, Left Side, 3 Req'd.	W01015	All-Weather 77/22; All-Weather 77/17
Ferrule, Right Side, 3 Req'd.	W01014	All-Weather 77/22; All-Weather 77/17
* Firing Pin	J01100A	All Models
Front Forearm Insert Screw, Front	KJ00415	All-Weather 77/22; All-Weather 77/17
Front Forearm Insert Screw, Rear	KJ00416	All-Weather 77/22; All-Weather 77/17
Front Mounting Screw	J04700	Standard 77/22; Standard 77/17
Front Mounting Screw	KJ04701	All-Weather 77/22; All-Weather 77/17
Front Mounting Screw	KJ04700T	Varmint 77/22; Varmint 77/17
Front Sight - .22 LR	J06000	Standard & All-Weather 77/22 - with Sights
Front Sight - .22 Mag.	J06001	Standard & All-Weather 77/22 - with Sights
Front Sling Swivel	KJ00420	All-Weather 77/22; All-Weather 77/17
Front Sling Swivel Pin	KJ00422	All-Weather 77/22; All-Weather 77/17
Magazine Complete, 10-shot	JX-1	All .22 LR Models
Magazine Complete, 9-shot	JMX-1	All .22 Mag. & .17 HMR Models
Magazine Latch Lever	J03400	Standard 77/22; Standard 77/17
Magazine Latch Lever	J03401	All-Weather 77/22; All-Weather 77/17
Magazine Latch Lever	J03402	Varmint 77/22; Varmint 77/17
Magazine Latch Block Retainer, Not Illustrated	J08800	All-Weather 77/22; All-Weather 77/17

<b>Part Name</b>	<b>Part No.</b>	<b>Model</b>
Magazine Latch Pivot Pin	J03500	Standard & Varmint 77/22; Standard & Varmint 77/17
Magazine Latch Pivot Pin	KJ03501	All-Weather 77/22; All-Weather 77/17
Magazine Latch Plunger	J04000	Standard & Varmint 77/22; Standard & Varmint 77/17
Magazine Latch Plunger	B-36	All-Weather 77/22; All-Weather 77/17
Magazine Latch Plunger Spring	B-37	All Models
Magazine Well Liner	J00600	Standard 77/22; Standard 77/17
Magazine Well Liner	KJ00600T	Varmint 77/22; Varmint 77/17
Pistol Grip Cap	D08001	Standard 77/22; Standard 77/17
Pistol Grip Cap Medallion	D-82	Standard 77/22; Standard 77/17
Pistol Grip Cap Screw	C-96SM	Standard 77/22; Standard 77/17
Pistol Grip Insert Screw	KW01300	All-Weather 77/22; All-Weather 77/17
Rear Mounting Screw	J04800	Standard 77/22; Standard 77/17
Rear Mounting Screw	KJ04802	All-Weather 77/22; All-Weather 77/17
Rear Mounting Screw	KJ04800T	Varmint 77/22; Varmint 77/17
Rear Sight	J06100	Standard & All-Weather 77/22 - with Sights
Rear Sling Swivel	KJ00421	All-Weather 77/22; All-Weather 77/17
Rear Sling Swivel Pin	KJ00423	All-Weather 77/22; All-Weather 77/17
Recoil Pad	J05602	All-Weather 77/22; All-Weather 77/17
Recoil Pad, Black, Rubber	D06304	Standard & Varmint 77/22; Standard & Varmint 77/17
Recoil Pad Screws, 2 Req'd	D-84	Standard & Varmint 77/22; Standard & Varmint 77/17
* Safety Selector	J03800	Standard 77/22; Standard & All-Weather 77/17
* Safety Selector	KJ03800	All-Weather & Varmint 77/22; Varmint 77/17
Safety Selector Detent	J04300	All Models
Safety Selector Detent Spring	D-32	All Models

<b>Part Name</b>	<b>Part No.</b>	<b>Model</b>
Safety Selector Retainer	J02100	Standard 77/22; Standard & All-Weather 77/17
Safety Selector Retainer	KJ02100	All-Weather & Varmint 77/22; Varmint 77/17
Scope Ring Clamp	D-74	All Models, except Varmint 77/17
Scope Ring Clamp, Matte Gray	KD74M	Varmint 77/17
Scope Ring Nut	D-73	All Models, except Varmint 77/17
Scope Ring Nut, Matte Gray	KD73M	Varmint 77/17
Scope Ring Screw, 8 Req'd	D-76	All Models
Scope Base Torx® Head Screw, 8 Req'd.	MPF07602	Standard 77/22; Standard & All-Weather 77/17 - blued
Scope Base Torx® Head Screw, 8 Req'd.	KMPF07602M	Standard & All Weather 77/22 - stainless Varmint 77/22; Varmint 77/17 - matte finish
Scope Rings, Low	S100RL	Standard 77/22
Scope Rings, Low	KS100RL	All-Weather 77/22
Scope Rings, Medium, Matte Gray	KD72MTG	Varmint 77/22
Scope Rings, Medium	S100RM	Standard & All-Weather 77/17
Scope Rings, High, Matte Gray	KD72HTG	Varmint 77/17
* Sear	KJ02302	Standard & All-Weather 77/22
* Sear	KJ02303	Varmint 77/22; All 77/17 Models
Sear Pivot Pin	J04200	All Models
Sling Swivel Front Screw, with Nut	S-86B	Standard & Varmint 77/22; Standard & Varmint 77/17
Sling Swivel Rear Mounting Stud	S-87	Standard & Varmint 77/22; Standard & Varmint 77/17
Stock, Walnut, Complete	J00400	Standard 77/22; Standard 77/17
Stock, Laminated, Complete	J00435	Varmint 77/22
Stock, Black Laminate, Complete	J00432	Varmint 77/17
Stock, Synthetic, Complete - .22 LR With Plastic Inserts	J20402A	All-Weather 77/22

<b>Part Name</b>	<b>Part No.</b>	<b>Model</b>
Stock, Synthetic, Complete - .22 Mag. & .17HMR With Plastic Inserts	J20403A	All-Weather 77/22; All-Weather 77/17
Striker	J01300	All Models
Striker/Cocking Piece Assembly	J31700	Standard 77/22
Striker/Cocking Piece Assembly	KJ31700	All-Weather 77/22; Standard & All-Weather 77/17
Striker/Cocking Piece Assembly	KJ31700T	Varmint 77/22; Varmint 77/17
Striker Cross Pin	J04900	All Models
Striker Spring	J01200A	All Models
Torx® Key Wrench, Not Illustrated (for scope base Torx® Head Screw)	MPF07601	All Models
* Trigger	KJ02000	Standard & All-Weather 77/22; Standard & All-Weather 77/17
* Trigger	KJ02000T	Varmint 77/22; Varmint 77/17
Trigger Guard Assembly - .22 LR	J30200	Standard 77/22
Trigger Guard Assembly - .22 Mag.	J30201	Standard 77/22
Trigger Guard Assembly - .22 LR	KJ30200T	Varmint 77/22
Trigger Guard Assembly - .22 Mag.	KJ30201T	Varmint 77/22
Trigger Guard Assembly - .17 HMR	J20201	Standard 77/17
Trigger Guard Assembly - .17 HMR	KJ20201T	Varmint 77/17
Trigger Pivot Pin	D-19	All Models
Trigger/Sear Spring	J02400	All Models

\* PARTS SO MARKED MUST BE FACTORY FITTED

# RUGER MODEL 77/22® & MODEL 77/17 EXPLODED VIEW

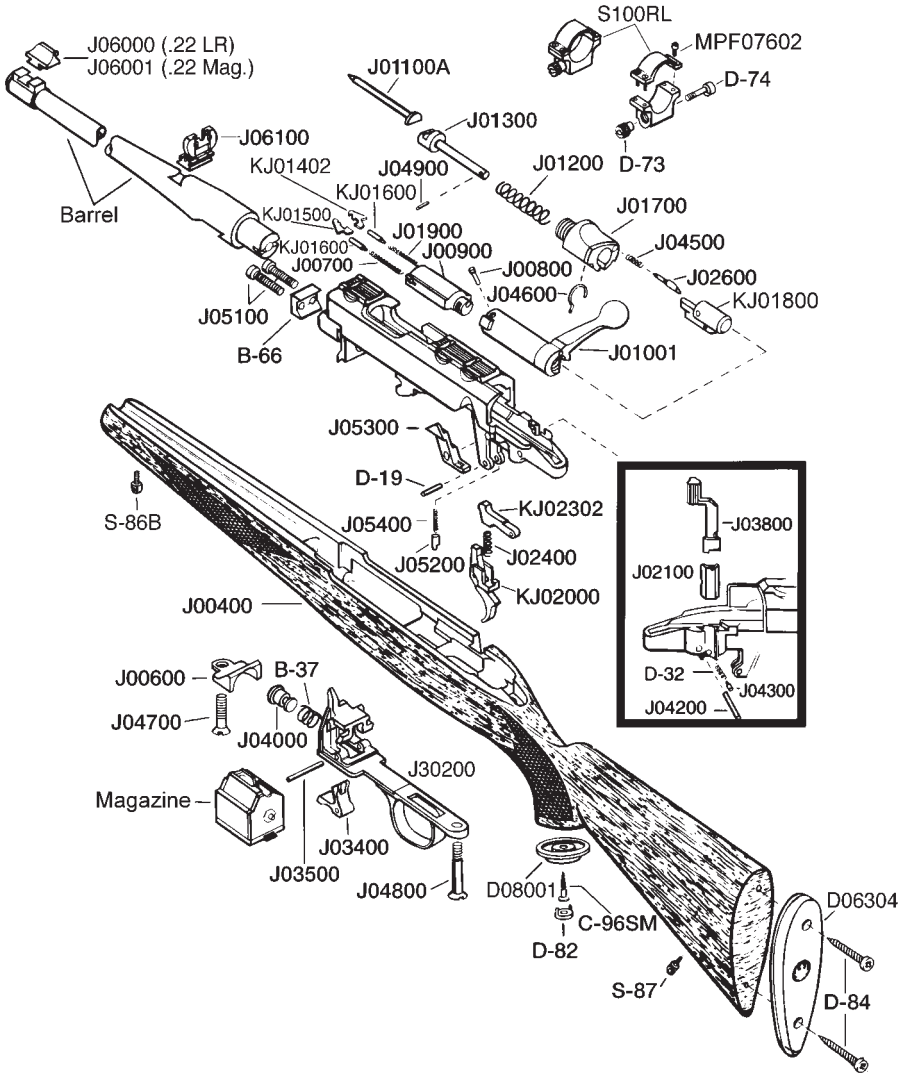

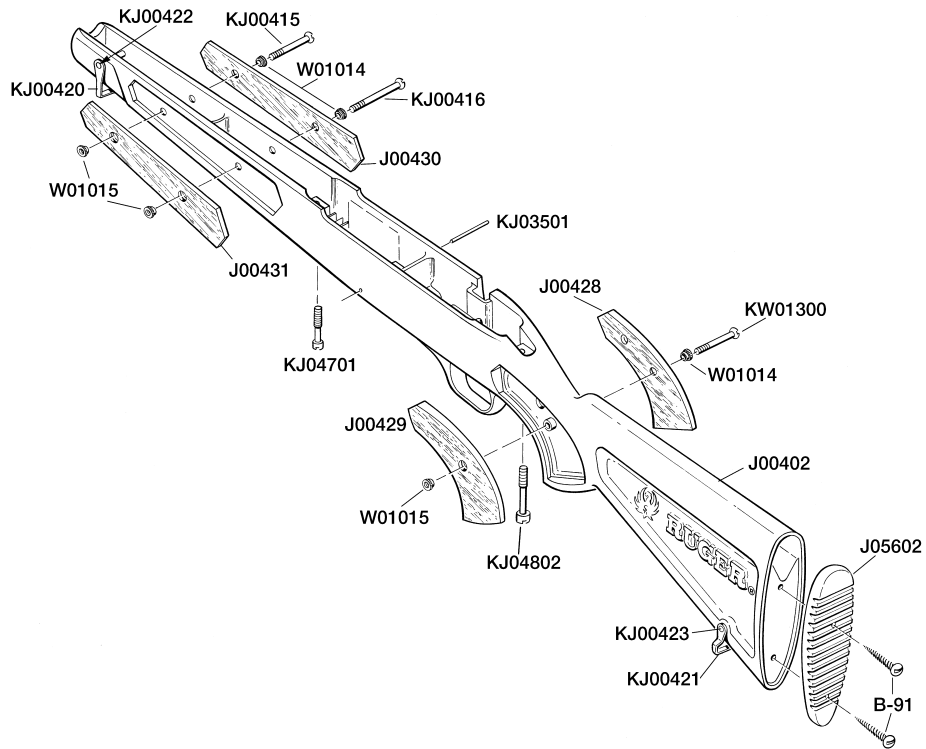

**SYNTHETIC STOCK**  
**COMPONENT PARTS**

# **RUGER® MODEL 77/22® HORNET & MODEL 77/44™ RIFLES**

## **PARTS LIST**

Design, prices and specifications subject to change without notice.

SPECIFY MODEL AND CALIBER WHEN ORDERING

(See Exploded View on Page 44 & 45)

<b>Part Name</b>	<b>Part No.</b>	<b>Model</b>
* Barrel 20"	OJ8008	77/22 RH, RSH
* Barrel 24"	KOJ8009	77/22 VHZ
* Barrel	OJ8013	77/44 RS
* Barrel	KOJ8013	77/44 RSP
* Bolt Handle	J01001	77/22 RH, RSH & 77/44 RS
* Bolt Handle	KJ01001T	77/22 VHZ
* Bolt Handle	KJ01001	77/44 RSP
Bolt Lock Plunger	J02600	77/22 RH, RSH & 77/44 RS
Bolt Lock Plunger	KJ02600T	77/22 VHZ
Bolt Lock Plunger	KJ02600	77/44 RSP
Bolt Lock Plunger Retainer	J04600	All Models
Bolt Lock Plunger Spring	J04500	All Models
Bolt Sleeve	J01700	77/22 RH, RSH
Bolt Sleeve	KJ01700T	77/22 VHZ
Bolt Sleeve	J01706	77/44 RS
Bolt Sleeve	KJ01706	77/44 RSP
Bolt Stop	J05302	77/22 RH, RSH & 77/44 RS
Bolt Stop	KJ05302T	77/22 VHZ & 77/44 RSP
Bolt Stop Plunger Spring	J05401	All Models
* Breech Block Assembly	J20903	77/22 RH, RSH
* Breech Block Assembly	KJ20903T	77/22 VHZ
* Breech Block Assembly	J20906	77/44 RS, RSP

<b>Part Name</b>	<b>Part No.</b>	<b>Model</b>
Breech Block Retaining Pin	J00800	All Models
Butt Plate Screw, 2 Req'd	B-91	77/44 RSP
Cartridge Support, Not Illustrated	J01503	77/44 RS, RSP
Cartridge Support Pivot Pin, Not Illustrated	J05801	77/44 RS, RSP
Cocking Piece	J01800	77/22 RH, RSH & 77/44 RS
Cocking Piece	KJ01800T	77/22 VHZ
Cocking Piece	KJ01800	77/44 RSP
Escutcheon, Not Illustrated	L05101	77/44 RS, RSP
Extractor	KJ01403	77/22 RH, RSH, VHZ
Extractor	L01421	77/44 RS, RSP
Extractor Pivot Pin	J05800	77/44 RS, RSP
Extractor Plunger	KJ01600	77/22 RH, RSH, VHZ
Extractor Spring	J01900	77/22 RH, RSH, VHZ
Extractor Spring	L05700	77/44 RS, RSP
* Firing Pin	J01102A	77/22 RH, RSH, VHZ
* Firing Pin	J01104A	77/44 RS, RSP
Front Mounting Screw	J04702	77/22 RH, RSH
Front Mounting Screw	KJ04702T	77/22 VHZ
Front Mounting Screw	J04703	77/44 RS, RSP
Front Sight, with Gold Bead, Not Illustrated	B27501	77/22 RSH
Front Sight	J06001	77/44 RS
Front Sight, Not Illustrated	J06009	77/44 RSP
Front Sight Base, Not Illustrated	J06005	77/22 RSH
Front Sight Base Set Screw, Not Illustrated	J06202	77/22 RSH
Magazine Complete, 6-shot	JHX-1	77/22 RH, RSH, VHZ
Magazine Complete, 4-shot	MAG-77/44	77/44 RS, RSP
Magazine Latch Lever	J03400	77/22 RH, RSH
Magazine Latch Lever	J03402	77/22 VHZ
Magazine Latch Lever	J03404	77/44 RS, RSP



<b>Part Name</b>	<b>Part No.</b>	<b>Model</b>
Magazine Latch Pivot Pin	J03500	All Models
Magazine Latch Plunger	J04000	All Models
Magazine Latch Plunger Spring	B-37	77/22 RH, RSH, VHZ
Magazine Latch Plunger Spring	J03701	77/44 RS, RSP
Magazine Well Liner	J00601	77/22 RH, RSH
Magazine Well Liner	KJ00601T	77/22 VHZ
Pistol Grip Cap	D08001	77/22 RH, RSH & 77/44 RS
Pistol Grip Cap	D-80SB	77/44 RSP
Pistol Grip Cap Medallion	D-82	77/22 RH, RSH & 77/44 RS, RSP
Pistol Grip Cap Screw	C-96SM	77/22 RH, RSH & 77/44 RS, RSP
Rear Mounting Screw	J04800	77/22 RH, RSH & 77/44 RS, RSP
Rear Mounting Screw	KJ04800T	77/22 VHZ
Rear Sight	J06100	77/22 RSH & 77/44 RS, RSP
Recoil Pad	D06304	77/22 RH, RSH, VHZ & 77/44 RS
Recoil Pad	D06315	77/44 RSP
Recoil Pad Screw, 2 Req'd.	D-84	77/22 RH, RSH, VHZ & 77/44 RS
* Safety Selector	J03800	77/22 RH, RSH & 77/44 RS
* Safety Selector	KJ03800	77/22 VHZ & 77/44 RSP
Safety Selector Detent	J04300	All Models
Safety Selector Detent Spring	D-32	All Models
Safety Selector Retainer	J02100	77/22 RH, RSH & 77/44 RS
Safety Selector Retainer	KJ02100	77/22 VHZ & 77/44 RSP
Scope Ring Clamp	D-74	All Models
Scope Ring Nut	D-73	All Models
Scope Base Torx® Head Screw, 8 Req'd.	MPF07602	77/22 RH, RSH & 77/44 RS
Scope Base Torx® Head Screw, 8 Req'd.	KMPF07602	77/44 RSP
Scope Base Torx® Head Screw, 8 Req'd.	KMPF07602M	77/22 VHZ - matte finish
Scope Rings, High	S100RH	77/22 RH, RSH
Scope Rings, High, Matte Gray	KD72HTG	77/22 VHZ
Scope Rings, Medium	S100RM	77/44 RS

<b>Part Name</b>	<b>Part No.</b>	<b>Model</b>
Scope Rings, Medium	KS100RM	77/44 RSP
* Sear	KJ02303	77/22 RH, RSH, VHZ
* Sear	KJ02302	77/44 RS, RSP
Sear Pivot Pin	J04201	All Models
Sling Swivel Front Screw With Nut	S-86B	77/22 RH, RSH, VHZ & 77/44 RS
Sling Swivel Front Stud	J08700	77/44 RSP
Sling Swivel Rear Mounting Stud	S-87	All Models
Stock, Laminated, Complete	J00437	77/22 VHZ
Stock, Walnut, Complete	J00436	77/22 RH, RSH
Stock, Walnut, Complete	J20438	77/44 RS
Stock, Synthetic, Complete	J30443	77/44 RSP
Striker	J01300	All Models
Striker Cross Pin	J04900	All Models
Striker Spring	J01200	All Models
* Striker/Cocking Piece Assembly	J31702	77/22 RH, RSH
* Striker/Cocking Piece Assembly	KJ31702T	77/22 VHZ
* Striker/Cocking Piece Assembly	J31706	77/44 RS
* Striker/Cocking Piece Assembly	KJ31706	77/44 RSP
Torx® Key Wrench, Not Illustrated (for scope base Torx® Head Screw)	MPF07601	All Models
* Trigger	KJ02000	77/22 RH, RSH & 77/44 RS, RSP
* Trigger	KJ02000T	77/22 VHZ
Trigger Guard Assembly	J30202	77/22 RH, RSH
Trigger Guard Assembly	KJ30202T	77/22 VHZ
Trigger Guard Assembly	J30203	77/44 RS, RSP
Trigger Pivot Pin	D-19	All Models
Trigger/Sear Spring	J02400	All Models

\* PARTS SO MARKED MUST BE FACTORY FITTED

# RUGER 77/22® HORNET

## EXPLODED VIEW

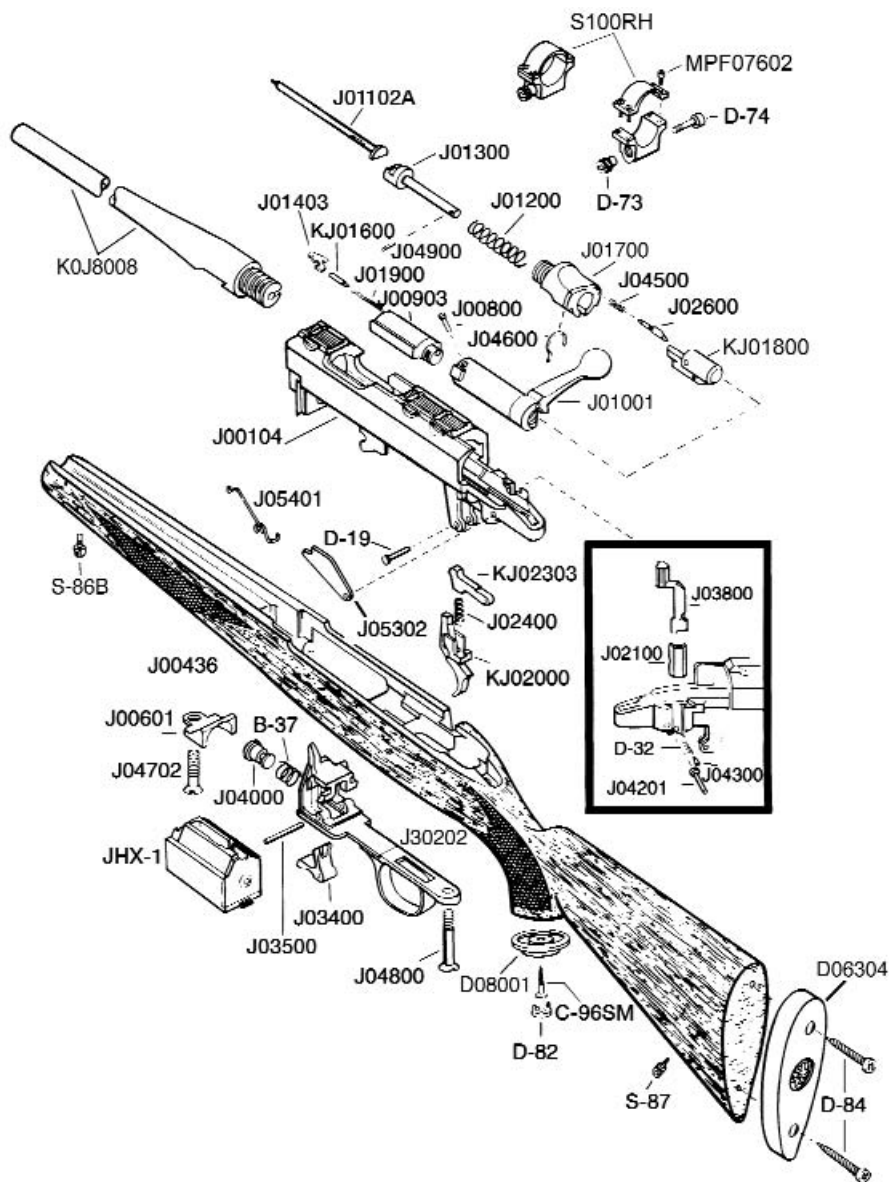



# THE BASIC RULES OF SAFE FIREARMS HANDLING

We believe that Americans have a right to purchase and use firearms for lawful purposes. The private ownership of firearms in America is traditional, but that ownership imposes the responsibility on the gun owner to use his firearms in a way which will ensure his own safety and that of others. When firearms are used in a safe and responsible manner, they are a great source of pleasure and satisfaction, and represent a fundamental part of our personal liberty.

Firearms do not cause accidents! Firearms accidents are almost always found to have been the result of carelessness, or ignorance on the part of the shooter of the basic rules of safe gun handling.

The following rules must be observed by gun users at all times. Safe gun handling is not just desirable, it is absolutely essential to your safety, the safety of others, and the continuation of gun ownership and sport shooting as we know it today.

## 1. LEARN THE MECHANICAL AND HANDLING CHARACTERISTICS OF THE FIREARM YOU ARE USING.

Not all firearms are the same. The method of carrying and handling firearms

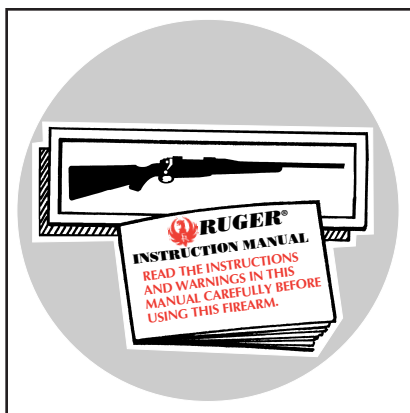

varies in accordance with the mechanical provisions for avoiding accidental discharge and the various proper procedures for loading and unloading. No person should handle any firearm without first having thoroughly familiarized himself with the particular type of firearm he is using, and with safe gun handling in general.

## 2. ALWAYS KEEP THE MUZZLE POINTED IN A SAFE DIRECTION.



Be sure of the bullet stop behind your target, even when dry-firing. Never let the muzzle of a firearm point at any part of your body or at another person. This is particularly important when loading or unloading a firearm. In the event of an accidental discharge, no injury can occur as long as the muzzle is pointing in a safe direction. A safe direction means a direction which will not permit a discharged bullet to strike a person, or to strike an object from which the bullet may ricochet.

A safe direction must take into account the fact that a bullet may penetrate a wall, ceiling, floor, window, etc., and strike a person or damage property. Make it a habit to know exactly where the muzzle of your gun is pointing whenever you handle it, and be sure that you are always in control of the direction in which the muzzle is pointing, even if you fall or stumble. Keep your finger off the trigger until you are ready to shoot.

### 3. FIREARMS SHOULD BE UNLOADED WHEN NOT IN USE.

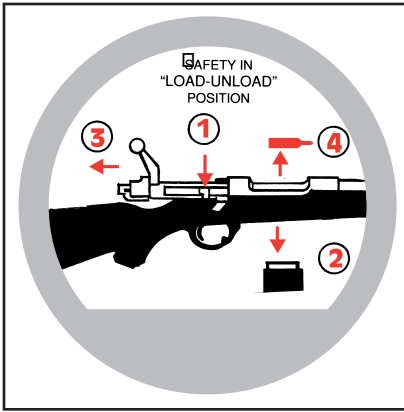

Firearms should be loaded only when you are in the field or on the target range or shooting area, ready to shoot. Firearms and ammunition should be securely locked in safes, racks or cabinets, or by using the locking device supplied with the firearm when not in use. Ammunition should safely be stored separate from firearms. Store your firearms out of sight of visitors and children. It is the gun owner's responsibility to be certain that children and persons unfamiliar with firearms cannot gain access to firearms, ammunition, or components.

### 4. BE SURE THE BARREL IS CLEAR OF OBSTRUCTIONS BEFORE SHOOTING.

Even a bit of mud, snow or excess lubricating oil or grease in the bore may cause the barrel to bulge, or even burst on firing, and can cause serious injury to the shooter and bystanders. Be sure that you are using ammunition of the proper caliber and loading for the gun you are using. If the report or recoil on firing seems weak, or doesn't seem quite right, **CEASE FIRING IMMEDIATELY**, unload your firearm, and check to be sure that no obstruction has become lodged in the barrel. Never try to shoot out an obstruction!

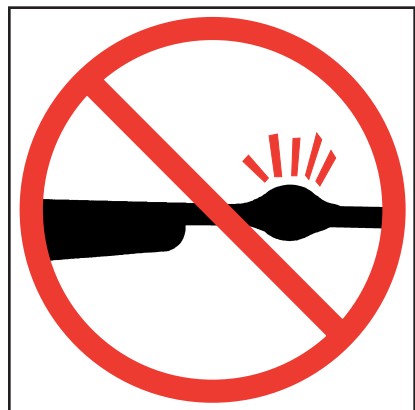



## 5. BE SURE OF YOUR TARGET BEFORE YOU SHOOT.

Don't shoot unless you know exactly where your bullet is going to strike. Be sure of the bullet stop behind your target, even when dry-firing with an unloaded gun. If you are in the field hunting, do not fire at a movement or noise. Take the time to be absolutely certain of your target before you pull the trigger.

## 6. WEAR SHOOTING GLASSES AND HEARING PROTECTORS WHEN YOU SHOOT.

All shooters should wear protective shooting glasses and adequate hearing protectors when shooting. Exposure to shooting noise can damage hearing, and adequate eye protection when shooting is essential.



## 7. NEVER CLIMB A TREE OR FENCE WITH A LOADED FIREARM.

Put the firearm down carefully before climbing a fence, and unload it before climbing or descending a tree or jumping over a ditch or other obstruction. Never pull or push a loaded firearm toward yourself or another person. When in doubt, or whenever you are about to do anything awkward, unload your gun!

**8. DON'T SHOOT AT A HARD SURFACE, OR AT WATER.**

Bullets can glance off many surfaces like rocks or the surface of water and travel in unpredictable directions with considerable velocity.

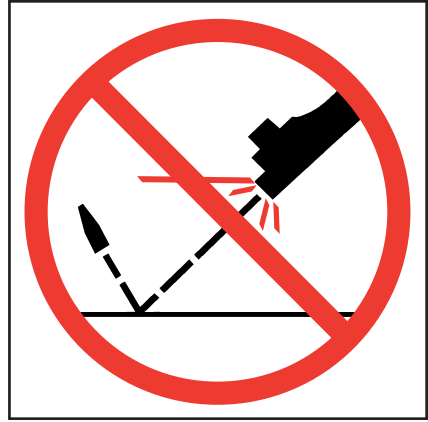

**9. NEVER TRANSPORT A LOADED FIREARM.**

Firearms should always be unloaded before being placed in a vehicle. A suitable carrying case or scabbard should be used to carry an unloaded firearm to and from the shooting area.

**10. AVOID ALCOHOLIC BEVERAGES WHEN SHOOTING.**

Don't drink until the day's shooting is over. Handling firearms while under the influence of alcohol in any form, or medications that could affect your judgment or co-ordination, constitutes a criminal disregard for the safety of others.





## A BRIEF ACCOUNT OF AN EXTRAORDINARY ACHIEVEMENT: RUGER FIREARMS

One of the few American firearms manufacturers whose management has remained in the same family since starting in business, Sturm, Ruger & Company, Inc., had its beginning in a small machine shop occupying a rented frame building in Southport, Connecticut. In January, 1949, with an initial investment of only \$50,000 and an idea, William B. Ruger and Alexander M. Sturm started production of a .22 caliber autoloading pistol—a design which was so successful that it became the cornerstone upon which one of the most comprehensive lines of sporting firearms ever made in America was established. After Alex Sturm's death in 1951, William B. Ruger continued to direct the company alone and today, William B. Ruger, Jr. continues to provide guidance which has made this company a sound and successful enterprise.

Sturm, Ruger & Company, in this relatively short time, has established itself as a leading small arms design organization, developing a unique and broad line of fine quality sporting, military and police firearms to become one of the world's most famous producers of revolvers, pistols, rifles and shotguns. Since 1949 Ruger craftsmen have built many millions of firearms.

During its five decades of growth and progress under the leadership of William B. Ruger, the company developed a business philosophy and implemented policies which represent a constructive influence in the life of modern America. From the beginning, Sturm, Ruger & Company played a positive role in conservation efforts and has supported the interests of shooters through such groups as the National Rifle Association, National Shooting Sports Foundation, and many regional sportsmen's organizations.

The company has always endeavored to market its firearms for constructive and recreational purposes, to emphasize the traditional aspects of shooting, to render meaningful public services and to encourage shooters in constructive, responsible, and safe participation in the shooting sports. Its motto is "Arms Makers For Responsible Citizens."

Today, Sturm, Ruger & Company is particularly mindful of those elements which have contributed to the creation of its success, and extends heartfelt thanks to its many loyal employees and customers.

A current catalog of Ruger firearms is available free upon request to  
Sturm, Ruger & Co., Inc., Southport, CT 06890

## **WHY NO WARRANTY CARD HAS BEEN PACKED WITH THIS NEW RUGER FIREARM**

The Magnuson-Moss Act (Public Law 93-637) does not require any seller or manufacturer of a consumer product to give a written warranty. It does provide that if a written warranty is given, it must be designated as "limited" or as "full" and sets minimum standards for a "full" warranty. Sturm, Ruger & Company, Inc. has elected not to provide any written warranty, either "limited" or "full", rather than to attempt to comply with the provisions of the Magnuson-Moss Act and the regulations issued thereunder. There are certain implied warranties under state law with respect to sales of consumer goods. As the extent and interpretation of these implied warranties varies from state to state, you should refer to your state statutes. Sturm, Ruger & Company wishes to assure its customers of its continued interest in providing service to owners of Ruger firearms.



**STURM, RUGER & Company, Inc.**  
**Southport, Connecticut 06890 U.S.A.**  
**[www.ruger.com](http://www.ruger.com)**

**“Arms Makers For Responsible Citizens”<sup>®</sup>**

**A COPY OF THE INSTRUCTION MANUAL FOR ANY RUGER  
FIREARM IS AVAILABLE FROM THE FACTORY FREE ON REQUEST.  
THESE INSTRUCTION MANUALS CONTAIN IMPORTANT  
WARNINGS WHICH MUST BE UNDERSTOOD  
BEFORE USING THESE FIREARMS.**

22/45", "Model 96", "77/17", "Gold Label", and "Target Grey" are RUGER TRADEMARKS. "RUGER", "THE STURM, RUGER LOGO", "10/22", "All-Weather", "Arms Makers For Responsible Citizens", "Bearcat", "Blackhawk", "GP-100", "M77", "Mini Thirty", "Mini-14", "Old Army", "P90", "P93", "P94", "Redhawk", "77/22", "77/44", "77/50", "SP101", "Vaquero", and "Single Six" are REGISTERED U.S. TRADEMARKS. "DEERFIELD" is a registered trademark of Blount, Inc.