

INSTRUCTION MANUAL FOR

BLUED &
STAINLESS
STEEL



CALIBER
.223 (5.56mm)

RUGER® **MINI-14® RIFLE** AUTOLOADING RIFLE

NOT FOR USE WITH MINI THIRTY RIFLES (cal. 7.62 x 39mm)



FOR REFERENCE ONLY
These models are out of
production. They have been
superseded by the Ruger
New Mini-14 Ranch Rifle.



**READ THE INSTRUCTIONS AND
WARNINGS IN THIS MANUAL CAREFULLY
BEFORE USING THIS FIREARM**

**For Product Service on This Model Please Call:
(603) 865-2442 (See p. 33)**

STURM, RUGER & Company, Inc.
Southport, Connecticut 06890 U.S.A.

THIS INSTRUCTION MANUAL SHOULD ALWAYS ACCOMPANY THIS FIREARM AND BE
TRANSFERRED WITH IT UPON CHANGE OF OWNERSHIP, OR WHEN THE FIREARM IS LOANED OR
PRESENTED TO ANOTHER PERSON.

KMS1 & MS1/6-03 R17

State-By-State Warnings

Certain states require by law that their own specified warning notices in larger-than-normal type be conspicuously included by the manufacturer, distributor, or retail dealer with firearms sold in that state. Sturm, Ruger sells its products in compliance with applicable laws and regulations. Because our products may be sold in these states, we include the following:

California:

⚠ WARNING

“Children are attracted to and can operate firearms that can cause severe injuries or death. Prevent child access by always keeping guns locked away and unloaded when not in use. If you keep a loaded firearm where a child obtains and improperly uses it, you can be fined or sent to prison.”

⚠ ADVERTENCIA

“A los niños los atraen las armas de fuego y las pueden hacer funcionar. Ellos pueden causarse lesiones graves y la muerte. Evite que los niños tengan acceso a las armas de fuego guardándolas siempre con llave y descargadas cuando no las esté utilizando. Si usted tiene un arma de fuego cargada en un lugar en que un niño tiene acceso a ella y la usa indebidamente, le pueden dar una multa o enviarlo a la cárcel.”

Connecticut:

“UNLAWFUL STORAGE OF A LOADED FIREARM MAY RESULT IN IMPRISONMENT OR FINE.”

Florida:

“IT IS UNLAWFUL, AND PUNISHABLE BY IMPRISONMENT AND FINE, FOR ANY ADULT TO STORE OR LEAVE A FIREARM IN ANY PLACE WITHIN THE REACH OR EASY ACCESS OF A MINOR UNDER 18 YEARS OF AGE OR TO KNOWINGLY SELL OR OTHERWISE TRANSFER OWNERSHIP OR POSSESSION OF A FIREARM TO A MINOR OR A PERSON OF UNSOUND MIND.”

Maine:

“ENDANGERING THE WELFARE OF A CHILD IS A CRIME. IF YOU LEAVE A FIREARM AND AMMUNITION WITHIN EASY ACCESS OF A CHILD, YOU MAY BE SUBJECT TO FINE, IMPRISONMENT OR BOTH. KEEP FIREARMS AND AMMUNITION SEPARATE. KEEP FIREARMS AND AMMUNITION LOCKED UP. USE TRIGGER LOCKS.”

Maryland:

“WARNING: Children can operate firearms which may cause death or serious injury. It is a crime to store or leave a loaded firearm in any location where an individual knew or should have known that an unsupervised minor would gain access to the firearm. Store your firearm responsibly!”

Massachusetts:

“WARNING FROM THE MASSACHUSETTS ATTORNEY GENERAL: This handgun is not equipped with a device that fully blocks use by unauthorized users. More than 200,000 firearms like this one are stolen from their owners every year in the United States. In addition, there are more than a thousand suicides each year by younger children and teenagers who get access to firearms. Hundreds more die from accidental discharge. It is likely that many more children sustain serious wounds, or inflict such wounds accidentally on others. In order to limit the chance of such misuse, it is imperative that you keep this weapon locked in a secure place and take other steps necessary to limit the possibility of theft or accident. Failure to take reasonable preventive steps may result in innocent lives being lost, and in some circumstances may result in your liability for these deaths.”

“IT IS UNLAWFUL TO STORE OR KEEP A FIREARM, RIFLE, SHOTGUN OR MACHINE GUN IN ANY PLACE UNLESS THAT WEAPON IS EQUIPPED WITH A TAMPER-RESISTANT SAFETY DEVICE OR IS STORED OR KEPT IN A SECURELY LOCKED CONTAINER.”

New Jersey:

“IT IS A CRIMINAL OFFENSE TO LEAVE A LOADED FIREARM WITHIN EASY ACCESS OF A MINOR.”

New York City:

“THE USE OF A LOCKING DEVICE OR SAFETY LOCK IS ONLY ONE ASPECT OF RESPONSIBLE WEAPONS STORAGE. ALL WEAPONS SHOULD BE STORED UNLOADED AND LOCKED IN A LOCATION THAT IS BOTH SEPARATE FROM THEIR AMMUNITION AND INACCESSIBLE TO CHILDREN AND ANY OTHER UNAUTHORIZED PERSONS.”

North Carolina:

“IT IS UNLAWFUL TO STORE OR LEAVE A FIREARM THAT CAN BE DISCHARGED IN A MANNER THAT A REASONABLE PERSON SHOULD KNOW IS ACCESSIBLE TO A MINOR.”

Texas:

“IT IS UNLAWFUL TO STORE, TRANSPORT, OR ABANDON AN UNSECURED FIREARM IN A PLACE WHERE CHILDREN ARE LIKELY TO BE AND CAN OBTAIN ACCESS TO THE FIREARM.”

Wisconsin:

“IF YOU LEAVE A LOADED FIREARM WITHIN THE REACH OR EASY ACCESS OF A CHILD YOU MAY BE FINED OR IMPRISONED OR BOTH IF THE CHILD IMPROPERLY DISCHARGES, POSSESSES, OR EXHIBITS THE FIREARM.”

* * * * *

Please check with your licensed retailer or state police for additional warnings which may be required by local law or regulation. Such regulations change constantly, and local authorities are in the best position to advise you on such legal matters.



WARNING – LOCKING DEVICES

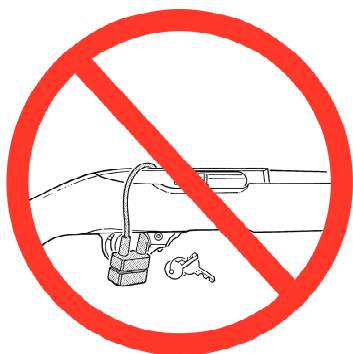

**DO NOT INSTALL
INSIDE TRIGGER GUARD**

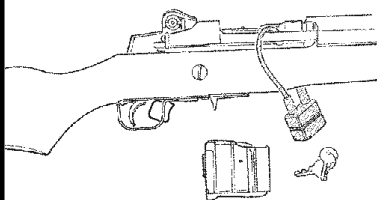

**INSTALL LOCK
AS SHOWN HERE**

This firearm was originally sold with a key-operated locking device. While it can help provide secure storage for your **unloaded** firearm, any locking device can fail. All guns are designed to fire if they are loaded and the trigger is pulled. Therefore, **never install the locking device inside the trigger guard or in any way that it can possibly pull the trigger!** Do not leave the keys in the lock.

The ultimate responsibility for secure storage of any firearm must depend upon its owner and his or her individual circumstances. **Guns should be securely stored unloaded, in a secure location, separate from their ammunition.**

See “Storage Warning”, page 30.

**NEVER INSTALL
LOCKING DEVICE
INSIDE TRIGGER GUARD**

FIREARMS SAFETY-YOUR RESPONSIBILITY

SAFETY MUST BE THE FIRST AND CONSTANT CONSIDERATION OF EVERY PERSON WHO HANDLES FIREARMS AND AMMUNITION.

This Instruction Manual is designed to assist you in learning how to use and care for your **RUGER® MINI-14® RIFLE** properly. Please contact us if you have any questions about it.

Only when you are certain you fully understand the Manual and can properly carry out its instructions should you practice loading, etc. with live ammunition. If you have any doubts about your ability to handle or use a particular type of gun safely, then you should seek supervised instruction. Such personalized instruction is often available from gun dealers, gun clubs or police departments. If none of these sources can help you, write to the National Rifle Association, 11250 Waples Mill Road, Fairfax, VA 22030-7400. They will assist you.

The person possessing a gun has a full-time job. You cannot guess; you cannot forget. You must know how to use your firearm safely. **Do not use any firearm without having a complete understanding of its particular characteristics and safe use.**

Remember: There is no such thing as a foolproof gun.

TABLE OF CONTENTS

	Page
General Information	8
Operation of Safety	9
The Bolt Lock	10
Ammunition	11
Magazines	12
To Load and Fire (With Magazine)	14
To Load and Fire (Without Magazine)	16
To Unload	16
To Reload the Rifle	18
To Extract and Eject a Chambered Cartridge	18
To Remove a Bore Obstruction	18
To Clear a Malfunction ("Jam")	20
To Minimize Malfunctions ("Jams")	21
Disassembly	23
Reassembly	26
Removal and Replacement of Fiberglass Handguard	27
Magazine Inspection and Care	27
Care and Cleaning	29
Storage	30
Maintenance of Stainless Steel Rifles	31
Sight Adjustment	31
Service and Parts Policy	33
Parts Drawing	41
The Basic Rules of Safe Firearms Handling	42
Warranty Information	48

"RUGER" and "Mini-14", are registered U.S. trademarks.



WARNINGS OF GREAT IMPORTANCE ARE FOUND ON THE FOLLOWING PAGES:

Locking Devices	6	Unloading	16
Alterations	8	Bore Obstructions	19
Manual Safety	10	Malfuncions	22
Ammunition	11	Disassembly	23
Lead Exposure	12	Lubrication	29
Firing	14	Storage	30
Handling	15	Parts Purchasers	34
Sustained Firing	16		

OTHER CAUTIONS AND WARNINGS APPEAR THROUGHOUT THE MANUAL.

**FIREARMS ARE DANGEROUS WEAPONS—
READ THE INSTRUCTIONS AND WARNINGS
IN THIS MANUAL THOROUGHLY AND
CAREFULLY BEFORE USING.**



WARNING—ALTERATIONS



This product was designed to function properly in its original condition. Alterations can make it unsafe. Do not alter any part or add or substitute parts or accessories not made by Sturm, Ruger & Co. Inc.

DO NOT ALTER ANY GUN

GENERAL INFORMATION AND MECHANICAL CHARACTERISTICS

The **RUGER® MINI-14® RIFLE** is a gas operated, box magazine fed, autoloading rifle. It is simple, reliable, and consists of a relatively few rugged components. The mechanism employs the Ruger fixed piston/moving cylinder gas system in conjunction with a simplified Garand-type rotating bolt. The Mini-14 Rifle can be field stripped for cleaning to its basic subassemblies in seconds without the use of tools.

Music wire coil springs are used throughout the mechanism. The safety, located in front of the trigger guard, blocks both the hammer and sear and permits the slide to be cycled with the safety "ON". A bolt lock mechanism is provided for

convenience in holding the bolt open for loading and inspection. The firing pin is retracted mechanically as the bolt starts to unlock and the rifle will fire only when the bolt is locked. The one-piece American hardwood stock is reinforced with steel liners in stressed and high temperature areas. The "All-Weather" model features a synthetic stock and stainless steel construction.

NOMENCLATURE

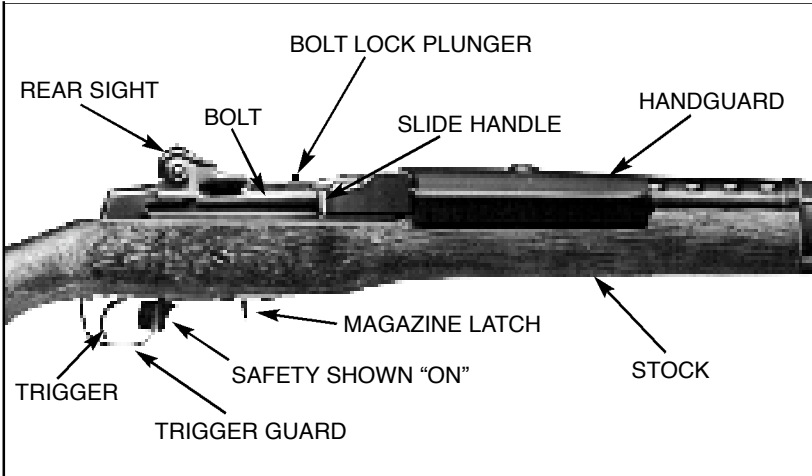

Figure 1. In this illustration the frequently used operating components are identified. Note that the safety is rearward of the trigger guard and is therefore in its "ON" (safe) position.

OPERATION OF SAFETY

The manual safety mechanism is located forward of the trigger for convenient operation and is "ON" when in its fully rearward position intruding into the trigger guard. (See Fig. 2) The safety can be moved to "ON" (extreme rearward position) only when the hammer is cocked. When the safety is "ON", it blocks both the hammer and sear. **The safety should always be placed "ON" before loading or unloading the rifle and should be kept "ON" at all times except when actually firing.**

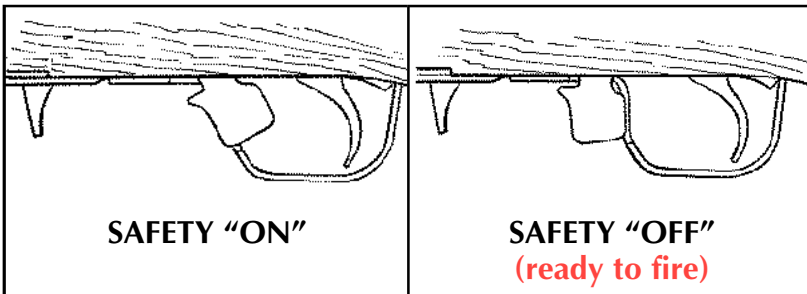
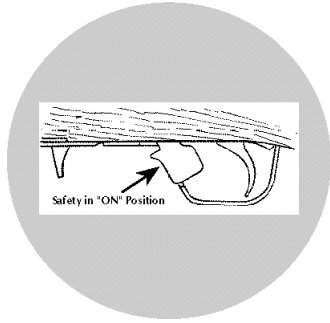

Figure 2.



WARNING – MANUAL SAFETY



Keep the safety on unless actually firing. Always move the safety fully to its intended position and check it. The safety is not “ON” unless it is completely “ON”. Never depend on a safety mechanism or any other mechanical device to justify careless handling or permitting the rifle to point in an unsafe direction. The only “safe” rifle is one in which the bolt is open, the chamber is empty, and there is no magazine in the gun.

KNOW HOW TO USE THE SAFETY

THE BOLT LOCK

The Mini-14 Rifle is designed so that the bolt remains open after the last shot has been fired, provided there is a magazine in the rifle. When the magazine is empty, the magazine follower actuates the bolt lock which is designed to retain the bolt and slide in their rearward position.

WARNING: The bolt lock is *not* a safety device. It should not be used to hold the bolt back when there are cartridges in the magazine. A slight jar to the butt end of the rifle will cause the bolt lock to disengage and to feed a cartridge into the chamber.

The bolt lock should be relied on only to hold the bolt in its rearward position when the chamber is empty and an empty magazine is in place. The only purpose of the bolt lock is for convenience in the rapid changing of magazines and for holding the bolt in its rearward position when the rifle is unloaded for the purpose of cleaning or inspection.

OPERATION OF BOLT LOCK

To manually engage the bolt lock to keep the bolt open: (See Figure 3)

1. Pull the slide handle all the way to the rear.
2. Depress the bolt lock plunger and allow the slide to move forward until it stops.
3. Put safety “ON” (push fully rearward).

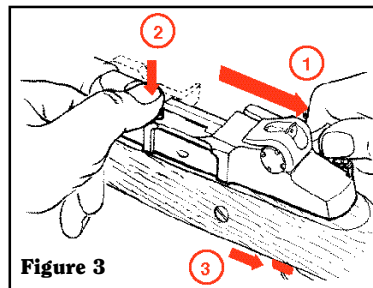

To release the slide (which allows the bolt to go forward) keep safety "ON" and either:

1. Remove the magazine, draw the slide handle to the rear and release, or;
2. With an empty magazine in place, draw the slide handle fully to the rear and hold it there. Then, while holding the slide handle, depress the magazine follower slightly with the thumb, remove the thumb, and then allow the slide to go forward. (See Figure 4)

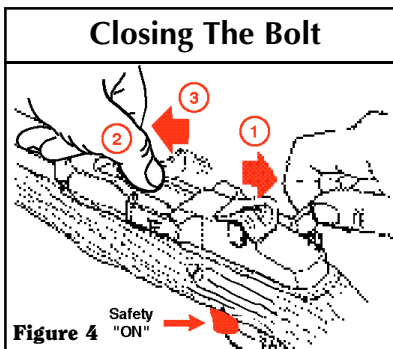



CAUTION: Slide is under heavy spring tension and can injure fingers when it slams shut.

AMMUNITION

The **RUGER® MINI-14® RIFLES** are chambered for the .223 Remington (5.56mm) cartridge. The Mini-14 Rifle is designed to use either standardized U.S. military, or factory loaded sporting .223 (5.56mm) cartridges manufactured in accordance with U.S. industry practice. See "Ammunition Notice" & "Ammunition Warning", below.

USE ONLY FACTORY AMMUNITION LOADED TO U.S. INDUSTRY STANDARDS

		WARNING – AMMUNITION
	Death, serious injury, and damage can result from the use of wrong ammunition, bore obstructions, powder overloads, or incorrect cartridge components. Even the strongest gun can be "blown up" as a result of excess pressure. Always wear shooting glasses and hearing protectors.	
	IMPROPER AMMUNITION DESTROYS GUNS	

AMMUNITION (CARTRIDGES) NOTICE

WE SPECIFICALLY DISCLAIM RESPONSIBILITY FOR ANY DAMAGE OR INJURY WHATSOEVER OCCURRING IN CONNECTION WITH, OR AS THE RESULT OF, THE USE IN RUGER FIREARMS OF FAULTY, OR NON-STANDARD, OR "REMANUFACTURED" OR HAND LOADED (RELOADED) AMMUNITION, OR OF CARTRIDGES OTHER THAN THOSE FOR WHICH THE FIREARM WAS ORIGINALLY CHAMBERED.



WARNING – LEAD EXPOSURE



Discharging firearms in poorly ventilated areas, cleaning firearms, or handling ammunition may result in exposure to lead and other substances known to the state of California to cause birth defects, reproductive harm, and other serious physical injury. Have adequate ventilation at all times. Wash hands thoroughly after exposure.

**SHOOTING OR CLEANING GUNS
MAY EXPOSE YOU TO LEAD**

MAGAZINES

RUGER® MINI-14® magazines are identified by having three vertical creases in the side of the magazine versus one vertical crease in the Ruger Mini Thirty magazine. The bottom of the Mini-14 magazine is more rectangular than the generally tapered bottom of the Mini Thirty magazine, and the follower, visible from the top of the magazine, is distinctly more pointed on the Mini Thirty (see illustrations below). **DO NOT ATTEMPT TO USE MINI THIRTY MAGAZINES IN RUGER MINI-14 RIFLES.**

Ruger Mini-14 Magazine (Correct)

For Caliber .223
Ammunition Only

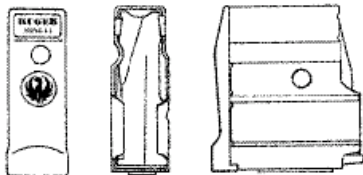

Bottom

Top

Side

Ruger Mini Thirty Magazine (Incorrect)

For Caliber 7.62 x 39mm
Ammunition Only

Do not use in Mini-14

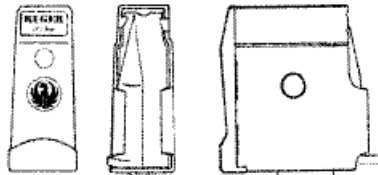

Bottom

Top

Side

Never attempt to use 7.62 x 39mm ammunition in Ruger Mini-14 rifles, as it will not chamber correctly and will “jam” the action. As with any firearm, always wear safety shooting glasses and adequate hearing protection.

LOADING THE MAGAZINE

Use only clean ammunition of the proper caliber manufactured to U. S. Industry specifications, in good condition. (See Notice and Warnings in other sections of this manual pertaining to Ammunition).

To load the magazine, align each cartridge with the bullet forward (pointing toward the hole in the front of the magazine body) and push downward until the cartridge snaps into place. Do not attempt to load more than the designated number of cartridges for which the magazine has been designed. **RUGER® MINI-14® RIFLES** are sold with 5 round Ruger magazines.

The **RUGER® MINI-14®** magazine is *not* interchangeable with the Ruger Mini Thirty magazines. Do not use non-Ruger magazines -- they may cause malfunctions.

DAMAGED, NON-STANDARD, OR IMPROPERLY ASSEMBLED MAGAZINES SHOULD NOT BE USED. THEY CAN CAUSE THE RIFLE TO MALFUNCTION.

INSERTING THE MAGAZINE

See Figure 5. The magazine may be inserted with the bolt either in the closed or open position (See "Bolt Lock" section p. 10).

1. Hold the magazine at an angle as shown and insert all the way up into the magazine well. NOTE: There is a hole in the top-front portion of the magazine that mates with a stud on the inside of the receiver.
2. Pull the bottom of the magazine toward the trigger guard until the magazine latch at the rear of the magazine well engages. Check to be sure that the magazine is securely latched into place.

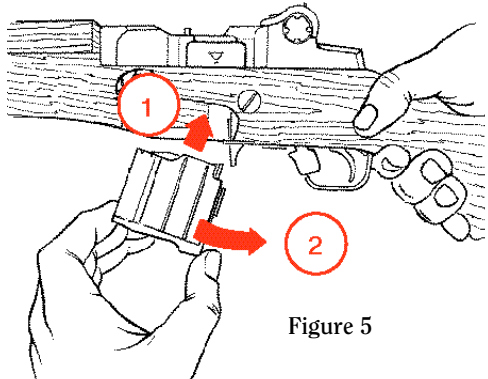

Figure 5

REMOVING THE MAGAZINE

To remove the magazine, simply push the magazine latch forward until the rear end of the magazine drops out of the magazine well. The magazine can then be withdrawn from the rifle. To minimize the possibility of damage and malfunctions, do not let the magazine drop to the ground (See Figure 6, p. 23).

TO LOAD AND FIRE (WITH MAGAZINE)

Practice this important aspect of gun handling (with an unloaded rifle) until you can perform each of the steps - described below - with skill and confidence. But before you do anything with the rifle, please first read completely through this manual. This procedure begins with an empty rifle with its magazine out.

1. **Be certain the muzzle is pointing in a safe direction.** (See Rule 2, p. 42).
2. Before inserting loaded magazine, engage the bolt lock so the bolt is held open. Check the chamber to be certain it is empty. **MOVE THE SAFETY TO THE “ON” POSITION.** (See Figure 3, p. 10).
3. Load a magazine with the desired number of cartridges.
4. Insert the loaded magazine into the magazine well, and immediately...
5. Draw the slide handle all the way to the rear and release it, allowing the slide to snap forward under full spring force. A cartridge will be stripped from the magazine and chambered by the motion of the bolt.

WARNING: If cartridges do not feed smoothly from the magazine into the chamber then do not use the rifle until the problem is corrected. (See “Malfunction Warning” p. 22)

6. The rifle is now cocked and a loaded cartridge is chambered. Visually check to be certain the safety is in the “ON” position.
7. When you are ready to fire the rifle, move the safety to the “OFF” position.

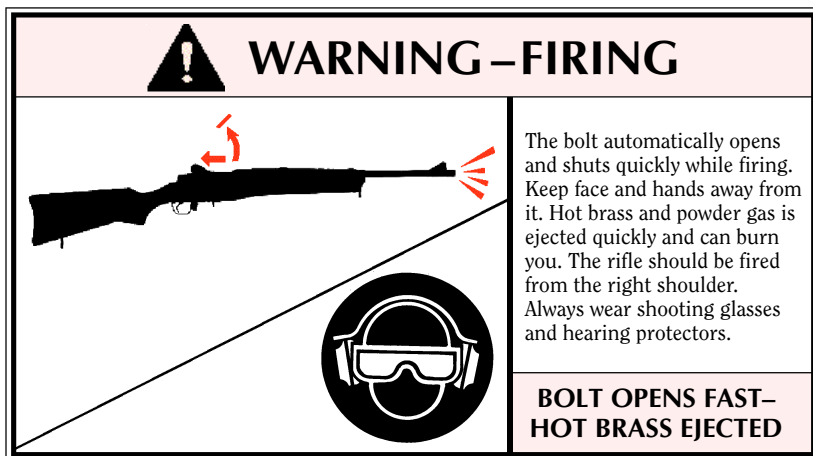

WARNING: DO NOT TOUCH THE TRIGGER UNTIL YOU ARE ACTUALLY READY TO FIRE. KEEP THE SAFETY “ON” UNLESS ACTUALLY FIRING.

8. The rifle will fire one shot each time the trigger is pulled until the magazine is empty. Some of the gas produced by the combustion of the powder is used to push the slide and bolt to the rear, which extracts and ejects the fired cartridge case, recocks the gun, and reloads a new cartridge from the magazine into the firing chamber.



9. Immediately following the firing of a shot, and if a subsequent shot is not to be fired at once, put the safety "ON" while the rifle is still pointing in a safe direction down range. The safety should be moved to the "ON" position as soon as firing is completed, and it should be "ON" at all times except when the rifle is on target and being fired.
10. When the last cartridge in the magazine has been fired, the bolt lock will automatically engage and hold the bolt and slide in the rearward, open position. CAUTION: Autoloading firearms have reciprocating bolts and slides. Do not position your fingers or face so these components can strike you when the gun is fired.

 WARNING – HANDLING	
	<p>If dropped or struck with the safety "off", the rifle may fire. Keep chamber empty unless actually firing! Keep safety "on" unless actually firing!</p>
<p>ANY GUN MAY FIRE IF DROPPED</p>	

 WARNING – SUSTAINED FIRING	
	<p>The Mini-14 rifle fires from a closed bolt. Sustained firing can create excessive heat in the barrel and can cause “cook-off” of ammunition (heat-firing of the cartridge in the chamber). This “cook-off” can occur a substantial period of time after firing has ceased. Always unload the firearm immediately after you have finished shooting.</p>
HOT BARREL CAN “COOK-OFF” (FIRE) CARTRIDGE IN CHAMBER	

TO LOAD AND FIRE (WITHOUT MAGAZINE)

The rifle can be used as a single shot rifle in the absence of a magazine or for safety or training purposes. To do so, follow step 1, p. 14. Then, manually load a cartridge into the chamber, and follow steps 5 and 6 p. 14, disregarding the magazine. Note that the bolt will not automatically lock open after the cartridge is fired and automatically ejected. Engage the safety between shots.

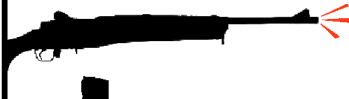
 WARNING – UNLOADING	
	<p>So that the rifle can be used as a single loader, it will fire whether or not a magazine is in the gun if a cartridge is chambered. Removing magazine does not unload rifle! To unload, <u>first</u> remove magazine, <u>then</u> pull bolt to rear, eject chambered cartridge, and <u>visually inspect chamber</u>. <u>The safety should always be in the “on” (safe) position when loading or unloading the rifle.</u></p>
GUN WILL FIRE WITH MAGAZINE OUT	

TO UNLOAD

WARNING: This sequence must be followed exactly as spelled out. Failure to do so can result in the rifle’s chamber becoming unintentionally loaded with a cartridge!

1. Keep the muzzle pointed in a safe direction at all times and keep the fingers outside the trigger guard. **Move the safety to the “ON” position.**

2. Remove the magazine. **REMEMBER** that even though the magazine has been removed, a cartridge remaining in the chamber can still be fired!
3. Pull the slide handle all the way to the rear, extracting and ejecting the cartridge in the chamber. When the bolt is fully retracted, push down on the bolt lock plunger and then allow the slide to move forward until it comes to rest against the bolt stop.
4. **Always visually double check the chamber to be certain it is empty.**
5. The only “safe” rifle is one in which the bolt is open and the chamber and magazine are empty.

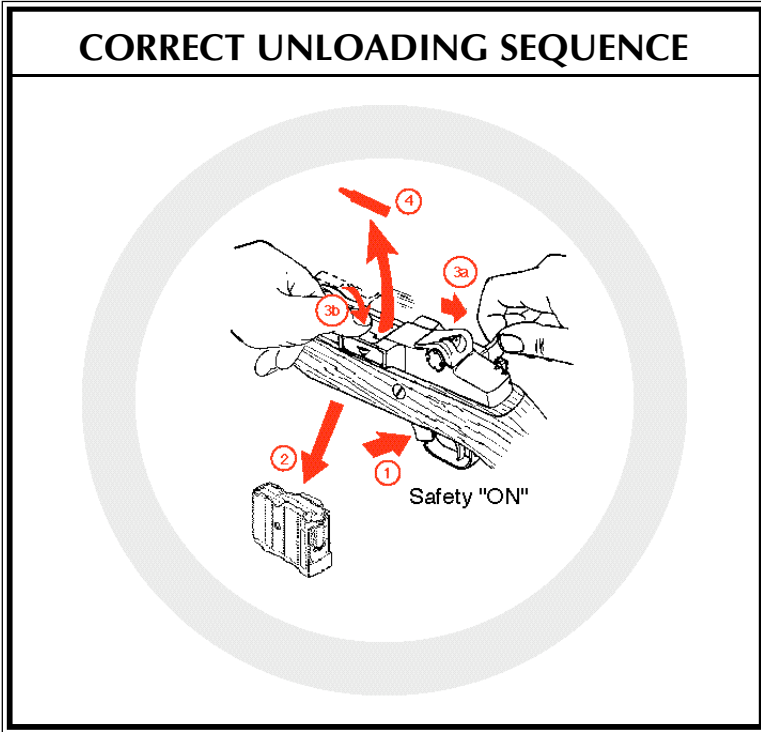

TO RELOAD THE RIFLE

1. Firing all cartridges in the magazine and the chamber will cause the bolt to automatically lock open. **Keep the rifle pointed in a safe direction.** Put the safety “ON”. Reloading can be accomplished by pressing forward on the magazine latch with the thumb or forefinger. The magazine will fall free of the rifle of its own weight. To avoid the possibility of damage to the magazine, do not let it fall to the ground unless rapid reloading is absolutely necessary.
2. Insert a loaded magazine. **WARNING: The bolt stop is held in place by a spring detent. Therefore, when there is a loaded magazine in place and the rifle is jarred, the bolt can fly forward and chamber a cartridge.**
3. Release the bolt to move forward by pulling the slide handle fully to the rear and release the slide. A cartridge will be chambered when the bolt shuts. **WARNING: The rifle is ready for instant use once the bolt moves forward.** If the rifle is not to be fired immediately, keep the safety “ON”. When you are ready to fire immediately, take the safety “OFF” and resume firing, putting the safety back “ON” whenever you cease firing, even for a moment.

TO EXTRACT AND EJECT A CHAMBERED CARTRIDGE

When the rifle is fired, the same gas pressure that drives the bullet forward acts through the gas port to push the slide and bolt to the rear. This action causes extraction and ejection of the fired cartridge case. If a cartridge fails to fire or if the shooter wishes to eject the chambered cartridge manually, follow the procedure “To Unload” step 3, p. 17. When the slide handle is operated there can be a failure to extract the cartridge from the chamber, or a failure to eject the cartridge clear of the rifle. These failures usually are the result of the slide handle not being pulled rearward vigorously. From the foregoing, it is clear that the gun user must:



1. Always visually check the chamber and the breech-face after opening the slide to eject a chambered cartridge. If the slide is not vigorously retracted, the extracted cartridge can be “ejected” into the magazine area or remain held to the breech-face by the extractor.
2. Thoroughly clean the chamber and the extractor as often as necessary.

If an empty magazine is in the rifle when the slide handle is being retracted to extract a cartridge, the cartridge may drop on top of the magazine or remain held to the breech-face by the extractor. Then, when the slide goes forward, the cartridge will be chambered again! **REMEMBER -- always remove the magazine before clearing the chamber, and visually check to ensure that no cartridges remain in the gun.**

TO REMOVE A BORE OBSTRUCTION

Rifles like the Mini-14 Rifle which are chambered for small caliber, high velocity cartridges, are particularly susceptible to damage from firing when the bore is obstructed. Excess oil, grease, water, or raindrops may form an obstruction which could cause damage and injury. If you suspect that your rifle may have excess oil, grease or cosmoline in the barrel, or if it may have been exposed to

humid conditions which could cause condensation, or to rain or snow which might have entered the bore, open the bolt and clean out the barrel. Inspect the bore visually to be sure that it is perfectly clear (See “Ammunition Warning” p. 11 and “Care and Cleaning” section p. 29)

	WARNING – BORE OBSTRUCTIONS
	<p>Before loading or shooting the Mini-14 rifle, be certain the bore is unobstructed. <i>Firing the rifle with any obstruction in the bore may result in severe damage to the rifle and serious injury to the shooter and other persons nearby.</i></p>
	<p>A MISFIRE or unusual report (sound) upon firing is always a signal to cease firing immediately and after waiting for one minute, examine the chamber and bore of the firearm. It is not sufficient to retract the slide handle and examine the chamber. You must remove the magazine, clear the chamber, lock the bolt open and inspect the bore visually - and with a rod if necessary - to be certain it is completely clear of any obstruction. Failure to detect and correctly remove a bore obstruction can result in serious injury to the shooter and bystanders, and damage to the firearm.</p>
	DO NOT “SHOOT OUT” A BORE OBSTRUCTION

A gun user should recognize that a lodged bullet is a fairly common form of bore obstruction. Therefore the following information on how a bullet may become lodged in the bore, and how it should be removed, deserves most careful reading and heeding!

1. When firing, a bullet may become lodged in the bore if the cartridge contains no powder, or the powder fails to ignite and only the primer charge ignites, producing insufficient force to propel the bullet out of the bore.
2. A bullet may also become lodged in the bore when extracting a cartridge from the chamber (unloading). If the bullet is not crimped tightly enough in the cartridge case, the bullet may stick in the bore, with only the case being extracted.

Experience indicates that the two conditions described above occur most frequently with *reloaded ammunition*.

When either of the above described (1 or 2) situations occurs, proceed as follows *with the rifle pointing in a safe direction*:

- a) If the rifle is cocked, move the safety to the “ON” position.
- b) Remove the magazine from the rifle.

- c) Retract the slide handle and lock it in the open position by pressing in the bolt lock plunger in the top of the receiver. Retracting the slide handle should remove the cartridge case. Be certain the safety is in the “ON” position.
- d) Check the chamber to be certain there is no cartridge case in it -- if there is, extract it before proceeding with steps (e) and (f).
- e) **After making sure that the rifle is unloaded**, inspect the bore from the muzzle end of the barrel. If the bore is obstructed, insert a proper size cleaning rod (without a tip or brush) into the bore from the muzzle and dislodge and remove the bullet. If the bullet does not readily dislodge, it may be necessary to lightly tap the handle end of the cleaning rod. If such efforts fail to dislodge the bullet, take the rifle to a gunsmith. **DO NOT ATTEMPT TO REMOVE A LODGED BULLET USING A BLANK CARTRIDGE, OR A CARTRIDGE FROM WHICH THE BULLET HAS BEEN REMOVED, OR BY ANY MEANS OTHER THAN THE USE OF THE PROPER SIZE CLEANING ROD AND REASONABLE FORCE APPLIED TO THE ROD. BE CERTAIN ALL LOOSE POWDER HAS BEEN REMOVED FROM THE BORE AND ACTION BEFORE INTRODUCING THE ROD INTO THE BORE. NEVER TRY TO SHOOT OUT A BORE OBSTRUCTION!** See “Bore Obstruction Warning”, p. 19.
- f) Reinspect the bore to be certain it is free of unburned powder particles or any other debris. At the same time clean the magazine, the magazine well, and other areas of the mechanism of unburned powder grains.

It is absolutely essential that steps (a) through (f) be followed if there is any suspicion that a bullet has been lodged in the bore because of the situations described in 1 or 2 above. Remember that a bullet can be lodged in the bore of a rifle just where the rifling begins, and a live cartridge can still be chambered and the bolt closed and locked. This can occur because the bullet in the chambered cartridge is pushed back into the cartridge case far enough to give the shooter the impression that the loaded cartridge has chambered normally.

Always check the bore for an obstruction if you experience difficulty in chambering a cartridge, experience a failure to extract, have a misfire, or the rifle does not make a normal loud report on firing.

RELOADERS SHOULD USE ONLY CANNELURED BULLETS AND BE SURE TO CRIMP THEM SECURELY IN THE CARTRIDGE CASE. NOTE: Sturm, Ruger & Co. specifically does not recommend the use of reloaded, hand-loaded or remanufactured cartridges. Please see “Ammunition Notice” p. 11.

TO CLEAR A MALFUNCTION (“JAM”)

Before “doing something”, study the situation to determine the nature of the jam and how best to clear it. Any autoloading firearm may occasionally malfunction. If it does:

1. **Be certain the muzzle is pointed in a safe direction and the safety is “ON”.**

2. When attempting to free a jammed cartridge, do not use any type of tool that is likely to act as a “firing pin” and discharge the cartridge should the tool impact on the primer. Never use a cartridge as a “tool”.
3. After clearing a jam, inspect the gun mechanism to determine if dirt or debris might be the cause of the problem. Excess lubricant or grease can cause cartridges to feed sluggishly. An accumulation of grease, dirt or powder grains in the magazine can contribute to cartridge feeding problems.
4. After clearing a jam, inspect all cartridges that have been removed from the gun. Safely dispose of any cartridges which are dented or nicked or have bullets that are loose or improperly positioned in the cartridge case.
5. If it appears that the gun and magazine are not at fault and that the jam was caused by the type of cartridge being used, then try another type.
6. If the above procedures do not result in a smooth and reliable feeding firearm, don't use the gun until it feeds cartridges smoothly and reliably. The rifle should be returned directly to our Newport Product Service Department for repair. See the “Service and Parts” section p. 33, for packing and shipping information.

Another precaution: Form the habit of examining fired cartridge cases from time to time. If fired cases have bulged heads or show splits on any part of the case, stop using that ammunition and return the rifle to the factory for inspection. (See pages 33 - 34)

7. If a cartridge or shell is caught between the bolt and receiver, put the safety “ON”, retract the slide, and lock it in the open position. Remove the magazine; then remove the jammed case.
8. If a fired case is in the chamber, use a cleaning rod to knock it out.
9. If an unfired cartridge is stuck in the chamber, remove it from the breech-end rather than trying to dislodge it with a cleaning rod inserted from the muzzle. Use a piece of 3/16” brass rod which has one end shaped like a screwdriver tip. Insert the tip in the extractor groove of the cartridge, use the face of the receiver ring as a fulcrum and carefully pry out the cartridge. **Be careful not to strike the primer area of the live cartridge!** Vigorously brush-clean the chamber with solvent after clearing any jam involving the chamber.

TO MINIMIZE MALFUNCTIONS (“JAMS”)



Autoloading firearms of all makes and types occasionally malfunction when a cartridge fails to feed from the magazine to the chamber, or when a cartridge (or fired case) fails to properly extract and eject.

To minimize the possibility of such occurrences the gun user should:

1. Use ammunition of the correct caliber and type which is loaded to Industry Specifications. Avoid reloads, remanufactured cartridges, and cartridges that are dirty, corroded, or deformed. (See “Ammunition Warning”, p. 11)
2. Clean and lubricate the gun in accordance with the instructions in this manual.

3. If the mechanism shows signs of not functioning correctly, or if a part is damaged or broken -- don't use the gun. Have it inspected, and repaired. (See "Malfunction Warning" below)
4. Use only genuine Ruger® Mini-14 magazines and carefully load the magazine. Do not exceed the stated magazine capacity. (See "Loading Magazine", p. 13)
5. Do not 'ride' the slide handle when chambering a cartridge from the magazine. The slide should be drawn fully to the rear and then be permitted to snap forward under the full force of the recoil spring. If a cartridge does not fully chamber, do not 'pound' on the slide handle to force the bolt closed. Rather, retract the slide, eject the cartridge and determine the cause of the problem. (See "Bore Obstructions Warning" p. 19)
6. To minimize the probability of an unfired cartridge being jammed should it 'fall back' onto the magazine, remove the magazine *before* retracting the slide. When extracting an unfired cartridge, tip the right side of the rifle towards the ground so that gravity will assist the cartridge to fall clear of the magazine well. Always retract the slide briskly whenever extracting a live cartridge. Take care to see that a cartridge is not forcibly ejected against a surface where the primer might be set off.

Alterations to the rifle or use of non-Ruger magazines and accessories may cause malfunctions. See "Alteration Warning" on page 8. If the above procedures do not result in a smooth and reliable feeding firearm, don't use the gun. The rifle can be returned directly to our Newport, New Hampshire Product Service Department for repair. See the Service and Parts Policy section, page 33, of this manual for packing and shipping information.

 <h2 style="margin: 0;">WARNING – MALFUNCTIONS</h2>	
	<p>A cartridge can be "discharged" before it is chambered if its primer receives a sharp blow. If a cartridge hangs up, jams, or binds when being chambered or when being fed from the magazine into the chamber, do not attempt to force it into the chamber by pushing or striking the bolt. Any jam or feeding problem is a signal to immediately stop using the gun until it can be determined what is wrong. Most failures of a cartridge to feed or to chamber are caused by a damaged magazine, improper gun handling, or defective ammunition. Whatever the cause, cartridge jams can result in the potentially dangerous situation of a cartridge discharging before it is chambered. If this occurs, the cartridge case will rupture and its fragments will fly out of the gun with sufficient force to cause injury. Always wear shooting glasses and hearing protectors! Keep face away from chamber!</p>
	<p>STRIKING RIM OR PRIMER CAN BURST CARTRIDGE</p>



WARNING – DISASSEMBLY

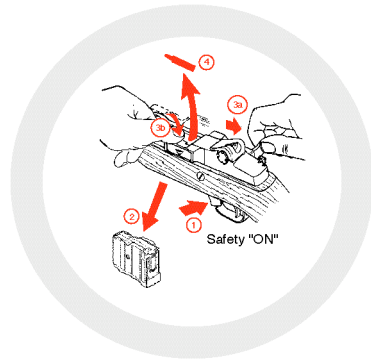

Always unload a firearm before cleaning, lubrication, disassembly or assembly.

**UNLOAD BEFORE
CLEANING**

DISASSEMBLY

Be Sure Rifle Is Unloaded!

Although The Mini-14 Rifle can be disassembled, reassembled, and cleaned in almost any surrounding, it is preferable to carry out these procedures on a workbench or table which has a covered top. A piece of shallow nap rug or an old blanket is an ideal covering. Such a covering keeps the rifle from slipping and being scratched.

1. **With the rifle pointing in a safe direction, safety “ON”, remove the magazine** by pushing catch forward to release magazine, while drawing magazine down and forward (See Fig. 6).

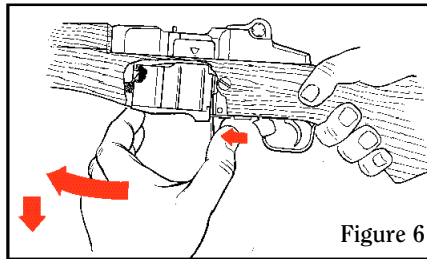

Figure 6

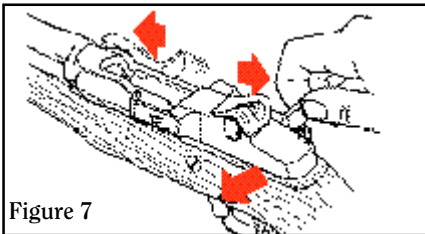
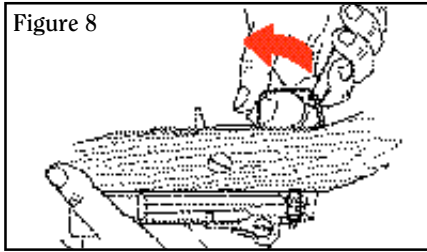

Figure 7

2. Pull the slide handle all the way to the rear and release. Make sure safety is “ON” (See Fig. 7). NOTE: Hammer must be cocked and safety must be “ON” to accomplish disassembly and reassembly. **Again, be sure chamber is empty!**

3. Use a 1/4" diameter steel rod, punch, screwdriver shank, or other suitable instrument inserted into the hole in the rear of the trigger guard as a lever to spring open the trigger guard from its latched position (See Fig. 8).



WARNING: Do *not* use a cartridge to unlatch the trigger guard because of the danger of loosening the bullet in the cartridge case (See Warnings in "Ammunition" section, p. 11).



4. Invert rifle and remove trigger housing assembly by carefully pulling it upward (See Fig. 9). Be careful not to damage stock when removing or replacing the trigger housing assembly.

5. Remove barrel/receiver assembly from stock by swinging rear end away from action slightly, then pull stock out of engagement with gas block (See Fig. 10).

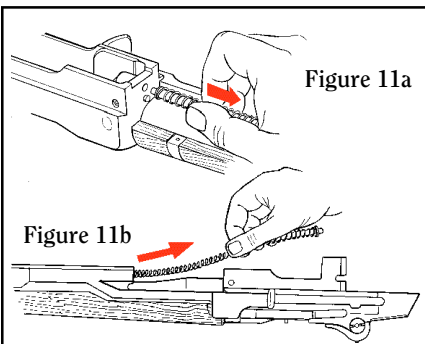
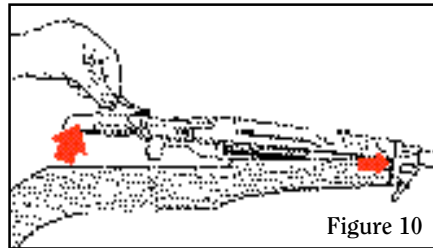

6. Remove guide rod and recoil spring (See Figs. 11a and 11b).

CAUTION: The recoil spring is heavily compressed — use eye protection and care when disassembling and reassembling to prevent the guide rod and spring from escaping forcibly and possibly causing injury.

7. Pull slide handle to the rear. Align locking projections on slide with disassembly notch on receiver. Remove slide (See Fig. 12).

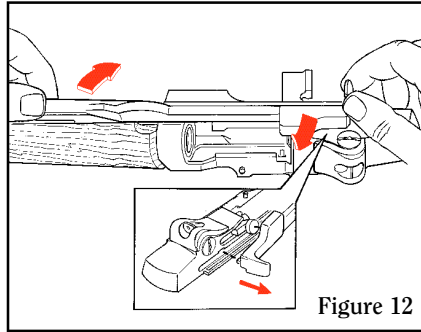

8. Pull the bolt forward until it can be pivoted out of receiver. Align firing pin projection with slot in lower receiver bridge and remove bolt from receiver (See Fig. 13).

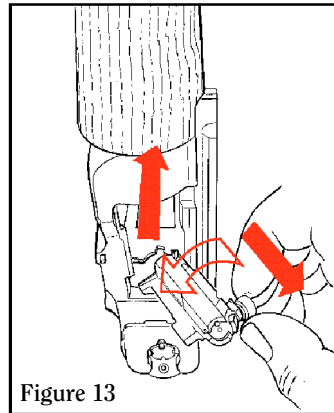

Removal of the bolt stop assembly is not normally required for routine cleaning.

9. The bolt lock cover plate can be removed by tapping downward (with a soft metal punch) at point "a" (See Fig. 14). With cover plate removed, depress bolt lock plunger "b", which will allow the bolt stop "c" to be lifted out.

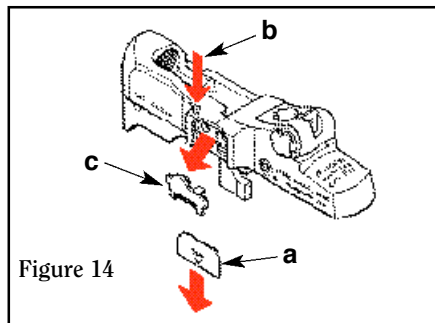

NOTE: The Mini-14 is like the M1 Garand and many other types of autoloading rifles in that the hammer can fall if the trigger is pulled when the bolt is partially retracted. It is important for the shooter to realize that the firing pin cannot contact the cartridge until the bolt is safely locked, regardless of the position of the slide.

Removal of the gas block assembly is not necessary and is not advisable. The gas block assembly is factory fitted using special fixtures and torque tools. Attempting to fit the gas block assembly without the required special equipment can result in damage to the components and malfunctioning of the rifle.

Further disassembly of the **RUGER® MINI-14® RIFLE** is not required for normal cleaning purposes and should only be performed by a trained armorer who is experienced in firearms repair.

REASSEMBLY

Again, Be Sure Rifle and Magazine are Completely Unloaded!

1. Reassembly of bolt into receiver:

- a. Bolt can be reinserted by holding it at approximately a 45° angle to the receiver, with the rear end of the bolt angling downward. Insert the tail of the firing pin through the slot in the receiver bridge, and “wobble” the bolt until its rear end moves back into the receiver. Then, push it forward to its closed and locked position. It should rotate and move freely into place.
- b. If you have removed the bolt stop (step 9, p. 25) reinsert the bolt lock plunger and spring into its hole in the top of the receiver. Depress the plunger until the rectangular cut in its side lines up with the round hole seen inside the receiver on the left side. **CAUTION! Plunger will now be under spring tension and could cause injury if suddenly released.** While holding the plunger against its spring in this position, insert the bolt stop until its rectangular “tab” goes into the rectangular cut on the bolt lock plunger. Sliding the bolt lock cover plate upward (prying it upward slightly with a screwdriver if necessary) completes reassembly of the bolt lock. Note that the large inverted triangular protection on the cover plate goes on the outside of the rifle.

2. Reinstalling remaining parts of barrel/receiver group:

- a. Retract bolt. Replace operating slide by angling the handle portion upward between the handguard and receiver ring; then lower the slide so that the cam track on the inside of the rod fits over the roller on the right locking lug of the bolt, and the tab adjacent to the slide handle goes into its track on the right side of the receiver.
- b. Push operating rod fully forward. Be sure that the gas piston fits into the hole in the front of the slide.
- c. Hold action upside down as show in Figure 11b, p. 24. Carefully insert recoil spring into hole in rear of slide, and compress the recoil spring until the end of the guide rod can be reinserted into the small hole in the front of the receiver.

CAUTION! The recoil spring will be strongly compressed during this step and can fly out with considerable force, possibly resulting in injury. Keep it under your control and proceed with care.

3. Final reassembly of rifle:

- a. Replace stock by inserting its front end into the gas block at a slight angle. When the stock is correctly seated into the gas block, the stock can be swung down into full contact with the receiver.
- b. Insert the opened trigger housing assembly, safety “ON”, into the stock (the hammer must be cocked prior to insertion). When fully seated, swing the trigger guard fully into place until it locks shut. An audible “click” will be heard when it is correctly locked. Cycle the slide handle and safety a few times to be certain the components are correctly assembled. Put the safety back “ON”.
- c. Reinsert an empty magazine and fully withdraw slide. The bolt should lock open automatically.

GUNS SHOULD NOT BE STORED LOADED!

REMOVAL AND REPLACEMENT OF FIBERGLASS HANDGUARD

1. **MAKE CERTAIN THE RIFLE CONTAINS NO CARTRIDGES AND THAT IT IS POINTING IN A SAFE DIRECTION.**
2. Remove the magazine. Leave the slide in the forward position.
3. With the rifle flat on its side, apply substantial thumb pressure, with both thumbs, to the projecting underside of the handguard in the area of the retaining spring. (The spring is located underneath the circular projection on the top of the handguard.) The pressure should be applied so as to raise the rear portion of the handguard first.
4. To replace the handguard, put the forward end of the handguard under the top portion of the gas block (as far forward as possible) and squeeze the handguard down over the barrel.

MAGAZINE INSPECTION AND CARE

Check the magazine frequently. The follower must move freely and have adequate spring tension so that each cartridge is quickly raised to the feeding position.

To test the spring tension, load one cartridge into the magazine and then firmly press against the cartridge case. Remove your finger quickly. The cartridge should instantly and fully move in to the feeding position. If it does not, the magazine should be cleaned. **If cleaning does not restore proper spring tension, do not use the magazine.** (NOTE: After testing, remove the test cartridge).

When cleaning is necessary, use a solvent that will not rust the metal components or adversely affect the plastic magazine bottom. The magazine may be disassembled by placing a small screwdriver through the hole located in the magazine bottom and depressing the magazine bottom retainer. Carefully use the

screwdriver to push the magazine bottom rearward as you push down on the spring-loaded bottom retainer. After the magazine bottom has been slid rearward off the magazine shell, carefully raise the rear end of the bottom retainer so that its two small lugs can be slid out the rear of the magazine and carefully remove the bottom retainer. **CAUTION! It is under spring tension from the magazine spring.** The magazine spring and follower may now be removed from the bottom of the magazine shell, completing its disassembly. After the magazine has been soaked in solvent to loosen foreign matter, be certain to shake it vigorously (with the loading opening away from you) to remove solvent or residue from within the magazine.

Reassembly of the magazine can be accomplished by hooking the magazine spring into the hole in the magazine follower from the right side. Reinsert this assembly upwards into the magazine shell. Carefully compress the spring and slide the bottom retainer on from the rear. Finally, press the bottom retainer downward and slide the magazine bottom on from the rear.

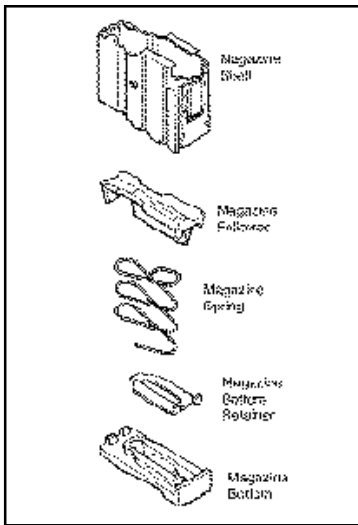

Figure 15. Exploded view of the Mini-14 magazine components. This illustration is included to show the relationship and names of the magazine components.



CARE AND CLEANING

BEFORE CLEANING, BE CERTAIN THE RIFLE AND ITS MAGAZINE CONTAIN NO CARTRIDGES.

At regular intervals, or whenever the rifle has been exposed to sand, dust, extreme humidity, condensation, immersion in water, or other adverse conditions, disassemble, clean and oil it. Proper periodic maintenance is essential to the reliable functioning of any firearm.

To clean the rifle, proceed as follows:

1. Disassemble (field-strip) the rifle to the extent described on pages 23 - 25.
2. Using a cleaning rod, run a solvent-wetted patch through the bore several times. Then attach a solvent-wetted bristle brush to the rod and run it back and forth the full length of the bore as many times as necessary to remove grease and dirt from the bore and chamber. Clean bore with dry patches and examine. Bore fouling can contribute to reduced accuracy, and grease accumulation in the chamber can interfere with proper feeding of cartridges from the magazine.
3. Using powder solvent on a clean patch or bristle brush, remove powder residue from all components of the mechanism. After cleaning, run a dry patch through the bore, then follow with a patch that is very lightly oiled. Wipe all surfaces clean with cloth, then wipe all surfaces with a patch or cloth that has been very lightly oiled.
4. NOTE: Only a light application of oil is needed to provide adequate lubrication of moving parts and to prevent rust. Excess accumulations of oil tend to attract particles of dust and dirt and may congeal in cold weather which can interfere with the safe and reliable function of the rifle.

 WARNING – LUBRICATION	
	<p>Firing a rifle with oil, grease, or any other material even partially obstructing the bore may result in damage to the rifle and serious injury to the shooter and those nearby. Do not spray or apply lubricants directly on ammunition. If the powder of a cartridge is affected by the lubricant, it may not be ignited, but the primer firing may push the bullet into the bore where it may be lodged. Firing a subsequent bullet into the obstructed bore may damage the rifle and cause serious injury or death to the shooter and those nearby. Use lubricants properly. You are responsible for the proper care and maintenance of your firearms.</p>
IMPROPER LUBRICATION DESTROYS GUNS	

STORAGE

GUNS SHOULD NOT BE STORED LOADED!

**USE THE LOCKING DEVICE SUPPLIED WITH THE RIFLE FOR STORAGE.
(SEE PAGE 6)**

Do not store the rifle in a leather case or scabbard. Leather attracts moisture, even though it may appear to be dry.

TO RENDER THE RIFLE INOPERATIVE FOR SAFE STORAGE

With the muzzle pointed in a safe direction, remove the magazine, retract the slide handle, and retract the bolt fully to the rear. Lock the bolt open and check the chamber to be sure the rifle is completely unloaded! With the muzzle pointed in a safe direction, pull downward on the rear end of the trigger guard and remove the trigger housing assembly from the bottom of the rifle.

Store the rifle and the trigger housing assembly in different locations. When disassembled in this manner, the rifle is inoperable. It is impossible to fire the rifle until the trigger housing assembly has been correctly replaced.

To reassemble the rifle for firing, reinsert the trigger housing assembly into the receiver from the bottom. Swing the trigger guard upward and rearward until it latches securely in place. Check to be sure that the bolt can be operated fully and freely by operating the slide handle back and forth. The rifle is now reassembled and can be loaded and fired normally.

While the rifle is less likely to be used by unauthorized persons when disassembled in the above manner, it is always safest to store a firearm with the supplied locking device correctly installed, or to store the firearm in a gun safe or other secure location, away from children and unauthorized adults. Guns should always be stored securely, unloaded and separate from their ammunition.

 WARNING – STORAGE	
	<p>Never place or store any fire arm in such a manner that it may be dislodged. Fire arms should always be stored securely and unloaded, away from children and careless adults. Use the locking device originally supplied with this fire arm for storage.</p> <p>The use of a locking device or safety lock is only one aspect of responsible fire arms storage. For increased safety, fire arms should be stored unloaded and locked in a location that is both separate from their ammunition and inaccessible to children and any other unauthorized person.</p>
STORE SECURELY & UNLOADED	

MAINTENANCE OF STAINLESS STEEL RIFLES

Firearms and components made of stainless steel are relatively more resistant to corrosion than those of blued steel. However, in the interest of proper operation and long life of a stainless steel firearm, inspect it frequently and clean, lubricate and apply an appropriate rust preventative.

Sometimes discoloration occurs from perspiration or from contact with some types of gun cases. Rusting may occur as a result of the firearm being exposed to moisture, salt air or chemicals.

Minor discoloration can usually be removed by rubbing the stainless area with an abrasive ink eraser, crocus cloth, or a “metal polishing” compound. When using any of these abrasives, proceed with care and use light pressure to achieve a blending of “color” with those areas that are not discolored. Do not use abrasives on the clear coating of the aluminum alloy trigger housing.

External surfaces most subject to rusting from handling, or from exposure to the elements should be cleaned and wiped dry after use or after exposure to adverse conditions. If the rifle is to be stored, coat it with a light film of oil or preservative. Where the rifle is in continuing use, and the presence of oil or grease would be objectionable, then the external surfaces can be coated (after cleaning and drying) with a paste wax formulated for use on metals. Apply the wax sparingly, allow time for it to dry hard, then buff lightly with a soft cloth. When applying the wax, take care that it does not get into the mechanism or on the functioning parts or in the bore.

SIGHT ADJUSTMENT

Shooting to determine the setting of the elevation slide (aperture) should be done from a bench rest and over a measured distance.

SUGGESTED SIGHT PICTURE

The front sight is aligned in the center of the rear sight aperture (“peep”) and the target (bullseye) is positioned to appear as if it is sitting on top of the front sight.

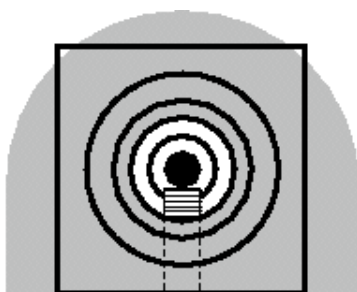

The rear sight is adjustable for both windage and elevation. A small punch, the head of a finishing nail, or other similar instrument can be used to depress the plunger to allow the adjustment to be moved one quarter turn in either direction. One quarter turn will move the point of impact 1 inch at 100 yards. The sight adjustments have been made deliberately positive by means of spring-loaded detent plungers so that settings cannot be accidentally disturbed under normal conditions.

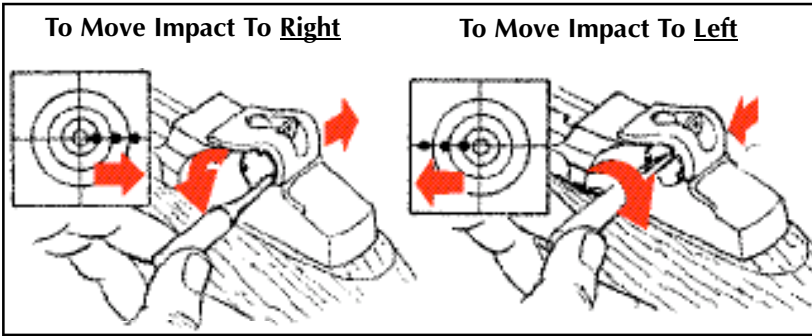

WINDAGE ADJUSTMENT: To move the bullet impact point to the right, move the rear sight base to the right by turning the adjustment knob counterclockwise. To move the bullet impact point to the left, move the rear sight base to the left by turning the side adjustment knob clockwise.

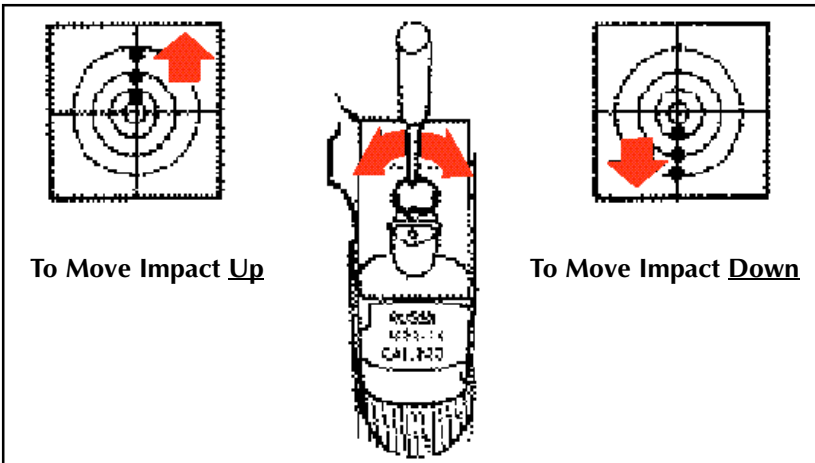

ELEVATION ADJUSTMENT: To move the bullet impact point up, move the elevation slide (the “peep”) up by turning the top adjustment knob counterclockwise. To move the bullet impact point down, move the elevation slide down by turning the top adjustment knob clockwise.

SERVICE AND PARTS POLICY

If you have any question with regard to the performance of your **RUGER® MINI-14®** rifle please write or call (603-865-2442) our Product Service Department in Newport, New Hampshire 03773, fully describing all circumstances and conditions involved. If you should return your rifle to the factory for repair, or order parts for it, please comply with the following suggestions for prompt service:



WARNING: BEFORE SHIPPING ANY FIREARM, BE ABSOLUTELY CERTAIN THAT IT AND ITS MAGAZINE ARE UNLOADED. DO NOT SHIP CARTRIDGES WITH A FIREARM.

SHIPPING FIREARMS FOR REPAIR

RUGER® MINI-14® rifles returned to the factory for repair should be sent to: Sturm, Ruger & Company, Inc., Product Service Department, 411 Sunapee St., Newport, New Hampshire 03773. Telephone (603) 865-2442.

Guns should be sent prepaid. We will not accept collect shipments.

The Federal Gun Control Act, as well as the laws of most States and localities, do not prohibit an individual (who is not otherwise barred from purchasing or possessing a firearm) from shipping a firearm directly to the manufacturer for repair. However, before you ship your rifle to us, be certain that your State or locality does not have a law or regulation which will prohibit you from receiving the rifle from us after it has been repaired. If such receiving is prohibited, then please have a Federally Licensed firearms dealer ship the gun to us. If your rifle is sent to us by a dealer, it will be returned to him after being repaired. If a handgun (pistol or revolver) is shipped by an individual who does not hold a Federal Firearms License, it must be shipped via U.P.S. (Next Day Air) Persons who do not hold a Federal Firearms License are prohibited by Federal law from shipping a handgun by Mail. Handguns mailed in violation of the law are impounded by the Post Office.

DO NOT SEND GUN BOXES OR LITERATURE THAT YOU CONSIDER TO BE COLLECTOR'S ITEMS – THESE ARE INVARIABLY DAMAGED OR DESTROYED IN SHIPMENT. Please do not include rifle case, sling, telescopic sights or custom accessories with a firearm being shipped to the factory for service. Rifles and shotguns may be shipped via Parcel Post. Always insure your shipment.

Enclose a letter which includes your name, address, telephone number, serial number and model of the firearm. Describe in detail the trouble you have experienced with your firearm, or the work you wish to have done. Merely stating that the firearm “needs repair” is inadequate information.

Work performed will bear a net minimum labor charge of \$20.00 plus a \$12.00 shipping and handling charge. The charge for rebluing the **RUGER® MINI-14® RIFLE** is \$50.00 plus a \$12.00 shipping and handling charge. Custom gunsmithing service or nonstandard alterations are NOT AVAILABLE from Ruger Product Service Departments.



WARNING – PARTS PURCHASERS



It is the purchaser's responsibility to be absolutely certain that any parts ordered from the factory are correctly fitted and installed. Firearms are complicated mechanisms and **IMPROPER FITTING OF PARTS MAY RESULT IN A DANGEROUS MALFUNCTION, DAMAGE TO THE FIREARM, AND SERIOUS INJURY TO THE SHOOTER AND OTHER PERSONS.** The purchaser and installer of parts must accept full responsibility for the correct adjustment and functioning of the rifle after such installation.

PARTS MUST FIT CORRECTLY

ORDERING PARTS

Please contact the New Hampshire Product Service Department for parts availability and current prices. All parts orders for the **RUGER® MINI-14®** rifle should be sent to: Sturm, Ruger & Co., Inc., Product Service Department, 411 Sunapee Street, Newport, New Hampshire 03773, 603-865-2442. We cannot comply with open account or C.O.D. orders. Payment in the form of a check, money order, Visa or Mastercard must accompany your order. Credit Card orders must include the account number, expiration date and whether it is a Visa or Mastercard account. Minimum parts order is \$1.00 plus \$3.50 shipping and handling charge. Order parts by Part Name and Part Number and include the entire serial number of the firearm for which the parts are being ordered. There is a minimum net labor charge of \$20.00 plus \$12.00 shipping and handling charge if the parts are factory fitted. All factory fitted parts are fit on an exchange basis only. We will not return the replaced parts.

Barrels, and a number of other component parts must be fitted at the factory. Company policy is to proof-test and/or function fire all barrels after fitting to the receivers in which they are to be used. This procedure ensures maximum protection to our customers. The special proof-test ammunition used in this testing is sold only to bonafide firearms manufacturers and is not available to gun shops, gunsmiths, or individuals.

Because the receiver of the **RUGER® MINI-14®** is a serial numbered component, it is defined as a "firearm" by Federal law and is not sold as a separate component.

*Parts designated by an asterisk must be factory fitted. These parts are fitted on an exchange basis only. We will not return the replaced parts. We will not return any part that is broken, malfunctioning, badly worn or has been modified. See "Warning – Parts Purchasers", above.



CAUTION: A gun containing modified, broken, malfunctioning, or badly worn parts should not be fired.

RUGER® MINI-14® RIFLE

PARTS LIST

Design, prices and specifications subject to change without notice.

SPECIFY MODEL & SERIAL NUMBER WHEN ORDERING

(See Exploded View on Page 41)

Part Name	Part No.	Model
* Barrel, Specify Model & Serial Number	0M8001	Mini-14 - Blued Model
* Barrel, Specify Model & Serial Number	K0M8001	Mini-14 - Stainless Models
* Bolt Assembly	MS01000A	Mini-14 - Blued Model
* Bolt Assembly	KMS01000A	Mini-14 - Stainless Models
Bolt Lock Buffer Spring	MS06000	All Mini-14 Models
Bolt Lock Cover Plate	MS06700	Mini-14 - Blued Model
Bolt Lock Cover Plate	KMS06700	Mini-14 - Stainless Models
Bolt Lock Plunger	MS04500	Mini-14 - Blued Model
Bolt Lock Plunger	KMS04500	Mini-14 - Stainless Models
Bolt Lock Plunger Spring	KMS04600	All Mini-14 Models
Bolt Stop Assembly	MS13200	Mini-14 - Blued Model
Bolt Stop Assembly	KMS13200	Mini-14 - Stainless Models
Butt Pad	D06315	Mini-14 - Stainless, Synthetic Stock Model
Butt Pad Screw, 2 Req'd	B-91	Mini-14 - Stainless, Synthetic Stock Model
Butt Plate	C-63	Mini-14 - Stainless & Blued, Wood Stock Models
Butt Plate Screw, 2 Req'd	B-64	Mini-14 - Stainless & Blued, Wood Stock Models
Ejector	KMS00800	All Mini-14 Models
Ejector Spring	MS07000	All Mini-14 Models

Part Name	Part No.	Model
Extractor	MS01400	Mini-14 - Blued Model
Extractor	KMS01400	Mini-14 - Stainless Models
Extractor Plunger	KMS01600	All Mini-14 Models
Extractor Spring	MS01500	All Mini-14 Models
* Firing Pin	KMS01102A	All Mini-14 Models
Forearm Liner & Stock Cap Assembly	MS02200	Mini-14 - Blued Model
Forearm Liner & Stock Cap Assembly	KMS02200	Mini-14 - Stainless Models
Front Sight	MS04400	Mini-14 - Blued Model
Front Sight	KMS04400	Mini-14 - Stainless Models
Front Sight Cross Pin	MS07200	Mini-14 - Blued Model
Front Sight Cross Pin	KMS07200	Mini-14 - Stainless Models
* Gas Block, Top & Bottom, 2 Pieces	MS03500	Mini-14 - Blued Model
* Gas Block, Top & Bottom, 2 Pieces	KMS03500	Mini-14 - Stainless Models
Gas Block Screw, 4 Req'd.	MS06500	Mini-14 - Blued Model
Gas Block Screw, 4 Req'd.	KMS06500	Mini-14 - Stainless Models
Gas Port Bushing	KMS02500	All Mini-14 Models
Guide Rod	MS03900	Mini-14 - Blued Model
Guide Rod	KMS03900	Mini-14 - Stainless Models
* Hammer	MS01700	Mini-14 - Blued Model
* Hammer	KMS01700	Mini-14 - Stainless Models
Hammer Pivot Pin	MS01900	Mini-14 - Blued Model
Hammer Pivot Pin	KMS01900	Mini-14 - Stainless Models
Hammer Spring	KMS04700	All Mini-14 Models
Hammer Strut	MS01800	Mini-14 - Blued Model

Part Name	Part No.	Model
Hammer Strut	KMS01800	Mini-14 - Stainless Models
Hammer Strut Assembly	MS01800A	Mini-14 - Blued Models
Hammer Strut Assembly	KMS01800A	Mini-14 - Stainless Models
Handguard Assembly, Fiberglass	MFH	All Mini-14 Models
Magazine, Complete, 5-Shot Capacity	MAG/5	All Mini-14 Models
Magazine Bottom	MS03400	All Mini-14 Models
Magazine Bottom Retainer	MS02600	All Mini-14 Models
Magazine Follower	MS03000	All Mini-14 Models
Magazine Latch, Front	MS04000	Mini-14 - Blued Model
Magazine Latch, Front	KMS04000	Mini-14 - Stainless Models
Magazine Latch, Rear	MS03100B	Mini-14 - Blued Model
Magazine Latch, Rear	KMS03100B	Mini-14 - Stainless Models
Magazine Latch Cross Pin	MS06600	Mini-14 - Blued Model
Magazine Latch Cross Pin	KMS06600	Mini-14 - Stainless Models
Magazine Latch Pivot Pin	MS01200	Mini-14 - Blued Model
Magazine Latch Pivot Pin	KMS01200	Mini-14 - Stainless Models
Magazine Latch Spring	MS05000	Mini-14 - Blued Model
Magazine Latch Spring	KMS05000	Mini-14 - Stainless Models
Magazine Shell	MS02700	All Mini-14 Models
Magazine Spring	MS02800	All Mini-14 Models
Pistol Grip Cap	D-80SB	Mini-14 - Stainless, Synthetic Stock Model
Pistol Grip Cap Medallion	D-82	Mini-14 - Stainless, Synthetic Stock Model
Pistol Grip Cap Screw	C-96SM	Mini-14 - Stainless, Synthetic Stock Model
Piston, Gas Pipe	MS03600	Mini-14 - Blued Model

Part Name	Part No.	Model
Piston, Gas Pipe	KMS03600	Mini-14 - Stainless Models
Rear Sight Adjustment Tool	RSAT	All Mini-14 Models
Rear Sight Assembly, Complete	MS05500B	All Mini-14 Models
Rear Sight Base	MS05500	All Mini-14 Models
Rear Sight Elevation Detent Plunger	MS07300	All Mini-14 Models
Rear Sight Elevation Detent Spring	MS05600	All Mini-14 Models
Rear Sight Elevation Screw	MS07400	All Mini-14 Models
Rear Sight Elevation Plunger	MS05300	All Mini-14 Models
Rear Sight Elevation Plunger Spring	MS05400	All Mini-14 Models
Rear Sight Nut	MS05700	Mini-14 - Blued Model
Rear Sight Nut	KMS05700	Mini-14 - Stainless Models
Rear Sight, Peep	MS05201	All Mini-14 Models
Rear Sight Windage Detent Plunger	MS06100	All Mini-14 Models
Rear Sight Windage Detent Spring	MS05800	All Mini-14 Models
Rear Sight Windage Screw	MS05900	Mini-14 - Blued Model
Rear Sight Windage Screw	KMS05900	Mini-14 - Stainless Models
Rear Sight Windage Screw Pin	KMS07100	All Mini-14 Models
Safety Assembly	MS13800A	Mini-14 - Blued Model
Safety Assembly	KMS13800A	Mini-14 - Stainless Models
Safety Detent Spring	KMS04900	All Mini-14 Models
Safety Spring Retaining Pin	MS06200	Mini-14 - Blued Model
Safety Spring Retaining Pin	KMS06200	Mini-14 - Stainless Models
* Secondary Sear	MS02300	Mini-14 - Blued Model
* Secondary Sear	KMS02300	Mini-14 - Stainless Models

Part Name	Part No.	Model
Secondary Sear Spring	KMS02400	All Mini-14 Models
Slide Assembly	MS23701	Mini-14 - Blued Model
Slide Assembly	KMS23701	Mini-14 - Stainless Models
Slide Spring/Recoil Spring	KMS05101	All Mini-14 Models
Sling, Carrying, Nylon, Not Illustrated	MA-132	All Mini-14 Models
Sling Swivel, Front	MS07500	Mini-14 - Blued Model
Sling Swivel, Front	KMS07500	Mini-14 - Stainless Models
Sling Swivel, Rear	MS07601	Mini-14 - Blued Model
Sling Swivel, Rear	KMS07600	Mini-14 - Stainless Models
Stock, Wood With Butt Plate	MS00400	Mini-14 - Stainless & Blued, Wood Stock Models
Stock Assembly, Synthetic	MS30426	Mini-14 - Stainless, Synthetic Stock Model
Stock Reinforcement	MS00700	Mini-14 - Blued Model
Stock Reinforcement	KMS00700	Mini-14 - Stainless, Wood Stock Model
Stock Reinforcement Lock Washer, 2 Req'd.	MS08000	Mini-14 - Stainless & Blued, Wood Stock Models
Stock Reinforcement Screw, 2 Req'd.	MS06900	Mini-14 - Blued Model
Stock Reinforcement Screw, 2 Req'd.	KMS06900	Mini-14 - Stainless, Wood Stock Model
Stripper Clip, Not Illustrated	MS08400	All Mini-14 Models
* Trigger	MS02000	Mini-14 - Blued Model
* Trigger	KMS02000	Mini-14 - Stainless Models
Trigger Bushing	MS04300	Mini-14 - Blued Model
Trigger Bushing	KMS04300	Mini-14 - Stainless Models

Part Name	Part No.	Model
Trigger Guard	MS00200	Mini-14 - Blued Model
Trigger Guard	KMS00200	Mini-14 - Stainless Models
Trigger Housing	MS01300	Mini-14 - Blued Model
Trigger Housing	KMS01300	Mini-14 - Stainless Models
Trigger Pivot Pin	MS02100	Mini-14 - Blued Model
Trigger Pivot Pin	KMS02100	Mini-14 - Stainless Models
Trigger Spring	KMS04800	All Mini-14 Models

* PARTS SO MARKED MUST BE FACTORY FITTED

THE BASIC RULES OF SAFE FIREARMS HANDLING

We believe that Americans have a right to purchase and use firearms for lawful purposes. The private ownership of firearms in America is traditional, but that ownership imposes the responsibility on the gun owner to use his firearms in a way which will ensure his own safety and that of others. When firearms are used in a safe and responsible manner, they are a great source of pleasure and satisfaction, and represent a fundamental part of our personal liberty.

Firearms do not cause accidents! Firearms accidents are almost always found to have been the result of carelessness, or ignorance on the part of the shooter of the basic rules of safe gun handling.

The following rules must be observed by gun users at all times. Safe gun handling is not just desirable, it is absolutely essential to your safety, the safety of others, and the continuation of gun ownership and sport shooting as we know it today.

1. LEARN THE MECHANICAL AND HANDLING CHARACTERISTICS OF THE FIREARM YOU ARE USING.

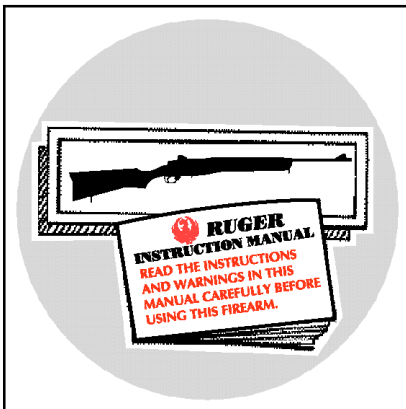

Not all firearms are the same. The method of carrying and handling firearms varies in accordance with the mechanical provisions for avoiding accidental discharge and the various proper procedures for loading and unloading. No person should handle any firearm without first having thoroughly familiarized himself with the particular type of firearm he is using, and with safe gun handling in general.

2. ALWAYS KEEP THE MUZZLE POINTED IN A SAFE DIRECTION.



Be sure of the bullet stop behind your target, even when dry-firing. Never let the muzzle of a firearm point at any part of your body or at another person. This is particularly important when loading or unloading a firearm. In the event of an accidental discharge, no injury can occur as long as the muzzle is pointing in a safe direction. A safe direction means a direction which will not permit a discharged bullet to strike a person, or to strike an object from which the bullet may ricochet.

A safe direction must take into account the fact that a bullet may penetrate a wall, ceiling, floor, window, etc., and strike a person or damage property. Make it a habit to know exactly where the muzzle of your gun is pointing whenever you handle it, and be sure that you are always in control of the direction in which the muzzle is pointing, even if you fall or stumble. Keep your finger off the trigger until you are ready to shoot.

3. FIREARMS SHOULD BE UNLOADED WHEN NOT IN USE.

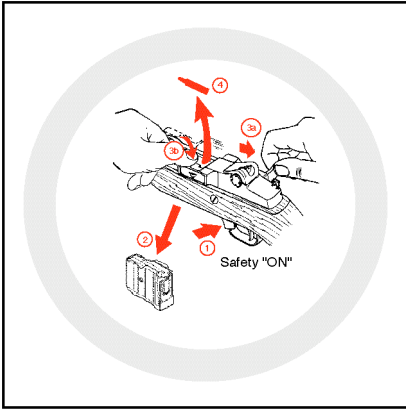

Firearms should be loaded only when you are in the field or on the target range or shooting area, ready to shoot. Firearms and ammunition should be securely locked in safes, racks or cabinets, or by using the locking device supplied with the firearm, when not in use. Ammunition should safely be stored separate from firearms. Store your firearms out of sight of visitors and children. It is the gun owner's responsibility to be certain that children and

persons unfamiliar with firearms cannot gain access to firearms, ammunition, or components.

4. BE SURE THE BARREL IS CLEAR OF OBSTRUCTIONS BEFORE SHOOTING.

Even a bit of mud, snow or excess lubricating oil or grease in the bore may cause the barrel to bulge, or even burst on firing, and can cause serious injury to the shooter and bystanders. Be sure that you are using ammunition of the proper caliber and loading for the gun you are using. If the report or recoil on firing seems weak, or doesn't seem quite right, CEASE FIRING IMMEDIATELY, unload your firearm, and check to be sure that no obstruction has become lodged in the barrel. Never try to shoot out an obstruction!

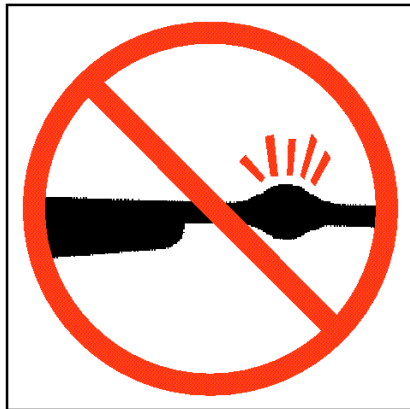



5. BE SURE OF YOUR TARGET BEFORE YOU SHOOT.

Don't shoot unless you know exactly where your bullet is going to strike. Be sure of the bullet stop behind your target, even when dry-firing with an unloaded gun. If you are in the field hunting, do not fire at a movement or noise. Take the time to be absolutely certain of your target before you pull the trigger.

6. WEAR SHOOTING GLASSES AND HEARING PROTECTORS WHEN YOU SHOOT.

All shooters should wear protective shooting glasses and adequate hearing protectors when shooting. Exposure to shooting noise can damage hearing, and adequate eye protection when shooting is essential.



7. NEVER CLIMB A TREE OR FENCE WITH A LOADED FIREARM.

Put the firearm down carefully before climbing a fence, and unload it before climbing or descending a tree or jumping over a ditch or other obstruction. Never pull or push a loaded firearm toward yourself or another person. When in doubt, or whenever you are about to do anything awkward, unload your gun!

8. DON'T SHOOT AT A HARD SURFACE, OR AT WATER.

Bullets can glance off many surfaces like rocks or the surface of water and travel in unpredictable directions with considerable velocity.

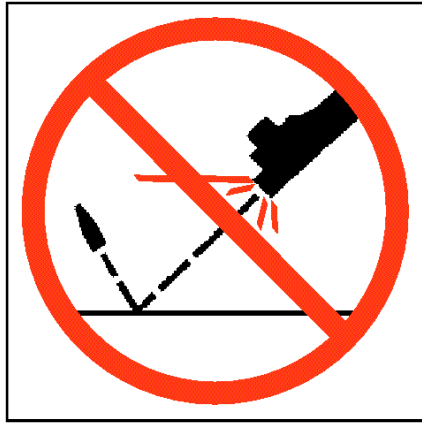

9. NEVER TRANSPORT A LOADED FIREARM.

Firearms should always be unloaded before being placed in a vehicle. A suitable carrying case or scabbard should be used to carry an unloaded firearm to and from the shooting area.

10. AVOID ALCOHOLIC BEVERAGES WHEN SHOOTING.

Don't drink until the day's shooting is over. Handling firearms while under the influence of alcohol in any form, or medications that could affect your judgement or co-ordination, constitutes a criminal disregard for the safety of others.



A BRIEF ACCOUNT OF AN EXTRAORDINARY ACHIEVEMENT: RUGER FIREARMS

One of the few American firearms manufacturers whose management has remained in the same family since starting in business, Sturm, Ruger & Company, Inc., had its beginning in a small machine shop occupying a rented frame building in Southport, Connecticut. In January, 1949, with an initial investment of only \$50,000 and an idea, William B. Ruger and Alexander M. Sturm started production of a .22 caliber autoloading pistol—a design which was so successful that it became the cornerstone upon which one of the most comprehensive lines of sporting firearms ever made in America was established. After Alex Sturm's death in 1951, William B. Ruger continued to direct the company alone and today, William B. Ruger, Jr. continues to provide guidance which has made this company a sound and successful enterprise.

Sturm, Ruger & Company, in this relatively short time, has established itself as a leading small arms design organization, developing a unique and broad line of fine quality sporting, military and police firearms to become one of the world's most famous producers of revolvers, pistols, rifles and shotguns. Since 1949 Ruger craftsmen have built many millions of firearms.

During its five decades of growth and progress under the leadership of William B. Ruger, the company developed a business philosophy and implemented policies which represent a constructive influence in the life of modern America. From the beginning, Sturm, Ruger & Company played a positive role in conservation efforts and has supported the interests of shooters through such groups as the National Rifle Association, National Shooting Sports Foundation, and many regional sportsmen's organizations.

The company has always endeavored to market its firearms for constructive and recreational purposes, to emphasize the traditional aspects of shooting, to render meaningful public services and to encourage shooters in constructive, responsible, and safe participation in the shooting sports. Its motto is "Arms Makers For Responsible Citizens."

Today, Sturm, Ruger & Company is particularly mindful of those elements which have contributed to the creation of its success, and extends heartfelt thanks to its many loyal employees and customers.

A current catalog of Ruger firearms is available free upon request to
Sturm, Ruger & Co., Inc., Southport, CT 06890

WHY NO WARRANTY CARD HAS BEEN PACKED WITH THIS NEW RUGER FIREARM

The Magnuson-Moss Act (Public Law 93-637) does not require any seller or manufacturer of a consumer product to give a written warranty. It does provide that if a written warranty is given, it must be designated as "limited" or as "full" and sets minimum standards for a "full" warranty. Sturm, Ruger & Company, Inc. has elected not to provide any written warranty, either "limited" or "full", rather than to attempt to comply with the provisions of the Magnuson-Moss Act and the regulations issued thereunder. There are certain implied warranties under state law with respect to sales of consumer goods. As the extent and interpretation of these implied warranties varies from state to state, you should refer to your state statutes. Sturm, Ruger & Company wishes to assure its customers of its continued interest in providing service to owners of Ruger firearms.



STURM, RUGER & Company, Inc.
Southport, Connecticut 06890 U.S.A.
www.ruger.com

“Arms Makers For Responsible Citizens”[®]

**A COPY OF THE INSTRUCTION MANUAL FOR ANY RUGER
FIREARM IS AVAILABLE FROM THE FACTORY FREE ON REQUEST.
THESE INSTRUCTION MANUALS CONTAIN IMPORTANT
WARNINGS WHICH MUST BE UNDERSTOOD
BEFORE USING THESE FIREARMS.**

22/45", "Model 96", "77/17", "Gold Label", and "Target Grey" are RUGER TRADEMARKS. "RUGER", THE STURM, RUGER LOGO, "10/22", "All-Weather", "Arms Makers For Responsible Citizens", "Bearcat", "Blackhawk", "GP-100", "M77", "Mini Thirty", "Mini-14", "Old Army", "P90", "P93", "P94", "Redhawk", "77/22", "77/44", "77/50", "SP101", "Vaquero", and "Single Six" are REGISTERED U.S. TRADEMARKS. "DEERFIELD" is a registered trademark of Blount, Inc.