

PATTERN-MAKING
CORE-MAKING AND MOLDING

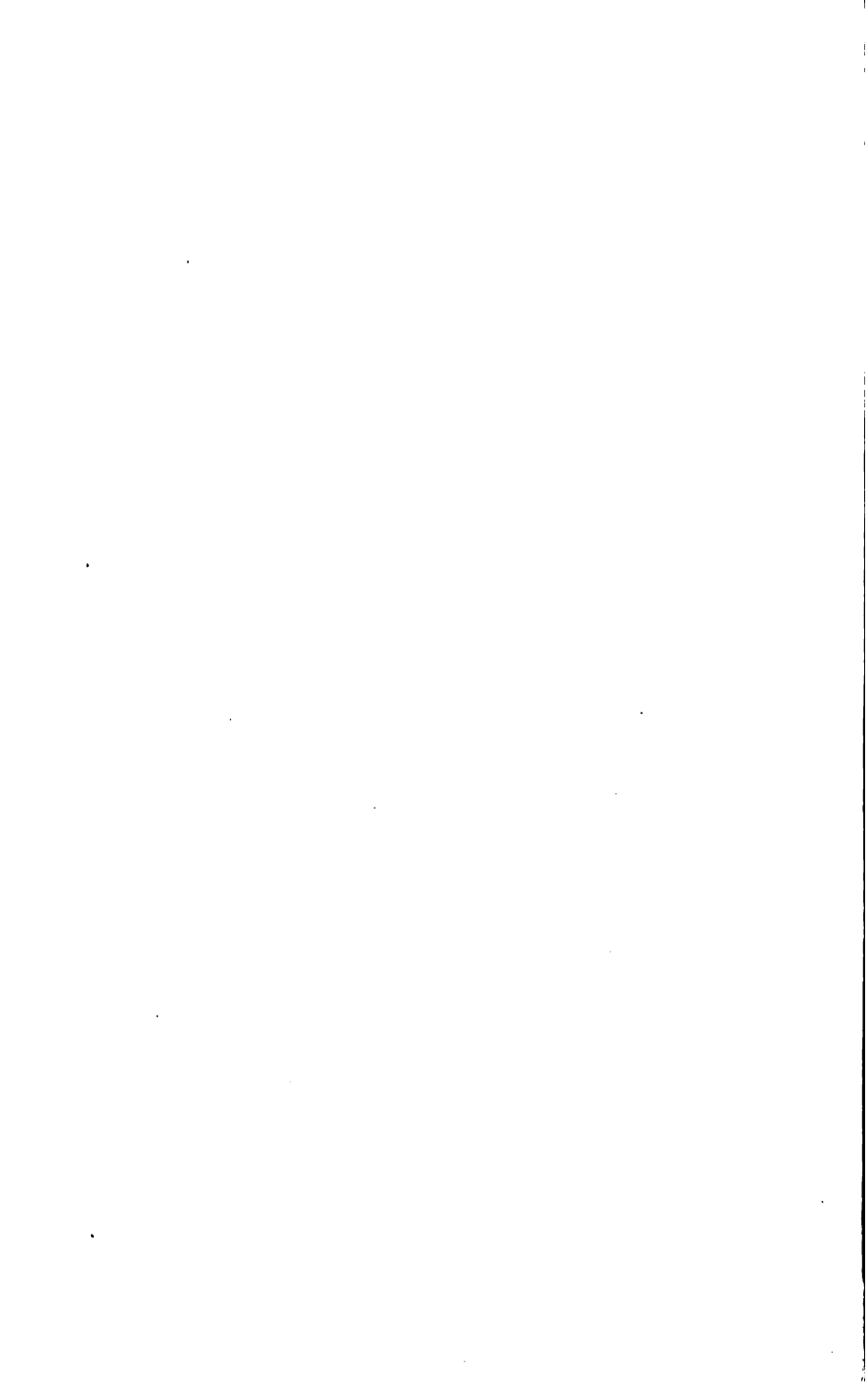

Not in RA
1/6-25
91

Pattern-Making

BY

G. H. WILLARD

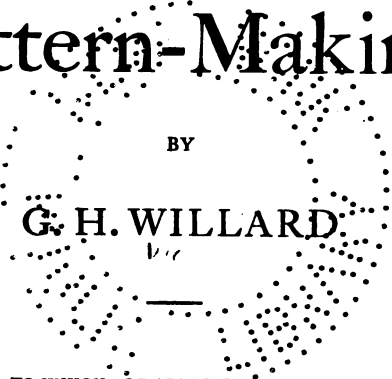

TO WHICH ARE ADDED CHAPTERS ON

Core-Making and Molding

With 312 Illustrations

PRICE, ONE DOLLAR

CHICAGO: POPULAR MECHANICS
COMPANY, PUBLISHERS.

cmw

1

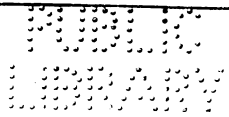

TO NEW YORK
PUBLIC LIBRARY
220521A
ASTOR, LENOX AND
TILDEN FOUNDATIONS
R 1925 L

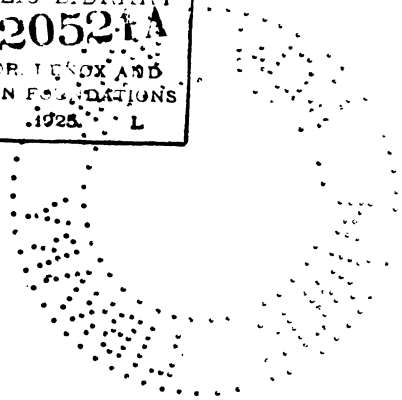

Copyright 1910
by
H. H. WINDSOR

ROY WEN
OLDF
WAGELL

~~79054~~

671
WS

CONTENTS

Chapter I.

Pattern-making One of the Foremost Mechanical Trades.
Education of the Pattern-maker. Drawing. Practical
Experience. Foundry Work. Table Showing Shrink-
age of Metals. Finishing or Varnishing..... 13

Chapter II.

Tools Required. Chisels and Gouges. Planes. Braces
and Bits. Proper Angle for Drills. Saws. Slickers.
Gauges. Wood Rasps. Miscellaneous Tools. Select-
ing a Kit. How to Make a Tool-box. Marking Tools. 19

Chapter III.

Woods Adapted for Pattern-making. Rules for Selection.
Quarter-Sawing and Flat-Sawing. Judging Lumber.
Gluing. How to Avoid Warping..... 29

Chapter IV.

The Various Forms of Joints. Square, V, Tongue and
End-half Lap Joints. Tongue and Groove, Miter, etc.
The Dovetail. Jointing an Important Factor..... 36

PATTERN-MAKING

Chapter V.

- Turning. Lathes Adapted for Pattern-making. Speed Lathes and How to Use Them. Turning Split Patterns. Fastening Bosses on Patterns. Proper Angle of Cutting Edges. The Skew Chisel..... 43

Chapter VI.

- Turning (continued). Tools and other Appliances Used in Hand Turning. Various Forms of Chucks. 51

Chapter VII.

- Turning (continued). Wooden Face Plates. Forms of Construction for Large Work. Device for Holding Rings. 58

Chapter VIII.

- Turning (concluded). Machine Turning. Work on Large Lathes. Methods and Tools. Keeping Machine Tools in Shape..... 66

Chapter IX.

- The Circular Saw. Rip, Cut-off and Combination Saws. Filing. Special Devices. Making Lags. Saw "Tricks." 73

Chapter X.

- The Circular Saw (concluded). A Dangerous Tool. Making Cylinder Barrels or Pipe. The Rotary Protractor. Concaving the Lag..... 80

CONTENTS

Chapter XI.

Machine Tools. The Scroll or Jig Saw. The Band Saw. The Buzz or Hand Jointer-Plane. Safeguards in the Use of Woodworking Machinery. 88

Chapter XII.

Machine Tools (continued). The Surface or Cylinder Planer. The Boring-Machine. Routing. Making Corners. The Universal Trimmer. 94

Chapter XIII.

Simple Patterns. Methods of Construction and Manner of Use in Molding. Practical Considerations for the Pattern-maker. Drawings and Sketches. Making a Pattern from a Broken Casting. Working from Drawings. Calculating the Finish. Split Patterns. Making a Bushing—from the Pattern to the Casting. . . 100

Chapter XIV.

Simple Patterns (continued). Much Experience Gained from Apparently Simple Things. The Balanced Core. Making the Core Box. 111

Chapter XV.

Simple Patterns (concluded). The Heel Core. Best Methods and Most Suitable Materials. Cutting the Corners. Fillets 118

PATTERN-MAKING

Chapter XVI.

Crooked Patterns. Great Care Required. How to Prevent Warping. How the Grain of the Wood Should Run. Methods of Joining. Samples of Work Illustrated. Simpler Methods of Curved Work.....126

Chapter XVII.

Large Pattern Work. Difference in Methods for Large and for Small Work. A Practical Comparison Exemplified133

Chapter XVIII.

Large Pattern Work (concluded). Process of Making a Piston Pattern for a Large Cylinder. Various Methods Illustrated. The Stronger Construction.....141

Chapter XIX.

Crosshead Guide Patterns. Various Ways of Making the Joints. Stiffening and Strengthening. Preparing the Pattern for the Lathe. Method of Strengthening the Heads149

Chapter XX.

Sweep Work. How the Pattern of a Hollow-Arm Fly-wheel is Made. Molding the Wheel.....156

Chapter XXI.

Pipe Work. Pipe Fittings Wanted Quickly. Half Circles and Bends. Odd-Shaped Pipes. Cheap Patterns where Few Castings are Required.....163

CONTENTS

Chapter XXII.

- Stove Patterns. Different from Ordinary Pattern Work.
Uniform Thickness Essential. Metal Patterns. "Rat-
tails." Process of Making a Stove-Cover Pattern.
Making a Furnace-door Lining171

Chapter XXIII.

- Molding-Machine Work. The Molding-Press or
"Squeezer." Power Machines for Large and Small
Castings. Both Hardwood and Metal Patterns Used.
Methods of Making the Patterns. Close Measurement
Required179

Chapter XXIV.

- Molding Pattern Work. Troubles in Molding. Stool
and Stripping-Plate Work. An Interesting Branch
of Pattern-making.187

PATTERN-MAKING

II.—CORE-MAKING AND MOLDING

Chapter I.

Core-making, Simple and Complex. Making, Baking and Setting Cores. Their Purpose. Green and Dry Sand. Providing for the Escape of Gas. Supports and Vents. Knowledge Indispensable to the Pattern-maker....195

Chapter II.

Principles in Molding Which Govern the Making of Patterns. Shrinkage. Draft. Determining the Position and Location of Cores. The Placing of Loose Pieces on Patterns. Split and Solid Patterns.....199

Chapter III.

Loam Patterns and Loam Molds. Recipe for Loam Mixture. Loam Patterns Cheaper and More Quickly Made than Those of Wood. Limited in a General Way to Cylindrical Forms. Processes and Methods for Making Loam Patterns.....203

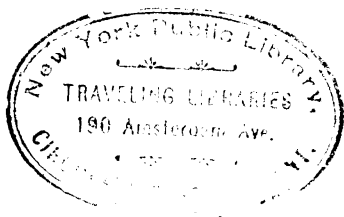

PATTERN-MAKING

PLATE I

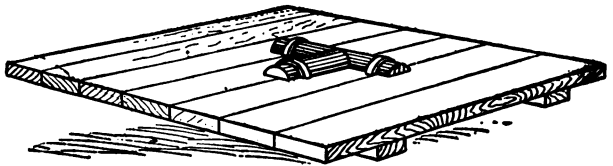

FIG. 1

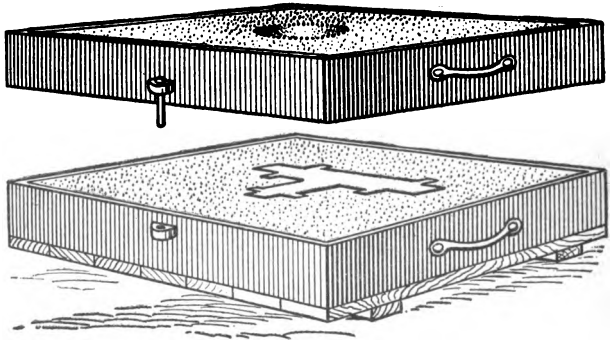

FIG. 2

PATTERN-MAKING

CHAPTER I

PATTERN-MAKING AS A TRADE

UP TO the year 1840, when the division of labor into trades began, little was known of pattern-making as a distinct craft in this country. A person working at pattern-making at the present time should have a good knowledge of drafting, foundry work, the machinist's craft, and of woodworking tools in general, and, also, a good training in mathematics.

Pattern-making to-day is considered one of the foremost of all the skilled mechanical trades. The pattern-maker must be able to read a drawing and also to picture in his mind what the finished casting will look like when the machinist has completed his work on it; he must also have knowledge as to how the casting is to be removed from the molding sand in the foundry, where it should be parted in the flask, and when the cores are needed, the shape and size of the cores, and how to construct the pattern so it will

preserve its form and be durable. Some patterns do not require to be made as perfectly as others, as only one casting may be required. In a case of this kind the pattern-maker adopts the quickest and cheapest construction possible.

The making of all tools and devices in cast metals necessitates the previous making of a pattern. At the present time not only cast metals require a pattern; but frequently stone, brick, mortar, cement, plaster of Paris, rubber, glass, paper—in fact, almost everything that is made in odd shapes requires a pattern. Some men working at the foundry trade are so well trained at their occupation that they can make some pieces without the aid of a pattern, but such men are few.

Some large concerns start their apprentice boys in the factory and pass them on to the drawing-room, enabling them to obtain an accurate and practical knowledge of drawing, which is quite as essential as the knowledge of pattern-making. Some pattern-makers spend nearly as much time trying to picture in their minds how the casting should look when taken out of the sand as they do in working at the pattern, while if they had a good knowledge of drawing much of this time would be saved.

From the drawing-room the apprentice goes to the foundry, where he obtains a good idea of

the best and easiest way to mold a pattern. The pattern-maker's education, then, comes from an experience in the drawing-room and the shops most closely related to the pattern shop, as well as through an experience in the pattern shop itself.

A mold is made in the foundry as follows: A pattern is first made, sometimes with two or three pieces nicely fitted together. If made in halves, one half is placed on a flat board called the turn-over board (Fig. 1), and fine, dry sand is sprinkled over it. A frame or box without a bottom or top and of the right size for the pattern (this frame is called the nowel or drag) is inverted on this board. The nowel is filled to the top with molding-sand well tamped, and another board is placed on top of this and rubbed gently so as to make an even, compact surface on the sand. The flask (as the entire box is called) and board are turned over, and what was the bottom becomes the top (Fig. 2). The turn-over board is now removed, the superfluous sand cut away, and a "parting" around the pattern made by sprinkling burned sand, or that which has been often used, over the surface. Then the other half of the pattern and of the flask, called the cope, is placed on top of the first half, or nowel, and the process is repeated. These flasks have pins attached to them so that they can be

detached and replaced in the same relative position as at first. This upper half, or cope, is lifted off after it is tamped with sand, and the pattern is carefully picked up by the aid of draw spikes or lifting plates, leaving an impression in the sand the same shape and size as the pattern. A small opening called a sprue is made through the cope sand to allow for the pouring of the melted metal into the mold.

When the metal is cooled it shrinks, and on this account metals and other materials that are poured into a mold to harden are given an allowance for shrinkage. Thus, if a sketch is made for a pattern for an iron casting which when taken out of the sand shall be the size of the figures on the sketch, say 12 in. long by 1 in. square, the pattern, if made by common rule, would produce a casting 1-8 in. shorter than the pattern, because cast iron shrinks 1-8 in. in 12 in. Shrink rules are graduated according to the shrinkage of different materials. Different shrinks are allowed for iron in different shops, according to the mixture of the metal, but a shrinkage of 1-8 in. per foot is ordinary. A pattern-maker when he starts in a new shop is given the "shrink rule" to be used.

Below is a table of the different cast metals and the shrinkages most commonly used:

SHRINKAGE OF METALS

Cast Iron.—Irregular shapes with cores or small castings, $\frac{1}{8}$ in. in 12 in., per linear foot in every direction. For large, thick and solid casting 1-16 in. in 12 in. is allowed.

Brass, 3-16 in. in 12 in.

Zinc, 5-16 in. in 12 in.

Lead, 5-16 in. to $\frac{1}{4}$ in. in 12 in.

Copper, 7-32 in. in 12 in.

Tin, 9-32 in. in 12 in.

Silver, $\frac{1}{8}$ in. in 12 in.

Steel—Long, $\frac{3}{8}$ in. in 12 in. Medium, 3-16 in. in 12 in.

Aluminum, $\frac{1}{4}$ in. in 12 in.

A very important factor in pattern-making is the finishing or varnishing. Many otherwise well-made patterns are spoiled by improper varnishing or shellacing. In most large shops there is a man or boy who does nothing but varnish and sandpaper and place wax, putty, leather or wooden corners, or fillets, in the corners of patterns. The present-day competition in business is so keen that every hour of the skilled workman counts, and he is kept close to his own particular work, while a boy or apprentice does the varnishing and helping under his direction. The varnishing is done not so much for appearance as to waterproof and preserve the pattern from the dampness of the sand while in the flask, and to secure a smooth finish on the surface of the pattern to permit its being drawn

from the sand easily and to secure a smooth surface on the casting. Coloring-matter is added to the varnish as a guide to the molder, though there are no set rules in this regard. Care should be used not to get too much coloring. Mix it so that the color will show up well, but do not have it thick and muddy.

It will be found a great convenience for the foundry and the pattern store-room to varnish wood patterns to be used for cast-iron work black, with orange core-prints; steel patterns red with orange prints; brass patterns orange with black prints; aluminum patterns green with orange prints. Where there are loose pieces on a pattern the surfaces that come together should be of another color than the patterns or prints. If a pattern for cast iron is black with orange prints, for example, the loose pieces may be red, which shows that there is a loose piece and where it goes. This takes time, but may save a great many dollars. It is becoming quite general, however, to finish all parts of a pattern except the core prints with orange shellac regardless of the kind of metal used in casting. This is done because it is semi-transparent and permits of an inspection of pattern construction. In this case the prints are usually finished black. After the first coat of varnish has well hardened, sand-paper smooth before applying the second.

CHAPTER II

TOOLS

IT is not easy to enumerate and describe all the tools that are used in pattern-making. There is perhaps, no trade where so great a variety of tools is required, and every shop has its particular tools and methods of work. It is not always the best workman that has the most tools. Some tools especially useful for apprentices and those going into pattern work may be mentioned.

Chisels and gouges (Fig. 3) are among the first tools that are required in making up the kit. Bent shanks will enable work to be done on longer places, and by using these one will not mar the wood or injure the hand. Gouges come in three different "sweeps"—regular, middle and flat. It is not necessary to buy a complete set of each sweep at first; $\frac{1}{4}$ -in., $\frac{1}{2}$ -in., $\frac{3}{4}$ -in. and 1-in. of each sweep will be sufficient to begin with. These are to be ground on the inside and are used for paring. There are spoon gouges of several sizes and sweeps that are very useful.

A variety of planes (Fig. 4) are called for and they must be good ones. A 22-in. jointer plane with $2\frac{3}{8}$ -in. blade that can be raised and

lowered and also has a lever to throw the cutter sideways so as to obtain an even thickness of chip; a smoothing plane, a block plane and a circular plane are needed. The latter is very useful on large concave or convex surfaces; the sole is flexible and can be adjusted to most any arc either concave or convex. A rabbet plane is another very handy tool, and it will plane where the ordinary plane can not. The router is a very necessary tool and is sometimes called a plane; it is used for making a lower surface parallel with an upper one, such as a groove in which are set rapping plates that are to be flush with the surface of the pattern. It can also be used in a number of other places to advantage. A core-box plane is very useful, and is used to plane half-round core boxes. These planes can be obtained in most hardware stores, or one can be made out of a wood rabbet plane by fitting on wings at right angles. Fig. 5 and Fig. 6 will give a good idea of the principles and how used. The dotted lines show the box when planed out.

A ratchet bit brace (Fig. 7) with a set of auger bits (Fig. 8) is another very useful tool. In the set of bits should be included a few centerless bits (Fig. 9) of different sizes. These bits have no spur, but enter the wood by the rim of the bit forming a circle in the wood as pressure is exerted upon the brace. With these bits a hole

PATTERN-MAKING

PLATE II

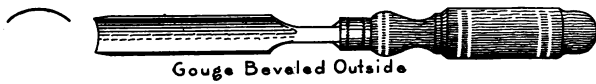
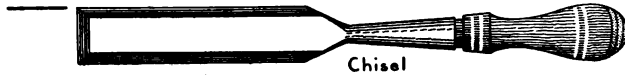

FIG. 3

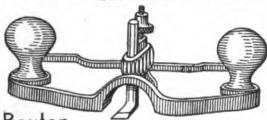
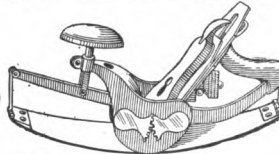
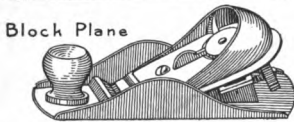
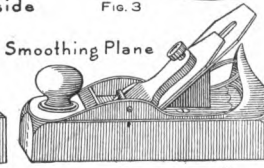
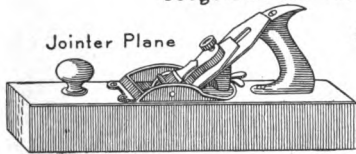
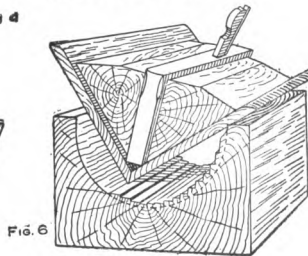
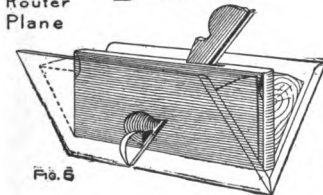

FIG. 4





can be bored at any angle any way of the grain, and they make a good smooth, flat-bottomed hole.

A spoke shave (Fig. 10) must be added to the list, also a breast drill with small drills (Fig. 11). If the angle on the lips of the drills is ground to 90 degrees they will work better in wood than if used as they ordinarily are for metal. A countersink for screwheads, screwdrivers and plug-cutters are very handy for the bit brace.

Hand saws are of course necessary, and, like the planes, should be A-1. There are the cross-cut, back and compass saws. The cross-cut is used mostly for cutting off boards that are not easy to cut on the band or circular saws. A turning saw is a very handy tool in a pattern-maker's kit where one does not have easy access to a power jig or band saw. The rip saw is used with the grain, and the back saw is used either with or across the grain for fine work.

Wax and putty slickers for forming fillets will be needed. A very nice slicker is made out of a round ball with a straight shank attached. Obtain different sizes to fit the different radii of corners desired. A very convenient slicker may be made from 5/16-in. rod iron by filing and polishing the end similar in shape to the small end of an egg.

Marking gauges, one small and one large

(Fig. 12), and a surface gauge (Fig. 13), which is very handy on curved or uneven surfaces where the marking gauge cannot be used, should be purchased. By holding crooked patterns on a flat surface one can locate centers for bosses easily and obtain correct heights with a surface gauge. A knife made from an old broken hack saw makes a good one that keeps its edge well, as the steel is of good quality. Another knife that is very useful has the blade sharpened on both edges, with the point bent like a hook (Fig. 14). This is handy for cutting out corners in spokes of pulleys and where a straight-blade knife can not be easily used.

An oilstone and slip stone must not be forgotten. There should also be a bevel protractor with a 12-in. blade (Fig. 15). Have the center attachment so as to find the center on the end of a round piece. And three sizes of try-squares with adjustable blades, 2-in., 6-in. and 12-in. (Fig. 16). A 24-in. carpenter's steel square (Fig. 17) is often needed, as are also small and large bevel squares. A medium size draw-knife (Fig. 18), and beam compasses or trammels (Fig. 19), which can be obtained in almost any hardware store, are necessary. A large and small pair of dividers (Fig. 20), say 3-in. and 6-in.; the 6-in. size with a removable point so a lead pencil can be used for one point. At least

PATTERN-MAKING

PLATE III



Fig. 9

Ratchet Bit Brace

Fig. 7

Drill

Fig. 11

Spoke Shave

Fig. 10

Marking Gauge

Fig. 12

Knife made from Hack Saw

Fig. 14

Carpenter's Square

Fig. 17

Bevel Protractor

Fig. 15

Try Square

Fig. 16

Calipers

Fig. 21

Dividers

Fig. 20

Surface Gauge

Fig. 13

Beam Compass

Fig. 19

Draw Knife

Fig. 18



three sizes of calipers (Fig. 21), small, medium and large, about 3-in., 8-in. and 16 or 20-in., and pattern-maker's rounding tools in different sizes.

In ordinary joinery there is very little use made of files, but in a pattern-making shop they are indispensable. They are called wood rasps and are manufactured especially for woodworking. A half dozen of these of different sizes, shapes and cuts should be in every pattern-maker's kit. Wood-scrapers are often used after the file on patterns made of hard wood, and one or two of these should be purchased.

Turning tools are also very necessary: a gouge, diamond-point cutting-off tool, right and left-hand side tools, round nose of large and small radius, and a narrow and wide flat like a chisel. A hammer, a mallet and an ordinary screw-driver will complete the kit.

This does not include all the tools used in the trade, but is a good starter, and as one advances in the work others will suggest themselves, and the chest will fill as time goes on.

A good tool box, and one that does not cost much to move from place to place, is made out of a small trunk. A steamer trunk, which is long and flat, is very serviceable. Then make a case of drawers with a shallow one at the top and running down, say five or six in all, with each tool set into a form on the bottom of the drawer

so that they will not move around, and every time a tool is returned to the chest it will go in the same place. Have a place for everything, and put every tool back in its place. Have the case with drawers fit snugly into the trunk. By this arrangement the tools are handy and ready to move at short notice if required.

One thing more: Put a private mark, say your initials, or a number, on all your tools, and then there will be less likelihood of their getting misplaced or lost.

A word should be said about keeping tools in condition. It is not unusual for an experienced mechanic to comment on the habit of a beginner to keep his tools poorly sharpened. The beginner seems to feel that sharpening tools is a waste of time. This is not true. One can do better work and more of it by keeping tools well sharpened.

CHAPTER III

WOODS

PATTERN-MAKERS use several kinds of wood, pine, mahogany, baywood, cherry, Washington fir, beech, maple and whitewood being the principal ones. Each wood has some particular advantage over the others for the purpose for which it is used.

For general pattern work white pine leads them all in the opinion of American pattern-makers. It is soft, easy to work into shape with edged tools, is light, and does not have that tendency to curl and twist that some other woods have. Whitewood and fir are being substituted for pine, however, because of the scarcity and price of pine. Lignum-vitae, black walnut, etc., are very hard on edge tools, and are used only for patterns which are to be used over and over again. The grain on pine ordinarily runs straight. It is not brittle nor easy to sliver up as in the case of some soft woods like redwood or California cedar. When picking out lumber in the yard or at the lumber racks in the shop, always get a dry and straight-grained board. A soft, dry board that is very light and shows no signs of pitch is a good board to pick out. If it is not dry and well seasoned it will cause no end

of trouble, because it will shrink, check or crack. "Season-dried stock" seems to work better and has more "life" in the board than ordinary yard stock. Wide boards are apt to be the best, and the expert can tell after a little experience by rapping a board whether it is good or not. A knot or two does not do much harm, and all pattern-makers say that a few wormholes indicate good wood.

It may be noticed in a lumber yard that the ends of boards and planks are sometimes painted. This is mostly on cheap stock. Fine lumber seasoned and dried well does not have the ends painted. In a good sound plank deposits of sap are formed around the pores, showing that as the stock dries the sap discharges through these pores, but if they are filled with paint the sap can not flow through and the result will be dry rot. A board with pitch in it is heavier and darker in color than one without pitch. This kind of stock works well in the lathe and turns smoother, but cannot be depended upon to keep its size and shape. Always obtain dry lumber for patterns of all kinds. It can be depended upon, and much trouble will be saved by using it.

Mahogany is much used for small patterns where there are a great many castings wanted, also for crooked work, as it keeps its shape better

PATTERN-MAKING

PLATE IV

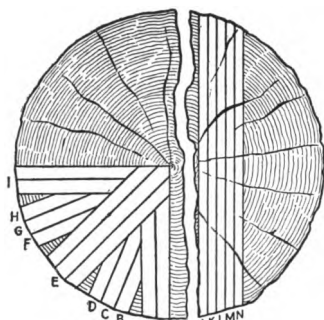

Fig. 22

Fig. 23



Fig. 24



Fig. 25



Fig. 26

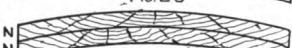

Fig. 27

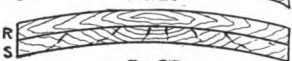

Fig. 28

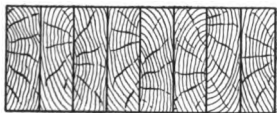

Fig. 29

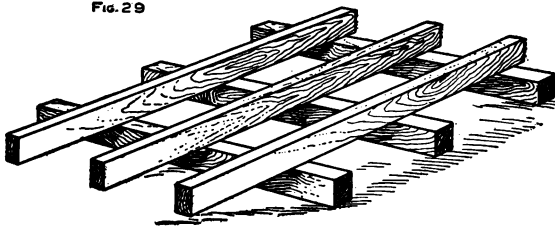

Fig. 30

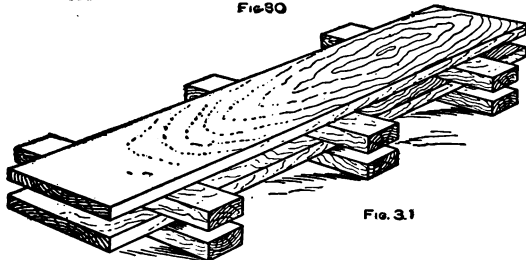

Fig. 31



than almost any other hard wood. It is also used for trimmings or exposed parts where the pattern is in constant use. Cherry is also used for the same purpose, but it is harder than pine and not so good for keeping its shape. Baywood is substituted for mahogany, and it is often quite hard to tell the difference between the two. It is, in fact, a variety of mahogany. The other hard woods are mostly used for trimmings and parts of the pattern where the foundryman uses his vent rod or piercer.

There is one thing few pattern-makers seem to understand, and that is about the grain of the lumber, a matter of no little importance. You can purchase in the market flat and quarter-sawed lumber. Quarter-sawed lumber may not only be obtained in hard woods, but also in soft woods such as pine. There are not a great many boards quarter-sawed out of one log, as it would cost more to saw, and too much of the log would be wasted. A quarter-sawed board is one cut radially, as shown in Fig. 22 from *A* to *I*. The letters *B, C, D, E, F, G, H* show how the boards are cut in this quarter to make them what is called quarter-sawed stock, and it may easily be seen why quarter-sawed lumber costs more than any other.

Lumber generally comes sawed as in Fig. 23, *J, K, L, M, N*, where the whole log is sawed up

into boards. The best boards are nearest the heart of the tree. There are a few boards that are very nearly quarter-sawed through the center, as *A*, and each side of the center of the logs in flat-sawed lumber. A board like Fig. 24, with the grain as shown, from the log at *N*, will not stay straight long and will curl away from the center or heart of the tree as shown.

If two boards are to be glued together, glue them as shown in Fig. 25, with the grain as shown in *N*, the reason being that they warp away from the heart of the tree and one piece counteracts the other. If they are glued with the sides nearest the heart of the tree coming together, the result will be as shown in Fig. 26. If the grain is the same way on both pieces, as in Fig. 27, they would both warp together as shown. If one piece is glued crosswise of the other, the result will be as shown in Fig. 28. The warping power of *S* is strong enough to bend piece *R*. It is not good policy to glue boards crosswise unless the stock is absolutely dry and glued in four or more thicknesses. The reason for this is that each board will shrink and swell in width, not much in length, and the result will be, in stock glued up with alternate boards having grains running at right angles, that the glued up block will soon be torn apart. There may be occasion to glue several pieces together

as shown in Fig. 29. When gluing see that the grain of each piece matches the piece next to it as shown.

On large work the stock is often got out ahead and sawed into lengths and widths, such as lags or staves for a cylinder or any job where a quantity of lumber is used. The pieces are stacked as shown in Fig. 30, which allows the air to circulate all around the stock, and after being thus dried, it will keep its shape when put into a pattern. Do not lay one board flat on top of the other, but have strips between them as shown in Fig. 31. This allows a circulation of air all around each board and helps to keep the boards straight. It is customary, in gluing up stock for turned work, such as wheel or pulley rims, to build each layer in V's like pie pieces. When the layers are glued together, successive layers are so placed that pie-piece joints in any pair of layers will not come together.

CHAPTER IV

JOINTS

SEVERAL different kinds of joints are used in pattern-making. The jointing of patterns is a very important factor, and often where one joint on a pattern would be most suitable another kind of a joint would be of no use. In making a pattern the object is to make it so that it will keep its shape and size, and in order to do this the pattern-maker has to use much care and judgment. A great help in pattern-making is to know what kind of a joint will hold best for the particular pattern in hand.

Fig. 32 shows a square or butt joint. This is used only where there are layers of stock built up and where the wood of one layer will cover the joint of the next succeeding layer. As was stated in a previous chapter, such a joint is used in building up the segments for a pulley or gear.

Fig. 33 is also a square joint, but when the two pieces are closed together a hole is bored and a wooden dowel or plug glued in. This has no great strength lengthwise, but the two pieces are held from slipping out of place sideways.

Fig. 34 is a V joint. When glued it is much stronger and more durable than either of the square joints.

PATTERN-MAKING

PLATE V

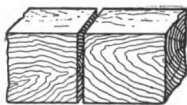

Fig. 32

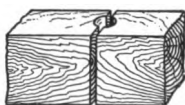

Fig. 33

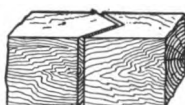

Fig. 34

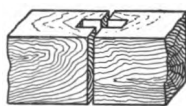

Fig. 35

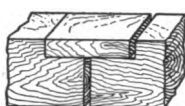

Fig. 36

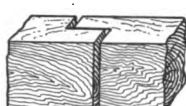

Fig. 37

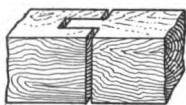

Fig. 38

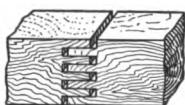

Fig. 39



Fig. 40

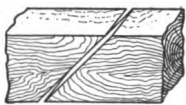

Fig. 41



Fig. 42

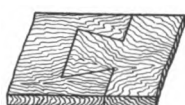

Fig. 43

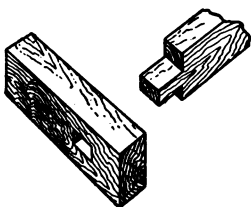

Fig. 44

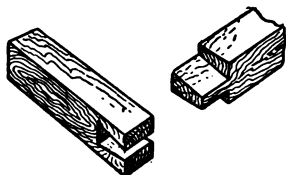

Fig. 45



Fig. 35 is a tongue joint, one of the most commonly used joints in pattern work. It is easy to make and very strong when well glued. It is used on webs of pulleys and gears that do not have arms. The groove is made with the circular saw by setting the saw above the table height and shifting it to the width required for the tongue which fits into the groove. The tongue is forced into the groove in glue to form a perfectly tight joint.

Fig. 36 is still another joint, seldom used, but occasionally adopted where there are ribs high up on a pattern. This joint holds the pieces together and keeps them from moving sideways.

Fig. 37 is an end-half lap joint and is generally used on long pattern work where single strips are fastened together end to end. It can be made with the circular saw when the pieces are not too long. When joints are glued and dry the pattern-maker sometimes puts a wood screw through the joint, which makes a very strong construction.

Fig. 38 is what is called a tongue-and-groove joint. It is strong, durable and easy to make. Care should be taken to make the tongue fit tightly. This joint is very often used to make the corners of square frames or any square-cornered construction. It is also very useful on crooked work.

Fig. 39 is a tongue-and-groove joint similar to Fig. 38, with several tongues. There is a special device made for sawing the grooves, as will be shown later. This is one of the best joints used for pattern work where there are a large number of castings wanted from the pattern, as it is strong, and, when well glued, makes a joint nearly as good as a solid piece of wood. It is used to great advantage on crooked work of any thickness or width.

Fig. 40 shows a joint where several thicknesses of stock are glued one over the other, such as segments for pulleys and gears, etc. Much care should be taken in making all the layers of stock of exactly the same thickness. If this is not done, there will be open places where one piece overlaps the other, allowing play to the pieces and consequent weakness.

Fig. 41 is a scarfed joint. It is stronger than Fig. 32 and does very well for patterns where there are not many castings wanted. It is well to nail or screw this joint. The damp molding sand will open up the joint if the pattern is in the sand a great while.

Fig. 42 is used for thin work. It secures the pieces so they can not pull apart and locks them in good shape. Make the small piece first, lay it on top of the two pieces when placed end to end and mark around it with a scratch awl. Then

cut a hole through the two pieces to the marks. After this has been done the small piece will drop in and fit all around. Much care should be exercised in making this a good joint, as the thin stock is dependent upon the joint for strength. Where pieces are placed end to end the grain in the small piece should run with the grain of the pieces joined.

Fig. 43 is similar to Fig. 42, except that it has no center keys. It is used frequently for fastening core prints to patterns, also for fastening on loose pieces, for both thick and thin work.

Fig. 44 is an open mortise-and-tenon joint. This is used where there is a piece that projects out a distance from the end or the center of a piece, forming a T in shape. This must be strong to keep its shape and place. An easy way to make this is to bore a hole or two in the piece where the mortise comes and then chisel it out, cutting the tenon on the circular saw to fit this chiseled-out hole.

Fig. 45 is a single-tongued dovetail joint and is considered one of the strongest joints made. It may be made in several tongues as well as one. These joints are used in fine work and patterns that require long service in the foundry. Tool chests or boxes that require strength have the corners made with this joint. There are several of these joints that can be used for the same pur-

pose in a pattern, but the shape and size are to be considered for each case as it arises.

Many of the joints described in this chapter will be used very little by an apprentice. Those in most common use are illustrated in Figs. 32, 35, 37, 39, 40, 42, 43 and 44. The dovetail joint shown in Fig. 45 is used in framing and cabinet work more than in pattern-making.

CHAPTER V

TURNING

IN pattern-making much turning is required, and of different shapes and sizes. Lathes are made for pattern-making with a movable carriage, compound rest, swiveling headstock, and set over tail stock and with a feed arrangement for the carriage. For the general run of pattern work the speed lathe is most commonly used, and with it a large variety of work can be done. The turning is done with what are called hand turning tools, mentioned in Chapter II.

Fig. 46 shows a speed lathe. *A* is the headstock, which is fastened to the bed, *B*, and should be strong and substantially set to avoid the shaking which is caused by the high speed at which it is driven. There are generally four speeds, as shown by cone *C*, Fig. 46. The highest speed is obtained when the driving-belt is on the smallest diameter on the cone, and it gradually diminishes as the belt is shifted to the larger steps on the cone. A large piece of work in the lathe should not run as fast as a small piece, but it should be run as fast as it can and be safe, for, the faster the work turns, the better and smoother will be the turning. Inexperienced pattern-mak-

ers speed up their large work too fast, and the result is that the work flies out of the lathe and is likely to be broken, or perhaps the workman is injured. Speed lathes run between 1,200 and 2,400 revolutions per minute, depending upon the step on which the belt is placed. The 1,200 speed should be used for very large and irregular-shaped stock. The 2,400 speed should be used only after a piece is turned to a cylinder, and then usually for small diameters only. *D* is a movable post for holding the hand-tool rest *E*. This post can be adjusted to any angle with the ways of the lathe and can be placed on the lathe bed to suit the job. *F* is the tailstock and can be adjusted on the bed to suit any length of work. *G* is a small screw to hold the spindle in place after being turned up with the hand wheel *H*. The work is sometimes too large in diameter to turn on the inside end of the headstock and is then turned on the outside end, which is sometimes provided with a large face plate, *I*, which has a left-hand thread so it will not come off while turning.

Fig. 47 shows a floor stand for holding the tool rest, *A*, for turning on this outside end. It has feet, as shown, and rests on the floor. The tool rest can be adjusted to the required height and angle. To turn a solid piece of wood a fork center (*J*, Fig. 46), is used. It is wedge-shaped on the

PATTERN-MAKING

PLATE VI

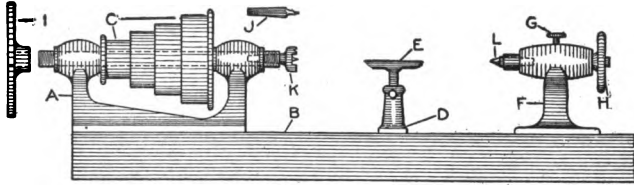

Fig. 46

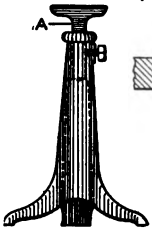

Fig. 47

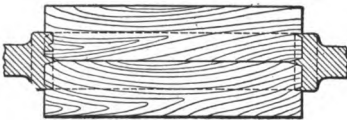

Fig. 50

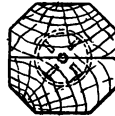

Fig. 51



Fig. 55

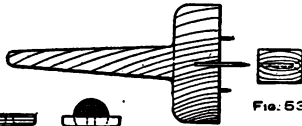

Fig. 52

Fig. 53

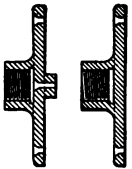

Fig. 56

Fig. 57

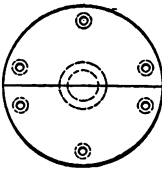

Fig. 58



Fig. 48



Fig. 49

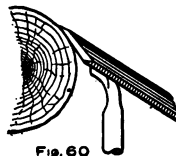
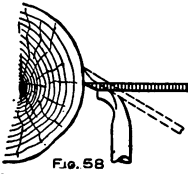

Fig. 60



Fig. 59



Fig. 54



end, with a center point similar to a common center. The two forked wedges *K* hold the piece securely. Often the work has to be taken out of the lathe and put back again, and unless it is replaced in the same position it first occupied it will not run true. To locate it when putting it between centers the second time there is a cut in one of the lips, as shown at the center of *K*, Fig. 46. On the tailstock there is an ordinary center as shown at *L*. These centers can be taken out and replaced by other designs as the job requires. A very common tail center is known as a cup center (Fig. 49), which is similar to *L* except that it has a rim outside of the center-point.

The split pattern is one that is made in halves. For doing this kind of work there are centers made as shown in Fig. 48, which hold the two pieces of wood together while turning. Fig. 48 is for the headstock and has lips inside of the outer circle as shown, and is used for the same purpose as *J*, Fig. 46. The ring on the outside has a knife edge; it is driven into the ends of the two pieces and holds them where they were when the center was sunk into them. Much care should be taken in having the joint lines of the two pieces close together, and also to have the point of this center on the joint of the two halves, as shown in Fig. 50. The tailstock

center, or cup center, is the same as Fig. 49, only there are no lips. This should be kept well oiled so as not to burn and spoil the center. In locating the headstock center the lips should come as shown in Fig. 51, two of them coming in each half. There are other ways of holding two pieces together while turning, as will be shown later. It is often necessary to fasten thin bosses on patterns. For this kind of work a chuck, Fig. 52, is used. Take a piece of hard wood and turn a taper on the end to fit the taper in the spindle or shaft of the headstock; turn up the other end as shown, $2\frac{1}{2}$ or 3 in. in diameter; locate a pin made out of a small wire nail in the center, also three or four other small nails, with the points sharpened. To turn the boss, drill a hole in the center the same size as the pin in the chuck, slide the piece on this pin and drive it into sharp pins on the chuck to keep it from turning around while turning it up. A small piece with a hole through the center (Fig. 53), is set on the tailstock, and holds the boss up solid on the chuck. This makes a very handy and cheap device for turning these bosses.

Sometimes it is required to turn up a piece as shown in Fig. 54. After the piece is turned round it is difficult to cut away the stock as shown and have it come to the center line; so there is a center made, as shown in Fig. 55. The

block is cut to size when in the square shape and screwed onto this half holder as shown. Small, short split pieces can be turned on this half holder. The end of the block must be longer than the end of the center with which it connects, *A*.

The ordinary center-screw face plate is made as shown in Fig. 56. Sometimes the boss is not made a part of the face plate, as shown. A wood screw is put through the face plate from the headstock side and screwed into the piece to be turned. This plate is commonly used for small pieces which will not turn or twist easily on the center screw. If the form with a boss is used, as shown in Fig. 56, a hole corresponding in size to the boss must be bored in the face of the wood which comes next to the face plate. The principal advantage of the boss is to prevent the piece from sliding. In other words, the boss keeps the stock perfectly centered.

When there are two pieces wanted that are both alike, such as in core boxes where there is a whole box or both ends are the same, these are turned on a face plate as in Fig. 57. A center line is scratched very accurately on the face, as shown; the joint line of the piece to be turned is placed on this line and screwed fast; it is then ready to turn. One half may be removed to see that it is all right. If not, it can be put back

again and turned as wanted without in any way disturbing it from the center. This face plate is also used for large pieces which would twist on the center-screw face plate.

Fig. 58 shows different angles for turning a plain round piece. Some prefer to hold the chisel on an angle as shown by the dotted lines, but the workman must be careful, as it is more liable to rip into the work. It is true that it cuts and does not act so much like a scraper as does the full-line chisel, but if the lathe speed is fast the tool will cut very well and there will be less danger of its catching and being thrown back against the operator. As a rule the tool is held for face plate work as shown in the full-line part of Fig. 58. For spindle turning, however, the tool should be held as in the dotted line illustration, and, if possible, the lower ground surface of the tool's cutting edge should rest flatly on the revolving stock. It should be tangent to this revolving surface.

Fig. 59 is what is called a cutting tool, or a skew chisel, because its cutting edge is ground at an angle to the center line and is beveled on both sides to a very keen edge. It is used as shown in Fig. 60. It will be hard at first to cut with it satisfactorily, but with practice it can be mastered and makes a good, safe tool. The principle of tangency spoken of above should be kept in mind at all times.

CHAPTER VI

TURNING

THE tools and appliances used in turning are many, and they all have a particular value for certain kinds of work. The use of some tools and parts of the lathe was illustrated and explained in Chapter V, but there are still others to be described.

Fig. 61 is a driving chuck similar to Fig. 56 and 57, Chapter V, only this has the screw, *A*, fastened on the chuck. The thread is very coarse, and before screwing on the piece of wood to be turned a small hole should be bored in it so that the pressure of the screw in the wood will not split it. Hard wood will split much easier than soft.

It is occasionally necessary to remove a piece from the lathe to try it into another piece already turned or completed at the bench. If the piece were put on a face plate like Fig. 61, the thread would soon wear so that it would not hold. A very convenient appliance to obviate this defect is shown in Figs. 62 and 63. The taper of Fig. 62 is the same as the taper in the headstock, so it will fit snugly and not slip or turn around. The piece to be turned is screwed onto the face of Fig. 63 with a common wood screw at *A*. After

it is screwed up tight the piece of wood and plate are screwed onto the part of the chuck which fits into the headstock. The piece being turned can be removed as many times as necessary by unscrewing the part shown in Fig. 63 without affecting the work. When a face plate similar to the one shown in Fig. 61 is used, the face plate and wood should be removed together if further turning is necessary.

Another very handy appliance is shown in Fig. 64. This can either be used in the head- or tailstock. A piece can be screwed on by wood screws and turned, or it can go in the tailstock and act as a back for a piece.

A chuck similar to Fig. 65 is another very useful tool for holding drills and bits or for turning small dowels, etc. It should run true and fit either head- or tailstock. A hole is bored part way in the milled face; this is for a wrench, to tighten the piece in the chuck more securely. When turning large work, such as cylinder barrels or any large piece, it is necessary to have something to center and hold the work in place, and if it is a split pattern it must be held so the halves will not separate.

For the headstock end of the pattern a device shown in Fig. 66 is sometimes used, made of steel or malleable iron with a projection or tongue at *A*. There is a deep center line

PATTERN-MAKING

PLATE VII

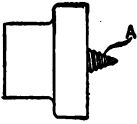

Fig. 61

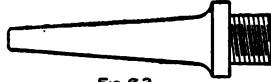

Fig. 62



Fig. 63

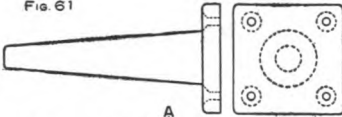

Fig. 64

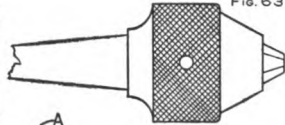

Fig. 65

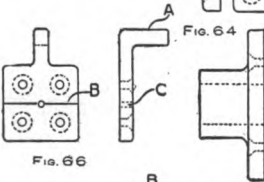

Fig. 66

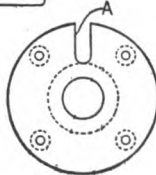

Fig. 68

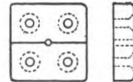

Fig. 67

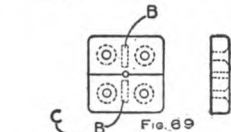

Fig. 69

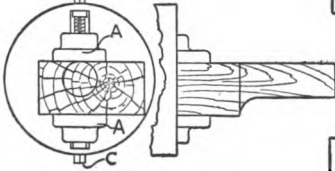

Fig. 71

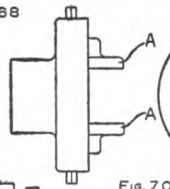

Fig. 70

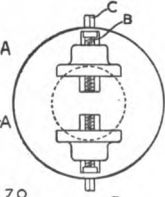

Fig. 72

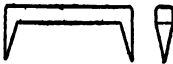

Fig. 73

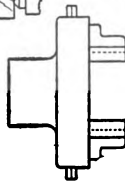

Fig. 74

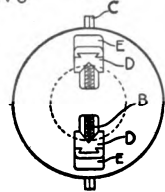
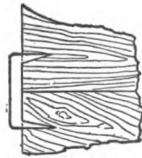
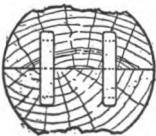

Fig. 75





scratched across the face which must be exactly through the center *B*. This is to center the piece on the joint of the pattern if it is a split pattern. A small hole is drilled as shown at *C*. This should be on the center line through the tongue. After this has been screwed onto the pattern in the proper place, Fig. 67 is fastened on the tailstock end of the piece to be turned. This is the same as the device shown in Fig. 66, except that it does not have the projection and is generally made of lignum-vitæ. This wood is hard and has an oily surface, thus making it run freely on the tail center. The common centers are placed in the head- and tailstock; the plate (Fig. 68) is then screwed on to the spindle of the head end. There is a slot, *A*, in this plate, which is used for the purpose of receiving the tongue on *A*, Fig. 66. When power is put onto the lathe it turns the plate, and by engaging with the tongue and slot causes the pattern to revolve in the lathe.

Fig. 69 is the same as Fig. 67, only it is used for the head end instead of Fig. 66 when smaller work is to be turned. The two slots, *B B*, are for the purpose of receiving the flat projections of the form center (*J*, Fig. 46, Chapter V.) It is not commonly used, and it is not advisable to use this plate on very large work, or over 12 in. in diameter.

A handy chuck is shown in Fig. 70. The two

jaws *A A* are independent of each other, and one can be raised or lowered without disturbing the other. They are screwed up or down by screw *B*, which has a thread cut nearly the whole length. *C* is a continuation of *B* which is made square for the purpose of receiving a wrench.

Fig. 71 is an illustration of the way this chuck works. One end of a piece is to be turned out of center as shown, and the problem is to set this block in the proper location for the work. The face of this chuck and the block must be true in every way. Mark on the end that is to be turned the center of the required diameter, open the jaws *A*, move up the tailstock to the center which has been marked, screw up the hand wheel (*H*, Fig. 46, Chapter V) so that the block will stay in place, and turn the ends *C C* till the jaws clamp the block. To keep the block in line with the jaws before screwing the second jaw, use one jaw to help locate the block on the center, raise up the bottom jaw till the center is located all right, and slide it sidewise until the center is determined the other way. Then turn the end of the screw, and the mark is ready.

Another chuck, similar to the one in Fig. 71, is shown in Fig. 72. In this the jaws work together by the screw *B*, the section *D* being dovetailed on the jaw *E*, which is worked up and down by the screw. Jaws *D D* are made with

different shapes of cutouts. The one shown in Fig. 72 is a V shape, but there are half circles of different diameters and other shapes that are found necessary. This chuck is specially useful for metal patterns, which will be dealt with later.

Fig. 73 is called a dog and is made of steel in different sizes and in shapes as shown. These are used as clamps, and draw and hold two pieces together as shown in Fig. 74.

For small split patterns a piece of corrugated metal about $\frac{3}{8}$ in. wide is used to hold the halves together (Fig. 75). It is driven into the end of the pattern at right angles with the division line and in positions similar to the ones occupied by the dogs in Fig. 73.

Another way to hold the halves of a split pattern together, if it is a spindle-turning job, is to screw the halves together at points beyond the limits of pattern length. These ends containing the screws are cut off when the turning is completed.

CHAPTER VII

TURNING

IN large turning such as rings, pulleys and jobs of that kind, the face plates are made of wood as the chuck or iron face plate (Fig. 46, Chapter V) is not large enough for very large work. The face plates shown in the present chapter illustrate the different constructions for large work. The iron chuck is screwed on the back when in use, and should be located in the center. If it is not, it will cause the work to shake and not run true, and the turning tool will be in danger of catching in the piece. It is better to spend a few minutes longer in locating the iron chuck centrally on the wooden face plate than to rush the work and simply fasten it where it looks central.

Fig. 76 shows a face plate made out of a wide board. There are battens (*A*) across the grain on the back to strengthen it and keep it from warping. A face plate made in this way has to be trued up frequently, because it gets out of shape on account of the strains to which the grain of the board is subjected. It is not advisable to use this kind of face plate for a job that will take very long to turn, for it will not

stay long in shape. They are inexpensive, however, and are used for short jobs.

A good face plate is shown in Fig. 77. The four segments *A* are sawed out lengthwise of the wood, which makes it superior to the chuck in Fig. 76, as it resists the strains which are caused by the variations of temperature. It is trued up much better and smoother, especially on the circumference, as there is no end grain, which is always more or less rough. To hold these segments together there are two bars across the back let into each other by a half lap joint as shown in Fig. 78. They are then glued and screwed together. They should be screwed before the glue has set, so they can be brought tightly together while the glue is warm. Fasten this cross-piece on the back of the four segments, as shown in Fig. 79; glue and screw as shown. This makes a very good face plate for work, say, 18 in. to 2 ft. in diameter. When getting out the stock for the cross bars make them about $1\frac{1}{4}$ in. thick by 2 in. wide and have them both exactly the same thickness and width. If the segments *A* are not exactly the same thickness it does not matter so much, because after it is put in the lathe it can easily be trued off.

Face plates for very large work are made similar to Figs. 80 and 81, say for work 4 ft. and upward in diameter. A face plate for as large

work as this requires more supports than the smaller sizes. Although there are eight arms in Fig. 80, it is not absolutely necessary that on face plates for work ranging from 2 to 4 ft. in diameter there should be eight arms. With six-arm plates use only six segments, *B*. In making these face plates, make them the thickness and width of the bars *A* all the same. On the 4 to 6-foot plate make the thickness not less than 2 in. and the width not less than $3\frac{1}{2}$ in. In a plate of this size it is very important to make it strong and secure. All the bars *A* are glued and screwed to the board *C*, Fig. 81. After this has been done segments *B* are glued and screwed to the bars *A* as shown; the holes for screws are bored in, say, half the thickness of the segments, the size of the head of the screw. Then a smaller hole the size of the wire of the screw is bored through the board. After these have all been screwed and glued the holes are plugged up with wood over the heads of the screws, so that when the face is trued off it will be smooth. Put the plugs in with the grain the same way as in the segments.

Fig. 82 shows a face plate similar to Fig. 80, only instead of piece *C*, Fig. 81, screwed on the outside, it is fastened on the inside as shown at *A*. This piece *A* should miter together lengthwise of the wood, and the joint is made as in Fig.

PATTERN-MAKING

PLATE VIII

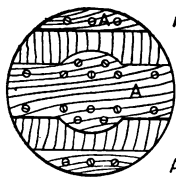

Fig. 76

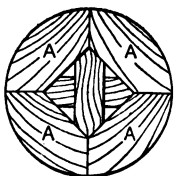

Fig. 77



Fig. 78

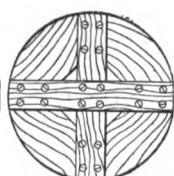

Fig. 79

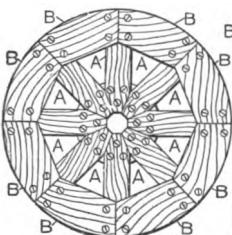

Fig. 80



Fig. 81



Fig. 82

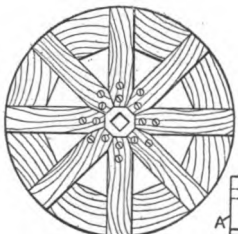

Fig. 83



Fig. 84

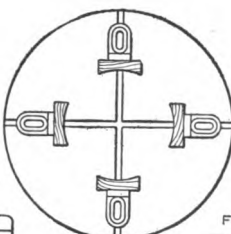

Fig. 85



Fig. 85

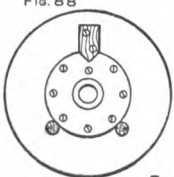

Fig. 86



Fig. 87

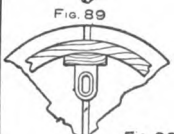

Fig. 88



84. This is a tongue joint as described in Chapter IV, Fig. 35. The piece *A* is placed on the inside instead of on the outside or back, as *C*, Fig. 81, because, the nearer the piece that is being turned is to the iron chuck, the better it will turn, as the work will be steadier.

Fig. 83 shows the reverse side of Fig. 82.

In Fig. 81 there is quite a distance from the back of *C* where the iron chuck is screwed on the front of the face plate *B*, making quite an overhang, which has a tendency to make the work shiver and shake. If the turner had a piece of work on this face plate that was 6 or 8 in. deep, he would have to be very careful or his turning tool would catch into the piece and make trouble.

Fig. 85 is a face plate of segments glued up as shown. This is the best form of construction for keeping the shape of the face plate. It is not used for work over 3 ft. in diameter, because it is quite heavy.

Sometimes the turner may have a job that will call for two face plates and the shop may have only one iron chuck available. Then he will have to use the same iron chuck for the two face plates. Fig. 86 shows how to locate the iron chuck on both face plates and have them exactly in the same place, so that the work will run truly in both cases. Screw the face plate onto

the iron chuck in the proper place. Bore two holes close to the chuck, so that when dowels are driven into these holes the chuck will rest against both dowels. Diametrically across the chuck from a point midway between the dowels is cut a notch, and a piece of wood is screwed on the face plate into the notch. With this arrangement the turner can replace the iron chuck to its original position by removing the piece of wood screwed into the notch, and, after replacing the chuck, screwing the piece of wood back again.

Fig. 87 shows a special device for holding rings that may want turning off. There are grooves cut as shown in the face of the face plate so that the jaw shown in Fig. 88 slides in or out from the center to fit any ring. Ring patterns are sometimes made too large, necessitating some turning off on the outside or the inside, and this device is for holding the ring centrally on the face plate.

Fig. 88 shows the cast iron piece. On the face, *A*, a piece of wood is screwed. If there is a ring on the lathe that measures, say, 24 in. on the outside, and the inside of the ring is to be turned off, move these irons so that the wood on the face will come about $11\frac{3}{4}$ in. from the center, at any rate a distance less than the radius of the outside of the ring; turn off enough of this wood to fit the 24-in. ring, so it will fit tight as shown

in Fig. 89, and then turn off all that is necessary on the inside ring. If there is a ring that wants turning off on the outside, turn the iron pieces around as shown in Fig. 90 and do the same as before. This time the blocks, when first fastened into the face *A*, must be farther from the center than the radius of the inside of the ring, to allow some stock to be turned off these blocks.

CHAPTER VIII

TURNING

MACHINE turning is the work done on a large lathe when tools are held in a tool post. Machine turning is much easier than hand turning, and by it a much better job can be done, and in less time. There is, of course, more or less hand work, and probably always will be.

Fig. 91 shows a piece of work being turned in a machine turning-lathe. *A* is the headstock, *B* is the iron chuck, *C* is the face plate to which the piece *D*, the work to be turned, is fastened. The piece *D* is secured to the face plate by wood screws from the back of the face plate. The tool used and the tool post, or holder for the tool, can be turned at any angle, and there is a feed arrangement so that the tool *E* can be worked in or out. The tool post is adjustable on the base *F*, which is also movable on the base *G*, and this also can be moved on the base or carriage *H*. This carriage and base *G F* and tool *E* can be moved together on the ways, so that any angle or desired feed can be had.

Fig. 92 shows a front view of the arrangement for holding the tool and the adjustment for same. *E* is the cutting tool, which is secured in the tool

post, *I*, by a screw, *J*; there is a slot in this post as shown in Fig. 93. The cutting tool has frequently to be raised or lowered, and by the aid of a small piece of steel, Fig. 94, which has the same curve on the bottom as the bottom of the post has, it can be set at any angle, as shown in Fig. 95. The base that holds the tool post *I* can be moved on *G* by the handle *K* (Fig. 92). The joint *L* shows where the different angles are obtained by swinging around the tool, tool post and bases *F* and *G*. On this line the surface *M* is marked off in degrees so that any angle wanted can be obtained very quickly and accurately. *N* is moved on *H*, which also moves everything above this to the back or front. *H* is moved on bed *O* toward or away from the headstock.

To turn the inside of *D* (Fig. 91) the tool *E* is set up to work as shown, and the angle wanted is set by the marks at *M*; the power is put on and the cutting tool is worked back and forth by the hand wheel. To turn the bottom at *P*, Fig. 91, a square-end tool is used and worked back and forth by the handle *Q*, Fig. 92. The corner can be made with a round-nose hand-turning tool by simply resting the tool on the top of the machine tool *E*. Before taking out the screws in the back of the face plate *C*, which holds the pattern on, force some screws through the bottom at *P* into the face plate. This will hold the

pattern exactly in the same place, so that when the pattern is reversed to turn the outside uniform thickness will result. Take out the screws on the back, keep the bevel of the movable carriage and compound rest the same, and locate the tool so that it will give the required thickness; change the cutting tool around so that the other edge will do the cutting.

In Fig. 96 at *A* is the cutting edge for the inside. *B* will do the cutting on the outside. This tool is called a spear, or diamond point.

Fig. 97 shows another handy method for turning a circular shape on the inside of a pattern. *A* shows the pattern. *B* is the cutting tool as shown in Fig. 98. It is secured to the carriage the same as in the first job shown. Assuming the radius to be turned out as 12 in., after securing the tool in the tool post, turn the handle *C* until the edge of the cutter is just 12 in. to the center, where the rest turns around to any angle. Say that *D* is the center. Now it is 12 in. to the cutting edge of *B*, as shown. This center should come on the center line of the lathe between the head and tail center. Swing the entire rest around on this center, and the thing is done. To regulate the chip to be taken off, move the carriage up near the headstock. This saves making a templet and makes a true circle or part of a circle. The tool shown in Fig. 99 is used

PATTERN-MAKING

PLATE IX

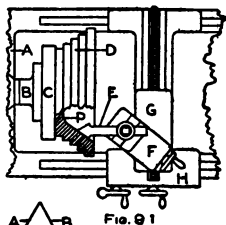

Fig. 91

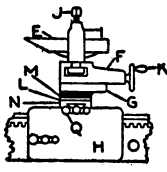

Fig. 92



Fig. 93



Fig. 94

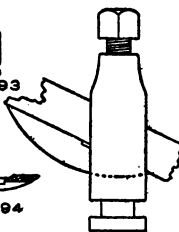

Fig. 95



Fig. 96

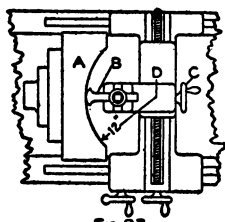

Fig. 97

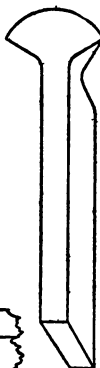

Fig. 98

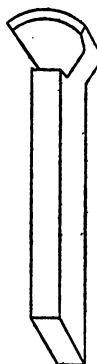

Fig. 99



Fig. 102

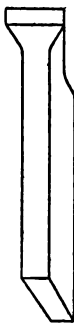

Fig. 100

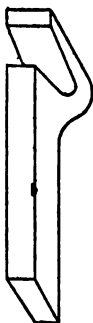

Fig. 101

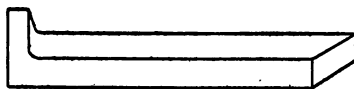

Fig. 103

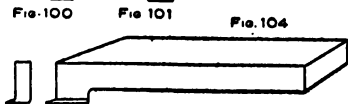

Fig. 104

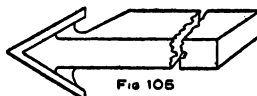
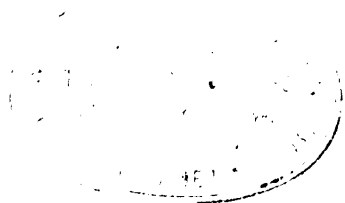

Fig. 105



for taking off the first chip and also for facing off segments on any disk that may be on the face plate. It works well also on outside diameters.

The tool Fig. 100 is good for general work on straight flat surfaces and is made in different sizes.

Fig. 101 shows an odd shape for a turning tool, but it is a "slick cutter" and leaves the wood as smooth as a piece of glass. The tool shown in Fig. 100 acts more as a scraper, but it is used as much as any tool for lathe work.

The tool in Fig. 102 is a cutting-off tool. The shape of the end acts as a knife and cuts or leaves a mark so that when the cutting edge strikes the wood it leaves a good smooth surface. The end grain of the wood is always hard to cut and keep smooth, and this tool is especially designed for this kind of turning. It is very important that the points be always sharp. It is not necessary that the one tool should have both points. They can be made in two separate tools and have a point on opposite sides in the two tools. One particular difficulty with this tool is that the points are very easily burned or dulled.

Fig. 103 shows a boring tool, and is used for holes that can not be easily reached. These tools are made right and left hand.

Fig. 104 is also a boring tool. It has a sharp point, and the side is made with a knife edge. It

is also made right and left hand, and, like the tool Fig. 102, it is easily burned.

Fig. 105 is a diamond or arrow point, and is used for finishing. When properly sharpened it will cut very smoothly and can be used both ways. It is used mostly for long, straight work, such as pipes, cylinder barrels and similar patterns.

Turning tools should always be kept in good shape, sharp and bright with a rack or cupboard for them so the edges do not knock one another. There should be a place for each tool, and it should always be put back in the place made for it. Never leave the tools lying around on the lathe. It is bad for the tools, and it does not look well. The workman should take as good care of the machine tools as he would of his own or even better, for it is his responsibility. It is the same way with the machines. A good workman should not look upon them as old junk even if some of them may look so. They are there to use, and care should be taken of them.

CHAPTER IX

THE CIRCULAR SAW

THE circular saw is an indispensable machine for pattern-making. It is mostly used for roughing-out purposes, removing stock, ripping up and cutting off. It is quite a labor-saver, also, when used with devices that may be applied to it for doing special jobs. Fig. 106 shows a simple pattern. There are many designs made, but the principle is the same in all. Some machines are so made that the table *A* can be set at a level. The saw *B* is adjustable so it can be raised or lowered above the surface of the table. There is a ripping gauge *C* which can be set any distance from the saw that the table will allow, and it is used for cutting stock to a width with the rip saw. The miter gauge *D* is used for cutting off stock with the cut-off saw at any degree or angle. There are usually two of these, one for cutting bevels and the other for cutting square ends. These gauges slide in the groove *E*.

The saws commonly used are called the rip saw and the cut-off saw. Saws are also made that are used for both ripping and cutting off. These are called combination saws. A circular saw, when sharpened properly and hung true, cuts very smoothly, even so that the piece sawed may

be sand-papered as it comes from the saw without dressing down. It requires a good saw-filer, one that is accustomed to filing saws, to make a saw cut clear and smooth. Saws should be entrusted for filing only to men that know their business.

There are several ways in which the teeth of a saw may be filed. It is quite a knack to do it right. The object in filing saws is, of course, to secure smooth and fast cutting with as little power as possible. Good results cannot be obtained by pushing and shoving the stock through.

In Fig. 107 are shown the teeth of a rip saw of approved pattern. Of course, there are many good forms. The first thing to do in putting a saw in order is to make the saw a true circle. This can be done by holding a piece of emery stone up to the saw so that the points will all touch the stone. This gives a guide to file the teeth, as the stone will make flat places, and will also make the saw run true on the arbor or shaft. After filing put it back on the saw arbor exactly as it was when trued with the emery stone. A mark can be made on the saw before taking it off, and it can be placed back by the same mark.

Fig. 107 shows one shape of tooth that works well. Use a standard saw gummer and a No. 3 saw swage to swage the teeth. After the saw is done it will look as in Figs. 107 and 108. An-

PATTERN-MAKING

PLATE X

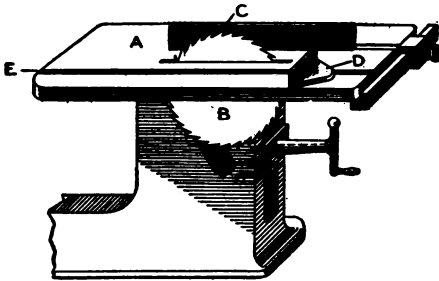

Fig. 106



Fig. 107



Fig. 108

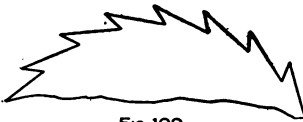

Fig. 109



Fig. 110

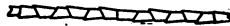

Fig. 112

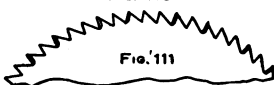

Fig. 111

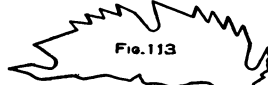

Fig. 113

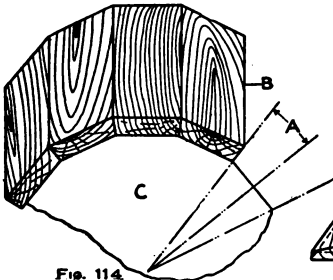

Fig. 114

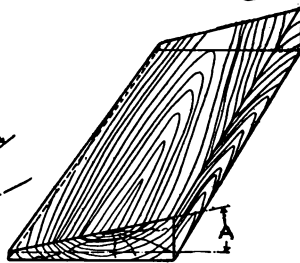

Fig. 115

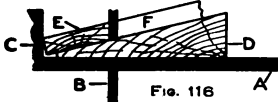

Fig. 116



Fig. 117



Fig. 118

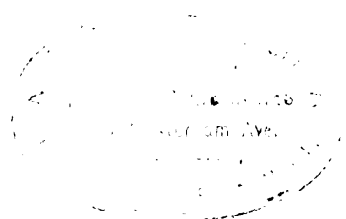

other way to file the shape of tooth is shown in Fig. 109. The tooth is strong, and the hook is made with a three-cornered file. Figs. 108 and 109 will make a kerf or cut as *A*, Fig. 110. For filing a cut-off saw a shape as in Fig. 111 cuts very nicely with every fifth tooth filed square across as shown in Fig. 112. Some file cut-off saws without the straight tooth, which leaves a cut or kerf as in *B*, Fig. 110. When sawing a spline with this style of tooth you are obliged to doctor the cut, as it will leave ridges and not a flat surface.

A saw for both rip and cut-off is shown in Fig. 113 and is called a combination saw. For nice work such as patterns this saw is excellent, if it is kept in good shape and sharp. The teeth are shaped made as shown. The maker of this saw claims that it needs no set, but without any set it soon gets dull on the points and then the work pinches. If a little set is made it leaves more clearance in the cut, the work does not pinch so soon and it gives longer service for each filing. Time and experience will enable one to file saws so they will cut well and do good work.

In making lags for a cylinder or pipe as shown in Fig. 114 the lags *B* are cut on an angle, as shown, to fit each other as they are matched together around on the head *C*. This bevel can be cut by making a board, Fig. 115, the bevel to

be obtained as shown in Fig. 114 by dotted lines at *A*. This angle may be determined with a protractor, or a full-sized drawing may be made and the bend square laid on the drawing to determine the lag angle. Next saw the lags *B*, Fig. 114. Be particular about the width, because if they are not accurate, they will run over or come short when fastened on the head.

Fig. 116 shows a sawing device used when the table *A* (Fig. 106) does not tilt. The thickness of the lags is shown at *E* and *F*. The board that the lags are sawed out of should be of uniform thickness and planed on both sides. The distance between the saw and gauge is set so that the width of the lags will come as required. To find out the width, lay out on a board the full size of the lags fastened on head, reproduce the individual lag sizes and saw to the lines. The bevel piece, Fig. 115, is fastened onto the table *A*.

In sawing these lags, some saw them as shown in Fig. 117 by sawing out a board as wide as the lag on the outer surface and cutting the bevel afterwards. This, however, wastes considerable stock if there are many lags or staves to saw. Fig. 118 shows the stock on each side that will be wasted. A better and more economical way to saw is shown in Fig. 116. *E* is the lag. The bevel on one side is being sawed by saw *B*. To saw the other edge of the lag turn

the piece upside down with the edge being sawed (as illustrated in Fig. 116) next to the guide, and saw the other side. Both edges of the board should be straightened on the buzz planer (to be shown later) which makes the edges straight so that the lags will be uniform in width. If more than one lag is to be sawed from one board the process of sawing may be continued by turning the board upside down after each saw cut. Each sawing forms one edge on each of two. If the saw is in good shape it will cut smooth and the work will need no smoothing with the hand plane, which will save much time. Ordinarily, however, it is wise to use the hand plane a very little. When gluing stock from the saw do not use glue that is too thin, as it will soak into the wood and do no good.

There are many saw "tricks." By this is meant there are many special things which can be done with a circular saw, but only square or bevel-edge ripping and square or miter-end cross-cut sawing are the uses to which the circular saw is usually subjected.

CHAPTER X

THE CIRCULAR SAW

THE circular saw is a very useful machine in the pattern shop, but it is a very dangerous tool if used carelessly as it will cut a workman's fingers or hand without giving the slightest warning. The familiar motto: "Don't monkey with the buzz saw," might well be posted over each machine. An experienced pattern-worker says: "When doing any work on this machine, don't have your eyes on something else and don't fool, but have your eyes and mind on the saw and what you are doing." This advice is good, too, in the use of any machine used in a woodworking shop.

In making cylinder barrels or pipe, a head is made on which to fasten the lags or staves. These heads are made circular, or in the form of a polygon, as shown in Fig. 119. Suppose we have a long pipe to make, requiring a number of these heads. It is necessary that they should be all alike. Fig. 120 shows a device for sawing these on the circular saw which makes them true and uniform. This device can be called a rotary protractor, as it is used to cut angles. The construction is simple, but the teeth in *B* should be made very accurately and spaced equally around

the circumference. This protractor (*A*) should be made of hard wood, preferably lignum-vitae, as it is hard and durable. Aluminum wears well and is also light. *C* is a piece of hard wood that holds the ratchet wheel *B* from turning. This is screwed on to the side as shown in Fig. 121. This ratchet wheel is set into a depression in the board *A*, Fig. 120, the diameter and depth of the wheel in thickness and diameter. If the board *A* is 1 in. thick, we will set the wheel in $\frac{1}{2}$ in., which is also the thickness of the ratchet. A hole is bored in the center which fits into a pin *D*. The fit should be snug, but the ratchet must turn easily on this pin. The pin *D* should be about 1 in. in diameter and glued solidly into the board *A*. There are four points *E* on the ratchet *B* to hold the piece to be sawed in place. It is very convenient to have two center lines scratched on the board through the center at right angles to each other, as they enable the turner to locate the piece centrally. Fig. 122 shows a section through *FF*, and Fig. 121 shows the edge of the board *A*, Fig. 120, with the spring of hard wood, *C*.

Fig. 123 illustrates the way in which the protractor is used. *AB* is the protractor, shown in Fig. 120. *D* is the saw table. *E* is the ripping gauge, which is supplied with all circular saw machines. To saw this piece, set the ripping gauge the right distance from the saw to place

the center of the ratchet at such a distance from the saw that the flat places on the head *C* will be sawed correctly. When this has been obtained, sink the piece *C* into the points on the center lines, turn the ratchet one notch and push the board. The saw will cut off one polygon side at *G*. Draw the board back and turn the ratchet two notches. This provides six sides on the half head shown. Therefore, we will turn two every time after the first sawing *G*, as in Fig. 123.

Some pattern-makers prefer to make their heads on a circle, as shown in Fig. 124, and fit the lags to the circle. Experience shows that it takes longer to make the lags by this method and does not produce any stronger patterns. But as it is the method that some use, we will describe this way to concave the lag by the circular saw to fit the head. *A* is the head and *B* are the lags or staves (Fig. 124). To cut the arc the lag has to be passed over the saw at an angle as shown in Fig. 125. To know the angle at which to pass the lag over the saw, lay out on the end of the lag a circle that has the diameter of the head that the lag has to fit, then set the saw above the table *A*, the height that the arc is above the bottom of the board to be cut, and swing the strip *B* to the angle so that the saw will cut to the line made on the end of the lag. If the diameter of the saw is greater than the diameter of the

PATTERN-MAKING

PLATE XI



Fig. 119



Fig. 124

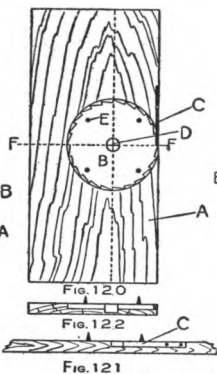

Fig. 120

Fig. 121

Fig. 122

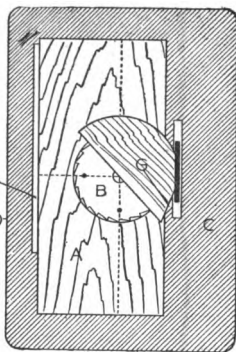

Fig. 123

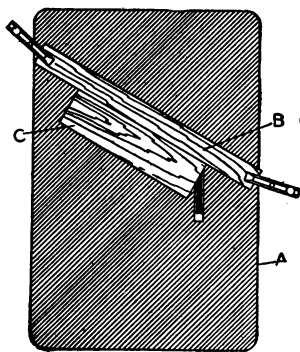

Fig. 125

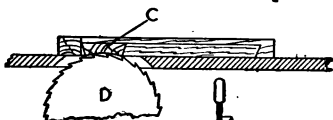

Fig. 126



Fig. 127

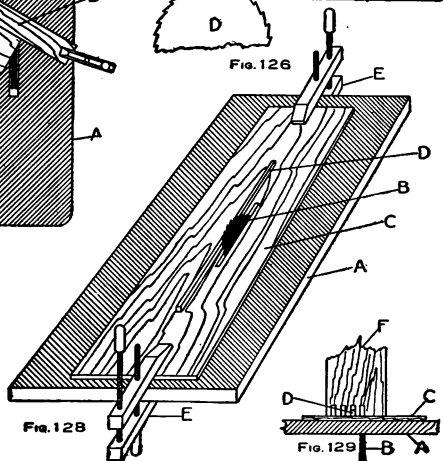

Fig. 128

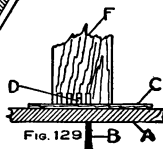
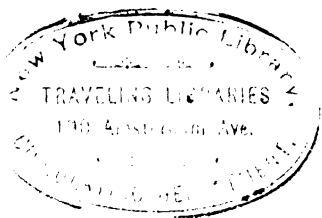

Fig. 129



head, you can saw the arc by passing the lag over the saw once. If the saw is smaller than the arc on the lag, it will be necessary to pass it over two or three times. When it is necessary to pass the lag over the saw more than once, the saw first cuts to one line, making the edge of the sawed-out part, and then to the other edge the second time. Then change strip *B* so as to cut the ridge that will be left in the center. It may be that three cuts are not enough. If so, pass it over again.

Fig. 126 shows the saw *D* cutting exactly on the line on the end of lag *C*. *B* is a strip of wood that acts as a gauge for the lag when passing it over the saw. The proper arc is sometimes made on the lags after sawing by planing with a plane called a lag plane. This takes much time and is hard work. If a man becomes an expert at saw work he will soon distance the man who works with planes and hand tools.

Fig. 127 shows a tongue-and-groove joint which may be made with the circular saw. Take a board 6 or 8 in. wide, $\frac{7}{8}$ or 1 in. thick and nearly as long as the saw table *A*, Fig. 128. For this work a saw is generally used that cuts a kerf about 5-32 or 3-16 in. wide, and this saw is used for this work only. Cut a groove part way through the thickness and length of the board *C*. A strip, *D*, of hard wood as thick as the

groove is wide, and also as thick as the saw, is glued into this groove. Move the ripping gauge near enough to the saw so that the space between the saw and strip *D* will be the same as the thickness of the saw. If we are using a saw 3-16 in. thick, the strip *D* will be 3-16 in. thick and the space between strip *D* and saw *B* will also be 3-16 in., the gauge being set to let *C* carefully down over the saw so that the saw will come through about $\frac{3}{8}$ in., as this is the most common depth of cut used. Clamp the board *C* to the saw table *A* with wood clamps *E*, as shown, to hold it securely on the table. Before sawing the pieces that are wanted take a waste block from the wood box, hold it against the strip *D* and pass it through the saw. After this has been done, put the cut over the strip *D* and pass it through the saw again; repeat as many times as possible, determined by the width of the block. See Fig. 129. After the block has been sawed across in this way, rip it through the center of its width and try the halves by fitting tongues in grooves. They should fit easily without any friction; if not, the board *C* must be shifted to one side or the other. When doing this be careful and keep the strip *D* perfectly parallel with the saw. When the trial blocks fit without any friction we are ready to saw the joints for the finished work. One side of the pieces should be

smooth. Always start with this smooth side against the strip *D*. When getting out the stock for a piece to be jointed in this manner, make it longer than the desired length of jointed pieces by the depth of the cut, so that when put together they will be the correct size. When cutting the other side or piece that fits into the first piece there will be a groove instead of a tongue. To make this half match, take the first piece cut and place the first cut made over the strip *D* so that the smooth side will come next to the saw. Now place the smooth side of the second piece so that the smooth side of this will rest against the smooth side of the first piece, the two sides coming together. Then pass over the saw with first piece as a guide. This makes the first cut in the second piece. Complete the sawing as on first piece. Do not try to force the work through, but let the saw cut its way. Fig. 129 shows the first piece partly sawed and guided by the strip *D*.

CHAPTER XI

MACHINE TOOLS

THE machine tools used for pattern-making are designed so that a great variety of work can be done on them. Modern tools have many improvements for doing work rapidly and accurately, and it is necessary to obtain the best machines that can be had for first-class pattern-shop work.

Fig. 130 shows a scroll saw, or, as it is more commonly called among pattern-makers, a jig saw. It is used to cut spiral ornaments or holes of odd shapes. The table *B* in some make of machines is made of iron, and in some of wood, as shown, glued up in strips, planed true and straight, with an arrangement so that the table can be set at an angle, with a plate, *C*, showing the degree marks at which it may be set. The saws, *A*, vary in length, and different lengths of saws can be used by raising or lowering the top guide.

Fig. 131 shows the saw *A* passing through the table *B*. These saws are filed with teeth as shown.

If there is an odd-shaped hole to cut out of a solid piece, as Fig. 132, *C*, first bore a hole, *B*, large enough to allow the saw to pass through it;

PATTERN-MAKING

PLATE XII

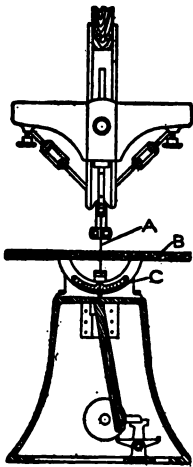

Fig. 130

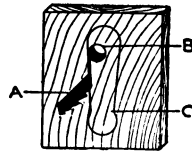

Fig. 132

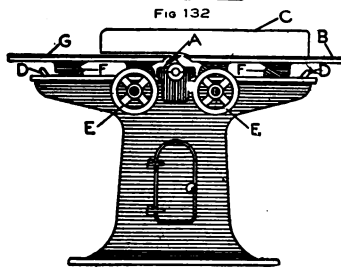

Fig. 135

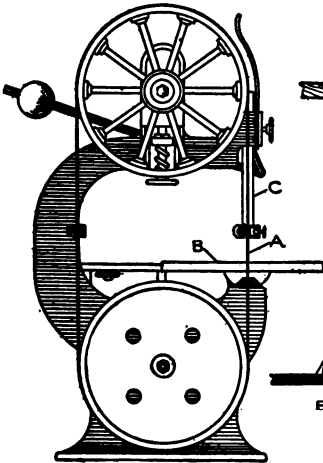

Fig. 133



Fig. 131

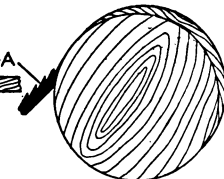

Fig. 134



Fig. 136



Fig. 138



Fig. 137



detach the saw *A* from the holders on the machine and pass it through the hole *B*; then attach again in the machine and saw around on the mark. Some machines are provided with a rotary fan for the purpose of removing the sawdust from the lines to keep them visible.

Fig. 133 shows a band saw, almost indispensable in pattern-making. It will cut with great rapidity and trueness if the saw is sharp and filed with a proper "set" in it. It is especially useful for cutting teeth in wheels or for sawing segments when making wheel patterns or gears. The band saw is an endless piece of sheet steel from several inches in width to as narrow as 1-32 in., carrying saw teeth and moving vertically and steadily in one direction. It is used entirely for outside work, or cutting in from the outside edge of a board, as shown in Fig. 134. The table *B* (Fig. 133) is so constructed that it can be set at a bevel or angle on or less than 45° . *A* shows the saw, and *C* the top guide, which can be raised or lowered to suit the thickness of stock. It is best to have this guide as near the work as possible, as the saw will run truer and the line can be followed more accurately. A great many devices are used with the band saw for doing work quickly and accurately, and well known among experts as tricks in pattern-making. These will be shown later.

The buzz planer or jointer, often called an edger, is shown in Fig. 135. It is a very dangerous tool, as the knives *A* are exposed between two tables, *B* and *G*, and there is no shield except the piece in the hand to prevent the fingers from coming in contact with the knives. There are two shields made to cover that part of the knives not in use, but if the work should catch in a knot and throw the piece from under the hand, there is nothing to prevent the hand from going into the knives, and when such a thing happens it means a disfigurement for life.

“Never under any conditions allow the hands to pass over the knives on top of the piece you are planing, but always keep them back or ahead of them.” This is a good rule for short work, but for long pieces it is not necessary to follow it. Never try to plane a piece that is too small or short, say shorter than 12 or 14 in. It is better to waste a few inches in length by starting with a piece too long than to run the chances of losing a finger or hand.

In Fig. 135, *A* are the knives, which revolve very rapidly, and, when sharp, cut very smooth and true. The table *G* should be exactly in a line with the knives when they are at their highest point, and the depth of the table *B* below that of *A* determines the thickness of the chip or shaving. The tables are raised and lowered by the

hand wheels *D*, which slide on blocks *F*, which are on an incline. *C* is a gauge to make the edge square or on a bevel, as in Fig. 136. *B* is the table, *C* the gauge or fence, and *A* the piece being planed. When changing the knives the tables are moved away from them by the hand wheels *E E*, which gives the workman more room to work. A great many shops buy their lumber rough from the saw, and it comes more or less twisted. By passing the board over this planer with a side on the table *G*, one side is trued and straightened, but not always with parallel surfaces or uniform thickness. If parallel surfaces are required, the piece is next run through a pony planer described later. When there is occasion to make a cut on one end of a piece, as shown in Fig. 137, this is done by lowering the table *B* so that it will allow the cutters to cut the depth required. If there is a square piece to turn in the lathe the corners may be planed off as shown in Fig. 138, and thus save much time in turning.

CHAPTER XII

MACHINE TOOLS

THE surface or cylinder planer, sometimes called a pony planer, is shown in Fig. 139. This machine differs in construction from the buzz planer and is not nearly so dangerous, as the knives are covered up. The knives are fastened onto the cylinder *A*, the same as on the buzz, only they run or cut the top surface instead of the under surface. This machine is used for planing straight flat surfaces, or "parallel work." The knives on the cylinder *A* are the same as on the buzz planer and revolve very rapidly between the two rolls *B B*, which are feed rolls. The front roll is grooved and is the first feed roll. This feeds the stock into the knives. The back roll is smooth and feeds the stock through after it leaves the front roll. The table *C* is raised and lowered by the handle and shaft *D* to the thickness required. We will suppose a board $1\frac{1}{2}$ in. thick is to be planed to a parallel thickness, as the common term is, of 1 in. Do not set the table at 1 in., as that would make the planer take off too great a chip at one cutting. One-eighth or three-sixteenths is enough to take off at once and does not strain the machine. The two rolls *E E* are loose, which makes it easier to

enter or take a board from the machine. The weight *F* is for the purpose of holding down the rolls *B B* onto work so as to feed it through. The first side of a board may be surfaced on the buzz planer, or both sides may be surfaced on the pony planer.

If there is occasion to make a piece with one side narrower or thinner than the other, as in Fig. 140 *B*, as the draft on the ribs or sides of a pattern, get out a strip, *A*, of the thickness that is to be taken off the piece. That is, suppose we have a rib that is 6 in. high and 1 in. thick. On a piece of this height, say the top is to be reduced to $\frac{3}{4}$ in. thick. To plane this we will get out a strip $\frac{1}{4}$ in. thick and not very wide, shown at *A*. This tips up one side when passing through the planer, as shown in Fig. 140. If there is occasion to plane a piece of stock very thin, take a board, say about 1 in. thick, as shown by *B*, Fig. 141, the thin board being shown by *A*. If this thicker board were not used, the thin piece would not be straight, but would curl and twist as it went through the machine. When selecting lumber for this thin work, get as straight a grain as possible. If there are knots in the piece, or it is cross-grained, it will be likely to come out of the machine in a broken condition. Do not try to plane a piece that is shorter than the distance between the two rolls *B B*, Fig. 139. The piece

should be long enough so that when it leaves the grooved roll the smooth roll has caught it and the piece will continue feeding through the machine.

The boring machine shown in Fig. 142 is used for boring holes and making countersinks for screws. On some makes of machines the table *A* can be set at different angles. The table is raised and lowered by the hand wheel *D*, which is connected with a shaft *E*, which has a screw thread cut on it the whole length. The table slides on ways or guides *F*. The drills or bits are held in place by the chuck *B*, and this chuck is fastened onto the spindle *J*, which is raised and lowered by a foot lever *C*. The collar *K* can be adjusted on the spindle *J* to regulate the depth of the hole. The weight *G* is for drawing the boring tool out of the hole. *H* is the slowest speed pulley, and *I* the highest. For large-size bits it is better to run the lowest speed; for drilling brass the highest speed gets the best results.

Fig. 143 shows a tool for doing routing work, that is, cutting a surface parallel with the surface that rests on the table. Fig. 144 shows a piece with a depressed surface parallel with both top and bottom. To get this use a flat-bottom bit, boring nearly the depth wanted, and then change the bit for the router, Fig. 143, and finally rout the piece to the required line.

PATTERN-MAKING

PLATE XIII

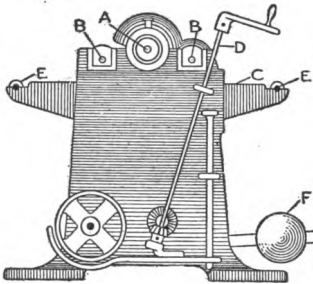

Fig. 139



Fig. 140

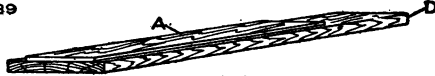
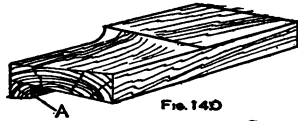

Fig. 141

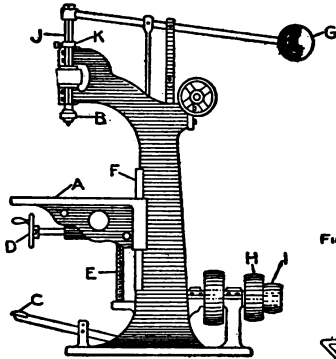

Fig. 142



Fig. 143

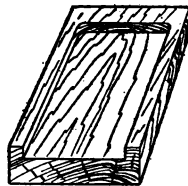

Fig. 144

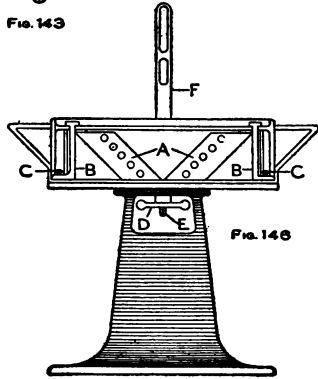

Fig. 145

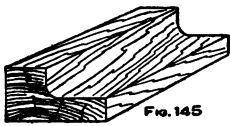

Fig. 146

79054

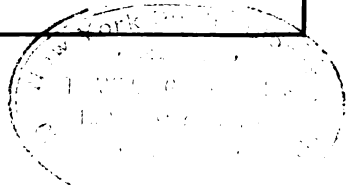



Fig. 145 shows a piece of wood cut with a flat, round-cornered tool with different radii of a circle, for making corners. Cutters are made for marking a surface parallel with the table; these are used with the cylinder planer. When using these tools the speed should be fast, as they cut much smoother with high speed than with low.

Fig. 146 shows a universal trimmer, without which no pattern shop is complete. The drawing or shaving movement of the knives *AA* makes a finish to the work that is not obtainable in any other way. It is necessary, however, to keep the knives very sharp. The handle *F* is detachable and can be adjusted to suit the work or the convenience of the operator. The wings *B* are held at the top and bottom rigidly and unchangeably in their relation to the knife cut, and are easily adjusted to any angle to the plane of knife travel. Smaller ones are made for bench use, but they will not cut large pieces. The one shown is on a standard and is easily shifted from one place to another in a room. It may be turned on this standard as shown. *D* is a hand wheel which is worked on a screw *E*, holding it securely when located in position. The wings *B* are held in place by a thumb nut *C*.

220521A

CHAPTER XIII

SIMPLE PATTERNS

WE will now take up some simple pattern work, including the method of constructing the patterns and the molding of the same in the foundry. The pattern-maker must consider:

1. How can I make the pattern so that the molder can make the casting most easily and at the same time obtain a good casting?

2. How many castings are wanted from the pattern?

3. How shall I construct the pattern so that it may be the best, cheapest and quickest way for the class of pattern wanted?

In Fig. 147 is shown a drawing of a bushing cast in a metal called composition and finished all over. The only way by which the pattern-maker can definitely know what he is to make is by a drawing or sketch. Sometimes an old broken casting is placed on his bench and he is told to make a pattern from it. The fact is that one of the worst things to make a pattern from is an old casting. There are no centers or figures to work to, but the pattern-maker has to measure the casting with a common rule and do more or less guessing to obtain the dimensions. Even then, when he has the pattern made,

he is not absolutely sure that he has the thing exact.

We will work from drawings in this series, as it is the method used in most shops. We have before us a drawing of a bushing, showing the shape, kind of metal that is wanted from the pattern, with figures giving the size of the finished casting, and also the finish to be allowed all over. If the drawing is a drawing for the machinist, this last item—the finish—is not given on the drawing, but must be calculated by the pattern-maker. This necessitates sound judgment on his part, gained only through experience. There are to be less than 1,000 castings made, and six patterns are required, all exactly alike.

The next thing is to decide how the patterns should be made. There are three ways in which this pattern can be made, as shown in Figs. 148, 149, and 150. We will select Fig. 148 as one that illustrates an easy method for the molder. It is called a split pattern, or one made in halves. We will make these patterns of cherry or mahogany, as hard wood will be more durable for the work demanded. We first find two pieces of wood long enough and wide enough to turn out in the lathe the sizes wanted. There should be two dowel pins, *A*, fastened into the cope half, and this half should always contain the pins.

Fasten these two halves together and place in the lathe with the centers exactly on the joint line of the halves, as described in a previous chapter. The diameter is to be $\frac{1}{8}$ in. larger than the drawing calls for, core prints $\frac{1}{8}$ in. smaller, and the length should be $\frac{1}{8}$ in. longer, so as to allow for finish. This leaves 1-16 in. all over to turn off in the machine shop. We should allow 3-16 in. shrinkage to the foot, as that is the shrink allowed for composition metal. The length of the core print *B* on the cope side is 1-16 in. longer than on the nowel, the reason for which will be shown later.

The pattern being made, the foundryman takes a mold board *A*, Fig. 151, lays the nowel half of the pattern *C*, on this board, as shown, and covers it up with packed sand to the top of the flask which has been placed around the pattern. After this has been done another board is placed on top of the flask and the whole thing turned over. The mold board *A* is then taken away, which leaves a joint line, *AA*, Fig. 152. The cope half of the pattern is then placed on top of the nowel half, and the cope half of the flask is placed on top of the nowel half, and then sand is sifted or riddled over the pattern to the top of the flask, as shown. Usually the amount of sand riddled is just sufficient to cover the pattern; the rest of the sand to fill the box is shoveled in

PATTERN-MAKING

PLATE XIV

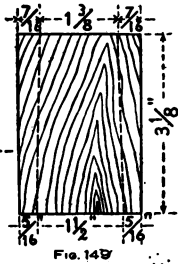
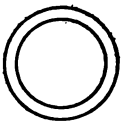

Fig. 149

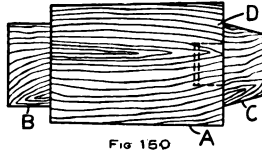

Fig. 150

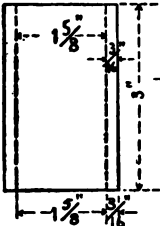

Fig. 147

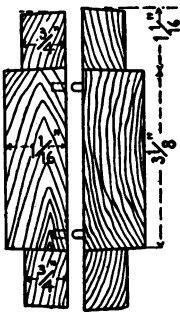

Fig. 148

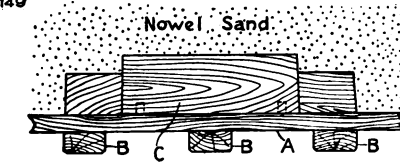

Fig. 151

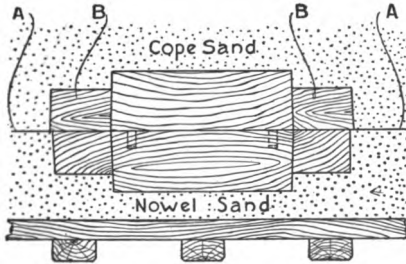

Fig. 152



Fig. 153

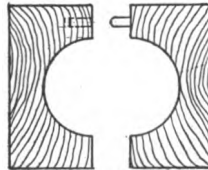

Fig. 154



from the pile. The cope half of the flask and pattern are lifted up and away from the nowel half, both halves of the pattern are drawn out of the sand, and the corners trimmed. In the impression that the core prints *B B* make a core is placed. To make this core a box is made as shown in Figs. 153 and 154. Make the length of the core box the same as the length over all of the nowel half of the pattern. The two halves of the box are made and pinned together as shown. When the core is made it is placed into the nowel half of the mold, as shown in Fig. 155; the cope half is then lowered on top of the nowel. A section of the mold is shown in Fig. 155. *A A* is the joint line of the nowel and cope; *B* is the bottom board, *C* the nowel sand, *D* the cope sand, *E* the core, and *F F* the space left for the metal to flow into. There is a space, *G G*, between the cope and the core. This is left so that when the cope half of the mold is lowered onto the nowel the core will not rub and break off the sand. It must be kept in mind also that in making the mold a runner hole and gate must be provided, through which to run the metal into the space between the mold sand and the core.

Fig. 150 shows another way to make this pattern, and one more economical of space, as six can be placed in a single flask, using a smaller flask than in Fig. 148. *A* (Fig. 150) shows the

pattern, *B* the nowel core print, and *C* the cope print. On this core print, *C*, there should be a pin turned, *D*, and a hole bored into the pattern the same size as the pin, so that the print can come off loose. This is made in the foundry the same as shown in Fig. 148 and as shown in Fig. 156. *B*, in Fig. 156, is the nowel part of the pattern. The same operation for the cope half is performed as illustrated in Fig. 152, and as shown also in Fig. 157, where *A A* is the joint line of the cope and nowel, and *C* the core print, which is all the part of the pattern we have in the cope sand *D*. *B* is the nowel part of the pattern and *E* the nowel sand. A core box is made for this pattern, but it differs from Figs. 153 and 154, as one end has a tapered part to match the print, *C*. This core, when placed into the mold, stands on end as shown in Fig. 158. To make this core a box is made as shown in Figs. 162 and 163. Otherwise it is the same as Fig. 155 as to the method of molding. The reason that the cope print is tapered is that the core may find the hole in the cope sand and be drawn into the proper upright position as the cope reaches the nowel. When making boxes of this kind, make the box a shade longer than the total length of the prints, so that when the cope is down fast it will hold the core firmly in place. Fig. 158 shows flask in section ready for pouring.

PATTERN-MAKING

PLATE XV

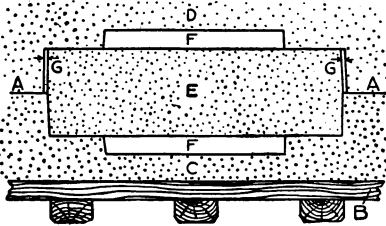

Fig. 155

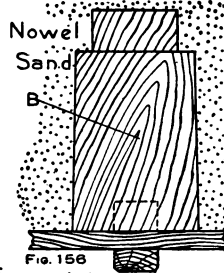

Fig. 156

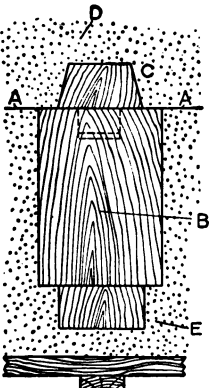

Fig. 157

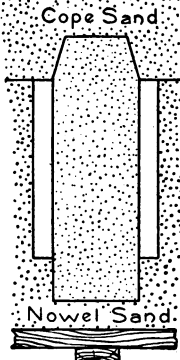

Fig. 158

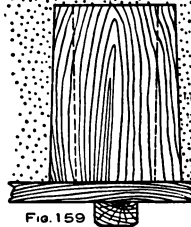

Fig. 159

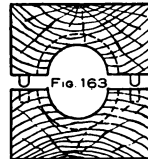

Fig. 163

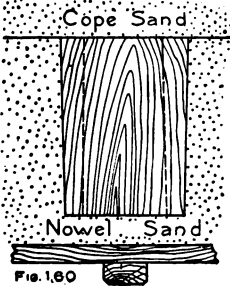

Fig. 160

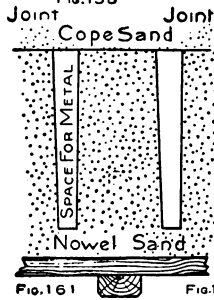

Fig. 161



Fig. 162



We have gained some on the last method, as shown in Fig. 155, because we can use a smaller flask, but the time taken in making the core and setting it in place should be considered, not to speak of the core sand used.

Suppose we make a pattern that does not require a separate core. Fig. 149 shows how this may be done. In making the pattern for this take a solid block of hard wood and turn out the inside and outside, with the grain lengthwise of the pattern. When turning make a taper, on the inside and outside, so it will draw out of the sand easily. There are no core prints, as it is in the form of the casting wanted. The foundryman molds it the same as the others, only in the novel half he packs the sand inside and outside of the pattern and makes the whole thing in the novel part of the mold, as shown in Fig. 159.

Fig. 160 shows that only sufficient cope is required to cover over the top part of the pattern. A section of the mold made from this pattern is shown in Fig. 161. This method, called vertical molding, is only used where the pattern is comparatively short. For long patterns this method makes the drawing of the pattern difficult.

Comparing the three methods of making the pattern for castings of this bushing, the last way is clearly the best. In the first place there is no

expense of core sand, and no time is required for setting the core. It is also an easy pattern to mold, and good castings can be obtained from it. The reason why the three forms are described is that they may serve as an illustration of some of the problems that are sure to confront the pattern-maker at the start.

CHAPTER XIV

SIMPLE PATTERNS

IT is not always from the large things that we learn most. Much experience is gained from the simple problems and those that look easy. Fig. 164 shows a cross section drawing for a piece for which a pattern is wanted. This is not in itself a difficult pattern to make, but the way the inside is cored out, or the way that it is to be constructed so as to make it hollow, is something to be thought out. It is a good illustration of what is called a balanced core job.

Fig. 165 shows how the pattern is made for this piece. A split pattern is fastened with dowel pins, so that one-half comes in the nowel and the other half in the cope. The pattern is split on the line *F*, *A* being the cope half of the pattern and *B* the cope part of the core print. The diameter of *E* is the same as the mouth of the hole, or $\frac{3}{4}$ in. *C* and *D* are the nowel halves of the pattern and core print. If the casting were to have a hole in each end, we would not be obliged to make this with a balanced core, because there would be a bearing on each end for the core to rest on, as shown in the preceding chapter. As this has only one end open, we make a core print so large and long that the weight

of the core outside the pattern will balance the real core inside. This means that when the core is set into the mold, it will stay up in place. Hence, it is called a balanced core.

Fig. 166 shows the core box. There are two halves made and pinned together, so that a whole core can be made. *A* is the part of the box that makes the core for the inside of the casting, *B* is the part that makes the core fit the core print, *G* is the part that makes the part of the core that provides the $\frac{3}{4}$ -in. hole. On the end at *H* there is a separate piece pinned on so that the round corner can be obtained at this end of the casting. This core box might be made of two solid halves and the round corner provided for by placing a fillet in the core box. *D* shows the piece and *E E* the pins. When the coremaker makes this core, he places the two halves of the box together with piece *D* taken away. He fills this end with sand up to the joint line *H*, or a little above; he then places this piece *D* on, and it forms the corner and end of this part of the core. The box is then turned end for end and filled with sand to the top. The operator next takes off one-half of the box and rolls the core out of the other half onto a plate to bake it. It is better to make the core all in one piece, because when a core is made in two halves and pasted it is liable to be "out of round," caused by the paste that holds the two

PATTERN-MAKING

PLATE XIV

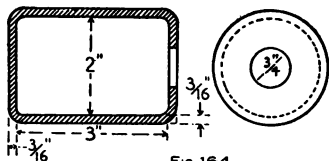

Fig. 164

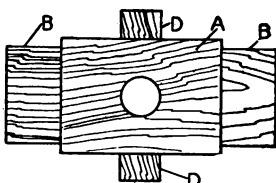

Fig. 170

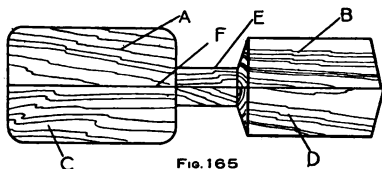

Fig. 165

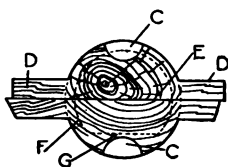

Fig. 171

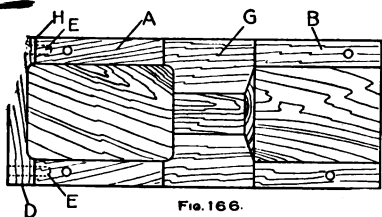

Fig. 166.

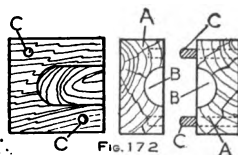

Fig. 172

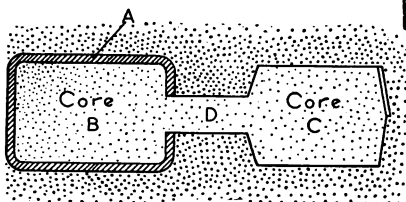

Fig. 167

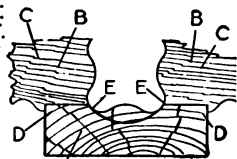

Fig. 173

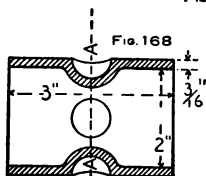

Fig. 168

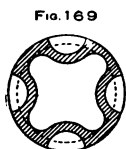
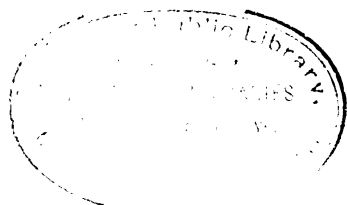

Fig. 169



halves of the core together. When making a pattern where a balanced core is used, be sure to have more weight in the print than in the core itself. Fig. 167 shows the core set into the mold. *A* is the space between core and mold into which the metal flows, making the casting. This core should be held in position with wire or the incoming metal will break the neck of core. *B* is the core, *C* is the balance end of the core, and *D* is the connection of the cores, $\frac{3}{4}$ in. in diameter, and making the hole in the end of the casting, as the drawing calls for.

Figs. 168 and 169 show another drawing for a casting which also requires a balanced core. Fig. 169 is a section through Fig. 168 at *A A*. To make this pattern we make a split pattern the same as Fig. 165. Dowel the halves together so that it will mold the same as the pattern just shown. Fig. 170 is a top view of the pattern. *A* is the part of the pattern that makes the mold for the casting. *B B* are the core prints for the inside core. *D D* are the small core prints for the balanced core that cores out the small half circle or parts of spheres in the sides at *A* in Fig. 168. Four of these are wanted on the casting; two of them are cored and two make their own cores, one in the cope and one in the nowel. They are cut out of the pattern, as seen in Fig. 171. The two hemispheres that come on the cope and nowel

could be cored, and a great many pattern-makers would have a print at these points, but it is not necessary, and if a print were added it would require another core box for the cope half, as the print would be tapered, and the same box could be used for only three cores.

In Fig. 171 *E* is the joint line of pattern, *D D* the prints for coring out the hemispheres, *C C* the part of the sphere cut out in the nowel and cope half of the pattern, and *F* is the line of the large core print, which has a place made flat as shown at *G*. This is for locating the main core in the proper place. If there were no flat or odd shape on this core print, there would be no way of setting the core in its proper place, to obtain an even thickness of metal around these half spheres. This flat piece on the core print should always be made on the nowel part of the pattern, because the core is set into the nowel half of the mold and by having the flat part in the nowel the molder can see what he is doing when he sets the core.

Fig. 172 shows how to make the core box for the small core. The two halves are made alike and pinned together, *C C*, so that a solid core can be made. *A A* show the two blocks. After the pins have been glued in and one end of each of the pieces is trued off, bore a $\frac{3}{4}$ -in. hole, which is also the diameter of the prints, down to where

the center of the half circle starts, or the depth that the print is in length. Then cut out the hemisphere with hand tools, to be shown later. *B B* show the core cavity.

The box for the main core is shown in Fig. 173. This box is also made in two halves, one half only being shown, and pinned together so that a whole core can be made, as was explained for the casting shown in Fig. 164. *A* is the block, in which a half circle is cut the diameter of the large core print and the length of the core. In this box we have to make a boss so that there will be the right thickness of metal around the ends of the small cores and also around the part we cut out of the pattern for two of the hemispheres. The bosses that come on the joint line of the box must be loose and pull away, as shown by *B B*, which are separate pieces from *A*. There is a shoulder made at *D*, so that the boss will project into the core box the right distance and will be made so that the corners at *E E* will form a proper contour with the inside. *C C* show a handle with which to pull this piece out of the box. It must be understood that Fig. 173 shows an end view of the core box. *B* and *C* are solid pieces which are drawn out to the right and left in the drawing. In reality they are plugs set into *A*.

CHAPTER XV

SIMPLE PATTERNS

THE heel core is a core used on patterns where there are to be bolt holes in the casting. Fig. 174 shows a drawing for the pattern, which is not a difficult one to make, but it requires some thought as to the best method to be followed. It can be made out of a solid block 8 in. long, $3\frac{1}{2}$ in. wide by $2\frac{1}{4}$ in. thick, but it takes time to cut out the stock inside so as to leave the rib all around. Small patterns of this kind are made in this way out of hard wood, but it makes an expensive job.

Fig. 175 shows a better and quicker way to make the pattern. Take a board 7 in. long, $3\frac{1}{2}$ in. wide, by $\frac{3}{4}$ in. thick, and on the ends saw in a cut and glue in a piece as shown in *B*, Figs. 176 and 177. This keeps the ends of the board straight and covers up the end grain. We now make the ribs for the edges. Saw them out on the band saw, making the draft and corner that come on these ribs. There should be a draft made so that the pattern will draw out of the sand. Glue and nail these onto the board *A* around the edges. After the glue is dry, make the corner round in the inside. For making these corners use a tool made for the boring machine,

a peculiar form of drill called a fillet cutter, which makes a nice, smooth corner.

Fig. 178 shows the cutter. *A* is the shank, *B* the circle, which has the same radius as the filleted corner required. It is sharpened from the inside always. Keep it sharp and cut with or across the grain. The method of cutting this corner around the inside is shown in Fig. 175. *C* is the cutter, *B* the ribs which were glued around the edges of the board with a draft on the inside, as *G*. The outside of the ribs has a slight draft also, but as the outside comes in the novel sand it does not need so much draft as does the inside. When cutting these corners, make a roll (or hollow cylinder), shown by dotted lines *F*, with a hole through the center the same size as the shank, and have it fit snug. This roll acts as a guide when cutting, as it is to bear against the bevel of the inside of the rib. The diameter of the roll should be just a little greater than the diameter of *C*.

Fig. 179 shows the cutter as it cuts around; *E* the cutter, *F* the roll that guides it, *C* the board that is being cut, *B* the ribs. After the corner is cut all around, take out this cutter and place a routing cutter in its place. This has a flat bottom and is used for flat surfaces. To gauge the depth for both round and routing cuts, fasten the collar *K* as shown in Fig. 142, Chapter

XII, and adjust table *A* to the depth of cut to be taken. On large corners it is not advisable to attempt making the whole corner with one setting of the table, but make the cut in two settings. This is a very quick way to make the corners, and the result is a very nice job.

Another way of making this pattern is shown in Fig. 180. The ribs *B* are deeper and the center rib *A* is thinner than in Fig. 175. This center rib is made the same thickness as the casting, and the ribs around the edge make the height called for on the drawing, with a draft on the inside as shown. They are glued and nailed onto this center rib or board in their proper place. The corner is made with what is called a fillet made of leather, or in some shops of wax, although leather lasts longer and helps to strengthen the corners. Some glue the fillets and others prefer shellac to fasten them to the pattern, which lasts longer, as the damp sand does not affect it. When securing them in with shellac cover the surface of the corner that comes next to the wood with a coat of shellac first, then cover the wood on the pattern with shellac. Do not use too thin shellac, but have it rather thick and light-colored. For rubbing it into place there is a very fine tool called a filleter, *F* (Fig. 180), *D* shows the fillet in place, and *G* after it is rubbed into place. There are 12 $\frac{1}{4}$ -in. holes to

PATTERN-MAKING

PLATE XVII

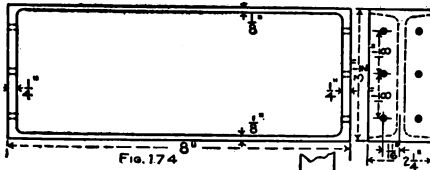

Fig. 174

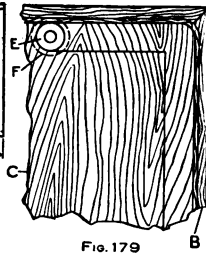

Fig. 179



Fig. 178

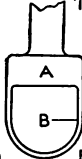

Fig. 175

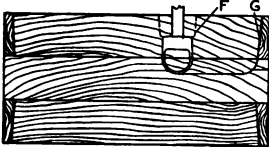

Fig. 180

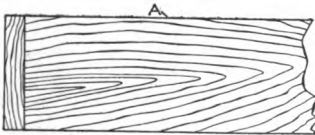
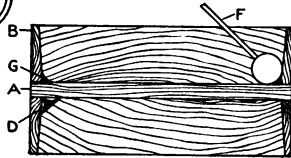

Fig. 176

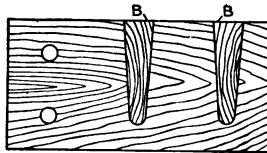

Fig. 181



Fig. 177

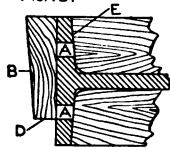

Fig. 182

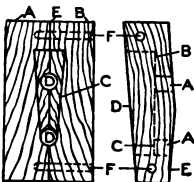

Fig. 183

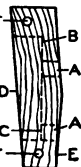

Fig. 184

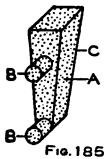

Fig. 185

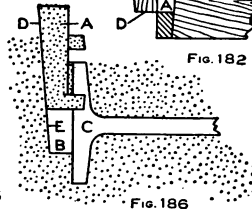
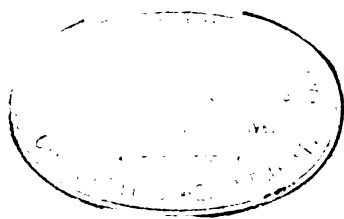

Fig. 186



be cored in the ends. Some shops drill these holes; others want them cored. When coring them, fasten onto the pattern a heel core print, as shown by *BB*, Figs. 181 and 182. *A* shows the holes and the way they look when the casting is taken out of the sand. *B* shows the prints; they should have plenty of draft, so that when the molder sets the cores into the mold there will be plenty of room to enter into the hole made by the print.

In Fig. 182 *A* shows the holes, *B* the core print, *D* the draft on print, and *E* the draft on the inside of pattern. The prints should be of uniform size, so that one core box will do for all the cores. The box is shown in Figs. 183 and 184. Hard wood is preferred for these core boxes, as there are many cores to be made in one box. Split the box through the center on the line *E*, so that the core will come out easily. It is made in two parts, and doweled together by pins *F*. In making the box one section is made the same thickness as the core print, and through this is a hole the same shape as the print, so that the print will fit snugly into the hole. The shape is shown by *C*, Fig. 183. Another part of the box is made the same thickness as the rib on the pattern, with two holes $\frac{1}{4}$ in. in diameter bored as shown by *DD*, $1\frac{3}{8}$ in. apart, with the bottom hole on a line with the bottom of the

core print as shown. Fig. 184 shows another view of this box. *D* is the flat surface that the core is baked on and corresponds to the surface *B* shown in Fig. 182. *C* is the line of the casting, *B* shows the thickness and shape of these prints where they core, *A A* are the holes, *E* the draft on the inside of the casting or ribs at this point, and *F F* the dowel pins. When the coremaker makes the core, he rams the box up with core sand and lays it down on a plate with the surface *D* next to the plate. This is the surface of the core that it is baked on, because it is flat and has the largest flat surface of the core. The two halves of the box, *A* and *B*, Fig. 183, are drawn away, leaving the core as shown in Fig. 185. *A* is the core print part of the core, *B B* the cores proper, and *C* the surface that the core is baked on and also the outside of the core. The manner of setting it into the mold is shown in Fig. 186. *C* is the space made by the pattern, *B* the space made by the core print, *E* the outside surface of the core print, *A* is the core, and when entering it into the mold it is let down into the mold with the surfaces *D* and *E* together.

While this method of making bolt-holes by means of coring is possible, and an explanation of the procedure will prove profitable to the student of pattern-making, it is not to be recommended for general practice, because it involves

considerable expense and much careful work. Unless the holes are large it is much better to drill them in the casting. This drilling can be done by using jigs, which makes it possible to drill them rapidly. By using jigs also it is possible to drill a number of holes at one time.

CHAPTER XVI

CROOKED PATTERNS

CROOKED work in pattern-making is a part of the trade that especially requires thought, judgment and skill. It is necessary in making crooked patterns to construct them so that they will keep their shape, and also be strong and durable. Wood shrinks very little lengthwise of the grain, and when constructing work of the crooked kind it is desirable to have as much of the pattern as possible come lengthwise of the grain. Fig. 187 shows a drawing of a flat piece with a double or ogee curve, for which a pattern is wanted. The pattern itself is not hard to make, but it is not easy to make it so that it will be strong and keep its shape. Patterns of this kind are sometimes made out of the solid stock, but when so constructed are liable to split or warp.

The best and one of the strongest ways to make this pattern is as shown in Fig. 188. *AA* shows two pieces of wood $\frac{3}{4}$ in. thick, with the grain running lengthwise and the piece *B* running lengthwise connecting the two pieces *AA* as shown. The joint for holding these pieces together (Fig. 189) was shown and described in previous chapters. For this pattern the single

tongue-and-groove joint might be used. A saw cut is made in the pieces *A A* and also in the piece *B*, as shown at *C C* and *D D*, Figs. 188 and 189, and the pieces are joined accordingly. This makes a very strong and durable joint. Fig. 190 shows the single tongue-and-groove joint. A wide saw-cut is made in *A A* at *C*, which makes the groove for a tongue-and-groove joint. There is a tongue made on the piece *B* which fits into the groove in the pieces *A A*, as shown at *C C* and *D D*. This joint does not take so long to make as the one shown in Fig. 189, and, though not so strong, will do very well for a pattern where there are only a few castings wanted. The grain of the wood should in all cases run as shown in Fig. 188.

Fig. 191 shows another way of joining the pieces. The saw-cuts can be made on all three pieces at one setting of the saw gauge and saw. After the saw-cuts have been made in the ends of the pieces, a strip of thin stock the thickness of the saw-cut and with the grain lengthwise is glued in when the joints are dry and hard, bore a small hole or two in the pieces, as shown by, *E E*, and glue in a wood pin. This pattern is only a sample of crooked work, but all crooked work is constructed on the same principle.

Fig. 192 shows another curved pattern, a flat bar in the form of a half circle, with a hole at

each end for a bar or shaft. This requires more time and labor to work up so it will stay in shape.

Fig. 193 shows a method which will do very well where there are but a few castings wanted. Three pieces, *A*, *B* and *C*, are cut out of $\frac{3}{4}$ -in. stuff and the joints made as shown at *E E*, or they are made as in Figs. 188, 189, 190 and 191. The grain should of course run lengthwise in each piece. The pieces are got out in the first place a little larger than is wanted, so that the extra stock can be sawed off to the lines, and after it is all sawed the saw-cuts *D D* are made. This job can be made by making a whole ring and gluing it up this same way. After the glue is hard, it is fastened onto a face plate and turned in the lathe. This method insures a true job, and it is a quick way as well. There is some stock wasted, but the saving of time by making it this way pays for the extra stock used. Fig. 194 shows the end view of the pattern, *C* one piece, *B* another, *D* the groove, and *E* the joint of the pieces.

Figs. 195, 196 and 197 show a much better and stronger way to construct this pattern for a standard job. *A*, *B* and *C* are segments a sixth part of the circle, $\frac{1}{8}$ in. thick, with joints *D D* glued. These thin pieces are glued one on top of the other, with the joints of the piece on top coming between the joints of the piece under it, so that the joints will not all come in a line. *A*

PATTERN-MAKING

PLATE XVIII

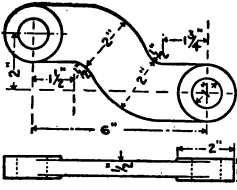

Fig. 187

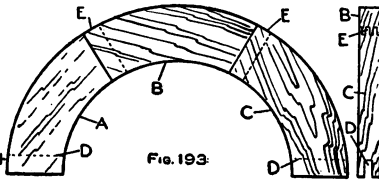

Fig. 193

Fig. 194

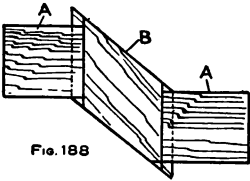

Fig. 188

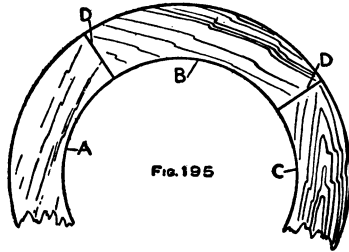

Fig. 195

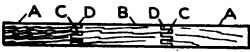

Fig. 189



Fig. 190

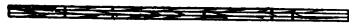

Fig. 196

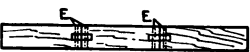

Fig. 191



Fig. 197

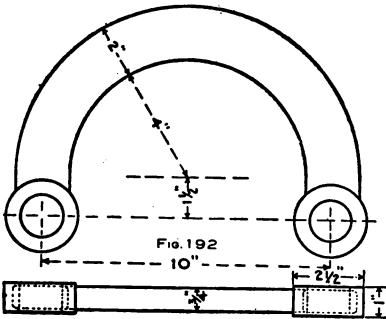

Fig. 192

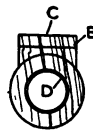

Fig. 198

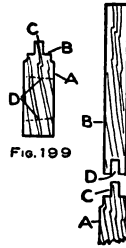

Fig. 199

Fig. 200



whole circle is glued up in this way and turned in the lathe to the right sizes. This ring will be $\frac{3}{8}$ in. in thickness when it is all turned, cut through the center, making two half circles, which are glued together as in Fig. 197. *A A* show the joint line of the two pieces. When these are dry a saw-cut is made in the ends *B B* the same as at *D*, Fig. 194. The ends where the shaft or bar is to go is taken care of thus: Two pieces are made, Figs. 198 and 199, with the grain lengthwise, and the ends sawed at *B* and *C* to fit snugly the groove in the ends of the semi-circular piece. When this has been done, a hole should be bored in *A* as shown by *D*, and a taper made so that when it is drawn out of the sand there will be draft enough to keep the sand from sticking and breaking away. After this has been done with both pieces they are glued into the grooves made for them. Fig. 199 shows the side view of piece *A*, and also shows the draft *D* in the hole. Fig. 200 shows how the two pieces are put together. *A* is the piece with the hole in it, *B* is the large half circle, *C* is the tongue on one piece, and *D* is the groove on the other.

The methods illustrated in this chapter of making curved patterns are good, but for practical purposes a simpler and quicker method is to glue up stock with the grain running lengthwise of the pattern, having three or four layers of stock

for the whole piece. From this glued-up stock the pattern is hewn out as modeled. If the grains of successive layers of stock are parallel the pattern might easily split. Therefore a slight angle of grain in two successive layers is advised. This method saves the trouble of making joints and also of getting a smooth surface on the pattern where the joint comes.

CHAPTER XVII

LARGE PATTERN WORK

THE construction of large patterns is almost a distinct trade. As a general rule a pattern-maker who is an expert on small work does not do so well in making large patterns, and similarly a man who is a first-class pattern-maker on large architectural work or large machine-tool work is likely to be lost on large steam-pump and steam-engine work. In order to be a first-class man on all kinds of pattern work, the pattern-maker must acquaint himself with the various ways in which patterns are made for the special lines of work. To obtain this knowledge, he must make a constant study of his art, and get practical experience, if possible, by working in the different shops where they make special lines of machines, etc.

In Chapter XV, Fig. 174, is shown a drawing for a piece that is the same as described in this chapter, except that it was for a small pattern. A comparison of the two will illustrate how the methods differ in making patterns for a small casting and for a large one. In Fig. 201 a pattern is called for 48 in. long, by shrink rule, and finish added. In making large work for a standard pattern, we make the fillets *F*. (Fig.

202) of wood, which is much better than leather, as it lasts longer and also helps to strengthen the pattern if the wood in the fillet is set in as shown. Fig. 202 shows a longitudinal section through the pattern. In making this pattern get out stock 1 in. thick, cut into 6-in. widths and 47 in. long. In both edges make a saw-cut $\frac{1}{4}$ in. thick and $\frac{1}{2}$ in. deep. The boards are shown by *A* and the grooves by *B*. On the top and bottom boards *C C* make a $\frac{1}{4}$ -in. deep rabbet, as shown at *D*, Fig. 203. This is made wide enough so that the fillet corner running the length of the end when set in will be as shown at *E*. This construction is so that there may be no feather edge to curl up between *A* and *E* while the pattern is in the sand. When the boards have been sawed with grooves and the rabbet made, strips $\frac{1}{4}$ in. thick and 15-16 in. wide are inserted into the grooves *B* in the boards *A* of Fig. 202, so that the boards will all be flat and smooth. The grain of these thin pieces should run across the joint of the boards to strengthen them and prevent twisting. By making the boards 6 in. wide, the surface will stay straighter and keep in place better than if they were wider. The sliding tongue joints should not be glued. Slide the tongue in dry, making a fairly good fit. By so doing the shrink and swell of the wood will not spring the pattern out of shape as would be the case if the joint were

PATTERN-MAKING

PLATE XIX

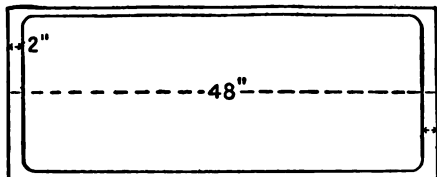

Fig. 201

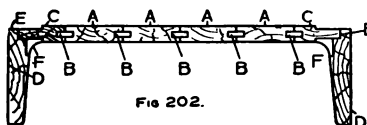
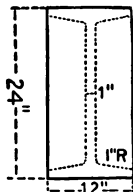

Fig. 202.

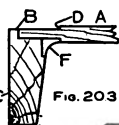

Fig. 203

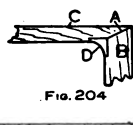

Fig. 204

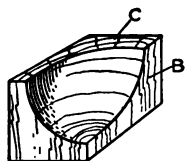

Fig. 205

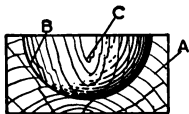

Fig. 207

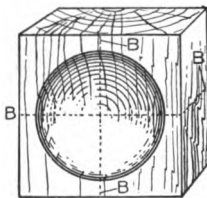

Fig. 206

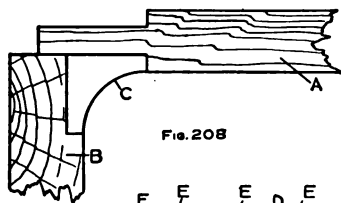

Fig. 208

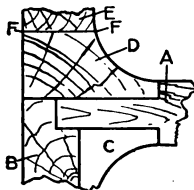

Fig. 209

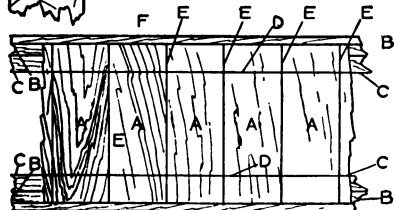

Fig. 211

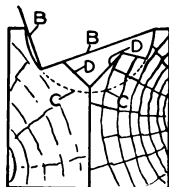

Fig. 210



glued. When making the sides *D D*, Fig. 202, cut in rabbets at *E E* for the corner joint at *C*, also cut rabbets in the sides and ends so that the corner will set in. *F* shows the corner when in place. This should be glued in solidly, and much care should be used in making the joints tight. In Fig. 203 is shown the way they are fastened onto the ribs, with the grain in *C* running at right angles to that in *A*. By rabbeting the end of the sides *C*, at *B*, and not running the boards out to the end, we avoid any end grain of the wood on the outside of the pattern.

Where there is end grain exposed to the damp sand it will become rough and uneven, which will cause the sand to break away and make a rough surface in the mold when the molder draws the pattern out of the sand. It takes longer for the molder to pack the sand around a large piece than a small one, and the flasks after being rammed are sometimes set aside for days for the sand to pack.

Fig. 204 shows the way the sides and ends are sometimes made with the wood as corner fillet. *B* is the end, *C* the side, and *D* the corner. To avoid any end grain at the corners we make a joint as shown at *A*. At the bottom, where the sides and ends come together, a corner is fastened in as shown by Fig. 205. This must make a good match on the three sides, *A*, *B* and *C*, and where

the three sides come together. The corner where the side, end and 1-in. rib or middle piece come together is made out of a solid block, as shown by Fig. 206. This block is $2\frac{3}{8}$ in. square by 1 3-16 in. thick. It is fastened onto the face plate and turned as shown in Fig. 207. *A* is the block and *B* shows the line of the hollow hemisphere that is turned in this block. When turned out it will be the shape of half a ball; that is, a ball 2 in. in diameter will fit in it half way. To make the corner, we saw it on the lines *B B* (Fig. 206), which makes four parts all alike. One of these quarters is shown in Fig. 205. In turning this out make a templet or flat pattern out of a thin piece of wood in the shape of a half circle, the diameter to be the same as that of the hole in the block *C*, Fig. 207. Turn out the stock until the templet fits all around and the entire half circle fits in the hole. When we fasten this pattern together, we make the frame part of it first; that is, the sides and ends are screwed and glued solidly with the corners *D*, Fig. 204, also glued in. Then take the 1-in. grooved boards and lay them on their sides in the rabbet *E*, as shown in Fig. 202, with the corners and the small quarter blocks. All these are glued and fastened solidly with nails or screws. This is the novel part of the pattern; the cope half is loose from it, so that when the cope part of the mold is taken off the

cope part of the pattern will come with it. The corner *C* (Fig. 208) is fastened on two sides. *A* represents the boards or center rib, and *B* the sides or ends. Fig. 209 shows another way of working the side corners, or rounding the angle formed by the sides and ends. *A* is the center rib, *B* the novel half of the pattern, and *C* the corner. Instead of gluing the corner in as in Fig. 208, we make the corner and part of the sides as *D*, Fig. 209, with the side glued onto this at *F F*. Pieces *E* and *D* should be fastened by some joint construction. One can make these corners, if the shop does not have a core-box machine, by using a core-box plane as was shown in Chapter II. Two strips the right width and thickness are screwed together as *A A*, Fig. 210; the dotted line shows the circle that is to be cut as *C*; *D D* shows some of the extra stock cut away so that the plane will cut well, and *B* shows the lines of the plane.

If there is a pattern to make that is, say, 120 in. long, the same width and thickness, the boards should be run transversely, as shown in Fig. 211. *A* shows the boards, *B* the sides or ribs, *C* the corners, *D* the part that is rabbeted down on the cope side, *E* the joint or boards (which, when fastened, should have a little space between them to allow for the shrink and swell of the boards), and *F* the wall left around

so that there may be no end grain next to the molding-sand.

In the next chapter other features of large pattern work will be presented, including the pattern of a piston for a large cylinder. For this, various methods will be illustrated.

CHAPTER XVIII

LARGE PATTERN WORK

IT is time now to consider more difficult work—a piston pattern for a 36-in. cylinder, for example. Like everything else there is more than one way to make it. Fig. 212 shows a section of the casting. Fig. 213 shows a section on *A A*. This pattern is to have six ribs cast inside with a hole through each to make the casting lighter. There are also six holes cored through the casting for the purpose of holding the cores that core out the inside. These holes are also used to take out the core sand after the casting is made. After the casting has been cleaned out in good shape, the machinist plugs up the holes and makes a smooth surface of the side where these holes were.

Figs. 214 and 215 show one method of making this pattern which is well liked in some shops. Saw up strips *A* of narrow stock, say 4 or 5 in. wide. The pattern will keep its shape better by using narrow stock than if wide pieces are used. These strips are for the heads, and all pieces should be of the same thickness. Lay the strips on a flat surface and leave about 1/16-in. space between strips. Mark a circle, say 33 in. in diameter, on these strips. Next make the pieces

B, which are to strengthen the pattern and to fasten the boards *A* together. These pieces are of such a width that when the top and bottom boards *A* are all on, the total thickness of the pattern will be as required. These braces should be so fastened onto the heads that all the boards will stay firmly in place. A pattern of this size should be made as strong as it can be made. Next make the lags *C*, which are glued and nailed around on the 33-in. diameter head as shown. *D*, Fig. 214, is the 33-in. diameter head and *E* is the outside surface, which when turned will be 36½ in. in diameter. This allows finish for the machine shop. After all the lags are fastened on, screw the pattern on a face plate and have it as near central as possible. In Fig. 215 *A* is one piece of the head, *C C* are the lags, *B* the braces that hold the head boards in place, and *D* the thickness of the top head, which is left off in the drawing so as to show the way the braces are fastened on the inside. The pattern being on the face plate, turn it to the diameter wanted, say 36½ in. This way of construction is strong, and the making-up is much quicker than some other ways that might be employed.

Figs. 216 and 217 show another method that will produce a much stronger pattern and one that will stay in place longer than that shown in Fig. 214 and Fig. 215, but takes longer to make.

PATTERN-MAKING

PLATE XX

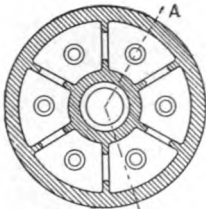

Fig. 212

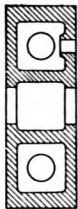

Fig. 213

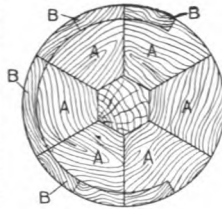

Fig. 216

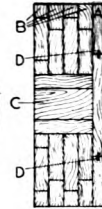

Fig. 217

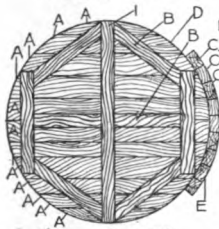

Fig. 214

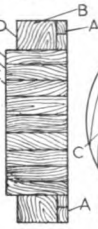

Fig. 215



Fig. 218

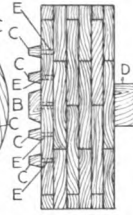

Fig. 219

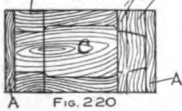

Fig. 220



Fig. 223



Fig. 224

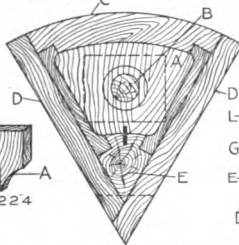

Fig. 221



Fig. 222

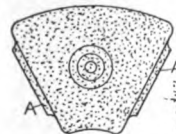

Fig. 225

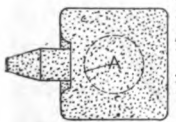

Fig. 226

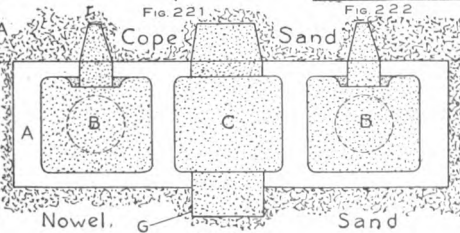

Fig. 226



The heads *A* are one-sixth segments of a circle and are tongued together as shown by *DD*, Fig. 217. These joints are well glued so that they will be strong and durable. Saw out segments *B* and nail them to the heads, using plenty of glue on the joints. The heads should be $1\frac{1}{2}$ or 2 in. thick and the segments 1 in. thick. In constructing this pattern, first make the heads, then fasten one of them onto a face plate, and true up a part of the inside face so that when the segments are glued on they will lie flat. Glue and nail one course, then true off; glue and nail another course and true it off. Continue this until you have the depth required without the top head. Then fasten in a block, *C*, in the center, letting the block be large enough to provide for a good bearing for the center of the heads. Fasten on the top head with nails and glue. The bottom is now ready to turn to the outside diameter and the proper thickness.

To core out the inside is a more difficult problem. As shown in Fig. 212 there are six sections with six small holes cast in or on one side of the piston. Locate the centers of these holes on one of the heads on the outside and see that they are accurately spaced as regards center and diameter. Bore six 1-in. holes, *C*, Fig. 218, about half way through the head; turn six core prints as *C*, Fig. 219, with a pin on the end the

same diameter as the hole, or 1-in., and place them into the holes *E* as shown. These prints should have a good taper, as they come on the cope side of the mold. Next turn the prints for the center core and locate them in the center of the pattern as shown by Fig. 219, where *B* is the cope print and *D* the novel print. We now have the pattern made, and our next move is to make the core boxes.

The center core box is made as in Fig. 220. First make the chambered part *C*, then the two sections that are the size of the core prints, as *B* and *D*. The section *E* is the same as core print *B*, Fig. 219. The two pieces *A* are fastened on the ends as shown. This is a half core box. The core is made in halves and pasted together. If the core were a small one, we could make the core all in one, but on large cores we can not do this, because there is so much more weight to the core, and as the sand is soft it would sag down and cause a flat place on the core when baked. The large core box is shown in Figs. 221 and 222. First make a board that will be used for the base. This board will be the thickness required for the casting to the top of the boss inside of the piston, as shown by *A*. The size and shape of the core are laid out on this board, and the size of the boss is cut out, leaving corners as shown at *K K*. We will next make

the piece *C*, which forms the inside surface of the casting. Some make it out of one thickness of stock while others make it in segments. If the depth is considerable it would not be advisable to make it out of one piece, because it would not keep its shape. Make the sides *DD*, which are to be so fastened on the board *A*, that the core will be a little less than a one-sixth segment of a circle. When the cores are made they swell and are a little larger than the box; therefore we make the box a little small. Glue in a piece, *E*, which forms a part of the inside surface of the casting around the center core. These sections of the core are made with one-half the thickness of each rib on each side of the core box, as *F*. They have a hole through them as shown by *J*. The lower half of this rib can be made fast in the box, but the upper half has a joint at *L*, so that the core can be taken out of the box. A piece is cut into the box as shown so that this top half will stay in the proper place and also make a corner. Fig. 223 shows this part of the rib more clearly than Figs. 221 and 222. On the bottom of the base board *A* cut a hole the size that the small core prints are at the bottom of the taper, and make a block the thickness of the core prints. Cut a hole through it the same shape and size as the prints *B*. The block is shown by *H*, Fig. 222. Fasten a piece of the same thick-

ness as *H* at one end, at *I*, to have the box set level when it is being filled with sand. After the box is filled with sand the top edge is rammed thus: Take a small piece of hard wood with a radius cut the size of the corner wanted, as shown by *G*. Fig. 224 shows the shape of the piece. *A* is the corner and *B* is the kerf that acts as a guide for sliding the piece around on the top of the box, as shown in Fig. 222. Fig. 225 shows the core when taken out of the box. The surfaces *A* are the points where the cores come together when they are set into the mold, and they are on a circle as shown by *A*. All cores are set into the cope part of the mold as shown in Fig. 226. *A* is the space that metal flows into, *B B* are cores made in the box shown in Fig. 221. *C* is the center core, which rests in the space in the novel part of the mold at *G* made by the core prints. The joint line of the mold is shown at *D D*, Fig. 226.

CHAPTER XIX

CROSSHEAD GUIDE PATTERNS

A CROSSHEAD guide pattern is constructed as follows: We will suppose the drawings call for a pattern 6 ft. long with a barrel 24 in. in diameter. Fig. 227 shows the design of the casting and Fig. 228 shows a section through *A A*. This pattern is made similar to cylinder barrels. Fig. 229 shows one half of the pattern cut longitudinally and vertically through the center. It is a split pattern, the two halves being doweled together with the fastened pins in the cope half. Fig. 230 shows a section through this half. To make the pattern one first gets out the heads *A* out of 2-in. stock. There should be about four of these for a half pattern for this length, and they should be made with the grain as shown in Fig. 230. These are for the main barrel. The core prints *D* and *E*, Fig. 229, should have the heads made the same way. The joints for these heads can be made as shown in Figs. 35, 38 and 39 of Chapter IV, but the strongest and most durable way is as shown in Fig. 39. When the heads are glued up for the main barrel and core prints, lay off on one head the size or diameter of the pattern that the barrel is to turn, then mark inside of this the size and

thickness of the lags you are going to make, say 2-in. stock, and make them about 3 in. wide or more. Mark flat places on these heads where the lags are to be nailed on. Saw one out and use it as a templet for the others. Do the same way for the core print heads. Then cut a notch 2x5 in. in the center of each head, to receive a piece this thickness and width that runs the whole length of the pattern *B*, Fig. 230. This is for making the pattern stiffer and stronger; it also is convenient for rapping and drawing the pattern out of the sand. Fasten the heads by screws onto this strip in the desired locations. Nail the large core print lags on *D* (we will saw out the lags for barrel and prints, and also the segments for the small end while we are getting out the stock for heads and other parts); then nail the barrel lags to the heads. Nail the segments *B* (Fig. 231) to the end as shown. Make these segments about 1 in. thick and nail them, using also plenty of glue; then fasten the lags for the small print by nailing and gluing.

The next operation is to prepare the pattern for the lathe. The two halves are pinned together and a good joint made. Dog the two halves together and screw onto the large print end a center as shown in Fig. 66, Chapter VI, which is the end of the pattern that is next to the head end of the lathe. On the other end we will

PATTERN-MAKING

PLATE XXI

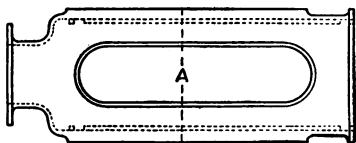

Fig. 227

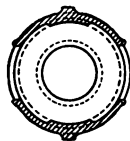

Fig. 228

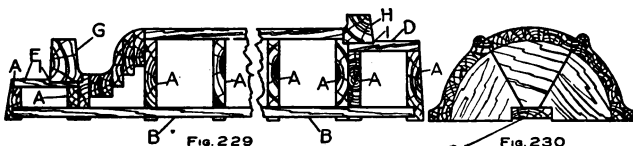

Fig. 229

Fig. 230

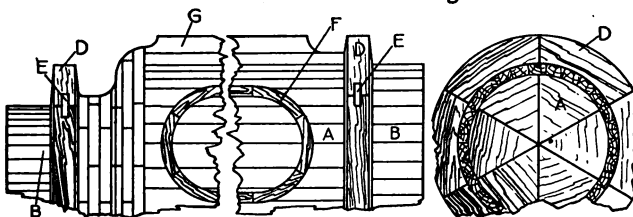

Fig. 231

Fig. 232

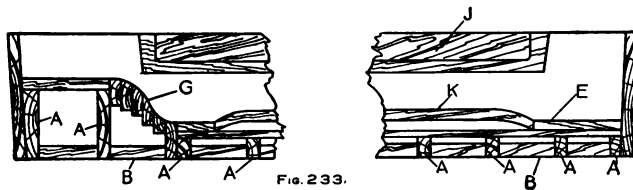

Fig. 233

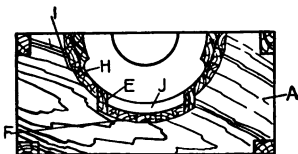
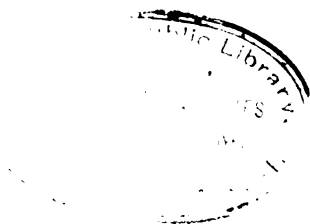

Fig. 234



screw on a center as shown in Fig. 67 of the same chapter. On the head end of the lathe we screw on a chuck (Fig. 68 of Chapter VI), which is used for this kind of work. Now we have the pattern in the lathe and it is ready to turn. It is a good plan to lay out on one half of the pattern, before placing together on the joint, the exact shape and size that the pattern should be when turned. With a knife cut to this line so one can easily tell when turning when he reaches the line. This saves the use of calipers and templates, and if the turner is careful will be quite as accurate a method to follow. When turning, cut in a place to receive the flanges *G* and *H*, Fig. 229. They should be set in as shown at *I* to make a stronger joint. The flanges are made in segments and fastened as shown by *E*, Fig. 231. The inside diameter is sawed out the same size as the groove turned in the pattern to receive them. They are then glued and nailed into place and turned to the thickness and diameter wanted. To prevent a feather edge on the corner fillet, set in a piece as *F* and *G*. After the glue is dry, work out the corner. Figs. 231 and 232 show the pattern when made. *A* is the barrel, *B B* the core prints, *C* the section that is made in segments, *D D* the flanges, *E E* the joint used for flanges, *F* is the rib around the hole that is cored through the barrel, and *G* the piece

that acts as a rib under the ways that the cross-head slides on. The pattern is now ready for the varnishing.

We will now start on the core box. A half core box only is needed, as the coremaker will make two cores from the box and paste them together. Figs. 233 and 234 show the box. In making the box make heads *A* and cut out the shape as shown in Fig. 234 for the barrel. For the small core print end the heads will be cut smaller. Nail and glue lags onto heads as shown, up to the neck that connects the large and small diameters. Plane this out to the size and shape desired the whole length. Glue up the segments on a face plate so that one can turn the part as shown by *G G*. After it is turned cut in two parts so that one-half will be just half the circle. Glue and screw this on the end as shown, and fasten on the heads for the small core print. There are also strips running the whole length, as *B B*, to strengthen the box and hold the heads in place. These strips should not be less than 2x5 in. Screw these to the heads securely. Fig. 234 at *J* shows the thickness of metal. At the ends where the half circle part of the bead or rib comes on the outside of the pattern, it is cored through, and the part *J* is filled in up to the line *E*, Fig. 233. This provides for a continuous surface of the casting marked by line *F*, Fig.

234. *F* shows the shape that is left in Fig. 233. The ways that the crossheads work on must come out loose, and when the core is dumped out on the plate they are taken away. *J* shows the piece which is set into the barrel as *I*, Fig. 234, and the corner is made on this same piece as *H*. The ends have a bevel so that it will come out easy. The ends *I* and *H* are screwed on, making the box complete. In making large work the pattern worker cannot make it too strong, for there is a large body of core sand in the box which makes it very heavy to handle. A large box like this can not be turned over by hand, but a crane is used, and it is apt to get some rough handling. Therefore, make the box as strong as possible. The heads are sometimes strengthened by pieces glued and screwed on one side across the grain. On very large work it is advisable to do this. The pattern-maker need not fear he will have too many heads. They may be 18 in. apart measured lengthwise of the barrel part of the box.

CHAPTER XX

SWEEP WORK

WHEN making flywheels of large diameter, say 20 ft. or more, it is not customary to make a whole pattern, as it is not profitable or necessary. The large amount of time and lumber used in making so large a pattern would be too costly. In making patterns for large castings of this nature, a section of the wheel is made, and the molder does the rest by moving this section around segment by segment until he has completed the circle. This class of molding is called sweep work.

Figs. 235 and 236 show a 20-ft. flywheel with arms cored out and cast in halves. Fig. 237 shows a cross section of the arm and Fig. 238 a longitudinal section. In making this pattern we first make the outside of the arm, as shown in Figs. 239 and 240. Beginning by making the bottom and sides of a box, *A* and *I*, Fig. 239, we fasten strips across the bottom, *J*, Fig. 240, to keep the board straight. The depth of the sides should be the distance from the center of the arm to the center of a bolt hole on the hub, as will be seen later. We will now make a pattern for half of the arm, *B*, Fig. 239, from *F* to *E*, making the joints at these points. This part can

be planed with a hand plane to the required sizes. It is fastened to the bottom board, as shown in Fig. 241 at *B*. Next make the section at the hub end of the arm. This wheel has eight arms, and the angles at this end should be such that when all arms are laid into place they will all fit and exactly complete the hub. The pieces that make this are shown by the boards *G G* in Fig. 239. The diameter of the hub is shown at *H*. These sections should be screwed together and not glued, because they may be used many times for different sizes of wheels by moving on the bottom board so as to make the arm the required length. The rim end is shown at *D*. This is also screwed to the bottom board so that it can be moved to suit the length of arm wanted for a larger diameter wheel. Figs. 240 and 241 show sections of the core box for the arm. There are two cores made in this box to make one arm. Parts of the boss on the hub have to be made in this arm core, *K*, Fig. 242, which fits onto the surface or perimeter of hub at *H*. On this piece there is a core print for a cored hole in the casting to be used as a bolt hole. Both right and left-hand core prints are provided. Fig. 243 shows this piece as located. The box that cores out the inside of the arm is shown by Figs. 244, 245 and 246. Cut out the arm, *A*, between *E* and *D* (Fig. 245), and fasten in a piece, *F*,

which is to strengthen the arm at this point. Cut out the print *G* at the hub end *C*. This print is used to support the center core for the shaft hole in the hub. Make the rim end of the box which is shown by *B* by having the grain of the wood in *B* crosswise, as shown. The piece *F* is fastened into the hub part to strengthen the arm at this point. Screw these sections onto a board, *A* and *L*, Fig. 245. The hub end of this core is beveled the same as the outside of the arm in the pattern, *H H*. When molding this pattern a section of the rim is made as shown in Figs. 247 and 248, with the inside diameter the size of the wheel and the depth a little more than the face of the wheel. This provides for a guide when the core for the outside of the pulley or wheel is set. This section has two pieces of board, *B B*, fastened on the top with one end as shown in Fig. 249, the other end projecting over so that a brace, *C*, can be fastened for holding the lower part of the sweep in place when it is rammed in the flask. It will be noted that only a part of the hub was made in the arm box. For the other part a core box as shown in Figs. 250 and 251 is used. This box has a bottom, *A*, and sides and ends, *B*, for half of the hub, with bosses for bolts and the hole through them. *C* is the part of hub, *G G* the bosses for bolts, *F F* the core prints for the core that cores the bolt holes, and *D D* are pieces that

PATTERN-MAKING

PLATE XXII

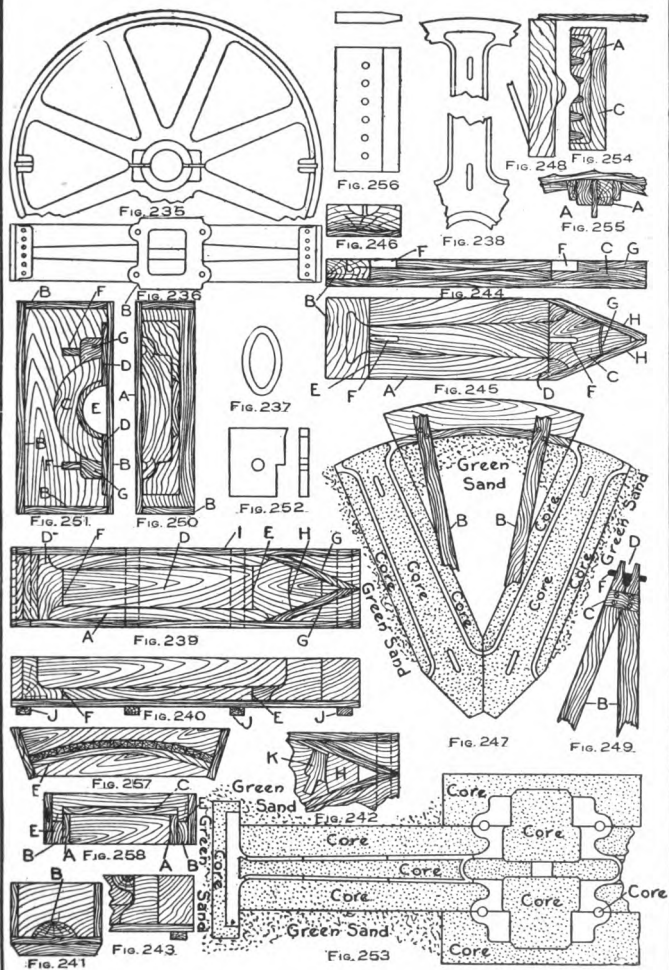

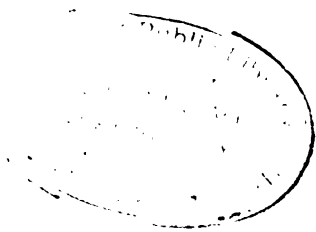

make a place to receive a cast-iron splitting plate as shown by Fig. 252. *E* is a print to locate the center or shaft core.

When the molder starts to mold this wheel, he lays the hub cores at the bottom and the arm cores on top, as shown by Fig. 253, laying the eight around in their proper places and then locating the sweep section between the arms, as shown in Fig. 247. Everything is centered from a spindle, *O*, to which the end of the sweep is fastened with a notch cut in the surface of the spindle *D*, Fig. 249. The pin *F* is for holding it in place. *C* is a piece fastened on the ends for strength where the boards *B B* come together. The lug for bolting the wheel together on the rim ends is a piece made as shown in Figs. 254 and 255. *A* is the piece that fits the rim on the inside, with core prints fastened on to receive cores the size of the hole wanted. Print *C* is fastened on to receive the splitting iron, Fig. 256. When molding, these are located in the proper place by the molder. When the mold is finished the small cores are placed in the holes of the splitting iron and set into the mold and the sand packed in to fill up the space left by the heel core. The main cores are set in place, and splitting irons for the hub are also placed in the cores. The rest of the cores are put in their proper places as shown in Fig. 253. When past-

ing the arm cores together chaplets are placed between the cores so that there will be an even thickness of metal all around, and also to hold them in place. Chaplets are small irons or lugs used to locate or fix cores.

The part of the mold made for the rim or outside of the wheel is made to receive a core also. Figs. 257 and 258 show the box for making the cores for the outside of the pulley or wheel. Make the two pieces *A A*, Fig. 258, and nail lags *C* on to them. Work to the size of the outside of the wheel. It does not make much difference how many of these sections are made, but they must come out even when all are placed around on the circumference. Then make two pieces, arcs of the circle, just the thickness of the rim of the wheel, and fasten them onto the ends of the pieces that the lags were nailed to, as *B B* and the circle *E E*. Next fasten on boards for the ends and sides *D D*. This is filled with core sand and dumped out onto a plate to bake and fasten on the face *F*.

The rim of the wheel is made by sweeping a circle in the mold at the extremity of the arms. This circle will be the depth and thickness of the rim of the wheel. It will be made by a special sweep of the shape of a cross section of the wheel rim and will be revolved on the center spindle as was the arm sweep.

CHAPTER XXI

PIPE WORK

IN shops where there are engines and pipe fittings to be made, it often happens that pipes of large diameter are wanted, and wanted quickly. They are made in odd shapes and are not used many times. In a case of this kind it is necessary to make the pattern as quickly and cheaply as possible. The time and expense in making this class of work should be as little as possible. Patterns of half circles and bends can be made like the one described in this chapter.

In Figs. 259 and 260 is shown a drawing of a straight pipe 14 ft. long and 12 in. in diameter. In Figs. 261 and 262 is shown the construction of this pattern. Our first operation will be to lay out the shape of the pipe and the prints on a board. Dowel this to a second board the same thickness. Then band-saw to the outline, which in size is the same as the pattern on the outside. This board is shown by *A*. Now we will fasten onto a face plate two pieces and have the center line of each located exactly on the center of the face plate, so that when turned they will both be alike. The pieces should be thick enough to turn the corner or fillet that connects the straight part of the pipe with the flange. After four of

these have been turned, fasten them onto boards as shown by *B B*. The distance of these apart is the length between flanges that the drawing calls for, allowing for finish and shrinkage. The core prints *C C* can be sawed on the band-saw and fastened onto board *A* up to the flange as shown. Slightly bevel the edges of the board between the flanges to conform to the surface of the outside of the pattern.

This finishes the main part of the pattern, but to make the circle of the pipe between flanges we make a piece as shown in Fig. 263, called a strike. This can be about $\frac{7}{8}$ -in. thick, long enough and wide enough so that there will be stock left after sawing out the half circle *B* (which has the same outside diameter as the pipe) to make it strong. The points *C C* should be on the diameter of the circle.

This does not look much like a pipe pattern, but from this a molder can make a good casting. It requires more time in the foundry to make a casting from a pattern of this kind, but as there are only a few castings wanted it is cheaper in the end to make it this way than if a regular pattern were made.

It does not require quite so much time to make this kind of a straight pattern for a straight pipe as it does for odd-shaped pipes. Now the molder, when starting to make the casting, first

PATTERN-MAKING

PLATE XXIII

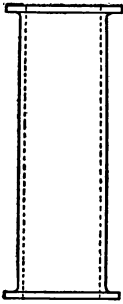

Fig. 259

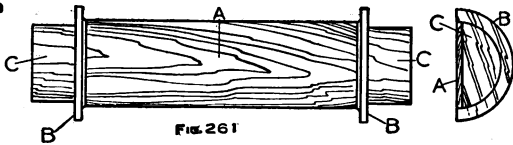

Fig. 261



Fig. 262

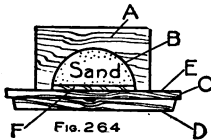

Fig. 264

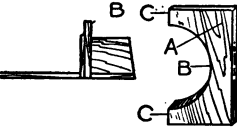

Fig. 263

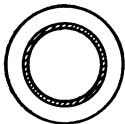

Fig. 260



Fig. 265

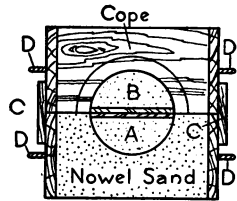

Fig. 266

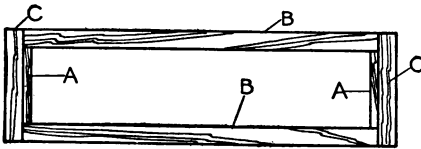

Fig. 267

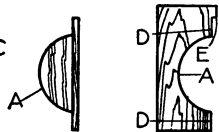

Fig. 268

Fig. 269

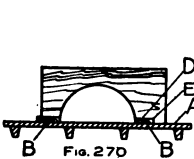

Fig. 270

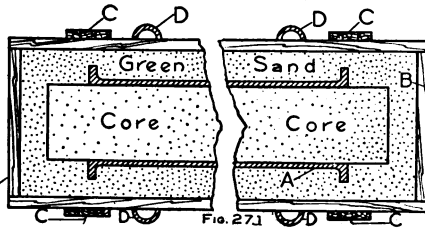
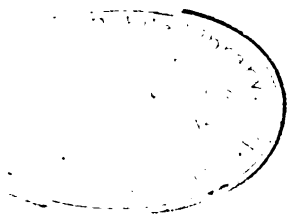

Fig. 271



obtains a board called a mold board, or bottom board, long enough and wide enough to lay this pattern on together with the flask. This board has cleats on the bottom as *D*, Fig. 264, to keep it straight, and the top surface *E* is flat and straight. The pattern is placed on this board as shown, and the molder packs sand over the board *F*, shaping it with the strike *A* to form the half cylinder of the pipe size, as *B*. Now this forms the same shape and size as we would have if the pattern were made up entirely of wood. After this has been done, the novel half of the flask is placed on top of the mold board, as *A*, Fig. 265. Newspaper is next put smoothly over the green sand, which acts as parting sand (*B*), and the molder fills the flask with sand over the newspaper, which forms a mold of one-half the pattern. After this has been done, the flask and pattern are turned over, and the other section of the pattern placed on top of this, which has been packed with sand and the newspaper put smoothly over it. The sand is packed around this part the same as was done on the first or novel part of the mold. Fig. 266 shows the second operation: *A*, the novel part of the pattern; *B*, the cope; *C*, pieces nailed on to the sides of flask to act as pins for the flask, and *D*, hooks used to lift the flask off from the bottom half and also to lift the mold from one piece to another.

After this cope half has been rammed up with sand, it is taken away and the pattern drawn out of the sand. The wood part of the pattern is the part that is drawn away, as the sand that we first packed on top of the board *A* (Fig. 262) will be left in the mold. This is taken out easily, as the newspaper forms a separation between the sand of the mold and the sand that forms the pattern. The same operation is performed for the nowel half of the mold. When all is taken out a hole is left in the sand the exact shape and size that an ordinary pattern would make.

If a regular pattern for this were made, a great deal of lumber would be used unnecessarily, and also much time would be required to make the pattern, such as sawing out the heads and lags and nailing them on, turning, rapping plates, and other little things that take time. It is not advisable, however, to make a pattern this way if there are many castings wanted, because the extra time that the molder has to use in making the mold would soon eat up the difference in cost in making a regular pattern.

Our next move is to make the core box. This is shown in Figs. 267 and 268. There are two heads sawed out on the band saw, of the diameter of the bore of the pipe, as *AA*. There are then two boards or strips made, *BB*, that are of the same width and about $\frac{7}{8}$ in. thick, with the

inside tapered a little to conform to the cylindrical surface of the core. Next two more pieces are made, *C C*, which are used to hold the heads and pieces *B B* in place. These are sometimes halved in and sometimes screwed on top of pieces *B B*. Either way will do as long as they hold the heads in place. Make a strike, Fig. 269, used to form the half-circle cylinder of the core. *A* is the diameter of the core. A place is made in one end, as *D* and *E*, which is the depth of the strips *B B* in thickness, and the point *E* is so located that the edge of strips *B B* will act as a guide for this point to slide on. The surface *D D* slides on top of the strips so that the ends of the circle on the sweep will match the inside edge of the strips *B B* and will form a true circle, which is one half of the core. In making this core, the coremaker lays the frame on an iron plate, *A*, Fig. 270, with the heads up as shown, and packs sand between these heads. The strike is then moved along on top of the strips and guided by the places cut out, as *D* and *E*. This forms the core, and the frame is lifted off without disturbing the core. This is quite an item, as turning over a box with a core in it of this size would be quite a difficult job. The other half of the core is made the same as the first. The inside of the sweeps should be bev-

eled some to make a cutting edge to strike off the sand.

A section of the mold when it is ready to have the metal poured into it will look as shown in Fig. 271. *A* is the space that is left for the metal and makes the size and shape of the casting. *B* is the flask, *C* the pieces nailed onto the sides to act as pins, *D* the hooks for moving the flask. This drawing shows plainly and without further explanation, how the mold looks. It must be remembered that Fig. 271 is the view one gets when looking down the lower half of the mold.

CHAPTER XXII

STOVE PATTERN WORK

STOVE pattern work differs somewhat from ordinary machine patterns, because the metal in stove castings is thin, and if the patterns were made the thickness of the casting they would not be durable. Every large stove manufacturer has new designs each year for his stoves and furnaces. To obtain these new designs the manufacturer usually makes models the exact size and shape of the new designs.

These models are framework filled with plastelina, a sort of putty made out of clay, olive oil and wax, which can be worked into any shape and does not harden. This clay or plastelina is placed on the frame and worked into any shape that may suit the fancy of the designer. Nails are driven into the frame so as to hold the clay in place. The doors and covers and all loose parts are not made separately, but all are shown in the one-piece model. After the stove has been designed the draftsman picks out each part and makes a drawing of it for the pattern-maker to work from. The metal in stove work runs about $\frac{1}{8}$ in. in thickness and it is in odd shapes. When making a pattern the exact shape and size of the casting, the outside of the pattern is made first;

then the inside is modeled, leaving the pattern of uniform thickness. This point is very important, for the metal must be the same thickness in all places that it may expand and contract uniformly to prevent crocking. A form is made that fits the inside of the pattern at all places, so that when the molder rams up the mold the pattern will not spring, but will keep its shape. Nearly all stove shops have their patterns made of metal, as these last much longer than those of wood. But this does not concern the pattern-maker, as wooden patterns are always required first from which the metal patterns are cast. Patterns for this class of work should be very smooth, for if they are not it is difficult for the molder to obtain a smooth casting. The metal patterns, too, have to be smooth. In fact, the most elegant patterns today are made for stove work. If the patterns are well made there is little difficulty in making good castings. The reason for this is that on smooth patterns there is little danger of the sand burning and sticking to the metal.

Figs. 272 and 273 show a stove cover, apparently a simple piece to mold, but it has caused the foundryman considerable trouble on account of the wavy surface, or "rat-tails," as they are sometimes called. These are caused by the metal running imperfectly. Fig. 275 shows a

PATTERN-MAKING

PLATE XXIV

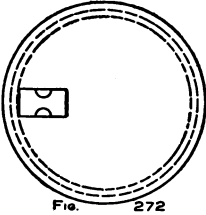

Fig. 272

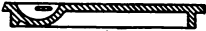

Fig. 273

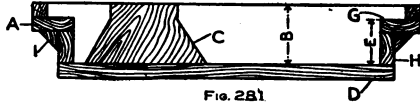

Fig. 281

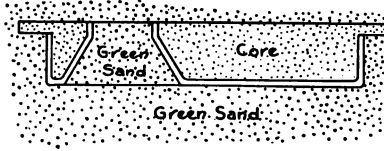

Fig. 282

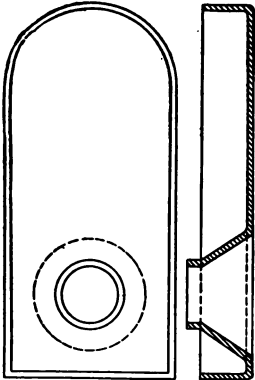

Fig. 277

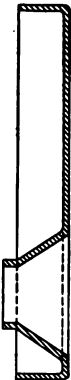

Fig. 278

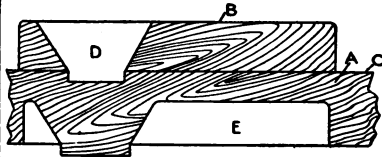

Fig. 279



Fig. 280

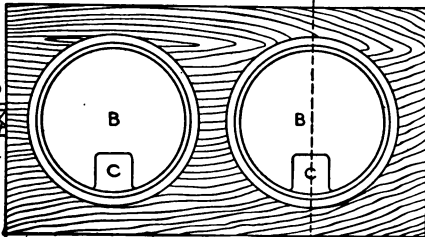

Fig. 274

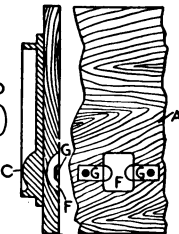

Fig. 275 Fig. 276



section through *A A*, Fig. 274. We first make a board, *A*, say about 1 in. thick, with strips in the end to help keep it straight and true. We then fasten on V pin guides, *D* and *E*, which are for guiding the pins on the flask. This board is called a pattern plate. Two patterns are made of a stove cover as *B B*, with lugs inside of them (*C*, Fig. 275) to form the cavities or lifter holes. After these have been made a thin sheet of polished steel plate is fastened onto this pattern plate, completely covering it, and the patterns for the covers are fastened on top with the flat surface down. This makes an excellent surface for the tops of covers. On the other side of the pattern plate, directly opposite the lugs *C C*, there is a cavity made as shown at *F*, Fig. 275. There are small projections, *G*, which form the lugs for lifting the cover. These are set in the plate *A*, as shown in Fig. 276. The molder when making this mold first lays the plate on the table with the cover pattern up, which is the inside or bottom of the pattern. A snap flask is placed on top of this plate, which is the novel part of the mold, and sand is rammed quite hard around the pattern. A bottom board is then placed on top, and the flask with the plate turned over. The plate is then drawn off, which leaves a hole in the sand the shape and size of the inside of the cover pattern. This pattern plate is then

used on the other side, and the cope part of the flask is placed on top of it and rammed up with sand. The sand on this side is not rammed hard, but softly, so as to prevent the wavy or "rat-tail" surface. After this has been done the cope part of the flask is taken away, and the pieces that make the projections come with it. These are then drawn out of the mold, and the cope half is made. When the flasks are placed together these lugs for the lifter come opposite the lugs *C C*, leaving space for the metal. Small parts of stove work are thus made on plates, which is a very practical way, as it is much easier for the molder to handle them than if there were a loose pattern for each piece.

Figs. 277 and 278 show a door-lining for a furnace. Now if this pattern were made in a thin shell of wood, it would not last long, because it could not be constructed strong enough to stand the foundry wear and tear. It could be made as shown and one or two castings made from it, and a metal pattern made from these castings which would be reasonably durable.

Fig. 279 shows how a casting is obtained from a pattern. A board, *A*, is made thick enough for the cavity *E* to be cut out of it, which forms the inside of the lining. This board is made large enough for two or more linings to be made in the same flask, with V pin guides on the ends the

same as on the stove-cover plate. The surface, *C*, is the joint line of cope and nowel. There is then a piece made, as *B*, which forms the outside of the lining, and this is fastened on the other side of the board or plate with a hole made as *D*, which is enough smaller than the wooden lug in *A* of the same shape to leave a space the thickness of the metal, or $\frac{1}{8}$ in. all around, in which the metal runs. This is rammed up the same as the stove cover, and the flasks placed together in the same way.

Figs. 280 and 281 show another method for this class of work when there is to be a separate pattern for a casting, and more than one thing can be made in the same flask. In this the cope part of the mold is only a flat surface. This is a much quicker way to make a pattern of this sort, and is used quite extensively for thin work. To make this pattern a block is worked out the size and shape required for the outside of the casting, *A A*, Fig. 280, and a piece is fastened on top the thickness that the round part (or door opening) projects above the top or front of the casting, *A*, Fig. 281. This is a core print as shown by *B*, Fig. 280, which projects outside the main part of the pattern all around, as *C*. A hole is cut into this the size of the hole in the casting. We then make a core box as shown in Fig. 281. A board, *D*, is the base, with *G* and *H* glued and

nailed onto it, which forms the inside of the casting and is made $\frac{1}{8}$ in. smaller all around to leave a space for the metal when the core is placed in the mold. *C* is a piece fastened in, which is really a core, to form the space for the metal surrounding this round part or furnace opening. *A* is the depth of the core print; *B* is the depth from the inside of the casting to the top of the core print, and *E* is the depth of the body of the casting. *I* are corner pieces nailed around to strengthen the core box. Fig. 282 shows the way the core is set into the mold and how the space is made to make the proper thickness of metal. The core rests on the green sand formed by the projection of the print on the pattern. This guides the core and makes the uniform thickness all around.

CHAPTER XXIII

MOLDING-MACHINE WORK

MOLDING-MACHINES are not a foundry luxury today, but a necessity where many castings are required from the same pattern. The foundry managers today are required to produce a large number of castings at little cost. In order to obtain this result, the introduction of some type of molding-machine became a necessity. There are a great many makes of molding-machines, and practically every line of small castings can now be economically modeled by either hand or power molding-machines. The progress in the development of the molding-machine the past few years has been great, and all the large and modern foundries are making castings or molds on machines. The opposition of skilled molders to machine-molding is rapidly disappearing, and today the molding-machine is operated by the highly skilled workman as well as the ordinary foundry laborer. The molding-machine is a benefit to both employer and employee, giving to the manufacturer cheaper and better castings; to the workman a bigger day's pay or an easier day's work.

A common form of molding-machine is called

a molding press, or squeezer. These are used for small and plain molding. They press the sand to an even hardness all over the pattern and are used quite extensively in large foundries. On molding-machine work a flask called a snap flask is used as shown in Figs. 283 and 284, constructed of hard wood with iron trimmings. *A* is the wood frame, *B* the pins and ears. The pins are sometimes round and sometimes V shape. There are hinges, *C*, on one corner, with a snap and locking device as *D*. When the mold is made, the flask is taken away and used for the next mold. These flasks are made for round work and irregular parting. They are grooved out on the inside so as to hold the sand in them, and in some makes of flasks studs are fastened on the inside to prevent the drag from slipping down. An iron band is placed inside the flask, which helps to hold the sand together.

Fig. 285 shows a small design for a casting where a large number of castings are wanted. To make this on the molding-machine, ten patterns are made all alike and fastened onto a thin sheet of iron or brass, as shown by Figs. 286 and 287. *A* is the plate, with two holes *C* in each end for the pins *F* (Fig. 284) of the flask to fit, and which are the same distance apart as are the pins *F* on the flask. The patterns *B* are fastened on one side of the plate, as shown. Both hard-

PATTERN-MAKING

PLATE XXV

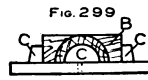
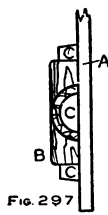
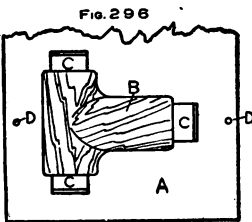
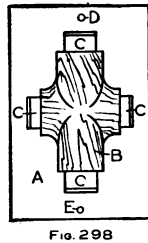
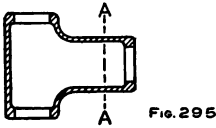
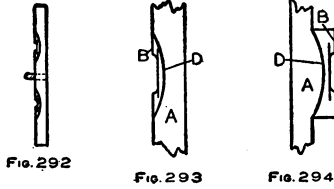
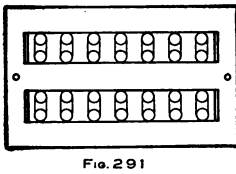
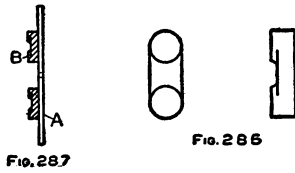
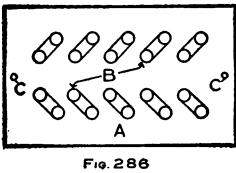
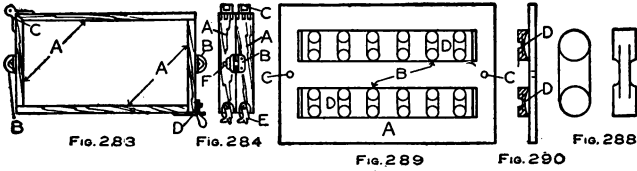



wood and metal patterns are used. As this pattern is flat on one side, there is no cope part of the pattern to fasten on the plate, and the whole pattern is made in the nowel or drag part of the mold. This class of work is usually made on a press or squeezer machine. The molder first places the plate with the patterns flat part down and in the center of the table; he then places the nowel part of the flask on top with the pins through the holes *C*. He then fills the flask full of sand, peening or tucking around the edge of the flask with the rammer if necessary. He next strikes off the level and places a bottom board squarely on the mold. With the left hand he pulls the presser top forward and with the right hand works the lever for pressing the sand. Then he turns over the flask and the pattern plate and places the cope half of the flask on top of the plate and nowel part of the flask, fills this full of sand, strikes off the top, places a presser board on top and works the lever the same as before. After this has been done, he draws off the cope part of the flask and takes the pattern plate out of the nowel flask, and the gates are made for the metal. The lugs to form the gates are usually made and placed on the sheet iron with the patterns, so that when the plate is drawn away the mold, including the gates, is made, which saves time for the molder.

Fig. 288 shows a similar design of casting wanted, only there are webs on each side as shown. These are fastened onto a plate, but the plate is made differently, as shown in Figs. 289 and 290. A section of the plate is made with an arc of a circle and fastened onto the plate, as *DD*, Figs. 289 and 290. *A* is the plate, *B* the part of patterns, and *C* the holes for the flask pins to fit into. The arc *D* is made so that the outside edge of webs and half the thickness of the pattern will be on this plate as shown. Now the other half of the pattern is made on another plate, as shown in Figs. 291 and 292. A section of a circle is cut out, having the same radius as the arc on the first plate, so that when the two parts of the mold come together they will match. In this cut-out part the second part of the pattern is placed, and much care has to be used so that the two parts will match up exactly and so that the casting when made will not have any ridge around it on the joint line between the parts of the pattern. This plate has two pins in it to fit the other half of the flask. An enlarged section of the pattern and the plate is shown in Figs. 293 and 294. *AA* the plate, *BB* the part of pattern, and *DD* the part of the circle that the pattern is fitted onto.

Fig. 295 shows a design for a casting where a large number of castings are wanted. This

pattern is made in halves and each half fastened onto a plate. One half is shown on one plate, as in Figs. 296 and 297. Sometimes one half of the pattern is fastened on one side of the plate and the other half on the other side, so that both halves of the pattern are on the same plate. *A* is the plate, *B* the pattern, *C C* the core prints, and *D D* the holes for the flask pins. Much pipe work and many irregular but symmetrical patterns are made on the molding-machine in this way. The core box for this pattern is made the same as for any ordinary pattern.

Figs. 298 and 299 show another design of pattern for which there need be only one half of the pattern, as it is symmetrical on two axes. This half of the pattern is placed onto a plate, and much care must be used in placing it centrally so that when the two molds are made they will match all around. This plate, *A*, is made of wood or sheet metal; *B* is the pattern, *C* the core prints, *D* a hole for the pin on the flask, and *E* a pin for the ear on the flask. The flask for this kind of molding has the pin on one end and the ear with a hole in it on the other. When the two molds are made the flask, when joined, is turned around so that the flask fits together. Almost any piece with exactly corresponding ends and sides can be made successfully in this way.

Molding-machine work, it should be stated here, is extremely particular, and the measurements are very close. A little offset in the pattern will show up badly on the casting. Molding-machines are now made to accommodate most patterns, large or small work, and regardless of shape. In the next chapter the molding of pattern work by machine is taken up in a general way.

CHAPTER XXIV

MOLDING PATTERN WORK

IN the preceding chapter I showed some of the work done on what is called a press or squeezer. These machines are used principally for flat and plain patterns. In this chapter I will describe and illustrate the stool and stripping plate work. The important point in machine molding is to obtain a perfect mold that does not need patching. The trouble in molding is that, when you draw away the pattern, the sand in places breaks away and causes patching. The makers of molding-machines have devised different devices to overcome this difficulty. Some have fitted their machines with vibrators, some turn over the mold, but the most favorable method used is that of the stripping plate. Some machines are made so that the pattern is drawn through the stripping plate and some are made that strip the pattern and raise the sand and flask up away from the pattern, which is stationary. On the whole this last method is the most satisfactory, because the stripping plate is the most efficient and certain. The stripping plate can be used for flat or crooked joints, or simple entangled joints. Molding-machine work is very

interesting as to the pattern-making part of it, and there is always something to learn.

In Fig. 300 is shown a drawing of a piece that is to be made on the molding-machine. I will show how it is made and the way it is worked for a machine that draws the pattern through the stripping plate. *A* in Fig. 301 is the pattern. The length of the two feet, *RR*, is the same as the distance from the face of the plate at *CC* to the top of feet *R*. *BB* is the stripping plate. There is another plate, *E*, which is called the stool plate. There are legs, *FF*, which are fastened on the top of this plate and made the length that the stripping plate is required to be above the plate *E*. The distance between the plates is not always the same. The height of the pattern to be made determines the length of pieces or legs *F*. There is the stool plate, *D*, which has the same shape and size as the slot in the pattern. There is a leg, *G*, which locates this in the proper place. The top surface of this stool *D* is in a line with the surface *CC*. These legs are fastened on the surface of plate *E* as shown by *I*. There are two rods, *HH*, which are screwed into the pattern as shown by *JJ*. The other ends of these rods are fastened onto a table that is worked up and down equal to the distance that the pattern is required to be lowered. The pattern in this figure is set at the desired height. The plate

PATTERN-MAKING

PLATE XXVI

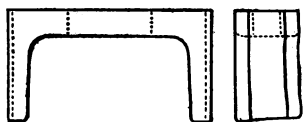

Fig. 300

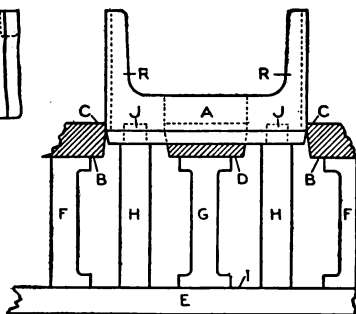
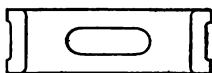

Fig. 301

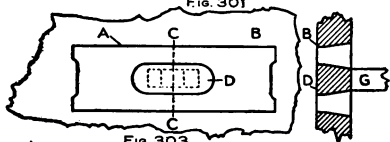

Fig. 303

Section CC

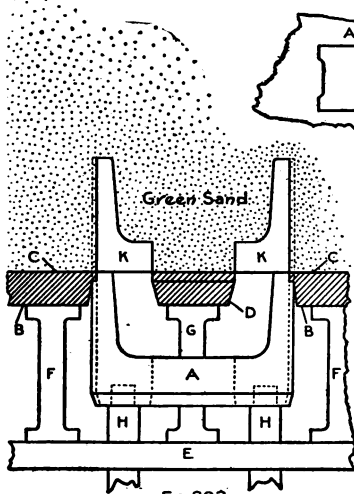

Fig. 302

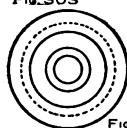

Fig. 304



Fig. 305

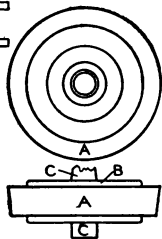

Fig. 306

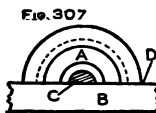

Fig. 307

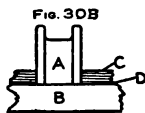

Fig. 308

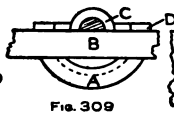

Fig. 309

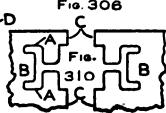

Fig. 310



is to fit the pattern very closely. About $\frac{1}{8}$ in. of the edge of *B*, Fig. 301, that fits against the pattern is straight, and from that it tapers away as shown. When the molder makes this mold he places a novel part of the flask on top of this plate *B B*, with the pattern up in place as shown. He fills the flask full of sand, some molders doing the ramming by hand, but most of them using the presser top, which makes an even hardness of sand all over the pattern. After this has been done, a lever is worked which draws the pattern down through the stripping plate as shown in Fig. 302. *K* is the space in the sand that the metal is to fill and is made by the pattern; *C* is the surface that the flask rests on, and *A* is the pattern. The other parts are the same as shown in Fig. 301. This is the drag or novel part of the mold. Now the cope has a flat surface and is made by placing a flat board on top of the stripping plate with the pattern down. The cope part of the flask is placed on top of this board and filled full of sand. Now the shape of the hole through the stripping plate is as shown in *A*, Fig. 303. *B* is the plate; *A* is the shape of the outside of the pattern; *D* is the stool that holds the sand in place for the slot. Section *C C* shows the other view. There are holes through the plate *E* in Figs. 301 and 302 so that the rods *H H* can be lowered and raised. Only a section of the machine with this pattern on it is shown.

There can be a number of these molds made at a time. The larger the machine, the more castings can be made in one mold. There is a counterbalance on each machine so that the raising and lowering of the plate that the patterns are fastened to is very easily done. Molding-machines are made very strong, and good workmanship is used in making them, because everything has to be very accurate. Some shops use wood stripping-plates, which are much cheaper to make than metal, but these are not used if there are a great number of castings to be made. A wood stripping-plate will make a few hundred all right. Sometimes there are two or three sets of wood stripping-plates made for the same pattern. In large foundries you will see that each molder does one thing all the time and has trained himself on this particular piece of work so that he has very little loss of castings. Generally the machine molders do piece work and receive so much per flask of good castings. When the molder has trained himself to this one piece he can do a fair day's work and receive very good wages.

Gears can be made on a molding-machine better and quicker than by hand. In Figs. 304 and 305 is shown a small flanged pulley for which a large number of castings are wanted. Now, the old way to make this would be as shown in Fig.

306, which shows a pattern turned up with flange *B* and core prints *A A* and *C C*. These would be made on a "match" or connecting bar with ten or twelve patterns in a flask, the drag or nowel rammed first, then the cope.

The machine molding method is shown in Figs. 307, 308 and 309. Fig. 307 shows half the pattern above the plate. *A* is the pattern, *B* the plate, *D* the surface that the flask rests on, and *C* is a shaft which acts as a core print. The shape through the plate is as shown in Fig. 310. *B* is the plate, *A* is the shape of the outside surface of the pulley, and *C* the section that the rod or core print fits. Now to work this there is an arrangement, on the end of the rod that acts as a core print, for turning the half pulley over, which will look as shown in Fig. 309. Half of the pulley is down, and there is only a small part left above the table. Fig. 308 shows another view of Fig. 307. Where there are ten or twelve patterns made in a flask the old way, twenty or more can be put in a flask this way.

The molder makes this mold the same as was shown in Figs. 298 and 299 of Chapter XXIII. The flasks are made so that the halves can be turned and placed together as was described in that chapter.

PART II

CORE-MAKING AND MOLDING

CHAPTER I

CORE-MAKING

IN order to successfully make patterns the pattern-maker must be familiar with much of the molder's trade. Core-making is an important detail of this trade, and a few points concerning the making, baking and setting of cores are herewith given.

It must be understood that cores are always used for the purpose of making holes in castings. These are made by letting a part of the molding sand project into the mold or by making a separate sand piece which is baked and set into the mold. In either case, as the molten metal runs into the mold it flows about the sand cores and thus forms a hole in the casting.

Green sand cores, or those which are a part of the molding sand, must be used only when there is no danger of their breaking or being washed away by the molten metal. Common

sense must govern their use so far as size is concerned. It is evident from the nature of these green sand cores that they can be used only on the bottom of a mold with any degree of safety, and even in this position often must be lagged or nailed to the main part of the mold with pins.

Dry sand cores, may be made in half or whole-core boxes. As a rule the whole-core box is preferable to the half-core box. Gluing together the halves of a core made in a half-core box is not very satisfactory. The two halves are too liable to be glued so that the whole is not symmetrical, and, again, the glue does not always hold. Small cores are made by filling the core box with a mixture of sand and molasses, sand and flour water, sand and sour beer, or some mixture which when baked will be hard. There is no provision made in them for escaping gases which form when the molten metal comes in contact with the core. It should be understood, however, that, owing to the nature of the core mixture, a gas will be generated when the mold is poured, and consequently in large cores, where considerable gas will be produced, some means must be devised for its escape. This is done in different ways.

One of the most common ways of providing for the escape of gas in medium-sized cores is to build the core with a wire or rod running

through it and pulling this out after the core is baked. This leaves a hole running through the core through which the gas may escape. It is evident, of course, that this method is impossible except in straight cores. In bent or crooked cores of medium size a porous or easily burned substance is used instead of the wire or rod. If this is done the channel for the escape of gas is provided by the substance burning when the core is baked. A cotton wick or cord is sometimes used in cases of this kind.

For large cores the escape of gas is provided for in still other ways. One is to use a gaspipe around which the core sand is packed and baked. Another one is to mix with the core sand some porous or solid particles which will make the mixture porous, such as sawdust, crushed brick or horse dung. Whatever the method may be, the object is always the same, viz.: to make a vented core or one which will allow gases to escape. One can hardly appreciate what imperfect venting in either the core or the mold means until he has seen a mold "blow." This term is applied to the bursting of a mold when gases accumulate, forming a pressure which breaks the sand. The result of such bursting or blowing is the total ruin of the mold.

Sometimes in heavy cores rods are run through cores which are left in them to support

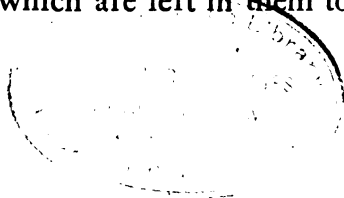

or strengthen them. In large cores the weight of the core is sufficient to make them sag if the distance between supporting points is great and the rods help to hold them in their true position and in shape while the mold is pored. Another way to keep a large core fixed in its position is to support it in the center from the under side by placing thin wire supports in the molding-sand and letting them project far enough into the hole in which the metal flows to touch the coil and hold it from sagging or dropping. These wires, being thin, will melt as the molten metal surrounds them and become a part of the casting. This method of supporting a large core is not recommended because it is not certain of good results and because, also, the wires may form defects in the casting.

If, after reading this chapter, one fails to see why it is put in a book on pattern-making, he should spend a day in the foundry, and especially in the core room. He will, by such a visit, not only learn much concerning the molder's trade, but he will pick up many points which are absolutely indispensable to the pattern-maker, and especially to the person who is learning the pattern-maker's trade.

CHAPTER II

PRINCIPLES IN MOLDING

IT has been said that pattern-making is an art, and that no man ever works at it so long that he cannot learn something new. True as this may be, it is likewise true that there are a few things which govern the making of patterns which every pattern-maker must know before he can make even the simplest patterns. Among these are principles governing shrinkage, draft, the determination of position and location of cores, and the place of loose pieces on patterns.

We will consider these briefly in the order mentioned. Shrinkage is that quality which every metal has to decrease in size when it cools. Inasmuch as a mold must be filled with molten metal it follows that as the metal cools it will occupy a smaller space than it did when it was hot. This necessitates making all patterns larger than the intended size of the castings which are to be made from the patterns. In another part of this book is given the ordinary shrinkage for different metals in terms of linear feet. For example, iron shrinks $\frac{1}{8}$ in. per foot. This means that a casting to be 1 ft. long must be made from a pattern which is 1 ft. $\frac{1}{8}$ in. in length. Rules are made which calculate this

shrinkage for different metals, and thus it is not necessary for the pattern-maker to bother about shrinkage calculations; he simply selects the rule which is calculated for the shrinkage of the metal for which he is making a pattern.

Castings do not shrink uniformly throughout their volume, because thin parts and small areas cool more rapidly than do large volumes and large areas. It is sometimes true that this unequal shrinkage causes cracks or checks in castings between large and small parts. This possible trouble may be either entirely overcome or lessened by the pattern-maker varying the shrinkage for the different parts. It is quite necessary, therefore, for the pattern-maker to be experienced in order to wisely use a shrink rule on different patterns.

Draft is the amount of taper given a pattern in order that it may be drawn from the sand of the mold. A general rule for draft is to taper each side of a pattern $\frac{1}{8}$ in. for every foot of draw. Thus if a pattern is 1 ft. deep in the sand and 1 ft. square on top it will of necessity be 11- $\frac{3}{4}$ in. square on the bottom. This rule is a very satisfying one to use for ordinary or large-sized patterns, but for thin patterns having very little drawing surface it is wise to follow the rule that at least 1-32 in. draft will be given every drawing surface. Of course, if a pattern is very

thin and can be rapped well in the mold it may be made without any draft. On the contrary, if a pattern is very deep in the mold it may be wise to give it slightly more than $\frac{1}{8}$ in. draft for every foot of depth.

Concerning the position and location of cores in a mold which governs the construction of patterns, the following may be said: In general there are three kinds of cores, viz.: green sand cores, vertical dry cores, and horizontal dry cores. A green sand core is one which is formed in a mold by the molding sand filling a hole in the pattern and leaving a lug in the mold after the pattern is drawn from the sand. This class of cores may be made where the holes in the castings formed by them are not longer than they are wide. A vertical dry core is one which has been made in a core box and baked and which occupies a vertical position in the mold. As a rule a core may be set vertically if its length does not exceed four times its thickness or diameter. For cores of this class the pattern is made solid. A dry horizontal core is one which has been made in a core box and which occupies a horizontal position in the mold. Cores of this class require a split pattern.

It is more difficult and more expensive to make a split pattern than it is a solid pattern. Nevertheless it is necessary at times to make

split patterns. It is also expensive, but at the same time necessary to make patterns which have loose pieces. As a rule a loose piece is placed at any point on a pattern where there is a part or a projection which will interfere with success in drawing the pattern from its mold. These loose pieces are usually loosely pinned or doweled onto the main part of the pattern, so that when the main part is drawn from the sand the loose piece remains. They are afterwards drawn out through the hole formed by the withdrawal of the main part of the pattern.

CHAPTER III

LOAM PATTERNS AND LOAM MOLDS

ORDINARILY a mold is made of what has been called green sand. This is a sand which has a certain amount of adhesiveness, or the quality to hang together, and at the same time is porous enough to permit the addition of considerable moisture without becoming muddy. Loam is a mixture of green molding-sand and some material which will make the mixture more porous than the green sand alone. Chopped hay or straw, sawdust and sifted fire-clay are materials which are often mixed with the green sand to make a loam mixture. In order to make the mixture plastic a clay wash is added. A loam mixture is made with varying amounts of the above-mentioned ingredients for different kinds of work, but the following recipe is one which is common:

Mix one part of white pine sawdust with one part of dried, sifted fireclay, and one part of molding-sand and four parts of fire sand (molding-sand which has been turned); wet with a thin clay wash.

Making ordinary wooden patterns for certain kinds of large work is very expensive, and where only one casting is needed a loam pattern may

be used, because it can be made quickly and much more cheaply than can a wooden pattern. Loam patterns are made with sweeps, which have been described elsewhere in these articles. The mere fact that a sweep is used in the construction of these patterns limits, in a general way, the loam pattern to cylindrical forms. As an illustration we will consider a loam pattern and its mold for a plain cylinder 30 in. in diameter on the inside and having a shell $1\frac{1}{2}$ in. thick. (Figs. 311 and 312.) We will say that the cylinder has a 5-in. flange at each end.

The molder first prepares a level surface on the floor of the molding-room and lays on this a circular iron plate, *A*, about 40 in. in diameter, supported by bricks, *B*. On the surface of the plate he places a thin layer of loam, *C*, and upon the outer edge of this he lays a row of brick, *B*, making a ring of brick all around the plate. The brick will be farther apart on the outer ends than on the inner ends, and the spaces between them are filled with cinders, *E*, which will go through a riddle of $\frac{1}{4}$ - or $\frac{1}{2}$ -in. mesh. These cinders are used to provide vent for the mold.

Upon this first row of bricks and cinders is placed a layer of loam, and on top of the loam is put a second row of brick projecting over the ends of the first row toward the center of the ring. This projection is enough to provide for

PATTERN-MAKING

PLATE XXVII

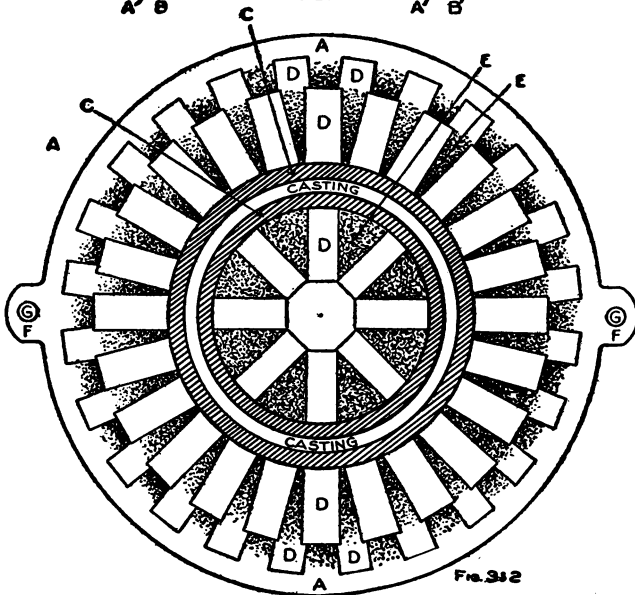
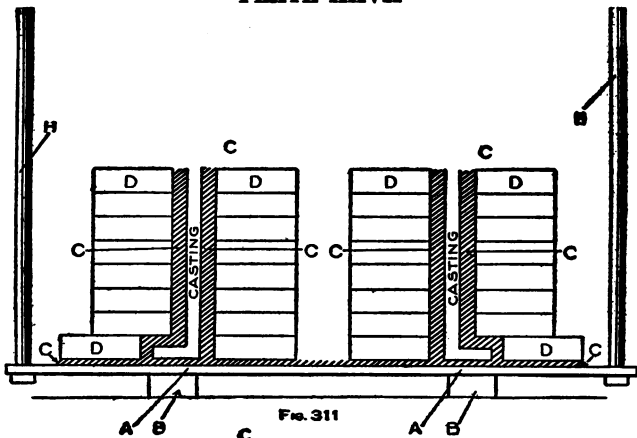



the flange of the pipe. Alternate layers of loam and brick are laid on top of this second ring of brick (between which cinders are placed as in the first ring). The successive layers of brick rings have the same diameter as the second layer of brick had. This process is continued until a height is reached equal to about half the length of the pipe, when loam is daubed on the inside of the cylindrical well formed and this loam is swept up. This sweep, of course, has the exact shape and size as the outside surface of the pipe. When this lower half of the cylinder has been swept up, the remaining layers of the mold well are laid. The top layer or ring of brick will correspond to the first layer laid on the base plate to form the flange on the upper end of the pipe. The upper part of the well is now daubed with loam and swept up as described for the lower part of the pipe. On top of this mold will be placed an iron plate similar to the bottom plate. On both the top and bottom plates will be projecting lugs, *F*, in which there are holes, *G*. These plates will be placed in such a position that rods *H* may be run through corresponding lugs to fasten the entire pile securely, and by which, with the aid of a crane, it may be lifted and swung out of the way.

The inside part of the mold, or the core for the bottom—for this is both a mold and a pat-

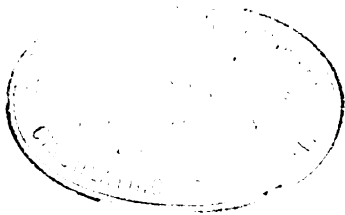

the flange of the pipe and brick are laid in brick (between the first rings have the height of brick height of the pipe of the swept up shape and When swept up are laid correspond plate to pipe. The with beam lower part be placed plate. G. These ing legs by which lifted and The the bottom

tern—is now made. For this particular pattern the core will be a cylindrical pile of bricks and loam which has a diameter somewhat less than the inside diameter of the pipe to be cast. The outside of this pile will be daubed with loam and swept up with a sweep having a vertical board fastened to the sweep spindle. The distance of the inner edge of this board from the center line of the spindle will be equal to the radius of the inside of the pipe. The crane now resets the outer part of the mold, so that the two parts are centrally located, and all is ready for pouring.

The foregoing description does not go into great detail because it is not intended to give the reader sufficient information to enable him at once to make a loam pattern and mold. It sufficiently describes, however, a method of making a casting for large symmetrical work where the construction of a wooden pattern would involve considerable expense.

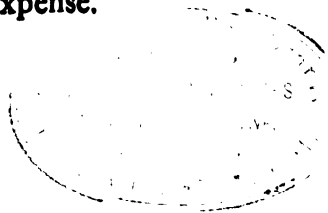

Alphabetical Index

- Angles for turning round piece, 50.
Apprentices, 14, 17.
Back saw, 23.
Balanced core job, 111.
Band saw, 91.
Baywood for patterns, 33.
Beam compasses, 24.
Bends, patterns of, 163.
Bevel protractor, 24.
Bevels, to cut, on circular saw, 73.
Bits, 20.
Board, turn-over, 15.
Boards, warping of, 34.
Boring machine, 96.
— tools, 71.
Boss, how to turn a, 48.
Bosses, to locate centers for, 24.
Brick, patterns for, 14.
Bushing, pattern for a, 100.
Butt joint, 36.
Buzz planer, 92.
Calipers, 27.
Care of turning-tools, 72.
Casting, how obtained from a pattern, 176.
—, making pattern from an old, 100.
—, where large numbers are required, 184.
Castings, points to consider, 100.
Cast-iron works, patterns for, 17.
Cast metals, 14.
Cedar for patterns, 29.
Cement, patterns for, 14.
Center screw, face plate, 49.
Chaplets, 162.
Cheap patterns for pipe work, 163.
Checks caused by shrinkage, 200.
Cherry wood, 33.
Chisel, skew, 50.
Chisels, 19.
Chuck, driving, 51.
—, a handy, 55.
—, a useful, for metal patterns, 56.
—, how to locate on two face plates, 63.
Circular saw, 23, 73.
— —, a dangerous tool, 80.
Circular shape, handy method for turning a, 68.
Clamps, "dogs" used as, 57.
Clay in models for stoves, 171.
Coloring for varnish, 17.
Colors, distinguishing, for patterns, 18.
Combination saw, 73, 77.
Compass saws, 23.
Compasses, beam, 24.
Cope, definition of, 15.
Core, balanced, 111, 112, 113.
Core-box, making a, 116.
— —, plane, 20.
Core-boxes, 146, 154, 168, 177.
— —, hardwood best for, 123.

- Core, heel, 118.
 Core-making and molding, 195.
 Core vents, 197.
 Cores, dry sand, 196.
 —, gas in, 196.
 —, green sand, 196.
 —, position and location of, 201.
 —, purpose of, 195.
 —, reinforced, 197.
 —, supports for, 198.
 — to prevent sagging, 198.
 —, various kinds of, 201.
 Corner fillet of wood, 137.
 Corners, quick way of making, 120.
 —, tool for making, 99.
 Countersink, 23.
 Countersinks for screws, 96.
 Cracks caused by shrinkage, 200.
 Crooked patterns, 126.
 Crooked work, best wood for, 30.
 Cross-cut saw, 23.
 Crosshead guide patterns, 149.
 Curling of boards, 34.
 Curved patterns, 127, 131.
 Cut-off saw, 73.
 — —, filing a, 77.
 Cutting-off tool, 71.
 Cylinder barrels, 52.
 — —, patterns for, 80.
 Dampness, preserving patterns from, 17.
 Diamond point, 72.
 Dividers, 24.
 "Dog," definition of, 57.
 Dovetail joint, 41.
 Draft, definition of, 200.
 —, rule for, 200.
 Drag, or nowel, 15.
 Drawing, value of, 14.
 Drawings, working from, 101.
 Drills, 23.
 Driving-chuck, 51.
 Edger, 92.
 Education of pattern-maker, 15.
 End grain rough and uneven, 137.
 End-half lap joint, 39.
 Face plate, a good, 59.
 — —, of segments, 63.
 — —, center screw, 49.
 Face plates for large work, 59.
 — —, truing up of, 58.
 — —, various forms of, 58.
 Files, 27.
 Filing a cut-off saw, 77.
 — circular saws, 74.
 Fillet, corner, of wood, 137.
 Fillets, 17.
 Finish, calculating the, 101.
 Finishing, 17.
 Fir as pattern wood, 29.
 Flask, definition of, 15.
 —, snap, 180.
 Flywheel, hollow-arm, 156.
 Flywheels of large diameter, 156.
 Foundry practice, 15.
 Furnace door-lining, pattern for, 176.
 Gases, providing for escape of, in cores, 196.
 Gate, definition of, 16.
 Gauge, marking, 24.
 —, ripping, 81.
 Gears made on a moiding machine, 192.
 Glass, patterns for, 14.
 Gluing, 34.
 — halves of core, 196.
 — segments, etc., 40.

- Gluing stock from the saw, 79.
 Gauges, 19.
 Gauge turning, 27.
 Grain, how to place, 41.
 — of lumber, 33.
 — of pine wood, 29.
 —, rough end, 137.
 Green sand cores, 195.
 Half-circles, patterns of, 163.
 Hand saws, 23.
 Hardwood, 33.
 — apt to split, 51.
 — preferred for core boxes, 123.
 Heel core, 118.
 Hollow-arm flywheel, 156.
 Horizontal dry cores, 201.
 Jig saw, 88.
 Joint, dovetail, 41.
 —, end-half lap, 39.
 — made with a circular saw, 85.
 —, miter, 40.
 —, mortise-and-tenon, 41.
 —, square or butt, 36.
 —, tongue, 39.
 —, tongue-and-groove, 39.
 —, V, 36.
 — with center keys, 40.
 Jointing plane, 19.
 Jointing-planer, 92.
 Joints, various kinds of, 36.
 Knots in wood, 30.
 Lags, 82.
 —, for cylinder, how to saw, 78.
 Large Pattern Work, 133, 141.
 Large work, face plates for, 59.
 —, turning, 52.
 Lathe, parts of the, 51.
 —, proper speed to run, 44.
 Lathes for pattern-making, 43.
 Life in wood, 30.
 Lignum vitae, 29.
 Loam mixture for patterns, 203.
 Loam patterns and molds, 203.
 — — limited to cylindrical forms, 204.
 Loose pieces on patterns, 202.
 Lumber, flat, 33.
 —, grain of, 33.
 —, how to season, 35.
 —, how to select, 29.
 —, quarter-sawed, 33.
 Machine molding method, 193.
 Machine tools, 88, 94.
 — —, care of, 72.
 Machine turning, 66.
 Mahogany for patterns, 30.
 Marking gauges, 24.
 Metal in stove work, 171.
 Metal patterns, 172.
 Miter gauge of circular saw, 73.
 Miter joint, 40.
 Models for stoves and furnaces, 171.
 Molasses and sand as core mixture, 196.
 Mold, making a, 15.
 Molding, 100, 199.
 — and core-making, 195.
 —, vertical, 109.
 Molding-machines, 179.
 Molding-machine work, 179, 187.
 Molding pattern work, 187.
 — press, 180.
 Molding-sand, 195.
 Molds, loam, 203.
 Mortar, patterns for, 14.
 Mortise-and-tenon joint, 41.

- Newspaper used as parting sand, 167.
- Nowel, or drag, 15.
- Odd-shaped pipes, 166.
- Ogee curve pattern, 126.
- Oilstone, 24.
- Paint, effect of on wood, 30.
- Paper, patterns for, 14.
- "Parting," 15.
- Patching, 187.
- Pattern, split, 47, 149.
- , cost of, 201.
- , three ways of making a, 101.
- Patternmaking a distinct craft, 13.
- , an art, 199.
- Patterns, crooked, 126.
- , crosshead guide, 149.
- , curved, 127, 131.
- for large work, 141.
- , jointing of, 36.
- , large, 133.
- , loam, 203.
- , loam, limited to cylindrical forms, 204.
- , loose pieces on, 202.
- , metal for stores, 172.
- of bends, 163.
- of half circles, 163.
- , simple, 100, 111, 118.
- , split, 47, 149, 201.
- , symmetrical, 185.
- , where required, 14.
- , where few castings are wanted, 128.
- Pattern Work, large, 133.
- , molding, 187.
- , stove, 171.
- Pine, white, 29.
- Pipe, patterns for, 80.
- Pipes, odd shaped, 166.
- Pipe work, 163.
- Piston pattern, 141.
- Pitch in wood, 30.
- Plane, core-box, 20.
- , routing, 20.
- Planer, buzz, 92.
- , pony, 95.
- , surface, 94.
- Planes, 19.
- Plastelina, 171.
- Plaster of paris, patterns for, 14.
- Plug-cutters, 23.
- Pony planer, 95.
- Preserving patterns, 17.
- Protractor, bevel, 24.
- , rotary, 80.
- Pulleys, turning of, 58.
- Putty stickers, 23.
- Quarter-sawed lumber, 33.
- Quick patterns for pipe work, 163.
- Rabbit plane, 20.
- Ratchet bit brace, 20.
- "Rat-tails," 172.
- Redwood for patterns, 29.
- Ring patterns too large, 64.
- Rings, special device for holding, 64.
- , turning of, 58, 64.
- Ripping gauge, 81.
- of circular saw, 73.
- Rip saw, 23, 73.
- Rods in cores, 197.
- Rotary protractor, 80.
- Round piece, angles for turning, 50.
- Rounding tools, 27.
- Router, 20.
- Routing machine, 96.

- Routing plane, 20.
 Rubber, patterns for, 14.
 Rule for shrinkage, 16.
 Sand breaking away, 187.
 —, burning, 172.
 —, dry, 196.
 —, molding, 195.
 — papering, 18.
 —, sticking, 172.
 —, with molasses as core mixture, 196.
 Sap in wood, 30.
 Saw, band, 91.
 —, circular, 23, 73, 74, 80.
 —, circular, to file, 74.
 —, combination, 73, 77.
 —, cut-off, 73.
 —, jig, 88.
 —, rip, 73.
 —, scroll, 88.
 Sawing device when table does not tilt, 78.
 Sawing lumber, 33.
 Saws, 23.
 Saw "tricks" with a circular saw, 79.
 Screw drivers, 23.
 Scroll saw, 88.
 Segments, how to glue, 40.
 Shrinkage, 16, 199.
 —, cause of checks and cracks, 200.
 — in castings not uniform, 200.
 —, table, 17.
 Skew chisel, 50.
 Slickers, 23.
 Slip stone, 24.
 Smoothing-plane, 20.
 Snap Flask, 180.
 Speed of lathes, 43.
 Spindle turning, 50.
 Split patterns, 47, 52, 55, 57, 101, 115, 149.
 — —, cost of, 201.
 — —, holding halves of, 57.
 Splitting, danger of, 126.
 Spoke shave, 23.
 Square joint, 36.
 —, steel, 24.
 Squeezer, or molding-press, 180.
 Steel square, 24.
 Stone, patterns for, 14.
 Stove castings, 171.
 Stove-cover patterns, 175.
 Stove pattern work, 171.
 Strength necessary for large work, 155.
 Strike, making a, 169.
 Stripping-plates, 192.
 Stripping-plate work, 187.
 Surface gauge, 24.
 —, planer, 94.
 Sweep work, 156.
 Sweeps of gauges, 19.
 Taper, or draft, 200.
 Teeth for Circular Saws, 74.
 Thread wearing out, 51.
 Tongue-and-groove joint, 39.
 — — made with a circular saw, 85.
 Tongue joint, 39.
 Tool box, how to make a, 27.
 Tools, 19.
 —, boring, 71.
 —, cutting off, 71.
 — for flat surfaces, 71.
 — for lathe work, 71.
 —, how to mark, 28.
 —, machine, 88, 94.
 —, proper care of, 28.

- Tools, rounding, 27.**
 —, tangency of cutting, 50, 51.
 —, turning, 27.
Trammels, 24.
Tricks in pattern-making, 91.
Trimmer, universal, 99.
Trimings, best wood for, 33.
Turned work, gluing up stock for, 36.
Turning, 43.
 —, holding pieces together while, 48.
 — of pulleys, 58.
 — of rings, 58.
 —, spindle, 50.
Turning lathe, machine, 66.
 — tools, 27, 43, 51.
 — —, care of, 72.
Turn-over board, 15.
Turn saw, 23.
Universal trimmer, 99.
Varnish, color-matter for, 17.
Varnishing, 17.
Vents for cores, 197.
Vertical dry cores, 201.
 —, molding, 109.
Vibrators, 187.
V joint, 36.
Walnut, black, 29.
Warping of Lumber, 34.
 —, danger of, 126.
 —, how to prevent, 34.
Waterproofing, 17.
Wavy surface in stove covers, 172.
Wax slickers, 23.
Wheel, pattern for section, 156.
Whitewood, 29.
Wood, best for crooked work, 30.
 —, life in, 30.
 —, pitch in, 30.
 —, sap in, 30.
 —, scrapers, 27.
Woods for patterns, 29.
Wormholes in wood, 30.

