



Class TS240

Book -T8

Copyright N^o _____

COPYRIGHT DEPOSIT.

THE WILEY TECHNICAL SERIES

FOR

VOCATIONAL AND INDUSTRIAL SCHOOLS

EDITED BY

J. M. JAMESON

GIRARD COLLEGE

FORMERLY PRATT INSTITUTE

THE WILEY TECHNICAL SERIES

EDITED BY

J. M. JAMESON

NOW READY

Gas Power. By C. F. HIRSHFELD, Professor of Power Engineering, Sibley College, Cornell University, and T. C. ULBRICHT, formerly Instructor, Department of Power Engineering, Cornell University. \$1.25 net.

Heat: A Text Book for Technical and Industrial Students. By J. A. RANDALL, Pratt Institute. Large 12mo, xiv+331 pages. 80 figures. \$1.50 net.

The Essentials of Electricity: A Text Book for Wiremen and the Electrical Trades. By W. H. TIMBIE. Wentworth Institute. 12mo, flexible cover, pocket size. xiii+271 pages. 224 figures. \$1.25 net.

Exercises for the Applied Mechanics Laboratory. By J. P. KOTTCAMP, Pratt Institute. 4to, loose leaf, 54 exercises, with numerous cuts and tables. Selected exercises, two cents each. Complete, \$1.00 net.

Exercises in General Chemistry. By CHARLES M. ALLEN, Pratt Institute. 4to, loose leaf, 61 exercises. Selected exercises, two cents each. Complete, \$1.00 net.

Agricultural Drafting. By CHARLES B. HOWE, Bushwick High School, Borough of Brooklyn, New York, N. Y. 4to, viii+63 pages, 45 figures, 26 plates. Cloth, \$1.25 net.

Studies of Trees: Their Diseases and Care. By J. J. LEVISON, Department of Parks, Brooklyn, N. Y. 4to, loose leaf, 20 pamphlets, \$1.00 net.

Many others in preparation. For full announcement see page 199

PATTERN-MAKING

BY

FREDERICK W. TURNER

AND

DANIEL G. TOWN

Instructors in Pattern-Making, Mechanic Arts High School, Boston

FIRST EDITION

FIRST THOUSAND

NEW YORK:

JOHN WILEY & SONS, INC.

LONDON: CHAPMAN & HALL, LIMITED

1914

TS240
T8

Copyright, 1914
BY
FREDERICK W. TURNER AND DANIEL G. TOWN

14-17679

OCT 1 1914

\$1.00

THE SCIENTIFIC PRESS
ROBERT DRUMMOND AND COMPANY
BROOKLYN, N. Y.

©Cl.A379797

no,

PREFACE

THIS volume is not intended primarily for the mature pattern-maker, although the authors hope the masters of the craft may read it with pleasure if not with great profit. It is planned to outline to the younger members of the fraternity a general survey of the most suitable materials, the special tools, and the fundamental processes of the trade, together with the relations of the allied departments, particularly those of the foundry. The detailed construction of typical patterns has been treated in an excellent manner by very competent workmen in the several books now published, and still the literature of the craft is not as large as the importance of the subject would seem to warrant. This book is not intended to supplant any of the existing works, but rather to pave the way for a better understanding of their technical excellencies. If it accomplishes this result even in a small way the authors will be well content.

CONTENTS

CHAPTER	PAGE
I. General Trade Relations and Qualifications of a Pattern-maker.....	1
II. Foundry and Machine Shop Practice as Determining the Type of Pattern.....	5
III. Allowances and their Effect on the Pattern.....	13
IV. Tools—Bench, Machine and Special.....	20
V. Layouts and Templets.....	38
VI. Materials—Construction, Fastening and Finishing.....	43
VII. Types of Patterns.....	54
VIII. Core Prints.....	65
IX. Construction of Patterns.....	71
X. Core-boxes and Cores.....	90
XI. Skeleton Patterns and Sweeps.....	102
XII. Specialization in the Pattern Shop and in the Foundry....	107

PATTERN-MAKING

CHAPTER I

GENERAL TRADE-RELATIONS AND QUALIFICATIONS OF A PATTERN-MAKER

1. Effects of Specialization. The pattern-maker is a modern development,—a part of specialized industry—and as such he must be a necessity or he would not be tolerated.

It is highly probable that the original casting was accidental; molten metal cooling in a shape which proved useful. As time went on, the shapes that could be made were brought under control. At first, everything from the conception of the form to the production of the completed casting was the product of one mind.

Specialization has divided this into a series of steps or processes as follows: designing, drafting, pattern-making, foundry work, and machine-shop practice. Each of these is again subdivided until we reach our present-day shop conditions. In spite of the division, the five general processes are dependent on one another to such an extent that each must keep the others in mind.

When work is divided among a group of men, some form of expression must be found which all can understand

and which will not require personal contact. Drawing has been selected for this purpose and it must be uniform in order to be intelligible.

2. Relation to Foundry Practice. In considering the work of the pattern-maker, we see at once that the closest connection is with the work of the foundryman, be he molder or core maker. Such frequent reference must be made to foundry conditions, and such careful attention paid to the convenience of the molder and the core maker, that it might almost be said that the best place to learn pattern-making is in the foundry. While it is not necessary for a pattern-maker to be a molder, he should be familiar with general foundry methods and equipment, and should consult frequently with the men who are to use the patterns he makes.

The pattern-maker is merely a tool-maker to the molder, and a pattern may be defined as any form or device by the use of which a mold may be made. This brings the pattern-maker into the general classification of non-producers, in the sense that his product is only a means to an end and not an end in itself.

3. Demand for the Pattern-maker. Other wood workers such as joiners, carpenters, and cabinet-makers produce articles which go into permanent use as made. No matter how much the elimination of the pattern-maker may be considered desirable, he is apt to stay with us for some time to come, and undying fame awaits the man who can produce all castings without patterns. Possibly the use of permanent molds will dispense with some patterns of comparatively small size, but such molds will never render the pattern-maker unnecessary. The pattern-maker who is resourceful, who can do a job quickly without assistance, and who works in harmony with the drawing room

on the one hand and with the foundry on the other hand, can always have a job. In this respect he is on a par with the skilled mechanic in any line.

4. Qualifications Necessary. In most trades, the principal qualification of a good workman is to be expert in handling the tools of his craft, but the pattern-maker, like the designer, is more largely concerned with that kind of planning which requires a strong effort of the imagination. Such planning must include not only the construction of the pattern, but also, before this construction can be determined, the method of molding, which must be selected from the alternative plans which suggest themselves to a good pattern-maker. This is what makes pattern-making an art rather than a trade, for while the pattern-maker must be a skilled craftsman, his success does not depend very largely on the mere cutting and fastening together of pieces of wood. As the draftsman has the flat sketch of the designer to make into a flat drawing, so the molder and machinist have a solid body or form from which to make another of somewhat similar shape; the pattern-maker, on the other hand, has only a flat drawing from which to make a solid pattern or form which may bear but little resemblance to the casting which is to be produced. This makes the work of the pattern-maker more like that of the designer than that of any of the other contributors to the finished article.

No book can make a pattern-maker, yet books may be of great assistance to him, and the contempt which many workmen have for "book learning" is not justified in the minds of the best craftsmen. The work is clean, pleasant, varied, and well paid, while the working conditions are usually better than are found in other trades. The intelligence and skill required for such intricate work bring

together a superior set of men whose requirements rank with those of the engineer. Among these may be noted an ability to draw, a working knowledge of geometry, a general acquaintance with machine tools, a good sense of proportion, and some idea of the strength of materials. If a man can read a drawing as well as the man who made it, can appreciate the limitations of the foundry, and can also see things from the point of view of the machinist, then such a man may aspire to become a pattern-maker if his judgment is quick and accurate, if he is self-reliant and resourceful, and, most important of all, if he has the gift of imagination to see a mental picture of the pattern, of the way it is to be used in the foundry, and of the finished casting.

CHAPTER II

FOUNDRY AND MACHINE-SHOP PRACTICE AS DETERMINING THE TYPE OF PATTERN

WHILE the pattern-maker does not need to be a molder, he must know the general principles underlying foundry practice, and, above all, if he is to consult with the molder, as he should do on many occasions, he must be familiar with the terms used in the foundry. A very brief summary of foundry operations, while not attempting to cover the practice, will introduce and partially explain the terms ordinarily used.

5. Molding Sand. A mold is usually made by withdrawing a pattern from sand, leaving a cavity into which molten metal may be poured. This molding sand must be able to resist heat and have strength enough to keep its shape. It is composed of over 90% silica and about 6% alumina; the first makes the sand refractory and the last gives it strength, when the sticky quality of the alumina or clay is brought out by moistening. The addition of water to molding sand is called *tempering* and the result is that molding sand as used is somewhat damp. The sand just mentioned is not prepared in any way except by the tempering referred to and so is called **green sand**. It is not very strong at best, but it is cheaper than any other method and a large percentage of casting is done in this sand.

When a stronger mold is required, a coarse fire sand, almost pure silica, is mixed with clay water to the consistency of a very stiff dough. After a mold has been made in this sand it must be baked to drive out the water and make the mold strong. This makes what is called a **dry sand mold**.

For very heavy work, a somewhat similar mixture called **loam**, with some chopped straw mixed in, is used.

6. Flasks. Very little molding is done in which the top of the mold is left open; usually a cover of sand is placed over the cavity. In order to economize sand and to make

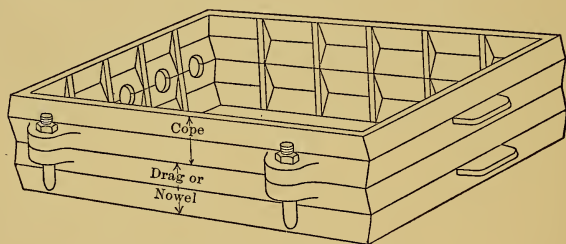

FIG. 1.—Two-part Flask.

it possible to move the molds about, boxes called **flasks** are used. The common or two-part flask consists of a lower part called the **drag** or **nowel**, and an upper part called the **cope**. (Fig. 1.) The drag has a smooth upper surface with sockets to receive the flask pins which project from the cope. Flasks are sometimes made with more parts and are called three-part, four-part, etc., the intermediate parts between the cope and the drag being called **cheeks**. The interior parts of the flask are sometimes made in sections which can be drawn out sideways and which are called **drawbacks**. This is frequently done in dry sand work.

If the cope is large in area and not very deep proportionally, **bars** may be fastened edgewise in the cope (Fig. 2) and in addition to this, cast-iron hooks called **gaggers** are wet in clay wash and laid against the cope bars. These bars and gaggers are used to prevent drop-outs.

7. Preparing the Mold. In plain molding in a two-part flask, the pattern is placed on a **pattern** or **mold board**, the drag inverted over it, and molding sand is sifted in through a sieve or **riddle** to cover the pattern. As this

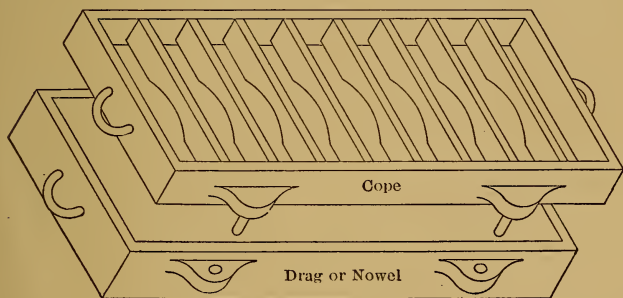

FIG. 2.—Bars in the Cope.

sand comes in contact with the pattern and forms the face of the mold it is called **facing sand**. In large work and especially in dry sand molding a stronger sand mixture is used for facing. The drag is then filled with sand which is forced into place with **rammers**. The ramming must be done carefully, not hard enough to lose the porosity of the sand, which allows the gases to escape, nor so soft that the sand will drop out or be pushed to one side by the pressure of the metal. The top of the drag is then struck off with a straightedge, a bottom board placed over it, and the drag rolled over. To prevent the sand in the cope

from sticking to that in the drag, some sand free from clay called **parting sand** must be sprinkled over the drag. The cope is then placed, facing sand is riddled in and the cope filled up, rammed, and struck off. If it is thought the gases may not pass off through the sand, the mold may be *vented* by pushing a vent wire in several places down through the cope nearly to the pattern. As the molten metal must pass down through the cope in order to reach the mold cavity, an opening called a **sprue** down to the level of the drag must be provided. The cope is then lifted, the patterns rapped to loosen them from the sand, and drawn up from the drag without disturbing the sand. Channels in the surface of the drag, called **gates**, are cut to connect the sprue with the mold cavity. Cores are then set if required and are sometimes supported by wrought- or cast-iron **chaplets**, tinned to prevent rust, which might cause an explosion. The mold is then closed by replacing the cope, clamped or weighted to resist the pressure of the metal, and poured from a ladle of molten metal.

As the metal is heavier than the sand, all loose sand, entrapped gases, etc., will rise to the top of the mold. Therefore, if a surface must be particularly sound, it must be arranged to cast that surface in the drag.

If a surface is required to be particularly hard, a piece of iron called a **chill** is used as a part of the mold, either as a section of the flask (Fig. 3), or set in the mold like a core.

When a pattern is frail, or irregular, especially if a large number of castings are wanted, a *false cope, match, or odd side* of plaster of Paris or of sand mixed with litharge may be used in place of a plain mold board. (Fig. 4.)

8. Deciding upon the Kind of Pattern. When a pattern-maker receives a drawing of an article for which a pattern

is necessary, his decision as to the kind of pattern to be made will be governed by many considerations. It is very easy to say that the pattern-maker is responsible for the pro-

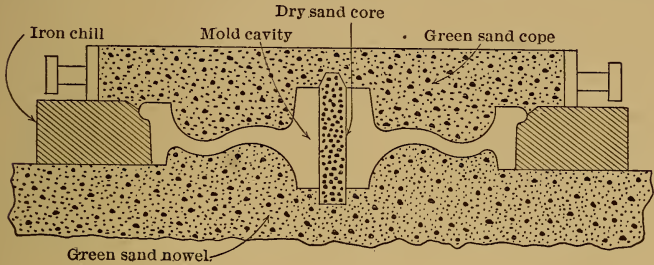

FIG. 3.—Section of Mold with Chill.

duction of the finished article with the least possible expenditure of time, labor, and materials in the pattern shop, foundry, and machine shop; but it is not as easy to decide

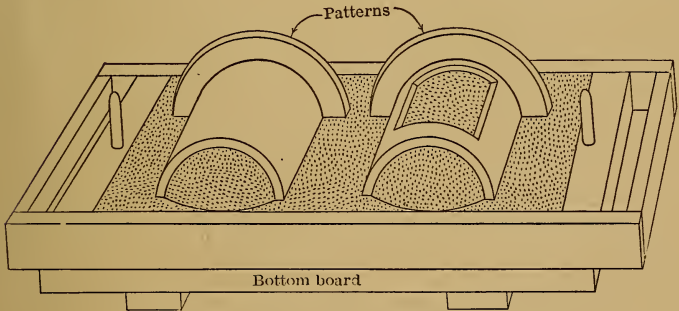

FIG. 4.—Odd Side or False Cope.

which of the many possibilities will prove to be the most economical. While the molder may be consulted as to the best method from the foundry point of view, it must

be remembered that a good molder can get a mold from almost any conceivable shape. One enthusiast is on record as saying, "I can mold the pronged horns of an antlered buck from the natural pattern as it grew on the animal's head." The equipment of the machine shop which is to handle the castings must also be kept in mind, but the principal, and many times the governing factors are the metal to be used and the number of castings wanted.

In a "**one-casting**" pattern, the burden of labor can safely be thrown on the foundry, and such a pattern would be called temporary and ought not to be stored, but destroyed as soon as used. A pattern to be used infrequently, as is the case with a so-called **master pattern**, must be made so that the retention of its shape will be its principal feature. A pattern to be used regularly for a long period would be called a **standard pattern** and should be made so that strength to resist use and abuse in the foundry would be its main feature.

When the information given on the drawing has been absorbed, the different molding possibilities should be considered. Note the choice in the case of such simple patterns as the plain gland (Fig. 5) and the solid roller (Fig. 6). Many times there are no precedents to govern the choice, and only a careful consideration of such factors as cost of molding, cost of cores, soundness of faces to be machined, strength and cost of pattern will bring about the combination of greatest efficiency. The modern tendency toward casting in one piece as contrasted with the older practice of bolting on parts tends to make more complicated patterns.

The same considerations govern the repair of old patterns, as there is often question as to whether the changes required on an old pattern to bring it up to date are not

more expensive than the construction of a new one. No good pattern-maker enjoys making over patterns, even those made by himself. It is hard on tools and temper,

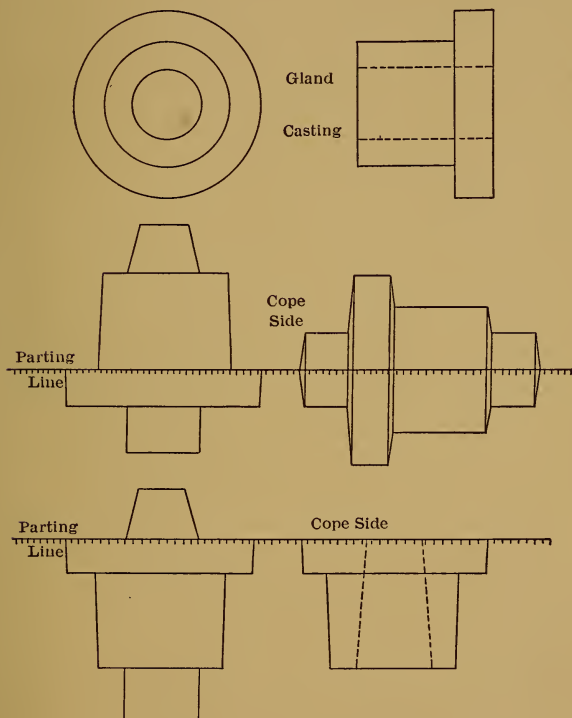

FIG. 5.—Possible Patterns for a Gland Casting.

and the result is never satisfactory from the workman's point of view.

In view of the different governing factors and their

relative importance, it is not surprising that, with the same data, several good pattern-makers might each decide upon a different method. As there can be but one *best* way to

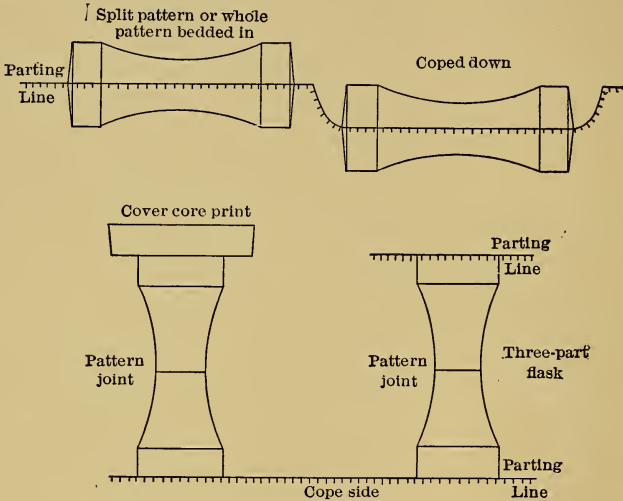

FIG. 6.—Possible Patterns for a Solid Roller.

make a pattern, it is evident there should be the freest consultation on an important job of all parties concerned, in order that the plan finally adopted may represent the most advanced ideas to be found in the engineering staff, of which the pattern-maker is not the least important.

CHAPTER III

ALLOWANCES AND THEIR EFFECT ON THE PATTERN

9. **Allowances.** One of the peculiar things about pattern-making is that certain changes in shape and dimensions from those shown in the drawing are necessary in order to get a casting which finally will be exactly as shown on the drawing. These allowances as they are called are made necessary partly by the nature of the metal to be used, partly by the nature of the mold to be made, and partly by the work to be done on the casting after it leaves the foundry.

The Allowance for Shrinkage is made necessary by the fact that nearly all commercial metals shrink somewhat in changing from the liquid to the solid state. The amount of shrinkage varies with the metal and also to some extent with the shape and weight of the casting. The casting is usually somewhat smaller than the mold in which it was cast, so the pattern must be made a little over the drawing dimensions in order to overcome this change in size. In the case of cast-iron, it should be noted that hard irons shrink more than soft, and that large castings shrink less in proportion than light ones.

Small gray iron castings made in green sand will shrink about $\frac{1}{8}$ " per foot, while large castings in dry sand or loam

will shrink at the rate of $\frac{1}{12}$ " per foot. What are known as malleable iron castings are cast in a hard white iron which shrinks about $\frac{3}{16}$ " per foot. Such castings are usually small and should not be over $\frac{1}{4}$ " thick. Steel castings, which by the way are usually made in dry sand, must have an allowance for shrinkage at the rate of $\frac{1}{4}$ " per foot. Castings in brass, an alloy of copper and zinc, or in composition, an alloy of copper, tin, and zinc, shrink about $\frac{3}{16}$ " per foot, while castings in bronze, an alloy of copper and tin, shrink about $\frac{5}{32}$ " per foot. Lead shrinks a little over $\frac{1}{4}$ " per foot, but a 4 to 1 alloy of lead and antimony has no shrinkage and so can be used for making duplicates of the master pattern. Type metal also has no shrinkage.

10. Unequal Shrinkage. If parts of the casting have sand between them in the mold the shrinkage tends to crush this sand when cooling takes place. If this sand happens to be a core which is harder than the rest of the mold, then the shrinkage cannot take place so readily and may thus be less in one direction on the casting than in another. A cylinder with a dry sand core, for example, will shrink less in diameter than in length for the reason that the core checks the shrinkage.

A change in the thickness of the casting may make one part cool faster than another and so throw a heavy shrinkage strain on a weak portion. As thin sections cool more quickly in the mold than heavy ones, it is sometimes necessary to uncover heavy sections soon after pouring so as to make the shrinkage more uniform. In the case of a pulley, the rim being thin, sets first, then the spokes, and finally the hub, which tends to draw the spokes inward. This may be overcome to a large extent by uncovering the hub almost as soon as pouring is completed. If the shrinkage

strain is greater than the elastic limit of the metal, a broken casting will be the result, and even though not broken in the mold, a casting may be left with such a strain that it may fail in service with a load or shock well below the ordinary limit of safety.

This unequal shrinkage often causes warping of a casting which, if not possible to overcome by uncovering the mold, may be avoided by making the pattern with an opposite warp or **camber**. In general, the heavy side of a casting will be hollow: for example, the bottom of a planer table or the ornamented side of a thin flat plate. (Fig. 7.) The amount of camber necessary can only be determined



FIG. 7.—Thin Flat Plates, Unequal Shrinkage.

by trial, although the necessity for it and the approximate amount may be closely estimated.

11. Draft. If, as sometimes defined, a pattern is a form into whose impression in sand molten metal is poured to form a casting, it follows that to obtain a perfect casting there must be a perfect impression. If the sand is disturbed when the pattern is drawn, it makes patching necessary and sometimes leaves sand so insecure that it washes into the mold when the metal is poured. A pattern must be so made that the large end comes out of the sand first and no part must disturb the sand after the pattern starts. To accomplish this result a certain amount of taper or

draft is added to the pattern required for the correct size. (Fig. 8.) The amount of draft necessary varies with the depth of the draw and with the intricacy of the work. As it is an extra and adds to the weight of the casting, and possibly to the machine work, it is made as small as is consistent with easy and rapid molding. When part of the pattern is molded in the cope, that part should have rather more draft than a corresponding part in the drag, for the lifting of the cope usually takes place

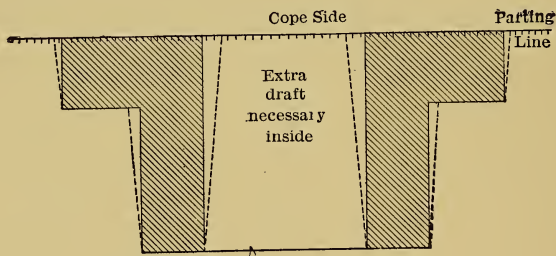

FIG. 8.—Taper Added for Draft.

before any very effective rapping can be done, and yet the lifting should have no tendency to raise the pattern.

The amount of draft on small, light patterns may be about $\frac{1}{32}$ " per inch while on larger work it may be as small as $\frac{1}{8}$ " or even $\frac{1}{16}$ " per foot. On large work the taper introduced by the draft becomes noticeable and is often objectionable, while the added weight may increase the cost appreciably. In general it may be said that on unfinished surfaces as much draft as possible should be added without interfering with the design.

12. Allowance for Finish. If the drawing indicates

that a surface or surfaces are to be finished, it means that the outer part of the casting is to be cut away to a definite size so as to expose clean sound metal, and an allowance equal to the amount to be cut away is added to those surfaces and is called **finish**. (Fig. 9.) On small castings which are cast true to the pattern, and which do not warp or shrink appreciably, the amount added for finish may not be more than $\frac{1}{32}$ " , but $\frac{1}{16}$ " is more common for iron

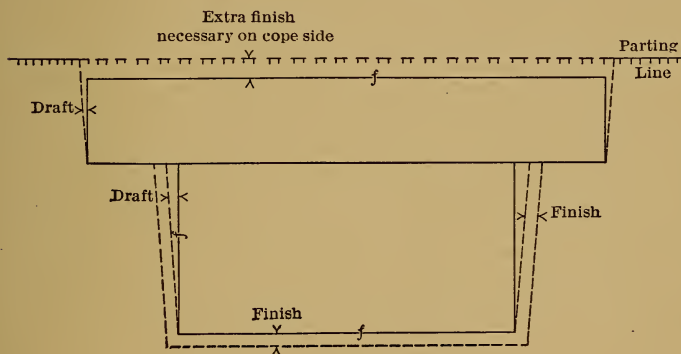

FIG. 9.—Finish where Required Combined with Draft where Necessary.

castings up to 25 pounds made in green sand. Heavy green sand work and castings made in dry sand usually have an allowance of from $\frac{1}{8}$ " to $\frac{1}{4}$ " due to the greater tendency to swell and warp as well as to have a rougher surface. Large dry sand castings and more especially castings made in loam will vary in size even when made from the same patterns. The pressure of the metal tends to strain the mold causing swells to appear on the casting. Uneven ramming is a common cause, while the slight difference

between sharp and dull iron may be enough to make a change in size. The surfaces on these large castings are not as smooth as is the case on smaller work and all these factors combine to make necessary an allowance for finish of $\frac{1}{4}''$ to $\frac{1}{2}''$.

Surfaces to be finished should if possible be cast in the drag as the metal will be sounder and freer from blow-holes. If necessary to finish a surface cast in the cope, the allowance for finish should be greater so as to get rid of the dirt, etc., which floats on the molten metal and so gathers in the cope.

13. Effect of Rapping. When castings are to fit together without machining, the amount of rapping which the pattern gets becomes of great importance. In small patterns, especially if they are thin and have a short draw, the rapping may be enough to more than overcome the shrinkage and so produce a casting which is actually larger than the pattern. In such a case, there is also no need for any draft, as the mold is so much larger than the pattern that no great care is needed in drawing.

When castings must be uniform and true to pattern, methods of molding are followed which do not require any rapping. This usually takes the form of the **stripping plate** which holds the sand while the pattern is drawn. By this method also the necessity for draft is removed and a pattern can be made with perfectly straight sides. This method is somewhat expensive, is usually employed with metal patterns, and has its principal use where large numbers of castings are wanted which must fit without machining.

14. Allowances for Machining. Sometimes allowances are made which do not appear on the drawing and which are solely for the benefit of the machinist. Projections

may be cast on for holding, driving, or for preventing distortion while the casting is being machined. The feet on piston ring castings and the brace across the crank opening of a crank shaft are examples, as well as the centering lug on a tee rest casting or on a drill press frame.

CHAPTER IV

TOOLS—BENCH, MACHINE AND SPECIAL

As patterns are usually made in wood, the bench tools used by the pattern-maker are largely those of the wood-worker, or cabinet-maker, while the machine tools used in the preparation of stock are similar to those used in a good cabinet-shop. The peculiar character of pattern work is responsible for many special tools which do not as a rule have a use in any other trade. Only these special tools will be illustrated, together with some special rigs used on common tools.

15. Pattern-maker's Tools. The first advice of any good mechanic to a man just entering his craft is to get standard, high-grade tools and then keep them in the best of order. As applied to pattern-makers, this results in a good man usually having a kit of personal tools worth from one hundred to two hundred dollars. The amount of time spent in keeping tools in order, together with the personal character of the tools themselves, makes it almost a crime to be considered a chronic borrower.

A man employed on work of fair size needs a **bench** about 8' long by 30'' wide and high enough to suit the man's stature. The front of the bench should be of maple or birch, $2\frac{1}{2}$ '' to 3'' thick, and preferably laid up in strips. Such a top can be planed off from time to time and so kept in good condition. The back may be $\frac{7}{8}$ '' thick and

slightly lower than the front. This bench should be furnished with two drawers and a vise of the quick-action variety or better yet a **pattern-maker's vise** (Fig. 10). A **cast-iron table** about 4' by 2' for truing up and assembling work is a great convenience. Extra large work can best be handled on the open floor and supported on horses or trestles of a height to suit the man and the work. These

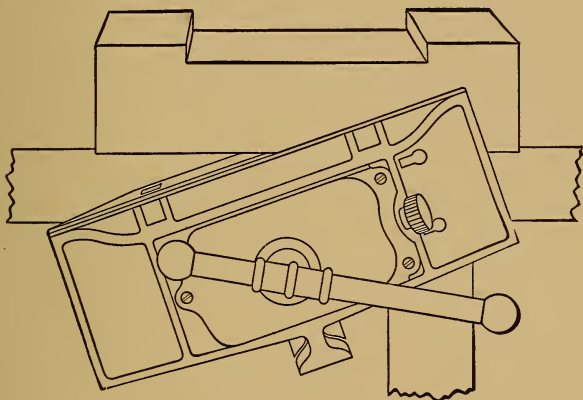

FIG. 10.—Pattern-maker's Vise.

supports should be so carefully levelled that a plumb bob could be used.

The pattern-maker has little use for the ordinary standard rule but uses almost exclusively a **shrink rule** suited to the shrinkage of the metal to be used for the casting. When master patterns are made it is necessary to allow two shrinks. If the working pattern and the casting are to be of the same metal, then it becomes double shrinkage for that metal, but where, for example, the working pattern is to be brass and the casting iron, it means one brass shrink

plus one iron shrink. These combinations make necessary a wide variety in shrink rules which can be had in $\frac{1}{16}$ "', $\frac{1}{12}$ "', $\frac{1}{10}$ "', $\frac{1}{8}$ "', $\frac{5}{32}$ "', $\frac{3}{16}$ "', $\frac{1}{4}$ "', $\frac{3}{8}$ "', and $\frac{1}{2}$ "' per foot. The best

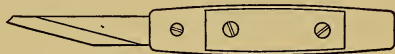

FIG. 11.—Pattern-maker's Knife.

rules are of steel 12" or 24" long. Wooden shrink rules are usually inaccurate and the graduations are coarse.

In as simple a tool as the **knife**, the pattern-maker uses an unusual shape. (Fig. 11.) The large amount of laying out done and the fine whittling, especially in such

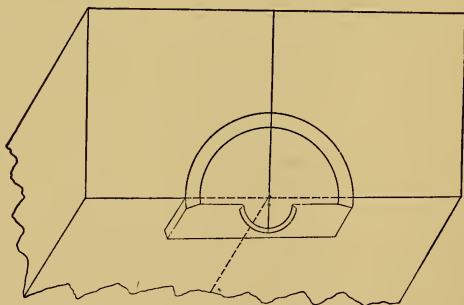

FIG. 12.—The Edge Center.

situations as spokes of small gears, etc., makes the small point shown a necessity, while the shearing cut given by the slope of the blade is highly desirable. This awkward whittling is also responsible for the knife with a bent blade seen in some kits of tools.

When it becomes necessary to strike an arc from a center which is located on the edge of a piece of stock, some means must be found to hold the point of the dividers or trammels. Clamping another piece of wood against the first is often resorted to. The **edge center** shown in Fig. 12 is much handier and is usually more accurate. It should be made of brass and the centers carefully located on the lines as shown.

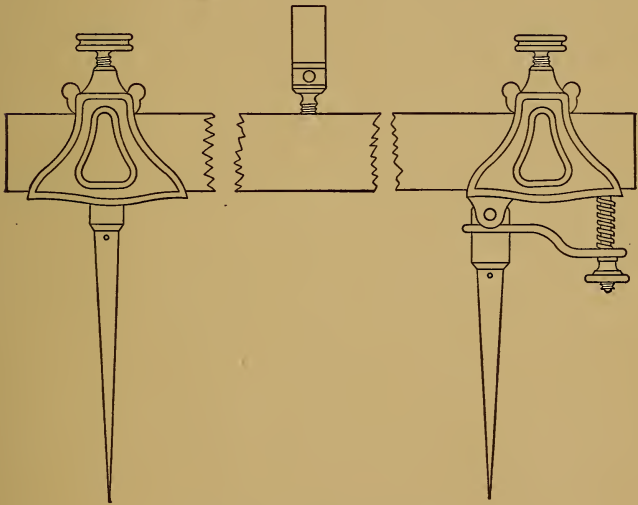

FIG. 13.—Trammel Points.

There seems to be no excuse for making a **center square** in the sizes that are obtainable in the market, but large circular work, especially large gear work, often needs a center square larger than can be bought. In such a case a shop-made tool, if carefully constructed, meets all needs. It may be well to point out that the angle between the two sides of the head need not be 90° as in the commercial

article; it is only necessary that the edge of the blade should bisect the angle of the head, whatever that may be.

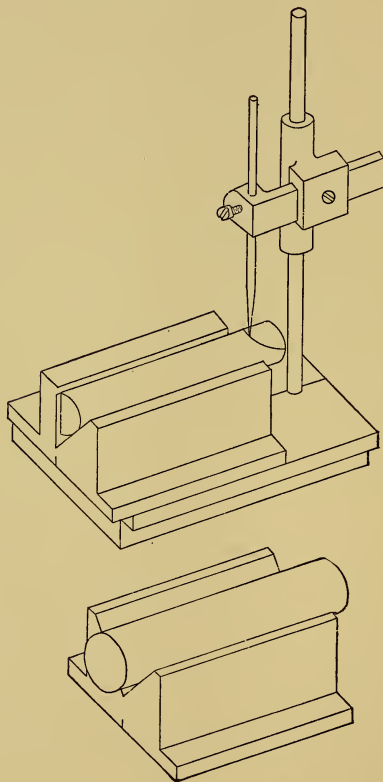

FIG. 14.—Coping Trammel with Cradle.

Trammel points should be made to fasten on the side of a light wooden bar, and one of the points should have a fine adjustment. (Fig. 13.)

A very useful tool for use where circular portions are to intersect is called a **coping trammel**. (Fig. 14.) It consists essentially of a base with a fixed vertical spindle carrying an adjustable rotating head with a sliding pencil or scriber. As an aid in holding either round or parted work while using the coping trammel or during other laying out, **cradles or V blocks** as shown in Fig. 14, are very desirable. They should be made of metal, cast-iron preferred, and laid out very accurately. As they are always used in pairs, they should be planed up in long lengths and cut into sec-

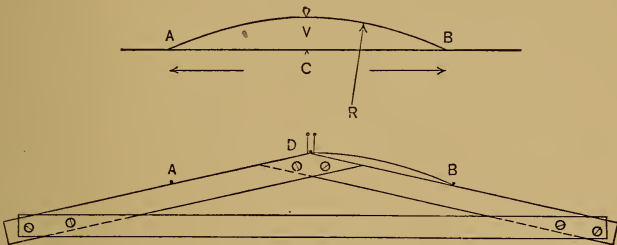

FIG. 15.—Tool for Drawing Arcs of Large Radius.

tions, thus insuring duplication. For drawing arcs beyond the reach of trammels, the method shown has many advantages. To draw an arc of given radius from A to B (Fig. 15) it is only necessary to find the rise of the segment or the versed sine of half the angle at the center by the formula

$$V = R - \sqrt{R^2 - \left(\frac{c}{2}\right)^2}$$

in which V = versed sine, R = radius,

and C = chord. By making a board as shown and sliding it against pins at A and B, the point D will describe the required arc.

A simple tool for laying out hexagons to be worked from the round is shown in Fig. 16. The angle between the

edges lying on the face is 60° and the angle between the edges lying tangent to the circle is $70^\circ 32'$, while a line which bisects one angle also bisects the other.

The good pattern-maker has a large assortment of **paring chisels** and **gouges**, especially the gouges, which are used in every known sweep.

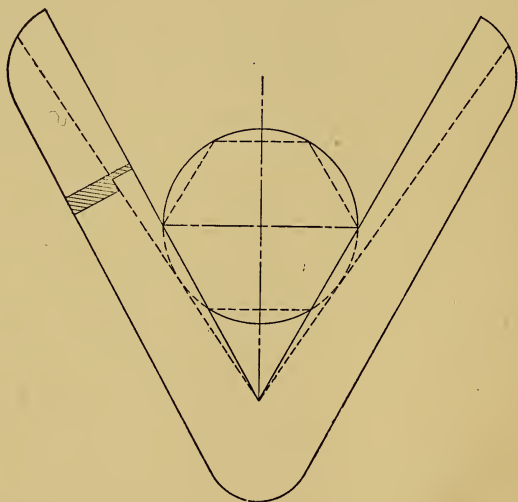

FIG. 16.—Tool for Laying out Hexagons.

Carving tools are also used on small work and especially on stove plate patterns.

The ordinary **planes** of the general wood-worker find full use although the use of the block plane is minimized by the use of a home-made **shoot board** with a jack plane or jointer. This is a step in advance, but the commercial tool (Fig. 17) with an iron base and a plane with a cutter set at 45° with its edge is far more accurate and permanent.

Of the special forms of planes the pattern-maker finds use for the **rabbet** and **routing planes** as well as for the **round soled plane** which is particularly useful in working out core boxes of large radius and fillets from the solid. The **flexible faced plane** (Fig. 18) is useful in smoothing up curved surfaces of large radius, either convex or concave.

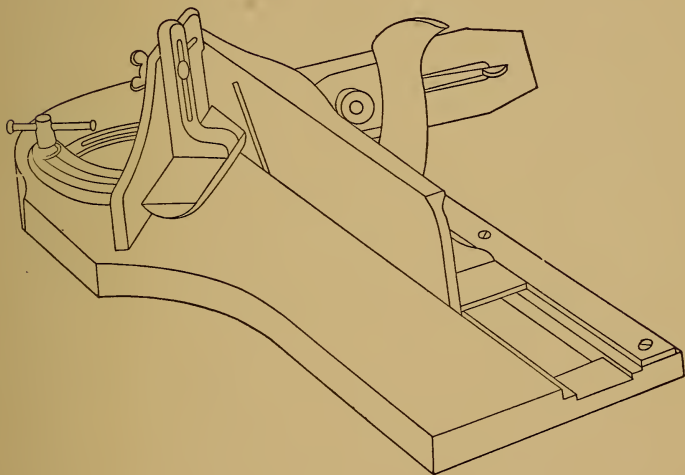

FIG. 17.—Shoot Board.

The **core box plane** is one of the best possible examples of a strictly special tool. (Fig. 19.) Made for the single purpose of working out semi-circular grooves, it performs its function admirably when properly set and intelligently used. The construction of this tool is based on the geometrical proposition that any angle inscribed in a semi-circle is a right angle, and this same proposition proves the accuracy

of the common test applied to semi-circular grooves of having the corner of a square follow the curve. (Fig. 20.) The

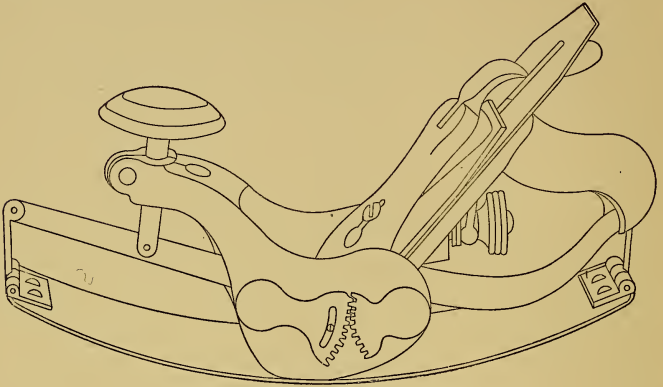

FIG. 18.—Flexible Faced Plane.

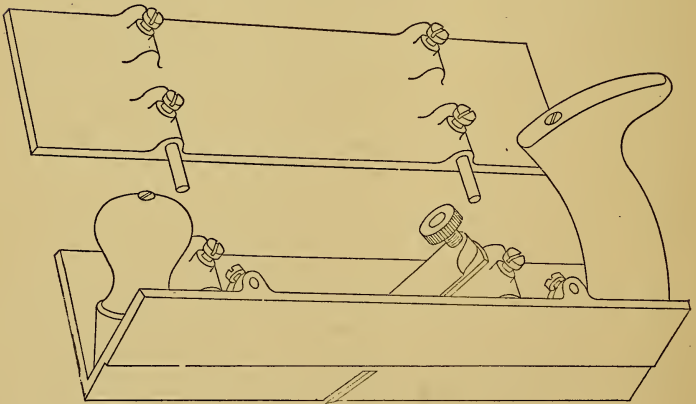

FIG. 19.—Core Box Plane.

edges of the cutters should be exactly in the sides of the angle and not project beyond. This makes it necessary

to cut away the sole on the working side about $\frac{1}{32}$ " deep and $\frac{3}{8}$ " wide. (Fig. 21.) Greater depth would give too

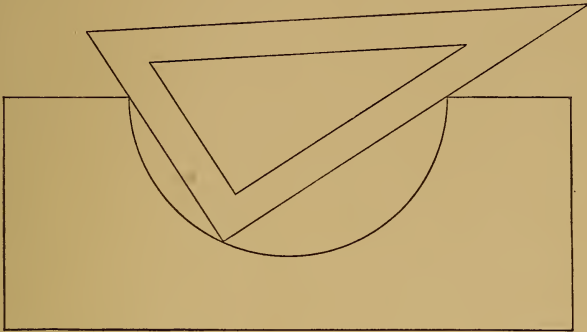

FIG. 20.—Testing Semi-circular Grooves.

rank a cut and make sandpapering difficult. The general method of use is shown in Fig. 22. The method of start-

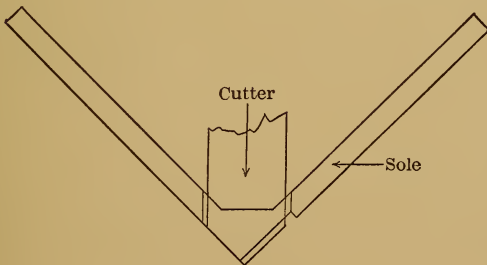

FIG. 21.—Proper Relation of Cutter and Sole of Core Box Plane.

ing may be by taking out the first chip to a knife line with a chisel or by bradding on a thin straightedge for a guide for the first cut with the plane.

The **Forstner bit** is of great service to the pattern-maker as it works beautifully in soft pine. (Fig. 23.)

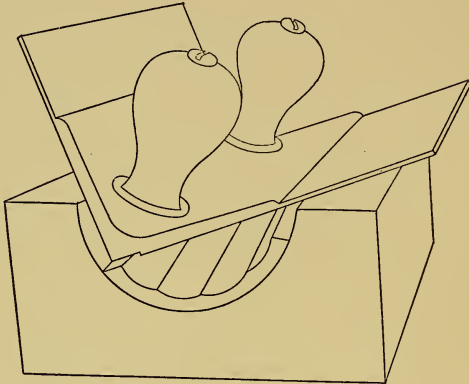

FIG. 22.—Semi-circular Groove Partially Worked Out with Core Box Plane.

Its ability to bore on less than half its area as well as the flat-bottomed hole due to absence of worm and spurs are its chief features.

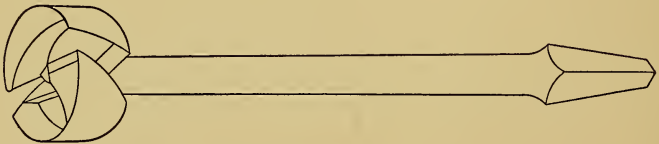

FIG. 23.—Forstner Bit.

For the man working on thin patterns or stove plate work, **thickness calipers** (Fig. 24) and **marking calipers** (Fig. 25) are of great service.

Probably no small tool is at the same time so important and so little known as the **cornering tool** (Fig. 26), which is needed more and more in these days of round corners.

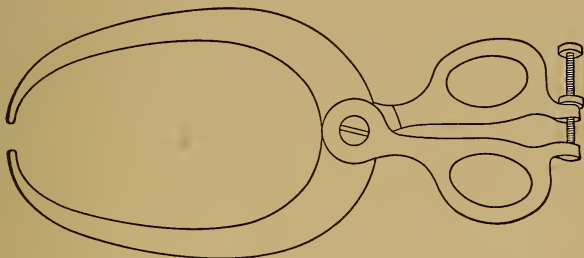

FIG. 24.—Thickness Calipers.

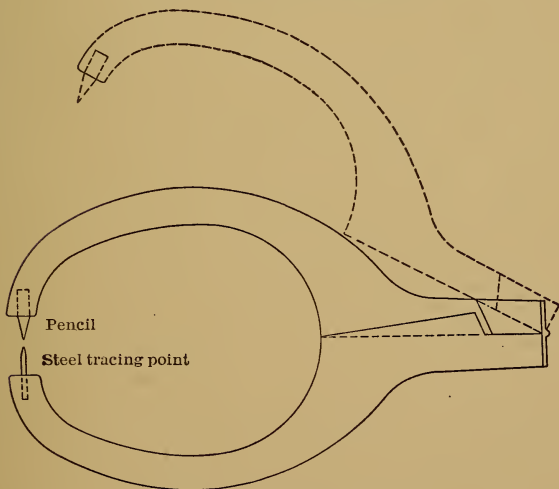

FIG. 25.—Marking Calipers.

16. Machine Tools. In spite of the growing tendency to use more machine tools, the size of the individual work-

man's kit has not become much smaller although the character of the tools has changed somewhat. Many of the operations formerly performed by hand are now handled on machine tools with a tendency to cut down the amount of bench work, but as the old straight operations are taken from the bench the added intricacy of modern pattern work places new obligations on the pattern-maker so that the actual reduction in hand work is not so great as is sometimes claimed.

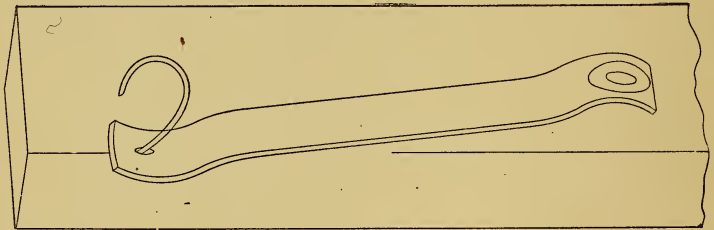

FIG. 26.—Cornering Tool.

The trimmer has taken the place of the block plane and of the shoot board, and with its adjustable angles, makes an almost indispensable tool.

The circular saw is probably used more than any other machine tool. In addition to getting out stock it is used for rabbeting, roughing out core boxes, sawing staves, etc.

The jig saw is not to be recommended except for inside work which cannot be reached with a band saw.

The band saw is used almost as much as the circular saw and when in good condition and properly handled leaves a surface which only needs sandpapering. Every pattern shop band saw should have a tilting table and a fence for ripping stock.

A boring machine with a tilting table is a great advantage in a pattern shop. Small routing cutters such as are shown in Fig. 27, can be used in connection with a boring machine for sinking surfaces, working fillets from the solid, and other operations of a similar character.

Where much circular core box work is necessary, a core box machine will be found to be helpful. The work which

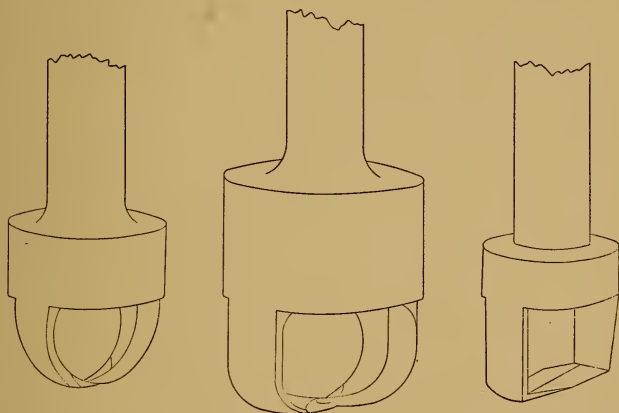

FIG. 27.—Routing Cutters.

can be done on one of these machines is limited only by the ingenuity of the operator.

For surfacing work, particularly if large and heavy, no machine tool surpasses the old Daniels planer, although it is not now in common use. With its cutter speed of 10,000 feet per minute, it leaves a good surface which is as flat as is possible with a machine.

For surfacing small pieces, but particularly for jointing edges, the hand jointer or buzz planer is used. This

tool has taken the place of the jointer plane as the trimmer has taken the place of the block plane.

The **surface planer** or **surfacer**, either single or double, is the tool now most used. The pressure of the rolls, however, usually results in a surface not as flat as that left by the Daniels planer.

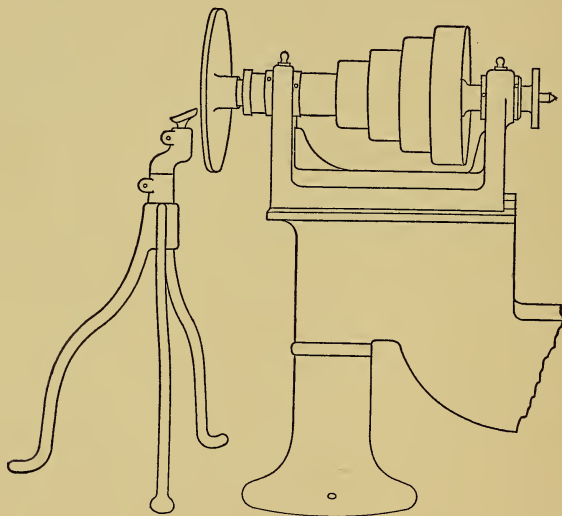

FIG. 28.—End Face Plate and Tripod.

The **surface sander** has been used for years in cabinet work as a finishing tool, but it is just becoming known that sandpaper can be used as a cutting tool. The **disc grinder** of the machine shop is beginning to be used with sandpaper in the pattern shop. It takes the place largely of the trimmer and the finishing planes and is more accurately adjusted and more rapid in operation than either. Moreover it leaves an excellent surface for gluing and is not

put out of commission by running onto a brad. Many of the older pattern-makers do not consider the use of a disc sander as workmanlike, but it is due to make a greater change in the pattern shop than any other modern tool.

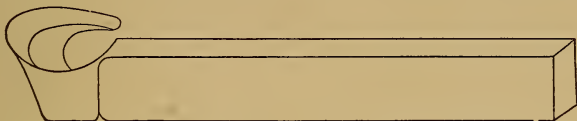

FIG. 29.—Hook Tool.

For turned work there should be at least two lathes, one about 10'' swing and another about 20'' with an end face plate and tripod for extra large work. (Fig. 28.) The

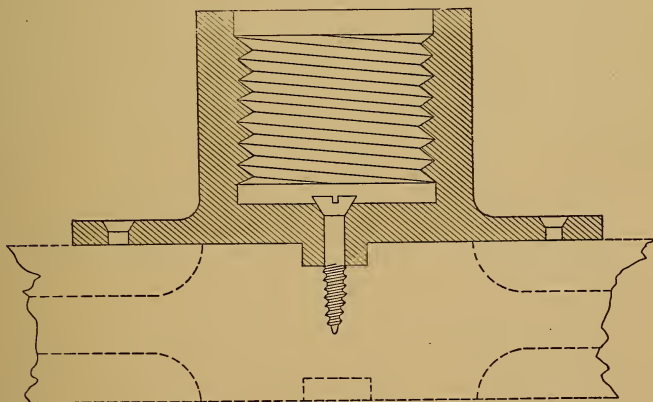

FIG. 30.—Screw Chuck for Rechucking.

highest speed of the small lathe should be about 3000 r.p.m. and in general a speed should be used which will give a surface speed of about 4000 feet per minute. For

the large lathe, probably no tool is of greater use than the **hook tool**. (Fig. 29.) Large built-up face plates should be provided which will remain true and on which patterns may be mounted.

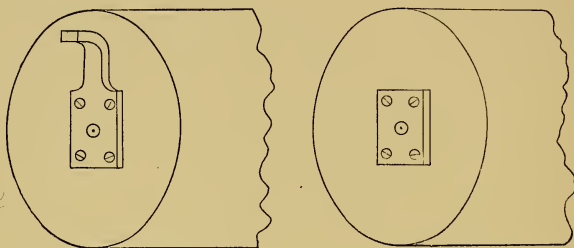

FIG. 31.—Center Plates.

Fig. 30 shows a **screw chuck** which can be used for rechucking. **Center plates**, as shown in Fig. 31, may be used for heavy split work, while lighter work can be held by steel **rings**, by ordinary **pinch dogs**, or by **corrugated fasteners**. (Fig. 32.)

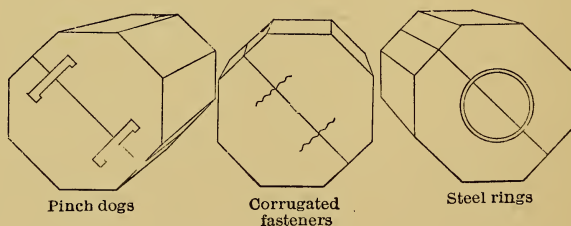

FIG. 32.

All machine tools require care to keep them in good condition and due to the high speed of all woodworking tools, the bearings should receive much attention. They

should be kept well lubricated and not allowed to become loose. No machine tool should be used without such guards as do not interfere unduly with its operation. The buzz planer particularly should be equipped with a safety cylinder and a guard to cover the throat of the machine.

17. Shop Conditions. Nothing is gained by keeping the shop equipment down, by crowding either men or tools, or by lack of air and light. Men waiting for a chance at a machine are costing the concern money as well as forming bad habits. Cramped quarters are always undesirable, especially on fine work with edge tools, and the crowding of machine tools is not only conducive to slow operation, but is positively dangerous on account of the chance for interference.

Good ventilation is necessary to keep men in condition to work effectively, while good light is not only desirable for the production of fine work but is also one of the best preventives of accidents. Plenty of air without drafts and plenty of light, from above if possible, should be the rule in every up-to-date pattern shop.

CHAPTER V

LAYOUTS AND TEMPLETS

As the choice of the particular method of molding to be used and the allowances for finish and draft may make the pattern have but little resemblance to the drawing from which it is to be made, either in shape or in dimensions, it follows that some method of recording this new shape and these new dimensions must be followed. Usually the drafting room makes drawings of the finished machine and its various parts for the benefit of the machinist, but no drawings of the patterns are furnished for the pattern-maker.

18. Layouts. If the pattern-maker thinks he needs a drawing of the pattern he must make it himself. He wants it to be in a form which will allow of ready consultation and which will keep its shape. As paper changes in a marked degree with the amount of moisture present, he uses wood, usually white pine, as a material better suited for a dependable record as well as to the tools he is accustomed to use. In order to have his record available for direct reference as well as to avoid the necessity for putting on dimensions, he makes his drawing full size and uses the appropriate shrink rule in laying it out. The result is called a **layout** and is the most important step in pattern-making, for it not only shows the method of molding to be used, and the allowances to be made, but may also be used to show the details of construction.

As the layout is made on wood and by a man who is more accustomed to wood-worker's tools than to those of a draftsman, we find the T-square and triangle replaced by the marking gage and try square, and the compasses by the dividers, while the knife takes the place of the pencil. In using the marking gage for lines parallel to the trued edge of the layout board, every setting must be checked up by the shrink rule, for the graduations on the marking gage are standard. The spur of the marking gage should be set so as to make a line as nearly like a knife line as is possible, a fine line being as necessary in laying out on wood as is the case on paper.

The same knowledge of geometrical construction that is necessary in drafting room practice is needed by the pattern-maker in making his layouts. The same degree of accuracy is also needed; layouts containing errors in drawing being as bad as blue prints with false dimensions.

In using a layout, dimensions are taken off directly by the same shrink rule that was used in making it, or by dividers applied directly to the points to be used.

19. Use of Pencil and Colors. The use of a pencil in making a layout should not be allowed, but when the layout is completed, a medium hard, chisel pointed pencil should be used to emphasize the lines made by the knife, gage, and dividers. If cross hatching is to be done, it should be free hand with wavy lines. Tinting with colored pencil or chalk is also resorted to. Lines which illustrate methods of construction should be clearly differentiated from those of the pattern proper. To make these pencil lines stand out clearly as well as to keep the layout clean, a single coat of orange shellac should be applied.

20. Specializing. Some years ago, one man made each pattern complete from the receipt of the blueprint to the

delivery of the pattern to the foundry. The first tendency toward specialization was seen in turning over the putting in of fillets, sandpapering, and shellacking to younger men or apprentices. More recently there seems to be in evidence a tendency to give over the making of the layouts as a specialty to one man, or, in the case of some small shops, to the foreman. Then again, some shops are turning over the getting out of stock to specifications to a mill gang, so there is left but one other stage in pattern con-

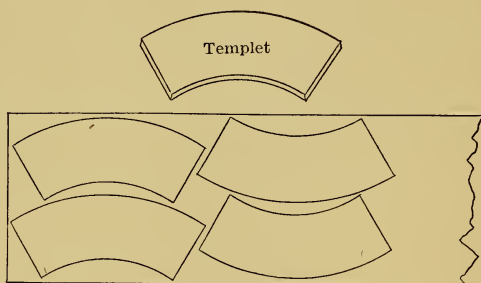

FIG. 33.—Marking Templet for Segments and Outlines Marked on Stock.

struction, namely, the actual building of the pattern out of stock already gotten out and in accordance with a layout already prepared. To be considered a good craftsman, one should be well trained in all these departments, but the greatest responsibility seems to lie in layout making.

21. Templets. When getting out stock for a pattern, it often happens that several pieces of the same shape, although possibly of varying thickness, are required. The shape of these pieces usually allows for subsequent working to finished form and so is not particularly accurate. In order to duplicate these pieces rapidly, it is customary

to lay out the shape on thin wood and cut to form. This makes what is known as a **marking templet**. By running a pencil around this outline, the shape is quickly laid out on the wood to be used and the pieces can then be band sawed. Waste of stock can often be lessened by reversing the templet as shown in Fig. 33.

While a pattern is under construction, many tests must be applied to make sure the work is progressing in accordance with the layout. When it is merely a question of diameters

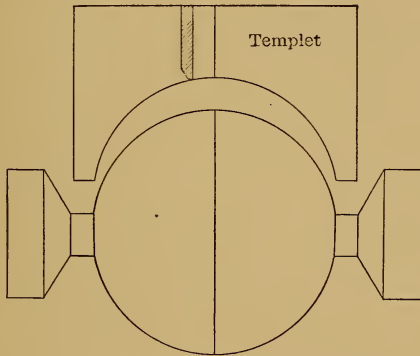

FIG. 34.—Form Templet for Sphere.

or of surfaces which can be tested with a straightedge or square, no special tools are necessary, but it often happens that a curved surface or an irregular outline is to be made which cannot be tested with any of the ordinary tools. In such cases it is necessary to make a reverse of the surface or outline which can be applied directly to the pattern. These outlines are called **form templets**. They are laid out very carefully on thin wood, band sawed close to the line and finished with knife, chisel, and file. Even with thin wood

it is difficult to make the edges exactly square and as the outline must be exact, the templet is backed off (Fig. 34) until the edge to be applied to the work is about $\frac{1}{32}$ " thick. When the pattern is close to shape, this thin edge may be rubbed with a soft pencil before applying the templet to the pattern, so a black spot will indicate the portion of the work which needs reduction.

CHAPTER VI

MATERIALS—CONSTRUCTION, FASTENING AND FINISHING

THE material used in the construction of a pattern depends very largely on the way and manner in which it is to be used. For example, a temporary pattern from which only one or two castings are to be taken, does not need to be made of as good material or to be constructed in such a careful manner as would be the case if long life and constant use were contemplated.

22. Pattern Materials. The materials most often used for making patterns and named in the order of their general use, are wood, cast-iron, brass, aluminum, and plaster of Paris. The use of wood for this purpose is so general that a pattern-maker is usually understood to be a wood-worker. The advantages of wood as a material for patterns as compared with other materials are that it is light and portable, easy to work or to alter, and comparatively cheap. Its disadvantages are that it tends to change its shape, is so soft as to be liable to injury, and, being used in many small pieces, is apt to come apart if great care is not taken in construction. Of these defects, the tendency to warp is the most vital, as changes too small to be visible might seriously affect the castings. Therefore those woods which have the least tendency to change their shape are chosen for pattern work. Only three are used to any great

extent: **white pine, cherry, and mahogany.** Any wood which has been quarter sawed, i.e., sawed so that the annual rings are nearly at right angles to the face of the board, (Fig. 35), is less liable to warp than that which has been

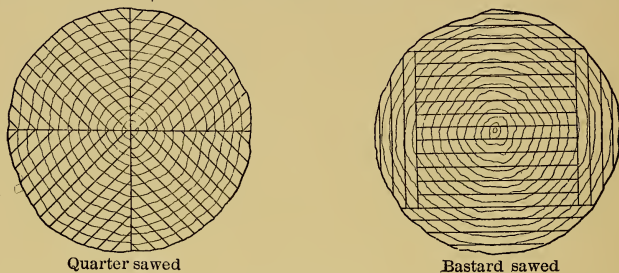

FIG. 35.

straight or bastard sawed. In drying out, the rings tend to become straight so the heart side of a board will become rounding or convex. (Fig. 36.) In very small, particular work it pays to select a board which has the rings running directly through it.

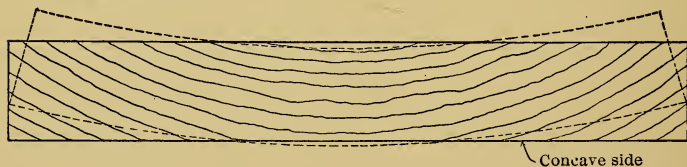

FIG. 36.—Warping.

The best pine probably is clear Michigan pine, although California or sugar pine is used by many, especially on large work. Strictly speaking, the latter is not a true pine but looks and works much the same. The cherry used is from the large trees of the Middle West. It is much harder

than pine, not so straight grained, cannot be had in such large, clear lengths, but is used for small patterns subject to continual hard usage. Most of the mahogany is from Mexico near the Gulf of Campeche and would be more properly called bay-wood as it is much lighter and softer than a true mahogany. True mahogany would not be a suitable wood for patterns as it is too heavy and too hard to work readily. This bay-wood is somewhat harder than white pine, can be worked almost as easily and is obtainable in long, clear lengths, but it is the most expensive of the three woods mentioned. It is also an open grained wood and requires extra treatment to obtain a clean, smooth surface.

23. Glue. In the construction of patterns, the various parts have to be held or fastened in a way which is sometimes temporary and sometimes permanent. Probably no one method is more used than that which involves the use of glue. The pattern-maker recognizes two kinds: **cold or liquid glue**, and **hot glue**. The first is usually a fish glue kept liquid by the addition of acetic or of nitric acid. It hardens slowly, does not chill as readily as hot glue, and is valuable where construction is complicated and the work of assembling the parts is slow. It is not considered to be as reliable or as strong as hot glue.

The best hot glue is made from hides, for which reason it is sometimes called animal or hide glue, and comes to the pattern shop in the form of hard, semi-transparent sheets. These sheets are broken up, soaked in cold water for about twelve hours, then cooked slowly until perfectly fluid. Some pattern-makers prefer to use ground glue and thus save nearly all the time of preliminary soaking. Adulteration is so much easier to conceal in ground than in sheet glue, that it is unsafe to use the former unless one is sure

of his source of supply. The better the glue the more water will be absorbed, thus adding to the quantity. This glue should be used hot and comparatively thin, and should not be chilled by cold wood or by drafts of air. The combination of a warm room, hot thin glue, warm wood, and rapid work produces the best results. When making up a glued joint, all the surplus glue should be removed either by rubbing the joint by hand or by clamping with hand screws or cabinet clamps. Steel pinch dogs such as are

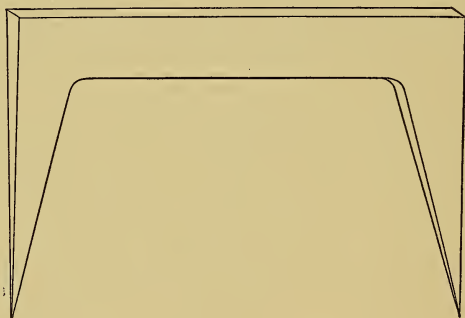

FIG. 37.—Pinch Dog.

shown in Fig. 37, are also used to hold work while glue is hardening. The bevel being on the inside tends to close the joint. The holes made are the principal objection to this type of clamp.

24. Sizing. The end grain of wood absorbs glue so fast that it is always well to give it a preliminary coat of glue called **sizing**, which closes the pores and allows the regular coating to unite the pieces. If a large amount of end grain is to be glued, it is profitable to use a thinner and cheaper glue for sizing than that used for its holding power.

25. Fasteners. The ordinary nail, either cut or wire, is used but little in the construction of patterns, but **brads** are used quite extensively. They are usually long and slender, such sizes as $\frac{5}{8}$ "-20 and 2"-15 being common. As brads are used principally as a reinforcement to glue, the holding power of a large head is not needed, while the hole made by the comparatively small head is more easily concealed. As a temporary fastening while gluing, especially on thin light work, the long and slender **looking glass tack** is well suited. The head is of no consequence, but the needle-like point enters easily with but little tendency to split the wood. Brads as a permanent part of a pattern are the despair of the man who has to repair or to alter it, and are the cause of many damaged tools and tempers.

Screws not only make a pattern which is stronger, but also facilitate repairs and changes. Round head screws, the length of which is measured under the head, are not much used in pattern work; the flat head screw, whose length is measured over all, is much more common. Here again a long and comparatively slender fastening is preferred, in such sizes as 2"-No. 12 or 1"-No. 10.

26. Dowels. When two parts of a pattern are not fastened together permanently, but simply held so that there can be no side motion, it is customary to use **dowels** for thus locating the parts. These dowels are usually round and of either wood (birch or maple) or of metal (brass or cast-iron). Those made of wood fit into holes bored in the pattern, while metal dowels have metal sockets. Large dowels for heavy work are provided with a plate for the dowel and one for the socket and these plates are let in flush with the surface of the pattern. (Fig. 38.) Metal dowels cost more than wooden ones and are more expensive to put in place, but they do not shrink or swell and stand much

more wear than those made of wood. Moreover, the plates may also have holes for rapping and drawing and thus save the wear and tear on the pattern caused by the ordinary draw nail or iron which is simply driven into the wood.

As dowels are usually placed near the ends of a pattern, the plate of either cannot be used for drawing, if that operation is to be done by one hand. For that purpose, a **rapping and drawing plate** having no dowel would be inserted at the center of gravity of the pattern, so that it would balance when drawn. On large work three or more plates

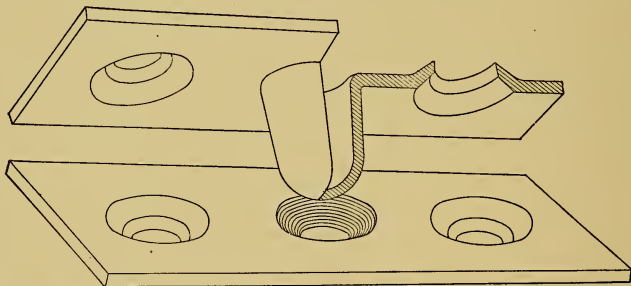

FIG. 38.—Dowel-plates.

might be used, with chains leading from the draw irons and the whole lifted by a crane.

27. Corners. Probably the greatest difference between the castings of fifty years ago and those of to-day lies in the still increasing use of the round corner. The round outside corner looks better, handles better, and molds better than a square one, and this is also true of the inside corner. The greatest benefit of the round inside corner cannot be seen, however, but consists of the production of a sounder and stronger casting. The cooling strains produce an effect similar to that shown in Fig. 39.

The round outside corner is worked down from the easily made square corner. It is also easier to make a square inside corner than to work it out round from the solid. To avoid this working out, it is customary to make a sharp inside corner and afterward put in the quarter round in the shape of a fillet. This may be of wood, wax, leather, putty, or lead. On long straight work a wood fillet is easily applied, but it cannot be worked around curves of short

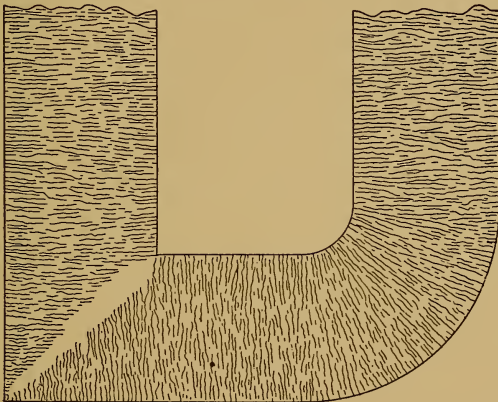

FIG. 39.—Section of Casting Showing Weakness due to Sharp Inside Corner.

radius. It is made with an angle of a little over ninety degrees so that the feather edges will lie closely against the sides. (Fig. 40.) Small brads hold it in place while the glue or shellac used to fasten it has time to set.

Pure beeswax is used for fillets of small radius, as it is easily pushed into place and shape by a fillet tool of proper size. The best fillet tool is a shank carrying a steel ball which may be warmed over an alcohol lamp.

In the absence of the steel ball or of the lamp, a piece of maple dowel rounded on the end and soaked in machine oil makes a good substitute, although it takes a little more pressure. The presence of rosin in the beeswax makes it harder, but so brittle that it cannot be worked satisfactorily. It is easier and more economical to use it in the form of wax wire made of proper size by a wax gun in which warmed wax is pushed through a hole by a plunger. Wax makes

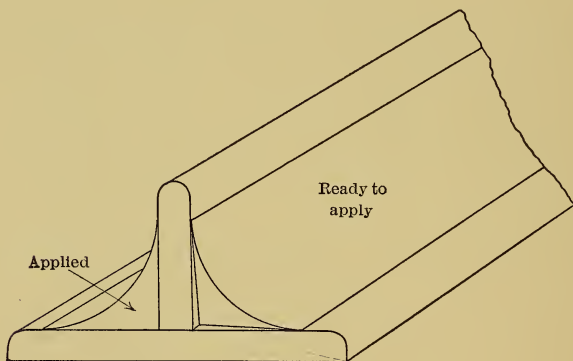

FIG. 40.—Wood Fillet.

a comparatively soft fillet and one which will stick to the sand unless it is well covered with shellac. It holds better if applied to the pattern after the first coat of shellac has been rubbed down.

Leather is probably the most satisfactory material for fillets as it is fairly hard, flexible, light, and is easily and permanently applied. It is cut in strips in the shape shown (Fig. 41) and is rubbed into place with a fillet tool after shellac has been applied in the corner and to the back of the fillet. Putty and lead are cheap especially

for large fillets, and are easily applied, but both tend to jar out, putty especially.

28. Marking Patterns. Patterns should be marked in some way for identification, and usually this mark is reproduced in the casting. Firm names, patent dates, and directions often appear in raised letters on the casting. All these must be applied to the pattern in the form of **pattern letters** which should have plenty of draft. If very small, they may be embossed on a thin sheet of alu-

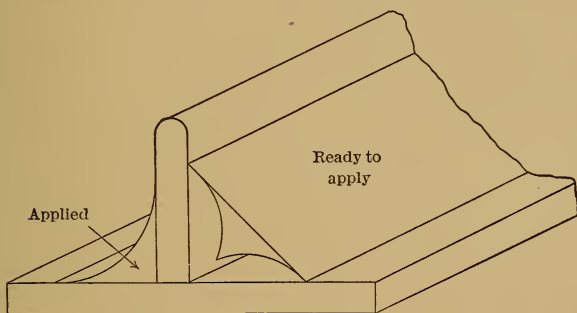

FIG. 41.—Leather Fillet.

minum. Larger letters and figures are made of a soft lead alloy or of brass, Roman and sharp Gothic being the usual styles. The soft alloy allows them to be placed on curved and irregular surfaces. Metal patterns usually have brass pattern letters which are soldered on.

29. Finishing. After the tool work on a pattern has been completed, it is smoothed up with **sandpaper**. This consists of quartz sand or of pulverized glass glued to a paper backing. The grades run from No. 00, which is very fine, to No. 1½, which is certainly as coarse as should ever be used on a pattern. Sandpapering by hand should

never be used to change shape, but simply to remove tool marks. It is not a cutting tool, as its action is purely that of scraping.

A pattern with the bare wood exposed would not stay in shape because the absorption of moisture from the damp sand would cause warping. Neither would it draw easily, as the sand would cling to the wood. In order to overcome both these objections, patterns are covered with a varnish which presents a hard, smooth, and impervious surface.

Oil varnish is not commonly used on patterns as it takes too long to harden. **Spirit varnish**, or gum shellac dissolved in alcohol, dries much quicker and is hard enough. Grain alcohol is best, denatured alcohol is very good, and wood alcohol very poor. The yellow flake gum shellac, when cut in alcohol, produces what is called orange shellac. When it becomes dark and dirty from age and use, the color may be restored by stirring in a small quantity of pulverized oxalic acid. Different colors are produced by adding colored pigments or aniline dyes to the orange shellac. Lampblack, first made into a paste with alcohol, will give black shellac. Other colors used are red, green, and yellow. There is no generally accepted standard for the different colors, but core prints and core outlines on the drag part of the pattern on the one hand, and the surfaces concealed by loose pieces on the other hand, must have colors which distinguish them from the pattern proper. Paint is sometimes used for pattern protection. Two or three coats give a thick, hard coating, but the time taken for drying is so great that it is not often used.

As alcohol evaporates rapidly, there should be tight covers on shellac pots with some arrangement so that the brushes will hang in the shellac and not rest on the hair or on the bristles.

Iron patterns should be first rusted by a solution of sal ammoniac or ammonium chloride with water. The pattern is then rubbed down and a hard wax is applied by warming the pattern and flowing the wax over it. When the surplus wax is removed the pattern will have a smooth glossy surface which will part from the sand much easier than the bare iron.

CHAPTER VII

TYPES OF PATTERNS

THE different methods of molding, the variations in pattern construction, and the features desired in finished castings all combine to make a large number of molding possibilities. The pattern in any given case may be any one of several different types, and it is impossible to say without a knowledge of all the conditions, just what type of pattern should be used. It will probably be better for the purposes of this volume to mention the types by name, and show such patterns as will illustrate them.

30. Determining the Type of Pattern. The factors which combine to determine the type of pattern may be classed under three heads; those of the pattern shop, those of the foundry, and those of the machine shop. The convenience of any particular trade should not be the controlling influence in the choice of the type of pattern. The making of the pattern is only one step toward the production of satisfactory castings at minimum cost. It will be noted that the character of the casting is placed before its cost, because an unsatisfactory casting is dear at any price.

The machine shop views castings from two angles; on the one hand, a casting must be easy to hold, and on the

other hand, it must be easy to work. The strength of the casting and its fitness for the work it has to perform is a matter decided by the designing department before the patterns are made. The foundry is principally concerned with the method of molding. It naturally wants the pattern made in such a way that the labor cost of getting out the casting will be reduced to a minimum. The pattern shop is concerned primarily with meeting the requirements of the foundry and the machine shop with the least expenditure possible for labor and material. Thus we see that no one of the three shops can expect to have its own convenience followed out in full. There should be a consideration of the convenience of all, before the pattern is started.

31. One-piece Patterns. Solid patterns in one piece are sometimes made from such materials as clay, wax, sand, or plaster of Paris, but they are not permanent and are usually used only where a single casting is desired of a comparatively simple piece. In some cases the nature of the material makes it necessary to destroy the pattern in order to get a casting from it. We are dealing more particularly with permanent patterns which are usually made of wood.

The simplest type is usually known as a **one-piece pattern**, meaning that the pattern is made from a single piece of wood. Such patterns are usually cheap because no time is taken for building them up, but they are subject to the disadvantage of being apt to warp, and in the case of a large pattern, would require too much stock even if the size to make a solid pattern could be obtained. As an example of the one-piece pattern we may consider a small cylinder (Fig. 42). The diameter may be relatively great or small and the method of making the pattern would

depend, somewhat, on this relation. Usually the pattern would be made so as to have the shortest draw possible. If the cylinder is to be molded horizontally, it may be bedded into the drag, or the mold can be coped down to the parting line on the pattern. If it is molded vertically, the complete mold would be in the drag. The decision as to

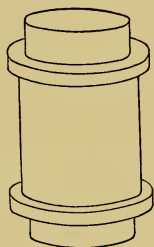

FIG. 42.

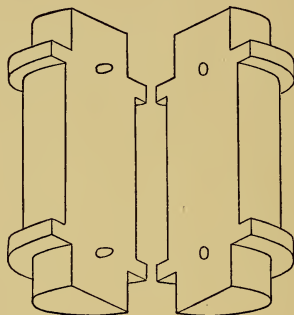

FIG. 43.

which type of pattern to make would turn largely on the depth of draw involved. Such a pattern molded horizontally involves extra labor on the part of the molder, but would be justified in case very few castings were required.

32. Split Patterns. If many castings of the above cylinder were required, it would be better to make a **split pattern** (Fig. 43). This involves more labor for the pattern-maker, but it gives the molder a chance to make his parting with less labor, and as this has to be repeated many times, the extra work of the pattern-maker is justified.

33. Use of a Follow Board. Another type of pattern is made on a follow board (Fig. 44). This is done for one of two reasons; to give the molder a chance to make his

parting readily with a pattern of irregular outline or, to support a thin pattern which might be injured during ram-

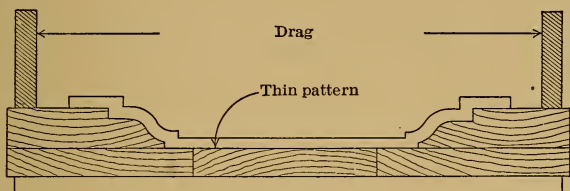

FIG. 44.—Section of Follow Board.

ming up if it were not carefully protected. Stove plate work is an excellent example of this last requirement. (Fig. 45.)

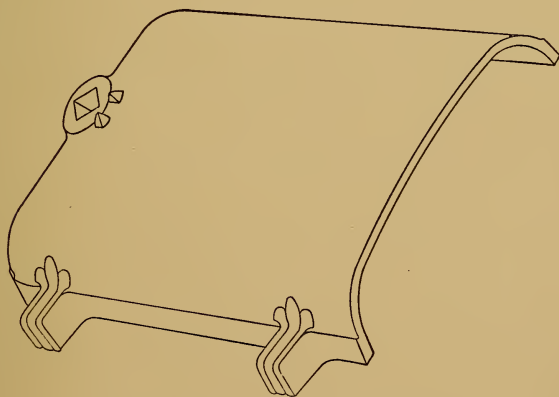

FIG. 45.—Pattern for Range Door.

34. Built-up Patterns. A built-up pattern, that is, one made of several pieces, may be made in that way for several reasons. It may be to save time, to economize

stock, to get a stronger pattern, to prevent warping, or for any combination of these reasons. A frail pattern

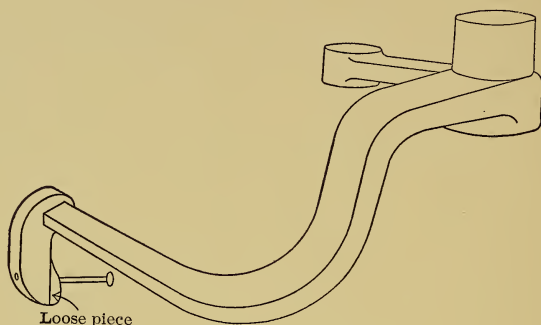

FIG. 46.—Frail, Irregular Pattern.

(Fig. 46) would certainly be made in this way. If made from a single piece, it would not be strong enough to stand ramming and it would certainly warp badly. A more

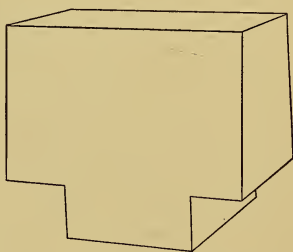

FIG. 47.—Simple Pattern.

stocky pattern (Fig. 47) could be made from a single piece as far as strength is concerned, but probably it would not stay in shape.

35. Cores. A piece which is to be cast with a hole in it may be made in either of two ways. By the simpler method there is a hole in the pattern with sufficient draft to prevent the sand from being disturbed. (Fig. 48.) As the sand which causes the hole is a part of the mold proper, it is called a **green sand core**, or, as it is sometimes expressed, the pattern "draws its own core." This

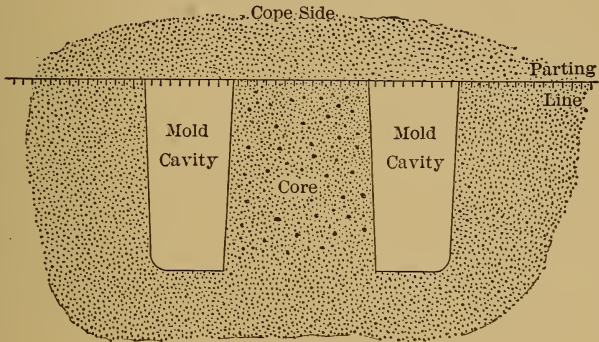

FIG. 48.—Green Sand Core.

method is often used when the hole is vertical and of a comparatively large diameter so that the core is well supported. A pattern which draws its own core is usually cheaper for both the pattern-maker and the molder, the casting is easily cleaned, and the surface is comparatively smooth.

On the other hand, if the hole is to be small or if it is to be at an angle to the vertical, a **dry sand core** is used. (Fig. 49.) This makes it necessary for the pattern-maker to make a core-box and the core-maker in the foundry to make a core which must be set by the molder. Molds

requiring cores are more expensive and there is some danger of injuring the mold when closing on the cope. The dry sand core makes a casting more difficult to clean and leaves a rougher surface. For all these reasons the green sand core method is preferable where it can be used.

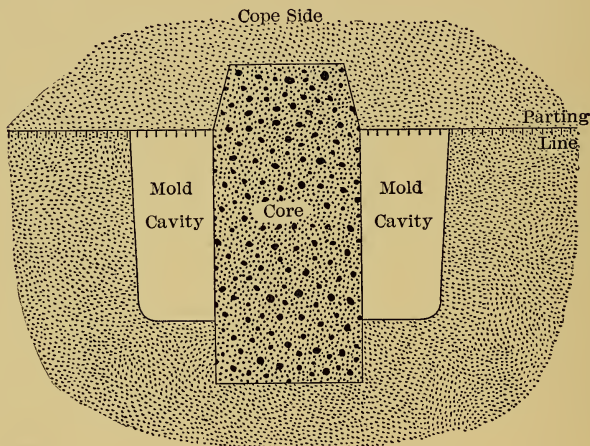

FIG. 49.—Dry Sand Core.

36. Part Patterns. Under certain conditions it is only necessary to make a **part pattern**. When the complete mold can be divided into a number of exactly similar parts, a pattern for one part may be used successively until the whole mold is completed. (Fig. 50.) This saves stock and time for the pattern-maker and in many cases is more convenient for the molder. Sometimes a part pattern is made to use in connection with a skeleton pattern or to make a part of a swept-up mold.

37. Skeleton Patterns. When the surfaces of a large

pattern consist principally of true arcs or of plane surfaces a **skeleton pattern** may be made which is merely an outline of the casting to be produced. (Fig. 51.) The sand surfaces can be struck up by means of strickles or strikes which are guided by this outline. On large work this gives

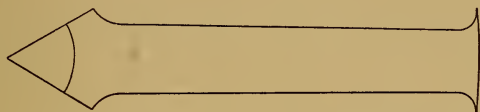

FIG. 50.—Pattern for Hub and Spokes, 6-armed Sheave, Rim to be Swept up.

great economy of time and material in the pattern shop which more than offsets the extra labor of the molder.

38. Metal Patterns. When small castings are to be produced in large quantities, metal patterns are prepared, **gated**, and used in connection with a molding machine.

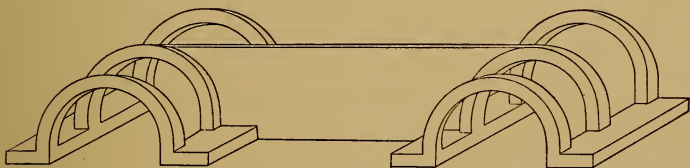

FIG. 51.—Skeleton Pattern.

A wooden master pattern is first made with an allowance for two shrinks; one for the metal of the working patterns and one for the metal of the desired castings. The castings for the metal patterns must be finished very carefully and then joined together to form a gate. (Fig. 52.) The

metals^e used for these gated patterns are cast-iron, brass, white metal, and aluminum, which are named in the order of their desirability.

39. Special and Irregular Patterns. If it is necessary that a casting should show little or no draft, as is the case in cast gear teeth, a pattern without draft may be made and drawn through a **stripping plate**. (Fig. 53.) This

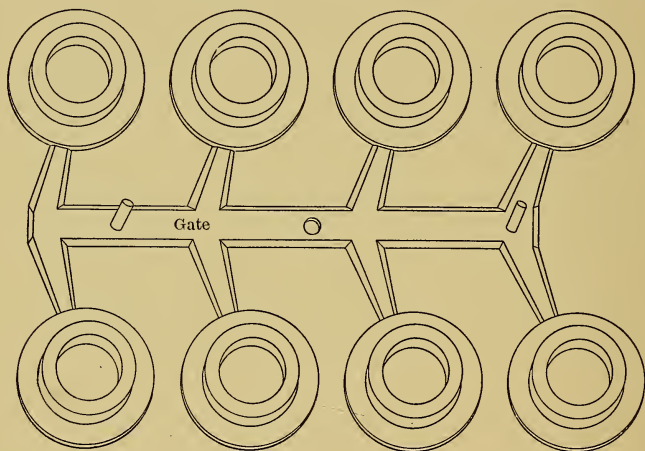

FIG. 52.—Gated Patterns.

holds the sand when the pattern is being drawn and thus makes draft unnecessary. Such a stripping plate, if it is to be used constantly should be made of metal and a metal pattern is also desirable. This work is usually put on a molding machine which draws the pattern mechanically.

When a pattern is irregular in outline so that the parting line cannot be made easily, an **odd-side** (Fig. 4) can be made of a mixture of molding sand and litharge in the proportion of eleven to one which is moistened with

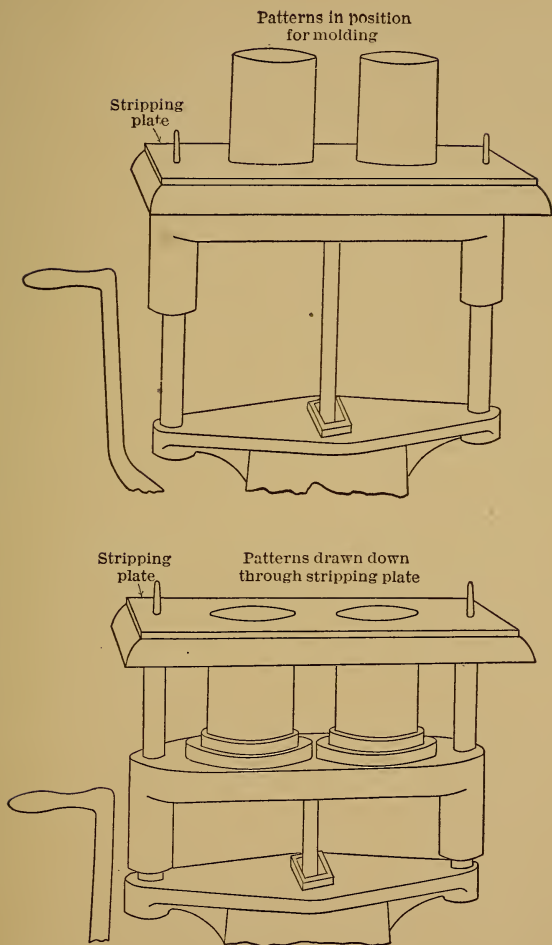

FIG. 53.—Molding Machine Arranged to use Piston Patterns.

boiled linseed oil. When the pattern is bedded to its parting line in this mixture we have, in effect, a follow board. The odd-side becomes very hard and the pattern may be removed and replaced as many times as are necessary.

Another method of producing this result is to place the cope and drag parts of the pattern on opposite sides of a heavy plate which is guided by the pins of the flask. This forms what is called a **match plate** (Fig. 54) and is more

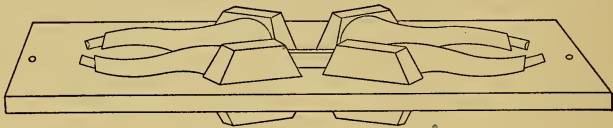

FIG. 54.—Match Plate for Four Teakettle Spouts.

expensive but more accurate and permanent than an odd-side.

40. Chilled Castings. When chilled castings are to be made, iron for chilling purposes must be introduced in the flask either as part of the flask itself as in the case of car wheels (Fig. 3) or placed in a pocket in the mold the same as a core. This latter method requires a print on the pattern to form a pocket for the chill. The amount of iron in the chill should be two or three times as great as in the portion to be chilled and the pattern-maker must arrange his pattern accordingly.

CHAPTER VIII

CORE PRINTS

41. Core Prints. A core print is a projection on a pattern or core-box for making an impression to support a core. The cores placed in the impressions thus made are usually composed of a mixture of coarse clayless sand and a binding material, which when baked gives a hard core. As the moisture is dried out of the sand by baking, they are called dry sand cores. If a separate piece like a core is to be introduced in a mold, there must be an impression in the sand which will locate and support it. This is the office of the core print, which for easy and accurate location is usually attached to or made a part of the pattern itself. When the reversal of a core in a mold would spoil a casting, the core prints must be made of such shape and size that the molder would find it impossible to set the core in any position except the proper one.

In Fig. 55, it will be noticed that the tapered print is made loose, for the molder wishes to lay the pattern on the mold board with the flat surface, on which this print is located, down, and any permanent projection would be in the way. When the pattern is rammed up and the drag rolled over, the broad surface is uppermost and is to be covered with the cope. The tapered print will thus be entirely in the cope and for this reason the **tapered** or **loose print** is often called the **cope print**. The angle of taper

is made comparatively large in order to steady the core when closing on the cope. There is no standard for this angle, but an angle of 15° with the axis, making 30° included angle, is easy to lay out, is satisfactory in use, and might well be adopted as a standard.

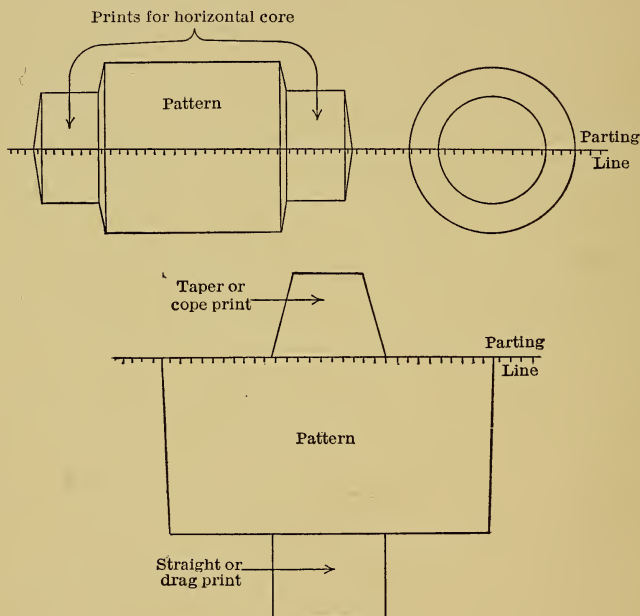

FIG. 55.—Simple Core Prints.

The drag or nowel print is nearly straight and has only enough draft to allow it to part from the sand readily. This print is so nearly straight that it is often called the straight print. As its presence does not interfere with the molder's operation, it is usually fastened to or made integral with the pattern proper.

The length of these prints should be only enough to furnish sufficient bearing in the sand so the weight of the core will not tend to crush the mold. When the core is supported at both ends, it is not necessary for the length to equal the diameter even in the smallest sizes, and as the diameter of the core increases, the proportionate length decreases until we have a length of about six inches for a core fifteen inches in diameter.

Prints for round cores can be turned with a dowel which locates the print accurately on the pattern whether the

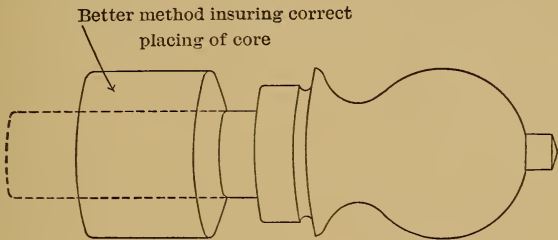

FIG. 56.—Pipe Ornament Pattern.

print is to be loose or solid. By adopting a standard size of dowel, it is possible to use a wide variety of print sizes on the same pattern. One of the common uses of cores is to cause holes in the hubs of gears or pulleys which are to be bored out to fit different sizes of shafts. For this purpose, different core prints may be used on the same pattern, thus getting a variation in the size of hole, and if the size of the hub will not allow enough range in the size of the hole, the pattern may have interchangeable hubs.

When the core is supported at one end only, and especially if it lies horizontally in the mold, the core must be made long enough so that the part resting on the sand will

more than balance the unsupported portion. (Fig. 56.) To bring this about, the prints for such cores have to be made longer or of a greater section than is the case where the crushing effect is the only point to be considered, and such patterns are said to be made for a **balanced core**.

When a core is to be located in a portion of the mold that is below the parting line, the print must not only form

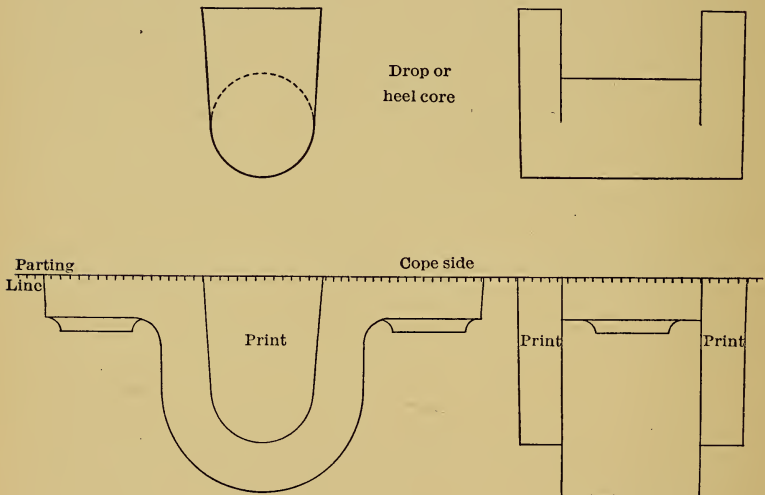

FIG. 57.—Drop or Heel Prints.

a pocket for the core to rest in, but it must also make an opening in the sand through which the core may be passed to its proper place. (Fig. 57.) These are called **drop or heel prints**.

For all these reasons, the core print attached to a pattern very often does not convey any idea as to the shape of that part of the core which actually causes the hole in a

casting, and consequently work involving cores and core prints calls for a great effort of the imagination on the part of the pattern-maker and makes it one of the most difficult branches of the trade.

42. Loose Pieces. Patterns sometimes have projecting portions which are made separately and fastened to the pattern by skewers or pins; they are not for the purpose of making a supporting pocket for a core, but are to be

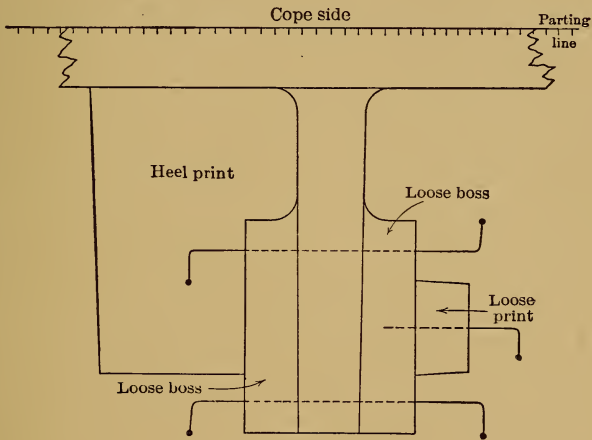

FIG. 58.—Loose Pieces.

reproduced in metal. (Fig. 58.) These loose pieces, as they are called, are often preferable to cores, even where cores might be used to "core on" the part, as they avoid scars on the castings and thus leave smoother surfaces. This method is also used in some cases to avoid making a split pattern. If a certain surface must be cast in the drag in order to produce a sound casting, it may happen that one slight projection will not allow the pattern to be

drawn. If this projection can be made loose, so that the pattern can be drawn, then the loose piece may be "picked in" or drawn into the cavity left by the main pattern, and we can accomplish the result desired with but little extra work for the molder. This loose piece may be held in its place on the pattern by skewers or pins, or be dovetailed into the pattern to give support until the sand has been rammed around it. Then the pins may be withdrawn and the ramming completed, leaving the loose piece to be picked in after the pattern proper has been drawn.

CHAPTER IX

CONSTRUCTION OF PATTERNS

IF pattern-making is one step in the process of securing a certain number of satisfactory castings at the lowest possible cost, it will be seen at once that the method of making the pattern must be governed by considerations other than those which would produce the cheapest pattern. Cheap castings and not cheap patterns is the goal to be reached. Bearing in mind the two cardinal virtues of pattern-making, (1) strength and durability, and (2) permanence of form, the different methods of construction which may be employed can now be considered. The choice between methods is governed by questions relating to operations outside of the pattern shop. The pattern-maker, having decided on the type of pattern, should make his pattern with the least possible expenditure of time and materials.

43. Methods of Construction. Advantages of Each. As a rule the amount of lathe work as compared with bench work is small. The methods employed by the wood turner produce work of fine appearance but such work will not stand the tests demanded by the accuracy of pattern-making. This accounts for the scraping done by the pattern-maker which is much slower but at the same time more accurate than the cutting which is used almost exclusively in wood turning. The appearance of a scraped surface before sand-

papering is not as good as that of one which has been cut but its accuracy is usually greater.

As distortion and liability to fracture are largely due to moisture on the one hand and to rough usage on the other hand, both must be carefully guarded against. Moisture

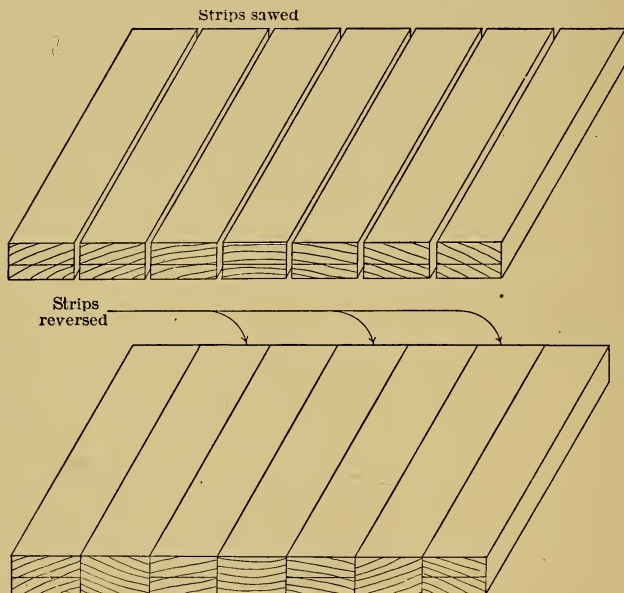

FIG. 59.—Method of Gluing up to Decrease Warping Effect

may be kept out by constructing the pattern in such a way that the least possible amount of end grain is exposed and by thoroughly protecting the surface of the finished pattern with shellac.

Strength is imparted by building up the pattern in sections with the grain running in the direction of the great-

est length of the different parts, and by making the joints overlap one another so that fracture must take place across the grain of the wood and not through a glued joint.

Stock for thin work should be cut into strips, every other strip turned end for end and turned over. (Fig. 59.) This reduces the tendency of the pattern to warp. Do not cross-glue pieces as the edges will not stay in shape and this would be particularly bad on the draw side of a

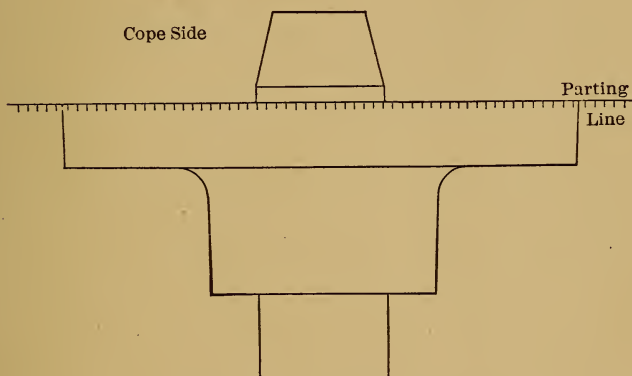

FIG. 60.—Plain Molding Joint.

pattern. End grain should be sized before gluing up, and all glued joints should be rubbed as much as possible.

44. Classes of Patterns. Patterns may be made complete, sectional, or as skeletons to be used in connection with a strike. If the parting between cope and drag is perfectly plain (Fig. 60), the molder has less work, and naturally he prefers patterns with plain partings. If the molder's joint does not coincide with that of the pattern-maker (Fig. 61), more time must be spent in the foundry and the pattern-maker must justify this increased cost

by decreased cost of his pattern, viewed in the light of the number of castings required. Another class of patterns is

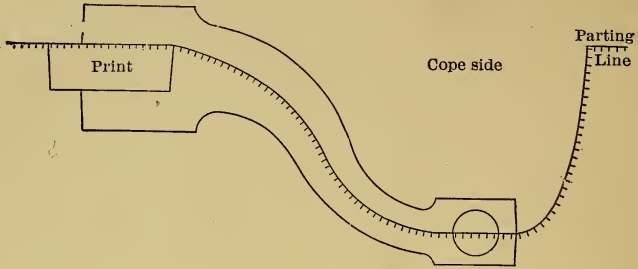

FIG. 61.—Irregular Molding Joint.

made to be used in connection with a multiple-part flask. (Fig. 62.) This often saves heavy and expensive cores and core-boxes, although calling for special flasks.

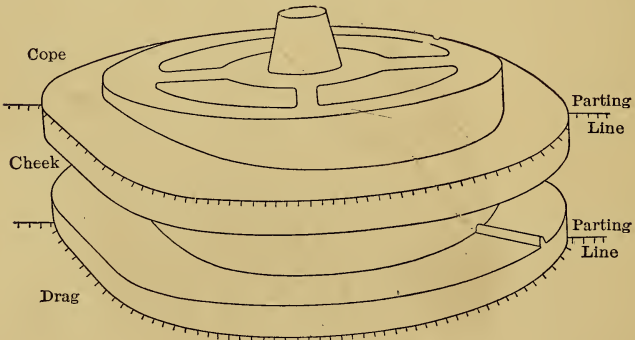

FIG. 62.—Cam Pattern to be Molded in Three-part Flask.

45. Small Patterns. Small patterns which have a short draw are often made with very little draft and practically

no allowance for shrinkage, as the rapping will allow the pattern to be drawn and will also increase the size of the mold enough to allow for the shrinkage of the metal. As the depth of draw is increased, the amount of draft must be greater as the rapping will not open out the sand as much as is the case with a short draw. When the drag is very

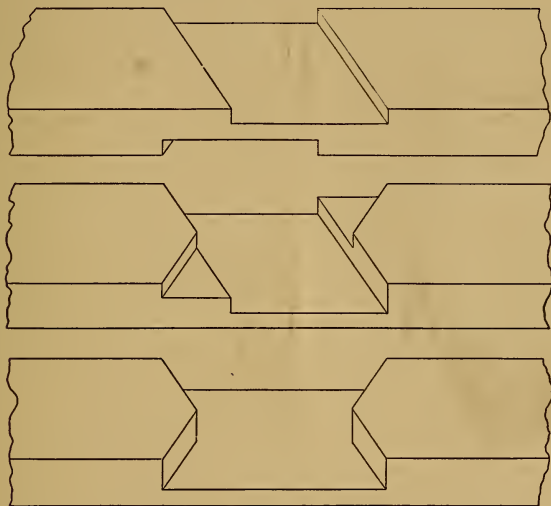

FIG. 63.—Halved or Checked Spokes for Six Spoked Spider.

deep, the pressure of the metal will often enlarge the mold as much as, or more than, the allowance usually given for shrinkage, and this fact must be considered by the pattern-maker.

Draft on the inside of a pattern, especially when the body of sand is small, must be greater than on the outside. For small circular green sand cores, such as are used for bolt holes, the use of a tapered burning iron is recommended

as a satisfactory and rapid method of obtaining the proper taper for draft.

46. Built-up Patterns. In building up patterns which require spokes, such as gears, pulleys, etc., the arms may be halved or checked together (Fig. 63), or they may be joined by butt joints (Fig. 64). The latter method, especially if reinforced by a feather in each joint or by what is known as **Canadian dovetailing**, involves less hand work and is sufficiently strong in most cases. The hubs used

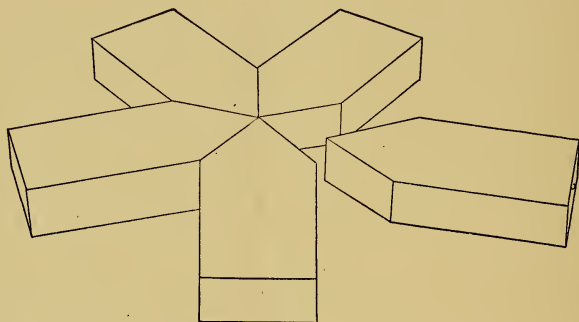

FIG. 64.—Five Spoked Spider with Butted Joints.

on this class of work are let in slightly and strengthen the joint. If no hubs are required, a thin piece of hard wood or metal may be let in flush.

The Canadian dovetail just referred to is not a true dovetail, but is like the locked corner joint seen on small boxes. (Fig. 65.) An ordinary circular saw with an attachment for moving the ripping fence the width of a groove and a tongue, or with a narrow guide the thickness of the saw located permanently parallel with the saw and the thickness of the tongue to one side of it, will do this work and will prove a good investment in any pattern shop.

Outside corners on built-up work if left sharp should be mitered to conceal end grain and reinforced on the inside with a square strip glued or screwed into the corner. If the corners are to be rounded slightly, a butt joint may be used. When the rounded corner is of large radius, and especially if it is liable to injury, the sides may be rabbeted into a hard wood corner, thus concealing the end grain, reinforcing the corner, and giving the curve in the hard wood. (Fig. 66.)

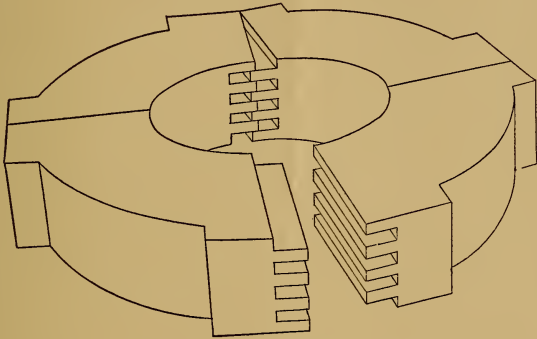

FIG. 65.—Canadian Dovetail.

Turned split patterns may be held while turning by pinch dogs, corrugated fasteners or by thin steel rings beveled on the inside and driven in flush. The last method is free from danger caused by flying pieces, but does not permit the pattern to be opened during construction as is sometimes desired.

As screws do not hold well in end grain, a plug of hard wood if desired, may be placed across the grain so that the screw may pass through it. If the screw is to be removed many times it is better not to glue the plug in, so that it

may be renewed. (Fig. 67.) When a perfectly smooth surface is desired, especially on the draw side of a pattern,

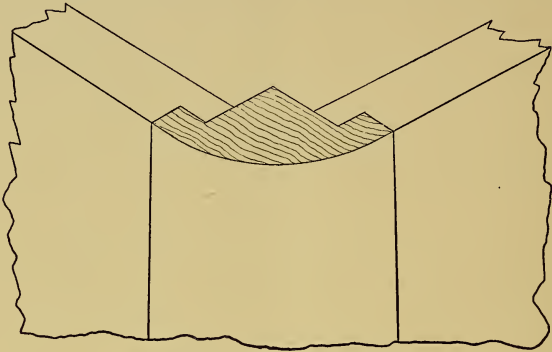

FIG. 66.—Hard Wood Corner.

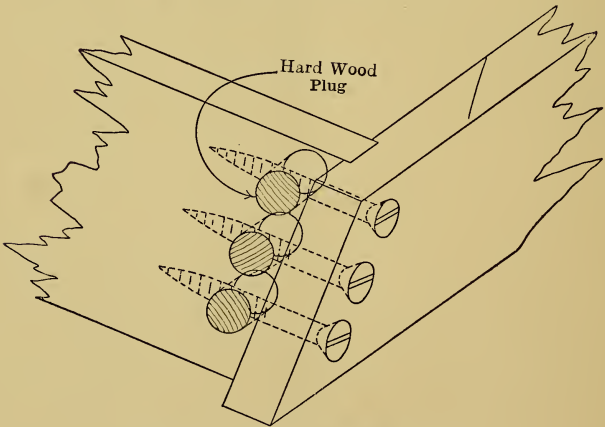

FIG. 67.—Screws in End Grains.

screws may be concealed by first counterboring so that the heads may be sunk below the surface, and then gluing in wooden plugs which may be worked off flush.

47. Circular Work. Flat circular work, especially that in the form of rings, should, for permanent construction, be laid up in **segments** in which the grain runs the longest way. The greater the number of segments in each course, the more nearly the grain follows the circular form and the less the amount of end grain exposed. The number of segments used is usually 4, 6, 8, 9, 12, or 18. The joint between adjacent segments may be the butt, feathered or keyed, or, best of all, the Canadian dovetail. The larger the surface for gluing and the stronger the mechanical

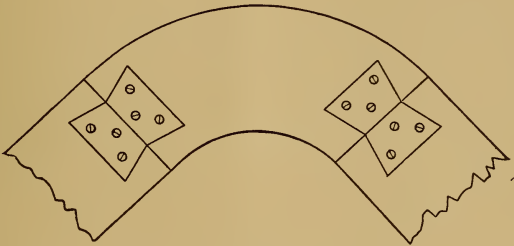

FIG. 68.—Dovetail Plates.

construction, the greater the permanence of the course. As the courses are glued one upon another, care should be taken to break joints. A single course of segments may be reinforced by dovetail plates of hard wood or metal let in as shown in Fig. 68. When the Canadian dovetail is used, this is hardly necessary. When the courses are quite thin, shoe pegs may be driven through, thus reinforcing the glue. A ring may be jointed up in one thick course, the joints fastened with the Canadian dovetail, and then sawed into a number of thin rings which may be glued together, breaking joints, thus saving time over what would be needed to handle a large number of small pieces.

If a circular pattern is so deep that the inside cannot be turned easily when completely built-up, such as a pattern for a bell, a few courses may be laid up, turned on the inside to a templet, a few more courses applied, turned as before, and so on until the inside of the pattern is finished.

48. Large Patterns. Large circular work such as cylinders, columns, etc., are usually made by placing long strips or **staves** on an interior braced form. (Fig. 69.) A surface made in this manner is called **lagging**. The flanges are often turned separately and fastened in very securely

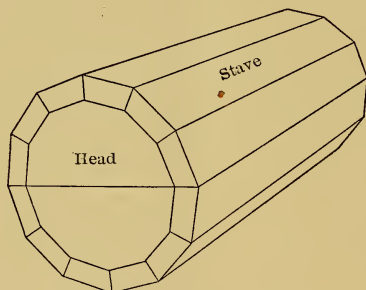

FIG. 69.—Staves Assembled for Turning.

as they are harder to draw and so get more rapping. As patterns of this kind are apt to be long in the sand, they are likely to swell. To avoid buckling, the staves are often laid with open joints. This form of construction is followed in patterns for large flat plates, also in large webs, or in any place where swelling would be likely to distort the pattern.

The same idea of an interior braced form as used for lagged work is employed in any large pattern when the drawing calls for no ribs or webs which would hold together

the flat sides of the pattern. Due to the box-like structure, such patterns are called **boxed-up**.

Different lengths of castings may be made from the same pattern by **stopping off** the mold. Such castings as engine beds, lathe beds, cylinders, and columns are made in this way with a comparatively small expenditure for patterns. (Fig. 70.) The stop-off pieces must suit the shape being made.

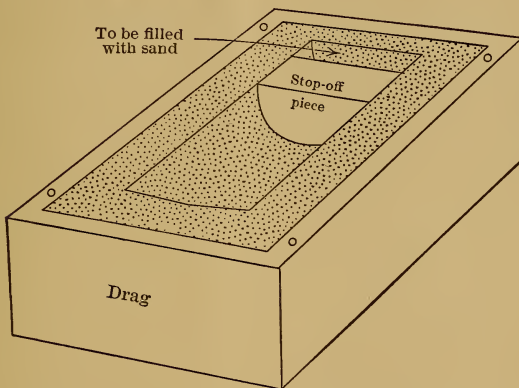

FIG. 70.—Mold with Stop-off Piece in Position.

49. Helical Forms. Patterns for **screw propellers** are made in various ways; a complete pattern with hub and blades, a hub with one blade, or a hub and one separate blade. When made in connection with the hub, the blade is usually laid up as shown in Fig. 71. The face of the blade is then worked off to a true helix using the joint lines as guides. To obtain the thickness of the blade, plugs as long as the thickness of the blade may be driven in at various points, and the back of the blade may then be worked off until flush with the ends of the plugs.

Another instance of the use of the helical form in pattern work is in a **worm** for a worm gear. It could be molded

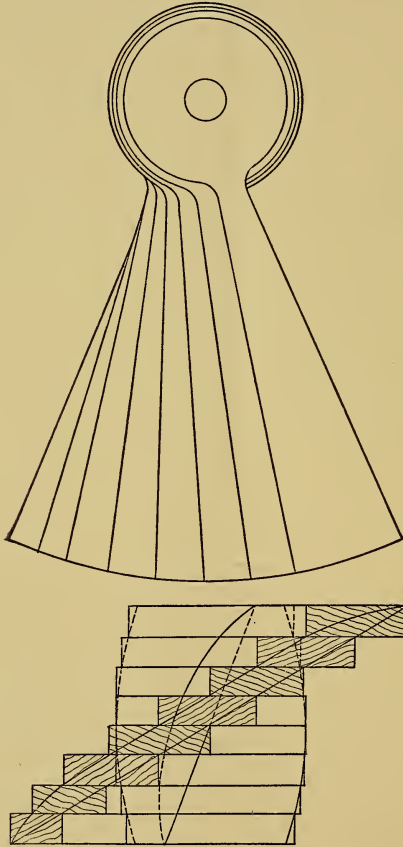

FIG. 71.—Propeller Blade Pattern Assembled.

horizontally, using a split pattern, but this method would probably leave a fin at the parting of the flask which would

interfere with its use unless machined carefully. To get a clean casting without a fin, a solid pattern may be used, molded on end in a deep flask, and drawn by turning and lifting at the same time, the proper relation between them being determined by a special rigging carrying a thread of the same lead.

50. Match Work. When many castings are to be made at once in a flask, or when a large number of single castings of irregular parting line are required, the placing of the patterns, cutting the gates and runners, and cutting irregular partings may be avoided by using the pattern on a follow board or on a plate called a **match**. The match may be made first, the pattern built upon it and patterns of the gates and runners placed in position and fastened to the pattern. If the cope side of the pattern is irregular, this match or follow board may be made of plaster of Paris so that the cope portion of the pattern may be imbedded in the plaster up to the parting line.

In the match work just referred to, the pattern is separate from the board, which is removed when the cope is to be rammed. But patterns are frequently mounted permanently on a flat metal **match plate** thick enough to stand the ramming and with the cope and drag parts of the pattern located exactly opposite one another. On the drag side of the plate are placed patterns for the gates and runners. Holes in the plate to match the flask pins keep the plate and the two parts of the flask in proper relation. When the ramming is completed the cope and plate are lifted from the drag and then the plate is lifted from the capsized cope. There is a tendency in the foundry practice of to-day to make the cope and drag of a mold on separate machines. This means that, instead of a single plate with the patterns matched on opposite sides, there are two plates,

one with the cope part and one with the drag part of the pattern so located that when the copes and drags which are made on different machines are assembled, perfect molds will result.

51. Spur Gear Patterns. When making patterns for spur gears with cast teeth, there are several different methods for getting out the teeth for the pattern: (1) If the gear is small in diameter and without spokes, the pattern may be turned from one piece with the grain running in the direction of the tooth. After carefully laying out the whole

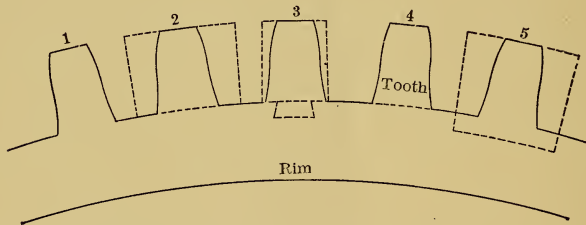

FIG. 72.—Five Methods of Attaching Teeth to Rim of Gear Pattern.

gear, the teeth can be worked from the solid. (2) In larger gears the spider may be mortised into a segmental rim the root diameter of the gear, and blocks glued on with the grain running across the rim. After carefully facing the ends of the blocks and turning to the outside diameter, the teeth may be laid out and worked in place. (3) With a rim of root diameter, a block for each tooth is fastened to the rim by a slightly tapering dovetail. After turning and laying out, the blocks are removed, worked to shape and replaced. (4) Blocks are worked out to shape independently in a jig, screwed to a rim of root diameter on which properly spaced lines have been carefully laid out, and the screw

holes plugged. The molder finds it of great advantage when finishing up a mold of a gear to have two or three separate teeth which he may remove from the pattern or which may be made for the purpose. Cherry teeth on a pine rim make an excellent gear pattern.

The methods of laying out **gear tooth outlines** vary all the way from free hand sketching to the use of zinc templets

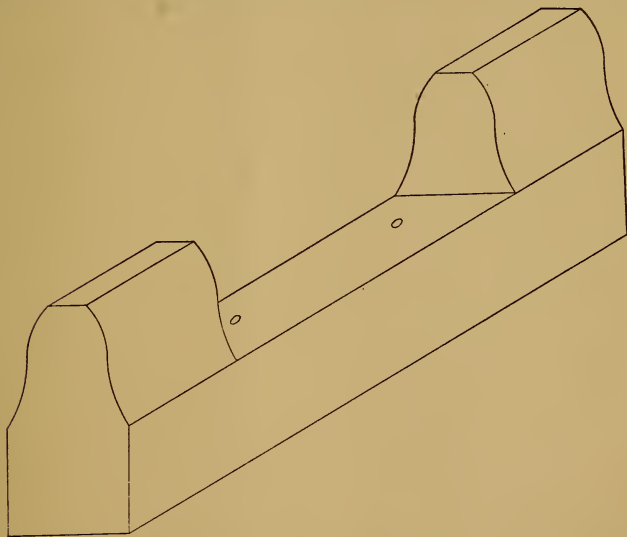

FIG. 73.—Jig for Working Out Teeth for Spur Gear Pattern.

which have been laid out mathematically. Between these, and accurate enough for all practical purposes, is the use of the Grant or Willis odontograph, a simple and universal templet, the use of which is explained in the maker's circulars.

52. Bevel Gears. Making patterns for bevel gears is more difficult, as all lines are elements of cones instead

of elements of cylinders. This makes nearly impossible any method of tooth formation which uses a surface below the root surface. If teeth are worked out by hand, they may be laid out to the proper shape at each end and then worked from line to line, or they may be made in a jig. The band saw is a most useful tool in getting out either

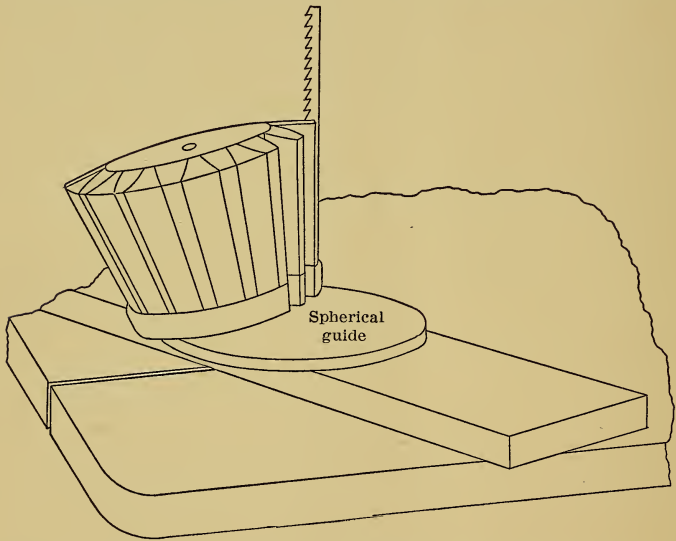

FIG. 74.—Method of Band Sawing Teeth on Bevel Gear Pattern.

spur or bevel teeth. For spur gears, the tooth must be held parallel to the saw all the time, so the flat table itself is the only guide needed. Bevel teeth require a spherical guide, the diameter of the inner end of the teeth, with the cutting edge of the saw passing radial to the sphere. (Fig. 74.) The outer end of each tooth is laid out and the gear carried on a concave holder so that any radius of the

sphere would pass through the center of the tooth, on the pitch circle. Teeth sawed in this way should require no finishing except with sandpaper.

53. Branched Patterns. Patterns having branches, especially if either the body or the branch is of curved section, are somewhat difficult to lay out. A full size development on paper can be cut out, folded around the branch, and used as a marking templet to show where the branch must be cut to fit the body. (Fig. 75.) Another method is to hold the branch at the proper angle on a form which has

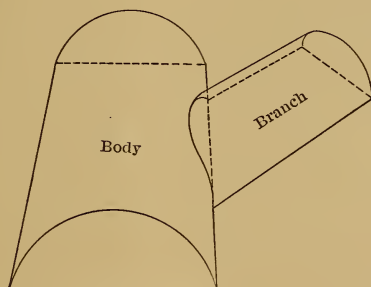

FIG. 75.—Half Branch Coped On.

on it a plan of the pattern, and use a band saw to cut to the outline of this plan, thus giving the proper shape to fit closely to the body. Both these methods are called **coping-on**. A branch may be **let into** the body either wholly or in part. It is not often that the band saw can be used in this method, the folded development serving better for laying out and the letting-in is accomplished by the use of hand tools.

54. Marking and Numbering. During the process of shellacking is the time to apply letters and figures, either

for purposes of identification or for inscriptions. They are usually placed on green shellac and fastened with brads, although screws are better if they can be used. For purposes of identification, a thin aluminum plate with raised figures and letters is preferable to separate characters. Separate figures are small, are not easily fastened, and the loss of one might give an entirely wrong number to the casting. The pattern and everything belonging to it, core-boxes, loose prints, loose pieces, etc., should carry the same pattern number and a figure representing the number of separate pieces in the group. This last figure is especially serviceable when shipping the pattern from the shop to the foundry or vice versa.

55. Fillets. Fillets are also applied at this time. Wax and putty fillets should be applied with a fillet tool after the first coat of shellac. Wood and leather fillets are shellacked on the back, laid in green shellac, and rubbed into place with a fillet tool of proper radius. Lead fillets usually rely on brads to hold them in place, but all fillets have one or more coats of shellac over them.

56. Shellacking. Shellac should be applied in several thin coats, each allowed to harden and then rubbed down with old or dull sandpaper, the only instance where a dull tool is better than a sharp one. The last coat should be left right from the brush and not rubbed down. The practice of burning off to hasten drying is only excusable when the order reads "Cast this yesterday." End grain being porous will absorb shellac so fast at first that an extra coat to seal the pores is often applied. This is about the same as sizing before gluing. Orange shellac is transparent and will not conceal poor workmanship; it also inspires the molder with greater respect for the patterns as the results of abuse are more easily seen. For these reasons many

concerns use light colored patterns exclusively, with different colors for the parts which need to be distinguished.

57. Weight of Castings. The weight of castings may be estimated quite accurately from cubic measurement of the casting part of the pattern or approximately from the weight of solid patterns. When calculating by cubic measurement, allow .26 pound for every cubic inch of cast-iron and .30 pound in case the metal is brass. If solid patterns are of pine, the weights of castings in cast-iron or brass will be approximately 16 to 1 or 18.5 to 1 respectively. Another method applicable to any material used for patterns is to take the weight of 3.85 cubic inches of the material used for the pattern in case the casting is to be in iron, or of 3.33 cubic inches if it is to be in brass. Then the weight of the pattern divided by the weight of this test block will be the weight of the casting. In using any of these methods, core prints and other parts not reproduced in metal should be deducted.

CHAPTER X

CORE-BOXES AND CORES

58. Cores. A **core** is something projecting into the mold cavity so as to cause a hole in the casting.

It may be a body of molding sand formed by a tapered recess in the pattern. As this is part of the mold itself and made of sand which has had no preparation other than tempering, it is called a **green sand core**. It is the cheapest form, as it does not require the making of core-boxes in the pattern shop, or the making and setting of cores in the foundry.

When a green sand core cannot be used, one of **dry sand** may be employed. This is made of a coarse sand free from clay, mixed to the consistency of a stiff dough with a bond having a base of sugar or starch, and baked until perfectly dry and hard. For fine work and especially for brass castings, dry sand cores are often made of burned molding sand or of beach sand. The reason for using sand free from clay is that a clayey sand would bake too hard to be readily shaken out of the casting. The core, while it must resist the flow and pressure of the molten metal, must crush under the shrinkage strain of the metal in order to avoid cracking the casting, and must break up easily so that it can be taken out.

Sometimes cores are made of **metal**, usually wrought iron or steel, in order to leave a surface so smooth and accurate that no machining is necessary. In this case, of

course, the core is not destroyed, but is made slightly tapering so it can be removed from the casting. Such cores are usually used in brass castings, as the chilling effect of such a core on cast-iron would leave the surface very hard and brittle.

With green sand and metal cores, the pattern-maker has no concern beyond the effect these cores may have on the shape of the pattern itself. Dry sand core work, on the other hand, calls for a lively imagination and is probably the most intricate as well as the most important part of pattern-making.

59. Core-boxes. After the shape of the core with its supports has been determined by the layout, the pattern-maker must turn molder, for he has to construct a mold of wood in which the core can be made. This is called a **core-box**, and goes to the foundry with the pattern.

60. Supporting Cores while Baking. When the core is first made it is so soft that it may change shape from its own weight or from careless handling. It is necessary, therefore, for the pattern-maker to consider the way that the core can best be supported while baking. The simplest form of core is one which has a comparatively broad flat portion on which it can rest. If a core is circular in section, it may be stood on end to bake, or, if the length is great as compared with the base, it may be rolled out of the core-box onto some loose dry sand.

A **half core-box** gives a flat support while baking, and is used on cores of various shapes to save expense in the pattern shop, or to obtain a support for baking. The foundryman often does not like them, for it takes more time to make two half cores, and besides the parts must be pasted together to make a complete core. Many cores which could not be baked safely on a flat plate, may be supported

on a bed of green sand, to hold which the pattern-maker may make a rough frame. The core-maker prefers this method rather than the use of a part box.

When cores are very intricate, the question of support is extremely important. In such cases it is often desirable to make a cast-iron dryer of such form that the core is supported at every point and all curved portions have intimate contact with the dryer. This means extra work for the pattern-maker and work for which he has no drawing. It should only be undertaken after consultation with the foundry foreman.

61. Large Cores. Large cylindrical cores which would require a large and expensive core-box, would use up a very large amount of core sand, and which would be very heavy if made in this way, are usually made on a cast-iron core barrel and are called **loam cores**. The barrel is first wound with hay rope and the loam mixture is applied in a softer state than dry sand and smoothed off with a strickle. As the barrel is being turned during these operations, the core is circular in sections at all points, and takes the form determined by the strickle. These cores are held by the shaft of the barrel and baked as are those of dry sand. Both large dry sand and loam cores are **black-washed** after baking. This consists in applying carbon, usually in the form of graphite, to the surface of the core. The carbon prevents the core sand from burning to the casting and aids in making the core part easily from the surface.

62. Classes of Cores. Thus it will be seen that with regard to construction, cores may be divided into four classes: (1) complete cores which lie as they are made, (2) cores which are turned over, (3) complete cores supported on sand or cast-iron dryers, (4) barrel or loam cores which require no boxes.

63. Placing Cores in the Mold. Dry sand cores are placed in the mold accurately by the guiding effect of pockets in the sand made by the core prints on the pattern. It is evident that the cores must fit closely, yet if they are at all over size the core will have a tendency to crush the mold. As cores are apt to swell somewhat in baking, they must, especially in large sizes, be made in boxes which are somewhat smaller than the finished core. Making the pattern by the shrink rule and the core-box by the standard rule usually gives sufficient allowance, but in small work where the difference between shrink and standard measure-

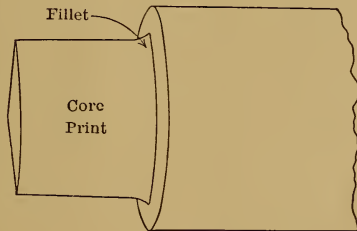

FIG. 76.—Fillet on Core Print next to Casting Part of Pattern.

ments is small, both may be made by the shrink rule, as the effect of rapping, which makes the mold larger and the core smaller, gives the leeway necessary.

If the mold is left sharp where the core pocket joins the mold proper, crushing is apt to take place even with light cores. A fillet on the pattern at this point or a taper at the base of the core print (Fig. 76) which is not reproduced in the core, will serve to prevent sand being dislodged to fall into the mold.

64. Construction of Core-boxes. Core-boxes for small standard cores should be made of metal carefully finished

for which special patterns, often of plaster of Paris, must be provided. Ordinarily, core-boxes are made of wood. The working part of the box consists of the outline of the core with the proper section, a finished face which comes in contact with the plate or with the dryer, and a bottom either solid or skeleton which brings the face of the box horizontal when in the ramming position. The bottom and

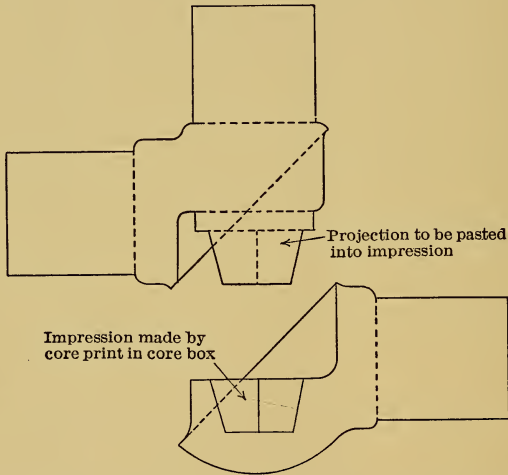

FIG. 77.—Two Parts to be Pasted together to Form Half Core for Globe Valve Body.

sides are not shellacked or even finished. These boxes must be fastened together very securely, as the core-maker uses a mallet quite freely on the bottom and sides to free the core before lifting the box. This accounts for a greater use of screws in the construction of core-boxes than is usual in patterns. Core-boxes are often made with core prints in them to make impressions to receive other cores (Fig.

77), or with loose pieces which are sometimes arranged to be drawn before the box is lifted; in other cases, they are designed to be drawn after the core is on the dryer.

In order to avoid working out to any great depth in a solid block by the use of hand tools, it is customary for cores of varying section to assemble as many pieces of wood as there are changes in section, together with a bottom

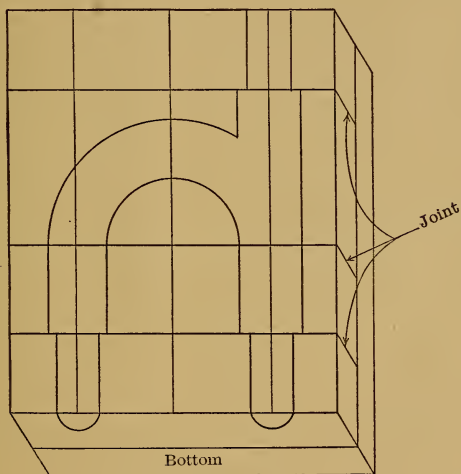

FIG. 78.—Parts for Half Core-box for Pipe Fitting Assembled and Laid Out.

or back which keeps all the pieces in proper relation. The workman can then finish the face, lay out reference lines upon it (Fig. 78), take down the box, lay out each individual piece from the reference lines, work each out by the easiest method, reassemble the box, apply fillets, etc., and shellac the box proper and the face. There is more hand work on core-boxes than is the case on patterns, as most of the

circular sections would involve inside turning. The gouge takes the place of the lathe in many cases, although the core-box machine, which is really a device for inside turning, may be used over a wide range of sizes.

65. Placing Large Cores. Large cores which are set flat in the mold can be placed by measurement and not located by core prints. These are often called **lightening**

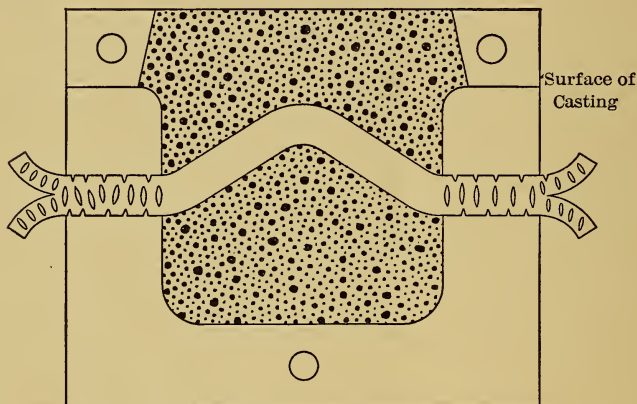

FIG. 79.—Half Core-box Showing Core Carrying Wrought Iron Flush Handle.

cores, making the casting much thinner as in the case of machine tool bases.

A core may be made to furnish the pocket and to carry the stock for a flush handle or similar work. (Fig. 79.)

66. Surfaces. A surface to be pierced with holes may have small green sand cores if the surface is flat, but if the surface is curved so that green sand cores cannot be formed, small dry sand cores the thickness of the metal may be fastened to the drag surface by nails. In the case of a

cylindrical strainer closed at one end these **nail cores** may be set on the body core and also act as chaplets to support the overhang. (Fig. 80.) In many cases a series of holes may be bored through the pattern and a plug turned to the same diameter may be forced through the pattern into the sand to make impressions for dry sand cores. Fixed pattern letters on the draw side of a pattern would interfere

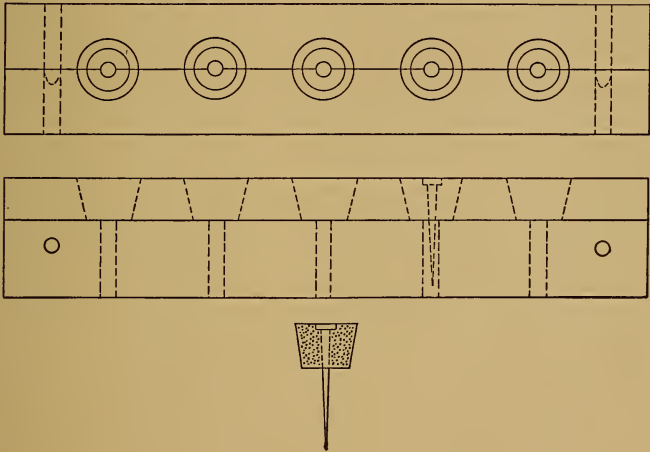

FIG. 80.—Multiple Core-box for Nail Cores.

with molding. A print including the same area might be picked in and a core set bearing a mold of the letters required. These **name plate cores** require that the pattern letters appear in the core-box and not on the pattern.

67. Covering Cores. These are often used, not to make a hole in the casting, but to avoid the use of a three-part flask. As an illustration of this take the case of the casting shown in Fig. 81. The pattern is laid on face *a*, the drag

rammed to joint *b*, the other part of the pattern placed, and rammed to line *c*, tucking the sand well under the flange. Then part 1 of the pattern is drawn and a cover core placed in the pocket made for it by the cover core

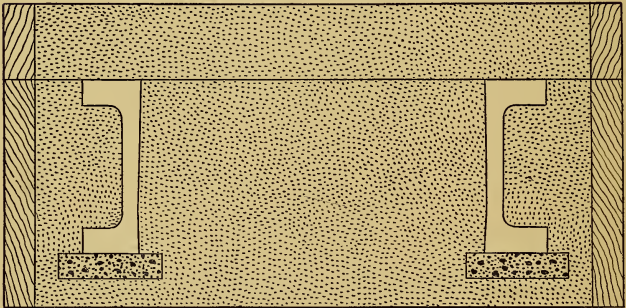
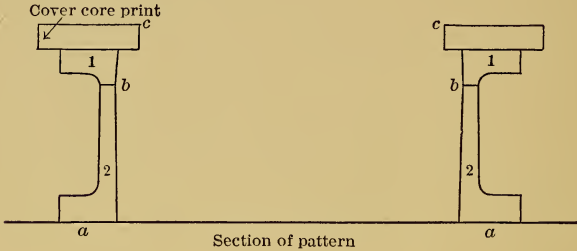

FIG. 81.—Section of Two-part Mold Showing Cover Core Making Three-part Flask Unnecessary.

print. The ramming of the drag can then be finished and, after making a plain cope, part 2 of the pattern can be drawn. This method can also be used in many cases where it is imperative that certain surfaces be molded in the drag as in the case of bearings on pedestals and machine bases.

In the case of a double shrouded gear, a ring covering core for the lower shroud would avoid casting the teeth in cores or in a three-part flask, and give a smoother job.

68. Ring Cores. The use of a three-part flask may also be avoided by the use of a **ring core**. If the diameter is large, they are usually made in sections to reduce the cost of the core-box and to insure greater safety in handling the core. Good examples of this work are cable sheaves and chain wheels. A section of one is shown in Fig. 82.

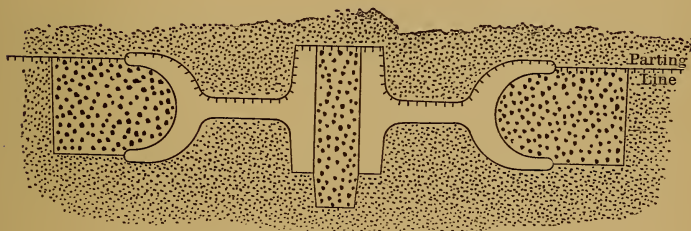

FIG. 82.—Mold for Sheave Showing Ring Core.

69. Hollow Cores. Sometimes a pattern could be drawn easily if it were not for some slight projection. As has already been pointed out, if the small piece can be drawn into the main cavity, it may be attached to the pattern as a loose piece. If it cannot be so drawn, a **hollow core** may be used, the interior of which is a mold for the part in question, the print for this core being of such a shape that it can be drawn with the pattern. (Fig. 83.)

70. Castings without Patterns. If part of a casting can be made in a core, it is but a step to make a casting without any pattern at all, using core-boxes only. This is usually done only on large work, the cores in some cases being so large and heavy that it pays to make them in

sections and stack them. Among the smaller class of castings which are sometimes made in this way may be noted cast chain, only one core-box being needed. (Fig. 84.)

Round flasks with their trunnions for lifting and rolling can be cast in cores, also columns with their bases,

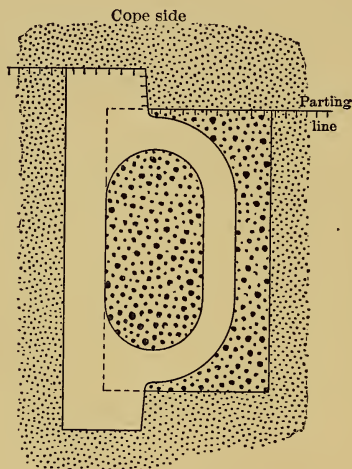

FIG. 83.—Part of Mold Showing Hollow Core for Casting on a Handle.

caps, and brackets. Large fly-wheels can be cast in cores by sweeping the depth of the rim to the outer diameter and using a core for the center, one for each arm, and a covering core for the rim and for the hub.

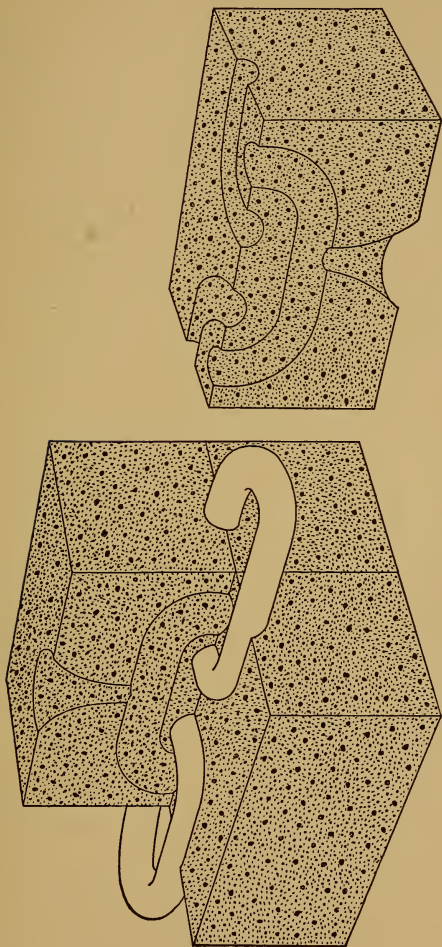

FIG. 84.—Four Cores for Casting Chain Link.

CHAPTER XI

SKELETON PATTERNS AND SWEEPS

71. Skeleton Patterns. Skeleton patterns and core-boxes are used for several reasons; as they take less stock and time, they are cheaper to build, and as they are much

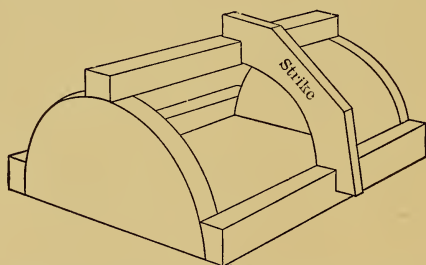

FIG. 85.—Skeleton Core-box with Strike.

lighter, they are easier to handle in the foundry. As the sand surfaces are made by the use of strikes, the pattern merely serving as a guide, the actual molding operations may take more time, but this is more than offset by the saving in the pattern shop.

Large cores can often be formed directly on the plate by the use of a skeleton box and strikes. (Fig. 85.) In the case of some simple forms, nothing is required but a core board to give the general direction and a single strike to give the proper section. (Fig. 86.) A skeleton pattern

may be made of any outline, no matter how irregular, provided the strikes can follow that outline.

72. Sweeping. When the main portion of a mold is circular in section, a strike swung in a circular path will produce the form desired. In such a case, the guiding effect may be obtained without the use of any pattern. A rigid vertical spindle can be erected in the foundry floor and the strike fixed so as to revolve around it. This method is known as **sweeping** and strikes used in this

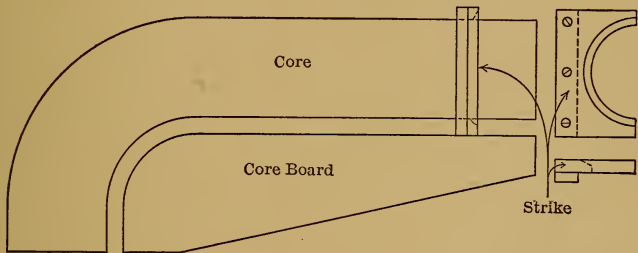

FIG. 86.—Core Board with Strike.

manner are usually called **sweeps**. Swept-up molds are not usually made in flasks, but on a level plate concentric with the spindle. A form of bricks is laid up in mud with wisps of straw between the bricks to vent the mold, to within about an inch of the first or roughing sweep, and loam is built upon this form until the sweep strikes every portion of it. (Fig. 87.) A second sweep, allowing a finishing coat of loam about a half an inch in thickness, may then be used. These **inside sweeps** may be held at top and bottom and should have the thickness of the metal indicated upon them.

The loam mixture consists of fire sand and molding sand

mixed with clay water. Some chopped straw is mixed with it to make the mixture more porous. As it is applied with a trowel, the consistency should be about the same as that of a stiff mortar.

The cores for loam molds are formed the same as the molds themselves, but the sweeps cannot be supported at

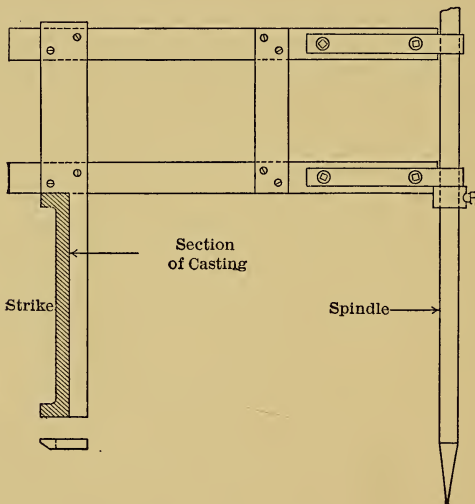

FIG. 87.—Sweep for Outside of Casting.

the bottom, making it necessary to give particular attention to the top support. These are called **outside sweeps** as the loam is placed on the outside of the brick form. (Fig. 88.)

The mold and core are swept up on separate plates, dried out, black-washed, and, if the mold is a large one, placed in a pit in the foundry floor, and sand filled in around

it to resist the pressure of the metal. A smaller mold might be held by chains.

A large pipe with nozzles may have the pipe proper swept up and part patterns used for the nozzles. These nozzle patterns can have cover core prints for the flanges,

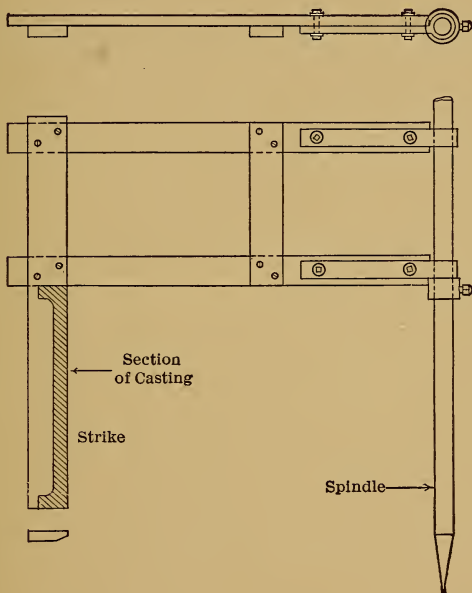

FIG. 88.—Sweep for Core or Inside of Casting.

and a large cover or slab core can be used for the face of the upper flange of the pipe. Loam molds may also be made by the use of skeleton patterns and strikes, no spindle being employed.

After a loam core has been made on a core plate, and dried, it may be black-washed and a **sand thickness** built

upon it, using for a gage either a strike, thickness strips (the spaces to be filled in), or nails with a gage for depth. On this sand pattern, a loam cope may be built and dried in place. After lifting the loam cope the sand pattern can be removed.

The blades of propellers may be swept up, using in connection with the spindle, an outside guide to give the pitch. In large sizes it is usual to have a separate cope for each blade.

A grooved winding drum may be made in this way, the inside sweep having a guide to raise it uniformly during a full revolution an amount equal to the pitch.

CHAPTER XII

SPECIALIZATION IN THE PATTERN SHOP AND IN THE FOUNDRY

73. Card Systems. The pattern shop must have a systematic and convenient method of **caring for the drawings** from which its work is laid out. Probably a card system referring to the drawings (which should be kept flat in shallow drawers and never rolled) is the plan best adapted to shops of any considerable size. These cards could be divided into three classes: (1) drawings received but not issued, (2) drawings in the shop, and (3) drawings of completed patterns. The information finally recorded should include (1) the dates of receipt of drawing, commencement of work, and completion of pattern, (2) description of pattern with its identifying number, and a list of all core-boxes and special rigging, (3) names of workmen, their time and rate, (4) amount and cost of stock, (5) total cost of pattern. Many other items of value will suggest themselves in special cases.

If the **storage of patterns** is placed in charge of the pattern shop, there should be a card index showing (1) patterns in storage, (2) patterns in foundry, and (3) patterns in shop for repairs or changes. Each card should show (1) date of receipt of pattern, (2) dates of issue, name of foundry, number of castings, and dates of return, (3) dates of transfer to pattern shop, memorandum of repairs or changes, and dates of return.

The keeping of these card systems should not be made a part of the duties of the shop foreman, but should be placed in charge of a competent clerk (although it might not take the whole of his time) who should be under the control of, and report to, the head of the pattern shop.

74. Division of Labor. When a proper analysis shows exactly the work to be done in the pattern shop, then specialization may produce good results. The sub-division of hand labor has not yet reached the same degree in the pattern shop that it has in the foundry and the machine shop. This is accounted for in a large measure by the fact that a much smaller number of men are employed, yet it is not too much to suppose that in large shops there will be in the immediate future separate departments of laying out, getting out stock, construction, and finishing. The purely creative work of planning or laying out will be the most important and the best paid, the skilled workman will find his opportunity in the construction department, while the getting out of stock and the finishing will fall to the lot of the workman of less ability and the apprentice. The time may come when each of these departments may be still further sub-divided.

Efficiency in the use of a labor-saving machine consists in having the saving made by its use more than offset the interest on the investment, the depreciation of the machine, the cost of power to run it, and the probability that it may be superseded by a better one. This last contingency should be anticipated by a sinking fund.

75. Relation of Methods to Foundry Practice. Specialization in the foundry has reacted and will still further react on the pattern shop. The skilled molder who could handle successfully almost any form the pattern-maker chose to produce is being replaced to a great extent by the unskilled

laborer. This has made necessary an arrangement of the pattern so that skill in molding is not required. The molding machine in its various forms is coming into general use for castings in lots as small as half a dozen. Follow boards are in greater demand, more patterns are being arranged for plate work, and all along the line there is a louder call for patterns which lend themselves to molding by unskilled hands.

One of the latest devices for saving labor in the foundry and one that reaches the hitherto untouched class of large castings, is the **jar-ramming** or **jolting machine**. While the use of this machine saves patterns from surface scars caused by hand or pneumatic rammers in the hands of careless molders, it puts a strain on the general construction of a pattern which was unknown in the old days. The effect of jolting a large pattern covered by a heavy body of sand tends to shake it apart, and calls for a stronger construction and for a more liberal use of screws than was considered necessary before the advent of this method.

This tendency toward the use of unskilled labor in the foundry calls for a greater degree of skill in the pattern shop, especially in the planning department, and no pattern-maker, however great his skill in construction, can hope to qualify for the more important duty of planning unless he is acquainted with, and keeps himself fully abreast of, this rapid and fundamental change in modern foundry practice.

INDEX

- Animal glue, 45
Allowance for, draft, 15; driving, 18; finish, 17; holding, 18; shrinkage, 13
Arcs, Tools for large, 25
- Backing off, 42
Balanced core, 68
Band saw, 32
Bars in cope, 7
Bastard sawing, 44
Bench, 20
Bevel gear pattern, 85
Bit, Forstner, 30
Black wash, 92
Blocks, V, 25
Board, Bottom, 7; Core, 102; Follow, 57; Mold, 7; Pattern, 7; Shoot, 26
Boring machine, 33
Bottom board, 7
Boxed-up pattern, 81
Brads, 47
Branched pattern, 87
Built-up pattern, 58, 76
Buzz planer, 33
- Calipers, Marking, 30; Thickness, 30
Camber, 15
- Canadian dovetail, 76
Casting, Chilled, 64; Original, 1; Weight of, 89
Center, edge, 23; plates, 36; square, 23
Chaplets, 8
Cheeks, 6
Cherry, 44
Chill, 8
Chilled castings, 64
Choice of pattern, 10
Chuck, Screw, 36
Circular saw, 32
Cold glue, 45
Complete pattern, 73
Cooling strains, 48
Cope, 6; bars, 7; core print, 65; False, 8
Coping, down, 56; on, 87; tram-mel, 25
Core, Balanced, 68; Covering, 97; Definition of, 90; dryer, 92; Dry sand, 59, 90; Green sand, 59, 90; Hollow, 99; Lightening, 96; Loam, 92; Metal, 90; Nail, 97; Name plate, 97; Ring, 99
Core-box, Construction of, 93; Definition of, 91; Half, 91; machine, 33; plane, 27; Skeleton, 102

- Core print, Cope, 65; Drag, 66; Drop, 68; Heel, 68; Length of, 67; Loose, 65; Nowel, 66; Straight, 66; Tapered, 65
- Cornering tool, 31
- Corners, Hardwood, 77; Round, 31, 48
- Corrugated fasteners, 36
- Covering core, 97
- Cradles, 25
- Cutters, Routing, 33
- Daniels' planer, 33
- Definition of, core, 90; core print, 65; finish, 17; mold, 5; pattern, 2, 15; pattern-making, 71
- Demand for pattern-maker, 2
- Disc grinder, 34
- Dogs, Pinch, 36, 46
- Double shrink, 21
- Dovetail, Canadian, 76; plates, 79
- Dowel plates, 48
- Dowels, 47
- Draft, 15
- Drag, 6; core print, 65
- Drawbacks, 6
- Drawing plates, 48
- Drawings, 1, 39; Caring for, 107
- Driving, Allowance for, 18
- Drop core print, 68
- Drop-outs, 7
- Dryer, Core, 92
- Dry sand, 6; core, 59, 90
- Edge center, 23
- End face plate, 35
- Face plate, 35, 36
- Facing sand, 7
- False cope, 8
- Fasteners, Corrugated, 36
- Fillet, 49; Lead, 50; Leather, 50; Putty, 50; tool, 49; Wax, 49, Wood, 49
- Finish, 17
- Fish glue, 45
- Flask, 6
- Flexible faced plane, 27
- Follow board, 57
- Form templet, 41
- Forstner bit, 30
- Gaggers, 7
- Gates, 8, 61
- Gear pattern, Bevel, 85; Spur, 84
- Glue, Animal, 45; Cold, 45; Fish, 45; Hot, 45; Liquid, 45
- Green sand, 5; core, 59, 90
- Grinder, Disc, 34
- Guards, 37
- Gun, Wax, 50
- Hand jointer, 33
- Hardwood corner, 77
- Heel core print, 68
- Hexagon, Tool for laying out, 25
- Holding, Allowance for, 18
- Hollow core, 99
- Hook tool, 36
- Hot glue, 45
- Jar ramming, 109
- Jig saw, 32
- Jointer, Hand, 33
- Jolting, 109
- Knife, 22
- Lagging, 80
- Lathe, 35
- Laying out, hexagon, 25; large arcs, 25

- Layouts, 38
 Lead fillet, 50
 Leather fillet, 50
 Letters, Pattern, 51
 Letting-in, 87
 Light, 37
 Lightning cores, 96
 Liquid glue, 45
 Loam, 6, 103; core, 92
 Loose, core print, 65; pieces, 69

 Machine, Boring, 33; Core-box, 33; Jar ramming, 109; Molding, 63
 Mahogany, 44
 Marking, calipers, 30; templet, 41
 Master pattern, 10
 Match, 8, 83; plate, 64, 83
 Materials, 43
 Metal, core, 90; pattern, 61
 Mold, board, 7; Definition of, 5
 Molding, machine, 63; sand, 5

 Nail core, 97
 Name plate core, 97
 Nowel, 6; core print, 66
 Nozzle, 105

 Odd-side, 8, 62
 One-casting pattern, 10
 One-piece pattern, 55

 Parting sand, 8
 Pattern, board, 7; Boxed up, 81; Branched, 87; Built up, 58, 76; Choice of, 10; Complete, 73; Definition of, 2, 15; letters, 51; Master, 10; Metal, 61; One-casting, 10; One-piece, 55; Part, 60; Propeller, 81, 106; Repair of, 10; Sand, 106; Sectional, 73; Skeleton, 71, 73, 102; Small, 74; Split, 56; Spur Gear, 84; Standard, 10; Storage of, 107; Stove plate, 30, 57; Temporary, 10; Thin, 30; Types of, 54; Winding drum, 106; Worm, 82
 Pattern-making, Definition of, 71
 Pattern-maker, Demand for, 2; Qualifications of, 3; Tools for, 20
 Picking in, 70
 Pinch dogs, 36, 46
 Pine, 44
 Planer, Buzz, 33; Daniels', 33; Surface, 34
 Planes, Core-box, 27; Flexible faced, 27; Rabbet, 27; Routing, 27; Round soled, 27
 Plates, Center, 36; Dowel, 48; Dovetail, 79; Match, 64, 83; Rapping and Drawing, 48; Stripping, 62
 Points, Trammel, 24
 Propeller, pattern, 81, 106
 Putty fillet, 50

 Qualifications of a pattern-maker, 3
 Quarter sawing, 44

 Rabbet plane, 27
 Rammers, 7
 Ramming, Jar, 109; Jolt, 109
 Rapping, 16, 18; plates, 48
 Repair of patterns, 10
 Riddle, 7
 Ring core, 99
 Rings, 36
 Round corners, 31, 48

- Round soled plane, 27
 Routing, cutters, 33; plane, 27
 Rule, Shrinkage, 21
 Rusting patterns, 53
- Sand, Dry, 6; Facing, 7; Green, 5; Molding, 5; Parting, 8; Pattern in, 106; thickness, 105
 Sander, surface, 34
 Sandpaper, 51
 Sawing, Bastard, 44; Quarter, 44; Straight, 44
 Saw, Band, 32; Circular, 32; Jig, 32
 Screw chuck, 36
 Screws, 47
 Sectional patterns, 73
 Segments, 79
 Shellac, 52, 88
 Shoot board, 26
 Shrinkage, 13; Double, 21; rule, 21; Unequal, 14
 Sieve, 7
 Sizing, 46
 Skeleton pattern, 61, 73, 102
 Small pattern, 74
 Specialization, 1, 39, 108
 Spindle, 103
 Spirit varnish, 52
 Split pattern, 56
 Sprue, 8
 Spur gear pattern, 84
 Square, Center, 23
 Standard pattern, 10
 Staves, 80
 Stopping off, 81
 Storage of patterns, 107
 Stove plate pattern, 30, 57
 Straight, core print, 66; sawing, 44
- Strains, Cooling, 48
 Strickle, 61
 Strike, 61, 102
 Stripping plate, 18, 62
 Surface, planer, 34; sander, 34
 Sweeps, Inside, 103; Outside, 104
 Swells, 17
- Table, Cast iron, 21
 Tacks, 47
 Taper, 16
 Tapered core print, 65
 Tempering, 5
 Templets, Form, 41; Marking, 41
 Temporary pattern, 10
 Thickness calipers, 30; Sand, 105
 Thin pattern, 30
 Tool, for cornering, 31; for large arcs, 25; for laying out hexagon, 25; for pattern-maker, 20; Hook, 36
 Trammel, Coping, 25; points, 24
 Trimmer, 32
 Tripod, 35
 Types of patterns, 54
- V blocks, 25
 Varnish, 52; Spirit, 52
 Ventilation, 37
 Venting, 8
 Vise, 21
- Warping, 43
 Wash, Black, 92
 Wax, fillet, 49; gun, 50
 Weight of castings, 89
 Winding drum pattern, 106
 Wire, Vent, 8
 Wood fillet, 49
 Worm pattern, 82

THE WILEY TECHNICAL SERIES

EDITED BY

J. M. JAMESON

A series of carefully adapted texts for use in technical, vocational and industrial schools. The subjects treated will include Applied Science; Household and Agricultural Chemistry; Electricity; Electrical Power and Machinery; Applied Mechanics; Drafting and Design; Steam; Gas Engines; Shop Practice; Applied Mathematics; Agriculture; Household Science, etc.

The following texts are announced; others are being added rapidly:

ELECTRICITY

THE ELEMENTS OF ELECTRICITY; For Technical Students.

By W. H. TIMBIE, Head of Department of Applied Science, Wentworth Institute. Small 8vo, xi+556 pages, 415 figures. Cloth, \$2.00 *net*.

THE ESSENTIALS OF ELECTRICITY; A Text-book for Wiremen and the Electrical Trades. By W. H. TIMBIE, Wentworth Institute. 12mo, flexible covers, pocket size. xiii+271 pages, 224 figures. Cloth, \$1.25 *net*.

CONTINUOUS AND ALTERNATING CURRENT MACHINERY. By Professor J. H. MORECROFT, Columbia University. Small 8vo, ix+466 pages, 283 figures. Cloth, \$1.75 *net*.

ALTERNATING CURRENTS. By W. H. TIMBIE, Head of Department of Applied Science, Wentworth Institute, and H. H. HIGBIE, Professor of Electrical Engineering, University of Michigan. (*In press.*)

ELECTRIC LIGHTING. By H. H. HIGBIE, Professor of Electrical Engineering, University of Michigan. (*In preparation.*)

INTRODUCTION TO INDUSTRIAL ELECTRICITY. By W. H. TIMBIE, Head of Department of Applied Science, Wentworth Institute. (*In preparation.*)

HEAT AND HEAT ENGINEERING

HEAT; A Text-book for Technical and Industrial Students. By J. A. RANDALL, Instructor in Mechanics and Heat, Pratt Institute. Small 8vo, xiv+331 pages, 80 figures. Cloth, \$1.50 *net*.

GAS POWER. By C. F. HIRSHFELD, Professor of Power Engineering, Sibley College, Cornell University, and T. C. ULBRICHT, formerly Instructor, Department of Power Engineering, Cornell University. Small 8vo, viii+198 pages, 60 figures. Cloth, \$1.25 *net*.

STEAM POWER. By C. F. HIRSHFELD, Professor of Power Engineering, Sibley College, Cornell University, and T. C. ULBRICHT, formerly Instructor, Department of Power Engineering, Cornell University. (*In preparation.*)

HEAT AND LIGHT IN THE HOUSEHOLD. By W. G. WHITMAN, State Normal School, Salem, Mass. (*In preparation.*)

MECHANICS

ELEMENTARY PRACTICAL MECHANICS. By J. M. JAMESON, Pratt Institute. Small 8vo, xii+321 pages, 212 figures. Cloth. \$1.50 *net*.

MECHANICS FOR MACHINISTS. By R. W. BURNHAM, Erasmus Hall High School, Brooklyn, Instructor in Evening Machine Work, Pratt Institute. (*In preparation.*)

MATHEMATICS

PRACTICAL MATHEMATICS. By C. R. DOOLEY, Westinghouse Electric and Manufacturing Company, Pittsburgh. (*In preparation.*)

A SHOP MATHEMATICS FOR MACHINISTS. By R. W. BURNHAM, Instructor in Machine Work, Pratt Institute Evening School. (*In preparation.*)

AGRICULTURE

- POULTRY.** By Professor J. C. GRAHAM, Massachusetts Agricultural College. (*In preparation.*)
- SOILS.** By Professor A. G. McCALL, Ohio State University. (*In preparation.*)
- AGRICULTURAL CHEMISTRY.** By Professor T. E. KEITT, Clemson Agricultural College. (*In preparation.*)
- INJURIOUS INSECTS.** By Dean E. D. SANDERSON and Professor L. M. PEAIRS, West Virginia University. (*In preparation.*)
- AGRICULTURAL DRAFTING.** By CHARLES B. HOWE, M.E. 4to, 46 pages, 45 figures, 22 plates. Cloth, \$1.25 *net.*
- STUDIES OF TREES.** By J. J. LEVISON, Forester, Park Department, Brooklyn, N. Y. Small 8vo, x+253 pages, 156 half-tone illustrations. Cloth, \$1.60 *net.*

FIELD MANUALS IN AGRICULTURE

A carefully selected series of laboratory and field studies, with supplementary theory and information for classroom use. 4to; loose leaf, or bound in paper covers as preferred.

Studies of Trees: Their Diseases and Care. By J. J. LEVISON, M.F., Lecturer on Ornamental and Shade Trees, Yale University Forest School, Forester to the Department of Parks, Brooklyn, N. Y. 20 pamphlets, \$1.00 *net.* Sold separately if desired. Price each 5, 10, or 15 cents according to size.

Exercises in Farm Dairying. By Professor C. LARSEN, Department of Dairy Husbandry, South Dakota State College. 69 Exercises. Single Exercises two cents each. Complete \$1.00 *net.*

Exercises in Poultry Raising. By Professor J. C. GRAHAM, Massachusetts Agricultural College. (*In preparation.*)

Market Gardening. By Professor F. L. YEAW, Oasis Farm & Orchard Company, Roswell, New Mexico. Formerly Professor of Market Gardening, Massachusetts Agricultural College. (*In preparation.*)

Studies of Insects. By Dean E. D. SANDERSON and L. M. PEAIRS, West Virginia University. (*In preparation.*)

Farm Crops and Soils. By Professor A. G. McCALL, Department of Agronomy, Ohio State University. (*In preparation.*)

Exercises in Agricultural Chemistry. By Professor T. E. KEITT, Clemson Agricultural College. (*In preparation.*)

THE LOOSE LEAF LABORATORY MANUAL.

A series of carefully selected exercises to accompany the texts of the Series, covering every subject in which laboratory or field work may be given. Each exercise is complete in itself, and is printed separately. These will be sold by the single sheet as selected or where preferred will be bound in paper cover.

Exercises in General Chemistry. By CHARLES M. ALLEN, Head of Department of Chemistry, Pratt Institute. An introductory course in Applied Chemistry, covering a year's laboratory work on the acid-forming and metallic elements and compounds. 4to, 62 pages, 61 exercises.

Selected exercises as desired, to fit an ordinary binder, two cents each. Complete in paper cover, \$1.00 *net*.

Exercises for the Applied Mechanics Laboratory. By J. P. KOTTCAMP, M.E., Instructor in Steam and Strength of Materials, Pratt Institute. Steam; Strength of Materials; Gas Engines; and Hydraulics. 4to, 54 exercises, with numerous cuts and tables.

Selected exercises as desired, to fit an ordinary binder, two cents each. Complete in paper cover, \$1 *net*.

Wiring Exercises. By H. A. CALDERWOOD, Carnegie Institute of Technology. (*In preparation.*)

Quantitative Chemical Analysis. By CHARLES M. ALLEN, Head of Department of Chemistry, Pratt Institute. 12 pamphlets. Complete in paper cover, \$1.00 *net*.

Exercises in Industrial Chemistry. By Dr. ALLEN ROGERS, Instructor in Qualitative Analysis, Pratt Institute. (*In preparation.*)

Technical Chemical Analysis. By R. H. H. AUNGST, Instructor in Technical Chemistry, Pratt Institute. 19 pamphlets. Complete, 85 cents *net*.

Qualitative Chemical Analysis. By C. E. BIVINS, Instructor in Qualitative Analysis, Pratt Institute. (*Ready in part.*)

Elementary Electrical Testing. By Professor V. KARAPETOFF, Cornell University, Ithaca, N. Y. 25 exercises, 50 cents *net*.

Exercises in Mechanics. By J. M. JAMESON, Girard College; Formerly Pratt Institute. 52 exercises. Single exercises two cents each. Complete in paper cover, 85 cents *net*.

Exercises in Heat. By J. A. RANDALL, Instructor in Mechanics and Heat, Pratt Institute. 13 exercises, with numerous cuts and diagrams. Single exercises two cents *net* each.

Exercises in Electricity, A. C. and D. C. By W. H. TIMBIE, Head of Department of Applied Science, Wentworth Institute. 49 Exercises. Single exercises, two cents each. Complete in paper cover, 85 cents *net*.

SHOP TEXTS

MACHINE SHOP PRACTICE. By W. J. KAUP, Westinghouse Electric and Manufacturing Company, Pittsburgh, Pa. Small 8vo, ix+227 pages, 186 figures. Cloth, \$1.25 *net*.

PATTERN MAKING. By FREDERICK W. TURNER and DANIEL G. TOWN, Mechanic Arts High School, Boston. Small 8vo, v+114 pages, 88 figures. Cloth.

TOOL MAKING. By W. J. KAUP, Westinghouse Electric and Manufacturing Company, and J. A. CHAMBERLAIN, Supervisor of Manual Training, Washington, D. C. (*In preparation.*)

A SHOP MATHEMATICS FOR MACHINISTS. By R. W. BURNHAM, Instructor in Machine Work, Pratt Institute Evening School. (*In preparation.*)

DRAFTING AND DESIGN

AGRICULTURAL DRAFTING. By CHARLES B. HOWE, M.E. 4to, viii+63 pages, 45 figures, 26 plates. Cloth, \$1.25 *net*.

ARCHITECTURAL DRAFTING. By A. B. GREENBERG and CHARLES B. HOWE, Stuyvesant Technical High School, New York. 4to. Cloth, \$1.50 *net*.

THE LOOSE LEAF DRAWING MANUAL. Reference and Problem Sheets to accompany the texts of Agricultural Drafting. These will be furnished singly as selected, and are designed to enable the instructor to adapt his instruction closely to the needs of his class. 40 sheets now ready. Price two cents each.

LIBRARY OF CONGRESS



0 003 318 088 3

