

UNIVERSITY OF TORONTO



3 1761 01078242 3



Digitized by the Internet Archive
in 2007 with funding from
Microsoft Corporation

GEODETIC SURVEYING

GEODETIC SURVEYING

AND

THE ADJUSTMENT OF OBSERVATIONS

(METHOD OF LEAST SQUARES)

BY

EDWARD L. INGRAM, C.E.

Professor of Railroad Engineering and Geodesy, University of Pennsylvania

FIRST EDITION
FIFTH IMPRESSION

McGRAW-HILL BOOK COMPANY, INC.

NEW YORK: 370 SEVENTH AVENUE

LONDON: 6 & 8 BOUVERIE ST., E. C. 4

1911



QB
301
I6

COPYRIGHT, 1911, BY THE
MCGRAW-HILL BOOK COMPANY, INC.

PRINTED IN THE UNITED STATES OF AMERICA

PREFACE

AFTER a careful examination of existing books, the University of Pennsylvania has failed to find a satisfactory text from which to teach its civil engineering students the fundamental principles of geodetic surveying and the adjustment of observations as it feels they should be taught to this class of men. A canvass of the leading colleges of the country has shown that the same lack of a suitable book has been felt by many other institutions. The present volume has been prepared to meet this apparent need. No attempt has been made, therefore, to treat the subject exhaustively for the benefit of the professional geodesist, but rather to build up a book containing everything that can be considered desirable for the student or useful to the practicing civil engineer. In order to make the book complete for such engineers it has been necessary to include a large amount of matter not desirable or suitable for class-room work, the arrangement of the college course being left to the judgment of the instructor.

In writing the book in two parts the aim has been to make each part complete in itself, so that either part may be read intelligently without having read the other part. Those who wish to make a study of geodetic work without entering into involved mathematical discussions, will find a complete treatment of geodetic methods and the rules for making the necessary adjustments in the first part of the book. Those who wish to become familiar with the fundamental principles of least squares, or those familiar with geodetic work who wish to understand the mathematical theory on which the rules for adjusting observations are based, may read the second part of the book alone. The book has been written with the intention, however, that engineering students shall take the two parts in succession.

In the first part of the book the initial chapter takes up the principles of triangulation work as the best introduction to geodetic work in general. Nothing new of any special importance is available in the general scheme of triangulation, and the chapter is written as briefly and logically as possible.

The second chapter treats of the subject of base-line measurement, including measurements with base-bars, steel tapes, invar tapes, and steel and brass wires. Special care has been taken to have such constants as the temperature coefficient, the modulus of elasticity, and the specific weight correct and complete for the different materials involved. The mathematical treatment of the corrections required in base-line work has been made as simple as possible, avoiding needless transformations of mathematical formulas to cover unusual methods of work.

The third chapter takes up the subject of angle measurement, and is intended to make clear the most approved methods of using the instruments and performing the actual work in the field. The repeating method is given in much detail on account of the excellent results obtainable by this method with the ordinary engineer's transit.

The fourth chapter includes the computations and adjustments required in triangulation work, and is intended to cover all points of interest to the civil engineer.

The fifth chapter takes up the subject of computing the geodetic positions from the results of the triangulation work. The mathematical treatment of this subject is so difficult that the formulas to be used are given without demonstration, but all the rules and constants are given that the engineer will ever require.

The sixth chapter is devoted to geodetic leveling, and contains the familiar knowledge on this subject arranged as briefly as is consistent with clearness and completeness.

The seventh chapter is devoted to astronomical determinations, giving in detail such work as falls within the province of the engineer, and in outline such general information as the educated engineer should possess, but which is seldom found in engineering text-books. The number of methods for making astronomical determinations is almost without limit, but the older and well-tried methods are here retained as best adapted to the needs of the engineer.

The eighth chapter considers the principal methods of map

projection, and differs from the treatment found in other books chiefly by including the formulas which alone make it possible to use the different methods.

Chapters IX to XVI form the second part of the book, devoted to the development of the Method of Least Squares and its application to the adjustment of observations.

Chapter IX includes the necessary classification of values, quantities and errors, and also the laws of chance on which the theory of errors is founded. This is followed in Chapter X by the development of the mathematical theory of errors, which is the fundamental basis from which all the rules for adjustments are derived.

Chapter XI develops the mathematical methods for obtaining the most probable values of independent quantities in general from their observed values, and Chapter XII extends the methods so as to include conditioned and computed quantities.

Chapter XIII explains the meaning of and methods of obtaining the probable error for both observed and computed quantities. The derivation of the necessary formulas is considered too abstruse for the average student, and these formulas are given without demonstration.

Chapters XIV, XV, and XVI, deal respectively with the application of the theory of least squares to the various conditions met with and adjustments required in angle work, base-line work, and level work, covering all cases likely to be of interest to the civil engineer.

In the preparation of the text the following points have been kept constantly in view: to bring the book up to date; to make the treatment of each subject as clear and concise as possible; to use the same symbols throughout the book for the same meaning, adopting the symbols having the most general acceptance; to define each symbol in a formula where the formula is developed, so that the user of the formula is never required to hunt for the meaning of its terms; to give for every formula the unit in which each symbol is to be taken; to clear up any doubt as to what algebraic sign is to be given to a symbol in a formula, as the sign required in a geodetic formula is not infrequently the opposite of what would naturally be supposed; to make perfectly rigid such demonstrations as are given; where demonstrations are not given to state where they may be found; to give the best

obtainable values for all constants required in geodetic work; and to state the accuracy attainable with different instruments and methods, so that a proper choice may be made. Attention is called to the very large number of illustrative examples that are given, and which are worked out in detail so that every process may be thoroughly understood.

E. L. I.

PHILADELPHIA, PA., December, 1911.

TABLE OF CONTENTS

INTRODUCTION

ART.	PAGE
1. GEODESY DEFINED	1
2. IMPORTANCE OF GEODETIC WORK	1
3. GEODETIC WORK IN THE UNITED STATES	1
4. HISTORICAL NOTES	1
5. SCOPE OF GEODESY	2
6. GEODETIC SURVEYING	2
7. ADJUSTMENT OF OBSERVATIONS	3

PART I

GEODETIC SURVEYING

CHAPTER I

PRINCIPLES OF TRIANGULATION

8. GENERAL SCHEME	4
9. GEOMETRICAL CONDITIONS	5
10. SPECIAL CASES	8
11. CLASSIFICATION OF TRIANGULATION SYSTEMS	9
12. SELECTION OF STATIONS	10
13. RECONNOISSANCE	10
14. CURVATURE AND REFRACTION	12
15. INTERVISIBILITY OF STATIONS	14
<i>Example</i>	15
16. HEIGHT OF STATIONS	17
<i>Example</i>	17
17. STATION MARKS	17
18. OBSERVING STATIONS AND TOWERS	18

ART.	PAGE
19. STATION SIGNALS OR TARGETS	18
<i>Board Signals</i>	20
<i>Pole Signals</i>	20
<i>Heliotropes</i>	21
<i>Night Signals</i>	23

CHAPTER II

BASE-LINE MEASUREMENT

20. GENERAL SCHEME	24
21. BASE-BARS AND THEIR USE	24
22. STEEL TAPES AND THEIR USE	30
23. INVAR TAPES	32
24. MEASUREMENTS WITH STEEL AND BRASS WIRES	32
25. STANDARDIZING BARS AND TAPES	33
26. CORRECTIONS REQUIRED IN BASE-LINE WORK	33
27. CORRECTION FOR ABSOLUTE LENGTH	36
28. CORRECTION FOR TEMPERATURE	36
29. CORRECTION FOR PULL	38
30. CORRECTION FOR SAG	39
31. CORRECTION FOR HORIZONTAL ALIGNMENT	40
32. CORRECTION FOR VERTICAL ALIGNMENT	42
33. REDUCTION TO MEAN SEA LEVEL	43
34. COMPUTING GAPS IN BASE LINES	44
35. ACCURACY OF BASE-LINE MEASUREMENTS	45
<i>Example</i>	46

CHAPTER III

MEASUREMENT OF ANGLES

36. GENERAL CONDITIONS	47
37. INSTRUMENTS FOR ANGULAR MEASUREMENTS	47
38. THE REPEATING INSTRUMENT AND ITS USE	52
39. FIRST METHOD WITH REPEATING INSTRUMENT	52
40. SECOND METHOD WITH REPEATING INSTRUMENT	53
40a. Reducing the Notes	56
40b. Illustrative Example	57
40c. Additional Instructions	58
41. ADJUSTMENTS OF THE REPEATING INSTRUMENT	59
42. THE DIRECTION INSTRUMENT AND ITS USE	60
43. FIRST METHOD WITH DIRECTION INSTRUMENT	61
44. SECOND METHOD WITH DIRECTION INSTRUMENT	64
45. THE MICROMETER MICROSCOPES	65
46. READING THE MICROMETERS	67
46a. Run of the Micrometer	68
<i>Example</i>	72

ART.	PAGE
47. ADJUSTMENTS OF THE DIRECTION INSTRUMENT.....	71
48. REDUCTION TO CENTER.....	75
49. ECCENTRICITY OF SIGNAL.....	78
50. ACCURACY OF ANGLE MEASUREMENTS.....	78
<i>Example</i>	79

CHAPTER IV

TRIANGULATION ADJUSTMENTS AND COMPUTATIONS

51. ADJUSTMENTS.....	81
52. THEORY OF WEIGHTS.....	81
53. LAWS OF WEIGHTS.....	82
<i>Examples</i>	82
54. STATION ADJUSTMENT.....	84
<i>Examples</i>	84
55. FIGURE ADJUSTMENT.....	87
56. SPHERICAL EXCESS.....	88
57. TRIANGLE ADJUSTMENT.....	89
58. THE GEODETIC QUADRILATERAL.....	90
59. APPROXIMATE ADJUSTMENT OF A QUADRILATERAL.....	92
<i>Example</i>	95
60. RIGOROUS ADJUSTMENT OF A QUADRILATERAL.....	96
<i>Example</i>	101
61. WEIGHTED ADJUSTMENTS AND LARGER SYSTEMS.....	100
62. COMPUTING THE LINES OF THE SYSTEM.....	102
63. ACCURACY OF TRIANGULATION WORK.....	102

CHAPTER V

COMPUTING THE GEODETIC POSITIONS

64. THE PROBLEM.....	103
65. THE FIGURE OF THE EARTH.....	104
66. THE PRECISE FIGURE.....	105
67. THE PRACTICAL FIGURE.....	106
68. GEOMETRICAL CONSIDERATIONS.....	106
69. ANALYTICAL CONSIDERATIONS.....	109
70. CONVERGENCE OF THE MERIDIANS.....	111
71. THE PUISSANT SOLUTION.....	113
72. THE CLARKE SOLUTION.....	116
73. THE INVERSE PROBLEM.....	118
74. LOCATING A PARALLEL OF LATITUDE.....	120
75. DEVIATION OF THE PLUMB LINE.....	124

CHAPTER VI

GEODETIC LEVELING

ART.	PAGE
76. PRINCIPLES AND METHODS.....	125
77. DETERMINATION OF MEAN SEA LEVEL.....	125

A. BAROMETRIC LEVELING

78. INSTRUMENTS AND METHODS.....	126
79. THE COMPUTATIONS.....	128
<i>Example</i>	128
80. ACCURACY OF BAROMETRIC WORK.....	129

B. TRIGONOMETRIC LEVELING

81. INSTRUMENTS AND METHODS.....	130
82. BY THE SEA HORIZON METHOD.....	131
83. BY AN OBSERVATION AT ONE STATION.....	133
84. BY RECIPROCAL OBSERVATIONS.....	136
85. COEFFICIENT OF REFRACTION.....	138
86. ACCURACY OF TRIGONOMETRIC LEVELING.....	139

C. PRECISE SPIRIT LEVELING

87. INSTRUMENTAL FEATURES.....	139
88. GENERAL FIELD METHODS.....	143
89. THE EUROPEAN LEVEL.....	145
89a. Constants of European Level.....	146
<i>Examples</i>	147
89b. Adjustments of European Level.....	150
<i>Example</i>	152
89c. Use of European Level.....	152
<i>Example</i>	154
90. THE COAST SURVEY LEVEL.....	153
90a. Constants of Coast Survey Level.....	155
90b. Adjustments of Coast Survey Level.....	155
90c. Use of Coast Survey Level.....	156
<i>Example</i>	157
91. RODS AND TURNING POINTS.....	158
92. ADJUSTMENT OF LEVEL WORK.....	160
<i>Example</i>	160
93. ACCURACY OF PRECISE SPIRIT LEVELING.....	161

CHAPTER VII

ASTRONOMICAL DETERMINATIONS

ART.	PAGE
94. GENERAL CONSIDERATIONS.....	163

TIME

95. GENERAL PRINCIPLES.....	164
96. MEAN SOLAR TIME.....	164
96a. Standard Time.....	165
96b. To Change Standard Time to Local Mean Time and <i>vice versa</i>	165
<i>Examples</i>	168
97. SIDEREAL TIME.....	168
98. TO CHANGE A SIDEREAL TO A MEAN TIME INTERVAL AND <i>vice versa</i>	169
99. TO CHANGE LOCAL MEAN TIME OR STANDARD TIME TO SIDEREAL..	169
<i>Example</i>	169
100. TO CHANGE SIDEREAL TO LOCAL MEAN TIME OR STANDARD TIME..	170
<i>Example</i>	170
101. TIME BY SINGLE ALTITUDES.....	171
101a. Making the Observation.....	172
101b. The Computation.....	173
<i>Example</i>	175
102. TIME BY EQUAL ALTITUDES.....	176
102a. Making the Observation.....	176
102b. The Computation.....	177
<i>Example</i>	180
103. TIME BY SUN AND STAR TRANSITS.....	181
103a. Sun Transits with Engineering Instruments.....	181
103b. Star Transits with Engineering Instruments.....	182
103c. Star Transits with Astronomical Instruments.....	183
104. CHOICE OF METHODS.....	184
105. TIME DETERMINATIONS AT SEA.....	184

LATITUDE

106. GENERAL PRINCIPLES.....	186
107. LATITUDE FROM OBSERVATIONS ON THE SUN AT APPARENT NOON....	188
108. LATITUDE BY CULMINATION OF CIRCUMPOLAR STARS.....	190
109. LATITUDE BY PRIME-VERTICAL TRANSITS.....	192
110. LATITUDE WITH THE ZENITH TELESCOPE.....	193
111. LATITUDE DETERMINATIONS AT SEA.....	196
112. PERIODIC CHANGES IN LATITUDE.....	196

ART.	LONGITUDE	PAGE
113.	GENERAL PRINCIPLES	197
114.	DIFFERENCE OF LONGITUDE BY SPECIAL METHODS	198
	<i>By Special Phenomena</i>	198
	<i>By Flash Signals</i>	198
115.	LONGITUDE BY LUNAR OBSERVATIONS	198
	<i>By Lunar Distances</i>	199
	<i>By Lunar Culminations</i>	199
	<i>By Lunar Occultations</i>	199
116.	DIFFERENCE OF LONGITUDE BY TRANSPORTATION OF CHRONOMETERS	199
117.	DIFFERENCE OF LONGITUDE BY TELEGRAPH	200
	<i>By Standard Time Signals</i>	201
	<i>By Star Signals</i>	201
	<i>By Arbitrary Signals</i>	202
118.	LONGITUDE DETERMINATIONS AT SEA	203
119.	PERIODIC CHANGES IN LONGITUDE	203

AZIMUTH

120.	GENERAL PRINCIPLES	203
121.	THE AZIMUTH MARK	204
122.	AZIMUTH BY SUN OR STAR ALTITUDES	205
	122a. Making the Observation	205
	122b. The Computation	206
123.	AZIMUTH FROM OBSERVATIONS ON CIRCUMPOLAR STARS	207
	123a. Fundamental Formulas	208
	123b. Approximate Determinations	213
	123c. The Direction Method	215
	<i>Example</i>	216
	123d. The Repeating Method	218
	<i>Example</i>	219
	123e. The Micrometric Method	221
	<i>Example</i>	223
124.	AZIMUTH DETERMINATIONS AT SEA	225
125.	PERIODIC CHANGES IN AZIMUTH	226

CHAPTER VIII

GEODETTIC MAP DRAWING

126.	GENERAL CONSIDERATIONS	227
127.	CYLINDRICAL PROJECTIONS	229
	127a. Simple Cylindrical Projection	229
	127b. Rectangular Cylindrical Projection	231
	127c. Mercator's Cylindrical Projection	231
128.	TRAPEZOIDAL PROJECTION	234

ART.		PAGE
129.	CONICAL PROJECTIONS.....	234
	129a. Simple Conic Projection.....	235
	129b. Mercator's Conic Projection.....	236
	129c. Bonne's Conic Projection.....	238
	129d. Polyconic Projection.....	239

PART II

ADJUSTMENT OF OBSERVATIONS BY THE METHOD OF LEAST SQUARES

CHAPTER IX

DEFINITIONS AND PRINCIPLES

130.	GENERAL CONSIDERATIONS.....	241
131.	CLASSIFICATION OF QUANTITIES.....	241
132.	CLASSIFICATION OF VALUES.....	242
133.	OBSERVED VALUES AND WEIGHTS.....	243
134.	MOST PROBABLE VALUES AND WEIGHTS.....	243
135.	TRUE AND RESIDUAL ERRORS.....	245
136.	SOURCES OF ERROR.....	247
137.	NATURE OF ACCIDENTAL ERRORS.....	247
138.	THE LAWS OF CHANCE.....	248
139.	SIMPLE EVENTS.....	248
140.	COMPOUND EVENTS.....	249
141.	CONCURRENT EVENTS.....	249
142.	MISAPPLICATION OF THE LAWS OF CHANCE.....	250

CHAPTER X

THE THEORY OF ERRORS

143.	THE LAWS OF ACCIDENTAL ERROR.....	252
144.	GRAPHICAL REPRESENTATION OF THE LAWS OF ERROR.....	253
145.	THE TWO TYPES OF ERROR.....	254
146.	THE FACILITY OF ERROR.....	255
147.	THE PROBABILITY OF ERROR.....	256
148.	THE LAW OF THE FACILITY OF ERROR.....	257
149.	FORM OF THE PROBABILITY EQUATION.....	257
150.	GENERAL EQUATION OF THE PROBABILITY CURVE.....	260
151.	THE VALUE OF THE PRECISION FACTOR.....	262
152.	COMPARISON OF THEORY AND EXPERIENCE.....	264

CHAPTER XI

MOST PROBABLE VALUES OF INDEPENDENT QUANTITIES

ART.	PAGE
153. GENERAL CONSIDERATIONS.....	266
154. FUNDAMENTAL PRINCIPLE OF LEAST SQUARES.....	266
155. DIRECT OBSERVATIONS OF EQUAL WEIGHT.....	267
<i>Example</i>	268
156. GENERAL PRINCIPLE OF LEAST SQUARES.....	268
157. DIRECT OBSERVATIONS OF UNEQUAL WEIGHT.....	270
<i>Example</i>	271
158. INDIRECT OBSERVATIONS.....	271
159. INDIRECT OBSERVATIONS OF EQUAL WEIGHT ON INDEPENDENT QUANTITIES.....	273
<i>Examples</i>	274
160. INDIRECT OBSERVATIONS OF UNEQUAL WEIGHT ON INDEPENDENT QUANTITIES.....	276
<i>Examples</i>	277
161. REDUCTION OF WEIGHTED OBSERVATIONS TO EQUIVALENT OBSER- VATIONS OF UNIT WEIGHT.....	278
<i>Examples</i>	279
162. LAW OF THE COEFFICIENTS IN NORMAL EQUATIONS.....	280
<i>Example</i>	281
163. REDUCED OBSERVATION EQUATIONS.....	281
<i>Examples</i>	282

CHAPTER XII

MOST PROBABLE VALUES OF CONDITIONED AND COMPUTED QUANTITIES

164. CONDITIONAL EQUATIONS.....	284
165. AVOIDANCE OF CONDITIONAL EQUATIONS.....	285
<i>Examples</i>	286
166. ELIMINATION OF CONDITIONAL EQUATIONS.....	288
<i>Example</i>	289
167. METHOD OF CORRELATIVES.....	290
<i>Example</i>	295
168. MOST PROBABLE VALUES OF COMPUTED QUANTITIES.....	296

CHAPTER XIII

PROBABLE ERRORS OF OBSERVED AND COMPUTED QUANTITIES

A. OF OBSERVED QUANTITIES

169. GENERAL CONSIDERATIONS.....	297
170. FUNDAMENTAL MEANING OF THE PROBABLE ERROR.....	297

TABLE OF CONTENTS

xvii

ART.	PAGE
171. GRAPHICAL REPRESENTATION OF THE PROBABLE ERROR.....	298
172. GENERAL VALUE OF THE PROBABLE ERROR.....	299
173. DIRECT OBSERVATIONS OF EQUAL WEIGHT.....	300
<i>Example</i>	300
174. DIRECT OBSERVATIONS OF UNEQUAL WEIGHT.....	301
<i>Example</i>	302
175. INDIRECT OBSERVATIONS ON INDEPENDENT QUANTITIES.....	302
<i>Example</i>	303
176. INDIRECT OBSERVATIONS INVOLVING CONDITIONAL EQUATIONS.....	304
177. OTHER MEASURES OF PRECISION.....	304

B. OF COMPUTED QUANTITIES

178. TYPICAL CASES.....	306
179. THE COMPUTED QUANTITY IS THE SUM OR DIFFERENCE OF AN OBSERVED QUANTITY AND A CONSTANT.....	306
<i>Example</i>	307
180. THE COMPUTED QUANTITY IS OBTAINED FROM AN OBSERVED QUANTITY BY THE USE OF A CONSTANT FACTOR.....	307
<i>Example</i>	308
181. THE COMPUTED QUANTITY IS ANY FUNCTION OF A SINGLE OB- SERVED QUANTITY.....	308
<i>Example</i>	308
182. THE COMPUTED QUANTITY IS THE ALGEBRAIC SUM OF TWO OR MORE INDEPENDENTLY OBSERVED QUANTITIES.....	308
<i>Examples</i>	309
183. THE COMPUTED QUANTITY IS ANY FUNCTION OF TWO OR MORE INDEPENDENTLY OBSERVED QUANTITIES.....	310
<i>Examples</i>	310

CHAPTER XIV

APPLICATION TO ANGULAR MEASUREMENTS

184. GENERAL CONSIDERATIONS.....	312
----------------------------------	-----

SINGLE ANGLE ADJUSTMENT

185. THE CASE OF EQUAL WEIGHTS.....	312
<i>Example</i>	312
186. THE CASE OF UNEQUAL WEIGHTS.....	313
<i>Example</i>	313

STATION ADJUSTMENT

187. GENERAL CONSIDERATIONS.....	313
188. CLOSING THE HORIZON WITH ANGLES OF EQUAL WEIGHT.....	313
<i>Example</i>	315

ART.	PAGE
189. CLOSING THE HORIZON WITH ANGLES OF UNEQUAL WEIGHT	315
<i>Example</i>	317
190. SIMPLE SUMMATION ADJUSTMENTS	317
<i>Examples</i>	318
191. THE GENERAL CASE	319
<i>Examples</i>	320

FIGURE ADJUSTMENT

192. GENERAL CONSIDERATIONS	321
193. TRIANGLE ADJUSTMENT WITH ANGLES OF EQUAL WEIGHT	322
<i>Example</i>	323
194. TRIANGLE ADJUSTMENT WITH ANGLES OF UNEQUAL WEIGHT	323
<i>Example</i>	324
195. TWO CONNECTED TRIANGLES	325
<i>Example</i>	325
196. QUADRILATERAL ADJUSTMENT	326
<i>Example</i>	330
197. OTHER CASES OF FIGURE ADJUSTMENT	329
<i>Examples</i>	331

CHAPTER XV

APPLICATION TO BASE-LINE WORK

198. UNWEIGHTED MEASUREMENTS	333
<i>Example</i>	333
199. WEIGHTED MEASUREMENTS	333
<i>Example</i>	334
200. DUPLICATE LINES	334
<i>Example</i>	335
201. SECTIONAL LINES	335
<i>Example</i>	336
202. GENERAL LAW OF THE PROBABLE ERRORS	336
<i>Example</i>	337
203. THE LAW OF RELATIVE WEIGHT	337
204. PROBABLE ERROR OF A LINE OF UNIT LENGTH	338
205. DETERMINATION OF THE NUMERICAL VALUE OF THE PROBABLE ERROR OF A LINE OF UNIT LENGTH	339
<i>Example</i>	341
206. THE UNCERTAINTY OF A BASE LINE	342
<i>Examples</i>	343

CHAPTER XVI

APPLICATION TO LEVEL WORK

ART.	PAGE
207. UNWEIGHTED MEASUREMENTS	344
<i>Example</i>	344
208. WEIGHTED MEASUREMENTS	345
<i>Example</i>	345
209. DUPLICATE LINES	346
<i>Example</i>	346
210. SECTIONAL LINES	347
<i>Example</i>	347
211. GENERAL LAW OF THE PROBABLE ERRORS	347
<i>Example</i>	348
212. THE LAW OF RELATIVE WEIGHT	348
213. PROBABLE ERROR OF A LINE OF UNIT LENGTH	348
214. DETERMINATION OF THE NUMERICAL VALUE OF THE PROBABLE ERROR OF A LINE OF UNIT LENGTH	349
<i>Example</i>	350
215. MULTIPLE LINES	350
<i>Example</i>	351
216. LEVEL NETS	352
<i>Example</i>	353
217. INTERMEDIATE POINTS	355
<i>Example</i>	356
218. CLOSED CIRCUITS	357
<i>Example</i>	358
219. BRANCH LINES, CIRCUITS, AND NETS	359

FULL-PAGE PLATES

EXAMPLE OF A TRIANGULATION SYSTEM	6
EXAMPLE OF A TOWER STATION	19
EIMBECK DUPLEX BASE-BAR	28
CONTACT SLIDES, EIMBECK DUPLEX BASE-BAR	29
REPEATING INSTRUMENT	49
DIRECTION INSTRUMENT	50
ALTAZIMUTH INSTRUMENT	51
REDUCTION TO CENTER	77
LOCATION OF A BOUNDARY LINE	123
EUROPEAN TYPE OF PRECISE LEVEL	141
COAST SURVEY PRECISE LEVEL	142
MOLITOR'S PRECISE LEVEL ROD AND JOHNSON'S FOOT-PIN	159
CELESTIAL SPHERE	166
PORTABLE ASTRONOMICAL TRANSIT	185
MAP OF CIRCUMPOLAR STARS	191
ZENITH TELESCOPE	195

TABLES

	PAGE
I. CURVATURE AND REFRACTION IN ELEVATION.....	363
II. LOGARITHMS OF THE PUISSANT FACTORS.....	364
III. BAROMETRIC ELEVATIONS.....	366
IV. CORRECTION COEFFICIENTS TO BAROMETRIC ELEVATIONS FOR TEMPERATURE (FAHRENHEIT) AND HUMIDITY.....	368
V. LOGARITHMS OF RADIUS OF CURVATURE (METRIC).....	369
VI. LOGARITHMS OF RADIUS OF CURVATURE (FEET).....	370
VII. CORRECTIONS FOR CURVATURE AND REFRACTION IN PRECISE SPIRIT LEVELING.....	370
VIII. MEAN ANGULAR REFRACTION.....	371
IX. ELEMENTS OF MAP PROJECTIONS.....	372
X. CONSTANTS AND THEIR LOGARITHMS.....	373

BIBLIOGRAPHY

REFERENCES ON GEODETIC SURVEYING.....	374
REFERENCES ON METHOD OF LEAST SQUARES.....	375

GEODETIC SURVEYING

AND

THE ADJUSTMENT OF OBSERVATIONS

(METHOD OF LEAST SQUARES)

INTRODUCTION

1. Geodesy is that branch of science which treats of making extended measurements on the surface of the earth, and of related problems. Primarily the object of such work is to furnish precise locations for the controlling points of extensive surveys. The determination of the figure and dimensions of the earth, however, is also a fundamental object.

2. The Importance of Geodetic Work is recognized by all civilized nations, each of which maintains an extensive organization for this purpose. The knowledge thus gained of the earth and its surface has been of great benefit to humanity. In furtherance of this object an International Geodetic Association has been formed (1886), and includes the United States (1889) in its membership.

3. Geodetic Work in the United States is carried on mainly by the United States Coast and Geodetic Survey, a branch of the Department of Commerce and Labor. The valuable papers on geodetic work published by this department may be obtained free of charge by addressing the "Superintendent United States Coast and Geodetic Survey, Washington, D. C."

4. History. Plane surveying dates from about the year 2000 B.C. Geodesy literally began about 230 B.C., in the time of Eratosthenes and the famous school of Alexandria, at which time very fair results were secured in the effort to determine the

shape and size of the earth. Modern geodesy practically began in the seventeenth century in the time of Newton, owing to disputes concerning the shape of the earth and the flattening of the poles. (See Chapter V for further treatment of this subject.)

5. The Scope of Geodesy originally involved only the shape of the earth and its dimensions. Modern geodesy covers many topics, the principal ones being about as follows:

Leveling (on land);

Soundings (oceans, lakes, rivers);

Mean Sea Level;

Triangulation;

Time;

Latitude (by observation);

Longitude (by observation);

Azimuth (by observation);

Computation of Geodetic Positions (latitude, longitude, and azimuth by computation);

Problems of Location;

Figure and Dimensions of the Earth;

Configuration of the Earth;

Map Projection;

Gravity;

Terrestrial Magnetism;

Deviation of the Plumb Line;

Tides and Tidal Phenomena;

Ocean Currents;

Meteorology.

6. Geodetic Surveying. This class of surveying is distinguished from plane surveying by the fact that it takes account of the curvature of the earth, usually necessitated by the large distances or areas covered. Work of this character requires the utmost refinement of methods and instruments,

1st, Because allowing for the curvature of the earth is in itself a refinement;

2nd, Because small measurements have to be greatly expanded;

3rd, Because the magnitude of the work involves an accumulation of errors.

The fundamental operations of geodetic surveying are Triangulation and Precise Leveling. These in turn require the deter-

mination of time, latitude, longitude, and azimuth; the determination of mean sea level; and a knowledge of the figure and dimensions of the earth. The first part of this book covers such points on these subjects as are likely to interest the civil engineer.

7. The Adjustment of Observations. All measurements are subject to more or less unknown and unavoidable sources of error. Repeated measurements of the same quantity can not be made to agree precisely by any refinement of methods or instruments. Measurements made on different parts of the same figure do not give results that are absolutely consistent with the rigid geometrical requirements of the case. Some method of adjustment is therefore necessary in order that these discrepancies may be removed. Obviously that method of adjustment will be the most satisfactory which assigns the *most probable values* to the unknown quantities in view of all the measurements that have been taken and the conditions which must be satisfied. Such adjustments are now universally made by the Method of Least Squares. The application of this method to the elementary problems of geodetic work forms the subject-matter of the second part of this book.

PART I

GEODETIC SURVEYING

CHAPTER I

PRINCIPLES OF TRIANGULATION

8. General Scheme. The word *triangulation*, as used in geodetic surveying, includes all those operations required to determine either the relative or the absolute positions of different points on the surface of the earth, when such operations are based on the properties of plane and spherical triangles. By the *relative* position of a point is meant its location with reference to one or more other points in terms of angles or distance as may be necessary. In geodetic work distances are usually expressed in meters, and are always reduced to mean sea level, as explained later on. By the *absolute* position of a point is meant its location by latitude and longitude. Strictly speaking the absolute position of a point also includes its elevation above mean sea level, but if this is desired it forms a special piece of work, and comes under the head of leveling. Directions are either relative or absolute. The *relative* directions of the lines of a survey are shown by the measured or computed angles. The *absolute* direction of a line is given by its *azimuth*, which is the angle it makes with a meridian through either of its ends, counting clockwise from the south point and continuously up to 360°. For reasons which will appear later the azimuth of a line must always be stated in a way that clearly shows which end it refers to.

In the actual field work of the triangulation suitable points, called *stations*, are selected and definitely marked throughout the area to be covered, the selection of these stations depending on the character of the country and the object of the survey.

The stations thus established are regarded as forming the vertices of a set of mutually connected triangles (overlapping or not, as the case may be), the complete figure being called a *triangulation system*. At least one side and all the angles in the triangulation system are directly measured, using the utmost care. All the remaining sides are obtained by computation of the successive triangles, which (corrected for spherical excess, if necessary) are treated as plane triangles. The line which is actually measured is called the *base line*. It is common to measure an additional line near the close of the work, this line being connected with the triangulation system so that its length may also be obtained by calculation. Such a line is called a *check base*, forming an excellent check on both the field work and the computations of the whole survey. In work of large extent intermediate bases or check bases are often introduced. Lines which are actually measured on the ground are always reduced to mean sea level before any further use is made of them. It is evident that all computed lengths will therefore refer to mean sea level without further reduction.

The stations forming a triangulation system are called *triangulation stations*. Those stations (usually triangulation stations) at which special work is done are commonly given corresponding names, such as *base-line stations*, *astronomical stations*, *latitude stations*, *longitude stations*, *azimuth stations*, etc.

An example of a small triangulation system (United States and Mexico Boundary Survey, 1891-1896) is shown in Fig. 1, page 6, the object being to connect the "Boundary Post" on the azimuth line to the westward with "Monument 204" on the azimuth line to the eastward. The air-line distance between these points is about 23 miles. The system is made up of the quadrilateral West Base, Azimuth Station, East Base, Station No. 9; the quadrilateral Pilot Knob, Azimuth Station, Station No. 10, Station No. 9; the quadrilateral Pilot Knob, Azimuth Station, Station No. 10, Monument 204; and the triangle Pilot Knob, Boundary Post, Azimuth Station. The base line (West Base to East Base) has a length of 2,205 meters (1.37+ miles), and the successive expansions are evident from the figure.

9. Geometrical Conditions. The triangles and combinations thereof which make up a triangulation system form a figure involving rigid geometrical relations among the various lines and angles. The measured values seldom or never exactly satisfy these con-

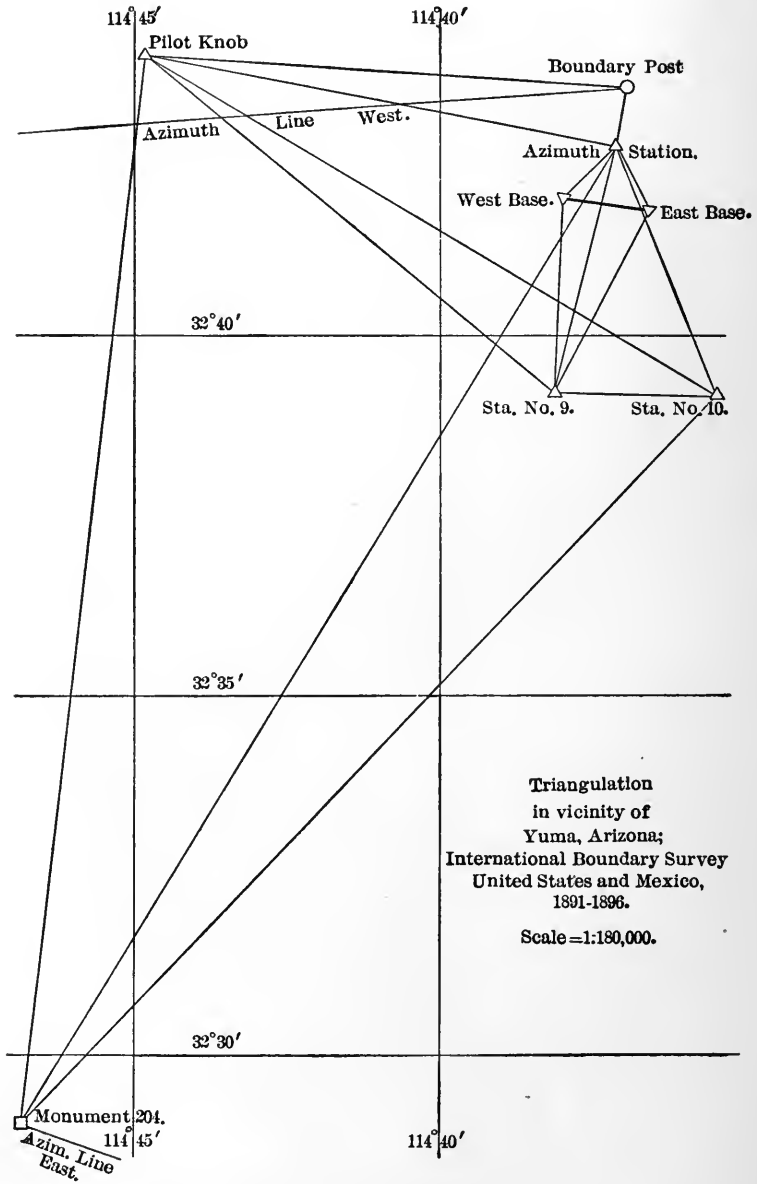

FIG. 1.—Example of a Triangulation System.

From Report of U. S. Section of International Boundary Commission.

ditions, and must therefore be adjusted until they do. In the nature of things the true values of the lines and angles can never be known, but the greater the number of independent conditions on which an adjustment is based the greater the probability that the adjusted values lie nearer to the truth than the measured values. It is for this reason that work of an extended character is arranged so that some or all of the measured values will be involved in more than one triangle, thus greatly increasing the number of conditions which must be satisfied by the adjustment.

The simplest system of triangulation is that in which the work is expanded or carried forward through a succession of independent triangles, each of which is separately adjusted and computed; and where the work is of moderate extent this is usually all that is necessary. The best triangulation system, under ordinary circumstances, when the survey is of a more extended character, or great accuracy is desired, is that in which the work is so arranged as to form a succession of independent quadrilaterals, each of which is separately adjusted and computed. (In work of great magnitude the entire system would be adjusted as a whole.) A *geodetic quadrilateral* is the figure formed by connecting any four stations in every possible way, the result being the ordinary quadrilateral with both its diagonals included; there is no station where the diagonals intersect. The eight corner angles of the quadrilateral are always measured independently, and then adjusted (as explained later) so as to satisfy all the geometric requirements of such a figure. Other arrangements of triangles are sometimes used for special work. More complicated systems of triangles or adjustment are seldom necessary or desirable, except in the very largest class of work. Since triangulation systems are usually treated as a succession of independent figures it evidently makes no difference whether the figures overlap or extend into new territory.

Every triangulation system is fundamentally made up of triangles, and in order that small errors of measurement shall not produce large errors in the computed values, it is necessary that only well shaped triangles should be permitted. The best shaped triangle is evidently equilateral, while the best shaped quadrilateral is a perfect square, and these are the figures which it is desirable to approximate as far as possible. A well shaped triangle is one which contains no angle smaller than 30° (involving

the requirement that no angle must exceed 120°). In a quadrilateral, however, angles much less than 30° are often necessary and justifiable in the component triangles.

10. Special Cases. It is often desirable and feasible (especially on reconnoissance) to connect two distant stations with a narrow and approximately straight triangulation system, as shown diagrammatically by the several plans in Fig. 2. In these diagrams the heavy dots represent the stations occupied, all the angles at each station being directly measured. The maximum length

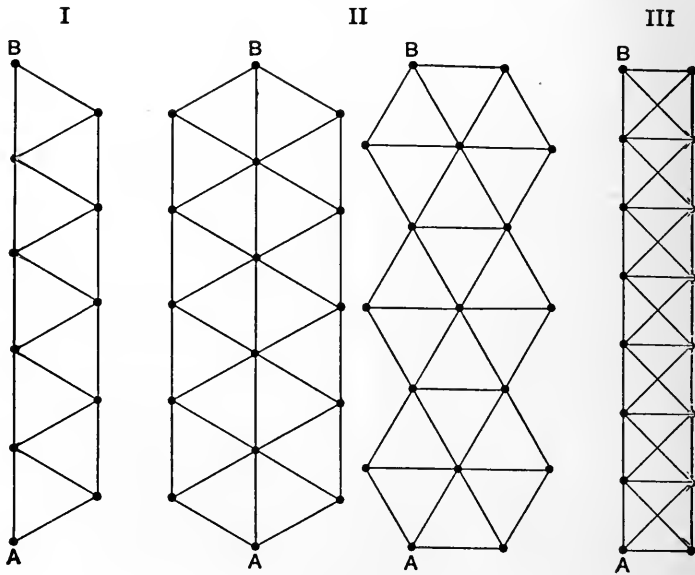

FIG. 2.

of sight is approximately the same in each case. The stations to be connected are marked *A* and *B*. In an actual survey, of course, the location of the stations could only approximate the perfect regularity of the sketches.

In System I the terminal stations are connected by a simple chain of triangles. This plan is the cheapest and most rapid, but also the least accurate.

System II is given in two forms, which are substantially alike in cost and results, the hexagonal idea being the basis of each construction. This system not only covers the largest area, but greatly increases the accuracy attainable. The large num-

ber of stations in this system necessarily increases both the labor and the cost.

System III is formed by a continuous succession of quadrilaterals, and is the one to use where the highest degree of accuracy is desired. The area covered is less than in System I, but the cost and labor approximate System II.

11. Classification of Triangulation Systems. It has been found convenient to classify triangulation systems (and the triangles involved) as *primary*, *secondary* and *tertiary*, based on the magnitude and accuracy of the work.

Primary triangulation is that which is of the greatest magnitude and importance, sometimes extending over an entire continent. In work of this character the highest attainable degree of accuracy (1 in 500,000 or better) is sought, using long base lines, large and well shaped triangles, the highest grade of instruments, and the best known methods of observation and computation. Primary base lines may measure from three to ten or more miles in length, with successive base lines occurring at intervals of one hundred to several hundreds of miles (about 30 to 100 times the length of base), depending on the character of the country traversed and the instrument used in making the measurement. In primary triangulation the sides of the triangles may vary from 20 to 100 miles or more in length.

Secondary triangulation covers work of great importance, often including many hundred miles of territory, but where the base lines and triangles are smaller than in primary systems, and where the same extreme refinement of instruments and methods is not necessarily required. An accuracy of 1 in 50,000 is good work. Base lines in secondary work may measure from one to three miles in length, and occur at intervals of about twenty to fifty times the length of base. The triangle sides may vary from about five to forty miles in length.

Tertiary triangulation includes all those smaller systems which are not of sufficient size or importance to be ranked as *primary* or *secondary*. The accuracy of such work ranges upwards from about 1 in 5,000. The base lines measure from about a half to one and a half miles long, occurring at intervals of about ten to twenty-five times the length of base. The triangle sides may measure from a fraction of a mile up to about six miles in length.

In an extended survey the primary triangulation furnishes

the great main skeleton on which the accuracy of the whole survey depends; the secondary systems (branching from the primary) furnish a great many well located intermediate points; and the tertiary systems (branching from the secondary) furnish the multitude of closely connected points which serve as the reference points for the final detailed work of the survey.

12. Selection of Stations. This part of the work calls for the greatest care and judgment, as it practically controls both the accuracy and the cost of the survey. Every effort, therefore, should be made to secure the best arrangement of stations consistent with the object of the survey, the grade of work desired, and the allowable cost. The base line is usually much smaller than the principal lines of the triangulation system, and therefore requires an especially favorable location, in order that its length may be accurately determined. Approximately level or gently sloping ground (not over about 4°) is demanded for good base-line work. It is also necessary that the base line be connected as directly as possible with one of the main lines of the system, using a minimum number of well shaped triangles. The base-line stations and the connecting triangulation stations are consequently dependent on each other, in order that both objects may be served. In flat country the greatest freedom of choice would probably lie with the base-line stations, while in rough country the triangulation stations would probably be largely controlled by a necessary base-line location.

The various stations in a triangulation system must be selected not only with regard to the territory to be covered and the formation of well shaped triangles, but so as to secure at a minimum expense the necessary intervisibility between stations for the angles to be measured. Clearing out lines of sight is expensive in itself, and may also result in damages to private interests. Building high stations in order to see over obstructions is likewise expensive. A judicious selection of stations may materially reduce the cost of such work without prejudicing the other interests of the survey. It is important that lines of sight should not pass over factories or other sources of atmospheric disturbance. These and similar points familiar to surveyors must all receive the most careful consideration.

13. Reconnoissance. The preliminary work of examining the country to be surveyed, selecting and marking the various

base-line and angle stations, determining the required height for tower stations, etc., is called *reconnoissance*. As much information as possible is obtained from existing maps, such as the height and relative location of probable station points and desirable arrangement of triangles. The reconnoissance party then selects in the field the best location of stations consistent with the grade and object of the survey and in accordance with the principles laid down in the preceding article. The reconnoissance is often carried forward as a survey itself, so that fairly good values are obtained of all the quantities which will finally be determined with greater accuracy by the main survey. When a point is thought to be suitable for a station a high signal is erected, such as a flag on a pole fastened on top of a tree or building, and the surrounding country is scanned in all directions to pick up previously located signals and to select favorable points for advance stations.

The instrumental outfit of the reconnoissance party is selected in accordance with the character of the information which it proposes to obtain. In any event it must be provided with convenient means for measuring angles, directions, and elevations. A minimum outfit would probably contain a sextant for measuring angles, a prismatic compass for measuring directions, an aneroid barometer for measuring elevations, a good field glass, and creepers for climbing poles and trees.

A common problem for the reconnoissance party is to establish the direction between two stations which can not be seen from each other until the forest growth is cleared out along the connecting line. Any kind of a traverse run from one station to the other would furnish the means for computing this direction, but the following simple plan can often be used:

Let AB , Fig. 3, be the direction it is desired to establish. Find two inter-visible points C and D from each of which both A and B can be seen. Measure each of the two angles at C and D and assume any value (one is the simplest) for the length CD . From the triangle ACD compute the relative value of AD . Similarly from BCD get the relative value of BD . Then from the

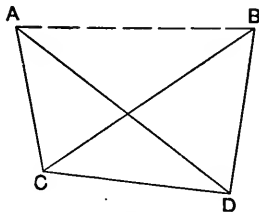

FIG. 3.

triangle ABD compute the angles at A and B , which will give the direction of AB from either end with reference to the point D . All computed lengths are necessarily only relative because CD was assumed, but the computed angles are of course correct.

The required intervisibility of any two stations must be finally determined on the ground by the reconnoissance party, but a knowledge of the theoretical considerations governing this question is of the greatest importance and usefulness.

14. Curvature and Refraction. Before discussing the intervisibility of stations it is necessary to consider the effect of curvature and refraction on a line of sight. In geodetic work *curvature*

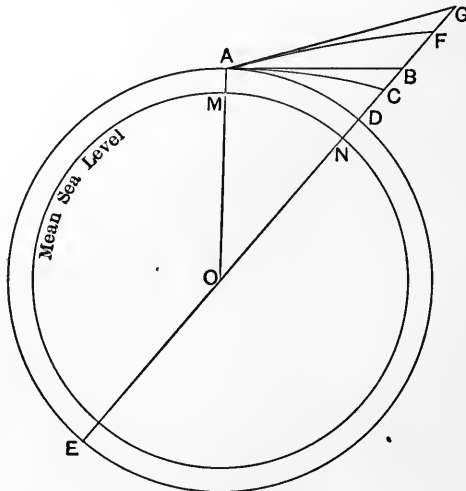

FIG. 4.

is understood to mean the apparent reduction of elevation of an observed station, due to the rotundity of the earth and consequent falling away of a level line (see Art. 76) from a horizontal line of sight. *Refraction* is understood to mean the apparent increase of elevation of an observed station, due to the refraction of light and consequent curving of the line of sight as it passes through air of differing densities. The net result is an apparent loss of elevation, causing an angle of depression in sighting between two stations of equal altitude. In Fig. 4 the circle ADE represents a level line through the observing point A , necessarily following the curvature of the earth. Assum-

ing the line of sight to be truly level or horizontal at the point A , the observer apparently sees in the straight line direction AB (tangent to the circle at A), but owing to the refraction of light actually looks along the curved line AC (also tangent at A). The observer therefore regards C as having the same elevation as A , whereas the point D is the one which really has the same elevation as A . There is hence an apparent loss of elevation at C equal to CD , as the net result of the loss BD due to curvature and the gain BC due to refraction. Just as C appears to lie at B , so any point F appears to lie at a corresponding point G . The apparent difference of elevation of the points A and F is measured by the line BG , the true difference being DF . As $DF = BG + BD - FG$, the apparent loss equals $BD - FG$, which does not ordinarily differ much from CD .

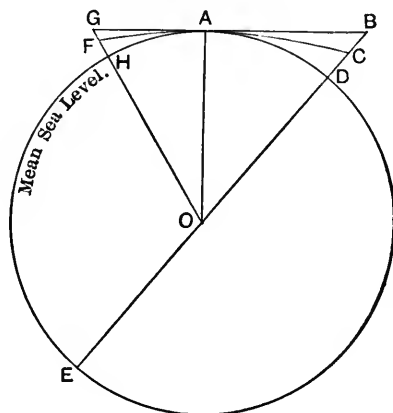

FIG. 5.

So far as the intervisibility of two stations is concerned it is only necessary to know the effect of curvature and refraction with reference to a straight line tangent to the earth at mean sea level. Referring to Fig. 5, BD represents the effect of curvature, and BC the effect of refraction, as in the previous figure. By geometry we have

$$AB^2 = BD \times BE.$$

The earth is so large as compared with any actual case in practice that we may substitute AD (=distance, called K)

for AB , and DE ($= 2R$) for BE , without any practical error, and write

$$BD = \text{curvature} = \frac{\text{Distance}^2}{\text{Aver. diam. of earth}} = \frac{K^2}{2R},$$

in which all values are to be taken in the same units. (For mean value of R see Table X at end of book.) As the result of proper investigations we may also write

$$BC = \text{refraction} = m \frac{\text{Distance}^2}{\text{Aver. rad. of earth}} = m \frac{K^2}{R} = 2m \frac{K^2}{2R},$$

in which m is a coefficient having a mean value of .070, and K and R are the same as before. (For additional values of m see Art. 85.) We thus have

$$BD - BC = CD = \text{curv. and refract.} = (1 - 2m) \frac{K^2}{2R}.$$

Table I (at end of book) shows the effect of curvature and refraction, computed by the above formula, for distances from 1 to 66 miles.

15. Intervisibility of Stations *The elevation* (or *altitude*) of a station is the elevation of the observing instrument above mean sea level. This is not to be confused with the *height* of a station, which is the elevation of the instrument above the natural ground. In order that two stations may be visible from each other the line of sight must clear all intermediate points. The necessary (or minimum) elevation of each station will therefore be governed by the following considerations:

1. *The elevation of the other station.* Obviously a line of sight which is required to clear a given point by a certain amount can not be lowered at one end without being raised at the other.

2. *The profile of the intervening country.* It is evidently not only the height of an intermediate point but also its location between the two stations that will determine its influence on their intervisibility. An elevation great enough to obstruct the line of sight if located near the lower station might be readily seen over if located near the higher station.

3. *The distance between the stations.* Owing to the curvature of the earth it is necessary in looking from one point to another to see over the intervening rotundity, the extent of which depends

on the distance between the stations. Since lines of sight are nearly straight this can not be accomplished unless at least one of the stations has a greater elevation than any intermediate point. Owing to the refraction of light the line of sight is not really a straight line, but in any actual case is practically the arc of a circle, with the concavity downwards, and a radius about seven times that of the earth. This fact slightly lessens the elevation necessary to see over the rotundity, but otherwise does not change the conditions to be met. Thus in Fig. 5 the points F and C are just barely intervisible, though F and C both have greater elevations than A .

In view of the above facts it is usually necessary to place stations on the highest available ground, such as ridge lines, summits, or mountain peaks, increasing the height, if necessary, by suitably built towers.

The simplest question of intervisibility is illustrated in Fig. 5, page 13, where all points between stations F and C lie at the elevation of mean sea level. If the elevation of F is given or assumed the corresponding distance HA to the point of tangency is taken out directly from Table I (interpolating if necessary). The value CD corresponding to the remaining distance AD is then taken out from the same table, and gives the minimum elevation of C which will make it visible from F . Thus if $HD = 30.0$ miles, and elevation of $F = 97.0$ ft., we have $HA = 13.0$ miles, and the remaining distance $AD = 17.0$ miles, calling for a minimum elevation of 165.8 ft. for station C .

In general the profile between two stations is more or less irregular, and the question can not be handled in the above simple manner. It is usually necessary to compute the elevations of the line of sight at a number of different points and compare the results with the ground elevation at such points. The critical points are usually evident from an inspection of the profile. Owing to the uncertainties of refraction accurate methods of computation are not worth while; different methods of approximation give slightly different results, but all sufficiently near the truth for the desired purpose.

The following example will show a satisfactory method of procedure in any case that may arise in practice. The line $AEJP$, Fig. 6, page 16, is the natural profile of the ground, and it is desired if possible to establish stations at A and P . The critical points

that might obstruct the line of sight are evidently at E and J . Assume the following data to be known:

Distances (at mean sea level).	Elevations (above M. S. L.).
$BH = 30.0$ miles	$A = 1140.6$ ft. = AB
$HN = 10.1$ "	$E = 1322.7$ " = EH
$NR = 10.7$ "	$J = 1689.0$ " = JN
	$P = 2098.3$ " = PR

For an imaginary line of sight BQ , horizontal at B we have from Table I (by interpolating):

$$\text{Elevation of } \begin{cases} G = 516.4 \text{ ft.} = GH. \\ M = 922.8 \text{ " } = MN. \\ Q = 1480.9 \text{ " } = QR. \end{cases} \quad \text{Hence } PQ = 617.4 \text{ ft.}$$

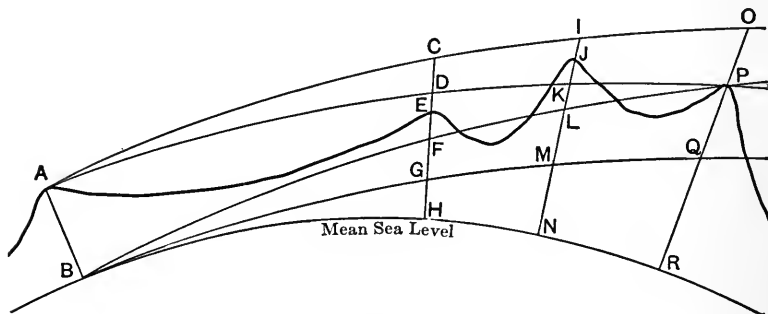

FIG. 6.

Assuming the lines of sight BP , AP , and AO to have the same radius of curvature as BQ , we may write approximately

$$\frac{FG}{PQ} = \frac{BG}{BQ} = \frac{BH}{BR} \quad \text{and} \quad \frac{LM}{PQ} = \frac{BM}{BQ} = \frac{BN}{BR},$$

giving, by substitution, $FG = 364.6$ ft. and $LM = 498.3$ ft.

$$\text{Hence we have elevation of } \begin{cases} F = 881.0 \text{ ft.} \\ L = 1421.1 \text{ ft.} \end{cases}$$

By the similar approximations

$$\frac{DF}{AB} = \frac{FP}{BP} = \frac{HR}{BR} \quad \text{and} \quad \frac{KL}{AB} = \frac{LP}{BP} = \frac{NR}{BR},$$

we find $DF = 467.0$ ft. and $KL = 240.2$ ft.

Hence we have elevation of $\begin{cases} D = 1348.0 \text{ ft.} \\ K = 1661.3 \text{ ft.} \end{cases}$

Hence the line of sight AP clears E by 25.3 ft., but fails to clear J by 27.7 ft.

16. Height of Stations. Referring to the previous article, suppose it is desired to erect a tower OP , so that the line of sight OA shall clear the obstruction J . It was found that the line PA failed to clear J by 27.7 ft., and it is not desirable to have a line of sight less than 6 ft. from the ground, hence IK should be about 34 ft. Using the approximation

$$\frac{OP}{IK} = \frac{AP}{AK} = \frac{BR}{BN} \quad \text{or} \quad \frac{OP}{34.0} = \frac{50.8}{40.1},$$

we find $OP = 43.1$ ft.

Hence a suitable tower at P should not be less than 43 ft. high. If it were desired to build a smaller tower at P , the instrument at A would also have to be elevated, the amount being determined by a similar plan of approximation. It is evident that the least total height of towers is obtained by building a single tower at the station nearest to the obstruction. If the obstruction is practically midway between the stations the combined height of any two corresponding towers would of course come the same as that of a suitable single tower. If more than one obstruction is to be seen over, the most economical arrangement of towers is readily found by a few trial computations.

In heavily wooded country tower stations extending above the tree tops are frequently more economical than clearing out long lines of sight, and their construction is therefore justified even though the intervening country would not otherwise demand their use. In general it is not wise to have a line of sight near the ground for any large portion of its length, on account of the unsteadiness of the atmosphere and the risk of sidewise refraction.

17. Station Marks. Any kind of a survey requires the station marks to remain unchanged at least during the period of the survey. When work is of sufficient magnitude or importance to justify geodetic methods and instruments, permanent station marks are usually desirable. The best plan seems to be to place the principal mark below the ground, as least likely to suffer

disturbance by frost, accident, or malicious interference. Though many plans have been tried, the common underground mark consists of a stone about $6'' \times 6'' \times 24''$ placed vertically with its top about $30''$ below the surface of the ground, the center point being marked by a small hole or copper bolt. The underground mark is of course only used in case there is reason to think the surface mark has been moved. The surface mark usually consists of a similar stone, reaching nearly down to the bottom stone and extending a few inches above the surface, with the station point similarly marked. Three witness stones are commonly set near the station (where least likely to be disturbed, ordinarily 200 or more feet from the station, and forming approximately an equilateral triangle), with their azimuths and distances recorded, so that the station might be restored if entirely destroyed. Stones about $36''$ long and projecting about $12''$ above the surface have proven satisfactory. Other means of establishing permanent stations will suggest themselves to the surveyor when the surrounding conditions are known.

18. Observing Stations and Towers. In addition to the station mark a suitable support is required to carry the observing instrument. Unless the tripod is very heavy and stiff it will not prove satisfactory. In such a case a rigid support must be provided. Heavy posts well set in the ground may serve as the basis for such a construction for a low height, bracing as may prove necessary for rigidity. If an observing platform is built it must not be connected in any way with the structure that carries the instrument. A low masonry pier makes an excellent station. Under 15 ft. in height a tripod can be built at the station heavy enough to be satisfactory as an instrument support. For greater heights a regular tower should be built to carry the instrument, so braced and guyed as to be absolutely immovable and free from vibration. The observer's platform must be carried by an entirely independent structure surrounding the instrument tower without being in any way connected with it, or in any way possible to come in contact with it. A light awning on a framework attached to the observer's platform should shelter the instrument from the sun. Fig. 7 shows a common form of tower station.

19. Station Signals or Targets. These terms (used more or less interchangeably) refer to that object at a station which is sighted at by observers at other stations. A satisfactory target

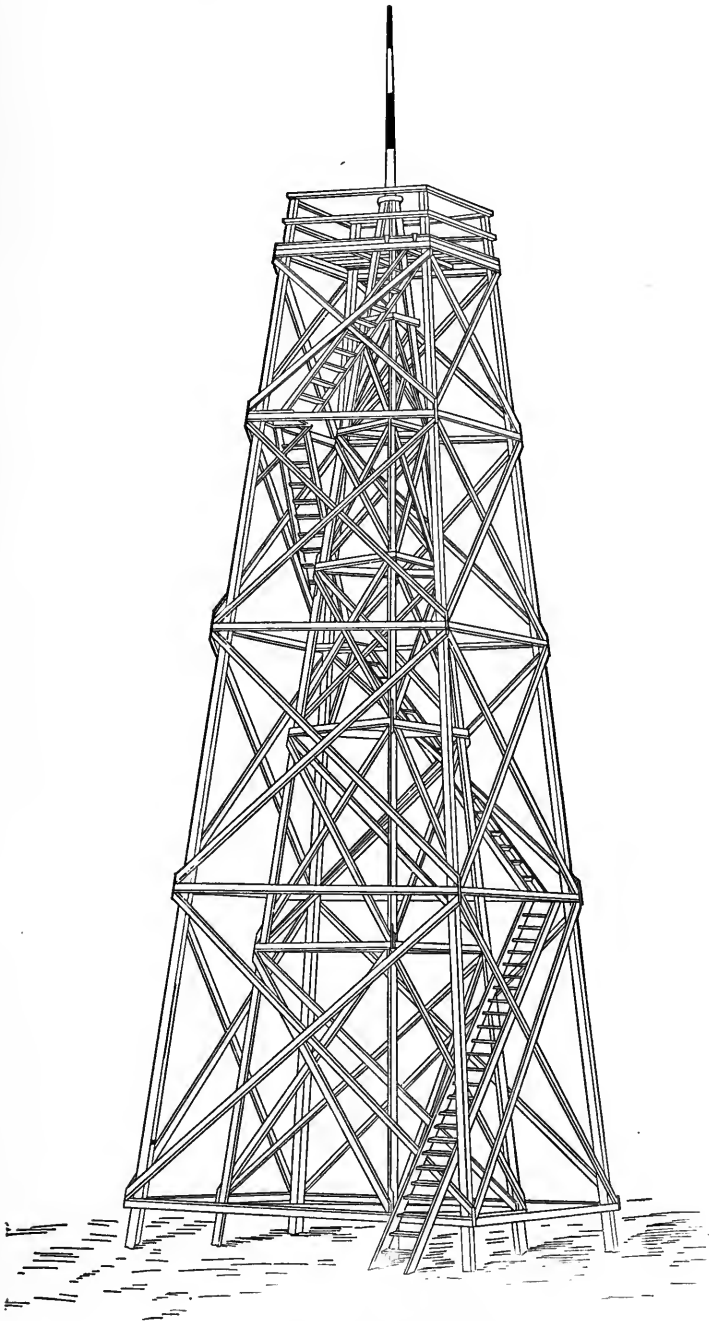

FIG. 7.—Tower Station.
From Appendix No. 9, Report for 1882, U. S. C. and G. S.

must be distinctly visible against any background and of suitable width for accurate bisection, and preferably free from phase. When the face of a target is partially illuminated and partially in shadow, the observer usually sees only the illuminated portion and thus makes an erroneous bisection, the apparent displacement of the center of the target being called *phase*. Targets of this kind have been used and rules for correction for phase devised, but targets free from phase are much to be preferred. The target may be a permanent part of the station (such as a flagpole carried by an overhead construction so as to clear the instrument), or only brought into service when the station is not occupied (such as flagpoles, heliotropes or night signals). In any case a signal must of course be accurately centered over the station. Eccentric signals are sometimes used, involving a corresponding reduction of results, but where the instrument and signal can not occupy the same position it is more common to regard the signal as the true station and the instrument as eccentric.

Board Signals. Approximately square boards, three or more feet wide, painted in black and white vertical stripes or other designs, have been tried as targets and found usually unsatisfactory, except for distances of a few miles only. The painted designs are hard to see unless in direct sunlight and not easy to bisect even then. They present their full width in only one direction. If two such boards are placed at right angles (whether as a cross or one above the other) so as to give a good apparent width in any direction, the shadow of one board on the other produces the very phase difficulty that board targets were designed to prevent.

Pole Signals. Round (sometimes square) poles, painted black and white in alternate lengths, are frequently used for signals. Against a sky background they give good results, but against a dark background they may give the usual trouble from phase. Their diameter should be about $1\frac{1}{2}$ inches for the first mile, increasing roughly as the square root of the distance. Their size becomes prohibitory for distances of over 15 or 20 miles. The equivalent of a pole signal, made out of wire and canvas and free from phase, was found very satisfactory on the Mississippi River Survey. The general construction consisted of four vertical wires forming a square, held in place by wire rings (all connections soldered), black and white canvas being stretched

across the diagonal wires between the successive rings, so as to form a vertical series of black and white planes at right angles to each other and showing both colors in both directions. The distance between the rings was made several times the diameter of the rings, so that any shadow or phase effect would affect only a very small part of the length of each canvas. In addition to being accurately centered any pole or equivalent signal must of course be set truly vertical.

Heliotropes. When the distance between stations exceeds about 15 or 20 miles resort is had to reflected sunlight as a signal. If the reflecting surface is of proper size such a signal is entirely satisfactory for any distance from the smallest to the largest, on account of the certainty with which it is seen. Any device

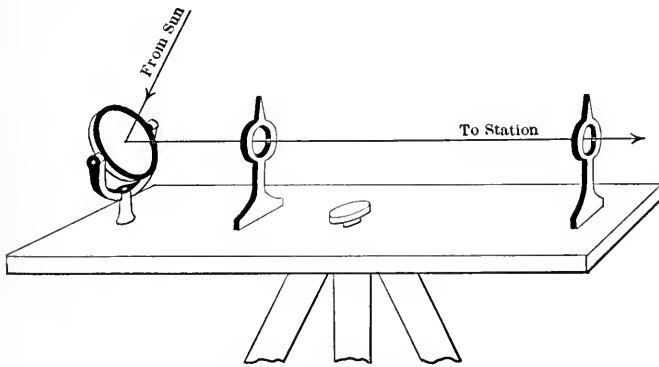

FIG. 8.—Heliotrope.

by which the rays of the sun may be reflected in a given direction is called a heliotrope, the essential features being a plane mirror and a line of sight. A simple form of such an instrument is shown in Fig. 8. An additional mirror (called the *back mirror*) is also required, in order to reflect the sunlight onto the main mirror when it can not be directly received. The heliotrope is generally mounted on a tripod, with a horizontal motion for lining in with the distant station, and is centered over its own station with a plumb bob.

In more elaborate forms a telescope with universal motion furnishes the line of sight, the mirror and vanes being mounted on top of it.

In using the instrument it is pointed towards the observing

station by means of the sight vanes or telescope, and the mirror is turned so as to throw the shadow of the near vane centrally on the farther vane, an attendant moving the mirror slightly every few minutes as required. The cone of rays reflected by the mirror subtends an angle of about 32 minutes (the angular diameter of the sun as seen from the earth), or about 50 feet in width per mile. The light will therefore be seen at the observing station if the error of pointing is less than 16 minutes or about 25 feet per mile. The topographical features of the country generally enable the heliotrope to locate a station with this degree of approximation without any other aid, though it is well to be provided with a good pair of field glasses if the heliotrope has no telescope. The observing station usually has a heliotrope also, so that the two stations may be in communication by agreed signals or by using the telegraphic alphabet of dots and dashes (long flashes for dashes and short ones for dots, swinging a hat or other handy object in front of the mirror to obscure the light as desired). When each station has a heliotrope they soon find each other by swinging the light around slowly until either one catches the other's light, when the two heliotropes are quickly and accurately centered on each other.

The best size of mirror to use depends on the character of the observing instrument, the state of the atmosphere, and the distance between stations. In order to have a signal capable of accurate bisection it must be neither dangerously indistinct nor dazzlingly bright. Between these limits there is a wide range of light which is satisfactory. If the light is too bright it is readily reduced by covering the mirror with a cardboard disc containing a suitable sized hole. A mirror whose diameter is proportioned at the rate of 0.2 inch per mile of distance will answer well for average conditions of climate and instruments. In the dry climate of our western states one-half this rate will prove sufficient. In the southern part of California the writer has seen a six-inch mirror for 80 miles across the Yuma desert with the naked eye, but this required exceptionally favorable conditions.

The apparent size of the heliotrope light varies remarkably with the time of day and the condition of the atmosphere, this phenomenon being an actual measurable fact and not an optical illusion. At sunrise and sunset the light appears as small as a star, almost covered by the vertical hair, and giving a perfect

pointing. Anywhere within about two hours of sunrise and sunset the image is circular, clean cut, and readily bisected, the size of the image increasing rapidly with the distance of the sun above the horizon. After the sun has risen a couple of hours above the horizon until noon the image gradually becomes more and more irregular in outline and gains in size at an enormous rate, sometimes filling 25 per cent of the field of view of the telescope at noon. The image then decreases in size and becomes gradually more regular in outline, becoming fit to observe again about two hours before sunset. When the wind blows strongly the image elongates like an ellipse, and appears to wave and flutter like a flag. If the attendant neglects his work, so that either the back mirror or main mirror is poorly pointed, the image loses rapidly in brilliancy. On the United States Boundary Survey, however, it was found by the most careful micrometric experiments that the center of the apparent image always corresponded with the true center of station.

Only one objection has been urged against the heliotrope, namely, that it can only be used when the sun is shining, while angles are best measured on cloudy days. Nevertheless, the heliotrope furnishes the best solution for long distance signals in the daytime, and good results can be obtained by making the measurements close to sunrise and sunset. For the best class of work the afternoon period is much the best, as great risk of sidewise (lateral) refraction always endangers the work of the morning period.

Night signals. A great deal of geodetic work has been done at night, using an artificial light as a signal, aided by a lens or parabolic reflector. Up to about forty miles a kerosene light with an Argand burner is entirely satisfactory. For any practicable distance the acetylene gas lamp is found to meet every requirement. Other kinds of lights have been successfully used, but those above given have the advantage that only unskilled labor is required to operate them, such as can operate heliotropes in the daytime. Up to midnight fully as good work can be done as in the daytime, but the remainder of the night does not provide favorable atmospheric conditions for close work. The chief advantage of night work is, of course, the fact that it practically doubles the number of hours per day available for good work.

CHAPTER II

BASE-LINE MEASUREMENT

20. General Scheme. The accurate measurement of base lines required for geodetic work may be accomplished with rigid base-bars placed successively end to end, or with flexible wires or tapes stretched successively from point to point. Base-bars were formerly used exclusively for the highest grade of work, but tape or wire measurements are rapidly growing in favor. The invar tape (a special kind of steel tape) is now being used exclusively by the United States Coast and Geodetic Survey for its base line measurements. The convenience of the steel tape is apparent, and the ease and rapidity with which it can be used are strong points in its favor.

No form of measuring apparatus maintains a constant length at all temperatures, nor is it often possible to measure along a mathematically straight line. Base lines can seldom be located at sea level. The actual length of a bar or tape under standard conditions (called its absolute length) is seldom found to be exactly the same as its designated length. Tapes and wires are elastic, and their length varies with the tension (pull) under which they are used. The weight of tapes or wires (when unsupported) causes them to sag and thus draw the ends closer together. In base-bar work corrections may hence be required for absolute length, temperature, horizontal and vertical alignment, and reduction to mean sea level. With tape or wire measurements corrections may be required for absolute length, temperature, pull, sag, horizontal and vertical alignment, and reduction to mean sea level. These corrections will be considered in turn after describing the types and use of bars and tapes.

21. Base-bars and Their Use. The fundamental idea of a base-bar is a rigid measuring unit, such as a metallic rod. The general scheme of measuring a base requires the use of two such bars. The first bar is placed in approximate position,

supported at the quarter points by two tripods or trestles, carefully aligned both horizontally and vertically, and moved longitudinally forward or backward until its rear end is vertically over one end of the base line. The second bar, similarly supported and aligned, is then drawn longitudinally backward until its rear end is just in contact with the forward end of the first bar. The first bar and its supports are then carried forward, alignment and contact made as before, and the measurement so continued to the end of the base. In the simple form outlined above the method would not produce results of sufficient accuracy for geodetic work, but with the perfected methods and apparatus in actual use measurements of extreme precision may be made.

Several features are more or less common to all types of base-bar. The actual measuring unit is generally made of metal and protected by an outer casing of wood or metal. Mercurial thermometers are located inside the casing for temperature measurements. Means are provided for aligning the bars horizontally, usually a telescope suitably mounted at the forward end of the bar. Vertical alignment is provided for, usually by a graduated sector carrying a level bubble, mounted on the side of the bar near its central point, so that the bar may be made truly horizontal or its inclination determined. A slow motion is provided for making the contact with the previous bar; the slow motion is produced by turning a milled head at the rear of the bar, which moves the measuring unit only, the casing remaining stationary in its approximate position on the tripods on account of the friction due to the weight of the bar. The rod (or tube) constituting the measuring unit terminates at its forward end with a small vertical abutting plane; the rear end of the rod carries a sliding sleeve pressed outward by a light spring and ending in a small straight knife edge for making the contact with the abutting plane of the previous bar; the length of the bar is the distance between the knife edge and the abutting plane of its measuring unit when the sliding sleeve is in its proper place, indicated by a mark on the sleeve coinciding with a mark on the rod; the forward bar is therefore brought into proper position without disturbing the rear bar, the only pressure on the rear bar being that due to the light spring controlling the contact sleeve while the forward measuring unit is slowly drawn

backward until the coincidence of the indicating lines shows that the bar is in its proper place.

One of the earlier forms of bar used by the U. S. Coast and Geodetic Survey is described in Appendix No. 17, Report for 1880, and called a perfected form of a contact-slide base apparatus. This bar was an improvement on similar bars in previous use, and besides the features enumerated above contained a new device for determining its own temperature. The actual measuring unit was a steel rod 8 mm. in diameter. A zinc tube 9.5 mm. in diameter was placed on each side of the steel rod (not quite reaching either end). The rear end of one zinc tube was soldered to the rear end of the steel rod, and the forward end of the other zinc tube was soldered to the forward end of the steel rod. By suitable scales on the steel rod and the free ends of the zinc tubes the apparatus was thus converted into a metallic thermometer

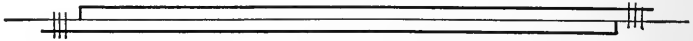

FIG. 9.—Thermometric Base-bar.

(zinc having a coefficient of expansion about $2\frac{3}{4}$ times that of steel), so that the temperature of the bar became very accurately measured. In Fig. 9 the arrangement is shown in outline, the light line indicating steel and the heavy lines zinc. This bar was 4 meters long.

In Appendix No. 7, Report for 1882, a compensating bar is described. This bar is made of a central zinc rod and two side steel rods, as shown in Fig. 10. The ends of this bar remain

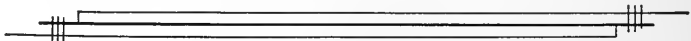

FIG. 10.—Compensating Base-bar.

nearly the same distance apart at all temperatures. The compensation is not absolutely perfect, however, and the scales at each end indicate the temperature so that the final small correction may be made for this cause. This bar was 5 meters long.

In Appendix No. 11, Report for 1897, the Einbeck duplex base-bar is described, this bar having almost entirely superseded those previously discussed. This bar is a bi-metallic contact-

slide apparatus consisting of two measuring units of precisely similar construction, one of steel and one of brass, each 5 meters in length, and weighs complete 118 pounds. The measuring units are made of tubing $\frac{3}{4}$ inch in diameter, each having a thickness of wall corresponding to the conductivity and specific heat of the material of which it is made, so that under changing conditions each tube shall keep the same temperature as the other one, which is an essential requirement. The two measuring tubes are carried in a brass protecting casing, which turns on its longitudinal axis in an outer brass protecting casing which remains stationary. The inner casing is rotated 180° from time to time to equalize temperature distribution. This bar is illustrated in Figs. 11 and 12. The two measuring units are entirely disconnected, and contact is always made brass to brass and steel to steel, so that two independent measures of the base are obtained, one by the brass unit and one by the steel unit. The difference in the length of these two measurements furnishes the key to the average temperature of the bars during the measuring, so that the correction for temperature can be very closely determined. Since the coefficient of expansion for brass is about $1\frac{1}{2}$ times that for steel, the two measuring units are seldom of the same length, and the shorter one continually gains on the longer one. To overcome this difficulty the measuring units are provided with vernier scales, and the brass bar is occasionally shifted a small amount which is read from the scales and recorded for an evident purpose. The duplex bar is superior to the bars previously described both in speed and accuracy. A speed of forty bars per hour is readily maintained.

The tripods used to support base-bars must be absolutely rigid. Special heads are provided so that both quick and slow motion are available for raising the bar support. The rear tripod usually has a knife-edge support and the front one a roller support. By easing the weight on the edge support the bar may be readily moved on the roller support and quickly brought into proper position.

Satisfactory work is accomplished with base-bars at all hours of the day. In order to protect the bars from the extreme heat of the sun, however, a portable awning is often placed over them, which is dragged steadily forward as the work advances.

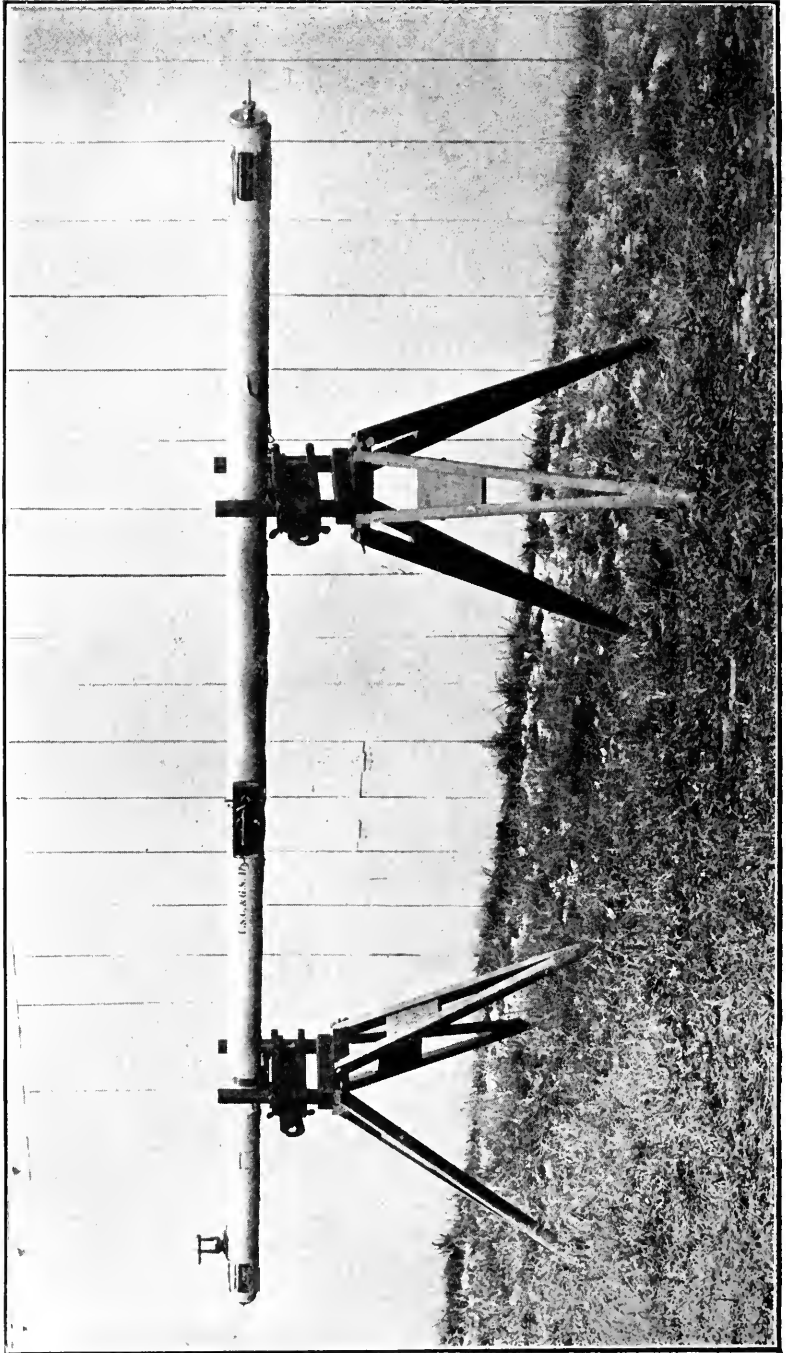

Fig. 11.—Einbeck Duplex Base-bar.
From a photograph loaned by the U. S. C. and G. S.

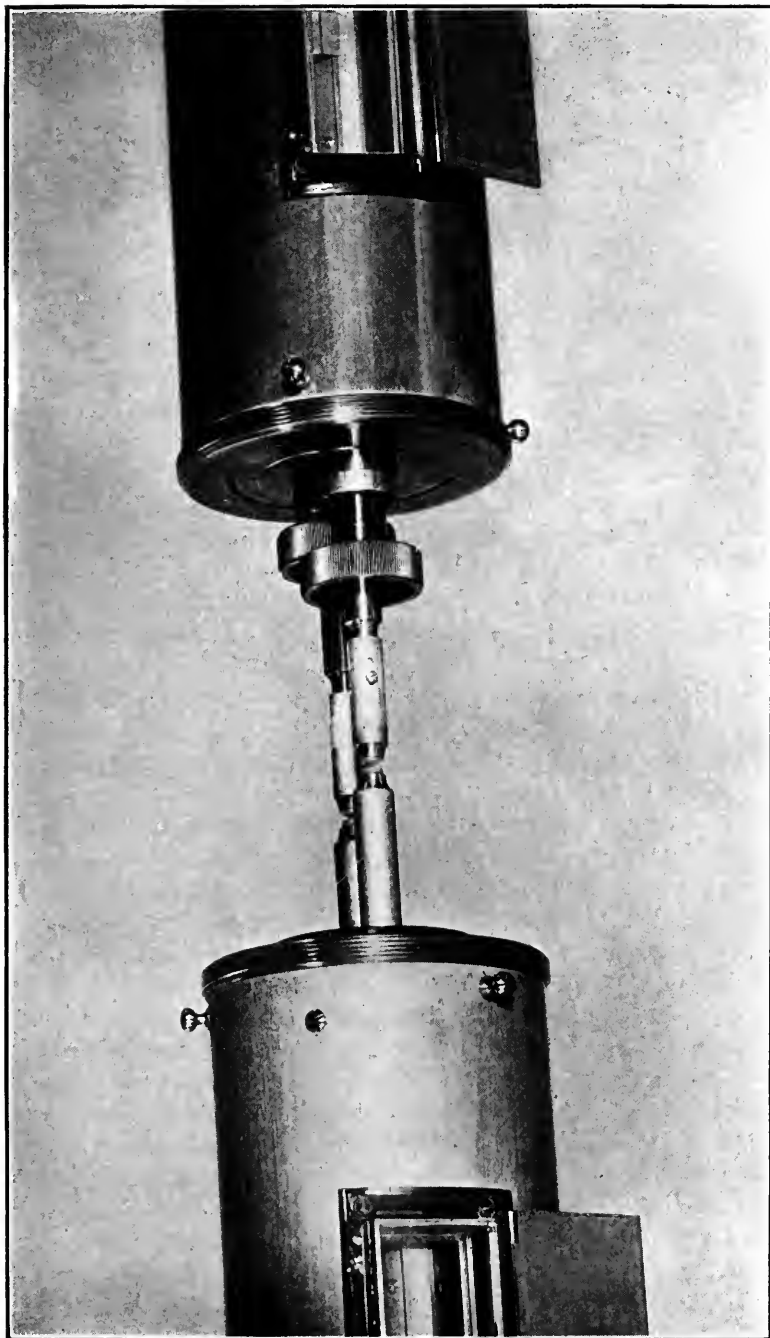

FIG. 12.—Contact Slides, Eimbeck Duplex Base-bar.
From a photograph loaned by the U. S. C. and G. S.

22. Steel Tapes and Their Use. Steel tapes for base-line work do not differ materially from ordinary tapes except in length. Surveyors generally use tapes 50 or 100 feet long, and with proper precautions a high grade of work can be done. Better or quicker work, however, can probably be done with longer tapes, such tapes usually being also somewhat smaller in cross-section. Experience shows that tapes 300 to 500 feet in length and with about 0.0025 square inch cross-section are entirely satisfactory.

It is seldom desirable to use the tape directly on the ground, on account of the uneven surface and the uncertainties of friction. The usual way is to support the tape at a number of equidistant points (20 to 100 feet), letting it hang suspended between these points and computing the corresponding correction for sag. In order to avoid any friction the supports are usually wire loops swinging from nails driven in carefully aligned stakes. Unless the points of support are on an even and determined grade it is necessary to measure the elevation of each such point, in order to make the necessary reduction for vertical alignment, that is, reduction to the horizontal. The points of support must have such elevations that the pull on the tape will not lift it free of any of the supports. No change of horizontal alignment is allowable within a single tape length. It is evident that good work can not be done with a suspended tape if an appreciable wind is blowing.

The pull on the tape must be exerted through the medium of a spring balance or other device attached to the forward end. The pull adopted may be from 12 to 20 pounds, depending on the weight of the tape and the distance between supports, so as to prevent excessive sagging and to hold the tape in line. For an accuracy of 1 in 50,000 the pull may be made with a good spring balance, properly steadied by connection with a good stake. For extreme accuracy the pull must be known within a question of ounces, and special stretching devices attached to firmly driven stakes are required. The desired amount of pull can be very accurately made through the simple device of a weight acting through a right-angled lever turning on a knife-edge fulcrum; the device must be so mounted that the lever arms can be brought into a truly vertical and horizontal position when the strain is on the tape.

The length of a steel tape is materially modified by a moderate change of temperature, so that the greatest care is required in making the corresponding correction. It is found in practice that a high grade of work can not be done in direct sunlight, owing to the difficulty of ascertaining the temperature of the tape, a mercurial thermometer held near the tape or in contact with it failing to give the true value by many degrees. An accuracy of 1 in 50,000 requires the mean temperature of the tape to be known within a degree, and an accuracy of 1 in 500,000 to within one-fifth of a degree. The highest grade of work can therefore be done only on densely cloudy days or at night.

In the common method of using steel tapes the tape is stretched (suspended) between two tripods (or posts driven or braced until immovable), the rear one being carried forward in turn for each new tape length. Intermediate supports are provided as previously described, if necessary. The rear end of the tape is connected with a straining stake a few feet back of the rear tripod; the front end is connected with the spring balance or other device for giving the desired pull, the strain at this end also being resisted by a suitable stake or stakes beyond the forward tripod; in this way no strain is allowed to come on either tripod. A small strip of zinc is secured to the top of each tripod, and each tripod is set with sufficient care so that the end mark on the tape will come somewhere on the zinc strip, the exact point being marked by making a fine scratch on the zinc with any suitable instrument. In regard to temperature measurements tapes 100 feet or less in length ought to have two thermometers tied to them, one at each quarter point; longer tapes, up to about 300 feet, ought to be equipped with three thermometers, one at the center, and one about one-sixth the length from each end.

Professor Edward Jäderin of Stockholm has obtained the very best results in a method slightly differing from the above. Professor Jäderin prefers a tape 25 meters long, 5 centimeters each side of the 25-meter mark being graduated to millimeters and read by estimation to the nearest tenth of a millimeter. Each tripod carries a single fixed graduation, and the distance between the marks on two successive tripods must not vary more than 5 centimeters either way from 25 meters. By means of the end scale on the tape the exact distance from tripod to tripod is determined and the whole base found by the sum of the results.

The best work can only be done on densely cloudy days or at night.

23. Invar Tapes. By alloying steel with about 35 per cent of nickel a material is produced possessing an exceedingly small coefficient of expansion, this discovery being due to C. E. Guillaume (of the International Bureau of Weights and Measures, near Paris). For this reason the name "invar" (from "invariable") has been applied to this material. Tapes made of invar have proven extremely satisfactory for the accurate measurement of base lines, errors in determining the temperature of the tape being of so much less importance than with steel tapes, which makes it possible to do first class work at all hours of the day.

The coefficient of expansion of invar is about 1:28 that of steel, or about 0.00000022 per degree Fahrenheit. The modulus of elasticity is about 8:10 that of steel, or about 23,000,000 pounds per square inch. The tensile strength is about 100,000 pounds per square inch, or about half that of the ordinary steel tape, but amply sufficient for the purpose. The yield point is about 70 per cent of the tensile strength.

In 1905 the Coast Survey purchased six invar tapes from J. H. Agar Baugh, London, Eng., for the purpose of subjecting them to the actual test of field work and comparing them with steel tapes under similar conditions. (See Appendix No. 4, 1907.) These tapes averaged about $0''.02 \times 0''.25$ in cross-section, about 53 meters in length, looked more like nickel than steel, and were full of innumerable small kinks which, however, did not cause any inaccuracy in actual service. They were very soft and easily bent, being much less elastic than steel, and requiring reels 16 inches in diameter to prevent permanent bending. Steady loads up to 60 pounds caused no permanent set. While rusting more slowly than steel tapes they were found to need oiling and care.

The experience of the Coast Survey with invar tapes indicates that they possess no properties derogatory to their use for base-line work, and that under similar conditions both better and cheaper work can be done than with steel tapes. They are used in all respects like steel tapes, using special care to avoid injury from bending.

24. Measurements with Steel and Brass Wires. Professor Edward Jäderin of Stockholm has found it possible to do excellent

base-line work throughout the entire day by using steel and brass wires instead of steel tapes. (See U. S. C. and G. S. Appendix No. 5, Report for 1893.) The object of using the metal in wire form instead of tape form is to minimize the effect of the wind, since the circular cross-section (for the same area) exposes much less surface to the action of the wind than the flat surface of the tape form. The method used is the same as described in the last paragraph of Art. 22, except that two values are obtained for the distance between each pair of tripods, one with the steel and one with the brass wire. Two measurements of the whole base line are thus obtained, and from their difference the average temperature of the wires is deduced and hence the corresponding correction. The assumption is made that the wires are always of equal temperature, both being given the same surface (nickel plate, for example), the same cross-section, and the same handling. The principle is identical with that of the Eimbeck duplex base-bar described in Art. 21.

25. Standardizing Bars and Tapes. The *nominal* length of a bar or tape is its ordinary designated length, as, for example, a fifty-foot tape or a five-meter bar. The actual length seldom equals the nominal length, but varies with changing conditions. The *absolute* length is the actual length under specified conditions. If the absolute length is known, the laws governing the change of length with changing conditions, and the particular conditions at the time of measuring, then the actual length of the measuring unit becomes known, and consequently the actual length of the line measured. By *standardizing* a bar or tape is meant determining its absolute length. Such an expression as the "temperature at which a bar or tape is standard" means the temperature at which the actual and designated lengths agree.

The absolute length of a bar or tape may be determined in a number of ways, but the essential principle in each case is the same, namely, the comparing of the unknown length with some known standard length at an accurately known temperature. If the comparison is made in-doors, the room must be one (such as in the basement of a building) where the temperature remains practically constant for long periods, so that the temperature of the measuring units will be the same as that of the surrounding air. If the comparison is made in the open air the work must be done on a densely cloudy day or at night, for the same reason.

Tapes are standardized unsupported, or supported horizontally throughout their length, at any convenient pull and temperature, the Coast Survey reducing the results by computation to a standard pull of 10 pounds and temperature of 62° F. The absolute length of a tape may be found by measuring it with a shorter unit (such as a standard yard or meter bar); by comparing it with a similar tape whose absolute length is known; by comparing it with fixed points whose distance apart is accurately known; or by measuring with it a base line whose length is already accurately known. For a nominal fee the Coast Survey at Washington will determine the absolute length of any tape up to 100 feet in length.

Any device or apparatus which permits a measuring unit to be compared with a standard length is called a *comparator*. It is quite common at the commencement of a survey to fix two points at a permanent and well determined distance apart, and compare all tapes used with these points from time to time; the standard or reference distance thus established would be called a comparator. In the laboratory the comparator may be a very elaborate piece of apparatus with micrometer microscopes, by which the most accurate comparisons may be made, or with which a measuring unit may be most accurately measured by a shorter standard.

Base-bars are probably most readily and accurately standardized by measuring a base line of known length with them. The actual length of the bar thus becomes known, by computation, for the temperature at which the measurement was made; and by means of its coefficient of expansion its length becomes known at any temperature.

Measuring the same base with the same bar or tape, at widely different temperatures, furnishes a good means of determining the coefficient of expansion if it is not otherwise known. With the compensating bar the coefficient of the residual expansion (since the compensation is never perfect) may be thus obtained.

If a base line of known length is measured with a duplex base-bar at a certain average temperature, the average actual length of each component bar (steel and brass) becomes known for that temperature, *and the difference in these average lengths indicates that particular temperature and that particular length of each bar*. The absolute length of each component is thus known

for that particular temperature. If the same thing is done at a widely different temperature the same information is obtained at the new temperature. Since the average length of each component is obtained at the two different temperatures *the coefficient of expansion of each component becomes known*. Since the difference in the lengths of the components is known at two widely separated temperatures, and since this difference changes uniformly from the lower to the higher temperature, the *temperature corresponding to any particular difference in the length of the bars also becomes known*. In measuring an unknown base with a duplex bar (provisionally using the absolute length of each component at the standard temperature on which the coefficient of expansion is based) the total difference by the two component bars becomes known, hence the average difference per bar length, hence the average temperature, hence by combination with the coefficient of expansion the actual length of each component at the time of measurement, hence the actual length of the base line. The result must, of course, be the same whether finally deduced from the steel or from the brass component, thus furnishing a good check on the computations. When base lines are measured with steel and brass wires these wires are standardized and used in the same manner as the duplex base-bar.

A base line of known length, to be used for standardizing bars or tapes, may be one that is measured with apparatus already standardized, or one measured with a base-bar packed in melting ice so as to ensure a constant and known temperature.

26. Corrections Required in Base-line Work. As explained in Art. 20, if a base line is measured with base-bars corrections may be required for absolute length, temperature, horizontal and vertical alignment, and reduction to mean sea level. If the base line is measured with supported tapes or wires an additional correction may be required for pull. If unsupported tapes or wires are used additional corrections may be required for both pull and sag. With a simple or a compensating base-bar, therefore, it is necessary to know its absolute length and coefficient of expansion before it can be used for base-line work. With a duplex base-bar (and correspondingly with double wire measurements) it is necessary to know the absolute length and coefficient of expansion of each of the component units. With tapes and wires it is necessary to know the absolute length, coefficient of

expansion, modulus of elasticity, area of cross-section, and weight. Except in work of great accuracy average values may be assumed for the weight, coefficient of expansion, and modulus of elasticity for the material of which the wire or tape is made.

The above corrections are relatively so small that they may be computed individually from the uncorrected length of base line, and their algebraic sum taken as the total correction required. A plus correction means that the uncorrected length is to be increased to obtain the true length, and a minus correction the reverse.

27. Correction for Absolute Length. The absolute length of a measuring unit is generally stated as its designated length plus or minus a correction. The total correction will have the same sign, and be equal to the given correction multiplied by the number of tape or bar lengths in the base (including fractional lengths expressed in decimals); or what amounts to the same thing, multiply the given correction by the length of the base and divide by the length of the measuring unit.

If C_a = correction for absolute length;
 c = correction to measuring unit;
 l = uncorrected length of measuring unit;
 L = uncorrected length of base;

then

$$C_a = \frac{Lc}{l}.$$

In duplex measurements the absolute lengths are used directly in the computations in order to determine the average temperature.

The quantities L and l must be expressed in the same unit (feet or meters, for instance), and C_a will be in the same unit as c (which need not be the same as used for L and l).

28. Correction for Temperature. In measuring a base line the temperature usually varies more or less during the progress of the work, but it is found entirely satisfactory to apply a correction due to their average temperature to the sum of all the even bar or tape lengths, and add a final correction for any fractional lengths and corresponding temperatures.

If C_t = correction for temperature;
 a = coefficient of expansion;
 T_m = mean temperature for length L ;
 T_s = temperature of standardization;
 L = length to be corrected;

then practically, since the measuring unit changes length uniformly with the temperature,

$$C_t = a(T_m - T_s)L.$$

C_t will be in the same unit as L and must be applied with its algebraic sign.

The coefficient of expansion for steel wires and tapes may vary from 0.0000055 to 0.0000070 per degree F., and if its value is not known for any particular case may be assumed as 0.0000063 (Coast Survey value). For the most accurate work the coefficient of expansion for the particular tape or wire ought to be carefully determined, either in the laboratory or by measuring a known base at widely different temperatures.

The coefficient of expansion for brass wires was found by Professor Jäderin to average 0.0000096 per degree F.

The coefficient of expansion of invar may be 0.0000022 per degree F., or less.

In the case of duplex measurements the average temperature and corresponding corrections may be deduced as follows:

Let L_s = provisional length of base, using absolute length of steel component at the standard temperature (usually 32° F. or 0° C.) to which coefficient of expansion refers;

L_b = same for brass;

A_s = coefficient of expansion of steel;

A_b = same for brass;

T = average number of degrees temperature above standard;

then the true length of base in terms of steel component

$$= L_s + L_s A_s T,$$

and in terms of brass component

$$= L_b + L_b A_b T.$$

Equating and reducing, we have

$$T = \frac{L_s - L_b}{L_b A_b - L_s A_s},$$

and correction for steel-component measurement

$$C_{ts} = L_s A_s T = \frac{L_s(L_s - L_b)A_s}{L_b A_b - L_s A_s},$$

or practically

C_{ts} = correction to measurement by steel component

$$= (L_s - L_b) \frac{A_s}{A_b - A_s},$$

and similarly

C_{tb} = correction to measurement by brass component

$$= (L_s - L_b) \frac{A_b}{A_b - A_s}.$$

These corrections will be in the same unit as L_s and L_b and are to be used with their algebraic signs.

29. Correction for Pull. This correction only occurs with tapes and wires; if the pull used is not the same as that to which the absolute length is referred a corresponding correction must be made.

Let C_p = correction for pull;

P_m = pull while measuring base line;

P_a = pull corresponding to absolute length;

S = area of cross-section of tape;

E = modulus of elasticity of tape;

L = uncorrected length of line;

then practically

$$C_p = \frac{(P_m - P_a)L}{SE}.$$

If E is taken in pounds per square inch, then P_m and P_a must be in pounds, L in inches, and S in squares inches, whence C_p will be in inches, and is to be applied with its algebraic sign.

If the cross-section is unknown it may readily be found by weighing the tape or wire (without the box or reel), and finding its volume by comparison with the specific weight of the same material. The cross-section then equals the volume divided by the length. The weight of a cubic foot may be assumed as 490 pounds for steel tapes, 500 pounds for steel wires, 520 pounds for brass wires, and 510 pounds for invar tapes.

If the modulus of elasticity is unknown it may be found as follows: Support the tape horizontally throughout its length, and apply two widely different pulls, noting how much the tape changes in length due to the change in the amount of pull.

Let P_s = smaller pull;

P_l = larger pull;

l = length of tape;

l_c = change in length caused by change in pull;

S = cross-section of tape;

E = modulus of elasticity;

then

$$E = \frac{(P_l - P_s)l}{Sl_c}$$

If P_l and P_s are taken in pounds, l and l_c in inches, and S in square inches, then E will be in pounds per square inch.

Except for the most accurate work E may be assumed as follows:

for steel, $E = 28,000,000$ lbs. per sq. in.

for brass, $E = 14,000,000$ “

for invar, $E = 23,000,000$ ”

30. Correction for Sag. This correction only occurs in the case of unsupported tapes and wires. In any actual case in practice the catenary curve thus formed will not differ sensibly in length from a parabola. The correction required is the difference in length between the curve and its chord.

Let C_s = correction for sag for one tape length;

c = correction for sag for the interval between one pair of supports;

l = length of tape;

d = horizontal distance between supports (for which the uncorrected distance given by the tape is used in practice without sensible error);

v = the amount of sag;

P = the pull;

w = weight of a unit length of tape.

The difference in length between the arc and chord of a very flat parabola (such as occurs in tape measurements) is found by the

calculus to be very nearly $\frac{8v^2}{3d}$, but the formula is never used in this form since it is inconvenient and unnecessary to measure v in actual work. Passing a vertical section midway between supports, and taking moments around one support, we have

$$Pv = \frac{wd}{2} \times \frac{d}{4} = \frac{wd^2}{8},$$

from which

$$v = \frac{wd^2}{8P},$$

whence

$$\frac{8v^2}{3d} = \frac{d(wd)^2}{24P^2} \quad \text{or} \quad c = -\frac{d(wd)^2}{24P^2},$$

and if there are n intervals per tape

$$C_s = -\frac{nd(wd)^2}{24P^2} = -\frac{l(wd)^2}{24P^2}.$$

The correction to the whole base line is found by multiplying the correction per tape length by the number of whole tape lengths, and adding thereto the corrections for any fractional tape lengths (which must be computed separately).

If w is taken as pounds per inch, then P must be taken in pounds and d and l in inches, whence C_s will be in inches.

The *normal tension* of a tape is such a tension as will cause the effects of pull and sag to neutralize each other, so that no correction need be made for these effects. Since the effects of pull and sag are opposite in character (pull increasing and sag decreasing distance between ends of tape) such a value can always be found by equating the formulas (for a tape length) for sag and for pull, and solving for P_n or pull to be used during measurement of line.

31. Correction for Horizontal Alignment. Ordinarily base lines are made straight horizontally, but sometimes slight deviations have to be introduced, forming what is called a broken base. Fig. 13 shows a common case of a broken base, a , b , and θ being measured, and c found by computation, some unavoidable

condition preventing the direct measurement of c . From trigonometry we have

$$a^2 + b^2 + 2ab \cos \theta = c^2,$$

so that c can always be found. If, however, θ is very small (say not over 3°) we may proceed as follows:

Let C_{bb} = correction for broken base; then

$$C_{bb} = - [(a + b) - c];$$

but

$$a^2 + b^2 + 2ab \cos \theta = c^2;$$

$$a^2 + b^2 - c^2 = -2ab \cos \theta.$$

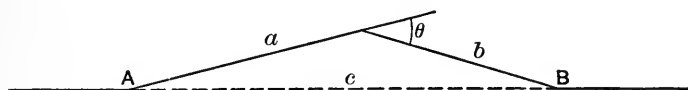

FIG. 13.

Adding $2ab$ to both members

$$a^2 + 2ab + b^2 - c^2 = 2ab - 2ab \cos \theta;$$

$$(a + b)^2 - c^2 = 2ab (1 - \cos \theta).$$

Substituting $(1 - \cos \theta) = 2 \sin^2 \frac{1}{2}\theta$,

$$[(a + b) - c] \times [(a + b) + c] = 4ab \sin^2 \frac{1}{2}\theta.$$

Hence

$$C_{bb} = - \frac{4ab \sin^2 \frac{1}{2}\theta}{(a + b) + c}.$$

If θ is very small (which is practically always the case) C_{bb} will be very small, and we may substitute

$$\sin \frac{1}{2}\theta = \frac{1}{2}\theta \sin 1' \quad \text{and} \quad (a + b) + c = 2(a + b),$$

whence

$$C_{bb} = - \frac{ab\theta^2}{a + b} \times \frac{\sin^2 1'}{2},$$

in which θ must be expressed in minutes, and C_{bb} will be in the same unit as a and b .

$$\frac{\sin^2 1'}{2} = 0.00000004231.$$

32. Correction for Vertical Alignment. When measurements are taken with wires or tapes the elevations of the different points of support will usually be different, though frequently a number of successive points may be made to fall on the same grade.

Let l_1, l_2 , etc., be the successive lengths of uniform grades;

h_1, h_2 , etc., be the differences of elevation between the successive ends of these grades;

c_1, c_2 , etc., be the numerical corrections for the single grades;

C_g = total correction for grade;

then for any one grade

$$c = l - \sqrt{l^2 - h^2},$$

$$c - l = -\sqrt{l^2 - h^2},$$

$$c^2 - 2lc + l^2 = l^2 - h^2,$$

$$c^2 - 2lc = -h^2,$$

$$2lc - c^2 = h^2,$$

$$c = \frac{h^2}{2l - c},$$

but since c is very small in comparison with l we may write with sufficient precision

$$c = \frac{h^2}{2l},$$

whence

$$C_g = -\left(\frac{h_1^2}{2l_1} + \frac{h_2^2}{2l_2} \dots + \frac{h_n^2}{2l_n}\right).$$

If the grade lengths are all equal, as, for instance, when h is taken at every tape length,

$$C_g = -\frac{1}{2l}(h_1^2 + h_2^2 \dots + h_n^2) = -\frac{\Sigma h^2}{2l}.$$

Fractional tape lengths must be reduced separately.

When base-bars are used the angles of inclination are measured, and the correction is the same for the same angle whether the angle is one of elevation or depression.

Let C_g = grade correction for one bar length;
 l = length of bar;
 θ = angle of inclination from the horizontal;

then

$$C_g = -l(1 - \cos \theta) = -2l \sin^2 \frac{1}{2}\theta.$$

If θ is less than 6° we may write without material error

$$\sin \frac{1}{2}\theta = \frac{1}{2}\theta \sin 1',$$

whence

$$C_g = -\frac{\sin^2 1'}{2}\theta^2 l,$$

or

$$C_g = -0.00000004231 \theta^2 l,$$

with the understanding that θ is to be expressed in minutes, and C_g will be in the same unit as l . The grade correction for the entire line will be the sum of the individual corrections for the several bar lengths.

33. Reduction to Mean Sea Level. In geodetic work all horizontal distances are referred to mean sea level, that is, the stations are all supposed to be projected radially (more strictly, normally) on to a mean-sea-level surface, and all distances are reckoned on this surface. All the angles of a triangulation system are measured as horizontal angles, and are not practically affected by the different elevations which the various stations may have. If the lines which are actually measured (bases and check bases) are reduced to mean sea level, all computed lines will correspond to this level without further reduction. It is necessary, therefore, to connect the ends of base lines with the nearest bench marks whose elevations are known with reference to mean sea level. (See Art. 77 for determination of mean sea level.)

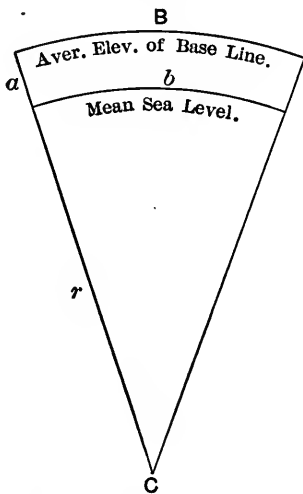

FIG. 14.

Let C_{msl} = reduction to mean sea level;
 r = mean radius of earth;
 a = average elevation of base line;
 B = length of base as measured;
 b = length of base at mean sea level;

then, from Fig. 14, page 43,

$$\frac{r+a}{B} = \frac{r}{b},$$

$$b = \frac{Br}{r+a},$$

$$C_{msl} = -(B - b) = -\left(B - \frac{Br}{r+a}\right) = -\frac{Ba}{r+a},$$

or since a is always very small as compared with r , we may write

$$C_{msl} = -\frac{Ba}{r},$$

in which a and r must be in the same unit, and in which C_{msl} will be in the same unit as B (need not be in the same unit as for a and r).

$$r \text{ (in meters)} = 6,367,465 \qquad \log. = 6.8039665.$$

$$r \text{ (in feet)} = 20,890,592 \qquad \log. = 7.3199507.$$

34. Computing Gaps in Base Lines. Sometimes an obstacle occurs which prevents the direct measurement of a portion of a straight base line, as, for instance, between B and C in Fig. 15. In such a case if two auxiliary points A and D (on the base) are taken, x can be computed if the distances a and b and the angles α , β , and θ are measured. Draw BE and CF perpendicular to AO , and CG and BH perpendicular to DO . Then

$$\frac{BE}{CF} = \frac{BA}{CA} \quad \text{or} \quad \frac{BO \sin \alpha}{CO \sin (\alpha + \beta)} = \frac{a}{x + a},$$

whence

$$\frac{BO}{CO} = \frac{a \sin (\alpha + \beta)}{(x + a) \sin \alpha} \dots \dots \dots (1)$$

Also

$$\frac{BH}{CG} = \frac{BD}{CD} \quad \text{or} \quad \frac{BO \sin (\beta + \theta)}{CO \sin \theta} = \frac{x + b}{b},$$

whence

$$\frac{BO}{CO} = \frac{(x + b) \sin \theta}{b \sin (\beta + \theta)} \dots \dots \dots (2)$$

Comparing (1) and (2)

$$\frac{a \sin (\alpha + \beta)}{(x + a) \sin \alpha} = \frac{(x + b) \sin \theta}{b \sin (\beta + \theta)}$$

or

$$(x + a) (x + b) = \frac{ab \sin (\alpha + \beta) \sin (\beta + \theta)}{\sin \alpha \sin \theta},$$

which gives

$$x = + \sqrt{\frac{ab \sin (\alpha + \beta) \sin (\beta + \theta)}{\sin \alpha \sin \theta} + \left(\frac{a - b}{2}\right)^2} - \frac{a + b}{2}.$$

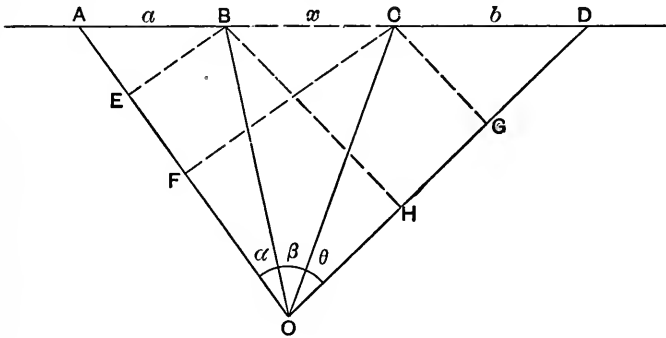

FIG. 15.

It is evident that good results can not be obtained unless the points A, D, and O are selected so as to make a well shaped figure.

35. Accuracy of Base-line Measurements. The accuracy possible in the determination of the length of a base line depends on the precision with which the various constants of the measuring apparatus have been obtained and the precision with which the field work is done. The instrumental constants can be determined with a degree of precision commensurate with the highest grade of field work. The precision attainable in the field is judged by making repeated measurements of the same base with the same apparatus and comparing the results. From the discrepancies in these measurements the probable error (Chapter XIII) of the average (arithmetic mean) of the determinations

is found and compared with the total length of the line as a measure of the precision attained. This measure of precision is called the *uncertainty*.

An exact comparison of the merits of different base-line apparatus is manifestly impossible, but under similar conditions the following results have been obtained:

Uncertainty of Mean Length of Base. Steel tapes in cloudy weather or at night, 1 in 1,000,000 or better. Invar tapes at all hours, 1 in 1,000,000 or better. Steel and brass wires at all hours, 1 in 1,000,000 or better. Ordinary base-bars, 1 in 2,000,000 or better. Duplex base-bars, 1 in 5,000,000 or better.

The probable error of a base line is obtained as follows:

$$\begin{aligned} \text{Let } r_a &= \text{probable error of mean length;} \\ M_1, M_2, \text{ etc.} &= \text{value of each determination;} \\ z &= \text{mean length of line;} \\ \left. \begin{array}{l} M_1 - z \\ M_2 - z \end{array} \right\} &\text{etc., = residuals;} \\ \Sigma v^2 &= \text{sum of squares of residuals;} \\ n &= \text{number of measurements;} \end{aligned}$$

then

$$r_a = \pm 0.6745 \sqrt{\frac{\Sigma v^2}{n(n-1)}}.$$

Example. Five measurements of a base line were made:

Observed Values.	Arithmetic Mean.	v .	v^2 .
6871.26 ft.	6871.284 ft.	- 0.024	0.000576
6871.31 "	6871.284 "	+ 0.026	0.000676
6871.27 "	6871.284 "	- 0.014	0.000196
6871.30 "	6871.284 "	+ 0.016	0.000256
6871.28 "	6871.284 "	- 0.004	0.000016
<hr/>			
5)1.42		0.000	0.001720
.284			

The algebraic sum of the residuals is zero, as it always should be. Then for r_a , the probable error of the mean length, we have

$$r_a = \pm 0.6745 \sqrt{\frac{0.001720}{5(5-1)}} = \pm 0.0093 \text{ ft.};$$

and for U_a , the uncertainty of the mean length, we have

$$U_a = \frac{0.0093}{6871.284} = \frac{1}{738848}.$$

CHAPTER III

MEASUREMENT OF ANGLES

36. General Conditions. Assuming that the stations and signals have been arranged to the best advantage, as described in Chapter I, the finest grade of instruments and favorable atmospheric conditions are required for the highest grade of work. The U. S. Coast and Geodetic Survey does satisfactory work at all hours, but it is not easy to do good work in the middle of the day. From dawn to sunrise (and within about an hour after sunrise if heliotropes are used), and from about four o'clock in the afternoon until dark, represent the hours most desirable for the highest grade of work; even the early morning period frequently proves unsatisfactory. In densely cloudy weather work may be carried on all day. If night signals are used (see Art. 19), good work can be done up till about midnight. Accurate results can not be expected if the instrument is exposed to the direct rays of the sun immediately before or during the measurement of an angle. The effect of the sun's rays is to cause *heat radiation*, producing an apparent unsteadiness of all objects seen through the telescope, due to the irregular refraction caused by the currents of air of different temperatures; an uncertain amount of sidewise refraction, even if the unsteadiness is not sufficient to prevent a good bisection of the signal; a disturbance of the adjustments of the instrument and bubbles, and an actual twisting of the instrument on a vertical axis, both caused by unequal expansion and contraction; and a twisting of the station itself on a vertical axis, if it have any particular height (the twisting being generally toward the sun's movement, and amounting to as much as a second of arc per minute on a 75-foot tower).

37. Instruments for Angular Measurements. Two types of instrument are in use for fine angle work, the *Repeating Instrument*, and the *Direction Instrument*, the latter being considered

the best in the hands of well-trained observers. If either instrument is provided with a vertical arc or circle it is called an *Altazimuth Instrument*. The term *Theodolite* is frequently applied to any large instrument of high grade, though more correctly limited to instruments in which the telescope can not be reversed without being lifted out of its supports (on account of the lowness of the standards). When an instrument has to be reversed in this manner the telescope must be turned end for end without reversing the pivots in the wyes. The illustrations are all of high grade instruments, Fig. 16 being a repeating instrument, Fig. 17 a direction instrument, and Fig. 18 an altazimuth instrument (in this case also a repeating instrument). In general, geodetic instruments are larger than surveyors' instruments, though experience has shown that horizontal circles greater than 10 or 12 inches in diameter offer no further advantage in the accuracy of the work that can be done with them. Such instruments are made of the best available material and with the greatest care, the utmost care being taken with the graduations and the making and fitting of the centers. Lifting rings are often provided to avoid strain in handling. The instruments are supported on three leveling screws (instead of four as ordinarily found on surveyors' transits), and in addition a delicate striding level is provided for direct application to the horizontal axis of the telescope. All the levels are more delicate than on a common transit, the plate levels running from about 10 to 20 seconds per division, and the striding level from 1 to 5 seconds per division. Repeating instruments are usually read by verniers, an 8-inch instrument reading to 10 seconds and a 10- or 12-inch instrument even down to 5 seconds, attached reading glasses of high power taking the place of the ordinary vernier glass. Direction instruments generally read to single seconds, as described in detail later on. The leveling screws (which support the instruments) are pointed at the lower ends and rest in V-shaped grooves, so that they are not constrained in any way. If tripods are used the grooves are usually cut in round foot plates (about $1\frac{1}{2}$ inches in diameter) properly placed on the tripod head by the maker. Extra foot plates are often provided which can be screwed to piers or station heads as desired. A *trivet* is a device often used for the same purpose, consisting of a frame containing three equally-spaced radial V-shaped grooves cut in

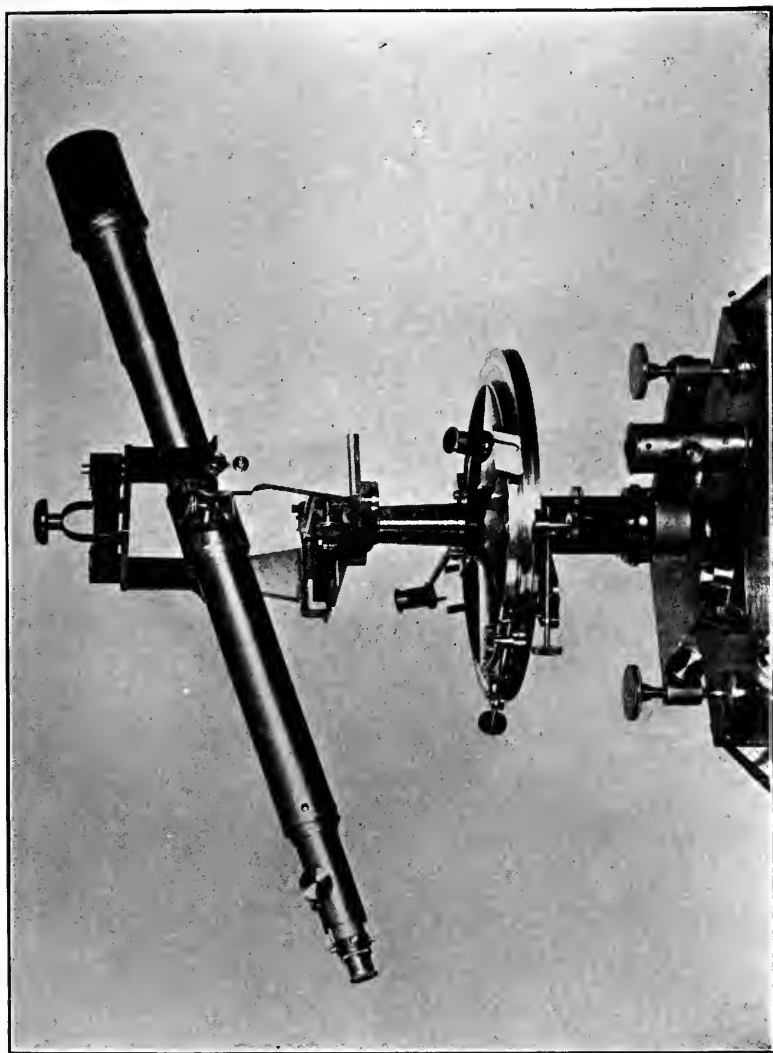

FIG. 16.—Repeating Instrument.
From a photograph loaned by the U. S. C. and G. S.

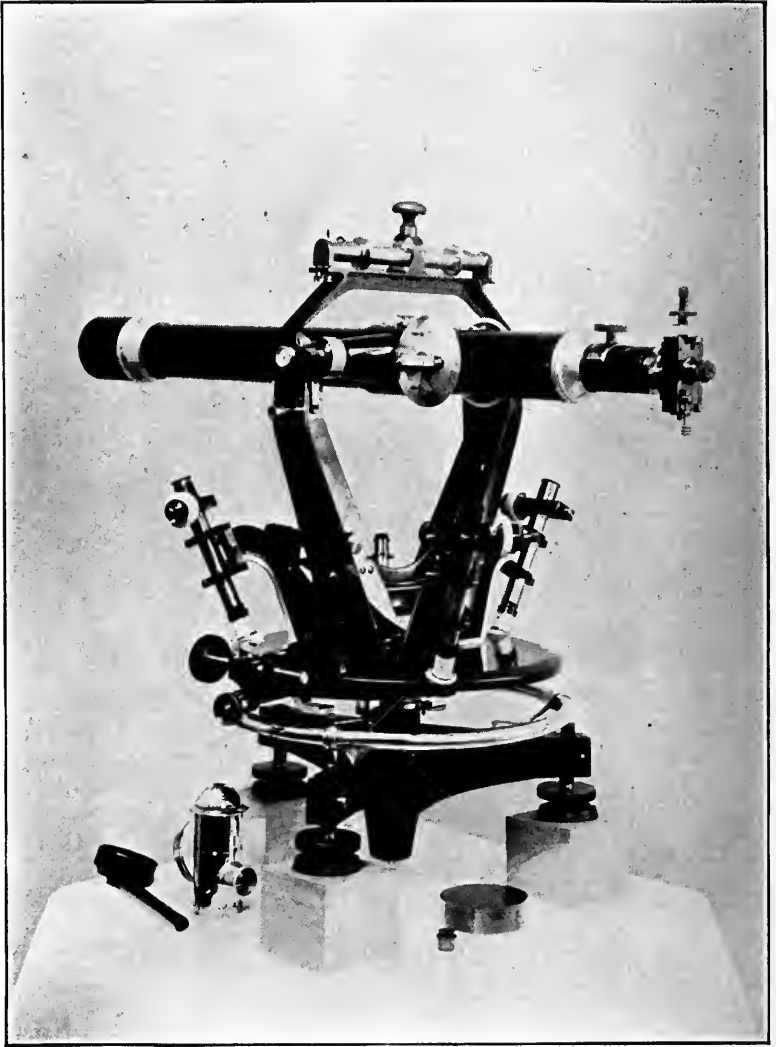

FIG. 17.—Direction Instrument.
From a photograph loaned by the U. S. C. and G. S.

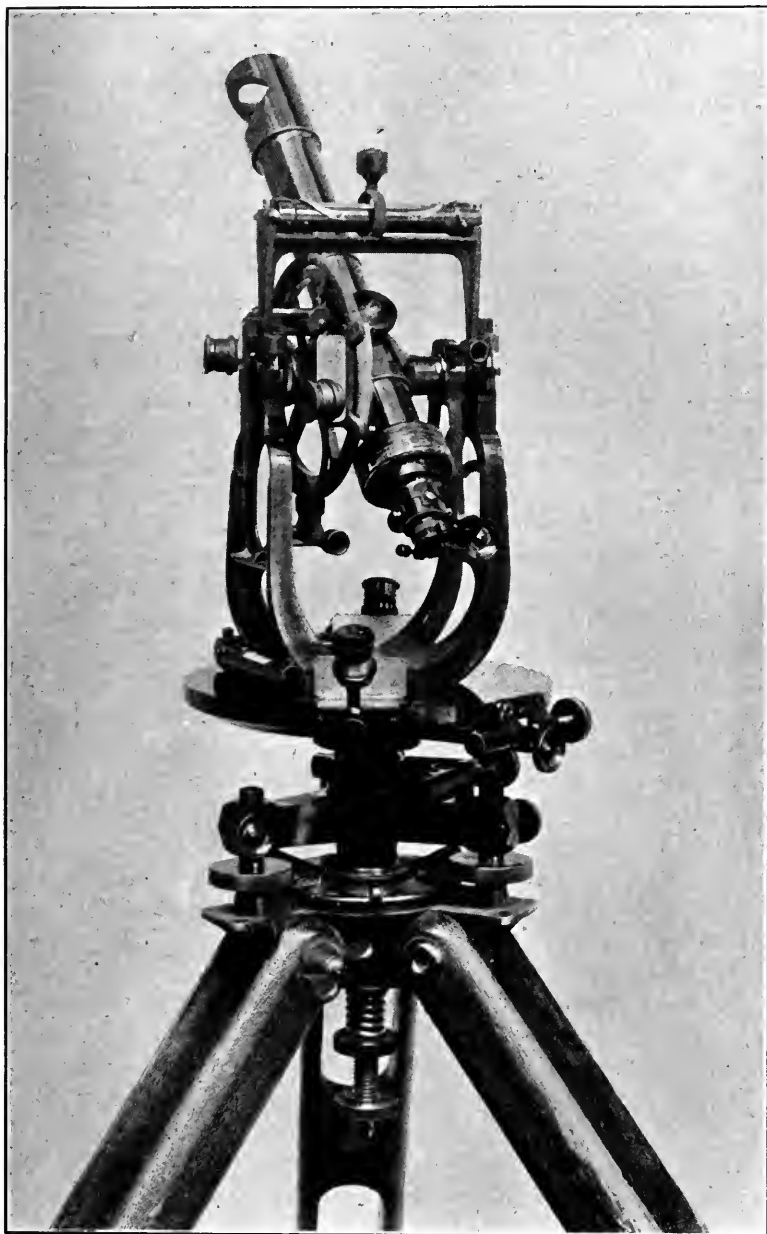

FIG. 18.—Altazimuth Instrument.
From a photograph loaned by the U. S. C. and G. S.

suitable arms. A three-screw instrument is leveled by setting a bubble parallel to a pair of leveling screws and bringing it to the center by turning that pair of screws equally in opposite directions; the crosswise bubble is then leveled by using only the single screw that is left.

38. The Repeating Instrument and its Use. Besides the features common to all first-class instruments, as described in the previous article, the repeating instrument *must* contain the special feature of a double vertical axis (as is always the case in the surveyor's transit), thus permitting angles to be measured by the method of repetition. The fundamental idea of measuring an angle by repetition is to measure the angle a number of times without resetting the plates to zero between the successive measurements, and dividing the accumulated result by the number of repetitions. It was at first thought that any desired degree of accuracy could be obtained by this method by simply increasing the number of repetitions, but it is now known that increasing the number of repetitions beyond a certain limit does not improve the result, on account of systematic errors introduced by the instrument itself, chiefly due to the clamping attachments. The method is nevertheless very meritorious, and excellent work can be done. The object of the repetition is twofold: *First*, the errors in the pointings tend to compensate each other, and the remaining error is largely reduced by the division; *Second*, the accumulated reading is theoretically correct to the least count of the vernier, and the division by the number of repetitions tends to make the reduced value as close as if the least count were just that much finer. There are two ways of measuring an angle by the method of repetition, each designed to eliminate as far as possible the various instrumental errors, but based on somewhat different arguments.

39. First Method with Repeating Instrument. The common, but not the best, method consists in repeating the angle any desired number of times, measuring from the left-hand to the right-hand station, with telescope direct, and dividing by the number of repetitions to obtain one value of the angle; then measuring the same angle in the reverse direction (right-hand to left-hand station), using the same number of repetitions, but with telescope reversed, and dividing as before to obtain a second value of the angle; the average of the two determinations is then

taken as the value of the angle (as given by that set, and of course as many sets as desired may be averaged together). The number of repetitions in each set is commonly so taken as to make each of the accumulated readings approximately equal to one or more times 360° , in order to eliminate errors of graduation. If this plan would require an unreasonable number of repetitions, a number of smaller sets may be taken from symmetrical points around the graduated limb, and the results averaged. Thus four independent sets might be taken, the starting point for vernier *A* for each set being respectively 0° , 45° , 90° , and 135° . The reversal of the telescope is designed to eliminate errors caused by imperfect adjustment of the collimation and the horizontal axis of the telescope. Measuring in opposite directions between stations is designed to eliminate errors caused by the clamping apparatus. The reading of the instrument at any time is understood to be the mean of the readings of the two verniers, as the eccentricity of the verniers and of the centers is thus eliminated. The argument advanced in favor of this method is that reversing all the processes for the second half of a set ought to reverse the signs of the various errors, so that theoretically they ought to largely vanish from the mean value. As this method is not recommended it is not given in any further detail.

40. Second Method with Repeating Instrument. In this method, considered the best, the instrument is always revolved about its vertical axis in the same direction (almost universally clockwise), no matter which clamp is loosened nor how great the angle through which it must be turned to point to the desired station. The fundamental scheme of this method is to measure (see Fig. 19) the desired angle from *A* to *B* (called the *interior angle*), and also to measure the other angle (called the *exterior angle*) from the *B* the rest of the way around to *A*, measuring this remaining angle being called *closing the horizon*. The interior angle *A* to *B* is repeated as many times as desired with the telescope direct (often called *normal*) and an equal number of times with the telescope reversed, and the accumulated reading divided by the total number of repetitions for the provisional

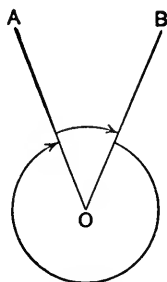

FIG. 19.

value of this angle. The exterior angle B to A is measured in exactly the same way with the same number of repetitions, etc. The values thus obtained for the interior and exterior angles are added together, and if the result is not exactly 360° the discrepancy is equally divided between the two angles. The entire operation makes one set. The argument in favor of this method is that since the exterior angle is measured in identically the same way as the interior angle it ought to be subject to exactly the same error; adding the two angles together, therefore, should double the error; and the value of this double error be made apparent by the failure of the sum to equal 360° . The assumption is evidently made that the errors which it is sought to eliminate by this method are independent of the size of the angle, and this is generally believed to be true. In practice the verniers are not reset to zero after completing the measurement of the interior angle, but become the starting point for the measurement of the exterior angle just as they stand; the instrument is thus made to automatically add the interior and exterior angles on its own graduations, and the verniers should therefore read zero (360°) at the completion of the set if no errors were involved. It is more common for the combined angles to run under than over 360° , about $10''$ per repetition not being an unusual amount. It is found by experience with this method that six repetitions (3 direct and 3 reversed) of the interior angle, and the same for the exterior angle, make a very satisfactory set; and the average of two such sets (if in close agreement) gives a very good determination of the desired angle. The plates are not reset to zero between the two sets, but left undisturbed as a starting point for the second set, so that the vernier readings become slightly different each time and the mind is free from bias. The complete program for a double set would be as follows:

PROGRAM

FIRST SET.

1. Level up, set vernier A to zero, read vernier B .
- Set telescope direct and*
2. Unclamped below, turn clockwise and set on left station.
 3. " above, " " right "
 4. Unclamp below, and read vernier A .

Leaving verniers unchanged,

- | | |
|----|----------------------------------------------------------|
| 5. | Unclamped below, turn clockwise and set on left station. |
| 6. | “ above, “ “ right “ |
| 7. | “ below, “ “ left “ |
| 8. | “ above, “ “ right “ |

Reverse telescope and

- | | |
|-----|----------------------------------------------------------|
| 9. | Unclamped below, turn clockwise and set on left station. |
| 10. | “ above, “ “ right “ |
| 11. | “ below, “ “ left “ |
| 12. | “ above, “ “ right “ |
| 13. | “ below, “ “ left “ |
| 14. | “ above, “ “ right “ |
15. Unclamp below and read both verniers.

Leaving telescope reversed and verniers unchanged,

- | | |
|-----|-----------------------------------------------------------|
| 16. | Unclamped below, turn clockwise and set on right station. |
| 17. | “ above, “ “ left “ |
| 18. | “ below, “ “ right “ |
| 19. | “ above, “ “ left “ |
| 20. | “ below, “ “ right “ |
| 21. | “ above “ “ left “ |

Set telescope direct and

- | | |
|-----|-----------------------------------------------------------|
| 22. | Unclamped below, turn clockwise and set on right station. |
| 23. | “ above, “ “ left “ |
| 24. | “ below, “ “ right “ |
| 25. | “ above, “ “ left “ |
| 26. | “ below, “ “ right “ |
| 27. | “ above, “ “ left “ |
28. Unclamp below and read both verniers.

SECOND SET.

1. Leaving verniers unchanged from previous set, relevel with lower motion unclamped.

Set telescope direct and

- | | |
|----|----------------------------------------------------------|
| 2. | Unclamped below, turn clockwise and set on left station. |
| 3. | “ above, “ “ right “ |
| | etc. etc. |

40a. Reducing the Notes. The following points are taken advantage of to save labor in reducing the notes:

First. In finding the average value of the six repetitions by dividing by six, it will be noted that the remainder from the degrees gives the first figure of the minutes, and the remainder from the minutes gives the first figure of the seconds, so it becomes unnecessary to reduce these remainders to the next lower unit, as would be required with any other number of repetitions. For example, let the accumulated reading be $250^{\circ} 57' 15''$,

$$\begin{array}{r} 6)250^{\circ} 57' 15'' \\ \underline{41 \quad 49 \quad 32.5} \end{array}$$

6 into 250 goes 41 times and 4 over, and 4 is the first figure of the minutes; 6 into 57 goes 9 times and 3 over, and 3 is the first figure of the seconds.

Second. The same numerical result can be reached without carrying out the reduction exactly as described in the explanation of the method.

Let a = mean of verniers at beginning of a set;

b = mean of verniers after six repetitions on interior angle;

c = mean of verniers after six repetitions on exterior angle;

n = number of times vernier passes initial point in the six repetitions of the interior angle;

I = interior angle as measured;

E = exterior angle as measured;

v = adjustment to be added to either angle as measured;

A = adjusted value of interior angle.

Since the interior and exterior angles together make 360° , and each has been repeated six times, the total angle turned through must be $360^{\circ} \times 6$, or what amounts to the same thing, 5 complete circuits plus the indications of the verniers and the correction for the accumulated errors; so that if n equals the number of complete circuits involved in the six repetitions of the interior angle, then $(5 - n)$ must represent the number of complete circuits involved in the six repetitions of the exterior angle. Hence

$$I = \frac{360n + b - a}{6},$$

$$E = \frac{360(5 - n) + c - b}{6},$$

$$I + E = \frac{360 \times 5 + c - a}{6},$$

$$v = \frac{1}{2} \left(360 - \frac{360 \times 5 + c - a}{6} \right) = \frac{1}{2} \left(\frac{360 - c + a}{6} \right),$$

$$A = I + v,$$

$$= \frac{360n + b - a}{6} + \frac{1}{2} \left(\frac{360 - c + a}{6} \right)$$

$$= \frac{1}{2} \left(\frac{360n + b - a}{6} + \frac{360n + (360 + b) - c}{6} \right)$$

$$= \frac{1}{2} \left[\left(60n + \frac{b - a}{6} \right) + \left(60n + \frac{(360 + b) - c}{6} \right) \right].$$

In actual work no attempt is made to observe the value of n , as its value is always evident from the approximate value of the angle as given by the first reading. The remainder of the formula involves very simple operations on the three mean vernier readings.

40b. Illustrative Example. A complete example of notes and reductions for a double set of angle measurements is here given to illustrate the above method.

Station occupied = A. Date = Aug. 28, 1911. Time = 4.30 P.M.			Angle = Sta. B to Sta. C. Observer = J. H. Smith. Instrument = Brandis No. 17.		
Telescope.	Ver. A.	Ver. B.	Mean.	Angle.	Average.
—	0° 00' 00"	180° 00' 10"	0° 00' 05"		
1. D	75 12 30				
6. D & R	91 14 50	271 14 50	91 14 50	75° 12' 27".5	
6. R & D	359 58 50	179 59 00	359 58 55	75 12 39 .2	75° 12' 33".4
6. D & R	91 13 50	271 13 50	91 13 50	75 12 29 .2	
6. R & D	359 57 50	179 57 50	359 57 50	75 12 40 .0	75 12 34 .6
			Mean angle =		75° 12' 34" 0

It will be noted that vernier *A* was set to zero to begin with, and vernier *B* read $180^{\circ} 00' 10''$. This setting to zero is, of course, not essential, but convenient, as the next reading at once gives a close value of the desired angle without computation. There is no object in reading vernier *B* for this approximate determination. The remaining readings are taken at the proper time just as the instrument reads, paying no attention to the number of times the 360° point has been passed. 1. D means one measurement of the angle with the telescope direct. 6. D & R means six repetitions, using the telescope equally both *direct* and *reversed* (hence 6. D & R means the result after 3 direct and 3 reversed measurements). It will also be noted that no resetting of verniers has taken place at any time throughout the complete double set. Vernier *B* is only read in order to average out instrumental errors (which are always very small), and therefore in filling in this column the degrees are recorded the same as given by vernier *A*, that is, the constant difference of 180° between vernier *A* and *B* is not allowed to affect the mean. In filling out the column marked *angle* the first and the final reading of each set are subtracted from the middle reading (adding 360° if necessary to make the subtraction possible), dividing the remainder by 6, and adding as many times 60° as may be needed to make the result correspond to the 1. D reading.

$91^{\circ} 14' 50''$ <hr/> 0 00 05 <hr/> 6)91 14 45 <hr/> 15 12 27.5 <hr/> 60 <hr/> 75 12 27.5	$91^{\circ} 13' 50''$ <hr/> 360 <hr/> 451 13 50 <hr/> 359 58 55 <hr/> 6)91 14 55 <hr/> 15 12 29.2 <hr/> 60 <hr/> 75 12 29.2
$91^{\circ} 14' 50''$ <hr/> 360 <hr/> 451 14 50 <hr/> 359 58 55 <hr/> 6)91 15 55 <hr/> 15 12 39.2 <hr/> 60 <hr/> 75 12 39.2	$91^{\circ} 13' 50''$ <hr/> 360 <hr/> 451 13 50 <hr/> 359 57 50 <hr/> 6)91 16 00 <hr/> 15 12 40.0 <hr/> 60 <hr/> 75 12 40.0
75 12 27.5 75 12 39.2 <hr/> 2)66.7 <hr/> 33.4	75 12 29.2 75 12 40.0 <hr/> 2)69.2 <hr/> 34.6

In actual practice the 360° and the 60° would have been added mentally as needed.

40c. Additional Instructions. If it is desired to attempt to eliminate errors of graduation, several double sets may be taken at different parts of the circle, symmetrically disposed. Modern

instruments are so well graduated, however, that it is doubtful if any increased accuracy is gained by this refinement when measuring angles by any method of repetition.

If it is desired to measure more than one angle at the same station, as for instance AOB and BOC , Fig. 20, we may take six repetitions on each of these angles and close the horizon by six repetitions on the angle from C clockwise around to A , and divide the failure to total 360° equally among the three angles; or we may measure AOB and its exterior angle without regard to station C , and then measure BOC and its exterior angle without regard to station A .

In using the above or any other methods of measuring an angle by repetition it is presumed the surveyor will use every precaution possible in the handling of the instrument. Avoid walking around the instrument, if supported on a tripod; unclamp the lower motion and revolve the instrument if it is desired to read the verniers. Do not relevel during the progress of measuring an angle except at such times as the upper motion is clamped and the lower motion free. Revolve the instrument very carefully on its vertical axis to avoid slipping the plates. Read each vernier independently, without regard to what the other one may have read.

41. Adjustments of the Repeating Instrument. For the measurement of horizontal angles the required adjustments include:

- The plate-bubble adjustment;
- The striding-level adjustment;
- The collimation adjustment;
- The horizontal-axis adjustment.

These adjustments may be made as here described, but there is usually more than one way of making the same adjustment.

The Plate-bubble Adjustment. This is made in the same manner as with a surveyor's transit. Place one bubble parallel to two of the leveling screws, and bring both bubbles to the center. Turn the instrument 180° on the vertical axis, and adjust each bubble for one-half of its movement. Level up and test again,

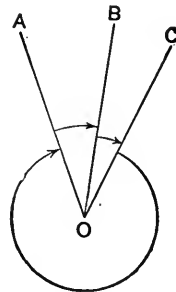

FIG. 20.

and so continue until revolution on the vertical axis causes no movement of the bubbles.

The Striding-level Adjustment. Level up the instrument by the plate bubbles (not absolutely necessary but convenient). Place striding level in position with telescope parallel to one pair of screws. Bring striding-level bubble to center with remaining screw. Lift striding level off, and replace in reversed position. Adjust it for one-half the bubble movement. Again bring bubble to middle as before with the leveling screw, test again, and repeat until reversal of the striding level causes no movement of its bubble.

The Collimation Adjustment. This is the same as with a surveyor's transit. Set up on nearly level ground, level up with the plate bubbles, and then perfect the leveling with the striding level, so that revolution on the vertical axis of the instrument causes no movement of the striding-level bubble. Unless the horizontal axis is in adjustment this stationary position of the bubble will not be in the middle. With the instrument clamped set a point about 200 feet away, plunge and set a second point about the same distance in the opposite direction, with the telescope reversed. Unclamp, revolve on vertical axis, set on first point with telescope reversed. Plunge and set a third point near the second point. Adjust by bringing the vertical hair back one quarter of the disagreement. Repeat the whole process until no discrepancy can be detected.

The Horizontal-axis Adjustment. This is the same as with the surveyor's transit. Level up perfectly with the striding level near an approximately vertical wall or equivalent. Set on a high point, with instrument clamped. Drop the telescope and mark a low point about level with the telescope. Unclamp, revolve on vertical axis, and set on high point with the telescope reversed. Drop the telescope and set a low point abreast of the first low point. Adjust the horizontal axis so that the line of sight will pass through the high point and bisect the space between the low points. If the striding level and the horizontal axis are both in adjustment and the instrument level, the striding-level bubble should stay unmoved in its middle position while the instrument is turned completely around on its vertical axis.

42. The Direction Instrument and its Use. Besides the features common to all first-class instruments, as described in

Art. 37, the direction instrument has two distinguishing features: *First*, it has only one vertical axis, so that angles can not be measured by repetition (means often provided for shifting the limb between sets of readings must not be used for angle repetition); *Second*, it is provided with two or more micrometer microscopes for reading the angles measured. The single center and clamp, instead of the two centers and clamps of the repeating instrument, undoubtedly add to the stability of the instrument and the trueness of its motion. The limb of a 10-inch or 12-inch direction instrument is commonly graduated into 5-minute spaces, and the micrometer microscopes enable an angle to be read at once to the nearest second, as described later on.

In using the direction instrument each angle is read a number of times, and the results averaged, to eliminate errors of pointing; all the microscopes are read at each pointing, to eliminate eccentricity of vertical axis or microscopes; half of the readings are taken with the telescope direct and half with it reversed, to eliminate errors of collimation and horizontal axis; half of the readings are taken to the right and half to the left, to eliminate errors due to twisting of the instrument and station. In the highest grade of work the limb of the instrument is shifted between each set of readings through an angular distance equal to the angular distance between the successive microscopes divided by the number of sets, to eliminate errors of graduation. This last refinement may be omitted in ordinary work.

43. First Method with Direction Instrument. The instrument having been set up and leveled with the telescope in its normal position is directed to the first station, and all of the micrometers read, and so on to the right (clockwise) to each station in order, the values of the different angles being obtained by taking the differences of the successive readings, as will be illustrated by an example when the method of using the micrometers is explained. When the last station to the right has been reached the instrument may be turned still further in the same direction until it reaches the initial station, called *closing the horizon*, and any difference between the initial and final readings equally divided among all the angles, but experience does not appear to show any advantage in thus closing the horizon, and it is commonly not done. When the last pointing to the right has been made, the instrument is brought back station by station

to the initial point, thus making a new series of values for the angles. The right and left pointings are again repeated, this time with the telescope reversed. The four series of values thus obtained constitute one set, and as many sets as desired may be averaged together. When for any cause a set is incomplete or inconsistent the entire set is rejected. When there are several angles to be measured at one station they are sometimes measured in various combinations as well as singly, the method of adjust-

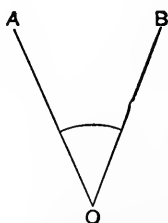

FIG. 21.

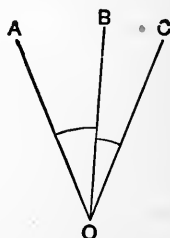

FIG. 22.

ment appearing later. The program in measuring a single angle, Fig. 21, is as follows:

PROGRAM

FIRST SET.

1. Level the instrument.

Set telescope direct and

2. Set on A and read micrometers.
3. " B " "
4. " A " "

Reverse telescope and

5. Set on A and read micrometers.
6. " B " "
7. " A " "

SECOND SET.

1. Shift limb. Relevel.

Leave telescope reversed and

2. Set on A and read micrometers.
3. " B " "
4. " A " "

Set telescope direct and

5. Set on *A* and read micrometers.
6. " *B* " "
7. " *A* " "

If there were two angles to be measured at a station, as illustrated in Fig. 22, the program would be as follows:

PROGRAM

FIRST SET.

1. Level the instrument.

Set telescope direct and

2. Set on *A* and read micrometers.
3. " *B* " "
4. " *C* " "
5. " *B* " "
6. " *A* " "

Reverse telescope and

7. Set on *A* and read micrometers.
8. " *B* " "
9. " *C* " "
10. " *B* " "
11. " *A* " "

SECOND SET.

1. Shift limb. Relevel.

Leave telescope reversed and

2. Set on *A* and read micrometers.
3. " *B* " "
4. " *C* " "
5. " *B* " "
6. " *A* " "

Set telescope direct and

7. Set on *A* and read micrometers.
8. " *B* " "
9. " *C* " "
10. " *B* " "
11. " *A* " "

and similarly for any number of angles at one station. It will be noted that in the above method the telescope is reversed in position only at the initial station.

44. Second Method with Direction Instrument. If it is not desired to make so many pointings (in order to reduce the labor and time) the telescope may be reversed at both the initial and final stations and the number of pointings be greatly reduced. The determination of the different angles, however, by this second method would not be considered as good on account of the decreased number of pointings. If a sufficient number of *sets* were taken to equalize the number of pointings the two methods would, of course, be equivalent. Referring to Fig. 21, page 62, the program for a single angle by the second method would be as follows:

PROGRAM

FIRST SET.

1. Level the instrument.

Set telescope direct and

2. Set on *A* and read micrometers.
3. " *B* " "

Reverse telescope and

4. Set on *B* and read micrometers.
5. " *A* " "

SECOND SET.

1. Shift limb. Relevel.

Leave telescope reversed and

2. Set on *A* and read micrometers.
3. " *B* " "

Set telescope direct and

4. Set on *B* and read micrometers.
5. " *A* " "

Referring to Fig. 22, page 62, the program by the second method for two angles at a station would be as follows:

PROGRAM

FIRST SET.

1. Level up instrument.

Set telescope direct and

2. Set on *A* and read micrometers.
3. " *B* " "
4. " *C* " "

Reverse telescope and

5. Set on *C* and read micrometers.
6. " *B* " "
7. " *A* " "

SECOND SET.

1. Shift limb. Relevel.

Leave telescope reversed and

2. Set on *A* and read micrometers.
3. " *B* " "
4. " *C* " "

Set telescope direct and

5. Set on *C* and read micrometers.
6. " *B* " "
7. " *A* " "

and similarly for any number of angles at a station.

45. The Micrometer Microscopes. When the direction instrument is set up and leveled at a station the graduated plate occupies a fixed position for the time being. The framework which supports the telescope carries two or more microscopes symmetrically disposed around the center of the instrument and focussed directly on the graduated ring. As the telescope is swung around from station to station the zero point of each microscope passes over the graduations an equal angular amount. If the exact position (on the graduated ring) of the zero point of any one of the microscopes is noted for two different stations, then the difference of these readings gives the angle through which the instrument has been turned, and consequently the angle between these

stations. Combined with each microscope is an instrument called a *filar micrometer*, by means of which the exact position of the zero point of the microscope on the scale may be determined.

Fig. 23 represents diagrammatically a sectional view of a filar micrometer. *A* is the micrometer box, attached to the microscope

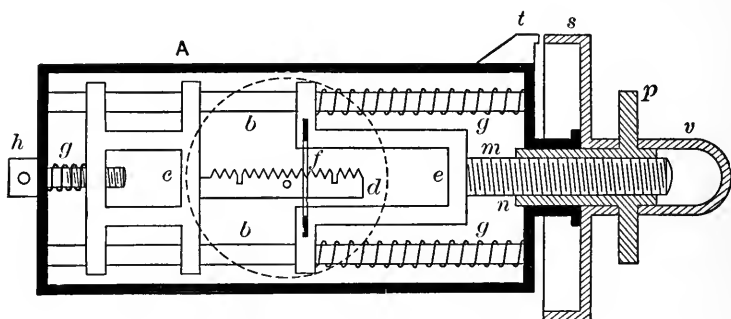

FIG. 23.—Filar Micrometer.

as seen in Fig. 17. The micrometer is made up of the following parts:

- A*, micrometer box;
- b, b*, fixed guide rods;
- c*, movable frame carrying comb scale *d*;
- d*, comb scale attached to movable frame *c*;
- e*, movable frame carrying cross-hairs *f*;
- f*, cross-hairs attached to movable frame *e*;
- g, g, g*, spiral springs to take up lost motion of movable frames *c* and *e*;
- h*, fixed screw whose revolution adjusts movable frame *c*;
- m*, micrometer screw attached to movable frame *e*;
- n*, fixed nut whose revolution moves cross-hairs across field of view;
- p*, milled head for revolving nut *n*;
- s*, graduated head for indicating fractional revolutions of nut *n*;
- t*, fixed index for reading scale on graduated head *s*;
- v*, dust cap to protect micrometer screw *m*.

The central notch of the comb scale is marked by a small hole drilled behind it (or greater depth to that notch, or other equivalent), and is intended to be practically at the center of the field

of view. Every fifth notch is indicated usually by its greater depth and square bottom. All counting is done with the *notches* and not with the points of the teeth. Each revolution of the micrometer screw moves the cross-hairs over a space equal to the distance between the bottoms of two adjacent notches. When the microscope is properly adjusted the image of the graduated ring is formed in the plane of the micrometer cross-hairs, so that both image and cross-hairs are seen sharply defined on looking into the eyepiece, the microscope ordinarily having a magnifying power of 30 to 50 diameters. The comb scale is placed as close as possible to the cross-hairs without touching them, and hence is seen at the same time and in sufficiently good focus. As ordinarily arranged the limb of the instrument is graduated into five-minute spaces, and the micrometer head into sixty spaces, and five revolutions of the micrometer screw carry the cross-hairs across the image of the limb from one five-minute division to the next five-minute division; so that one notch on the comb scale or one revolution of the micrometer screw indicates one minute of angle, and each division on the head indicates one second.

46. Reading the Micrometers. The cross-hairs *f*, Fig. 23, consist of two parallel spider threads, placed just a little further apart than the width of the graduation lines on the instrument, so that when a graduation line comes central between the hairs a narrow illuminated line appears to lie on each side of the graduation. It is found in practice that the hairs can be centered over a graduation in this way better than by any other plan (such as a single thread or intersecting threads). Everything being in good adjustment the zero point of the microscopes is the center of the space between the cross-hairs when they are opposite the central notch of the comb scale *and the zero of the head is opposite the index line*. It is important to note that the comb scale is not an essential part of a micrometer, but simply a convenience, enabling the observer to see at any moment how many complete revolutions of the micrometer screw have taken place at any time without keeping track of the matter while the screw is being turned; no attempt must be made to get the value of a reading by the comb scale beyond its intended purpose of indicating whole revolutions or single minutes, the seconds being read entirely from the micrometer head; as long as the comb scale serves its intended purpose, therefore, of counting whole revolu-

tions, it does not matter whether its position in the field of view is microscopically exact or not. Referring to Fig. 24, a greatly exaggerated view is given of what is seen through one of the microscopes for a certain pointing of the telescope. As seen in the microscope (which reverses the actual fact) the scale reads from left to right. Assuming the cross-hairs set to their index or zero point the reading is seen to be $65^{\circ} 10'$ plus the value between the 10-minute division and the center between the two hairs. Running the micrometer screw backwards until the hairs exactly center over the 10-minute division it is found

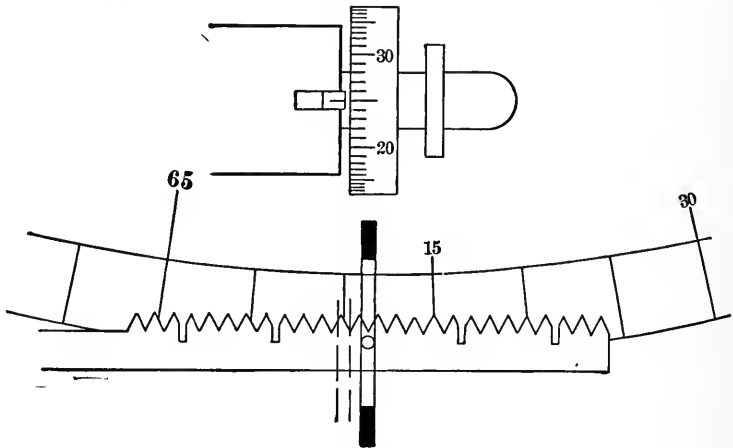

FIG. 24.

that one notch has been passed over by the hairs, but that they have not gone far enough to center over the second notch from the middle one. The screw has therefore been turned through more than one but less than two revolutions. The numbers on the micrometer head *increase as the hairs run toward the left*, and assuming the index to stand opposite 25 the complete micrometer reading is $1' 25.0''$, making the complete reading for the pointing

$$65^{\circ} 10' + 1' 25.0'' = 65^{\circ} 11' 25.0'',$$

if no corrections were required. The head reading is usually estimated to the nearest tenth of a second.

46a. Run of the Micrometer. It is not found practicable in actual work to adjust the microscopes so perfectly that the

screw will be turned through exactly five revolutions (or indicate exactly 300 seconds) in drawing the hairs from one five-minute division to the next one, but the excess or deficiency should not exceed about 2". The closer the microscope is brought to the graduated ring the larger becomes the image in the plane of the cross-hairs. It is almost impossible to get the image the exact size that corresponds to precisely five revolutions of the screw; even if this result were accomplished at one part of the graduated ring the instrument is seldom made so true that it would hold good all around the ring, either on account of slight errors in the graduations or a lack of perfect trueness of the ring itself, and many other reasons; owing to temperature changes and other reasons it will not remain true or the same at the same part of the ring. In running from one scale division to another the amount by which the micrometer measurement varies from 300 seconds is called the *run of the micrometer* between those divisions, and must be determined at the time the pointing is made. Whatever the micrometer head may read when the hairs are set over one five-minute division, it must necessarily read the same when the hairs are advanced to the next five-minute division, *provided there is no run of the micrometer*, that is, provided that the screw turns through precisely five revolutions or 300". If the two head readings are not the same the difference gives the value of the run of the micrometer between these two divisions. In drawing the hairs from left to right the head readings *decrease*, so that the micrometer overruns when the forward head reading is less than the backward head reading, and vice versa. The run of the micrometer for the 300" space, therefore, equals the backward head reading minus the forward head reading, and the micrometer measurement of the 300" space equals 300" plus the run of the micrometer for this space. Since the micrometer does not measure the five-minute (300") space correctly, it follows that a proportionate error exists for intermediate points; or for any intermediate point we have

$$\frac{\text{Correction for run}}{\text{Run of micrometer for 300'' space}}$$

$$= \frac{\text{Micrometer measurement for intermediate point}}{\text{Micrometer measurement of 300'' space}}$$

- Let n = number of full turns to back division;
 o = back head reading;
 p = forward head reading;
 b = backward reading in seconds = $60n + o$;
 f = forward reading (so called) in seconds = $60n + p$;
 $m = \frac{b + f}{2}$;
 d = run of micrometer for 300'' space = $o - p = b - f$;
 c = correction for run to value b ;
 $D = 300''$;
 A = micrometer measurement of 300'' space = $300 + d = D + d$;
 M = adjusted micrometer reading to add to scale reading = $b - c$;

then

$$\frac{c}{d} = \frac{b}{A} = \frac{b}{D + d},$$

$$c = \frac{db}{D + d},$$

$$M = b - \frac{db}{D + d};$$

substituting

$$b = \frac{b + f}{2} + \frac{b - f}{2} = m + \frac{d}{2},$$

$$M = m + \frac{d}{2} - \left(\frac{md}{D + d} + \frac{\frac{1}{2}d^2}{D + d} \right);$$

but since d is always very small in comparison with D we may write instead the extremely close approximation.

$$M = m + \frac{d}{2} - \frac{md}{D},$$

in which care must be taken to use d algebraically with its correct sign. Since the adjusted reading is based entirely on b and f it is evidently unnecessary to set the micrometer to its zero point before reading either b or f . When a pointing is made in actual work b is taken as the mean value of all the back readings of the

different microscopes, and f as the corresponding mean of the forward readings, and only one reduction is made for a pointing. The scale reading is taken for one micrometer only. The eyepiece of each microscope must be very carefully focussed by the observer, as any perceptible parallax renders good work impossible.

A complete example of notes and reduction is given on pages 72 and 73.

47. Adjustments of the Direction Instrument. For the measurement of horizontal angles the required adjustments include:

- The plate-bubble adjustment;
- The striding-level adjustment;
- The collimation adjustment;
- The horizontal-axis adjustment;
- The microscope and micrometer adjustment.

These may be made as here described, but there is usually more than one way of making the same adjustment.

The Plate-bubble Adjustment. This is made in the same manner as with a surveyor's transit. Place one bubble parallel to two of the leveling screws, and bring both bubbles to the center. Turn the instrument 180° on the vertical axis, and adjust each bubble for one-half its movement. Level up and test again, and so continue until revolution on the vertical axis causes no movement of the bubbles.

The Striding-level Adjustment. Level up the instrument by the plate bubbles (not absolutely necessary but convenient). Place striding level in position with telescope parallel to one pair of screws. Bring striding-level bubble to center with remaining screw. Lift striding level off, and replace in reversed position. Adjust it for one-half the bubble movement. Again bring bubble to middle as before with the leveling screw, test again, and repeat until reversal of striding level causes no movement of its bubble.

The Collimation Adjustment. This is the same as with a surveyor's transit. Set up on nearly level ground, level up with the plate bubbles, and then perfect the leveling with the striding level, so that revolution on the vertical axis of the instrument causes no movement of the striding-level bubble. Unless the horizontal axis is in adjustment this stationary position of the bubble will not be in the middle. With the instrument clamped,

ANGLE MEASUREMENT WITH

Station occupied = Sta. A.						
Date = May 15, 1910.						
Time = 5.00 P.M.						
Station	Instru- ment.	Microm- eter.	Scale.	<i>b</i>	<i>f</i>	<i>m</i>
B	D	A	65° 10'	85'' .0	82'' .7	
		B		83 .4	87 .6	
		Mean		84 .2	85 .2	84'' .70
C	D	A	75° 15'	126 .4	124 .0	
		B		124 .2	125 .2	
		Mean		125 .3	124 .6	124 .95
C	R	A		125 .2	123 .1	
		B		123 .0	126 .3	
		Mean		124 .1	124 .7	124 .40
B	R	A		82 .5	80 .3	
		B		81 .0	84 .6	
		Mean		81 .8	82 .5	82 .15
LIMB SHIFTED ABOUT 90°.						
B	R	A		72'' .6	69'' .4	
		B		69 .8	71 .8	
		Mean		71 .4	70 .6	71'' .00
C	R	A		112 .8	110 .0	
		B		109 .8	111 .6	
		Mean		111 .3	110 .8	111 .10
C	D	A		111 .5	110 .1	
		B		109 .1	111 .2	
		Mean		110 .3	110 .7	110 .50
B	D	A		70 .1	69 .0	
		B		68 .0	71 .2	
		Mean		69 .1	70 .1	69 .60

THE DIRECTION INSTRUMENT

Angle = Sta. B to Sta. C.
 Observer = Wm. S. Brown.
 Instrument = Brandis No. 20.

$\frac{d}{2} - \frac{md}{D}$	M	Pointing.	Angle.	Average.
- 0'' .22	84'' .48	65° 11' 24'' .48		
+ 0 .06	125 .01	75 17 05 .01	10° 05' 40'' .53	
- 0 .05	124 .35	75 17 04 .35		10° 05' 41'' .45
- 0 .16	81 .99	65 11 21 .99	10 05 42 .36	
+ 0 .21	71 .21	65 11 11 .21		
+ 0 .06	111 .16	75 16 51 .16	10 05 39 .95	
- 0 .05	110 .45	75 16 50 .45		10 05 40 .54
- 0 .27	69 .33	65 11 09 .33	10 05 41 .12	
		Mean angle =		10° 05' 41'' .00

set a point about 200 feet away, plunge and set a second point in the opposite direction with telescope reversed. Unclamp, revolve on vertical axis, set on first point with telescope reversed. Plunge and set a third point near the second point. Adjust by bringing the vertical hair back one quarter of the disagreement. Repeat the whole process until no discrepancy can be detected.

The Horizontal-axis Adjustment. This is the same as with the surveyor's transit. Level up perfectly with the striding level near an approximately vertical wall or equivalent. Set on a high point, with instrument clamped. Drop the telescope and mark a low point about level with the telescope. Unclamp, revolve on vertical axis, and set on high point with the telescope reversed. Drop the telescope and set a low point abreast of the first low point. Adjust the horizontal axis so that the line of sight will pass through the high point and bisect the space between the low points. If the striding level and the horizontal axis are both in adjustment and the instrument level, the striding-level bubble should stay unmoved in its middle position while the instrument is turned completely around on its vertical axis.

The Microscope and Micrometer Adjustment. It is necessary to have the graduated arc pass practically across the center of the field of view, and the supporting frame is generally provided with self-evident means of making this adjustment. Sometimes all but one of the microscopes may be moved circumferentially so as to space them equally around the circle, but frequently they are permanently mounted by the makers in their proper places. The microscope tube may be rotated on its own axis until the cross-hairs are exactly parallel to the graduation lines. The microscope can be adjusted so as to change the distance between the objective and the cross-hairs, and the whole microscope can be moved so as to change the distance between the objective and the graduated plate; if the micrometer overruns, the image of the graduations is too large, and must be made smaller by decreasing the distance between the objective and cross-hairs slightly, and then carefully moving the whole microscope away from the graduations until a perfect focus is again obtained exactly in the plane of the cross-hairs, as shown by the fact that properly focussing the eyepiece shows both the hairs and the graduations sharply defined and without parallax; if the micrometer underruns the image is too small, the objective

must be moved away from the cross-hairs, and the whole microscope moved toward the graduations; this adjustment should be perfected until the error does not exceed $2''$. The zero point of each microscope can be changed by shifting the comb scale and revolving the graduated head on the micrometer screw; this adjustment enables two microscopes to be set exactly 180° apart, three microscopes 120° apart, etc. Great care and skill are necessary to properly adjust the microscopes and micrometers.

48. Reduction to Center. It is sometimes impossible to set up an instrument exactly over a given station, a flag pole or steeple, for instance. In such a case an *eccentric station* is taken as near the true station as possible, and the *eccentric angle* is measured with the same precision as would have been used for the real angle. From the location of the true station with reference to the eccentric station a correction is computed which will reduce the eccentric angle to what it would have been if measured at the true station, this operation being known as *reduction to center*. The true station is generally referred to the eccentric station by an angle and a distance, a single measurement of the angle being sufficiently accurate for the purpose. Referring to Fig. 25, C is the true station, E the eccentric station, ACB the desired angle, AEB the angle actually measured, and α and r the angle and distance connecting the true station with the eccentric station. In the triangle ABC the angles at A and B are known by actual measurement, and one of the sides of the triangle must be known by measurement or by computation from its connection with the triangulation system. Having one side and two angles given we may regard all the parts of the triangle ABC as known with sufficient accuracy for the present reduction, on account of the desired correction always being very small. Opposite angles at D being equal, we have

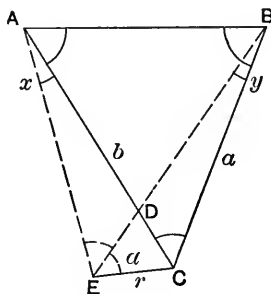

FIG. 25.

$$C + y = E + x,$$

or

$$C = E + (x - y),$$

but

$$\frac{\sin x}{\sin (E + \alpha)} = \frac{r}{b} \quad \text{and} \quad \frac{\sin y}{\sin \alpha} = \frac{r}{a};$$

hence

$$\sin x = \frac{r \sin (E + \alpha)}{b} \quad \text{and} \quad \sin y = \frac{r \sin \alpha}{a}.$$

Since x and y are very small angles, we may write

$$\sin x = x \sin 1'' \quad \text{and} \quad \sin y = y \sin 1'',$$

or

$$x = \left(\frac{r}{\sin 1''} \right) \frac{\sin (E + \alpha)}{b} \quad \text{and} \quad y = \left(\frac{r}{\sin 1''} \right) \frac{\sin \alpha}{a},$$

whence

$$C = E + \frac{r}{\sin 1''} \left[\frac{\sin (E + \alpha)}{b} - \frac{\sin \alpha}{a} \right],$$

in which the correction to be applied to E will be in seconds, and may be essentially positive or negative, since the true angle

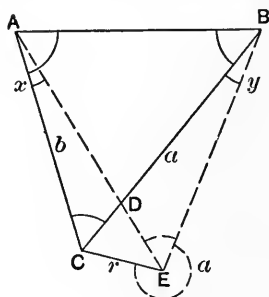

FIG. 26.

may be either larger or smaller than the eccentric angle. If care is taken to use the proper value of α , to remember that angles between 180° and 360° have negative sines, and to work out the formula for C algebraically, the correct value of C will be obtained whether it be larger or smaller than E , and without knowing what the plotted figure would look like. If measured from r the angle α must be taken counter-clockwise all the way around to

the line EB no matter how large it may come; if measured from EB it must be taken clockwise around to r ; thus in Fig. 26 the angle α is the one so marked and not the inside angle BEC .

The correction to be applied to E to obtain C depends entirely on the values of x and y , and these may be computed directly if preferred, and combined in the proper way by inspection of the figure, since the observer can scarcely be ignorant of how the different stations are related to each other and hence can quickly

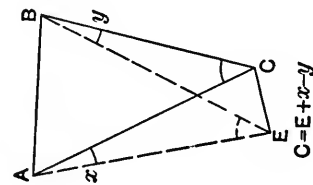
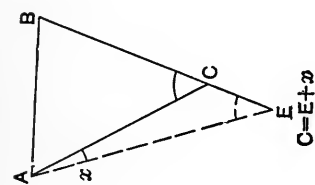
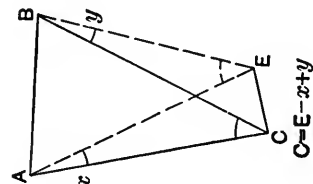
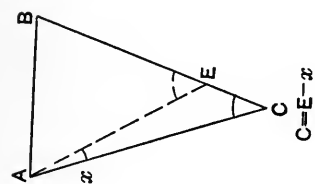
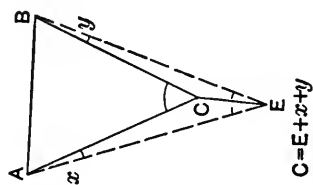
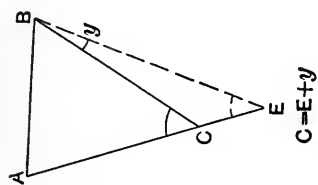
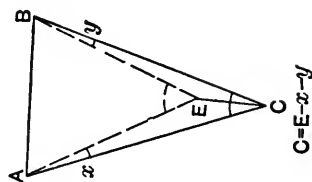
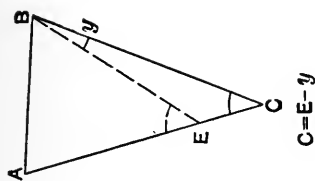

Fig. 27.—Reduction to Center.

draw a sketch of the actual conditions. All the possible cases are shown in Fig. 27, page 77, for any angle less than 180° .

49. Eccentricity of Signal. It sometimes becomes necessary in measuring an angle to sight on an eccentric signal; for instance,

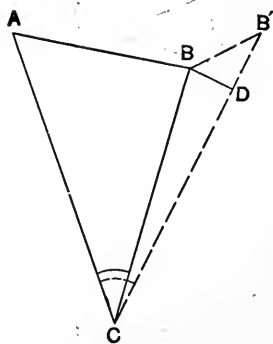

FIG. 28.

as in Fig. 28, it may be necessary to sight to B' instead of the true station B . The measured angle ACB' must therefore be corrected by the small angle BCB' to obtain the desired angle ACB . In the triangle ABC the angles at A and B are measured, and one side is always known through connection with the rest of the system, so that the side BC can be computed with sufficient closeness for the present purpose. The distance BD , perpendicular to CB' and called the eccentricity, is either directly measured or computed from a measurement of the distance $B'B$ and the angle at B' . Then

$$BCB' \text{ (in seconds)} = \frac{BD}{BC \sin 1''}$$

50. Accuracy of Angle Measurements. When the same instrument is used by a skilled observer under the same conditions results are obtained which differ but slightly from each other. In measuring an angle with an ordinary 30-second transit of good make two sets taken by the method of repetition, in accordance with the example given on page 57, should not differ by more than $5''$. A 10-inch repeating instrument used in the same way, or a 10-inch direction instrument used in accordance with the example on pages 72 and 73, should give sets differing by less than $2''$. A great many sets may be taken at the same time and agree with each other within these limits, but it does not follow that the value of the angle is obtained with this degree of precision. If the same observer measures the same angle with the same instrument under different conditions a new series of values may be obtained closely agreeing with each other, but the mean of the values belonging to the first series may differ several seconds from the mean of the second series; in fact, the two means may differ more from each other than the result of any one set differs from the

mean of its own series. Morning measurements often differ from afternoon measurements, even when the atmospheric conditions appear to be the same. In the finest work an angle is measured on many different days (sometimes with an equal number of A.M. and P.M. measurements), under as different conditions as possible, and a general average taken of all the values obtained, called the arithmetic mean.

In the Coast Survey work the probable error (Chapter XIII) of a primary angle must not exceed $0''.3$, and primary triangles must close within $3''$. In secondary work the probable error of an angle must not exceed $0''.7$, and triangles must close within $6''$. In work of less importance a greater probable error is allowable, but the triangles are expected to close within about $12''$. A sufficient number of measurements must be taken to bring about these results, but in primary work in any event at least five double sets like those given in the examples ought to be taken.

The probable error of an angle is obtained as follows:

- Let r_a = probable error of mean angle (in seconds);
- $M_1, M_2, \text{etc.}$ = value given by each set;
- z = mean value of angle;
- $M_1 - z = v_1$ } etc. = residuals (in seconds);
- $M_2 - z = v_2$ }
- Σv^2 = sum of squares of residuals;
- n = number of sets.

then

$$r_a = \pm 0.6745 \sqrt{\frac{\Sigma v^2}{n(n-1)}}$$

Example. Six measurements of an angle were taken:

Observed Values.	Arithmetic Mean.	v	v^2
7° 16' 9".2	7° 16' 9".7	- 0".5	0.25
7 16 12 .1	7 16 9 .7	+ 2 .4	5.76
7 16 8 .4	7 16 9 .7	- 1 .3	1.69
7 16 6 .7	7 16 9 .7	- 3 0	9.00
7 16 10 .3	7 16 9 .7	+ 0 6	0.36
7 16 11 .5	7 16 9 .7	+ 1 .8	3.24
6)58".2		0".0	20.30
9 .7			

The algebraic sum of the residuals is zero, as it always should be.

$$r_a = \pm 0.6745 \sqrt{\frac{20.30}{6(6-1)}} = \pm 0''.55.$$

If the several determinations of the angle are not considered equally good (on account of a difference in the number of repetitions or in the atmospheric conditions, etc.), and the values are correspondingly weighted, each value is multiplied by its weight and the sum of the products divided by the sum of the weights, giving the *weighted arithmetic mean*, the probable error of which is

$$r_{pa} = \pm 0.6745 \sqrt{\frac{\Sigma pv^2}{\Sigma p(n-1)}},$$

in which Σpv^2 equals the sum of the results obtained by multiplying each squared residual by the corresponding weight; and Σp equals the sum of the weights.

CHAPTER IV

TRIANGULATION ADJUSTMENTS AND COMPUTATIONS

51. Adjustments. After the field work of angle measurement has been completed there still remains the office adjustment of the angles necessary to satisfy the rigid geometrical conditions involved; thus all the angles around a point must add up to 360° , the three angles of a triangle must add up to 180° , etc. All such geometrical conditions must be satisfied before the lengths of the various lines of the system are computed. The adjustment of the angles at any station without regard to measurements taken at other stations (such as making the angles around a point add up to 360°), is called *station adjustment*. The mutual adjustment of the several angles of a given figure (such as making the angles of a triangle add up to 180°), is called *figure adjustment*. Easily applied rules for simple cases of adjustment can be derived by the method of least squares or the theory of weights; more complicated cases are better adjusted directly by the method of least squares, as explained in Part II of this book. The object in any case of adjustment is, of course, to find from the measured values the most probable values consistent with the geometrical conditions involved.

52. Theory of Weights. The *weight* of a quantity is defined as its *relative worth*. The term weight, therefore, is purely relative and must never be understood in an *absolute* sense. A distance of 3 feet or 3 miles is an absolute and definite distance; a weight of 3 does not represent any definite degree of precision, but is simply a comparison with that which is assigned a weight of 1. The basis of comparison is fundamentally the number of observations of unit weight from which the given value is derived; thus if 5 measurements of an angle were regarded as equally reliable, expressed mathematically by assigning to each a weight of 1, the *mean value* of the angle (by definition) would have a weight of 5. Weights are often arbitrarily assigned as a matter of judgment, however,

where the corresponding number of observations does not exist; thus a measurement obtained under unusually favorable conditions might be considered as good as the mean of two measurements taken under less favorable conditions, and hence a weight of 2 assigned to this single favorable measurement. Since, therefore, the numbers representing weight are purely relative, and do not necessarily represent a corresponding number of observations, any number, whole or fractional, may be so used; thus two quantities may be said to have the weights respectively of 1 and 2, or $\frac{1}{2}$ and 1, or 0.12 and 0.24, and their *relative worth* is the same in either case. The *mean value* as understood above is the *arithmetic mean*, and is only used when the quantities are of *equal* weight. When the different values are of *unequal* weight each value is multiplied by its weight, and the sum of the products is divided by the sum of the weights, the result obtained being called the *weighted arithmetic mean*.

53. Laws of Weights. The following principles (established by the method of least squares) govern the use of weights:

1. The weight of the arithmetic mean (with measurements of unit weight) equals the number of observations.

Example. Angle A by different measurements equals

$$\begin{array}{r}
 29^{\circ} 21' 59'' .1, \text{ weight } 1 \\
 29 \quad 22 \quad 06 \quad .4, \quad \text{“} \quad 1 \\
 29 \quad 21 \quad 58 \quad .1, \quad \text{“} \quad 1 \\
 \hline
 3)88^{\circ} 06' 03'' .6 \\
 \text{Arithmetic mean} = 29^{\circ} 22' 01'' .2, \text{ weight } 3.
 \end{array}$$

2. The weight of the weighted arithmetic mean equals the sum of the individual weights.

Example. Base line AB by different measurements equals

$$\begin{array}{r}
 4863.241 \text{ ft., weight } 2 \\
 4863.182 \text{ ft., “} \quad 1
 \end{array}$$

whence

$$\begin{array}{r}
 4863.241 \times 2 = 9726.482 \\
 4863.182 \times 1 = 4863.182 \\
 \hline
 3)14589.664 \\
 \text{Weighted arithmetic mean} = 4863.221, \text{ weight } 3.
 \end{array}$$

3. The weight of the algebraic sum of two or more numbers is equal to the reciprocal of the sum of the reciprocals of the individual weights.

Example. $\text{Angle } A = 45^\circ 14' 11'' .2, \text{ weight } 2$
 $\text{Angle } B = 11 \ 21 \ 19 \ .6, \text{ " } 3$

$A + B = 56^\circ 35' 30'' .8, \text{ weight } = \frac{1}{\frac{1}{2} + \frac{1}{3}} = \frac{6}{5}$

$A - B = 33^\circ 52' 51'' .6, \text{ weight } = \frac{1}{\frac{1}{2} + \frac{1}{3}} = \frac{6}{5}$

4. Multiplying a quantity by a factor divides its weight by the square of that factor.

Example. $\text{Angle } A = 67^\circ 10' 12'' .5, \text{ weight } 3,$
 $2A = 134^\circ 20' 25'' .0, \text{ weight } = \frac{3}{2 \times 2} = \frac{3}{4}$

5. Dividing a quantity by a factor multiplies its weight by the square of that factor.

Example. $\text{Base } AB = 2716.124 \text{ ft.}, \text{ weight } 3,$
 $\frac{AB}{2} = 1358.062 \text{ ft.}, \text{ weight } = 3 \times 4 = 12.$

6. Multiplying an equation by its own weight (or dividing it by the reciprocal of its weight), inverts its weight.

Example. $\frac{2}{3}(x + y) = 400, \text{ weight } \frac{3}{4};$ multiplying by $\frac{3}{4}$ (or dividing by $\frac{4}{3}$), we have
 $2(x + y) = 300, \text{ weight } \frac{4}{3}.$

7. Changing all the signs of an equation, or combining the equation with a constant by addition or subtraction, leaves the weight unchanged.

Example. $x + y = 11^\circ 10' 14'' .6, \text{ weight } 2.3,$
 and
 $360^\circ - (x + y) = 348^\circ 49' 45'' .4, \text{ weight } 2.3.$

54. Station Adjustment. This consists, as explained in Art. 51, of making the angles at a station geometrically consistent, such as making all the angles around a point add up to 360° . The following cases are worked out as shown:

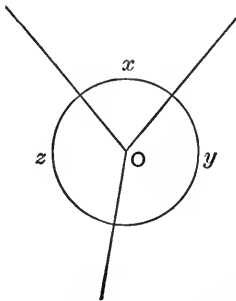

FIG. 29.

Case 1. The angles at a point have been measured with equal care (giving them equal or unit weight). In this case any discrepancy is equally distributed among the three angles. Thus in Fig. 29, if the angles x, y, z , as measured, added up to $360^\circ 00' 06''$, then each measured value would be reduced by $2''$.

As an application of the theory of weights, let us suppose we have by measurement

$$\begin{aligned} x &= a, & \text{weight } 1 \\ y &= b, & \text{“ } 1 \\ z &= c, & \text{“ } 1 \end{aligned}$$

From <i>third observation</i>	$360^\circ - z = 360^\circ - c,$	weight 1
or	$x + y = 360^\circ - c,$	“ 1
By <i>second observation</i>	$y = b,$	“ 1
By subtraction	$x = 360^\circ - b - c,$	weight $\frac{1}{2}$
By <i>first observation</i>	$x = a,$	“ 1

Taking the weighted arithmetic mean of these values of x ,

$$\begin{aligned} \frac{1}{2}x &= \frac{1}{2}(360^\circ - b - c) \\ x &= a \end{aligned}$$

By addition	$\frac{3}{2}x = a + \frac{1}{2}(360^\circ - b - c)$
whence	$x = \frac{2}{3}a + \frac{1}{3}(360^\circ - b - c)$
	$= a + \frac{1}{3}(360^\circ - a - b - c)$
	$= a + \frac{1}{3}[360^\circ - (a + b + c)],$

which indicates that the most probable value of x is found by correcting the measured value a by one-third the discrepancy; and the same result would be reached for y and z . In combining the observations as above it is to be noted that each observation can

be used but once, as otherwise additional observations would be implied that in fact have not been taken. The above rule for the distribution of the station error is, of course, the same as would be obtained by the method of least squares.

Case 2. The angles as measured around a point, Fig. 29, have been assigned different weights. In this case any discrepancy is distributed inversely as the weights. Thus if the weights are

$$\text{for } x, 1, \quad \text{for } y, 2, \quad \text{for } z, 3,$$

the distribution of error would be as

$$\frac{1}{1} : \frac{1}{2} : \frac{1}{3},$$

which is the same as

$$\frac{6}{6} : \frac{3}{6} : \frac{2}{6},$$

which is equivalent to

$$6 : 3 : 2;$$

and since $6 + 3 + 2 = 11$, we have

$$\text{correction for } x = \frac{6}{11} \text{ of discrepancy;}$$

$$\text{correction for } y = \frac{3}{11} \text{ of discrepancy;}$$

$$\text{correction for } z = \frac{2}{11} \text{ of discrepancy.}$$

Case 3. Several angles at a point, and also their sum, have been measured with equal care. In this case any discrepancy is to be equally distributed among all the measured values (including the measured sum). When the measured sum of several angles is greater than the sum of the individual measurements, the correction is positive for the single measurements and negative for the measured sum, and vice versa. Thus in Fig. 30, if the entire angle measured $8''$ more than the sum of the single measurements, then the $x, y,$

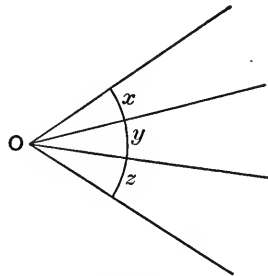

FIG. 30.

and z measurements would each be increased by $2''$, and the measured sum would be reduced by $2''$.

Case 4. Several angles at a point, and also their sum, have been measured, and different weights have been assigned to the measured values. In this case any discrepancy is distributed among all the measured values inversely as their weights. Thus in Fig. 30, page 85, suppose

	x	measured with weight	2;
	y	“	“ 1;
	z	“	“ 3;
	$(x + y + z)$	“	“ 1,

the division of error would be as

$$\frac{1}{2} : \frac{1}{1} : \frac{1}{3} : \frac{1}{1},$$

which is the same as

$$\frac{3}{6} : \frac{6}{6} : \frac{2}{6} : \frac{6}{6},$$

which equals

$$3 : 6 : 2 : 6;$$

and since $3 + 6 + 2 + 6 = 17$, we have

correction for	$x = \frac{3}{17}$	of discrepancy;
“ “	$y = \frac{6}{17}$	“ “
“ “	$z = \frac{2}{17}$	“ “
“ “	$(x + y + z) = \frac{6}{17}$	“ “

If the measured values of x , y , and z add up to less than the measured sum $(x + y + z)$, then the corrections for x , y , and z , are to be added, and the correction for $(x + y + z)$ subtracted, and vice versa.

General Rule. Any case of station adjustment in which the coefficients in the equations are all unity and the signs are all

positive (as is usually the case), and in which the horizon has not been closed or the closing has been evaded in the equations by subtracting one or more angles from 360° , and in which the weights of the final results are not desired, may be solved as follows: Multiply each equation by its own weight; add together separately all the new equations containing x , y , z , etc., as shown in the following example, and solve the resulting equations as simultaneous.

Example. Observed values, Fig. 31,

$x = 14^\circ 11' 17''.1$	weight 1
$y = 19\ 07\ 21\ .3$,	“ 2
$x + y = 33\ 18\ 43\ .4$,	“ 1
$z = 326\ 41\ 18\ .2$,	“ 2
$y + z = 345\ 48\ 39\ .2$,	“ 3

Subtracting the angles involving z from 360° .

$x = 14^\circ 11' 17''.1$	weight 1
$y = 19\ 07\ 21\ .3$,	“ 2
$x + y = 33\ 18\ 43\ .4$,	“ 1
$360^\circ - z = x + y = 33\ 18\ 41\ .8$,	“ 2
$360^\circ - (y + z) = x = 14\ 11\ 20\ .8$.	“ 3

Multiplying each equation by its weight,

x	$= 14^\circ 11' 17''.1$
$+ 2y$	$= 38\ 14\ 42\ .6$
$x + y$	$= 33\ 18\ 43\ .4$
$2x + 2y$	$= 66\ 37\ 23\ .6$
$3x$	$= 42\ 34\ 02\ .4$

Combining separately all equations containing x , and all equations containing y , we have

$$\begin{aligned} 7x + 3y &= 156^\circ 41' 26''.5 \\ 3x + 5y &= 138\ 10\ 49\ .6 \end{aligned}$$

which, solved as simultaneous equations, give

$$\begin{aligned} x &= 14^\circ 11' 20''.14 \\ y &= 19\ 07\ 21\ .83 \end{aligned}$$

the sum of which subtracted from 360° gives

$$z = 326^\circ 41' 18''.03.$$

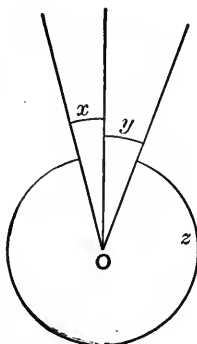

FIG. 31.

55. Figure Adjustment. Having found by measurement and station adjustment the best attainable values of the different angles of a system, the next step is to make the figure adjustment. (If the work is very important and the angles so involved that

making the figure adjustment would disturb the station adjustment, all the adjustments would have to be made in one operation by the method of least squares.) The figure adjustment, as explained in Art. 51, consists in making such slight changes in the various measured angles as will make the figure geometrically consistent, such as making the angles of a triangle add up to 180° , the angles of a quadrilateral add up to 360° , etc. The adjustment required in any case could be made in an infinite number of ways, but the adjustment that is sought is the one that assigns the *most probable* values to the various angles in view of their *actually measured* values. Since all the angles measured are spherical angles, it is necessary to compute the *spherical excess* in work of any magnitude before it can be determined to what extent the measured values are geometrically inconsistent.

If all the triangulation stations (referred to mean sea level) were connected by chords instead of arcs, we would have a network of plane triangles perfectly locating all the stations, and through which the computations could be carried with perfect accuracy, provided the plane angles were known and used. These plane angles become as well known as the actually measured spherical angles by a proper reduction for spherical excess. On account of the simplicity and saving of labor the computations in practice are always made on the basis of plane triangles. In carrying forward the azimuths of the various lines, however, the reduction for spherical excess must be restored to the adjusted plane angles, and a further allowance made for *convergence of meridians*, as explained in Chapter V.

56. Spherical Excess. The sum of the angles of a spherical triangle is always greater than 180° by an amount directly proportional to the area of the triangle and inversely proportional to the surface of the sphere, the value of the increase being called the *spherical excess*. It follows that the rule must also hold good for any spherical polygon, since such a figure can always be divided up into spherical triangles. Owing to the shape of the earth, which is not a perfect sphere, the spherical excess for the same area decreases slightly as we advance from the equator toward the poles; except for very large areas it may be taken as $1''$ for every 76 square miles, the true value for this area being $1''.0035 +$ in latitude 18° and $0''.9925 +$ in latitude 72° . It may ordinarily be disregarded entirely where the area is less than 10

square miles. The precise formula for any triangle may be written,

$$\epsilon = \frac{\text{area} \times (1 - e^2 \sin^2 \phi)^2}{C},$$

in which

ϵ = spherical excess in seconds of arc;

ϕ = latitude at center of triangle;

$\log e^2 = 7.8305026 - 10$;

$$\log C = \begin{cases} 1.8787228 & \text{(for area in square miles)} \\ 9.3239906 & \text{(" square feet)} \\ 8.2920224 & \text{(" square meters).} \end{cases}$$

For logarithms of $(1 - e^2 \sin^2 \phi)$ see Table IX.

It is evident that neither the area nor the latitude need be known with extreme precision for the present purpose, and may be estimated before any adjustments have been made.

57. Triangle Adjustment. The failure of the measured values of the angles of a triangle to add up to 180° is due to the spherical excess and the errors of measurement. If the spherical excess be computed, as explained in the previous article, the balance of the discrepancy represents the errors of measurement; or in other words, $180^\circ + \text{spherical excess} - \text{sum of angles} = \text{errors of measurement}$. The recognized adjustment for spherical excess is a deduction of one-third of the total excess from each angle, which is not mathematically correct unless the angles are all equal, but which may be so considered in any case that arises in practice; the reason for this is found in the fact that the excess is always a small quantity (rarely reaching $60''$), and also that the triangles are always well shaped in this class of work. The theoretical adjustment for errors of measurement is to divide the amount among the three angles inversely as their weights; if the angles are of equal weight this results in correcting each angle by one-third of the error. In view of the above considerations the failure of the angles of a triangle, as measured, to add up to 180° is adjusted as follows:

1. If all the angles as measured are considered equally reliable (of equal weight) the discrepancy is divided equally among the three angles. The spherical excess need not be computed in this case, unless it is desired for other purposes.

2. In important work where the angle measurements have different weights, each angle is first reduced by one-third of the spherical excess, and then corrected for the errors of measurement inversely as its weight.

3. In small triangles or work of minor importance, where the angle measurements are of unequal weight, the total discrepancy is divided among the angles inversely as their weights.

58. The Geodetic Quadrilateral. A geodetic quadrilateral is formed when the four stations, A , B , C , D , are connected as shown in Fig. 32. The size of the largest quadrilateral occurring

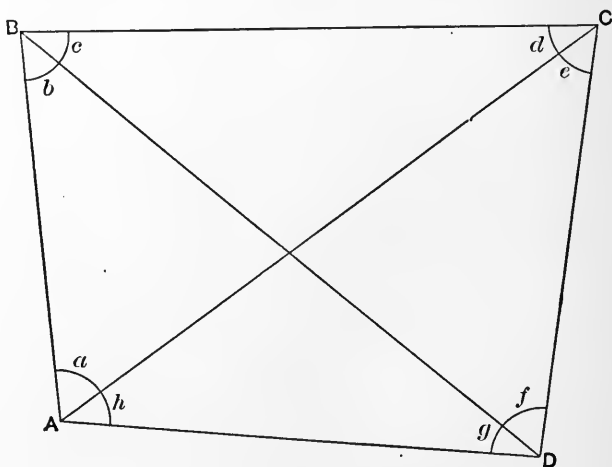

FIG. 32.—The Geodetic Quadrilateral.

in practice is relatively so small as compared with the size of the earth that we may always assume without material error that the four stations lie in a plane. In such a quadrilateral one side, as AD , must be known, either by direct measurement or connection with the system; and the eight angles a , b , c , d , e , f , g , h , must be measured. If the quadrilateral is of sufficient size to require it the measured angles must be reduced for the spherical excess; in minor work this may be distributed equally among the eight angles; in more important work each of the four triangles formed by the intersection of the diagonals would be treated separately—that is, each angle would be reduced by one-third of the excess appropriate to its own triangle. In the *plane* quadrilateral $ABCD$ there are seven angle conditions and three side

conditions that must be satisfied to make such a figure geometrically possible, and these ten conditions can all be covered by three angle equations and one side equation.

The seven angle conditions are as follows:

1. The sum of the eight corner angles must be exactly 360° . This furnishes one angle condition.

2. The opposite angles where the diagonals cross must be equal. This furnishes two angle conditions.

3. In each of the four triangles formed among the stations, such as ABC , the sum of the three angles must be exactly 180° . This furnishes four angle conditions.

These seven conditions are so involved, however, that if any three independent ones are satisfied the other four are also satisfied. As the first three conditions are independent all the angle conditions will be satisfied if we have

$$\begin{aligned} a + b + c + d + e + f + g + h &= 360^\circ; \\ a + b &= e + f; \\ c + d &= g + h. \end{aligned}$$

The three side conditions arise from the fact that each unknown side is contained in two different triangles, so that each side may be found by two independent computations which must give identical results; thus the unknown side BC may be computed from the known side AD through the triangles ACD and BCD , or through the triangles ABD and ABC , and the two values thus obtained must be the same. These three conditions are not independent, however, for if any one of them is satisfied the other two are also satisfied. It is well to note that all the seven angle conditions may be satisfied without satisfying any of the side conditions. From the figure we have

$$BC = AB \frac{\sin a}{\sin d} = AD \frac{\sin g}{\sin b} \frac{\sin a}{\sin d},$$

also

$$BC = CD \frac{\sin f}{\sin c} = AD \frac{\sin h}{\sin e} \frac{\sin f}{\sin c},$$

whence

$$\frac{BC}{AD} = \frac{\sin a \sin g}{\sin b \sin d} = \frac{\sin f \sin h}{\sin c \sin e},$$

or

$$\frac{\sin a \sin c \sin e \sin g}{\sin b \sin d \sin f \sin h} = 1.$$

which is called the *side equation*. When this equation is true the side conditions will all be satisfied. Writing the side equation in logarithmic form, which is the most convenient form for use, we have

$$\begin{aligned} &(\log \sin a + \log \sin c + \log \sin e + \log \sin g) \\ &\quad - (\log \sin b + \log \sin d + \log \sin f + \log \sin h) = 0. \end{aligned}$$

59. Approximate Adjustment of a Quadrilateral. Assuming the angles to have been measured with equal care (and reduced for spherical excess, if necessary), a quadrilateral of moderate size or minor importance can be adjusted with sufficient approximation and with comparatively little labor by the method here given.

Referring to Art. 58, the equations of condition which must be satisfied are as follows:

Angle equations,

$$\begin{aligned} a + b + c + d + e + f + g + h &= 360^\circ; \\ a + b &= e + f; \\ c + d &= g + h. \end{aligned}$$

Side equation,

$$\begin{aligned} &(\log \sin a + \log \sin c + \log \sin e + \log \sin g) \\ &\quad - (\log \sin b + \log \sin d + \log \sin f + \log \sin h) = 0. \end{aligned}$$

The adjustments for the three angle equations are made first; since these three equations are independent the adjustments required to satisfy them may be made in any order, and will not disturb each other. Since the angles are supposed to be equally well determined the adjustments made to satisfy any one of the angle equations ought to have the same value for each angle affected. Therefore, if the eight angles fail to add up to 360° , each angle is corrected by one-eighth of the discrepancy; thus if the sum of the eight angles were $360^\circ 00' 08''$, each angle would be reduced $1''$. If $a + b$ fails to equal $e + f$ each angle is corrected by one-fourth the discrepancy, reducing the larger side of the equation and increasing the smaller one; thus if $a + b$ exceed $e + f$ by $8''$, a and b must each be reduced by $2''$ and e

and f must each be increased by $2''$. Similarly, if $c + d$ fails to equal $g + h$, then each of these angles must be corrected for one-quarter of this discrepancy.

The adjustment for the side equation is then made as follows:

Let $A, B, \text{etc.}$, represent the measured angles as thus far adjusted;

l , represent the value of the first member of the side equation when $A, B, \text{etc.}$, are substituted for $a, b, \text{etc.}$;

l' , represent the numerical value of l ;

$v_a, v_b, \text{etc.}$, represent the numerical change in seconds required in $A, B, \text{etc.}$, in order to satisfy the side equation;

$d_a, d_b, \text{etc.}$, represent the tabular differences for $1''$ for $\log \sin A, \log \sin B, \text{etc.}$ Then

$$(\log \sin A + \log \sin C + \log \sin E + \log \sin G) - (\log \sin B + \log \sin D + \log \sin F + \log \sin H) = l.$$

Since the adjustment of the angles must reduce l to zero (with a minimum change in each angle), it is seen from this equation that when l is positive the first four terms must be reduced and the last four increased, and vice versa when l is negative. This is equivalent to saying that if l is *positive*, the angles A, C, E , and G must be reduced if less than 90° , and increased if greater than 90° , and the angles B, D, F , and H increased if less than 90° , and decreased if greater than 90° ; and that if l is *negative*, the angles A, C, E , and G must be increased if less than 90° , and decreased if greater than 90° , and the angles B, D, F , and H decreased if less than 90° , and increased if greater than 90° . It therefore only remains necessary to find the numerical values of the corrections. In either case, in order that l may vanish, the *numerical* sum of the logarithmic changes must equal the *numerical* value of l . Since changing the angle A by v_a changes $\log \sin A$ by $v_a d_a$, etc., we have

$$v_a d_a + v_c d_c + v_e d_e + v_g d_g + v_b d_b + v_d d_d + v_f d_f + v_h d_h = l',$$

in which all the terms are to be made positive. Since this equation contains eight unknown quantities, $v_a, v_c, \text{etc.}$, it can not be solved unless some additional relationship among the unknowns is assumed. This relationship is found in the fact that the values

v_a , v_c , etc., are to be the most probable ones; and it is generally admitted that the most probable values are those that are proportional to their influence in building up the quantity l' . Thus if d_a is twice d_c , then, second by second, v_a is twice as effective as v_c in building up the total, l' ; and this effectiveness should be recognized by allotting twice as many seconds to v_a as are allotted to v_c , and so on. We thus have

$$v_a : v_c : v_e, \text{ etc.} = d_a : d_c : d_e, \text{ etc.}$$

But if
$$\frac{v_a}{v_c} = \frac{d_a}{d_c}, \quad \frac{v_c}{v_e} = \frac{d_c}{d_e}, \quad \text{etc.,}$$

then
$$\frac{v_a d_a}{v_c d_c} = \frac{d_a^2}{d_c^2}, \quad \frac{v_c d_c}{v_e d_e} = \frac{d_c^2}{d_e^2}, \quad \text{etc.,}$$

or
$$v_a d_a : v_c d_c : v_e d_e, \text{ etc.} = d_a^2 : d_c^2 : d_e^2, \text{ etc.}$$

Referring to the equation to be solved, therefore; we see that l' is to be divided into 8 pieces which shall be in the ratio of the numbers d_a^2 , d_c^2 , d_e^2 , etc., giving for the successive terms of the equation the values

$$\frac{d_a^2 l'}{\Sigma d^2}, \quad \frac{d_c^2 l'}{\Sigma d^2}, \quad \frac{d_e^2 l'}{\Sigma d^2}, \quad \text{etc.}$$

Hence

$$v_a d_a = \frac{d_a^2 l'}{\Sigma d^2}, \quad v_c d_c = \frac{d_c^2 l'}{\Sigma d^2}, \quad \text{etc.,}$$

and we have the numerical values

$$v_a = d_a \left(\frac{l'}{\Sigma d^2} \right), \quad v_c = d_c \left(\frac{l'}{\Sigma d^2} \right), \quad \text{etc.,}$$

the signs of these corrections having been determined as previously explained.

The side-equation adjustment (having been derived without regard to the angle-equation requirements) will probably disturb the angle-equation adjustment slightly, but seldom seriously. If necessary, the two adjustments may be repeated in turn until both are satisfied with sufficient approximation.

QUADRILATERAL ADJUSTMENT BY APPROXIMATE METHOD

Measured Angles.	Angle-equation Adjustment.				Log sin A, B, etc.	d	d ²	Side-equation Adjustment.	Adjusted Angles.	Check log sines.
	for 360°.	for O.p. Angles.	Adjusted Values.							
a	46 18 38.3	+0.85	46 18 40.10	A	9.8591992	20.1	404.01	-1.95	46 18 38.15	9.8591953
b	53 26 08.2	+0.85	53 26 10.00	B	9.9048200	15.6	243.36	+1.51	53 26 11.51	9.9048224
c	42 11 29.6	+0.85	42 11 29.90	C	9.8271188	23.2	538.24	-2.25	42 11 27.65	9.8271135
d	38 03 39.7	+0.85	38 03 40.00	D	9.7899342	26.9	723.61	+2.61	38 03 42.61	9.7899412
e	58 19 12.3	+0.85	58 19 12.20	E	9.9299270	13.0	169.00	-1.26	58 19 10.94	9.9299253
f	41 25 38.0	+0.85	41 25 37.90	F	9.8206400	23.8	566.44	+2.31	41 25 40.21	9.8206455
g	34 33 48.7	+0.85	34 33 50.10	G	9.7538321	30.6	936.36	-2.97	34 33 47.13	9.7538230
h	45 41 18.4	+0.85	45 41 19.80	H	9.8546440	29.6	424.36	+2.00	45 41 21.80	9.8546481
	359 59 53.2	360 00 00.00	l = +389	Σd ² = 4005.38	360 00 00.00	l = -1

816.8
 0.85
 $a+b=99^{\circ} 44' 46''.5$
 $e+f=89 44 50 .3$
 $c+d=80^{\circ} 15' 09''.3$
 $g+h=80 15 07 .1$

9.8591992
 9.8271188
 9.9299270
 9.7538321
39.3700771
 39.3700382
l = +389

9.9048200
 9.7899342
 9.8206400
 9.8546440
39.3700382
 Σd² = 4005.38

389
4005.38
 20.1 × 0.097 = 1.95
 15.6 × 0.097 = 1.51
 23.2 × 0.097 = 2.25
 etc.

A complete example of adjustment by this method is worked out in the table on page 95. In this particular case the side-equation adjustment has disturbed the angle-equation adjustment to a maximum extent of $1''.49$. If this approximation is not as close as desired the adjusted values may be treated like original values, and be readjusted by the same method. A second adjustment gives the following values:

$a = 46^\circ 18' 38''.47$	$\log \sin = 9.8591959$	
$b = 53 \quad 26 \quad 11 \quad .92$	$\log \sin =$	9.9048230
$\quad \quad \quad \underline{99 \quad 44 \quad 50 \quad .39}$		
$c = 42 \quad 11 \quad 27 \quad .26$	$\log \sin = 9.8271126$	
$d = 38 \quad 03 \quad 42 \quad .35$	$\log \sin =$	9.7899405
$\quad \quad \quad \underline{80 \quad 15 \quad 09 \quad .61}$		
$e = 58 \quad 19 \quad 10 \quad .54$	$\log \sin = 9.9299248$	
$f = 41 \quad 25 \quad 39 \quad .90$	$\log \sin =$	9.8206448
$\quad \quad \quad \underline{99 \quad 44 \quad 50 \quad .44}$		
$g = 34 \quad 33 \quad 47 \quad .38$	$\log \sin = 9.7538238$	
$h = 45 \quad 41 \quad 22 \quad .18$	$\log \sin =$	9.8546489
$\quad \quad \quad \underline{80 \quad 15 \quad 09 \quad .56}$		
$\quad \quad \quad \underline{360 \quad 00 \quad 00 \quad .00}$	39.3700571	<hr style="width: 100%;"/> 39.3700572

An examination of these values shows an almost perfect adjustment. It is interesting to compare the results of both the first and the second adjustment with the results of the rigorous adjustment of the same example as given in Art. 60.

60. Rigorous Adjustment of a Quadrilateral. Assuming the angles to have been measured with equal care (and reduced for spherical excess, if necessary), and that the work is of too much importance for only approximate adjustment (or that a little extra labor on the computations is not objectionable), the following method may be used, the results being the same as would be obtained by the method of least squares.

Referring to Art. 58, the equations of condition to be satisfied are as follows:

Angle equations,

$$a + b + c + d + e + f + g + h = 360^\circ;$$

$$a + b = e + f;$$

$$c + d = g + h.$$

Side equation,

$$(\log \sin a + \log \sin c + \log \sin e + \log \sin g)$$

$$- (\log \sin b + \log \sin d + \log \sin f + \log \sin h) = 0.$$

As in the case of the approximate method, a provisional adjustment is first made that will satisfy the angle equations, being made in the same way as there explained because it recognizes as far as possible the fact that all the angles have been measured with equal care. This adjustment is made as follows:

If $a + b + c +$, etc., fails to equal 360° , correct each angle by $\frac{1}{3}$ of the discrepancy.

If $a + b$ fails to equal $e + f$, increase each member of the smaller sum and decrease each member of the larger sum by $\frac{1}{4}$ of the discrepancy.

If $c + d$ fails to equal $g + h$, increase each member of the smaller sum and decrease each member of the larger sum by $\frac{1}{4}$ of the discrepancy.

The side-equation adjustment is then made, but made in such a way as will not disturb the angle-equation adjustments.

Let A, B , etc., represent the angles as thus far adjusted;

l , represent the value of the first member of the side equation when A, B , etc., are substituted for a, b , etc.;

v_a, v_b , etc., represent the total corrections in seconds to A, B , etc., to satisfy the side equation;

x, x_1, x_2, x_3, x_4 , represent the partial corrections of which v_a, v_b , etc., are composed;

d_a, d_b , etc., represent the tabular differences for $1''$ for $\log \sin A, \log \sin B$, etc., taken as *positive* for angles less than 90° and *negative* for angles greater than 90° ;

then

$$(\log \sin A + \log \sin C + \log \sin E + \log \sin G)$$

$$- (\log \sin B + \log \sin D + \log \sin F + \log \sin H) = l;$$

and in order that the logarithmic corrections shall cause l to vanish we must have

$$(v_a d_a + v_c d_c + v_e d_e + v_g d_g) - (v_b d_b + v_d d_d + v_f d_f + v_h d_h) = -l,$$

in which such values must be assigned to v_a, v_b , etc., as will not disturb the angle-equation adjustments already made. These adjustments have given us

$$(A + B) + (C + D) + (E + F) + (G + H) = 360^\circ;$$

$$(A + B) = (E + F);$$

$$(C + D) = (G + H).$$

It is evident from these three equations of condition that there are only two possible ways in which the adjusted angles A, B , etc., can be modified without disturbing the angle-equation adjustments. *First*, any correction can be made to the sum of A and B , provided the same correction is made to the sum of E and F , and at the same time an equal and opposite correction is made to each of the other two sums; since the two angles of any sum are equally reliable the same numerical change must be made to each angle and will be denoted by x . *Second*, any group, such as $(A + B)$, may have any correction applied to one of its members, provided an equal and opposite correction is made to its other member; these corrections are independent of the first correction and of each other, and will be represented by x_1, x_2, x_3 , and x_4 . In accordance with the above considerations the side-equation adjustments must have the following relative values:

$$v_a = +x + x_1$$

$$v_e = +x + x_3$$

$$v_b = +x - x_1$$

$$v_f = +x - x_3$$

$$v_c = -x + x_2$$

$$v_g = -x + x_4$$

$$v_d = -x - x_2$$

$$v_h = -x - x_4$$

Substituting these values in our conditional side equation

$$(v_a d_a + v_c d_c + v_e d_e + v_g d_g) - (v_b d_b + v_d d_d + v_f d_f + v_h d_h) = -l,$$

and rearranging the terms, we have

$$\begin{aligned} [(d_a + d_d + d_e + d_h) - (d_b + d_c + d_f + d_g)]x + (d_a + d_b)x_1 \\ + (d_c + d_d)x_2 + (d_e + d_f)x_3 + (d_g + d_h)x_4 = -l, \end{aligned}$$

which for convenience we write

$$Cx + C_1x_1 + C_2x_2 + C_3x_3 + C_4x_4 = -l.$$

Since this equation contains five unknown quantities it can not be solved unless some additional relationship among the unknowns is assumed. The most probable relationship is therefore taken, namely, that the unknowns are proportional to their average effectiveness per angle in building up the quantity $(-l)$. Hence, since x affects 8 angles and the other unknowns only 2 each, we write

$$x : x_1 : x_2 : x_3 : x_4 = \frac{C}{8} : \frac{C_1}{2} : \frac{C_2}{2} : \frac{C_3}{2} : \frac{C_4}{2} = \frac{C}{4} : C_1 : C_2 : C_3 : C_4.$$

But if

$$\frac{x}{x_1} = \frac{\frac{C}{4}}{C_1}, \quad \frac{x_1}{x_2} = \frac{C_1}{C_2}, \quad \frac{x_2}{x_3} = \frac{C_2}{C_3}, \quad \text{etc.},$$

then

$$\frac{Cx}{C_1x_1} = \frac{\frac{C^2}{4}}{C_1^2}, \quad \frac{C_1x_1}{C_2x_2} = \frac{C_1^2}{C_2^2}, \quad \frac{C_2x_2}{C_3x_3} = \frac{C_2^2}{C_3^2}, \quad \text{etc.},$$

or

$$Cx : C_1x_1 : C_2x_2 : C_3x_3 : C_4x_4 = \frac{C^2}{4} : C_1^2 : C_2^2 : C_3^2 : C_4^2.$$

Referring to the equation to be solved, therefore, we see that $(-l)$ is to be divided into five pieces which shall be in the

ratio of the numbers $\frac{C^2}{4}$, C_1^2 , C_2^2 , C_3^2 , C_4^2 , giving for the successive terms of the equation the values

$$\frac{\frac{C^2}{4}(-l)}{\frac{C^2}{4} + C_1^2 + C_2^2 + C_3^2 + C_4^2}, \quad \frac{C_1^2(-l)}{\frac{C^2}{4} + C_1^2 + C_2^2 + C_3^2 + C_4^2}, \quad \text{etc.}$$

Hence, writing $S = \frac{-l}{\frac{C^2}{4} + C_1^2 + C_2^2 + C_3^2 + C_4^2}$, we have

$$Cx = \frac{C^2}{4} S, \quad \text{whence} \quad x = \frac{C}{4} S;$$

$$C_1x_1 = C_1^2S, \quad \text{"} \quad x_1 = C_1S;$$

$$C_2x_2 = C_2^2S, \quad \text{"} \quad x_2 = C_2S;$$

$$C_3x_3 = C_3^2S, \quad \text{"} \quad x_3 = C_3S;$$

$$C_4x_4 = C_4^2S, \quad \text{"} \quad x_4 = C_4S.$$

Combining these values of x , x_1 , x_2 , etc., to form v_a , v_b , etc., and applying these corrections to A , B , etc., we obtain the most probable values of the angles a , b , etc., consistent with the geometrical necessities of the figure and with the fact that all the angles were measured with equal care.

A complete example of adjustment by this method is worked out in the table on page 101, using the same quadrilateral that was adjusted by the approximate method (pages 95 and 96) in order to compare results. It will be noted that the first approximate adjustment has a maximum variation of only $0''.42$ from the rigorous adjustment, and that the second approximation comes within $0''.02$ of the rigorous values.

61. Weighted Adjustments and Larger Systems. If the measured angles of a triangle have different weights, the adjustment is made as already explained. If the measured angles of a quadrilateral or other figure are not of equal weight, the adjustment is best made by the method of least squares.

QUADRILATERAL ADJUSTMENT BY RIGOROUS METHOD

Measured Angles. ° ' "	Angle-equation Adjustment.				Log sin A, B, etc.	d.	Side-equation Adjustment.	Adjusted Angles. ° ' "	Check, log sines.
	for 360°.	for Opp. Angles.	Adjusted Values.						
			° ' "	° ' "					
a	"	"	A	46 18 40.10	9.8591992	20.1	+x+x ₁	46 18 38.48	9.8591959
b	+0.85	+0.95	B	53 26 10.00	9.9048200	15.6	+x-x ₁	53 26 11.94	9.9048230
c	+0.85	-0.55	C	42 11 29.90	9.8271188	23.2	-x+x ₂	42 11 27.24	9.8271126
d	+0.85	-0.55	D	38 03 40.00	9.7899342	26.9	-x-x ₂	38 03 42.34	9.7899405
e	+0.85	-0.95	E	58 19 12.20	9.9299270	13.0	+x+x ₃	58 19 10.52	9.9299248
f	+0.85	-0.95	F	41 25 37.90	9.8206400	23.8	+x-x ₃	41 25 39.90	9.8206448
g	+0.85	+0.55	G	34 33 50.10	9.7538921	30.6	-x+x ₄	34 33 47.39	9.7538238
h	+0.85	+0.55	H	45 41 19.80	9.8546440	20.6	-x-x ₄	45 41 22.19	9.8546489
	360 00 00.00	l = +389	360 00 00.00	l = -1

$$C^2 = \frac{-389}{7799.87} = -0.04987$$

$$\frac{C^2}{4} = 39.69$$

$$d_a = 20.1 \quad d_b = 15.6 \quad d_c = 23.2 \quad d_d = 26.9 \quad d_e = 13.0 \quad d_f = 23.8 \quad d_g = 30.6 \quad d_h = 20.6$$

$$C_1 = 35.7 \quad C_2 = 2510.01 \quad C_3 = 1354.24 \quad C_4 = 2621.44$$

$$C = \frac{-3.15}{4} = -0.7875$$

$$+x = -3.15 \times -0.04987 = +0.16$$

$$+x_1 = +35.7 \times -0.04987 = -1.78$$

$$+x_2 = +50.1 \times -0.04987 = -2.50$$

$$+x_3 = +36.8 \times -0.04987 = -1.84$$

$$+x_4 = +51.2 \times -0.04987 = -2.55$$

In work of moderate extent or importance a system composed of a series of triangles or quadrilaterals would have each triangle or quadrilateral independently adjusted. In work of the highest importance, such as primary triangulation, the entire system would be adjusted simultaneously by the method of least squares.

62. Computing the Lines of the System. After a figure or system is satisfactorily adjusted the distances between the various stations are computed, solving each triangle in order (as a plane triangle) by the ordinary sine ratio. In the case of the quadrilateral the two diagonals and the sides adjacent to the known side (called the base) are computed from the triangles involving the base; the side opposite the base is then computed from both the triangles in which it occurs, and the mean of the two results taken as its value. These two values would of course be **exactly** alike if the angle adjustments were perfect, but these adjustments are only correct as far as they are carried out decimally; a material disagreement in the two values would indicate errors in the computations.

63. Accuracy of Triangulation Work. The accuracy of this class of work is judged by measuring a check base at the end of the system, if the work is of moderate extent, with intermediate check bases if the work covers a large territory. The length of the check base as computed through the triangulation system should agree closely with its measured length. In triangulation work by the U. S. Coast and Geodetic Survey, extending over several states in one system, extremely close results are reached. In systems 600 to 800 miles in length the computed and measured values of check bases may agree within fractions of an inch.

CHAPTER V

COMPUTING THE GEODETIC POSITIONS

64. The Problem. After the triangulation system has been computed as described in the last chapter the *relative* positions of the various stations are known. By *computing the geodetic positions* is meant computing the *absolute* positions (latitudes and longitudes) of the triangulation stations from their relative positions; this computation can be made if we have the latitude and longitude of one of the stations and the azimuth of one of the lines through that station, provided we know the shape and dimensions of the earth. The problem, then, may be stated as follows: Given the latitude and longitude of a station and the azimuth and distance to another station, to find the latitude and longitude and the back azimuth at the second station. This problem is often called the L. M. Z. problem, the letters meaning *latitude, longitude (meridian), and azimuth*. The back azimuth at the second station will seldom be the same as the forward azimuth at the first station, on account of the convergence of the meridians. Having found the latitude, longitude, and back azimuth at the second station, the azimuths of the other lines at that station become known through the adjusted angles at that station, remembering that azimuths are counted clockwise from the south point continuously up to 360° , and that if the spherical excess has been removed from any angle it must be restored for the present purpose. By proceeding with the computations in the same manner from station to station we obtain the latitudes, longitudes, and azimuths for the whole system. There are many methods of solving the given problem, depending on the distance involved and the precision required; all methods are somewhat complicated on account of the shape of the earth. Two of the best solutions will be considered after discussing the figure of the earth.

65. The Figure of the Earth. It is doubtful when it was first realized that the surface of the earth is not a plane. Early Greek philosophers believed in solid figures of various shapes. Aristotle (340 B.C.) gives reasons for believing the shape to be spherical, geometers estimating the circumference at 300,000 stadia. The famous School of Alexandria appears to have made the first actual measurements of the curvature of the earth, and hence its radius, the earliest measurement being made by Eratosthenes, about the year 230 B.C., and a second one a little later. Eratosthenes concluded that the circumference of the earth was about 250,000 stadia in length, but the exact length of the stadium is now unknown. The knowledge which the Greeks obtained of the size and shape of the earth was lost during the declining civilization that followed, and no further measurements were made for upwards of a thousand years. About the year 825 the Arabs made a very good determination of the radius of the earth by measuring the arc of a meridian on the plains of Mesopotamia. This was followed by another lapse of about 700 years before any further measurements were undertaken. During the middle ages Europeans generally believed the earth to be flat until about the 15th century, when a few men, such as Columbus, declared it to be globular. In the 16th century general belief in the spherical shape of the earth was again established.

From the earliest measurements to the present time the principle employed has been essentially the same, but a very much higher degree of accuracy is now reached on account of the great refinement in detail. The fundamental idea is to obtain both the linear and the angular measure of the arc of a meridian, whence the distance divided by the number of degrees gives the length of one degree, and this multiplied by 360 gives the length of the entire circumference. In early times the meridian arc was actually staked out and its length obtained by direct measurement, but modern methods of measuring and computing are so improved that distances measured in any direction may be utilized. The angular measure of the arc is the angle between its two end radii (which meet near the center of the earth), and its value is obtained by finding the latitude at each end and taking their difference.

When Newton discovered the law of gravitation late in the 17th century he proved that the earth as a revolving plastic body

subject to its own attraction should have taken the form of a slightly flattened sphere, while an arc measured in France between 1683 and 1716 indicated an elongated sphere. To settle the question an arc was measured in the equatorial regions of Peru (1735-1741) and another in the polar regions of Lapland (1736-1737), which showed that a degree of latitude was longer near the pole than near the equator and that Newton's theory was correct. Since these dates a large amount of geodetic work has been done, in which France, Great Britain, Germany, Russia, and the United States have taken a leading part. Among the more recent arcs measured may be mentioned the Anglo-French arc, extending from the northern part of the British Isles southward into Africa; the great Russian arc, extending from the Arctic Ocean to the northern boundary of Turkey; the great Indian arc, extending from the southern point of India to the Himalayas; the European arc of a parallel, extending from southern Ireland eastward to central Russia; and in the United States, the trans-continental arc, extending along the 39th parallel from the Atlantic Ocean to the Pacific Ocean, and the eastern oblique arc, extending parallel to the Atlantic coast from Maine to Louisiana. These six arcs joined end to end would reach about two-fifths of the way around the earth.

66. The Precise Figure. Various names have been applied to the earth from time to time in the attempt to describe its shape more exactly as our knowledge has advanced. Roughly it may be called a *sphere*, since the flattening at the poles is relatively very small; a model with an equatorial diameter of fifty feet would only be flattened one inch at each pole. As the result of many precise measurements the shape has been found to be such that with considerable exactness any section parallel to the equator is a circle, and any section through the poles is an ellipse; the figure is such as may be generated by revolving an ellipse about its minor axis and is called an *oblate spheroid*. To be still more exact, the equatorial section is not exactly circular but very slightly elliptical, so that a section in any direction through the center would be an ellipse; such a figure is called an *ellipsoid*. Still further exactness indicates that the southern hemisphere is a trifle larger than the northern, and that all polar sections are therefore slightly oval, leading to the name *ovaloid*. As a matter of absolute precision no geometrical solid exactly

represents the shape of the earth, and this has been recognized by applying the special name *geoid*.

67. The Practical Figure. All the computations in geodetic work are based on the assumption that the figure of the earth is an *oblate spheroid*; this is found to be amply precise, since the variations from this figure are relatively very small. The most important determinations of the elements of the spheroid, founded on the best available data, are those made by Bessel in 1841 and Clarke in 1866. Bessel's spheroid is still largely used in Europe, but all computations in the United States are made on the basis of Clarke's spheroid, which conforms better to the actual surface of this country. According to Clarke's comparison of standards a meter contained 3.2808693 feet, a result which is now known to be too large. In the legal units of the United States the meter contains exactly 39.37 inches, which equals 3.2808333 feet, a value which is believed to be very close to the exact truth. The elements of Clarke's spheroid in U. S. legal units are as follows:

$$\text{Semi-major axis} = a = \begin{cases} 6,378,276.5 \text{ meters,} & \log = 6.8047033 \\ 20,926,062 \text{ feet,} & \log = 7.3206875 \end{cases}$$

$$\text{Semi-minor axis} = b = \begin{cases} 6,356,653.7 \text{ meters,} & \log = 6.8032285 \\ 20,855,121 \text{ feet,} & \log = 7.3192127 \end{cases}$$

$$\text{Ellipticity} = \frac{a-b}{a} = \epsilon = 0.00339007, \log = 7.5302093 - 10$$

$$\text{Eccentricity} = \sqrt{\frac{a^2 - b^2}{a^2}} = e = 0.08227184, \log = 8.9152513 - 10$$

$$\text{Eccentricity}^2 = \frac{a^2 - b^2}{a^2} = e^2 = 0.0067686580, \log = 7.8305026 - 10$$

$$\text{Ratio of axes} = \frac{b}{a} = \frac{293.98}{294.98}, \log = 9.9985252 - 10$$

68. Geometrical Considerations. In Fig. 33 the ellipse *WNES* represents a polar section of the earth, in which *WNES* is the meridian; *NS*, the polar axis, or minor axis of the ellipse; *WE*, the equatorial diameter, or major axis of the ellipse; *n*, any point on the meridian; *nt*, the tangent at *n*; *nlp_m*, the normal at *n*, or the direction of the plumb line if there is no local deflection;

np , the radius of curvature at n ; no , the radius of the small circle or parallel of latitude at n ; f, f , the foci of the ellipse; ϕ , the latitude of the point n . It is to be noted that the normal nm from the point n does not pass through the center c (except when n is at the poles or on the equator), and that the radius of curvature (and hence the length of a degree of latitude) increases from the equator to the poles; that the radii of curvature for different

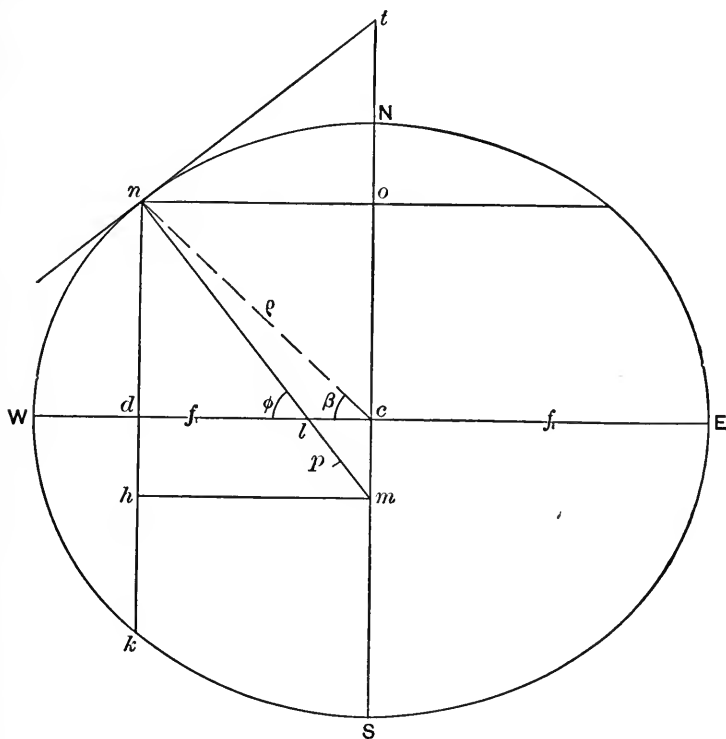

FIG. 33.

latitudes on a meridian do not intersect unless produced; and that for different latitudes not on the same meridian the normals (which include the radii of curvature) do not intersect at all.

Since the normals for two points of different latitudes and longitudes do not intersect, they do not lie in a plane; hence, Fig. 34, page 108, the vertical plane at $A(AaB)$ which includes B and the line of sight from A to B , is not the same as the vertical

plane at $B(BbA)$ which includes A and the line of sight from B to A . The lines which these planes cut at the surface of the spheroid are called *elliptic arcs*. In setting points from A to B an observer at A would mark out the line AaB , while an observer at B would mark out the line BbA ; the greatest discrepancy between the lines would be practically at the center, and under extreme conditions might amount to about an inch for 50 mile lines and 10 feet for 500 mile lines; the angles bAa and bBa might approximate $0''.1$ for 50 mile lines and $2''.0$ for 500 mile lines. For lines 100 miles or so long, therefore, it is evident that the two elliptic arcs may usually be regarded as identical, but that for greater distances the question may often be of considerable

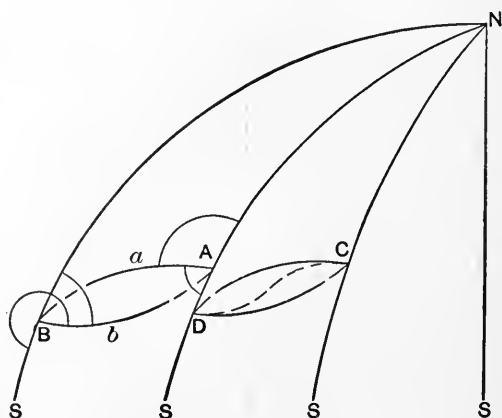

FIG. 34.

importance. If an observer should set up his instrument at any intermediate point on either elliptic arc he would not find himself in line with A and B ; if he sighted on A , for instance, he could not sight on B by simply transiting his telescope, as the angle between A and B would not measure 180° . An *alignment curve* (as represented by the dotted line CD , Fig. 34) is such a line that at any intermediate point a vertical plane can be established that will pass through both end stations; as seen from any intermediate point the two end stations are always 180° apart; such a line is a line of double curvature, slightly less in length than the elliptic arcs between which it lies, and tangent to the line of sight at each

end. A *geodesic line* is the shortest line that can be drawn between two points on a spheroid, and is a line of double curvature resembling the alignment curve, but the reverse curvature is not so pronounced. Between any two points on the earth that are actually intervisible all the lines described may be regarded as of equal length.

In geodetic work the term *latitude* always refers to the angle ϕ (Fig. 33, page 107) or *geodetic latitude*, and not to the angle ncd or geocentric latitude. The astronomical latitude, or angular distance from the equator to the zenith, is the same as the geodetic latitude except where there is local deflection of the plumb line. By *longitude* is meant the angular distance from some fixed meridian (usually Greenwich) to the given meridian, positive when counted westward. By the *azimuth* of a line (or a direction) from a given point is meant its angular divergence from the meridian at that point, counted clockwise from the south continuously up to 360° . Thus in Fig. 34, the angle DAa is the azimuth at A towards B (AaB being the line of sight from A), and the angle SBb (clockwise as marked) is the azimuth from B towards A . The azimuth (or forward azimuth) of a line means taken forward along the line, and back azimuth means in the reverse direction; the azimuth and back azimuth at the same point differ by 180° . The angles NAa and NBb , inside the two polar triangles NAB , are called *azimuthal angles*, the angle at each station being taken to the line of sight from that station; the relation of these angles to the azimuth above described is self evident. In solving either of the triangles NAB the angles at both A and B must be taken in the same triangle, the necessary reduction being made by means of the auxiliary angles bBa and bAa .

69. Analytical Considerations. The most important section of the spheroid is the meridian section, Fig. 33, page 107, of which N and R are the principal functions.

Let N = the normal nm ;

\overline{R} = radius of curvature np ;

r = radius no of parallel of latitude;

T = tangent nt ;

ϕ = latitude (geodetic);

β = geocentric latitude;

ρ = radius vector nc ;

then from analytical geometry

$$\begin{aligned}
 N &= \frac{a}{(1 - e^2 \sin^2 \phi)^{\frac{1}{2}}}, & R &= \frac{a(1 - e^2)}{(1 - e^2 \sin^2 \phi)^{\frac{1}{2}}}, \\
 R \text{ at equator} &= \frac{b^2}{a}, & R \text{ at poles} &= \frac{a^2}{b}, \\
 r &= N \cos \phi, & T &= N \cot \phi, \\
 nl &= N(1 - e^2), & nd &= N(1 - e^2) \sin \phi, \\
 \tan \beta &= \frac{b^2}{a^2} \tan \phi, & \rho &= a(1 - e^2 \sin^2 \beta)^{\frac{1}{2}} \text{ (approx.)},
 \end{aligned}$$

$$\sqrt{RN} = \text{radius of osculating sphere at } n = \frac{a\sqrt{1 - e^2}}{1 - e^2 \sin^2 \phi},$$

in which the logarithms of the constants are as follows:

Quantity.	Metric.	Feet.
a	6.8047033	7.3206875
b	6.8032285	7.3192127
e^2	7.8305026 - 10	7.8305026 - 10
$(1 - e^2)$	9.9970504 - 10	9.9970504 - 10
$a(1 - e^2)$	6.8017537	7.3177379
$a\sqrt{1 - e^2} = b$	6.8032285	7.3192127
$\frac{b^2}{a} = a(1 - e^2)$	6.8017537	7.3177379
$\frac{a^2}{b} = \frac{a}{\sqrt{1 - e^2}}$	6.8061781	7.3221623
$\frac{b^2}{a^2} = 1 - e^2$	9.9970504 - 10	9.9970504 - 10

The section of next importance at any point, after the meridian section, is that which is cut from the spheroid by the *prime vertical*, which is the vertical plane at the given point that is perpendicular to the meridian through that point. The ellipse that is thus cut from the spheroid is tangent to the parallel of latitude through the given point, and hence a straight line run east or west from any point is commonly called a *tangent*. The radius of curvature, R_p , of a prime-vertical section at the point where it originates has the same length as the normal N at that point, that is,

$$R_p = N = \frac{a}{(1 - e^2 \sin^2 \phi)^{\frac{1}{2}}}.$$

A vertical plane at a given point that is neither a meridional plane nor a prime-vertical plane, is called an *azimuth plane*; such a plane cuts an *azimuth section* from the spheroid and traces an *azimuth line* on its surface, that is, a straight line whose initial direction is not at right angles to the meridian. All the properties of an azimuth section may be deduced from those of the prime-vertical and meridional sections. Thus, for instance,

- Let α = azimuth of azimuth line at initial point;
 N = normal at same point;
 R = radius of curvature of meridian section at same point;
 R_α = radius of curvature of azimuth section at same point;

then

$$R_\alpha = \frac{R}{\cos^2 \alpha \left(1 + \frac{R}{N} \tan^2 \alpha \right)}$$

70. Convergence of the Meridians. On account of the convergence of the meridians the azimuth of a line varies from point to point, unless the given line be the equator or a meridian. By the *convergence of the meridians* is meant their angular drawing towards each other in passing from the equator to the poles.

Any two meridians are parallel at the equator or have a zero convergence (meaning no inclination towards each other); in moving towards the poles the meridians incline more and more towards each other, until at the poles the convergence is just equal to the difference of longitude. Referring to Fig. 35, the convergence at any two points, n , n' , which are in the same latitude ϕ_1 , is found by drawing tangents from n and n'

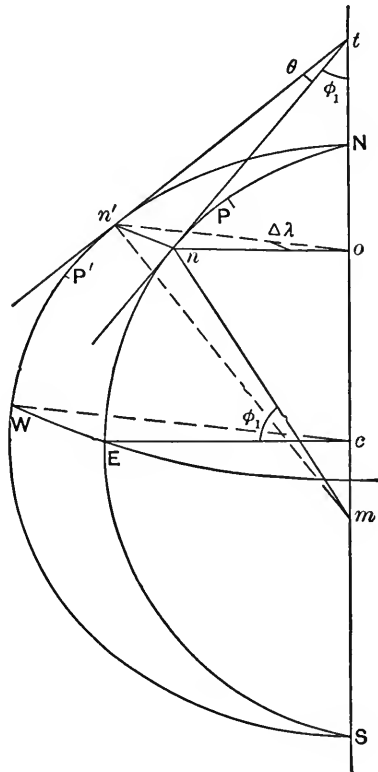

FIG. 35.

to their intersection t on the polar axis, in which case the angle θ is the convergence for those two meridians for the common latitude ϕ . When the two points P and P' are not in the same latitude the convergence for the middle (average) latitude is understood; so that if ϕ and ϕ' represent the latitudes of the two points we may write in any case $\phi_1 = \frac{1}{2}(\phi + \phi')$, and n and n' represent points on the middle parallel of latitude.

Let ϕ_1 = the common latitude for the points n and n' (or the average latitude for any two latitudes ϕ and ϕ');

$\Delta\lambda$ = difference of longitude for the two meridians;

$no = r$ = radius of parallel of latitude at n ;

$nt = T$ = tangent at n .

From the figure

$$\text{Chord } nn' = 2T \sin \frac{1}{2}\theta = 2r \sin \frac{1}{2}(\Delta\lambda).$$

Substituting $r = T \sin \phi_1$,

$$2T \sin \frac{1}{2}\theta = 2T \sin \phi_1 \sin \frac{1}{2}(\Delta\lambda),$$

or

$$\sin \frac{1}{2}\theta = \sin \frac{1}{2}(\Delta\lambda) \sin \phi_1,$$

which in terms of the latitudes ϕ and ϕ' becomes

$$\sin \frac{1}{2}\theta = \sin \frac{1}{2}(\Delta\lambda) \sin \frac{1}{2}(\phi + \phi').$$

When the difference of longitude, $\Delta\lambda$, is small, θ will also be small, and we may write with great closeness

$$\theta = (\Delta\lambda) \sin \frac{1}{2}(\phi + \phi'),$$

in which θ will be in the same unit as $\Delta\lambda$ (usually taken in minutes or seconds). Thus in an average latitude of 40° and a difference of longitude of one degree, or about 60 miles, the error of the approximation would be less than the one thousandth part of a second.

Referring to Fig. 36, let rr' be a straight line in the plane stv , and passing as close as possible to the points P and P' . In any case occurring in practice the angle rpv will differ but very little from the forward azimuth at P of a true geodetic line from P through P' , and the angle $rp's$ will closely represent the corre-

sponding forward azimuth at P' . We may therefore write with great closeness

$$\text{Change of azimuth} = rp's - rpv.$$

But from the figure

$$\theta = rpv - rp's,$$

or

$$\text{Change of azimuth} = -\theta = -(\Delta\lambda) \sin \frac{1}{2}(\phi + \phi').$$

Hence, in passing from one station to another, the change of azimuth is very closely the same in numerical value as the corresponding convergence of the meridians. The error in the approximation in running 60 miles in any direction in the neighborhood of 40° latitude would not exceed one tenth of a second. In the northern hemisphere the azimuth of a line decreases in running westward, and increases in running eastward, and vice versa in the southern hemisphere. The minus signs in the last formula must therefore be changed to plus in the southern hemisphere. In running approximately east and west in about 40° latitude the change of azimuth will be over half a minute per mile. The back azimuth of a line is equal to the forward azimuth at the same point plus 180° (less 360° if this number is exceeded).

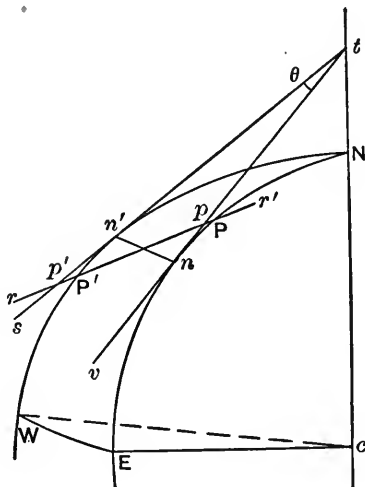

FIG. 36.

71. The Puissant Solution. Given the latitude and longitude of a station and the azimuth and distance to a second station, the problem (Art. 64) is to find the latitude, longitude, and back azimuth at the second station. The Puissant solution (as modified by the U. S. C. & G. S.) is found amply precise if the distance between the stations does not exceed about 1° of arc or about 69 miles (in which case the errors of the computed values might run from 0.001 to 0.003 seconds). For a

less degree of accuracy the method may be used up to about 100 miles. The Puissant method has the advantage that only seven place logarithms are required. With the help of special tables for certain factors in the formulas the actual work of computation is not very great. For a derivation of the formulas, examples of their use, and a complete set of tables, see Appendix No. 9, Report for 1894, U. S. Coast and Geodetic Survey. These formulas (in slightly different form) are as follows:

Let ϕ = the known latitude at the first station;
 λ = the known longitude at the first station;
 α = the known azimuth at the first station;
 ϕ' = the unknown latitude at the second station;
 λ' = the unknown longitude at the second station;
 α' = the unknown back azimuth at the second station;
 s = the known distance between the stations;
 $A, B, \text{ etc.},$ = certain factors required in the formulas;

then by successive steps we have

$$h = s \cos \alpha \cdot B,$$

$$\delta\phi = - (h + s^2 \sin^2 \alpha \cdot C - h \cdot s^2 \sin^2 \alpha \cdot E),$$

or with ample precision

$$\delta\phi \text{ (for 15 miles or less)} = - (h + s^2 \sin^2 \alpha \cdot C).$$

In either case

$$\Delta\phi = \delta\phi - (\delta\phi)^2 \cdot D,$$

and

$$\phi' = \phi + \Delta\phi = \text{latitude of second station};$$

$$\Delta\lambda = \left(\frac{s \sin \alpha \cdot A}{\cos \phi'} \right) G,$$

and

$$\lambda' = \lambda + \Delta\lambda = \text{longitude of second station};$$

$$\Delta\alpha = - \left[(\Delta\lambda) \sin \frac{1}{2}(\phi + \phi') \frac{1}{\cos \frac{1}{2}(\Delta\phi)} + (\Delta\lambda)^3 \cdot F \right],$$

or with ample precision

$$\Delta\alpha \text{ (for 15 miles or less)} = - (\Delta\lambda) \sin \frac{1}{2}(\phi + \phi'),$$

which agrees with the result of Art. 70. The sign of $\Delta\alpha$ is for the northern hemisphere, and is to be reversed in the southern hemisphere. Then

$$\alpha' = \alpha + \Delta\alpha + 180^\circ = \text{back azimuth at second station.}$$

In the above formulas the values of $\Delta\phi$, $\Delta\lambda$, and $\Delta\alpha$ are obtained in seconds. In using the formulas both north and south latitude are to be taken as positive, west longitude as positive and east longitude as negative, and the trigonometric functions are to be given their proper signs. The lettered factors of the formulas have the following values:

$$A = A'(1 - e^2 \sin^2 \phi')^{\frac{1}{2}}, \quad D = D' \left(\frac{\sin \phi \cos \phi}{1 - e^2 \sin^2 \phi} \right),$$

$$B = B'(1 - e^2 \sin^2 \phi)^{\frac{3}{2}}, \quad E = E'(1 + 3 \tan^2 \phi)(1 - e^2 \sin^2 \phi),$$

$$C = C'(1 - e^2 \sin^2 \phi)^2 \tan \phi, \quad F = F'(\sin \phi \cos^2 \phi),$$

$G =$ value determined by second part of Table II,

in which the logarithms of the constants are as follows:

Constant.	Metric.	Feet.
$A' = \frac{1}{a \text{ arc } 1''}$	8.5097218 - 10	7.9937376 - 10
$B' = \frac{1}{a(1 - e^2) \text{ arc } 1''}$	8.5126714 - 10	7.9966872 - 10
$C' = \frac{1}{2a^2(1 - e^2) \text{ arc } 1''}$	1.4069381 - 10	0.3749697 - 10
$D' = \frac{3}{2} e^2 \text{ arc } 1''$	2.6921687 - 20	2.6921687 - 20
$E' = \frac{1}{6a^2}$	5.6124421 - 20	4.5804737 - 20
$F' = \frac{1}{12} \text{ arc}^2 1''$	8.2919684 - 20	8.2919684 - 20

With the help of these constants it is not difficult to find the values of the factors A to F for any latitude. If the distance s is given in meters these factors may be taken from Table II, at the end of the book, this table being an abridgment of the

Coast Survey tables referred to (and corrected to agree with the U. S. legal meter of 39.37 inches).

72. The Clarke Solution. This solution of the problem (Art. 64) is adapted to greater distances than the previous one, being sufficiently precise for the longest lines (say about 300 miles) that could ever be directly observed. It has the advantage of being reasonably convenient in use, even without specially prepared tables, but requires not less than nine place logarithms for close work, on account of the size of the numbers involved. In this method the azimuthal angles are used in the computations instead of the azimuths themselves. The azimuthal angles (shown in Fig. 34, page 108, and explained at end of Art. 68), are the angles (at the stations) inside the polar triangles which are formed by the nearest pole and the two stations, the relation to the corresponding azimuths being always self-evident. The formulas used in this solution (taken from Appendix No. 9, Report for 1885, U. S. Coast and Geodetic Survey, but modified in form) are as follows:

- Let ϕ = the known latitude at the first station;
 λ = the known longitude at the first station;
 α = the known azimuthal angle at the first station;
 ϕ' = the unknown latitude at the second station;
 λ' = the unknown longitude at the second station;
 α' = the unknown azimuthal angle at the second station;
 s = the known distance between the stations;
 θ = the angle between terminal normals;
 ζ = auxiliary azimuthal angle at second station;
 $\Delta\lambda = \lambda' - \lambda$ = difference of longitude;
 $\Delta\phi = \phi' - \phi$ = difference of latitude;
 $\gamma = 90^\circ - \phi$ = co-latitude at first station;
 N = normal (to minor axis) at first station;
 R = radius of curvature of meridian at middle latitude;
 $\frac{1}{2}(\phi + \phi')$ = middle latitude.

From Art. 69,

$$N = \frac{a}{(1 - e^2 \sin^2 \phi)^{3/2}}, \quad R = \frac{a(1 - e^2)}{[1 - e^2 \sin^2 \frac{1}{2}(\phi + \phi')]^{3/2}}$$

Then

$$\theta = \frac{s}{N \sin 1''} + \left(\frac{e^2 \sin^2 1''}{6(1 - e^2)} \right) \theta^3 \cos^2 \phi \cos^2 \alpha.$$

But if s is not over about 100 miles we may write with ample precision

$$\theta = \frac{s}{N \sin 1''}.$$

In either case s and N must be in the same unit, and θ is obtained in seconds. If the second term is used in finding θ the approximate value of θ is used in that term. The value of this second term is always extremely small. Then

$$\zeta = \left(\frac{e^2 \sin 1''}{4(1-e^2)} \right) \theta^2 \cos^2 \phi \sin 2\alpha,$$

in which ζ is obtained in seconds and is always a very small quantity;

$$\tan P = \frac{\sin \frac{1}{2}(\gamma - \theta)}{\sin \frac{1}{2}(\gamma + \theta)} \cot \frac{\alpha}{2},$$

$$\tan Q = \frac{\cos \frac{1}{2}(\gamma - \theta)}{\cos \frac{1}{2}(\gamma + \theta)} \cot \frac{\alpha}{2},$$

from which values

$$\alpha' = P + Q - \zeta = \text{azimuthal angle at second station};$$

$$\Delta\lambda = Q - P;$$

$$\lambda' = \lambda + \Delta\lambda = \text{longitude at second station}.$$

The difference of latitude is found from the formula

$$\Delta\phi = \frac{s}{R \sin 1''} \left(\frac{\sin \frac{1}{2}(\alpha' + \zeta - \alpha)}{\sin \frac{1}{2}(\alpha' + \zeta + \alpha)} \right) \left[1 + \left(\frac{\sin^2 1''}{12} \right) \theta^2 \cos^2 \frac{1}{2}(\alpha' - \alpha) \right],$$

in which $\Delta\phi$ is obtained in seconds, and in which s and R must be in the same unit. Then

$$\phi' = \phi + \Delta\phi = \text{latitude at second station}.$$

It must be noted, however, that the $\Delta\phi$ formula requires the use of R for the middle latitude, which is not known until $\Delta\phi$ is found. $\Delta\phi$ must therefore be found by successive approximation—that is, an approximate value of R must first be used to obtain an approximate value of $\Delta\phi$, a greatly improved value of R thus becoming available to find a much closer value of $\Delta\phi$, and so on.

A few trials will soon give a value of R which is consistent with the value of ϕ' to which it leads. As with the Puissant formulas, both north and south latitude are to be taken as positive, west longitude as positive and east longitude as negative, and trigonometric functions used with their proper signs. The constants which enter into the above formulas have the following values:

Quantity.	Log.	Quantity.	Log.
a (metric)	6.8047033	$a(1 - e^2)$ (metric)	6.8017537
a (feet)	7.3206875	$a(1 - e^2)$ (feet)	7.3177379
e^2	7.8305026 - 10	$(1 - e^2)$	9.9970504 - 10
$\frac{e^2 \sin^2 1''}{6(1 - e^2)}$	6.4264506 - 20	$\sin 1''$	4.6855749 - 10
$\frac{e^2 \sin 1''}{4(1 - e^2)}$	1.9169671 - 10	$\frac{\sin^2 1''}{12}$	8.2919684 - 20

When the distance is so great that the Clarke solution is not satisfactory, resort must be had to more direct solutions, requiring at least ten place logarithms. The solutions by Bessel (1826) and Helmert (1880) are of this character.

73. The Inverse Problem. In this case the latitude and longitude are known at each of two stations, and the problem is to find the connecting distance and the mutual azimuths. The solution may be effected with either the Puissant or the Clarke formulas.

By the Puissant Formulas. There are several ways of securing the desired result; the one here given is chosen on account of its directness and simplicity. By transforming and combining the formulas in Art. 71, omitting terms which are too small to be appreciable, and writing x and y for the resulting values, we have

$$s \sin \alpha = y = \frac{(\Delta \lambda) \cos \phi'}{A};$$

$$s \cos \alpha = x = -\frac{1}{B}[\Delta \phi + C \cdot y^2 + D(\Delta \phi)^2 + E(\Delta \phi)y^2 + E \cdot C \cdot y^4],$$

from which we obtain

$$\tan \alpha = \frac{y}{x} \quad \text{and} \quad s = \frac{y}{\sin \alpha} = \frac{x}{\cos \alpha}.$$

The closest value of s is obtained from the fraction whose numerator is the smallest. Then, from Art. 71,

$$\Delta\alpha = -\left[(\Delta\lambda) \sin \frac{1}{2}(\phi + \phi') \frac{1}{\cos \frac{1}{2}(\Delta\phi)} + (\Delta\lambda)^3 \cdot F \right],$$

$$\Delta\alpha \text{ (for 15 miles or less)} = -(\Delta\lambda) \sin \frac{1}{2}(\phi + \phi'),$$

and in either case

$$\alpha' = \alpha + \Delta\alpha + 180^\circ.$$

Either station may be called the first station, so that the problem may be worked both ways as a check, if desired, in which case $\Delta\alpha$ need not be computed at all. As in Art. 71, the values $\Delta\alpha$, $\Delta\phi$, and $\Delta\lambda$ are expressed in seconds, and s will be in the same unit as that on which the factors A , B , etc., are based.

By the Clarke Formulas. In this method the desired values are found by successive approximation. The Puissant method

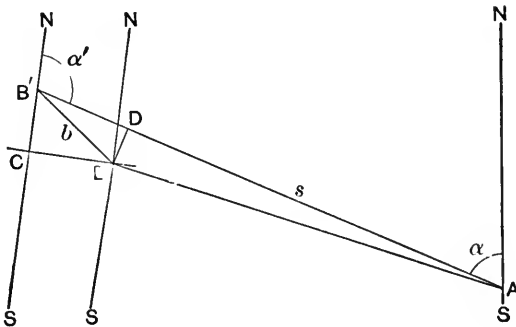

FIG. 37.

is applied first, therefore, to obtain as close an approximation as possible to begin with. The approximate values of s and α (changed to the azimuthal angle) are then substituted in the Clarke formulas, calling either station the first station, and computing the latitude and longitude for the second station. The computed values will usually disagree a small amount with the known latitude and longitude of the second station, and a new trial has to be made with s and α slightly changed, and so on until the assumed values of s and α satisfy the known conditions. The disagreement to be adjusted is always very small, and when all the circumstances are known it is not difficult to

judge which way and how much to modify s and α to remove the difficulty. Referring to Fig. 37, let the lines NS represent meridians, the line CB a parallel of latitude, and A and B the points whose latitude and longitude are known. With the assumed distance s and the assumed azimuthal angle α suppose, for instance, that the computation gives us the point B' instead of the desired point B . We then have

$$BC = \text{error in longitude in seconds of arc};$$

$$B'C = \text{error in latitude in seconds of arc};$$

$$BB' \text{ (in seconds)} = \sqrt{BC^2 + B'C^2};$$

$$b = BB' \text{ in distance} = (BB')R \sin 1'' \text{ (approximately)};$$

$$\tan CB'B = \frac{BC}{B'C};$$

$$BB'D = 180^\circ - \alpha' - CB'B;$$

$b \cos BB'D = B'D = \text{approximate error in the assumed value for distance } s;$

$$\frac{b \sin BB'D}{s \sin 1''} = BAD \text{ (nearly) in seconds} = \text{approximate error in assumed value of angle } \alpha.$$

74. Locating a Parallel of Latitude. For marking boundaries, or other purposes, it often becomes desirable to stake out a parallel of latitude directly on the ground. Points on the parallel are most conveniently found by offsets from a tangent (Art. 69). Thus in Fig. 38, ABD is a tangent from the point A , and ACF is the corresponding parallel; the point C on the parallel, for instance, is determined by the offset BC and the back-azimuth angle SBA . It is seldom desirable to run a tangent over 50 miles on account of the long offsets required; if the parallel is of greater length it is better to start new tangents occasionally. The computations may be made by either the Puissant (Art. 71), or the Clarke (Art. 72) formulas, which are much simplified by the east and west azimuths. Using the Puissant formulas, substituting 90° (westward) or 270° (eastward) for α , and omitting

inappreciable terms, we have with great precision for a hundred miles or more

$$\Delta\phi \text{ (in seconds)} = -s^2 \cdot C,$$

$$\Delta\lambda \text{ (in seconds)} = \begin{cases} \text{running } W, + \\ \text{running } E, - \end{cases} \frac{s \cdot A}{\cos \phi'};$$

whence

$$\Delta\phi \text{ (in linear units)} = - (s^2 \cdot C) R \sin 1'' = - \frac{s^2 \tan \phi}{2N},$$

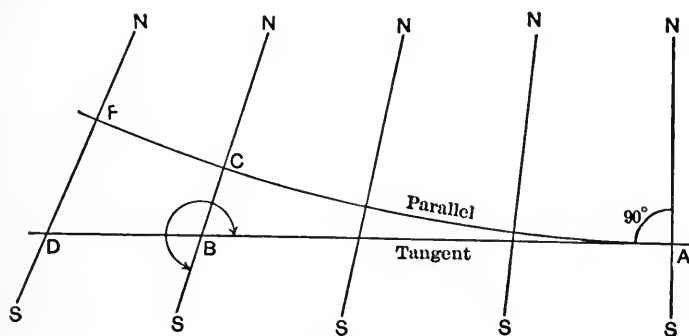

FIG. 38.

in which either formula may be used as preferred, and in which all linear quantities must be taken in the same unit. The expressions for N and R are given in Art. 69. For the change of azimuth we have

$$\Delta\alpha \text{ (in seconds)} = \begin{cases} \text{N. hemisphere,} & - \\ \text{S.} & + \end{cases} [(\Delta\lambda) \sin \frac{1}{2}(\phi + \phi') + (\Delta\lambda)^3 \cdot F];$$

or for the field work (within one-tenth of a second),

$$\Delta\alpha \text{ (in seconds)} = \begin{cases} \text{N. hemisphere,} & - \\ \text{S.} & + \end{cases} (\Delta\lambda) \sin \phi.$$

It is seen from the above formulas that the offsets (in seconds or linear units) may be taken to vary directly as the square of the distance, and the change of azimuth directly as the change of longitude.

In actual practice the point A may have to be located, or may be given by description or monument; in either case the latitude and meridian at A are determined by astronomical

observations, and the tangent AB (or a line parallel thereto) run out by the ordinary method of double centering. At the end of the tangent the computed value of the back azimuth should be compared with an astronomical determination; in the writer's experience on the Mexican Boundary Survey with an 8-inch repeating instrument (with striding level), and heliotrope sights ranging in length from 6 to 80 miles, the back-azimuth error was readily kept below one-tenth of a second per mile, regardless of the number of prolongations in the line. The conditions met with in the survey referred to are illustrated in Fig. 39, which shows also the adjustment made for back-azimuth error. The boundary line was intended to be the parallel of $31^\circ 47'$, but according to treaty all existing monuments had to be accepted as marking the true line. The astronomical station was conveniently located, and proved to be slightly south of the desired parallel, which in turn passed south of the old monument L . When the last point on the tangent was reached the back azimuth measured less than the theoretical value, indicating that the tangent as staked out swerved slightly to the south from its original direction. Assuming all corresponding distances on tangents and parallels to be equal and the azimuth error to accumulate uniformly from A to d ,

Let E = azimuth error at d ;

E_b = azimuth error at b ;

then

$$E_b = \frac{Ab}{Ad} E; \quad dD = \frac{Ad}{2} E \sin 1''; \quad bB = \frac{Ab^2}{2Ad} E \sin 1'';$$

$$DF = \Delta\phi \text{ (linear) for } AD; \quad BC = \Delta\phi \text{ (linear) for } AB;$$

$$dM \text{ and } AL \text{ are known by measurement;}$$

$$FG = CH = AL;$$

$$GM = dM - dD - DF - AL;$$

$$HP = GM \frac{LH}{LG} = GM \frac{Ab}{Ad}.$$

Hence for any point P , on the adjusted boundary, we have

$$bP = bB + BC + CH + HP.$$

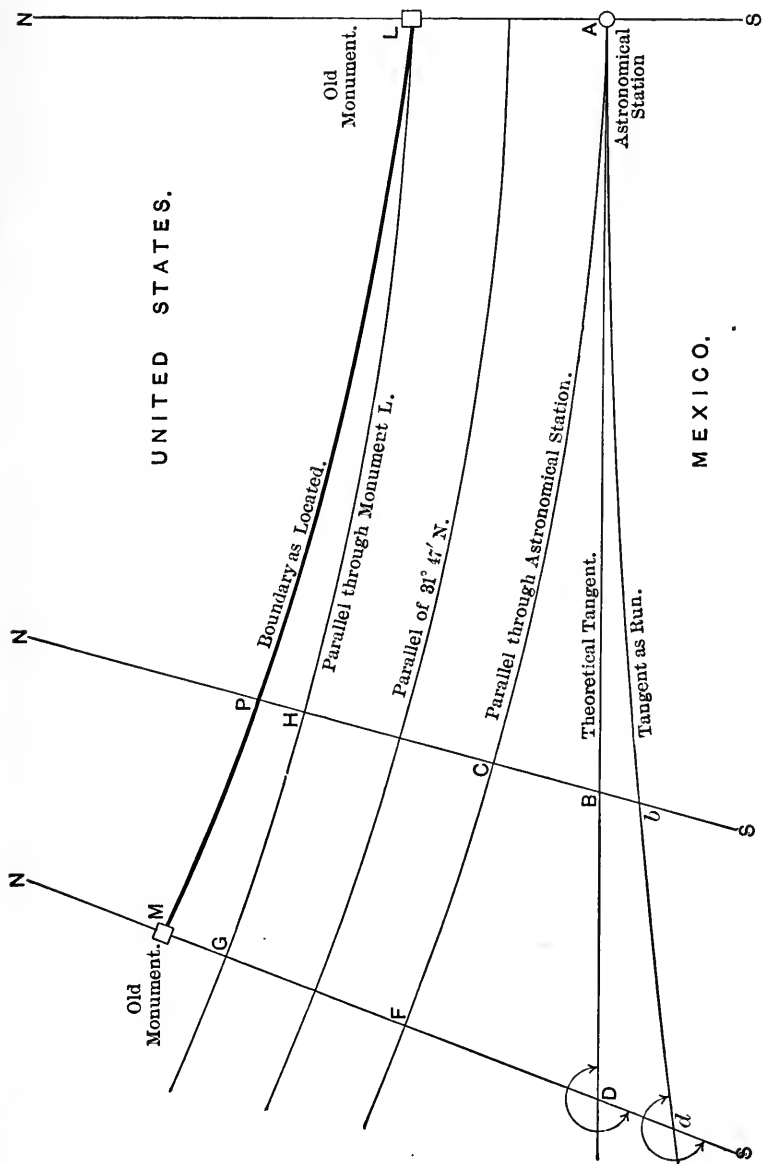

FIG. 39.—Location of a Boundary Line.

75. Deviation of the Plumb Line. There is always more or less uncertainty at any station as to the plumb line hanging truly vertical, or normal to the surface of the spheroid; it is not uncommon for the deviation to amount to 10 or more seconds of arc, with occasional values of 15 to 30 seconds. This fact is forced on our notice in a number of ways; if, for instance, the computed latitudes and longitudes of the stations in a triangulation system are tested by astronomical observations, the discrepancies are often greater than can be charged to either determination; if a parallel of latitude is staked out and tested astronomically at different points, the same discrepancies appear. By a proper combination of geodetic and astronomical measurements involving a number of stations, the probable deviation at each station and the probable errors in the latitude and longitude determinations can be computed. Astronomical and computed azimuths disagree for the same reason, and require similar adjustment. In moderate sized triangulation systems, such as are likely to engage the attention of the civil engineer, adjustments of this kind are rarely called for; but in extended systems astronomical latitudes, longitudes, and azimuths are taken at many stations, in order that such adjustments may be made.

CHAPTER VI

GEODETIC LEVELING

76. Principles and Methods. Leveling is the operation of determining the relative elevations of different points on the surface of the earth. By *relative elevation* is meant the difference of elevation between any two points compared. The *absolute elevation* of a point is its elevation above some particular point or surface of reference, mean low water, for instance; in geodetic work elevations are commonly referred to mean sea level. A *level line* is a line having the same absolute elevation at every point. By *geodetic leveling* is meant that class of leveling in which extra precision is sought by refinement of instruments and methods.

Three principal methods are available for determining differences of elevation, (A) *Barometric Leveling*, (B) *Trigonometric Leveling*, (C) *Precise Spirit Leveling*. Barometric leveling, based on determinations of atmospheric pressure, is briefly treated below on account of its usefulness in reconnaissance work. Geodetic leveling is generally understood to mean either trigonometric leveling, based on vertical angles (corrected for curvature and refraction), or precise spirit leveling, which differs from ordinary spirit leveling only in the refinement of its details.

77. Determination of Mean Sea Level. By *mean sea level* is meant the average elevation of the surface of the sea due to its continual change of level; and not, as might be supposed, the mean elevation of its high and low waters. In order to average out the irregularities due to winds and other causes the observations at any point should extend over a period of several years. Further, since tidal variations are relatively large during a lunar month, only complete lunations can be allowed in the reductions; if any storm period, for instance, is rejected on account of its excessive irregularities, that entire lunation must be rejected.

Observations of the varying elevation of the surface of the sea are best made by means of automatic tide gauges. An

automatic or self-registering tide gauge consists essentially of a well made clock and attached mechanism, by which a sheet of paper is drawn continuously past a pencil point which is moved crosswise of the paper by connection with a float; a rising and falling curve is thus traced on the paper, in which the ordinate of any point shows the elevation of the water at the time indicated by the corresponding abscissa. The float moves up and down in a vertical box admitting water only through a small opening in the bottom, which practically prevents oscillation of the float by wave action. A catgut cord or fine wire connects the float with the pencil through a suitable reducing mechanism. Pin points are often arranged to prick the even hours on the paper. The clock is often designed to run a week without rewinding, and the paper to last a month without changing. A scale of one inch per foot and $\frac{3}{4}$ of an inch per hour makes a very good record.

A staff tide gauge is always placed as near as possible to the automatic gauge, and its zero point connected by accurate leveling with a permanent bench mark near by. At least once a week the attendant carefully raises and lowers the float so that the pencil of the automatic gauge will mark the true direction of the ordinates at that time; and near the ordinate thus made he records the date, the staff reading, and the clock reading and error. The attendant's visits should be so timed that his staff readings will be alternately near high and low water, thus furnishing scales for different parts of the sheet that will practically neutralize errors due to stretching or shrinking of the paper or float connections. Hourly ordinates are drawn on all the records obtained at a station, and the average value of these ordinates is taken as the staff reading of mean sea level at that station. The relation of the permanent bench mark to the zero of the staff having been determined, as previously described, the elevation of the bench mark with reference to mean sea level becomes known, and furnishes the basis of the precise level lines that are extended to inland points.

A. BAROMETRIC LEVELING

78. Instruments and Methods. The instruments available are the familiar types of aneroid and mercurial barometers.

The mercurial barometer is the standard instrument for indicating atmospheric pressure, but lacks the aneroid's advantage of convenience in portability. The aneroid barometer is decidedly inferior to the mercurial barometer as a pressure indicator, but is sufficiently accurate for many purposes, such as reconnaissance work. Pocket aneroids (about 3 inches in diameter) are found to be as reliable as the larger sizes. Aneroids are intended to read the same as mercurial barometers under the same conditions, being *compensated* for the effect of temperature on their own construction; they are not compensated for the effect of temperature on atmospheric pressures. The aneroid requires careful handling, should be kept in its case at all times and away from the heat of the body, should be read in the open air and in a horizontal position, and should be gently tapped when reading to overcome any friction among its moving parts.

If all the conditions were the same at two different stations, the difference in atmospheric pressure would correspond to the difference in altitude; for points not over about 100 miles apart the conditions may be assumed to be nearly the same at the same time in ordinary calm weather. Two barometers are necessary for good work, the *office* barometer which is kept at the reference station, and the *field* barometer, which is carried from point to point. If the office barometer is an aneroid it must be standardized, that is, adjusted by the small screw at the back until it reads the same as a mercurial barometer. During the period of observations the office barometer and attached thermometer are read at regular intervals (about 15 or 30 minutes), so that by interpolation the readings are assumed to be known for any instant. The time and temperature are recorded whenever a field reading is taken, so that comparison may be made with the office readings for the same time. If the field barometer is an aneroid its readings will need correction for initial error and inertia. Before starting out to take readings with the field barometer it is compared with the office barometer and any difference is its *initial error*, which will affect all its readings to the same extent. On returning to the office after one or more observations the field barometer is again compared with the office one, and the amount by which the initial error has *changed* is called the *inertia error*; this error is distributed among the different readings in proportion to the elapsed time.

79. The Computations. The complete barometric formula (for which see Appendix No. 10, Report for 1881, U. S. Coast and Geodetic Survey) is very complicated and the smaller terms are generally omitted in ordinary work. Assuming all readings reduced to the standard of the office barometer,

Let H = elevation in feet of the office barometer above a plane corresponding to a barometric pressure of 30 inches for dry air at a temperature of 50° F.;

h = the same for the field barometer;

B = reading of office barometer in inches;

b = corrected reading of field barometer in inches;

t = Fahrenheit temperature at office barometer;

t' = Fahrenheit temperature at field barometer;

C = correction coefficient for mean temperature $\frac{t+t'}{2}$ for average conditions of humidity;

z = difference of elevation of the two barometers in feet;

then we have, nearly,

$$H = 62737 \log \frac{30}{B}, \quad h = 62737 \log \frac{30}{b},$$

and

$$z = (h - H) (1 + C),$$

in which H and h may be obtained from Table III, and C from Table IV opposite $(t + t')$.

Example. In the following table the field observations were taken with an aneroid and require the corrections described above.

FIELD NOTES AND REDUCTIONS, MAY 17, 1910.

Station.	Time.	Barom.	Temp.	Initial Corr.	Inertia Corr.	Thermom. Corr.
A	8.00 A.M.	29.124	73° F.	+0.040	+1°
B	11.10 A.M.	28.247	70° F.	+0.040	-0.006	+1°
C	1.30 P.M.	29.216	79° F.	+0.040	-0.011	+1°
A	4.00 P.M.	29.182	79° F.	+0.040	-0.016	+1°

OFFICE NOTES AND REDUCTIONS, MAY 17, 1910.

Station.	Office.		Field (reduced).		Diff. Elev.	Elevation.
	Barom.	Temp.	Barom.	Temp.		
A	29.164	74° F.	29.164	74° F.	1867 ft.
B	29.179	76° F.	29.281	71° F.	897	2764 ft.
C	29.189	73° F.	29.245	80° F.	-55	1812 ft.
A	29.206	80° F.	29.206	80° F.	1867 ft.

From Table III (by interpolation)

$$\begin{array}{rcl}
 b = 28.281, & h = 1607 & b = 29.245, & h = 694 \\
 B = 29.179, & H = 756 & B = 29.189, & H = 746 \\
 & \hline
 h - H = 851 & & h - H = -52 &
 \end{array}$$

From Table IV (by interpolation)

$$\begin{array}{rcl}
 147^\circ, C = +0.0544 & & 159^\circ, C = +0.0667 \\
 851 \times 0.0544 = 46 + & & -52 \times 0.0667 = -3 + \\
 851 + 46 = 897 & & -52 + (-3) = -55
 \end{array}$$

In this example the elevation of station A was known from previous determinations.

80. Accuracy of Barometric Work. For exploration, reconnaissance, and other classes of work where close results are not required, the barometer serves a very useful purpose. For stations only a few miles apart, or not differing much in altitude, the errors in the determinations may not exceed a few feet. For long distances or large differences in altitude the results are very disappointing, notwithstanding that the utmost refinements of theory and practice are employed, and daily readings averaged for a number of years. In general the values obtained in the heat of the day are too great, and in the morning and evening too small; and similarly too great in summer and too small in winter. Professor Whitney, in his *Barometric Hypsometry*, gives the results of three years' observations at Sacramento and Summit, California, from October, 1870, to October, 1873, in which the monthly average determinations of the difference of elevation

varied from 6900 to 7021 feet, the average for the three years being 6965 feet; according to railroad levelings the true difference is 6989 feet. Summit is about 77 miles from Sacramento in an air line; the altitude of Sacramento is about 30 feet above mean sea level. The example given is a fair illustration of the general experience in this class of work, with plus and minus errors about equal. The chief source of error in barometric work seems to be due to the lack of knowledge of the true average temperature of the air column between the levels of any two given stations, the mean of the station temperatures being only a fair approximation.

B. TRIGONOMETRIC LEVELING

81. Instruments and Methods. Trigonometric leveling can be done with any instrument capable of measuring angles of elevation and depression, but good work can be done only when the angles can be measured with precision. While the ordinary surveyor's transit may read vertical angles only to the nearest minute, a fine altazimuth instrument may be provided with micrometer microscopes reading such angles to single seconds. In round numbers a minute of arc corresponds to a foot and a half per mile, and a second to three-tenths of an inch; with moderate sized vertical angles, such as would usually occur in trigonometric leveling, the resulting effect in altitude is practically the same. It is presumed that the observer understands how to adjust and use his particular instrument to the best advantage.

The elevation of a station from which the open sea is visible can be determined by measuring the angle of depression to the sea horizon. The difference of elevation of two stations whose distance apart is known can be determined by measuring the angular elevation of *one* of them as seen from the other, constituting an "observation at one station," or by measuring the angular elevation of *each* station as seen from the other, constituting "reciprocal observations." From the nature of the case the effects of curvature and refraction are necessarily involved in any form of trigonometric leveling. The best results are obtained between 9.00 A.M. and 3.30 P.M., during which time the refraction has its least value and is comparatively stationary.

82. By the Sea Horizon Method. If a station is so situated as to command a view of the open sea its elevation above the surface of the water may be determined by measuring the angle of depression to the sea horizon. The advantage of this method lies in the fact that no distance is required to be known. Fig. 40

represents the vertical plane of the measured angle, in which A is the station whose elevation is desired; SS is an elliptic arc at the level of the sea horizon, but it is here assumed to be the arc of a circle; AE is a straight line from A tangent to the arc SS at the point E or true sea horizon; BC (on the vertical line AC) is the radius of the arc SS , and is assumed to be equal to the mean-sea-level radius of the section for the point A , the point C being in general not at the center of the earth. E' is the false horizon caused by the refraction of light; δ is the apparent and C the true angle of depression to the sea horizon; and BD is a tangent at B . From well known geometrical principles the angles GAD , ADB , and BCE are equal, and the line DC bisects the angle at C .

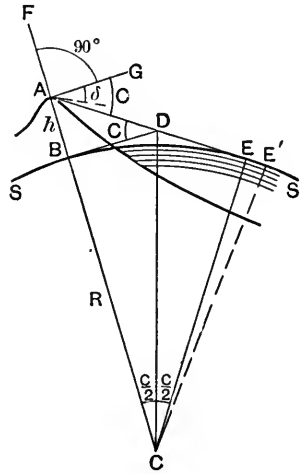

FIG. 40.

Let $R = BC$ = the mean-sea-level radius of the section for the point A ;

- C = the true angle of depression = angle at center;
- δ = the apparent angle of depression;
- $Z = 90^\circ + \delta$ = apparent zenith distance of sea horizon;
- m = coefficient of refraction;
- $h = AB$ = elevation of station A above surface of sea;

then from the figure we have

$$h = BD \tan C,$$

$$BD = R \tan \frac{C}{2};$$

$$h = R \tan \frac{C}{2} \tan C;$$

or since C is always a small angle (rarely $60'$),

$$h = \frac{R}{2} C^2 \tan^2 1''.$$

On account of refraction (Art. 14) the observer does not sight along the true line AE , but in the direction of the dotted line from A , which is tangent to a curved line of sight from A to the false horizon E' . The practical result of the refraction is to make the measured angle δ too small by the amount mC , so that

$$\delta = C - mC,$$

$$C = \frac{\delta}{1-m},$$

and

$$h = \frac{R}{2} \left(\frac{\delta}{1-m} \right)^2 \tan^2 1'',$$

whence by transposition

$$h = \delta^2 \left(\frac{\tan^2 1''}{2(1-m)^2} \right) R = (Z - 90^\circ)^2 \left(\frac{\tan^2 1''}{2(1-m)^2} \right) R,$$

in which h and r must be taken in the same unit, and δ must be taken in seconds. By many experiments the mean value of m on the New England coast has been found to be 0.078. If we use this value we may write

$$\log \left(\frac{\tan^2 1''}{2(1-m)^2} \right) = 9.1406579 - 20.$$

In order to secure the best results it is necessary to measure the azimuth of the plane in which the angle of depression is taken, and use the mean-sea-level value of R for this azimuth and the latitude of the station. This value may be taken from Tables V and VI, or computed as explained in Art. 69. If errors which may range up to say about 1 in 300 are not objectionable, we may use a mean value of R and write

$$\log \left[\left(\frac{\tan^2 1''}{2(1-m)^2} \right) R \right] = \left\{ \begin{array}{l} \text{metric, } 5.9446244 - 10 \\ \text{feet, } 6.4606086 - 10 \end{array} \right\} \text{ (approximate),}$$

or

$$h = \begin{cases} \text{metric, } 0.000088 \delta^2 \\ \text{feet, } 0.000289 \delta^2 \end{cases} \text{ (approximate),}$$

in which δ must be taken in seconds of arc.

83. By an Observation at One Station. When the distance between two stations is known their difference of elevation can be computed if the vertical angle of either as seen from the other is measured. The advantage of this method over the reciprocal method (Art. 84) lies in the economies due to occupying only one station, but the results are not likely to be so good on account of the uncertainty in the assumed value for the

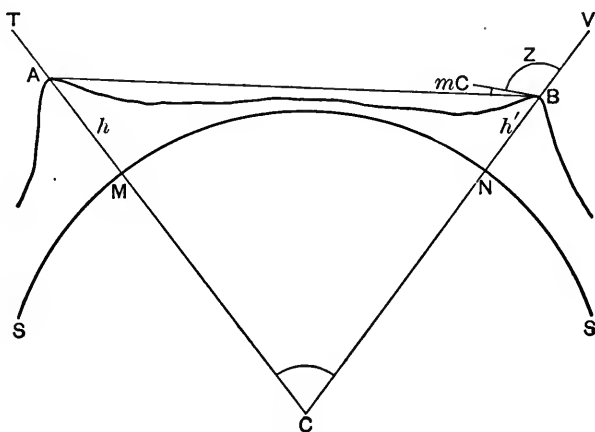

FIG. 41.

coefficient of refraction. Fig. 41 represents a plane through the two stations A and B , taken vertical at their middle latitude, and assumed to be vertical at both stations; SS is the elliptic arc cut from the spheroid, but it is here assumed to be the arc of a circle; the radius of the arc SS is taken as the mean-sea-level radius of the section at the middle latitude, the center C being in general not at the center of the earth; AC and BC are drawn to the center C and assumed to be vertical; Z is the apparent zenith distance of A as seen from B , and is in error by the small angle mC due to refraction.

- Let $h = AM =$ elevation of station A above mean sea level;
 $h' = BN =$ elevation of station B above mean sea level;
 $K = MN =$ mean-sea-level distance between stations
 A and B ;
 $R = MC =$ mean-sea-level radius of section at middle
latitude between A and B .
 $C =$ central angle ACB ;
 $Z =$ apparent zenith distance of A as seen from B ;
 $\alpha = 90^\circ - Z =$ apparent elevation of A as seen from B ;
 $mC =$ elevation of line of sight due to refraction:

then

$$\frac{AC + BC}{AC - BC} = \frac{2R + h + h'}{h - h'} = \frac{\tan \frac{1}{2}(ABC + BAC)}{\tan \frac{1}{2}(ABC - BAC)},$$

$$ABC + BAC = 180^\circ - C,$$

$$\tan \frac{1}{2}(ABC + BAC) = \tan \left(90^\circ - \frac{C}{2} \right) = \cot \frac{C}{2}.$$

$$ABC = 180^\circ - Z - mC$$

$$\frac{BAC}{ABC - BAC} = \frac{Z + mC - C}{180^\circ - 2Z - 2mC + C}$$

$$\frac{1}{2}(ABC - BAC) = 90^\circ - \left(Z + mC - \frac{C}{2} \right),$$

$$\tan \frac{1}{2}(ABC - BAC) = \cot \left(Z + mC - \frac{C}{2} \right).$$

$$\frac{2R + h + h'}{h - h'} = \frac{\cot \frac{C}{2}}{\cot \left(Z + mC - \frac{C}{2} \right)} = \frac{1}{\tan \frac{C}{2} \cot \left(Z + mC - \frac{C}{2} \right)},$$

$$h - h' = (2R + h + h') \tan \frac{C}{2} \cot \left(Z + mC - \frac{C}{2} \right).$$

Expanding $\tan \frac{C}{2}$ in series, we have

$$\tan \frac{C}{2} = \frac{C}{2} + \frac{C^3}{24} + \dots$$

But C (in arc) = $\frac{K}{R}$,

whence

$$\tan \frac{C}{2} = \frac{K}{2R} + \frac{K^3}{24R^3} + \dots$$

Hence by substitution and reduction and the omission of an inappreciable factor, we have

$$h - h' = K \cot \left(Z + mC - \frac{C}{2} \right) \left(1 + \frac{h + h'}{2R} + \frac{K^2}{12R^2} \right).$$

Also

$$C$$
 (in seconds) = $\frac{K}{R \sin 1''}$,

whence

$$\begin{aligned} h - h' &= K \cot \left[Z + (m - \frac{1}{2}) \frac{K}{R \sin 1''} \right] \left(1 + \frac{h + h'}{2R} + \frac{K^2}{12R^2} \right) \\ &= K \tan \left[\alpha + (\frac{1}{2} - m) \frac{K}{R \sin 1''} \right] \left(1 + \frac{h + h'}{2R} + \frac{K^2}{12R^2} \right), \end{aligned}$$

or approximately (error seldom over 1 in 3000)

$$\begin{aligned} h - h' &= K \cot \left[Z + (m - \frac{1}{2}) \frac{K}{R \sin 1''} \right] \quad (\text{approximate}), \\ &= K \tan \left[\alpha + (\frac{1}{2} - m) \frac{K}{R \sin 1''} \right] \quad (\text{approximate}). \end{aligned}$$

The value of $(h - h')$ is always found first by the approximate formula, after which a closer value may be obtained from the complete formula if so desired. In these formulas h , h' , K , and R must all be in the same unit. The coefficient of refraction m will average about 0.070 inland, and about 0.078 on the coast. The radius R is to be taken for the middle latitude of A and B and the approximate azimuth of the line joining them; this value may be taken from Tables V and VI, or computed as explained in Art. 69. If errors which may reach or possibly exceed about 1 in 500 are permissible we may use a mean value of R and write

$$\log R = \left\{ \begin{array}{l} \text{metric, } 6.8039665 \\ \text{feet, } 7.3199507 \end{array} \right\} \text{mean value.}$$

84. By Reciprocal Observations. When the distance between two stations is known their difference of elevation can be computed without assuming any particular value for the coefficient of refraction if the vertical angle of each station as seen from the other is measured. This result is brought about by assuming that the refraction is the same at each station, which is probably very nearly true if the observations are made at the same time on a calm day, although this is not always done. The advantage of this method over the single observation method (Art. 83) lies in the increased accuracy of the results. Fig. 42 (as in Fig. 41, Art. 83) represents a plane through the two stations A and B , taken vertical at their middle latitude and assumed to be

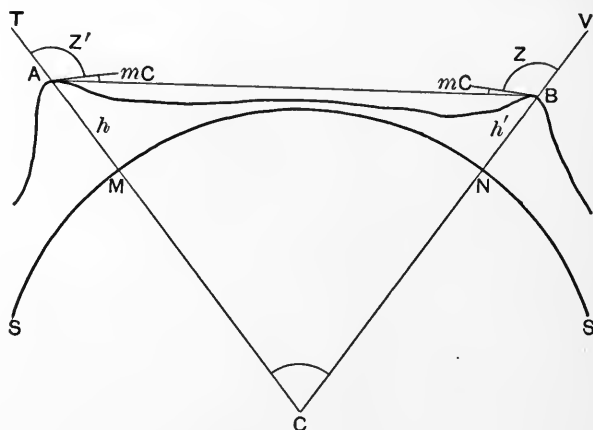

FIG. 42.

vertical at both stations; SS is the elliptic arc cut from the spheroid, but it is here assumed to be the arc of a circle; the radius of the arc SS is taken as the mean-sea-level radius of the section at the middle latitude, the center C being in general not at the center of the earth; AC and BC are drawn to the center C and assumed to be vertical; Z and Z' are the apparent zenith distances of the stations as seen from each other, each angle being assumed equally in error by the small angle mC due to refraction.

Let $h = AM =$ elevation of station A above mean sea level;
 $h' = BN =$ elevation of station B above mean sea level;

$K = MN$ = mean-sea-level distance between stations A and B ;

$R = MC$ = mean-sea-level radius of section at middle latitude between A and B ;

C = central angle ACB ;

Z = apparent zenith distance of A as seen from B ;

Z' = apparent zenith distance of B as seen from A ;

$\alpha = 90^\circ - Z$ = apparent elevation of A as seen from B ;

$\alpha' = 90^\circ - Z'$ = apparent elevation of B as seen from A ;

mC = elevation of lines of sight due to refraction;

then,

$$\frac{AC + BC}{AC - BC} = \frac{2R + h + h'}{h - h'} = \frac{\tan \frac{1}{2}(ABC + BAC)}{\tan \frac{1}{2}(ABC - BAC)},$$

$$ABC + BAC = 180^\circ - C,$$

$$\tan \frac{1}{2}(ABC + BAC) = \tan \left(90^\circ - \frac{C}{2} \right) = \cot \frac{C}{2},$$

$$ABC = 180^\circ - Z - mC$$

$$\frac{BAC = 180^\circ - Z' - mC}{ABC - BAC = Z' - Z}$$

$$\tan \frac{1}{2}(ABC - BAC) = \tan \frac{1}{2}(Z' - Z),$$

$$\frac{2R + h + h'}{h - h'} = \frac{\cot \frac{C}{2}}{\tan \frac{1}{2}(Z' - Z)} = \frac{1}{\tan \frac{C}{2} \tan \frac{1}{2}(Z' - Z)},$$

$$h - h' = (2R + h + h') \tan \frac{C}{2} \tan \frac{1}{2}(Z' - Z).$$

Expanding $\tan \frac{C}{2}$ in series, we have

$$\tan \frac{C}{2} = \frac{C}{2} + \frac{C^3}{24} + \dots$$

But

$$C \text{ (in arc)} = \frac{K}{R},$$

whence

$$\tan \frac{C}{2} = \frac{K}{2R} + \frac{K^3}{24R^3} + \dots$$

Hence by substitution and reduction and the omission of an inappreciable factor, we have,

$$\begin{aligned} h - h' &= K \tan \frac{1}{2} (Z' - Z) \left(1 + \frac{h + h'}{2R} + \frac{K^2}{12R^2} \right) \\ &= K \tan \frac{1}{2} (\alpha - \alpha') \left(1 + \frac{h + h'}{2R} + \frac{K^2}{12R^2} \right), \end{aligned}$$

or approximately (error seldom over 1 in 3000)

$$\begin{aligned} h - h' &= K \tan \frac{1}{2} (Z' - Z) \quad (\text{approximate}), \\ &= K \tan \frac{1}{2} (\alpha - \alpha') \quad (\text{approximate}). \end{aligned}$$

The value of $(h - h')$ is always found first by the approximate formula, after which a closer value may be obtained from the complete formula if so desired. In these formulas h , h' , K , and R must all be in the same unit. Except for very important work the mean value of R as given in Art. 83 is sufficiently precise. For very exact results the radius R is to be taken for the middle latitude of A and B and the approximate azimuth of the line joining them; this value may be taken from Tables V and VI, or computed as explained in Art. 69.

85. Coefficient of Refraction. If the distance between two stations is known, the coefficient of refraction m , may be obtained as follows:

1st. If the angular elevation of either station as seen from the other is measured, and the difference of elevation is obtained by spirit leveling, we have from Art. 83,

$$\begin{aligned} h - h' &= K \cot \left[Z + (m - \frac{1}{2}) \frac{K}{R \sin 1''} \right] \left(1 + \frac{h + h'}{2R} + \frac{K^2}{12R^2} \right) \\ &= K \tan \left[\alpha + (\frac{1}{2} - m) \frac{K}{R \sin 1''} \right] \left(1 + \frac{h + h'}{2R} + \frac{K^2}{12R^2} \right), \end{aligned}$$

in either of which expressions it is only necessary to substitute the known values and solve for m . The exact value of R is to be used, as explained in Art. 83.

2nd. If the angular elevation of each station as seen from the other is measured, we have from Fig. 42, page 136,

$$Z + mC - C = 180^\circ - Z' - mC;$$

whence $2mC = 180^\circ - Z - Z' + C$,

and $m = \frac{180^\circ - Z - Z' + C}{2C} = \frac{\alpha + \alpha' + C}{2C}$,

in which all the angular values must be expressed in the same unit (degrees, minutes, or seconds). From Art. 83 we have

$$C \text{ (in seconds)} = \frac{K}{R \sin 1''},$$

in which K and R must be in the same unit.

The average value of the coefficient of refraction from many Coast Survey observations (Appendix No. 9, Report for 1882), is as follows:

Across parts of the sea near the coast	0.078
Between primary stations	0.071
In the interior of the country	0.065

86. Accuracy of Trigonometric Leveling. The U. S. Coast and Geodetic Survey has done a large amount of leveling of this class in connection with its triangulation work, with sights sometimes exceeding a hundred miles in length in mountainous regions. The best results are obtained by reciprocal observations, taken on a number of different days so as to average up the atmospheric conditions. When the work is conducted in this manner on lines not over about 20 miles in length the probable error may be kept down to about one inch per mile. When the lines exceed about 20 miles in length it is necessary to take a great many observations under especially favorable conditions to secure good results. In order to prevent an accumulation of errors in the elevations determined by trigonometric leveling, connection is made at various points with precise-level bench marks, and the trigonometric leveling is adjusted to fit the precise leveling between these points.

C. PRECISE SPIRIT LEVELING.

87. Instrumental Features. The instruments used for precise leveling are the same in principle as the various types of engineers' levels, the essential feature being a telescopic line of sight and a spirit level (detachable or fixed) to determine its horizontality. Engineers' levels are designed to be as rapid and convenient in use as possible, consistent with the requirements of engineering work. Precise levels are designed to attain the highest possible

degree of precision in the work which is done with them. Such instruments are made in various forms, two of which are shown in Figs. 43 and 44 and described in Arts. 89 and 90. Certain features are more or less common to all types of precise level. A rigid construction and the highest grade of material and workmanship are demanded. Especial care is taken to make the line of collimation true for all distances. The telescope is made inverting (the increased illumination permitting a higher magnifying power), and has three horizontal hairs (as equally spaced as possible) whose mean position determines the line of sight. The convenience of having the line of sight at right angles to the vertical axis of the instrument is abandoned in order to place a delicate control of the position of the bubble in the hands of the observer; this is accomplished by pivoting the telescope near the object-glass end, and providing a fine screw motion near the eyepiece end, so that the inclination of the telescope can be changed as desired. Such a screw is commonly called a micrometer screw because it was originally provided with a graduated head for measuring the value of small changes of inclination. The level vial is placed above the telescope, and a mirror or other means provided to enable the observer to see the bubble at the moment of taking an observation. A sensitive bubble is used, one division corresponding to about 1 to 3 seconds of arc (against about 20 seconds in the ordinary wye or dumpy level). The level vial is chambered, permitting the observer to adjust the bubble to its most efficient length, and is so mounted that it is free to expand and contract. The instrument is supported on three pointed leveling screws resting freely in V-shaped metal grooves on the tripod head. Such an instrument is leveled by setting the bubble parallel to a pair of leveling screws and bringing it to the center by turning that pair of screws equally in opposite directions, then turning the bubble in line with the remaining leveling screw and bringing it to the center with that screw alone; then turn the instrument 180° on its vertical axis, and if the bubble moves from the center bring it half way back by the micrometer screw of the telescope and relevel both ways as before; when the bubble will stay within a few divisions of the center all the way around the leveling is satisfactory, as the precise leveling of the line of sight is accomplished with the micrometer screw while taking the observation.

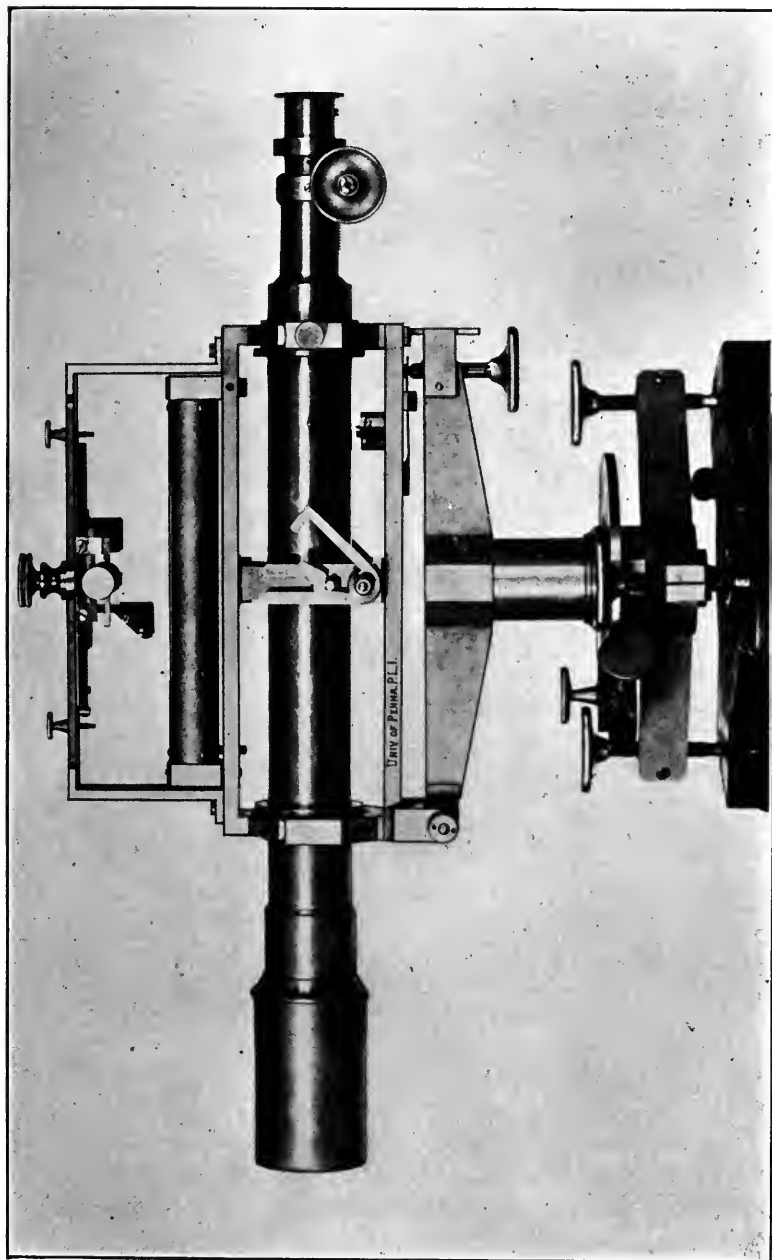

FIG. 43. The European Type of Precise Level.

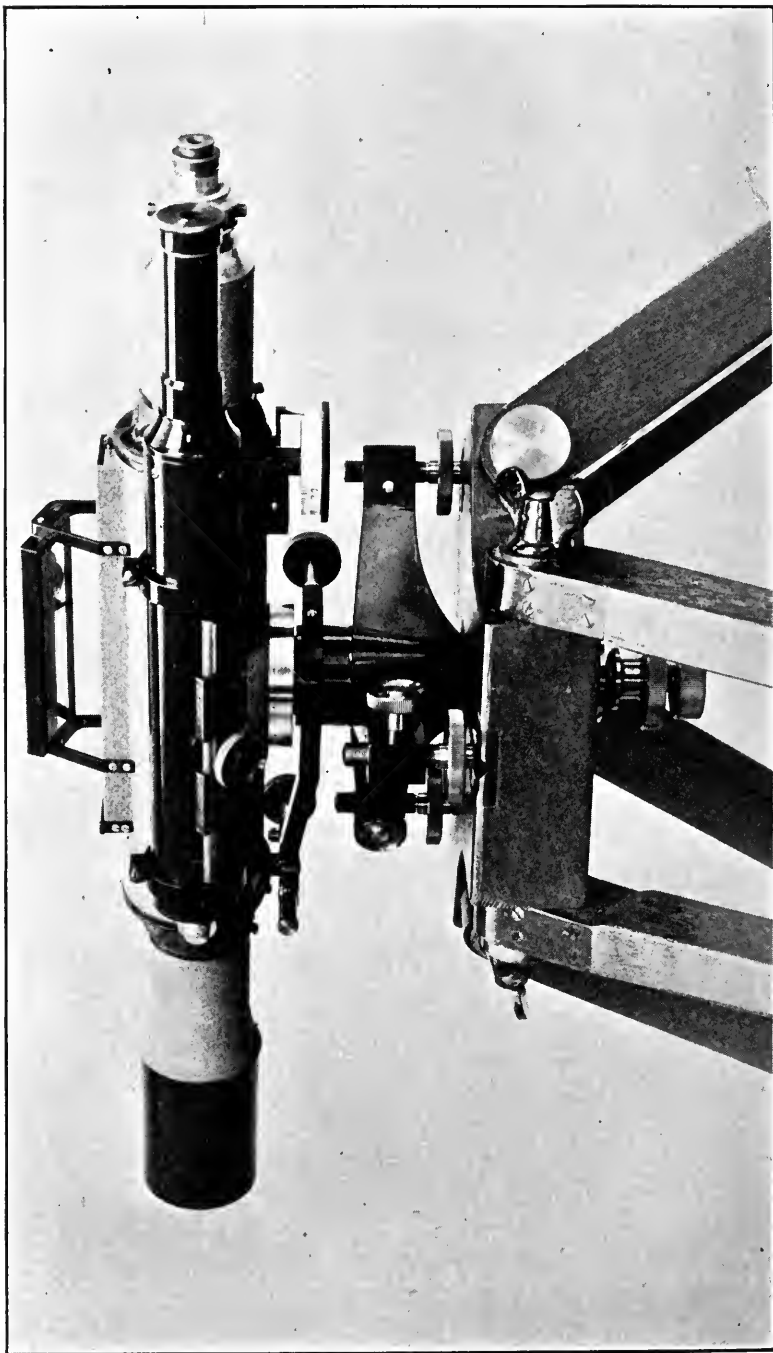

FIG. 44.—Coast Survey Precise Level.
From a photograph loaned by the U. S. C. and G. S.

The tripods used with these instruments must be strong and rigid. Rods of special pattern and metallic turning points, as described in Art. 91, are used in this class of work.

88. General Field Methods. In order to secure a high degree of precision in leveling the greatest care is required in the field work and methods. Five sources of error have to be guarded against, namely, errors of observation, instrumental errors, curvature and refraction errors, atmospheric errors, and errors from unstable supports.

Errors of observation are kept as small as possible by care on the part of the observer; by keeping the rods plumb; by using a proper length of sight, 100 meters or about 300 feet being suitable for average conditions; by comparing at every sight the two intervals furnished by the readings of the three wires, any material disagreement (more than 2 millimeters) denoting an erroneous reading; by the fact that each pointing is taken as the mean of the three wire readings; and by the further fact that every line is run in duplicate in the reverse direction and a limit set on the allowable discrepancies.

Instrumental errors are kept as small as possible by keeping the instrument in good adjustment; by determining the instrumental constants with care and applying the corresponding corrections when necessary; by using a program of observations adapted to the type of instrument used, so as to eliminate the instrumental errors as far as possible; by making the length of each foresight nearly equal, if possible, to that of the corresponding backsight; by balancing any extra long or short foresight by a similar long or short backsight elsewhere, and vice versa; and by keeping the sum of the lengths of the foresights as nearly equal as possible to the sum of the lengths of the backsights, with suitable corrections for the net difference. If the foresights and backsights were all exactly equal no correction would be required for instrumental errors. The effect of the various instrumental errors is to give the line of sight an inclination with the horizontal. The value of the inclination becomes known through the instrumental constants, as explained later. The required correction in elevation is found by multiplying the net difference in length of sights by the sine of this inclination.

Curvature and refraction errors exist in every line of sight,

as explained in Art. 14, but are obviously eliminated if the foresights and backsights are kept equal. If these sights are kept nearly balanced, as explained in the previous paragraph, and a suitable correction made for the net difference, the effects of curvature and ordinary refraction are practically reduced to zero. The correction which is made is the value of the curvature and refraction for the net difference in the lengths of the foresights and backsights. The net difference should be kept so small that no such correction may be necessary, but if required it can be taken from Table VII or computed as explained in Art. 14.

Atmospheric errors are those due to an *actual* unsteadiness of the rod or instrument, caused by the wind; an *apparent* unsteadiness of the rod, caused by heated air currents, commonly called heat radiation; an irregular vertical displacement of the line of sight, caused by variable refraction; and the disturbance of the relation between the line of sight and the axis of the bubble, caused by unequal expansion and contraction of the different parts of the instrument. Moderate winds do not prevent good work, especially if wind shields are used around the instrument; but when the wind reaches about eight miles an hour it becomes impracticable to do first class work. When the rod becomes unsteady through heat radiation it becomes necessary to decrease the length of the sights in order to read the rod satisfactorily, but the increased number of sights increases the probable error of the result; if it becomes necessary to decrease the length of sight below 50 meters, or about 150 feet, it is not advisable to continue the work. Refraction is nearly stationary and has its least value between about 9.00 A.M. and 3.30 P.M., but during this period heat radiation is apt to be very troublesome; outside of these hours the refraction may be very variable. The result is that in perfectly clear weather the best class of work is only possible during a few hours of the day. In order to guard against unequal expansion and contraction the instrument is protected with a large sunshade (umbrella), and never exposed to the direct rays of the sun either while in use or while being carried to a new set-up.

By the *errors from unstable supports* are meant the errors caused by the instrument or turning points changing their elevations slightly between readings. It is shown by experience that

either rising or settling may take place, though settling is the most common. If the instrument settles between the backward reading and the forward reading the final elevation will be too high; the same result will occur if the rod settles between the forward reading and the backward reading on it. Errors of this class are kept as small as possible by planting the instrument firmly; by using well driven metallic turning points; by taking both readings from each set-up with as little intermediate delay as possible, using two rodmen for this reason as well as the saving of time; by reading the back rod first for every other set-up, and the fore rod first for the intermediate set-ups; and by duplicating each line in the opposite direction, and correcting for half of the discrepancy.

Certain field methods have been discarded, after years of extensive use, because the results have not proven as satisfactory as by other methods. Among these may be mentioned methods involving computations based on readings of the micrometer screw. The best results are obtained when all the observations are taken with the bubble in the center, the micrometer screw being used simply as the means of keeping it there. Another unsatisfactory method is the running of so-called simultaneous lines, in which readings are taken at each set-up to the turning points of two separate lines, as a substitute for running duplicate lines in opposite directions.

89. The European Level. A typical leveling instrument of this form, made in France, is illustrated in Fig. 43 (page 141). The European type of instrument is essentially a wye level, in which different makers have followed the same general design, but with modified details. The telescope may be rotated in the wyes or lifted from the wyes and reversed. The level is separate from the instrument, being an ordinary striding level with the addition of a movable mirror over the bubble; by holding the eyes in a vertical line the image of the bubble may be seen with one eye while the rod is seen through the telescope with the other eye, the bubble being kept in the center with the micrometer screw while the observation is being made. The magnifying power is about forty-five diameters. Besides the above special features the instrument has all the general features of a good instrument, as described in Art. 87. With this type of level there are three so-called constants and two adjustments.

89a. Constants of European Level. The three constants of this instrument, which should be examined at least once a year, are as follows:

1. *The angular value of one division of the bubble*, meaning the change in inclination which causes the bubble to shift its position by one division on the bubble scale. Modern level vials are ground so nearly uniform in curvature that it is customary to measure the change of inclination for the whole run of the bubble, dividing by the number of divisions through which the bubble moves to obtain the average value of one division. By the position of the bubble, or the movement of the bubble, is meant the position or the movement of its central point; the ends of the bubble are constantly changing their position on account of the changing length of the bubble, but the center remains stationary as long as there is no change of inclination. Bubble tubes are sometimes graduated from one end, but more frequently both ways from the center, in which case the divisions one way from the center are called positive and the other way negative. The reading of the center of the bubble is the algebraic mean of its two end readings. The movement of the bubble between any two positions is the algebraic difference of its two center readings. The practical operation of finding the value of one division is as follows: Level up the instrument with the striding level in place, and have a leveling rod held at a fixed point at a known distance of about 200 feet. Turn the micrometer screw until the bubble comes near one end of its run, note each wire reading on the rod as closely as possible, and each end reading of the bubble to the nearest tenth of a division. Run the bubble to the other end of the tube and note the rod and bubble readings for this position. Take a number of readings in this way at both ends, with the bubble in slightly different positions so as to obtain unbiased values. Compute the position of the center of the bubble for each reading, then the average of the center readings for each end of the run, and then the movement corresponding to these average centers, which will be the average movement of the bubble. Subtract the mean of the lower readings from the mean of the upper readings on the rod for the average movement of the line of sight, which divided by the distance times the sine of $1''$ will give the average change of inclination in seconds of arc. The angular value of one division of the bubble in seconds will be this

average change of inclination divided by the average movement of the bubble. In this process the rod readings and the distances must be expressed in the same unit. In the following example illustrating the above principles the bubble tube is graduated each way from the center and a metric rod is held 70 meters from the instrument. Each recorded rod reading is the average of the three wire readings.

EXAMPLE.—ANGULAR VALUE OF ONE DIVISION OF BUBBLE TUBE

Looking Up.				Looking Down.			
Rod.	Bubble.			Rod.	Bubble.		
	Left.	Right.	Center.		Left.	Right.	Center.
1.5245	-36.9	+3.1	-16.9	1.5000	-1.5	+37.8	+18.2
1.5240	-36.1	+2.8	-16.7	1.5005	-1.7	+36.7	+17.5
1.5245	-36.0	+2.0	-17.0	1.5010	-2.0	+35.4	+16.7
1.5250	-35.6	+1.1	-17.3	1.5005	-1.4	+35.9	+17.2
1.5245	-35.8	+1.8	-17.0	1.5005	-1.5	+35.7	+17.1
7.6225	Sums		-84.9	7.5025	Sums		+86.7
1.5245	Means		-16.98	1.5005	Means		+17.34
$\sin 1'' = 0.000004848$ $70 \times \sin 1'' = 0.00033936$ $0.0240 \div 0.00033936 = 70''.72$ Change of inclination = $70''.72$				1.5245	Algebraic differences		-16.98
				0.0240			
				$70''.72 \div 34.32 = 2''.06$ Angular value of one division = $2''.1$			

2. *The inequality of the pivot rings*, meaning the angle between the line joining the tops of the pivot rings (the telescope collars that rest in the wyes) and the center line of these rings. This angle would of course be zero, if there were no inequality in the size of the rings; but a small angle generally exists, due usually to unequal wear. It follows that when the tops of the rings are in a level plane, as indicated by the striding level, the line of sight or center line of the rings must be inclined to the horizontal to the extent of this angle. In order to determine this value

the instrument is approximately leveled, and clamped on its vertical axis. Bubble readings are then taken with the telescope direct and also when reversed end for end in the wyes. If the striding level and telescope were reversed together (as one piece) the movement of the bubble would measure twice the angle between the axis of the bubble and the bottom line of the pivot rings. If the striding level were in perfect adjustment (axis of bubble parallel to line of feet) this would mean the same thing as twice the angle between the top line and bottom line of the rings, or four times the pivot inequality (angle between center line and tops of rings). The striding level is seldom in perfect adjustment, but its error is eliminated by taking its average reading for its direct and reversed positions for each position of the telescope. The telescope is generally reversed a number of times and the average result taken. It is found in practice that the inclination of the telescope is liable to be changing during the progress of the observations, and thus lead to erroneous conclusions. Readings are therefore not only taken for alternate positions of the telescope, but the last position is made the same as the first position; the assumption is then made that the mean of the direct sets and the mean of the reverse sets correspond to the same instant of time. When the pivot inequality is obtained in bubble divisions its angular value is found by multiplying this result by the angular value of one division of the bubble. In the following example illustrating the above principles the level tube is graduated both ways from the center, and is called direct with the marked end towards the eyepiece.

It will be noted in this example that the average effect of reversing the telescope (from eye-end left to eye-end right), is to cause the bubble to move to the right or towards the eye-end, showing the eye-end ring to be larger than the other ring which it replaces; when the tops of the rings are in a level plane, therefore, as indicated by the striding level, it follows that the line of sight (center line of the rings) must look up. If the telescope looks up it will cause the final elevation to be too low for an excess in the foresights and too high for an excess in the backsights, and vice versa when the telescope looks down. The amount of the correction required will be equal to the excess distance multiplied by the angular inequality of the pivots and by the sine of $1''$.

EXAMPLE.—INEQUALITY OF PIVOT RINGS

Telescope.	Level.	Bubble Readings.			
		Left.	Right.	Left.	Right.
Eye-end left	Direct	- 26.6	+ 23.7		
	Reversed	- 28.0	+ 22.4		
" right	Direct			-24.0	+ 26.5
	Reversed			-25.4	+ 25.0
" left	Direct	- 26.9	+ 23.8		
	Reversed	- 28.4	+ 22.4		
" right	Direct			-24.2	+ 26.8
	Reversed			-25.8	+ 25.2
" left	Direct	- 27.2	+ 24.1		
	Reversed	- 28.6	+ 22.8		
Sums		-165.7	+139.2	-99.4	+103.5
Means		- 27.62	+ 23.20	-24.85	+ 25.88
Center of bubble		- 2.21		+ 0.52	
Eye-end ring large		Bubble moves to right = 2.73 div.			
Telescope looks up		Inequality of pivots = -0.68 "			
0.68 × 2" . 1 = 1" . 428		Ang. inequality of pivots = -1" . 4			

3. *The angular value of the wire interval*, meaning the ratio between the solar focus or principal focal length of the objective and the distance between the outer cross-hairs. The telescope may be regarded as set for a solar focus when it is focussed on any distant object.

Let D = unknown distance between level rod and vertical axis of level;

S = corresponding rod intercept between outer cross-hairs;

d = a known distance from axis of level;

s = corresponding intercept;

f = distance from cross-hairs to objective for solar focus;

c = distance from vertical axis to objective for solar focus;

i = distance between outer cross-hairs;

$$A = \frac{f}{i} = \text{angular value of wire interval};$$

then, from the theory of stadia measurements,

$$A = \frac{f}{i} = \frac{d - (f + c)}{s},$$

$$D = A \cdot S + (f + c),$$

in which formulas D , S , d , s , f , and c must all be taken in the same unit. The field work of finding A consists in focussing on a distant point and measuring on the telescope the values of f and c ; then measure a distance of about 100 meters or about 300 feet from the vertical axis of the instrument, and take the rod readings at this point (with the instrument leveled) for the upper and lower hairs; the intercept s of the formula is the difference of these readings; then substitute the values d , s , f , and c in the formula for A . The value of A may run from about 100 to about 300, the instrument maker usually setting the hairs as near as possible for an even hundred. With the value of A known and the recorded rod readings a simple substitution in the formula for D at once gives the distance between the instrument and corresponding turning point. Since the corrections for instrumental errors are only applied to the excess distance between foresights and backsights, a running total is kept of the corresponding wire intervals, and the formula for D applied to this excess interval only, omitting the small constant $(f+c)$.

89b. Adjustments of European Level. The two adjustments of this instrument, which should be examined daily, are as follows:

1. *The collimation adjustment*, meaning the adjustment of the position of the ring that carries the cross-hairs so that the actual line of sight (as indicated by the mean position of the hairs) shall coincide with the true line of sight or center line of the rings. This adjustment is made by leveling up the instrument and sighting at a rod (about 100 meters distant) with the telescope both direct and inverted. If the mean of the three wire readings is not the same in each case the reticule is moved in the apparent direction needed to correct the error and an amount equal to half the discrepancy. It is essential that the instrument be perfectly leveled for each reading. When the discrepancy is brought down to about two millimeters it may be considered satisfactory, as it is easy to apply a correction for the residual

error, or the error may be eliminated by the method of observing. The collimation error is the angular amount by which the actual line of sight (determined by mean position of cross-hairs) deviates from the center line of the rings. The collimation error only affects the excess distance, like all the other instrumental errors.

- Let C = collimation correction for excess distance D ;
- D = excess distance between backsights and foresights;
- c = collimation error;
- d = a known distance;
- R_1 = mean rod reading for d with telescope normal;
- R_2 = mean rod reading for d with telescope inverted;

then evidently,

$$c = \frac{R_2 - R_1}{2d} \quad \text{and} \quad C = cD,$$

in which all values must be taken in the same unit.

2. *The bubble adjustment*, meaning the adjustment by which the axis of the bubble is made parallel to the line joining the feet of the striding level. This adjustment is made by leveling up the instrument, clamping the vertical axis, bringing the bubble exactly central with the micrometer screw, and then reversing the striding level without disturbing the telescope. If the bubble is not central after reversal it is to be adjusted for one-half of its movement. Relevel with the micrometer screw, reverse again, and so on until the adjustment is satisfactory (within about one division of the scale). The bubble error or inclination of the bubble is the angle between the axis of the bubble and the line joining the feet of the striding level; this angle would be zero if the bubble were in perfect adjustment. To determine the bubble error level up the instrument approximately, clamp the vertical axis, bring the bubble near the center with the micrometer screw, and then read the bubble a number of times in direct and reversed positions, making the last position the same as the first position. The bubble error in bubble divisions is half the average movement of the bubble; the inclination of the bubble is the error in bubble divisions multiplied by the angular value of one division. In the following example illustrating the above principles the level tube is graduated both ways from the center, and is called direct with the marked end towards the eyepiece.

EXAMPLE.—INCLINATION OF BUBBLE

	Striding Level.	Bubble.			
		Left.	Right.	Left.	Right.
Eyepiece to the left	Direct	-26.6	+23.7		
	Reversed			-23.0	+22.4
	Direct	-26.9	+23.8		
	Reversed			-28.4	+22.4
	Direct	-27.2	+24.1		
	Sums	-80.7	+71.6	-56.4	+44.8
	Means	-26.90	+23.87	-28.20	+22.40
	Center of bubble		-1.52		-2.90
	Level direct—Telescope looks down.		Bubble error= +0.69 division.		
	$0.69 \times 2'' .1 = 1'' .449$		Inclination of bubble= +1'' .4		

It will be noted in the above example that the average effect of reversing the striding level (putting marked end towards object glass) is to cause the bubble to move away from the marked end, showing that the marked end has the shorter leg; when the bubble is in the center, therefore, if the marked end of the striding level is nearest the eyepiece the telescope looks down. If a line of levels were run with the striding level in a fixed position a correction would be required for the excess distance, the value of which would equal the inclination of the bubble multiplied by the excess distance and the sine of 1''. The sign of the correction for excess of foresights would be positive for telescope looking up and negative looking down, and vice versa for excess of backsights.

89c. Use of European Level. The best results are obtained when all the rod readings are taken with the bubble precisely centered, and the observations so arranged as to eliminate as far as possible the effects of the instrumental errors. All the precautions of Art. 88 are to be carefully observed. Among these may be again mentioned the necessity of keeping the instrument sheltered by the umbrella from the sun and wind at all times; making each foresight approximately equal to the

previous backsight (pacing is satisfactory); keeping the sum of the foresights nearly equal to the sum of the backsights, as indicated by the corresponding sums of the wire intervals; planting the instrument firmly and making the turning points solid; keeping the rod plumb; watching the wire intervals at every sight, and taking a new reading of each of the three wires whenever the half intervals disagree by more than two millimeters; and running a duplicate line in the opposite direction as a check, and in order to eliminate errors from unstable supports (by using the mean difference of elevation as the true value).

Program of observations for each set-up. Level up the instrument; sight at the back rod; take each of the three wire readings with the bubble kept centered with the micrometer screw; sight on the forward rod and read with bubble central as before; remove striding level, invert telescope in wyes, replace striding level reversed end for end; read forward rod with bubble central; sight on back rod and read with bubble central. This method of observing eliminates both the bubble error and the collimation error, even with the foresights and backsights unbalanced. The correction for inequality of pivots, however, must be applied to any excess distance, as also the correction for curvature and refraction if the excess distance makes the amount appreciable. An example of notes and reductions is given on the next page. In this case the backsights are in excess, but not enough to require appreciable corrections.

90. The Coast Survey Level. Previous to 1900 the precise leveling of the U.S. Coast and Geodetic Survey was done with the European type of instrument. Commencing with the summer of 1900 this work has been done with a type of instrument designed by the Department and known as the Coast Survey level. A view of this level is shown in Fig. 44, page 142. The instrument is essentially a dumpy level, as the telescope does not rest in wyes, can not be removed from its supports, and can neither be inverted nor reversed. The base of the instrument is of the usual three leveling screw type, except that the center socket is unusually long and extends downwards through the tripod head. An outer protecting tube through which the telescope passes is rigidly attached to the vertical axis; the telescope is pivoted at one end of this outer tube, and has its inclination controlled by a micrometer screw at the other end. The collimation adjustment

FORM OF NOTES—EUROPEAN LEVEL

(Left-hand page.)

(Right-hand page.)

Forward Line. Backsights.					B. M. 4 to B. M. 5. Date, June 18, 1911.			
Point.	Rod. and Temp.	Thread Readings.			Mean.	Intervals.		Remarks.
		1	2	3		Each.	Sums.	
B. M. 4	2	2.518	2.616	2.714	2.6170	0.1950	0.1950	Elevation of B. M. 4=117.617 (Description of B. M. 4.)
	76	2.522	2.618	2.716				
	Means	2.5200	2.6170	2.7150				
T. P. 1	5	2.313	2.395	2.476	2.3967	0.1625	0.3575	
	78	2.318	2.398	2.480				
	Means	2.3155	2.3965	2.4780				
					+5.0137			
(Left-hand page.)					(Right-hand page.)			
Forward Line. Foresights.					B. M. 4 to B. M. 5. Date, June 18, 1911.			
Point.	Rod. and Temp.	Thread Readings.			Mean.	Intervals.		Remarks.
		1	2	3		Each.	Sums.	
T. P. 1	5	1.167	1.260	1.354	1.2635	0.1875	0.1875	(Description of B. M. 5.)
	77	1.173	1.266	1.361				
	Means	1.1700	1.2630	1.3575				
B. M. 5	2	0.720	0.800	0.880	0.8008	0.1585	0.3460	Elevation of B. M. 4=117.617 +2.949 B. M. 5=120.566
	78	0.723	0.802	0.880				
	Means	0.7215	0.8010	0.8800				
					-2.0643			
					+5.0137			
					+2.9494			
						0.3460		
						0.3575		
						0.0115		

is permanently fixed by the maker. The level tube is attached to the telescope, but has provision for adjustment. A strong point of the instrument is the closeness of the bubble to the line of sight, the level tube being let part way into a slot cut in the top of the telescope tube, the top of the level tube coming about flush with a slot in the top of the outer tube. The level vial is chambered for adjusting the length of the bubble. Attached to the left side of the instrument is a light auxiliary tube through

which the left eye may see an image of the bubble while the right eye is observing the rod, the head being held in its natural position, and the tube being adjustable sideways to suit the eyes of different observers. Besides the lens in its eyepiece the tube contains two prisms, adjustable for length of bubble, and placed opposite a slot running abreast of the level vial. The bubble is brought within the view of the left eye through the eye lens, the two prisms, and a mirror attached to the telescope. The telescope tube and outer casing are made of a nickel-iron alloy that has a coefficient of expansion which is only one-fourth that of brass, while the micrometer screw and other important screws are made of nickel-steel having a coefficient of expansion as low as 0.000001 per degree centigrade. A detailed description of this instrument (from which the above notes have been gathered) is given in Appendix No. 3, Report for 1903, U. S. Coast and Geodetic Survey. Work with this level has been extremely satisfactory, better results being secured with greater rapidity and a much reduced cost. The Coast Survey level has two constants and one adjustment.

90a. Constants of Coast Survey Level. The two constants of this instrument, which should be examined at least once a year, are as follows:

1. *The angular value of one division of the bubble.* This is found by the optical method, as described in Art. 89a.

2. *The angular value of the wire interval.* This is also found as described in Art. 89a.

90b. Adjustments of Coast Survey Level. The only adjustment of this instrument, which should be examined daily, is as follows:

To make the axis of the bubble parallel to the line of sight. This adjustment is made by the ordinary peg method (as adapted to this type of instrument), the bubble tube being raised or lowered at the adjusting end as may be required. The cross-hairs must never be disturbed as these have been permanently adjusted for collimation by the instrument maker. In testing the adjustment the rod reading is taken as the mean of the three wire readings, and the rod interval as the difference between the outside wire readings, the bubble being kept exactly centered while reading each of the three wires. Two pegs or turning-point pins are firmly driven about 100 meters apart, each rod being kept

on its own point if two rods are used, or one rod being shifted as required. The instrument is set up approximately in line with the two points, first about ten meters beyond one point, and then about the same distance beyond the other point. The rod reading is taken for each point in each position of the instrument, the terms *near rod* and *distant rod* being used to indicate the relative position of the rods for each set-up. Having taken the four readings we have

$$C = \frac{(\text{sum of near-rod readings}) - (\text{sum of distant-rod readings})}{(\text{sum of distant-rod intervals}) - (\text{sum of near-rod intervals})}$$

in which C is called the bubble error or constant for the day's work. If C does not exceed 0.010 (numerically) it is not advisable to change the adjustment. The telescope looks down when C is positive and up when C is negative, so that if an adjustment is found to be necessary the line of sight (middle wire) is raised or lowered on the distant rod by C times the corresponding interval, and the bubble tube adjusted to bring the bubble central. A new determination of C is always made after each adjustment, and in very precise work the distant-rod readings are corrected for curvature and refraction (Table VII) before using in the formula, as these errors double up instead of canceling out in this method of adjustment. A correction equal to C times the excess interval between the foresights and backsights is applied to the final elevation; if the backsights are in excess the correction has the same sign as C , and the opposite sign when the foresights are in excess.

90c. Use of Coast Survey Level. In order to obtain the best results with this instrument all the precautions given in Art. 88, and briefly summarized in Art. 89c, must be observed. The program of observations is much simpler than with the European level, there being nothing to do at each set-up except to obtain the three wire readings on each rod, with the bubble kept exactly centered while reading each wire. It is considered advisable to read the fore rod first on every other set-up. In the precise leveling of the U. S. Coast and Geodetic Survey a correction for excess of sights is applied for curvature and refraction and also for bubble error, together with corrections for absolute length of rod and average temperature of rod. An example illustrating the keeping of the notes is given on the next page.

FORM OF NOTES—COAST SURVEY LEVEL
(Left-hand page.) (Right-hand page.)

SPIRIT LEVELING.

Date: August 29, 1900. Sun: C. From B. M.: 68 To B. M.: G.
 Forward—~~Backward~~ Wind: S. T.

No. of Station.	Thread Reading Backsight.	Mean.	Thread Interval.	Sum of Intervals.	Rod and T. m.	Thread Reading Foresight.	Mean.	Thread Interval.	Sum of Intervals.
43	0674 0773 0872	0773.0	99 99 198		V 33	2683 2782 2882	2782.3	99 100 199	
44	0925 1031 1135	1030.3	106 104 210	408	W 35	2415 2518 2621	2518.0	103 103 206	405
45	0484 0582 0681	0582.3	98 99 197	605	V 35	2510 2606 2702	2606.0	96 96 192	597
46	0398 0495 0592	0495.0	97 97 194	799	W 34	2857 2955 3050	2954.7	96 95 191	788
47	1027 1053 1080	1053.3 3933.9	26 27 53	852	V 34	1006 1063	1034.7 11895.7 -7961.8	29 28 57	845
								2:25 p.m.	

The above example is taken from Appendix No. 3, Report for 1903, U. S. Coast and Geodetic Survey. The unit of the record is the millimeter. C. means cloudy, S. means south, and T. means running within 45° of directly towards the wind.

91. Rods and Turning Points. Various types of rods and turning points have been used in precise level work, with details changing from time to time. The notes here given are intended to briefly cover the points of interest to engineers.

Rods. Precise leveling rods are now generally made of wood, sometimes soaked in melted paraffin to eliminate changes of length by absorption of atmospheric moisture, cross or T-shaped in section, about 3.5 meters in length, graduated metrically, provided with a plumb line or level, and designed to be used without targets. The Coast Survey rod is cross-shaped in section, of pine wood which has absorbed about 20 per cent of its original weight of paraffin, graduated to centimeters and read by estimation to millimeters, and provided with a circular level for making it vertical. Target rods were abandoned by the Coast Survey in 1899. For a description of Coast Survey rods see Appendix No. 8, Report for 1895, and Appendix No. 8, Report for 1900. The precise rods used by the Corps of Engineers, U. S. A., are similar to the above, but T-shaped in cross-section. The Molitor rod (designed by Mr. David S. Molitor, and described in Trans. Am. Soc. C.E., Vol. XLV, page 12) is illustrated in Fig. 45, and is a precise rod of the highest class. The smallest divisions are two millimeters wide, and the reading is taken to millimeters or closer by estimation.

Rod constant and adjustment. The precise leveling rod has one constant, and one adjustment. *The rod constant* is its absolute length between extreme divisions, which may differ slightly from its designated length, and which should be examined at least once a year. If the rod is long or short a self-evident correction is required, which only affects the final difference of elevation between two points. *The rod adjustment* is the adjustment of its level, which should be examined daily by making the rod vertical with a plumb line, and corrected if necessary.

Turning points. Both foot-plates and foot-pins have been used for turning points. Cast iron foot-plates about six inches in diameter have been used extensively by the Coast Survey, but were practically abandoned in 1903 as inferior to pins. Fig. 45 shows a style of foot-pin first used by Prof. J. B. Johnson in 1881, and meeting every requirement of a good pin. It is driven nearly flush with the ground with a wooden mallet. Such a pin is

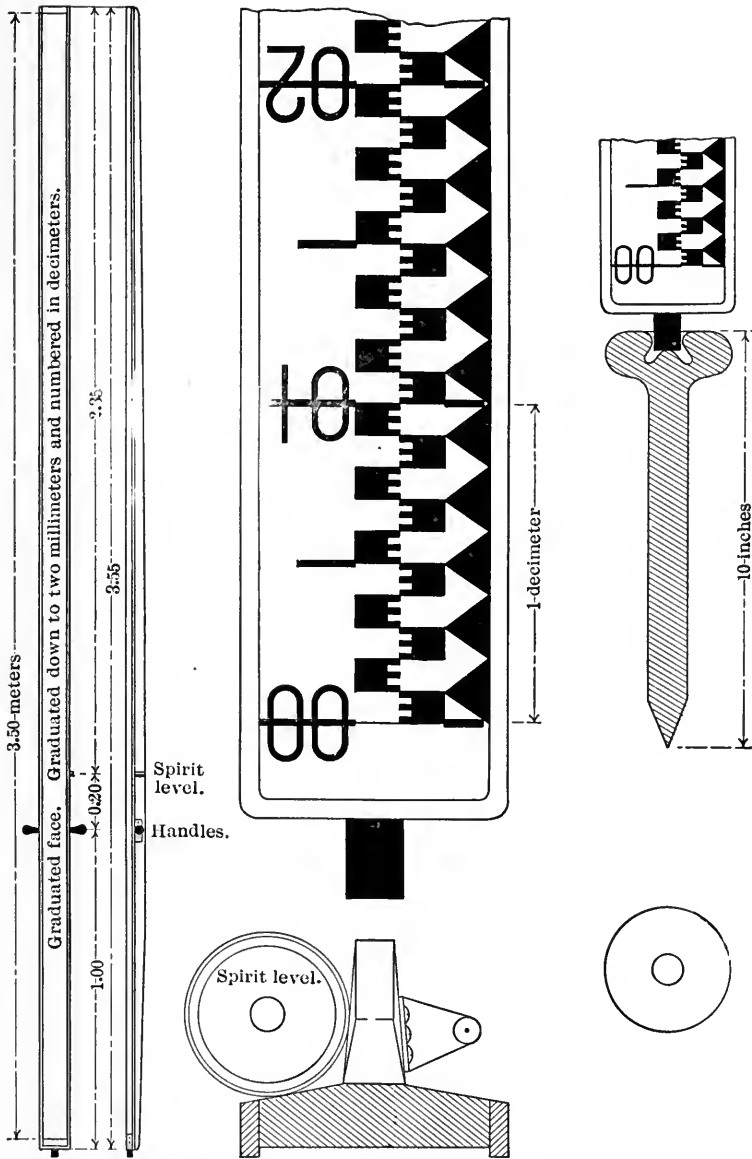

FIG. 45.—Molitor's Precise-level Rod and Johnson's Foot-pin.

best made of steel. The little groove in the head is to prevent dust or sand from settling on the bearing point.

92. Adjustment of Level Work. In running level lines of any importance the work is always arranged so as to furnish a check on itself, or to connect with other systems, and a corresponding adjustment is required to eliminate the discrepancies which appear. The problem may always be solved by the method of least squares when definite weights have been assigned to the various lines. When the work is all of the same grade the lines are weighted inversely as their length. This rule requires an error to be distributed uniformly along any given line to adjust the intermediate points. A common rule for intermediate points on a line or circuit is to distribute the error as the square root of the various lengths; but as this rule is inconsistent with itself it is not recommended. The following rules for the adjustment of level work will usually be found sufficient and satisfactory.

Duplicate lines. A duplicate line is understood to mean a line run over the same route, but in the opposite direction and with different turning points. This is the best way of checking a single line of levels. The discrepancy which usually appears is divided equally between the two lines.

Simultaneous lines. These are lines run over the same route in the same direction, but with different turning points. In this case the final elevation is taken as the mean of the elevations given by the different lines.

Multiple lines. This is understood to mean two or more lines run between two points by different routes. In this case the difference of elevation as given by each line is weighted inversely as the length of that line, and the weighted arithmetic mean is taken as the most probable difference of elevation. Thus if the difference of elevation between A and B is 9.811 by a 6-mile line, 9.802 by an 8-mile line, and 9.840 by a 12-mile line, we have

Mean difference of elevation

$$= \frac{(9.811 \times \frac{1}{6}) + (9.802 \times \frac{1}{8}) + (9.840 \times \frac{1}{12})}{\frac{1}{6} + \frac{1}{8} + \frac{1}{12}} = 9.814.$$

Intermediate points. These may occur on a line whose ends have been satisfactorily adjusted or on a closed circuit. In either case the required adjustment is distributed uniformly throughout the line, making the correction between any two

points directly proportional to the length between those two points.

Level nets. Any combination of level lines forming a series of closed circuits is called a polygonal system or level net. Fig. 46 represents such a system. If the true difference of elevation were known from point to point, then the algebraic sum of the differences in any closed circuit would always equal zero, the rise and fall balancing. In practical work the various circuits seldom add up to zero, and an adjustment has to be made to eliminate the discrepancies. A rigorous adjustment requires the use of the method of least squares, but the approximate adjustment here described will generally give very nearly the same results. Pick out the circuit which shows the largest discrepancy, and distribute the error among the different lines in direct proportion to their length. Take the circuit showing the next largest discrepancy, and distribute its error uniformly among any of its lines not previously adjusted in some other circuit, continuing in this way until all the circuits have been adjusted. The circuits here intended are the single closed figures, as *BEFC*, and not such a circuit as *ABEFCA*; and no attention is to be paid to the direction or combination in which the lines may have been run.

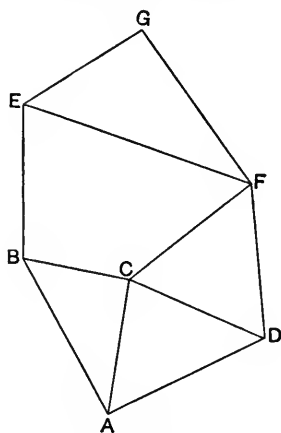

FIG. 46.

93. Accuracy of Precise Spirit Leveling. The accuracy attainable in precise spirit leveling may be judged by noting the discrepancies between duplicate lines (Art. 92). On the U. S. Coast and Geodetic Survey the limit of discrepancy allowed between duplicate lines is $4\text{mm} \cdot \sqrt{K}$, meaning 4 millimeters multiplied by the square root of the distance in kilometers between the ends of the lines; if this limit is exceeded the line must be rerun both ways until two results are obtained which fall within the specified limits. In various important surveys the allowable limit has ranged from $5\text{mm} \cdot \sqrt{K}$ to $10\text{mm} \cdot \sqrt{K}$, or $0.021\text{ft} \cdot \sqrt{M}$ to $0.042\text{ft} \cdot \sqrt{M}$ where M is the distance in miles. The probable error of the mean result of a pair of duplicate lines is practically

one-third of the discrepancy, and in actual work of the highest grade falls below $1\text{mm.}\sqrt{K}$. The adjusted value of the elevation above mean sea level of Coast Survey bench mark *K* in St. Louis has a probable error of only 32 millimeters or about $1\frac{1}{4}$ inches, and it is almost certain that no amount of leveling will ever change the adopted elevation as much as 6 inches.

A much more severe test of the accuracy of leveling is obtained from the closures of large circuits running up sometimes to 1000 or more miles in circumference. The greatest error indicated by the circuit closures in any line in about 20,000 miles of precise spirit leveling executed by the U. S. Coast and Geodetic Survey and other organizations, is about one-tenth of an inch per mile. With the Coast Survey level of Art. 90 very much closer results have been reached.

CHAPTER VII

ASTRONOMICAL DETERMINATIONS

94. General Considerations. The astronomical determinations required in practical geodesy are *Time, Latitude, Longitude and Azimuth*. The precise determination of these quantities requires special instruments as well as special knowledge and skill, and falls within the province of the astronomer or professional geodesist rather than that of the civil engineer. A fair determination, however, of one or more of these quantities is not infrequently required of the engineer, so that a partial knowledge of the subject is necessary. A complete discussion of the subjects of this chapter may be found in Doolittle's *Practical Astronomy*, or in Appendix No. 7, Report for 1897-98, U. S. Coast and Geodetic Survey. As the work of the fixed observatory is outside the sphere of the engineer, the following articles are intended to cover field methods only.

The instruments used by the engineer will generally be limited to the sextant, the engineer's transit, one of the higher grades of transits, or the altazimuth instruments of Chapter III. All of these instruments are suitable for either day or night observations, except that the ordinary engineer's transit is not usually furnished with means for illuminating the cross-hairs at night. This difficulty may be overcome by substituting in place of the sunshade a similar shade of thin white paper, a flat piece of bright tin bent over in front of the object glass at an angle of about 45° and containing an oblong hole having a slightly less area than that of the lens, or a special reflecting shade which may be bought from the maker of the instrument. The light of a bull's-eye lantern thrown on any of these devices will render the cross-hairs visible.

In astronomical work the observer is assumed to be at the center of the earth, this point being taken as the center of a great

celestial sphere on which all the heavenly bodies are regarded as being projected. Any appreciable errors arising from the assumption that the earth is stationary or that the observer is at its center, are duly corrected. All vertical and horizontal planes and the planes of the earth's equator and meridians are imagined extended to an intersection with the celestial sphere, and are correspondingly named. Fig. 47, page 166, is a diagram of the celestial sphere, and the accompanying text contains the definitions and notation used in the discussions. A thorough study and comprehension of the figure and text are absolutely essential for an understanding of what follows. The necessary values of the right ascensions, declinations, etc., required in the formulas, are obtained from the American Ephemeris, commonly called the Nautical Almanac, which is issued yearly (three years in advance) by the Government.

TIME

95. General Principles. Time is measured by the rotation of the earth on its axis, which may be considered perfectly uniform for the closest work. The rotation is marked by the observer's meridian sweeping around the heavens. The intersection of this meridian with the celestial equator furnishes a point whose uniform movement around the equator marks off time in angular value. The angle thus measured at any moment between the observer's meridian and the meridian of any given point (which may itself be moving) is the hour angle of that point at that moment. These angles are, of course, identical with the corresponding spherical angles at the pole. When 360° of the equator have passed by the meridian of a reference point (whether moving or not) the elapsed time is called twenty-four hours, so that any kind of time is changed from angular value to the hour system by dividing by 15, and vice versa. There are two kinds of time in common use, mean solar time and sidereal time, based on the character of the reference point. Mean solar time is the ordinary time of civil life, and sidereal time is the time chiefly used in astronomical work.

96. Mean Solar Time. The fundamental idea of solar time is to use as the measure of time the apparent daily motion of the sun

around the earth; this is called *apparent solar time*, the upper transit of the sun at the observer's meridian being called *apparent noon*. Apparent solar time, however, is not uniform, on account of a lack of uniformity in the apparent annual motion of the sun around the earth. This is due to the fact that the apparent annual motion is in the ecliptic, the plane of which makes an angle with the plane of the equator, and the further fact that even in the ecliptic the apparent motion is not uniform. To overcome this difficulty, a fictitious sun, called the mean sun, is assumed to move annually around the equator at a perfectly uniform rate, and to make the circuit of the equator in the same total time that the true sun apparently makes the circuit of the ecliptic. *Mean solar time* is time as indicated by the apparent daily motion of the mean sun and is perfectly uniform. The difference between apparent solar time and mean solar time is called the *equation of time*, varies both ways from zero to about seventeen minutes, and is given in the Nautical Almanac for each day of the year. *Local mean time* for any meridian is the hour angle of the mean sun measured westward from that meridian, *local mean noon* being the time of the upper transit of the mean sun for that meridian.

96a. Standard Time. This time, as now used in the United States, is mean solar time for certain specified meridians, each district using the time of one of these standard meridians instead of its own local time. The meridians used are the 75th, 90th, 105th and 120th west of Greenwich, furnishing respectively Eastern, Central, Mountain and Pacific standard time. Standard time for all points in the United States differs only by even hours, with very large belts having exactly the same time, the variation from local mean time seldom exceeding a half hour. In the latitude of New York local mean time varies about four seconds for every mile east or west. Standard time may be obtained at any telegraph station with a probable error of less than a second. In all astronomical work standard time must be changed to local mean time.

96b. To Change Standard Time to Local Mean Time and vice versa. The difference between standard time and local mean time at any point equals the difference of longitude (expressed in time units, Art. 113) between the given point and the standard time meridian used. For points east of the standard time

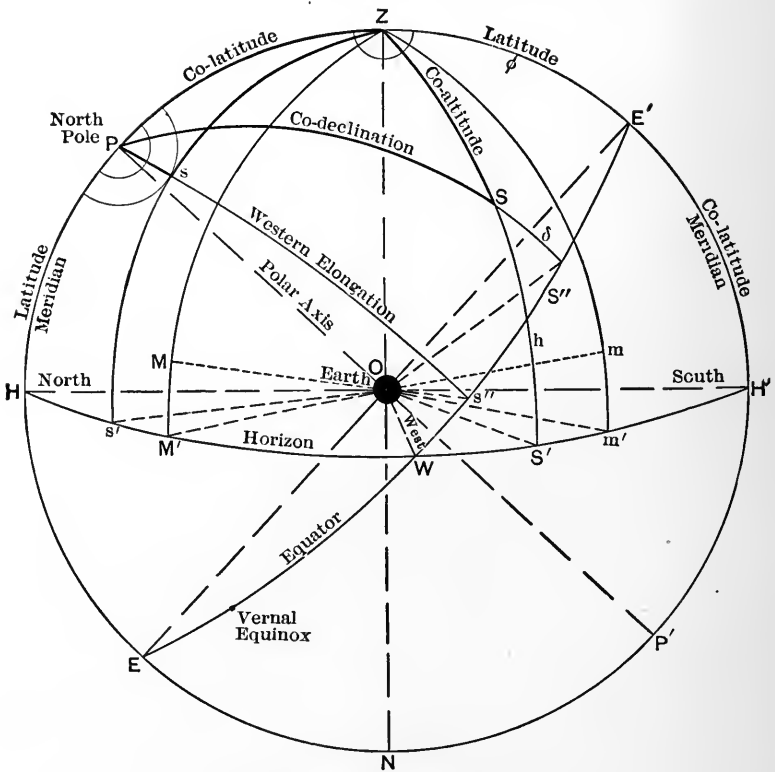

FIG. 47.—The Celestial Sphere.

EXPLANATION

$HZH'N$ = meridian of observer;

Z, W, N = points on prime vertical;

M, m = projection of azimuth marks on celestial sphere;

Z = observer's zenith;

N = observer's nadir;

Angles at Z , and corresponding horizontal angles at O , are azimuth angles;

Angles at P , and corresponding equatorial angles at O , are hour angles.

CONVERSION OF ARC AND TIME

Arc.	Time.	Time.	Arc.
1°	= 4 minutes	1 hour	= 15°
$1'$	= 4 seconds	1 minute	= $15'$
$1''$	= $\frac{1}{15}$ second	1 second	= $15''$

DEFINITIONS

The *zenith* (at a given station) is the intersection of a vertical line with the upper portion of the celestial sphere.

The *nadir* is the intersection of a vertical line with the lower portion of the celestial sphere.

The *meridian plane* is the vertical plane through the zenith and the celestial poles, the *meridian* being the intersection of this plane with the celestial sphere.

The *prime vertical* is the vertical plane (at the point of observation) at right angles with the meridian plane.

The *latitude* of a station is the angular distance of the zenith from the equator, and has the same value as the altitude of the elevated pole. Latitude may also be defined as the declination of the zenith. North latitude is positive and south latitude negative.

Co-latitude = $90^\circ - \text{latitude}$.

Right ascension is the equatorial angular distance of a heavenly body measured eastward from the vernal equinox.

Declination is the angular distance of a heavenly body from the equator. North declination is positive and south declination negative.

Co-declination or polar distance = $90^\circ - \text{declination}$.

The *hour angle* of a heavenly body is its equatorial angular distance from the meridian. Hour angles measured towards the west are positive, and vice versa.

The *azimuth* of a heavenly body (or other point) is its horizontal angular distance from the south point of the meridian (unless specified as from the north point). Azimuth is positive when measured clockwise, and vice versa.

The *altitude* of a heavenly body is its angular distance above the horizon.

Co-altitude or zenith distance = $90^\circ - \text{altitude}$.

Refraction is the angular increase in the apparent elevation of a heavenly body due to the refraction of light, and is always a negative correction.

Parallax (in altitude) is the angular decrease in the apparent elevation of a heavenly body due to the observation being taken at the surface instead of at the center of the earth, and is always a positive correction.

NOTATION

ϕ = latitude (+ when north, - when south);

α = right ascension;

δ = declination (+ when north, - when south);

t = hour angle (+ to west, - to east);

A = azimuth from north point (+ when measured clockwise);

Z = azimuth from south point (+ when measured clockwise);

h = altitude;

z = zenith distance;

r = refraction;

p = parallax.

meridian local mean time is later than standard time, and vice versa.

Example 1. New York, N.Y., uses 75th-meridian standard time. Given the longitude of Columbia College as $73^{\circ} 58' 24''.6$ west of Greenwich, what is the local mean time at $10^{\text{h}} 14^{\text{m}} 17^{\text{s}}.2$ P.M. standard time?

$$\begin{array}{r}
 75^{\circ} 00' 00''.0 \\
 73 \quad 58 \quad 24 \quad .6 \\
 \hline
 15) 1^{\circ} 01' 35''.4 \\
 \quad \quad \quad 4^{\text{m}} 06^{\text{s}}.4
 \end{array}
 \qquad
 \begin{array}{r}
 10^{\text{h}} 14^{\text{m}} 17^{\text{s}}.2 \text{ P.M.} \\
 \quad \quad \quad 4 \quad 06 \quad .4 \\
 \hline
 \text{Ans.} = 10^{\text{h}} 18^{\text{m}} 23^{\text{s}}.6 \text{ P.M.}
 \end{array}$$

Example 2. Philadelphia, Pa., uses 75th-meridian standard time. Given the longitude of Flower Observatory as $5^{\text{h}} 01^{\text{m}} 06^{\text{s}}.6$ west of Greenwich, what is the standard time at $9^{\text{h}} 06^{\text{m}} 18^{\text{s}}.1$ A.M. local mean time.

$$\begin{array}{r}
 15) 75^{\circ} 00' 00''.0 \\
 \quad \quad \quad 5^{\text{h}} 00^{\text{m}} 00^{\text{s}}.0 \\
 \quad \quad \quad 5 \quad 01 \quad 06 \quad .6 \\
 \hline
 \quad \quad \quad 1^{\text{m}} 06^{\text{s}}.6
 \end{array}
 \qquad
 \begin{array}{r}
 9^{\text{h}} 06^{\text{m}} 18^{\text{s}}.1 \text{ A.M.} \\
 \quad \quad \quad 1 \quad 06 \quad .6 \\
 \hline
 \text{Ans.} = 9^{\text{h}} 07^{\text{m}} 24^{\text{s}}.7 \text{ A.M.}
 \end{array}$$

97. Sidereal Time. In this kind of time a sidereal day of twenty-four hours corresponds exactly to one revolution of the earth on its axis, as marked by two successive upper transits of any star over the same meridian. The sidereal day for any meridian commences when that meridian crosses the vernal equinox, and runs from zero to twenty-four hours. The sidereal time at any moment is the hour angle of the vernal equinox at that moment, counting westward from the meridian. As the right ascensions of stars and meridians are counted eastward from the vernal equinox, it follows that the sidereal time for any observer is the same as the right ascension of his meridian at that moment. Hence when a star of known right ascension crosses the meridian the sidereal time becomes known at that moment. The right ascension of the mean sun at Greenwich mean noon (called sidereal time of Greenwich mean noon) is given in the Nautical Almanac for every day of the year, and is readily found for local mean noon at any other meridian by adding the product of 9.8565 seconds by the given longitude west of Greenwich expressed in hours.

98. To Change a Sidereal to a Mean Time Interval, and vice versa. Owing to the relative directions in which the earth rotates on its axis and revolves around the sun the number of sidereal days in a tropical year (one complete revolution of the earth around the sun) is exactly one more than the number of solar days. According to Bessel the tropical year contains 365.24222 mean solar days, hence $365.24222 \text{ mean solar days} = 366.24222 \text{ sidereal days}$, and therefore

$$1 \text{ mean solar day} = 1.0027379 \text{ sidereal days;}$$

$$1 \text{ sidereal day} = 0.9972696 \text{ mean solar days;}$$

whence if I_s is any sidereal interval of time and I_m the mean solar interval of equal value, we have

$$I_s = I_m + 0.0027379 I_m \quad (\log 0.0027379 = 7.4374176 - 10)$$

$$I_m = I_s - 0.0027304 I_s \quad (\log 0.0027304 = 7.4362263 - 10)$$

Where there is much of this work to be done the labor of computation is lessened by using the tables found in the Nautical Almanac and books of logarithms.

99. To Change Local Mean Time or Standard Time to Sidereal. For local mean time this is done by converting the mean time interval between the given time and noon into the equivalent sidereal interval (Art. 98), and combining the result with the sidereal time of mean noon for the given place and date. Since the right ascension of the mean sun increases 360° or twenty-four hours in one year, the increase per day will be $3^m 56^s.555$, or $9^s.8565$ per hour. The sidereal time of mean noon for the given place is therefore found by taking the sidereal time of Greenwich mean noon from the Nautical Almanac and adding thereto the product of $9^s.8565$ by the longitude in hours of the given meridian, counted westward from the meridian of Greenwich. If standard time is used it must first be changed to local mean time (Art. 96b) before applying the above rule.

Example. To find the sidereal time at Syracuse, N. Y., longitude $76^\circ 08' 20''.40$ west of Greenwich, when the standard (75th meridian) time is $10^h 42^m 00^s$ A. M., January 17th, 1911.

$76^{\circ} 08' 20''.40$ 75 <hr style="width: 50%; margin: 0 auto;"/> $15) 1^{\circ} 08' 20''.40$ $4^m 33^s .36$ <hr style="width: 50%; margin: 0 auto;"/>	$10^h 42^m 00^s .00$ standard time $- 4 33 .36$ <hr style="width: 50%; margin: 0 auto;"/> $10 37 26.64$ local mean time 12 <hr style="width: 50%; margin: 0 auto;"/>
$\log 4953.36 = 3.6948999$ $\log 0.0027379 = 7.4374176$ <hr style="width: 50%; margin: 0 auto;"/> $\log (13^s .56) = 1.1323175$ <hr style="width: 50%; margin: 0 auto;"/>	$1^h 22^m 33^s .36 = 4953^s .36$ $+ 13 .56$ <hr style="width: 50%; margin: 0 auto;"/> $1 22 46 .92$ sidereal interval <hr style="width: 50%; margin: 0 auto;"/>
$15) 76^{\circ} 08' 20''.40$ $5^h 04^m 33^s .36$ $= 5.0759$ hrs.	$\log 9.8565 = 0.9937227$ $\log 5.0759 = 0.7055131$ <hr style="width: 50%; margin: 0 auto;"/> $\log (50^s .03) = 1.6992358$
Sidereal time of Greenwich mean noon Reduction to Syracuse meridian	$19^h 43^m 09^s .48$ $+ 50 .03$ <hr style="width: 50%; margin: 0 auto;"/>
Sidereal time of Syracuse mean noon Sid. int. from Syracuse mean noon	$19 43 59 .51$ $- 1 22 46 .92$ <hr style="width: 50%; margin: 0 auto;"/>
Sidereal time at given instant	$18^h 21^m 12^s .59$

100. To Change Sidereal to Local Mean Time or Standard Time. This is the reverse of the process in Art. 99, and consists in finding the difference between the given time and the sidereal time of mean noon for the given place and date, changing this interval to the corresponding mean time interval (Art. 98), and combining the result with twelve o'clock (mean noon) by addition or subtraction as the case requires. The result is local mean time, and if standard time is wanted it is then obtained as explained in Art. 96*b*.

Example. To find the local mean time and standard (75th meridian) time at Syracuse, N. Y., longitude $76^{\circ} 08' 20''.40$ west of Greenwich, when the sidereal time is $18^h 21^m 12^s .59$, January 17, 1911.

$76^{\circ} 08' 20''.40 - 75^{\circ} = 1^{\circ} 08' 20''.40 = 4^m 33^s .36$ $15) 76^{\circ} 08' 20''.40$ $5^h 04^m 33^s .36$ $= 5.0759$ hrs.	$\log 9.8565 = 0.9937227$ $\log 5.0759 = 0.7055131$ <hr style="width: 50%; margin: 0 auto;"/> $\log (50^s .03) = 1.6992358$
--------------------------------------------------------------------------------------------------------------------------------------------------------	-----------------------------------------------------------------------------------------------------------------------------------

Sidereal time of Greenwich mean noon	19 ^h 43 ^m 09 ^s .48
Reduction to Syracuse meridian	+ 50 .03
<hr/>	
Sidereal time of Syracuse mean noon	19 43 59 .51
Sidereal time at given instant	18 21 12 .59
<hr/>	
Sidereal interval before Syracuse mean noon	1 ^h 22 ^m 46 ^s .92
<hr/>	
1 ^h 22 ^m 46 ^s .92 = 4966 ^s .92	
log 4966.92 = 3.6960872	{ Reduction to mean time interval }
log 0.0027304 = 7.4362263	
<hr/>	
log (13 ^s .56) = 1.1323135	1 ^h 22 ^m 46 ^s .92
	- 13 .56
	<hr/>
	1 22 33 .36
	<hr/>
	12
Local mean time at given instant (morning)	10 ^h 37 ^m 26 ^s .64
Reduction to standard time	+ 4 33 .36
<hr/>	
Standard time at given instant (morning)	10 ^h 42 ^m 00 ^s .00

101. Time by Single Altitudes. The altitude of any heavenly body as seen by an observer at a given point is constantly changing, each different altitude corresponding to a particular instant of time which can be computed if the latitude and longitude are approximately known. In finding local mean time or sidereal time it is sufficient to know the latitude to the nearest minute and the longitude within a few degrees. In changing from local to standard time, however, an error of 1^s will be caused by each 15'' error of longitude. If the latitude is not known it may generally be scaled sufficiently close from a good map, or it may be determined as explained in Arts. 107 or 108. By comparing the observed time for a certain measured altitude of sun or star with the corresponding computed time the error of the observer's timepiece is at once determined. The observation may be made with a transit (or altazimuth instrument), or with a sextant (and artificial horizon), the latter being the most accurate. In either case several observations ought to be taken in immediate succession, as described below, and the average time and average altitude used in the reductions. The probable error of the result may be several seconds with a transit, and a second or two with the sextant. The actual error is apt to be larger on account of the uncertainties of refraction. The observation is commonly made with the sextant and on the sun.

101a. Making the Observation. The best time for making an observation on the sun is between 8 and 9 o'clock in the morning and between 3 and 4 o'clock in the afternoon, in order to secure a rapidly changing altitude and at the same time avoid irregular refraction as far as possible. The altitude of the center of the sun is never directly measured, but the observations are taken on either the upper or lower limb, or preferably an equal number of times on each limb. Star observations may be made at any hour of the night, selecting stars which are about three hours from the meridian and near the prime vertical, and hence changing rapidly in altitude at the time and place of observation. If two stars are observed at about the same time having about the same declination and about the same altitude, but lying on opposite sides of the meridian, the mean of the two results (determinations of the clock error) will be largely free from the errors due to the uncertainties of refraction.

In taking the observation an attendant notes the watch time to the nearest second at the exact moment the pointing is made. *If the transit* is used, an equal number of readings should be taken with the telescope direct and reversed, the plate bubble parallel to the telescope being brought exactly central for each individual pointing in order to eliminate the instrumental errors of adjustment. If a star or one limb of the sun is observed there should be not less than 3 direct and 3 reversed readings. If both limbs of the sun are observed there should be not less than 2 direct and 2 reversed readings on each limb, or 3 direct on one limb and 3 reversed on the other limb. *If the sextant and artificial horizon* are used, and the pointings are made on a star or on one limb of the sun, not less than 5 readings of the double altitude should be taken; if both limbs of the sun are observed, not less than 3 readings should be taken for each limb. These double altitudes are always corrected for index error and sometimes for eccentricity. It is considered better not to use the cover on the artificial horizon, but if it has to be done it should be reversed on half of the readings. If as much tin foil is added to commercial mercury as it will unite with, an amalgam is formed whose surface is not readily disturbed by the wind, thus rendering the cover unnecessary. When the mercury is poured in its dish it must be skimmed with a card to clean its reflecting surface. In all of the above methods of observing, the work is supposed

to be carried on with reasonable regularity and expedition when once started. With any method it is desirable to take at least two sets of readings and compute them independently as a check, the extent of the disagreement showing the quality of the work that has been done, while the mean value is probably nearer the truth than the result of any single set.

101b. The Computation. The first step in the computation of any set of observations is to find the average value of the measured altitudes and the average value of the recorded times, these average values constituting the observed altitude and time for that set. This observed altitude is then reduced to the true altitude for the center of the object observed. The reductions which may be required are for refraction, parallax, and semi-diameter. The apparent altitude of all heavenly bodies is too large on account of the refraction of light; Table VIII gives the average angular value of refraction, which is a negative correction for all measured altitudes. Parallax is an apparent displacement of a heavenly body due to the fact that the observer is not at the center of the earth; star observations require no correction for parallax; all solar observations require a positive correction for parallax, the amount being equal to $8''.9$ multiplied by the cosine of the observed altitude. The correction for semi-diameter is only required in solar work, and not even then for the average of an equal number of observations on both limbs; when the average altitude refers to only one limb a self-evident positive or negative correction is required for semi-diameter, the value of which is given in the Nautical Almanac for the meridian of Greenwich for every day of the year, and can readily be interpolated for the given longitude. Letting h equal true altitude for center, h' equal measured altitude, r equal refraction, p equal parallax, and s equal semi-diameter, we have

$$\begin{aligned} h \text{ (for a star)} &= h' - r; \\ h \text{ (sun, both limbs)} &= h' - r + p; \\ h \text{ (sun, one limb)} &= h' - r + p \pm s. \end{aligned}$$

In the polar triangle ZPS , Fig. 47, page 166, the three sides are known. ZP , the co-latitude, is found by subtracting the observer's latitude from 90° . PS , the polar distance or co-declination, is

found by subtracting the declination of the observed body from 90° . In the case of the sun the declination is constantly changing and must be taken for the given date and hour (the time being always approximately known). The sun's declination for Greenwich mean noon is given in the Nautical Almanac for every day in the year, and can be interpolated for the Greenwich time of the observation; the Greenwich time of the observation differs from the observer's time by the difference in longitude in hours, remembering that for points west of Greenwich the clock time is earlier, and vice versa. ZS , the co-altitude, is found by subtracting the reduced altitude h from 90° . Using the notation of Fig. 47, we have from spherical trigonometry

$$\cos z = \sin \phi \sin \delta + \cos \phi \cos \delta \cos t,$$

whence

$$\cos t = \frac{\cos z - \sin \phi \sin \delta}{\cos \phi \cos \delta},$$

which for logarithmic computation is reduced to the form

$$\tan \frac{1}{2}t = \sqrt{\frac{\sin \frac{1}{2}[z + (\phi - \delta)] \sin \frac{1}{2}[z - (\phi - \delta)]}{\cos \frac{1}{2}[z + (\phi + \delta)] \cos \frac{1}{2}[z - (\phi + \delta)]}}.$$

The value of t thus found is the hour angle of the observed body, or angular distance from the observer's meridian. Dividing t by 15 changes the angular value to the corresponding time interval.

For a solar observation the time interval is subtracted from or added to 12 o'clock according as the sun is east or west of the meridian, giving the apparent solar time of the observation. This apparent time must be reduced to mean time by applying the equation of time for the given date and hour, taken from the Nautical Almanac in the manner above described for finding the declination. The local mean time of the observation as thus found may be changed to standard time (Art. 96*b*), or sidereal time (Art. 99), if so desired.

For a star observation the time interval is subtracted from or added to the star's right ascension according as the star is east or west of the meridian, giving the sidereal time of the observation. This may be changed to local mean time (Art. 100), and thence to standard time (Art. 96*b*), if so desired.

EXAMPLE.—TIME BY SINGLE ALTITUDES OF THE SUN

CHICAGO, ILL., June 1, 1911.

Latitude = $41^{\circ} 50' 01''.0$ N.

Longitude = $87^{\circ} 36' 42''.0 = 5^h 50^m 26^s.8 = 5.84$ hrs. W. of Greenwich.

Uses 90th meridian (Central Standard) time = 6.00 hrs. W. of Greenwich.

Local time—Standard time = $6^h 00^m 00^s.0 - 5^h 50^m 26^s.8 = 9^m 33^s.2$.

<i>Sun.</i>	<i>h'</i>	<i>Watch, A.M.</i>	<i>h and z.</i>
Lower limb	47° 00'	8 ^h 46 ^m 11 ^s	Par. = $8''.9 \times \cos 48^{\circ} 20' = 6''.7$
	47 20	8 48 06	
	47 40	8 50 03	
Upper limb	49 00	8 54 45	App. altitude = $48^{\circ} 20' 00''.0$
	49 20	8 56 41	Refraction = $- 51 .3$
	49 40	8 58 38	Parallax = $+ 6 .7$
<u>6)290° 00'</u>		<u>6)53^h 14^m 24^s</u>	<u><i>h</i> = $48^{\circ} 19' 15''.4$</u>
Average	<u>48° 20'</u>	<u>8^h 52^m 24^s.0</u>	<u><i>z</i> = $41^{\circ} 40' 44''.6$</u>

Approximate interval after Greenwich mean noon

$$= 8^h 52^m 24^s.0 + 6 \text{ hrs} - 12 \text{ hrs} = 2^h 52^m 24^s.0 = 2.87 \text{ hours.}$$

<i>Time.</i>	δ	$d\delta$	<i>Eq. of Time.</i>
At Greenwich mean noon	$+21^{\circ} 56' 33''.6$	$+21''.23$	$2^m 31^s.87$
Reduction for 2.87 hrs.	$+ 1 00 .8$	$- 0 .11$	$- 1 .04$
At time of observation	$+21^{\circ} 57' 34''.4$	$+21''.12$	$2^m 30^s.83$

Equation of time *subtractive* from *apparent time* (on given date).

$$\frac{0.96 \times 2.87}{24} = 0''.11 \qquad \frac{21.23 + 21.12}{2} = 21''.18$$

$$0.363 \times 2.87 = 1^s.04 \qquad 21.18 \times 2.87 = 60''.8$$

$$\begin{aligned} \phi - \delta &= 19^{\circ} 52' 26''.6 & \phi + \delta &= 63^{\circ} 47' 35''.4 \\ z + (\phi - \delta) &= 61 33 11 .2 & z + (\phi + \delta) &= 105 28 20 .0 \\ z - (\phi - \delta) &= 21 48 18 .0 & z - (\phi + \delta) &= -22 06 50 .8 \end{aligned}$$

$$\tan \frac{1}{2}t = \sqrt{\frac{\sin(30^{\circ} 46' 35''.6) \sin(10^{\circ} 54' 09''.0)}{\cos(52 44 10 .0) \cos(-11 03 25 .4)}} = 21^{\circ} 58' 37''.7$$

$$t = 43^{\circ} 57' 15''.4 = 2^h 55^m 49^s.0.$$

Local apparent noon	12 ^h 00 ^m 00 ^s .0
Hour angle of sun	- 2 55 49 .0
Apparent solar time	<u>9^h 04^m 11^s.0</u>
Equation of time	- 2 .30 .8
Local mean time of observation	<u>9^h 01^m 40^s.2</u>
Watch time of observation	8 52 24 .0
Watch <i>slow</i> by mean time	<u>9^m 16^s.2</u>
Reduction to standard time	- 9 33 .2
Watch <i>fast</i> by standard time	<u>0^m 17^s.0</u>

In either case the error of the observer's timepiece (as determined by any given set of observations) is obtained by comparing the observer's average time for the given set with the computed true time for the same set.

102. Time by Equal Altitudes. In this method the clock time is noted at which the sun (or a star) has the same altitude on each side of the meridian, from which the clock time of meridian passage (upper or lower transit or culmination) is readily obtained. By comparing the clock time with the true time of meridian passage the error of the observer's clock is at once made known. The advantages of this method over the method of single altitudes are as follows: the results are in general more reliable; the computation is simpler, as it does not involve the solution of a spherical triangle; no correction is required for refraction, parallax, semi-diameter, nor instrumental errors; the latitude need not be known at all for star observations, and only very approximately for solar work. The observations may be made with a transit or a sextant (with artificial horizon), the latter being the most accurate. In either case several observations ought to be taken in immediate succession, as described below, and the average time used in the reductions. The probable error of the result should not exceed about two seconds with the transit nor about one second with the sextant. The actual error may be greater on account of the uncertainties of refraction. The method evidently assumes that the refraction will be the same for each of the equal altitudes, but on account of the lapse of time between the observations this is not necessarily true. The observation is commonly made with the sextant and on the sun.

102a. Making the Observation. As with the previous method, the best time for making an observation on the sun is between 8 and 9 o'clock in the morning and between 3 and 4 o'clock in the afternoon. The observations may be taken entirely on one limb of the sun or an equal number of times on each limb. The equal altitudes may be taken on the morning and afternoon of the same day, or on the afternoon of one day and the morning of the next day. For star observations a star should be selected which will be about three hours from the meridian and near the prime vertical at the times of observation. Since the equal altitudes observed must be within the hours of darkness, a star is required whose meridian passage occurs within about three

hours after dark and three hours before daylight. The sidereal time of meridian passage is always known, since it is the same as the star's right ascension, and the corresponding values of mean time and standard time are readily found by Arts. 100 and 96b. The equal altitudes may be taken during the same night, or on the morning and evening of the same day.

In taking the observation the attendant notes the watch time to the nearest second at the exact moment the pointing is made. *If the transit* is used the telescope is not reversed, but the plate bubble parallel to the telescope is brought exactly central for each individual pointing; no corrections are made to the resulting reading for any instrumental errors. *If the sextant and artificial horizon* are used no corrections are applied to the resulting double altitude as measured. There is no great objection to using the cover of the artificial horizon in this method, and when used it is not reversed (as in Art. 101a); it is necessary, however, to use it in the same position at both periods of equal altitudes.

If a star or one limb of the sun is observed there should be not less than 5 readings taken at each period of equal altitudes. If both limbs of the sun are observed there should be not less than 3 readings (at each period) for each limb. The angular readings in this method are always equally spaced, the instrument being set in turn for each equal change of altitude and the time noted when the event occurs. In commencing operations the observer measures the approximate altitude, sets his vernier to the next convenient even reading, and watches for that altitude to be reached; the next setting is then made and that altitude waited for, and so on. At the second period the same settings must be used, but in reverse order. The size of the angular interval will depend on the ability of the observer to make each setting in time to catch the given occurrence, and can best be found by trial; under average conditions a good observer would not find it difficult to use 10' settings on the transit and 20' on the sextant. It is desirable to take at least two independent sets of observations, and compute them separately as a check and as an indication of the reliability of the results; the adopted value would then be taken as the mean of the several determinations.

102b. The Computation. In this method there is no object in finding the average of the observed altitudes, the method

being based on the *equality* of the corresponding altitudes instead of their *value*. For each set of observations, however, it is necessary to find the average of the time readings for each of the two periods of equal altitudes. From these values the middle time (half-way point between the two average time readings) is found for star observations, and the middle time and elapsed time (interval between average time readings) for solar observations. For star observations the middle time is the observer's time of meridian passage. For solar observations a correction must be applied to the middle time to obtain the observer's time of meridian passage, on account of the changing declination of the sun.

For solar observations on the same day, expressed in mean time units, we have from astronomy

$$U = M - \frac{d\delta \cdot t}{15} \left(\frac{\tan \phi}{\sin t} - \frac{\tan \delta}{\tan t} \right),$$

in which

- U = observer's time at apparent noon (upper transit of sun);
- M = middle time of the observations;
- t = one-half elapsed time, in hours to three places outside of parentheses and angular value inside of parentheses;
- ϕ = observer's latitude (approximate), + for north and - for south latitude;
- δ = sun's declination at mean noon for given date and longitude, + for north and - for south declination;
- $d\delta$ = hourly change of declination at mean noon for given date and longitude, + when north declination is increasing or south declination decreasing, and - when north declination is decreasing or south declination increasing.

The values for δ and $d\delta$ for the given date are found in the Nautical Almanac for Greenwich mean noon and interpolated for the given meridian. If a sidereal chronometer is used it is necessary to convert t into a mean time interval before inserting in the corrective term in the above formula, and the value of this term must then be reduced to a sidereal interval before subtracting from M .

The true mean time of apparent noon is found by applying

to 12 o'clock (the apparent time) the equation of time for the given date and longitude. The equation of time (with directions for applying) is found in the Nautical Almanac for Greenwich apparent noon of the given date, and interpolated for the given meridian. The true mean time of apparent noon is then reduced to standard time (Art. 96*b*), or sidereal time (Art. 99), if so desired.

By comparing the observer's time, U , with the corresponding true time of apparent noon, the error of the observer's timepiece at apparent noon is made known.

For solar observations on an afternoon and following morning, expressed in mean time units, we have from astronomy

$$L = M + \frac{d\delta \cdot t}{15} \left(\frac{\tan \phi}{\sin t} + \frac{\tan \delta}{\tan t} \right),$$

in which L is the observer's time at apparent midnight (lower transit of sun), δ and $d\delta$ the declination and hourly change for mean midnight of initial date, and the other quantities remain as before. This problem is worked out as in the preceding case except that δ , $d\delta$, and the equation of time must be interpolated for twelve hours more than the given longitude, and the clock error is determined for apparent midnight of the initial date.

For star observations during the same night, taken on the same star, the middle time represents the observer's time for the star's upper transit. The true sidereal time of this transit equals the star's right ascension, as given in the Nautical Almanac, and this is changed to local mean time (Art. 100), and thence to standard time (Art 96*b*), if so desired.

By comparing the observer's middle time with the true time of upper transit, the error of the observer's timepiece is determined for the moment at which it indicated the middle time.

For star observations on morning and evening of same day, taken on the same star, the middle time represents the observer's time for the star's lower transit. The true sidereal time of this transit equals the star's right ascension plus twelve hours, and this is changed to local mean time (Art. 100), and thence to standard time (Art. 96*b*), if so desired.

By comparing the observer's middle time with the true time of lower transit, the error of the observer's timepiece is determined for the moment at which it indicated the middle time.

EXAMPLE.—TIME BY EQUAL ALTITUDES OF THE SUN

ALBANY, N. Y., May 10, 1911.

Latitude = $42^{\circ} 39' 12''.7$ N.Longitude = $73^{\circ} 46' 42''.0 = 4^{\text{h}} 55^{\text{m}} 06^{\text{s}}.8 = 4.92$ hrs. W. of Greenwich.

Uses 75th meridian (Eastern Standard) time = 5.00 hrs. W. of Greenwich.

Local time - Standard time = $5^{\text{h}} 00^{\text{m}} 00^{\text{s}}.0 - 4^{\text{h}} 55^{\text{m}} 06^{\text{s}}.8 = 4^{\text{m}} 53^{\text{s}}.2$

<i>Time.</i>	δ	$d\delta$	<i>Eq. of Time.</i>
At Greenwich mean noon	+17° 23' 56''.7	+39''.87	
At Greenwich app. noon			3 ^m 41 ^s .2
Reduction for 4.92 hrs.	+ 3 15 .8	- 0 .15	+ 0 .6
At Albany mean noon	+17° 27' 12''.5	+39''.72	
At Albany app. noon			3 ^m 41 ^s .8

Equation of time *subtractive* from *apparent time* (on given date).

$$\frac{0.73 \times 4.92}{24} = 0''.15 \qquad \frac{39.87 + 39.72}{2} = 39''.80$$

$$0.126 \times 4.92 = 0^{\text{s}}.62 \qquad 39.80 \times 4.92 = 195''.8$$

<i>Sun.</i>	<i>App. alt.</i>	<i>Watch, A.M.</i>	<i>Watch, P.M.</i>
Upper limb	{ 45° 00'	8 ^h 58 ^m 22 ^s	2 ^h 54 ^m 13 ^s
	{ 45 20	9 00 18	2 52 18
	{ 45 40	9 02 12	2 50 24
Lower limb	{ 45 40	9 05 14	2 47 20
	{ 46 00	9 07 10	2 45 25
	{ 46 20	9 09 05	2 43 29
		6)54 ^h 22 ^m 21 ^s	6)16 ^h 53 ^m 09 ^s
$M = 11^{\text{h}} 56^{\text{m}} 17^{\text{s}}.5$		9 ^h 03 ^m 43 ^s .5	(+12)2 ^h 48 ^m 51 ^s .5
$= 2^{\text{h}} 52^{\text{m}} 34^{\text{s}}.0$	(+12)	2 48 51 .5	9 03 43 .5
$t = 2.88$ hrs.		2)23 ^h 52 ^m 35 ^s .0	2)5 ^h 45 ^m 08 ^s .0
$= 43^{\circ} 08' 30''.0$		11 ^h 56 ^m 17 ^s .5	2 ^h 52 ^m 34 ^s .0

	<i>log.</i>		<i>log.</i>
$\tan \phi$ ($42^{\circ} 39' 12''.7$)	= 9.9643882	$\tan \delta$ ($17^{\circ} 27' 12''.5$)	= 9.4974948
$\sin t$ ($43^{\circ} 08' 30''.0$)	= 9.8349320	$\tan t$ ($43^{\circ} 08' 30''.0$)	= 9.9718084
(1.3473)	= 0.1294562	(0.3355)	= 9.5256864
1.3473 - 0.3355 = 1.0118		$d\delta$ (39.72)	= 1.5990092
$M = 11^{\text{h}} 56^{\text{m}} 17^{\text{s}}.5$		t (2.88)	= 0.4593925
- 7 .7		15 (a.c.)	= 8.8239087
$U = 11^{\text{h}} 56^{\text{m}} 09^{\text{s}}.8$		1.0118	= 0.0050947
		(7 ^s .7)	= 0.8874051

Local apparent noon	12 ^h 00 ^m 00 ^s .0
Equation of time	- 3 41 .8
Local mean time at apparent noon	11 ^h 56 ^m 18 ^s .2
Watch time at apparent noon	11 56 09 .8
Watch <i>slow</i> by mean time	0 ^m 08 ^s .4
Reduction to standard time	- 4 53 .2
Watch <i>fast</i> by standard time	4 ^m 44 ^s .8

103. Time by Sun and Star Transits. The true time at which any heavenly body crosses the meridian is always known; in the case of the sun the upper transit is apparent noon, the mean time of which is determined by the equation of time (Art 96); in the case of a star the sidereal time at upper transit is the same as the star's right ascension; and (by Arts. 96*b*, 99, and 100) sidereal time, mean time and standard time are mutually convertible. If the observer notes his own clock time when any heavenly body crosses the meridian, the error of his timepiece is made apparent by comparison with the corresponding known true time. In order that the observation may be made it is necessary to know the location of the true meridian from a previous azimuth determination. (Astronomers have other ways of obtaining the meridian.) With the telescope in the plane of the true meridian, and set at a suitable vertical angle, it is only necessary to note the time when the given transit occurs.

103a. Sun Transits with Engineering Instruments. The instruments used for determining time by transits of the sun may be the ordinary engineer's transit or the altazimuth instruments of Chapter III. A prismatic eyepiece will be required if the meridian altitude exceeds about 60° . The instrument (and striding level, if there be one) should be in good adjustment. The instant at which the advancing edge of the sun reaches the meridian is noted with the telescope direct, and the instant at which the following edge reaches the meridian is noted with the telescope reversed, the mean of the two time readings being the observer's time of meridian passage. When the telescope is reversed it will be necessary to revolve the instrument on its vertical axis, and the telescope must be again brought into the plane of the meridian by sighting at the meridian mark as before. If the instrument has no striding level the plate bubble parallel to the horizontal axis of the telescope is to be kept exactly central while each observation is being made. If the instrument has a striding level it must not be reversed when the telescope is reversed, but the bubble must be kept central, as before, for each observation. If the instrument has three leveling screws it should be set with two screws parallel to the meridian and the bubble kept central with the remaining screw; if there are four leveling screws, place one pair in the meridian and hold the bubble central with the other pair. Time determined in the

above manner should not be in error by more than a second with an altazimuth instrument, nor by more than a couple of seconds with an engineer's transit.

The above method is not adapted to precise time determinations, so that when the larger astronomical instruments are available the observations are usually made on the stars.

103b. Star Transits with Engineering Instruments. The instruments used by the engineer for determining time by star transits may be the ordinary transit or the altazimuth instruments of Chapter III. The instrument (and striding level, if there be one) should be in good adjustment. The stars have no appreciable diameter, so that only one observation is obtained for each star. Since the true time of each star transit will be needed in the reductions it is desirable to tabulate these values beforehand, in order to be ready to watch for each transit near the proper time, as a star occupies only about a minute or two in crossing the field of view. As previously explained (Art. 97) the sidereal time of transit for each star is the same as its right ascension; if the observer's timepiece records mean or standard time it will be necessary to reduce the sidereal time of transit accordingly, as explained in Art. 100. In order to eliminate instrumental errors the stars are observed in pairs, the two stars of each pair having about the same declination; the second star of each pair is then observed with the telescope reversed. The instructions in the preceding article concerning the reversing and releveling of the instrument must be strictly adhered to. Only one result is obtained from each pair of stars, the average true time of transit for each pair being compared with the middle observed time for that pair to obtain the clock error for that instant of time. Not less than three pairs of stars should be observed and the results averaged. If the clock rate is not known the middle times for the several pairs should not differ greatly, the average of the error determinations being considered as the true value at the average of the middle times. If the clock rate is known the several error determinations are first reduced to the same instant of time before averaging.

Selection of stars. If several pairs of stars are observed it makes no difference in what order the stars come to the meridian so long as they are properly paired in the reductions. If the stars are so selected that all the first stars of the several pairs

will cross the meridian before any of the second stars, but one reversal of the instrument will be required; this will be the case if all the first stars have less right ascensions than any of the second stars. In order to have ample time between observations for releveling, etc., stars should not be selected having right ascensions differing by less than about five minutes. Having decided on the period of the night during which it is desired to make the observations, the mean time for the beginning and end of this period must be converted into approximate sidereal time, and stars must be selected whose right ascensions lie within these limits. The approximate sidereal time for any mean time instant is found by adding the mean time interval from the preceding noon to the sidereal time of Greenwich mean noon for the same date. Stars near either pole are not suitable for time stars on account of their apparent slow movement across the meridian; it is not desirable to use stars whose declination is more than 60° either way from the equator. On account of the uncertain state of the atmosphere at low altitudes stars should not be selected which will cross the meridian less than 30° above the horizon. Thus in 40° north latitude (see Fig. 47, page 166), the horizon will lie 50° south of the equator, and hence stars should not be taken lying over 20° south of the equator, so that for this latitude the stars selected should lie between 60° north declination and 20° south declination. The altitude of any star while crossing the meridian is readily obtained when it is remembered that the meridian altitude of the equator equals the observer's co-latitude, and that the star's distance from the equator is given by its declination. A prismatic eyepiece will be required for meridian altitudes exceeding about 60° .

It is best to use the brightest stars available for the given time and place, as it is not easy to identify or observe the fainter stars; satisfactory results may be obtained with stars ranging from the first (brightest) magnitude to about the fifth magnitude, depending on the size of the instrument. A large list of stars from which to choose, with all necessary data, will be found in the Nautical Almanac.

103c. Star Transits with Astronomical Instruments. The most accurate determinations of time are made by observing star transits with large portable astronomical transits or the still larger fixed observatory transits, in conjunction with an

astronomical clock beating seconds or a sidereal chronometer beating half seconds. A portable transit is illustrated in Fig. 48. A chronograph is generally used in the observatory, and sometimes in the field, for recording the observations. A chronograph is a clock-like device for moving a sheet of paper uniformly under a pen which automatically registers each second as indicated by the clock or chronometer; by breaking an electric circuit the observer causes the pen to record the star transits on the same sheet of paper; the time of transit is then obtained very accurately by scaling the distance from the nearest recorded second. When the chronograph is not used the observer listens to the chronometer beats and estimates the time of each transit to the nearest tenth of a second. The details of the instruments used, and the refinements in the methods of observation and computation, are beyond the scope of this treatise, but the principles involved are the same as those already given. The accuracy attainable is to about the nearest one-hundredth part of a second.

104. Choice of Methods. Though other methods have been devised for determining time, those above given are the ones in most general use. The engineer may use any of the methods from Art. 101 to Art. 103*b*, inclusive. Engineers generally prefer to work in the daytime, taking their observations on the sun. The transit may be used, but the sextant is to be preferred. If the transit is used the method based on the meridian passage of the sun (Art. 103*a*) is likely to be the most satisfactory, while if the sextant is used the method of equal altitudes (Arts. 102, 102*a*, 102*b*) will generally give the best results. Any of the methods will determine the true time as closely as the engineer will need it in any of his operations.

105. Time Determinations at Sea. There are several methods of finding local time at sea, the method by single altitudes (Art. 101) being most commonly used. The object observed may be the sun or one of the brighter stars. The observations are made with the sextant, the altitudes being measured from the sea horizon. This horizon is not the true horizon on account of the eye of the observer being at a material height above the surface of the water. The result of this condition is to make all measured altitudes too large by an angle depending on the height of the observer and known as the dip of the horizon. The correction

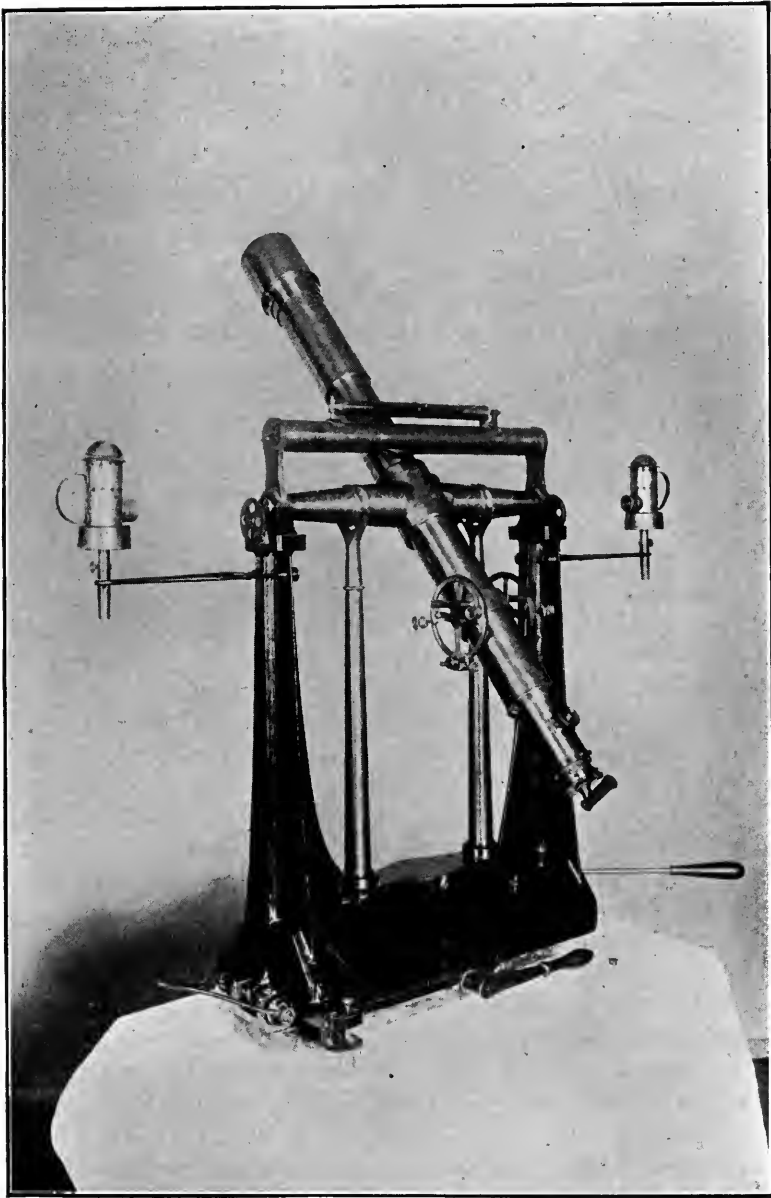

FIG. 48.—Portable Transit.

From a photograph loaned by the U. S. C. and G. S.

for dip is always subtractive, and is in addition to the corrections required by Art. 101*b*. Its value is given by the formula

$$\log D = 1.7712700 + \frac{1}{2} \log h,$$

in which D is the dip in seconds of arc and h is the observer's height in feet above the sea. The latitude required in the formula of Art. 101*b* is obtained sufficiently close by dead reckoning from the nearest observed latitude. Time at sea may be determined in this manner with a probable error running upwards from a few seconds, depending on the circumstances surrounding the observations.

LATITUDE

106. General Principles. The *latitude* of a point on the surface of the earth is its angular distance from the equator in a meridional plane. In Fig. 49 the ellipse $WNES$ represents a meridional section of the earth (Arts. 65, 66, 67), in which NS is the polar axis, or minor axis of the ellipse; WE , the equatorial diameter, or major axis of the ellipse; n , the position of the observer; nt the tangent at n ; nl , the normal at n , it being noted that the normal at any point n does not pass through the center c (except when n is at the poles or on the equator); Zn , the direction of the plumb line at n , frequently deviating a few seconds (Art. 75) from the direction of the normal nl ; Z , the zenith, or intersection of the direction of the plumb line with the celestial sphere (Art. 94).

Astronomical latitude is the angular distance of the zenith from the equator, or the angle between the plumb line and the equatorial plane. In Fig. 49 the astronomical latitude of the point n would be shown by prolonging the line Zn to an intersection with the line WE , the intersection commonly falling slightly to one side of the point l and making the angle a few seconds greater or less than the angle ϕ . The latitude as determined by observation is always the astronomical latitude. Latitudes obtained at sea are of this kind.

Geodetic latitude is the angle between the normal and the equator; in Fig. 49 the geodetic latitude of the point n is the angle ϕ . The geodetic latitude can never be directly observed, nor can the deviation of the plumb line be found by direct meas-

urement. If, however, the latitude of the point n be found by computation (Chapter V) from the astronomical latitudes measured at various other triangulation stations, and these values be averaged in with its own astronomical latitude, the result may be assumed to be free from the effects of plumb line

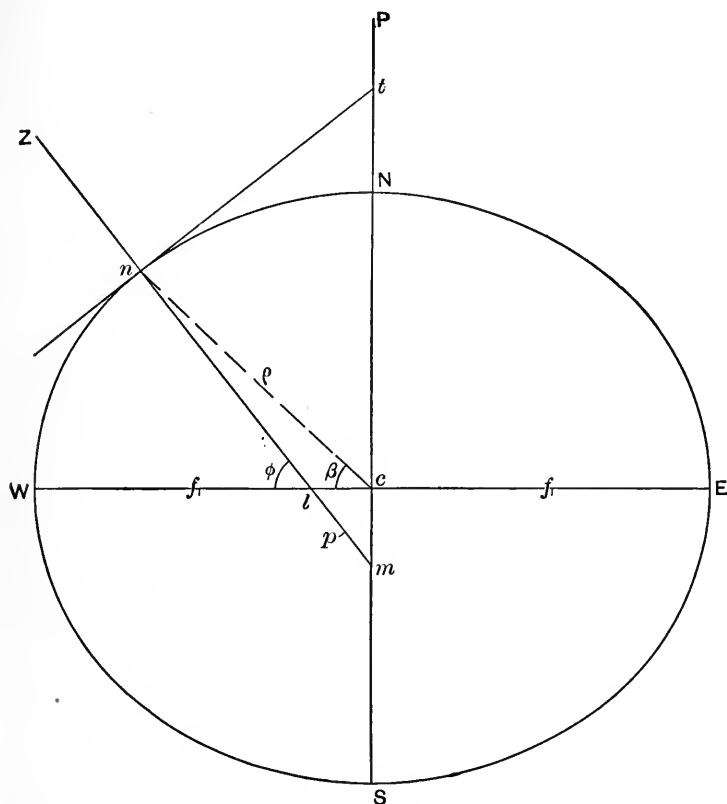

FIG. 49.

deviation and to represent the true geodetic latitude. In geodetic work geodetic latitude is always understood unless otherwise specified.

Geocentric latitude is the angle between the equator and the radius vector from the center of the earth; in Fig. 49 the geocentric latitude of the point n is the angle β . The geocentric

latitude can never be directly observed. It is computed from the geodetic latitude by the formula

$$\tan \beta = \frac{b^2}{a^2} \tan \phi,$$

in which (Art. 69)

$$\log \frac{b^2}{a^2} = 9.9970504 - 10.$$

At the equator the geodetic and geocentric latitudes are each equal to zero. At the poles they are each equal to 90° . At any other point the geocentric latitude is less than the geodetic latitude. By the calculus we have,

$$\tan \phi \text{ (for } \phi - \beta = \text{max.)} = \frac{a}{b}, \text{ or } \phi = 45^\circ 05' 50''.21;$$

$$\tan \beta \text{ (for } \phi - \beta = \text{max.)} = \frac{b}{a}, \text{ or } \beta = 44^\circ 54' 09''.79;$$

or a maximum difference of $11' 40''.42$. The popular conception of latitude is geocentric latitude, but published latitudes are usually astronomical latitudes or geodetic latitudes.

107. Latitude from Observations on the Sun at Apparent Noon. Latitude sufficiently close for many purposes may be obtained by measuring the altitude of the sun at apparent noon, or the moment when it crosses the meridian. The local mean time of apparent noon is found by applying to 12 o'clock (the apparent time) the equation of time as taken from the Nautical Almanac for the given date, interpolating for the given meridian; the corresponding standard time may then be found by Art. 96a. If the correct time is not known the altitude is measured when it attains its greatest value, which soon becomes evident to the observer who is following it up. A good observer can obtain an observation on each limb of the sun before there is any appreciable change of altitude, the mean of the readings being the observed altitude for the center; if only one limb is observed the reading must be reduced to the center by applying a correction for semi-diameter as found in the Nautical Almanac for the given date, the result being the observed altitude. In either case the observed altitude is too large on account of refraction, and must be corrected by an amount which may be taken from

Table VIII for the given observed altitude. Theoretically all solar altitudes are measured too small on account of parallax (due to the observer not being at the center of the earth), the necessary correction being equal to $8''.9$ multiplied by the cosine of the observed altitude. The correction for parallax is a useless refinement with the engineer's transit, but may be applied, if desired, when a sextant or altazimuth instrument is used.

The observation. Single altitudes of the sun may be measured with a transit or with an altazimuth instrument, but a prismatic eyepiece will be required if the altitude exceeds about 60° . The instrument must be very carefully leveled at the moment of taking the observation, and if two readings can be secured the second reading should be taken on the other limb of the sun with the telescope reversed and the instrument carefully releveled, so as to eliminate the instrumental errors. If only one reading is secured it should be corrected for index error if one exists. If the altitude is not greater than about 60° an artificial horizon may be used and the double altitude measured with either of the above instruments or a sextant. If a transit or altazimuth instrument is used it is not reversed on any of the observations, and it must not be releveled between the pointing to the sun and the pointing to its reflected image. If a sextant is used the correction for index error must be applied.

The computation. Having applied the appropriate corrections to the measured altitude, as described above, the true altitude of the sun is obtained within the capacity of the instrument used. This value being subtracted from 90° gives the zenith distance of the sun. The declination of the sun is taken from the Nautical Almanac for the given date and meridian, and this value is the distance of the sun from the equator. Knowing thus the distance from the equator to the sun, and from the sun to the zenith, an addition or subtraction (as the case requires) gives the zenith distance of the equator, and this value (Art. 106) is the observer's latitude. If an ordinary transit is used the latitude thus obtained should be correct to the nearest minute. If a sextant or an altazimuth instrument is used the result is generally much closer to the truth. Theoretically the result should be as accurate as the instrument will read, but there is always a doubt as to the precise value of the refraction, and the latitude obtained is subject to the same uncertainty.

108. Latitude by Culmination of Circumpolar Stars. Stars having a polar distance ($90^\circ - \text{declination}$) less than the observer's latitude never set, but appear to revolve continuously around the pole, and are hence called circumpolar stars. Such stars cross the observer's meridian twice every day, once above the pole (upper culmination) and once below the pole (lower culmination). By referring to Fig. 47, page 166, it will be seen that the latitude of any place is always the same as the altitude of the elevated pole. By observing the altitude of a close circumpolar star at either upper or lower culmination, and combining the result (minus correction for refraction, Table VIII) with the star's polar distance (added for lower culmination, subtracted for upper culmination), the altitude of the elevated pole is obtained, and hence the observer's latitude. The polar distance must be based on the declination for the given date as found in the Nautical Almanac. The latitude as thus determined is much more reliable than that obtained by solar observations.

In the northern hemisphere the best star to observe is Polaris (α Ursæ Minoris), on account of its brightness (2nd magnitude) and its small polar distance (about $1^\circ 10'$ in 1911). About the middle of the year both culminations of Polaris occur during daylight hours, rendering it unsuitable for observation. The next best star to observe is 51 Cephei, which also has a small polar distance (about $2^\circ 48'$ in 1911), but whose brightness (5th magnitude) is not equal to that of Polaris. As these two stars differ about five and one-half hours in right ascension, at least one of them must culminate during the hours of darkness. The sidereal time of upper culmination for either star is the same as its right ascension (the exact value for the given date being taken from the Nautical Almanac), and this is converted into mean time by Art. 100. By a study of Fig. 50, which shows the arrangement of a number of stars in the vicinity of the north pole of the heavens, it will not be difficult to identify Polaris and 51 Cephei. The polar distances of these stars are so small that but little change of altitude occurs when they are near the meridian, so that several observations may be obtained and averaged. If the observations are taken within five minutes each side of the meridian the error in assuming the altitudes unchanging will not exceed $1''$ with Polaris and $2''.5$ with 51 Cephei, and may be ignored when observing with engineering instruments. Within fifteen minutes either

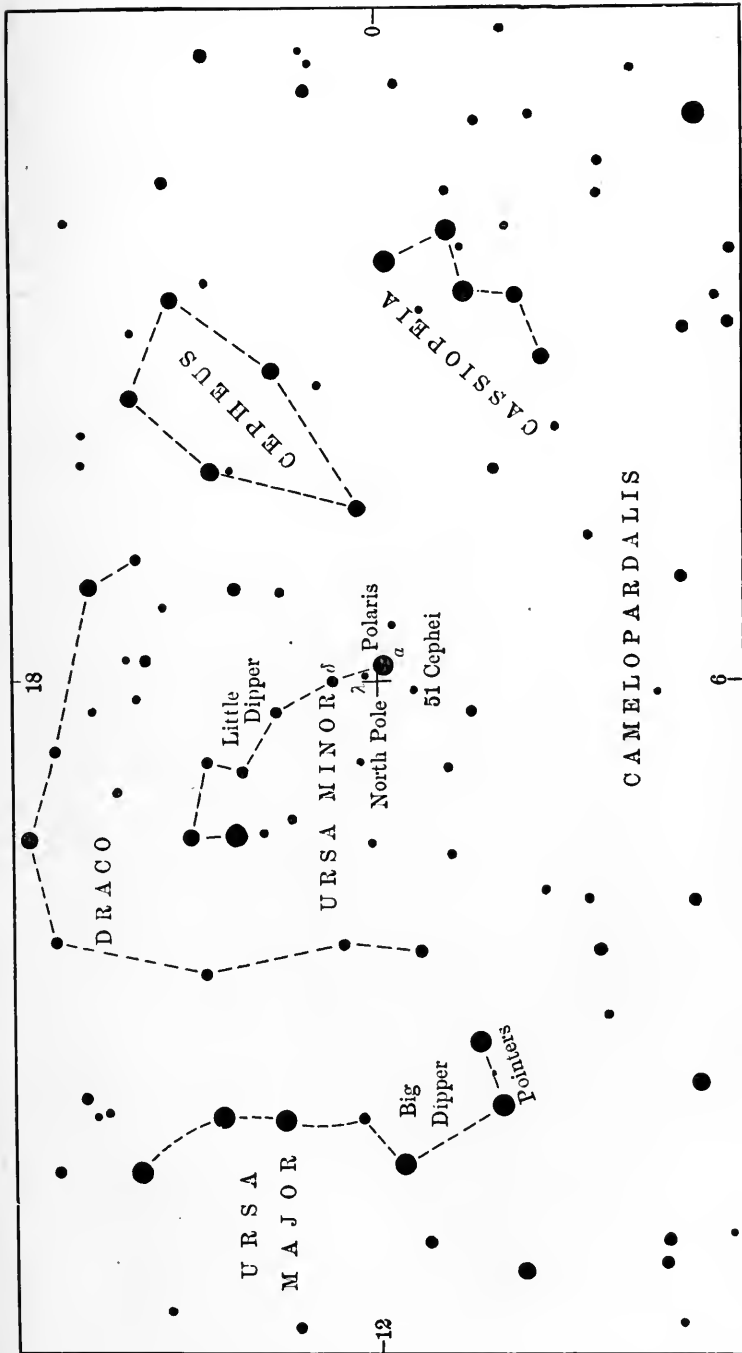

Fig. 50.—Appearance of North Circumpolar Stars at Midnight, June 22, 1911.

way from meridian passage the change in altitude (within 1'' error) may be found, if desired, by multiplying the square of the time (in minutes) from culmination by 0''.044 for Polaris and 0''.104 for 51 Cephei. If this correction is applied it is to be added to observations near upper culmination and subtracted from observations near lower culmination, to obtain the corresponding culminating altitude.

In making the observation the altitude may be directly measured with a transit or an altazimuth instrument. In order to eliminate instrumental errors at least two readings should be averaged together, one taken with telescope direct and one with telescope reversed. The instrument must be leveled after reversing, as it is necessary to have the bubbles exactly central at the moment each reading is taken. If by any accident only one reading is secured it must be corrected for index error, if one exists. The two readings should be obtained as near together and as near culmination as the skill of the observer will permit; two readings not over three minutes each way from the meridian are easily obtained. A better result will be obtained if four readings are averaged together, taking one direct reading, then two reversed readings, and then one direct reading, both bubbles being kept exactly central while taking each reading; this program is easily accomplished within five minutes each side of the meridian. If an artificial horizon is available it is better to measure the double altitude between the star and its image in the mercury, using either of the above instruments or a sextant. Angles measured with a sextant are always corrected for index error and sometimes for eccentricity. If a transit or altazimuth instrument is used the double altitude is obtained by reading on the star and then on its image, without reversing or leveling between the pointings. Two such double altitudes are easily obtained within three minutes each way from the meridian, using either of these instruments or a sextant. Latitudes obtained by the methods of this article should theoretically be correct within the reading capacity of the instrument, but may be further in error on account of the uncertainties of refraction.

109. Latitude by Prime Vertical Transits. Stars whose declination is less than the observer's latitude apparently cross the prime vertical (true east and west vertical plane) twice during each revolution of the earth on its axis. If the time elapsing

between the east and west transit of any star is noted the observer's latitude may be found by computation. Referring to Fig. 51, P is the elevated pole of the celestial sphere; PZS' , the observer's meridian; Z , the observer's zenith; SZS'' , the prime vertical; $\mathcal{E}S'S''$, the star's apparent path; PS , the star's polar distance; and PZ , the observer's co-latitude. In the spherical triangle PZS , right-angled at Z , the side PS and the angle SPZ are known; the side PS being the star's polar distance, and the angle SPZ equal to half the elapsed time changed to angular units by multiplying by 15. Hence, solving for the latitude ϕ , we have

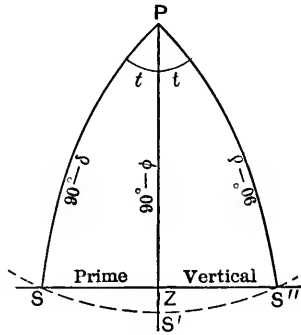

FIG. 51.

$$\tan \phi = \frac{\tan \delta}{\cos t}.$$

In this method the uncertainties of refraction are largely eliminated because the times of transit are observed instead of the altitudes. The success of the method depends on the precision with which the meridian is determined and the prime vertical located therefrom, and the accuracy with which the telescope

is made to describe a vertical plane. The method, though not much used in the United States, is one of the best, and with suitable instruments and refinements will determine latitude within a fraction of a second. If a close determination of latitude has to be made with an altazimuth instrument without a micrometer eyepiece, but which is furnished with a good striding level, this method will probably give better results than any other.

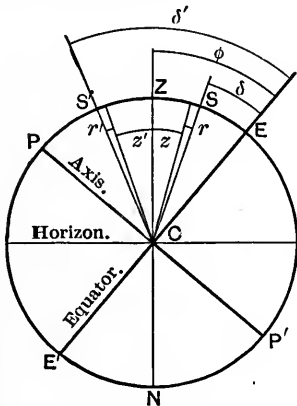

FIG. 52.

110. Latitude with the Zenith Telescope. This method (otherwise known as the Harrow-Talcott

method) is the one which the U. S. Coast and Geodetic Survey

always uses for the precise determination of latitude, the probable error of the results being readily kept below a tenth of a second. Referring to Fig. 52, page 193, $PEP'E'$ is a meridian section of the celestial sphere; PP' , the polar axis; EE' , the equator; C , the observer; Z , the zenith; S and S' , two stars with nearly equal (within about $15'$) but opposite meridian zenith distances, and with a sufficient difference of right ascension to enable each one to be observed in turn as it crosses the meridian.

Let $\phi = EZ =$ observer's latitude;
 $\delta = ES =$ declination of S (from Nautical Almanac);
 $\delta' = ES' =$ declination of S' (from Nautical Almanac);
 $z =$ apparent zenith distance of S ;
 $z' =$ apparent zenith distance of S' ;
 $r =$ refraction correction for z (from Table VIII);
 $r' =$ refraction correction for z' (from Table VIII);

then

$$\begin{aligned} z + r &= ZS = \text{true zenith distance of } S; \\ z' + r' &= ZS' = \text{true zenith distance of } S'; \end{aligned}$$

whence

$$\begin{aligned} \phi &= \delta + z + r \\ \phi &= \delta' - (z' + r') \\ \hline 2\phi &= (\delta + \delta') + (z - z') + (r - r') \end{aligned}$$

and we have for the latitude

$$\phi = \frac{1}{2}[(\delta + \delta') + (z - z') + (r - r')].$$

In this equation the quantities $(\delta + \delta')$ and $(r - r')$ are known, so that it is only necessary to obtain $(z - z')$ by observation to determine the latitude. The quantity $(z - z')$ is the difference between the zenith distances of the two stars S and S' , and if this quantity is not over about $15'$ it can be measured with great accuracy by means of the zenith telescope (see Fig. 53). The instrument illustrated has an aperture of about three inches, a focal length of nearly four feet, and a magnifying power of 100. The telescope being set at a proper vertical angle for a given pair of stars is not changed thereafter, but each star is brought into the field of view by revolving the instrument on its vertical axis, and the difference of zenith distance is measured entirely

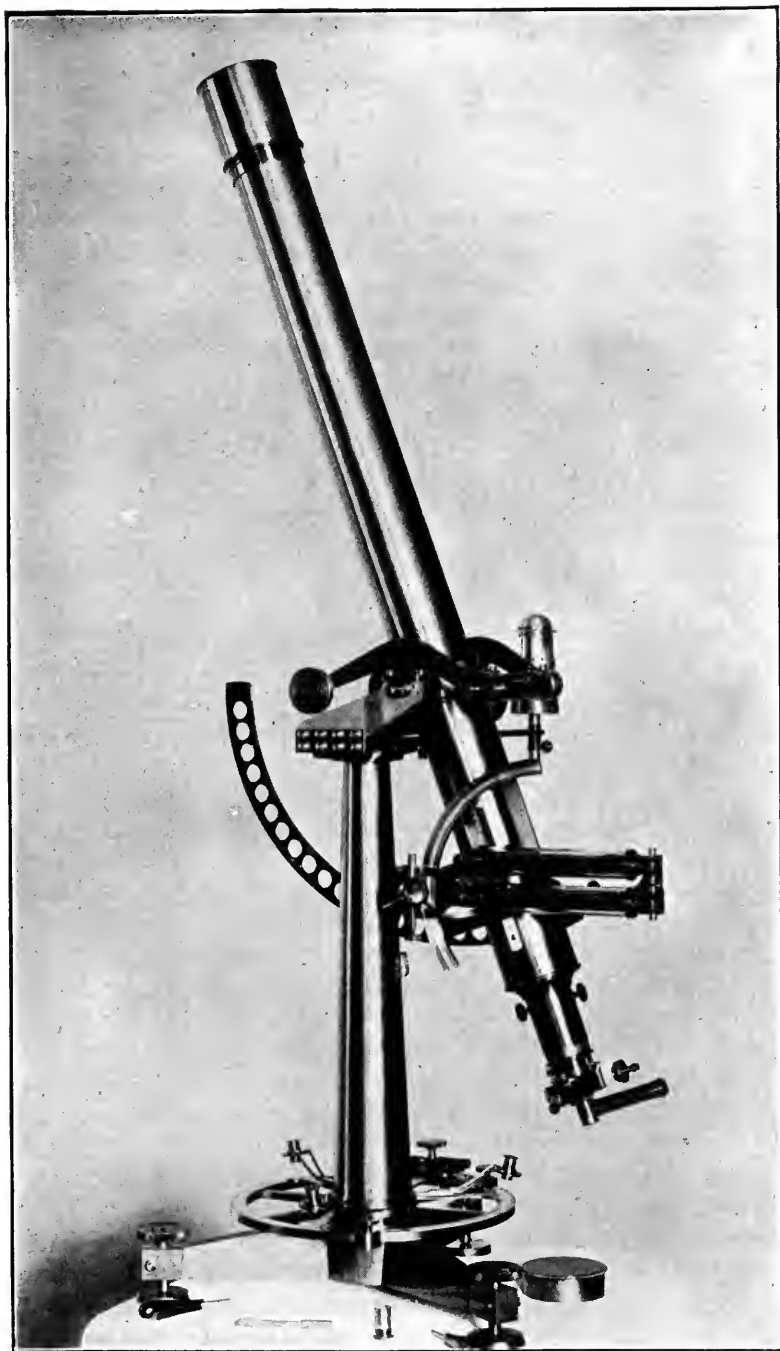

FIG. 53.—Zenith Telescope.
From a photograph loaned by the U. S. C. and G. S.

with the micrometer eyepiece. Many pairs of stars are observed, and many refinements in observation and computation are required in the highest grade of work. For a complete discussion of the method the reader is referred to Appendix No. 7, Report for 1897-98, U. S. Coast and Geodetic Survey. An altazimuth instrument with a micrometer eyepiece will give very good results by the above method, if used with proper precautions.

111. Latitude Determinations at Sea. Many methods have been devised for determining latitude at sea. Greenwich time may or may not be required, according to the method used, but is generally available from the ship's chronometers. In any case the observation consists in measuring with the sextant the altitude of one or more of the heavenly bodies above the sea horizon. All such altitudes are reduced to the true horizon by applying a correction for dip, as explained in Art. 105, this correction being in addition to any others which the observation requires to determine the true altitude. The most common observation for latitude is for the altitude of the sun at apparent noon, as explained in Art. 107. The meridian altitude of the pole star or other bright star is also often observed, the result in either case being worked out as explained for circumpolar stars in Art. 108. The error of a latitude determination at sea may range upwards from a fraction of a mile, depending on the circumstances surrounding the observation.

112. Periodic Changes in Latitude. It is now known that the earth has a slight wobbling motion with respect to the axis about which it rotates. In consequence of this motion the north and south poles do not occupy a fixed position on the surface of the earth, but each one apparently revolves about a fixed mean point in a period of about 425 days. The distance between the actual pole and the mean point is not constant, but varies (during a series of revolutions) between about $0''.16$ (16.3 ft.), and about $0''.36$ (36.6 ft.). As the equator necessarily shifts its position in accordance with the movement of the poles, it follows that the latitude at every point on the surface of the earth is subject to a continual oscillation about its mean value, the successive oscillations being of different extent and ranging from $0''.16$ to $0''.32$ each way from the middle. In precise latitude work, therefore, the date of the determination is an essential part of the record.

LONGITUDE

113. General Principles. The *longitude* of any point on the surface of the earth is the angular distance of the meridian of that point from a given reference meridian, being positive when reckoned westward and negative when reckoned eastward. The meridian of Greenwich has been universally adopted (since 1884) as the standard reference meridian of the world, but other meridians (Washington, Paris, etc.) are often used for special work. Since time is measured by the uniform angular movement of the earth on its axis (west to east), it follows that longitude may be expressed equally well in either angular units or time units. As 360° of arc correspond to twenty-four hours of time (mean or sidereal, Art. 95), the change from the angular to the time system is evidently made by dividing by 15, and vice versa; thus the longitude of Washington west from Greenwich may be written as $77^\circ 03' 56''.7$, or $5^{\text{h}} 08^{\text{m}} 15^{\text{s}}.78$, as preferred. At the same absolute instant of time the true local time of any station differs from the true local time of any other station by the angular divergence (expressed in time units) of the meridians of these two stations; the difference of longitude of any two stations, therefore, is identical with the difference of local time. At the same instant of time, the difference between the local mean time and the sidereal time at any station is the same for all points in the world, so that the difference of local time between any two given stations is always *numerically* the same whether the comparison is based on local mean time or sidereal time. From the nature of the case, it is evident that standard time (Art. 96a) bears no relation to the longitude of a station.

Longitude as described above is *geodetic longitude*. Longitude obtained from observations on heavenly bodies, or *astronomical longitude*, is identical with geodetic longitude except where local deviation of the plumb line (Art. 75) exists. The geodetic longitude of a point can never be directly observed, nor can the deviation of the plumb line be found by direct measurement. If, however, the longitude of any point be found by computation (Chapter V) from the astronomical longitudes measured at various other triangulation stations, and these values be averaged in with its own astronomical longitude, the result may be assumed to be free from the effects of plumb line deviation and to represent

the true geodetic longitude. In geodetic work geodetic longitude is always understood unless otherwise specified.

The longitude of any given point is ordinarily obtained by finding how much it differs from that of some other point whose longitude has already been well determined. The finding of this difference of longitude is essentially the finding of the difference of local time between the two points, the westerly point having the earliest time, and vice versa. The local time is found by the methods heretofore given, and the comparison is made as about to be explained.

114. Difference of Longitude by Special Methods. These methods are rarely used any more, but are of considerable scientific interest, and hence are here briefly mentioned.

By special phenomena. Certain astronomical phenomena, such as the eclipses of Jupiter's satellites, occur at the same instant of time as seen at any point on the earth from which they may be visible. These eclipses usually occur several times in the course of a month, the Washington mean time of the event being given in the Nautical Almanac. The observer notes the true local time at which the eclipse occurs, the error and rate of his timepiece having been previously determined. The difference between the Washington mean time and the local mean time of the eclipse is the observer's longitude from Washington. Eclipses of the moon may also be used in the same manner. Longitude obtained by these methods is apt to be several seconds of time in error, or a minute or more in arc.

By flash signals. Two observers, having obtained their own local time by proper observations, may each note the reading of their own clock at the same instant of time, this instant being determined by an agreed signal visible to both. Such a signal may be the flash of a heliotrope by day, or any suitable light signal by night. The difference of local time is then the difference of longitude. The error by this method may be kept below a second of time by averaging the results of a number of signals. This method usually requires one or more intermediate stations to be established to overcome the lack of intervisibility, and is generally an expensive one.

115. Longitude by Lunar Observations. If an observer notes his true local time (expressed as mean time) for any particular position of the moon, and obtains from the Nautical Almanac

the Greenwich mean time when the moon occupied such a position, the longitude from Greenwich is given by the corresponding difference of time. Many methods have been devised on this basis, requiring laborious computations in their application, and in many of the methods not leading to very accurate results. Lunar methods are therefore not generally used except on long sea voyages or long exploration trips. A few of the methods are given below, but only in the roughest outline.

By lunar distances. The angle between a star, the center of a planet, or the near edge of the sun, and the illuminated edge of the moon may be measured by a sextant, and reduced to what it would have been if it had been observed at the center of the earth and measured to the center of the moon. The Greenwich time of this position can be determined from the Nautical Almanac and compared with the local time at which the observation was made. The accuracy attainable is about five seconds of time.

By lunar culminations. The local time of meridian passage of the moon's illuminated limb may be noted, expressed as sidereal time and corrected for semi-diameter, giving the moon's right ascension at the given instant, and Greenwich mean time for this value of the right ascension be compared with the observed local time. The accuracy attainable is about five seconds of time.

By lunar occultations. The occultation (covering) of a star by the moon may be observed, noting the local time of immersion (disappearance), or emersion (reappearance), or both, in which case the apparent right ascension of the corresponding edge of the moon at the given instant is the same as the right ascension of the given star. When proper correction has been made for refraction, parallax, semi-diameter, etc., the true right ascension becomes known for the given instant, and the corresponding Greenwich time is compared as before with the local observed time. This method, with the exception of telegraphic methods, is one of the best that is known for longitude work. When a number of such determinations are averaged together, an accuracy within a second of time is attainable.

116. Difference of Longitude by the Transportation of Chronometers. When this method is used a number of chronometers (from 5 to 50) are carried back and forth (from about 5 round trips upwards) between the two points whose difference of longitude

is desired. On reaching each station the traveling chronometers are compared with the local chronometers. The errors of the local chronometers are determined astronomically at or near the time of comparison. The various values thus obtained for the difference of time between the two stations are averaged together and the result taken as the difference of longitude. Owing to the fact that each round trip furnishes two determinations that are oppositely affected by similar errors, and also to the refinements of method and reduction that are used in practice, the errors due to chronometer rates and irregularities are largely eliminated from the average result. The accuracy attainable (in time units) may range between a few tenths of a second and less than a single tenth of a second, depending on the distance between stations, the number of trips made, and the number of chronometers transported. Longitude determinations by this method are now rarely made, except where telegraphic connection is not available. In order to make an accurate comparison of two mean time chronometers each one is independently compared with the same sidereal chronometer, and two sidereal chronometers are similarly compared by mutual reference to a mean time chronometer. Sidereal chronometers continually gain on mean time chronometers. the beats or ticks (half seconds) gradually receding from and approaching a coincidence that occurs about every three minutes. When the beats exactly coincide the chronometers differ precisely by the value in half seconds indicated by the subtraction of their face readings. As the ear can be trained to detect a lack of coincidence as small as the one-hundredth part of a second, a comparison can be made with this degree of precision.

117. Difference of Longitude by Telegraph. Where telegraphic connection can be established between two stations it furnishes the best means of exchanging time signals, both on account of the great accuracy attainable and the comparative inexpensiveness. Difference of longitude obtained in this manner can be made more accurate than is possible by any other known method. The lines of the telegraph companies ramify in all directions, and the temporary use of a suitable wire can usually be obtained at reasonable cost, so that it is only necessary to erect short connecting lines between the observing stations and the telegraph stations. The most important applications of the method are as outlined below.

By standard time signals. This method furnishes a quick means for an approximate longitude determination. Standard time can be obtained at any telegraph station with a probable error of less than a second. The observer's true local mean time is obtained by any of the simpler methods of observation. The difference of these times is the difference of longitude between the given standard time meridian and the meridian of the observer's station.

By star signals. The difference of longitude of any two stations is identical with the sidereal time which elapses between the transit of any given star over the meridian of the easterly station, and the transit of the same star over the meridian of the westerly station; so that it is only necessary to observe how long it takes for any star to pass between the meridians of two stations to know their difference of longitude. In making use of this principle a chronograph (Art. 103c) is placed at each station, and these chronographs are connected by a telegraph line. A break-circuit chronometer, which may be placed anywhere in this line, records its beats on both chronographs. As the selected star crosses the meridian of the easterly observer he records this instant of time on both chronographs by tapping his break-circuit signal key. When the same star crosses the meridian of the westerly observer he likewise records this new instant of time on both chronographs. Each chronograph, therefore, contains a record of the time between transits, but the records are not identical, as it takes time for the signals to pass between the stations; in other words, each signal is recorded a little later on the distant chronograph than it is on the home chronograph. The record of the easterly chronograph thus becomes too great, and the record of the westerly one correspondingly too small; but the mean of the two records eliminates this error and gives (when corrected for chronometer rate) the true difference of longitude between the stations. In actual work the transits of many stars are observed at each station, so as to obtain an average value for the difference of longitude. The accuracy attainable is about 0.01 of a second of time. This method is one of the best, and was formerly largely used by the Coast Survey. The objection to the method is the difficulty of securing the monopoly of the telegraph line during the long period while the observations are in progress, so that it is no longer much in use.

By arbitrary signals. This is the standard method of the Coast Survey at the present time, and requires the use of the telegraph line for only a few minutes during an arbitrary period (previously agreed upon) on each night that observations are in progress. In this method a chronometer and chronograph are installed at each station, and each chronometer records its beats on the home chronograph only. Each observer makes his own time observations, which are likewise recorded on his own chronograph alone. Observations at each station are taken both before and after the exchange of signals in order to determine the corresponding chronometer's rate as well as its error. As far as possible the same stars are observed at each station, in order to avoid introducing errors of right ascension. In the most precise work the observers exchange places on successive nights, in order to eliminate the effects of personal equation, and numerous other refinements are introduced. The chronograph sheet at each station enables the true time at that station to be computed for any instant within the range of the record, and the difference of these true times at any one instant of time is the difference of longitude between the stations. The whole object of the exchange of signals, therefore, is to identify the same instant of time on both chronograph sheets. At the agreed time for the exchange of signals the two stations are thrown into circuit with the main telegraph line, with connections so arranged that signals (momentary breaking of circuit) sent by either station are recorded on both chronographs. No signal, however, is recorded at exactly the same instant at both stations, on account of the time required for its passage between them. The difference of longitude as based on the signals from the western station is hence too large, and that based on the eastern station's signals correspondingly too small. The mean of the two values is taken as the true difference of longitude, while the difference of the two values represents double the time of signal transmission. In the Coast Survey program two independent sets of ten pairs of stars each are observed on five successive nights, the observers then exchanging places and continuing the observations in the same manner for five more nights. Signals are exchanged once each night at about the middle time for the work of both stations, the western station sending thirty signals at intervals of about two seconds, followed by thirty similar signals from the eastern

station. These signals were formerly sent by the chronometers, but are now sent by tapping a break-circuit signal key. The accuracy attainable, as in the case of star signals, is about 0.01 of a second of time.

118. Longitude Determinations at Sea. Every sea-going vessel carries one or more chronometers, the error and rate of each being determined before leaving port, so that the Greenwich time of any instant is always very closely known. The local time for the ship's position having been determined for any instant (Art. 105), and the corresponding Greenwich time being obtained from the chronometers, it is only necessary to take the difference of these times to have the ship's longitude from Greenwich. The result thus obtained is expressed in time units, but is readily converted into angular units by multiplying by 15 (Art. 113). In case of failure of the chronometers, longitude at sea can still be determined in a number of ways not requiring a previous knowledge of Greenwich time, such as the method of lunar distances (Art. 115). Discussions and explanations of these methods can be found in all works on Navigation and Nautical Astronomy. A longitude determination at sea may be in error from a fraction of a mile to a number of miles, depending on the surrounding circumstances.

119. Periodic Changes in Longitude. As explained in Art. 112, the poles of the earth are not fixed in position, but each one apparently revolves about a mean point in a period of about 425 days, the radius-vector varying (during a series of revolutions) between about $0''.16$ and $0''.36$. The result of this shifting of the poles is to cause the longitude of any point to oscillate about a mean value, the amplitude of the oscillation depending on the location of the point. In precise longitude work, therefore, the date of the determination is an essential part of the record.

AZIMUTH

120. General Principles. By the *azimuth* of a line (or a direction) from a given point is meant its angular divergence from the meridian at that point, counting clockwise from the south continuously up to 360° . From any intermediate point on a straight line the azimuths towards the two ends always differ by exactly 180° , so that in any case it is only necessary to determine

the azimuth in one direction. In passing along a straight line the azimuth varies continuously from point to point, unless the line be the equator or a meridian. The cause of this change and the methods for computing it are explained in detail in Arts. 68 to 73, inclusive. The following articles are concerned solely with the determination of azimuth (and hence of the meridian) at any one given point.

Geodetic azimuth is that in which the angular divergence from the meridian is measured in a plane which is tangent to the spheroid at the given point. Azimuth obtained from observations on heavenly bodies, or *astronomical azimuth*, is identical with geodetic azimuth except where local deviation of the plumb line (Art. 75) exists. The geodetic azimuth of a line from a given point can never be directly observed, nor can the deviation of the plumb line be found by direct measurement. If, however, the azimuth of a line from a given point be found by computation (Chapter V) from the azimuth determinations made at various other triangulation stations, and these values be averaged in with the observed value, the result may be assumed to be free from the effects of plumb line deviation and to represent the true geodetic azimuth. In geodetic work geodetic azimuth is always understood unless otherwise specified.

121. The Azimuth Mark. This is the signal which gives the direction of the line whose azimuth is being determined. An azimuth mark should not be placed less than about a mile from the observer, otherwise a change of focus will be required between the heavenly body and the mark. Experience has shown that refocussing during an observation is very undesirable. When azimuth is obtained by solar observations any of the usual daytime signals (Art. 19) may be used, being located at a special azimuth point or a regular triangulation station as circumstances may require. When azimuth is obtained by stellar observations a special azimuth point is generally located one or more miles from the instrument. The azimuth mark should be mounted on a post or otherwise raised about five feet above the ground, and generally consists of a bull's-eye lantern enclosed in a box or placed behind a screen, a small circular hole being provided for the light to pass through on its way to the observer. If the diameter of the hole does not subtend over a second of arc (0.3 of an inch per mile) at the eye of the observer, the light will

closely resemble a star in both apparent size and brilliancy, which is the object sought. The face of the box or screen is often painted with stripes or other design so that it may also be observed in the daytime.

122. Azimuth by Sun or Star Altitudes. The altitude of any heavenly body as seen by an observer at a given point is constantly changing, each different altitude corresponding to a particular azimuth which can be computed if the latitude and longitude are approximately known. For the degree of accuracy sought by this method it is sufficient to know the latitude to the nearest minute and the longitude within a few degrees. The difference in azimuth of any two lines from the same point is always exactly the same as their angular divergence. If, therefore, the horizontal angle between the azimuth mark and the given heavenly body is measured at the same moment that the altitude is taken, the azimuth of the line to the azimuth mark is obtained by simply combining the computed azimuth of the heavenly body with this measured horizontal angle. The observation may be made with a transit or an altazimuth instrument. The probable error of a single determination should not exceed a minute of arc with the ordinary engineer's transit, nor a half minute with the larger instruments. The actual error may be larger than the probable error on account of the uncertainties of refraction.

122a. Making the Observation. The best time for making an observation on the sun is between about 8 and 10 o'clock in the morning and 2 and 4 o'clock in the afternoon. The sun should not be observed within less than two hours of the meridian because its change in azimuth is then so much more rapid than its change in altitude; nor when it is much more than four hours from the meridian on account of the uncertain refraction at low altitudes. In the latitude of New York it is not desirable to observe the sun for azimuth in the winter time because its distance from the prime vertical during suitable hours results in such a rapid movement in azimuth as compared with its movement in altitude. Star observations may be made at any hour of the night, selecting stars which are about three hours from the meridian and near the prime vertical, and hence changing but slowly in azimuth as compared with the change in altitude. The observations are made in sets of two, taking one reading with the telescope direct and the other with the telescope reversed, the mean

horizontal and the mean vertical angle constituting the observed values for that set. Several independent sets should be taken and separately reduced, the mean of the resulting azimuths being the most probable value. The instrument should be in perfect adjustment and be leveled up with the long bubble or the striding level, and should not be releveled except at the beginning of each set. The center of the sun is not directly observed, but the reading is taken with the image of the sun tangent to the horizontal and vertical hairs. A complete set is made up as follows: Sight on the mark and read the horizontal circle; unclamp the upper motion and bring the sun's image tangent to the horizontal and vertical hairs in that quadrant where it appears by its own motion to approach both hairs; note the time to the nearest minute and read both circles; unclamp the upper motion, invert the telescope, and bring the sun's image tangent in that quadrant where it appears to recede from both hairs; note the time and read both circles; unclamp the upper motion, sight on the mark and read the horizontal circle. A star set is taken in the same manner except that in each pointing the image of the star is bisected by both hairs. If the instrument does not have a full vertical circle the telescope is not inverted between the observations, but an index correction must be applied to the observed altitudes. The values used in the computations of the next article are those which correspond to the center of the observed object. If for any reason only one observation is secured on the sun, thus leaving the set incomplete, the observed altitude is reduced to the center by applying a correction for semi-diameter, and the observed horizontal angle is reduced to the center by applying a correction found by dividing the semi-diameter by the cosine of the altitude. The semi-diameter is taken from the Nautical Almanac for the given time and date, and the correction is added or subtracted in accordance with the particular limb of the sun which was observed.

122b. The Computation. It is best to reduce each set independently and average the final results. The observed altitude must first be reduced to the true altitude. The apparent altitude of all heavenly bodies is too large on account of refraction, the required correction being found in Table VIII. The apparent altitude of the sun is also too small on account of parallax, the amount being equal to $8''.9$ multiplied by the cosine of the

observed altitude, but this correction is so small it would seldom be applied in this method.

In the polar triangle ZPS , Fig. 47, page 166, the three sides are known. ZP , the co-latitude, is found by subtracting the observer's latitude from 90° . PS , the polar distance or co-declination, is found by subtracting the declination of the observed body from 90° . In the case of the sun the declination is constantly changing and must be taken for the given date and hour (the time being always approximately known). The sun's declination for Greenwich mean noon is given in the Nautical Almanac for every day in the year, and can be interpolated for the Greenwich time of the observation; the Greenwich time of the observation differs from the observer's time by the difference in longitude in hours, remembering that for points west of Greenwich the clock time is earlier and vice versa. ZS , the co-altitude, is found by subtracting the true (reduced) altitude of the observed body from 90° . Using the notation of Fig. 47, we have from spherical trigonometry,

$$\sin \delta = \cos z \sin \phi + \sin z \cos \phi \cos A,$$

whence

$$\cos A = \frac{\sin \delta - \cos z \sin \phi}{\sin z \cos \phi},$$

which for logarithmic computation is reduced to the form

$$\tan \frac{1}{2}A = \sqrt{\frac{\cos \frac{1}{2}[z + (\phi + \delta)] \sin \frac{1}{2}[z + (\phi - \delta)]}{\cos \frac{1}{2}[z - (\phi + \delta)] \sin \frac{1}{2}[z - (\phi - \delta)]}}.$$

The value of A thus found is the azimuth angle (from north branch of meridian) of the given heavenly body at the moment of observation. If the observed body was east of the meridian its azimuth (from the south point) equals $180^\circ + A$; if west of the meridian, $180^\circ - A$. The azimuth of the azimuth mark is then found by combining the azimuth of the observed body with the corresponding angle between the azimuth mark and the observed body, the combination being made by addition or subtraction as the case requires.

123. Azimuth from Observations on Circumpolar Stars. The simplest and most accurate method of determining azimuth is by suitable observations on close circumpolar stars, furnishing any desired degree of precision up to the highest attainable. In

northern latitudes the best available stars are α Ursæ Minoris (2nd magnitude), δ Ursæ Minoris (4th magnitude), 51 Cephei (5th magnitude), and λ Ursæ Minoris (6th magnitude). Of these four α Ursæ Minoris, commonly known as *Polaris*, is usually chosen by engineers on account of its brightness, the other three being barely visible to the naked eye. The four stars named may be identified by reference to Fig. 50, page 191.

Owing to the rotation of the earth on its axis the azimuth of any star, as seen from a given point, is constantly changing, but the value of the azimuth may be computed for any given instant of time when the position of the observer is known. The most favorable time for the observation of a close circumpolar star is at or near elongation (greatest apparent distance east or west of the meridian), as its motion in azimuth is then reduced to a minimum; but entirely satisfactory results may be obtained from observations taken at any time within about two hours either way from elongation; the only point involved is that time must be known with increasing accuracy the greater the interval from elongation, in order to secure the same degree of precision in the azimuth determination. In any case the actual observation consists in measuring the horizontal angle between an azimuth mark and the given star, and noting the time at which the star pointing is made. The azimuth of the mark is then obtained by combining the measured angle (by addition or subtraction as the case requires) with the computed azimuth of the star. The details of the observation will depend on the instrument available and the degree of precision desired in the result. The instruments used may be the ordinary engineer's transit, the larger transits equipped with striding levels, the repeating instrument, or the direction instrument. Close instrumental adjustments are necessary for good work. The methods ordinarily used are the direction method, the repeating method, and the micrometric method. Certain formulas enter more or less into all the methods.

123a. Fundamental Formulas. The following symbols are involved in the formulas as here given:

- A = azimuth of star (at any time) from north point,
 + when east, - when west;
 A_e = azimuth of star at elongation;

- A_0 = azimuth of star at mean hour angle of n pointings;
 n = number of pointings to star;
 t = hour angle of star (at any time), + when star is west, - when east, or may be counted westward up to 24 hours or 360° ;
 t_e = hour angle of star at elongation;
 Δt = interval of any one hour angle from the mean of n given hour angles;
 C = curvature correction in seconds of arc;
 D = correction for diurnal aberration in seconds of arc;
 D_e = ditto for a close circumpolar star at elongation;
 ϕ = latitude, + when north, - when south;
 δ = declination of star, + when north, - when south;
 A_m = azimuth of mark from north point, + to east, - to west;
 Z = azimuth of mark from south point;
 h = mean altitude of star;
 d = value of one division of bubble tube in seconds;
 w, w' , etc. = readings of west end of bubble tube when sighting on star;
 W = mean value of w, w' , etc.;
 e, e' , etc. = readings of east end of bubble tube when sighting on star;
 E = mean value of e, e' , etc.;
 b = mean inclination of telescope axis in seconds when sighting on star;
 x = angle correction in seconds due to inclination of telescope axis;
 α = star's right ascension;
 S = sidereal time at any instant;
 S_e = sidereal time of star's elongation.

a. Hour angle at any instant. The hour angle of a star (in time units) at any instant of sidereal time is given by the formula

$$t = S - \alpha.$$

The corresponding value of t in angular units is obtained (Art. 95) by multiplying by 15. The particular unit in which t is to be expressed is always apparent from the formula in which it occurs. If local mean time or standard time is used it must be

reduced to sidereal time (Art. 99) before being used in the formula for t .

b. Hour angle at elongation. In the polar triangle ZPp , Fig. 47, page 166, p may be taken to represent Polaris or any other star at elongation, or greatest apparent distance from the meridian for the observer whose zenith is at Z . In this triangle the side PZ is the observer's co-latitude, the side Pp is the star's co-declination, and the angle ZpP equals 90° on account of the tangency at the point p . Solving for the angle ZPp , or the star's hour angle at elongation, we have

$$\cos t_e = \frac{\tan \phi}{\tan \delta}.$$

c. Time of elongation. Having found t_e from the formula in (b), the sidereal time of elongation is given by the formulas

$$S_e = \alpha + t_e \quad (\text{western elongation}),$$

$$S_e = \alpha - t_e \quad (\text{eastern elongation}).$$

The sidereal time thus obtained is changed to local mean time or standard time by Art. 100 when so desired.

d. Azimuth at elongation. If the above triangle (b) be solved for the angle PZp , or the star's azimuth at elongation, we have

$$\sin A_e = \frac{\sin \text{polar distance}}{\cos \text{latitude}} = \frac{\cos \delta}{\cos \phi}.$$

e. Reduction to elongation. If the angle between the azimuth mark and a close circumpolar star is measured within about thirty minutes either way from elongation, the measured angle may be reduced very nearly to what it would have been if measured at elongation by applying the following correction:

$$A_e - A = \tan A_e \frac{2 \sin^2 \frac{1}{2}(t_e - t)}{\sin 1''}.$$

The quantity $(t_e - t)$ is equivalent to the sidereal time interval from elongation, and may be substituted directly without computing the hour angle represented by t . If the mean or standard

time interval is thus used the value which the formula gives for $(A_e - A)$ must be increased by $\frac{1}{150}$ part of itself.

f. Azimuth at any hour angle. If the star is observed at any other hour angle than that which corresponds to elongation, a polar triangle will be formed similar to ZPp , Fig. 47, page 166, but with all the angles oblique. In this case the azimuth A at the given hour angle t is given by the formula,

$$\begin{aligned} \tan A &= - \frac{\sin t}{\sin \phi \cos t - \cos \phi \tan \delta} \\ &= - \frac{\cot \delta \sec \phi \sin t}{1 - \cot \delta \tan \phi \cos t} \\ &= - \cot \delta \sec \phi \sin t \left(\frac{1}{1-a} \right), \end{aligned}$$

in which

$$a = \cot \delta \tan \phi \cos t.$$

g. The curvature correction. If a series of observations are taken on a star the hour angle and corresponding azimuth must necessarily be different for each pointing. The mean value of such azimuths is frequently desired, and may of course be found by computing each azimuth separately and averaging the results. The same value, however, may be obtained much more simply by computing the azimuth corresponding to the mean of the several hour angles, and then applying the so-called curvature correction to reduce this result to the mean azimuth desired. The reason that such a correction is required is because the motion of a star in azimuth is not uniform, but varies from zero at elongation to a maximum at culmination. In the case of a close circumpolar star, and a series of observations not extending over about a half hour, the curvature correction is given by the formula

$$C = \tan A_0 \frac{1}{n} \Sigma \frac{2 \sin^2 \frac{1}{2} \Delta t}{\sin 1''},$$

in which Δt is expressed in angular value, or

$$C = \tan A_0 \frac{(15)^2}{2} \sin 1'' \frac{1}{n} \Sigma (\Delta t)^2,$$

in which Δt is expressed in sidereal seconds of time. If Δt is expressed in mean-time seconds the value of C thus obtained must be increased by $\frac{1}{180}$ part of itself.

$$\log \left[\frac{(15)^2}{2} \sin 1'' \right] = 6.7367275 - 10.$$

The sign of the curvature correction C is known from the fact that the true mean azimuth always lies nearer the meridian than the azimuth that corresponds to the mean hour angle. From the nature of the case it is evident that the several values of Δt in time units may be obtained directly from the observed times (without changing them to hour angles) by taking the differences between each observed time and the mean of all the observed times.

h. Correction for inclination of telescope axis. If the axis of the telescope is not horizontal the line of sight will not describe a vertical plane when the telescope is revolved on this axis, and hence the measured angle between the star and the mark will be in error a corresponding amount. The inclination of the axis is found from the readings of the striding level. If the level is reversed but once the usual formula is

$$b = \frac{d}{4}[(w + w') - (e + e')];$$

but if the level is reversed more than once it is more convenient to write

$$b = \frac{d}{2}(W - E).$$

So far as the present purpose is concerned these formulas are equally applicable whether the level is actually reversed on the pivots, or reversed in direction because the instrument is turned through 180° . In one case the value obtained is the actual average inclination of the axis, while in the other case it is the net inclination. By the east or west end of the bubble tube is meant literally the end which happens to be east or west when the reading is taken. The correction required on account of the inclination b , due to the altitude of the star, is

$$x = b \tan h.$$

The value of x thus obtained is to be subtracted algebraically from the computed azimuth of the mark. Ordinarily a similar correction for inclination due to altitude of mark is not required, as the mark is generally nearly in the horizon of the instrument. If, however, the angular elevation (+ altitude) or depression (- altitude) of the mark is reasonably large, the striding level should be read when pointing to the mark and a similar correction computed. In this case the correction is to be added algebraically to the computed azimuth of the mark.

i. Correction for diurnal aberration. Owing to the rotation of the earth on its axis and the aberration of light thereby caused, the apparent position of any star is always more or less east of its true position, the amount of the displacement depending on the position of the observer and the position of the star. A corresponding correction is required for all azimuths based on the measurement of a horizontal angle between a mark and a star, and is given by the formula

$$D = 0''.32 \frac{\cos \phi \cos A}{\cos h},$$

which for a close circumpolar star at elongation reduces to

$$D_e = 0''.32 \cos A.$$

In obtaining azimuth from a north circumpolar star it is evident that the azimuth of the mark (counting clockwise from either the north or south point) must be increased by the amount of the above correction.

j. Reduction of azimuth to south point. In making azimuth determinations by observations on north circumpolar stars it is customary to refer all results to the north point until the azimuth of the mark is thus expressed. The azimuth of the mark from the south point is then given by the formula

$$Z = 180^\circ + A_m,$$

in which proper regard must be had to the negative sign of A_m if it is taken counter-clockwise.

123b. Approximate Determinations. It is frequently desirable to make approximate determinations of azimuth, either because the work in hand does not call for any greater accuracy, or as a preliminary to the more accurate location of the meridian. Such

determinations may be made by measuring sun or star altitudes, as explained in Art. 122, but observations on Polaris (or other circumpolar stars) give more reliable results without any increase in either field or office labor. The ordinary engineer's transit may be used for such work, and with proper care will give correct results within the smallest reading of the instrument. Since the observation is best made at or near elongation the time of elongation (*c*, Art. 123*a*) is computed beforehand, so that proper preparation may be made. Assuming the instrument to be in good adjustment and carefully leveled, the observation consists in reading on the mark with telescope direct, reading on the star with telescope direct, reading on the star with telescope reversed, and ending with a reading on the mark with telescope reversed. The lower motion must be left clamped and all pointings made with the upper motion alone. The instrument must not be releveled during the set. Both plate verniers should be read at each pointing. The four pointings should be made in close succession, but without undue haste or lack of care. If the observation is being made at elongation the first pointing to the mark is made a few minutes before the computed time of elongation, and the two star pointings as near as may be to the time of elongation. If time is not accurately known the star is followed with the telescope until elongation is evidently reached, when the necessary observations are quickly taken. For five minutes each side of elongation the motion of the star in azimuth is scarcely perceptible in an engineer's transit. If the observations are not taken at elongation time must be accurately known and read to the nearest second at each star pointing. The observations having been completed the mean angle between the mark and the star is obtained from the four readings taken, and it only remains to compute the mean azimuth of the star to know the azimuth of the mark. If the star pointings were made within about ten minutes either way from elongation the azimuth of the star may be taken as equal to its azimuth at elongation (*d*, Art. 123*a*). If the star pointings were made within about a half hour either way from elongation the angle between the mark and the star may be reduced to what it would have been at elongation by use of the formula for reduction to elongation (*e*, Art. 123*a*), the quantity $(t_e - t)$ being taken as the angular value of the time interval between the time of elongation and the average time of the star pointings. If the observa-

tions are taken over about a half hour from elongation it is better to compute the true azimuth of the star for the average time of the star pointings (*f*, Art. 123*a*).

123c. The Direction Method. In this method the angle between the mark and the star is measured with a direction instrument (Arts. 42–47), the process being substantially the same as there described for measuring angles between triangulation stations. Owing to the fact that the star is in motion during the observations, however, the angle being measured is constantly changing, and the reductions must be correspondingly modified. Owing to the altitude of the star serious errors are introduced by any lack of horizontality in the telescope axis, and a corresponding correction must be made in accordance with the readings of the striding level. If the mark is more than a few degrees out of the horizon a similar correction will be required for the same reason. The observations may be made at any hour angle, good work requiring time to be known to the nearest second. A good program for one set is to read twice on the mark with telescope direct; then read twice on the star with telescope direct, noting the exact time of each pointing and the reading of each end of the striding level at each pointing; then read twice on the star with telescope reversed, noting time and bubble readings as before; then read twice on the mark with telescope reversed. The striding level is left with the same ends on the same pivots throughout the observations. The mean azimuth of the star for the four pointings is then found by computing the azimuth corresponding to the average time of these pointings (*f*, Art. 123*a*), and then applying the curvature correction (*g*, Art. 123*a*). The apparent azimuth of the mark is then found by combining the computed star azimuth with the mean measured angle. The true azimuth of the mark (as given by this set) is then found by applying to the apparent azimuth the level correction and the aberration correction (*h* and *i*, Art. 123*a*), and reducing the result to the south point (*j*, Art. 123*a*). By taking a number of sets each night for several nights, and averaging the different results, a very close determination of azimuth may be secured. With skilled observers the probable error of a single set should not exceed about a half a second of arc, and this may be reduced to a tenth of a second by averaging about twenty-five sets.

EXAMPLE.—AZIMUTH BY DIRECTION METHOD *—RECORD

Station: Mount Nebo, Utah.

Date: July 21, 1887.

Instrument: 20-in. Theodolite No. 5.

Observer: W. E.

Star: Polaris, near lower culmination.

Position X.

Object.	Chron. Time.	Pos. of Tel.	Mic.	Circle Reading.						Levels and Remarks.		
				o	'	Forw. d.	Back. d.	Mean d.	Corr. for Run.		Cor'd Mean	
Az. mark	<i>h. m. s.</i>		D	A B C	140	53	14.8 14.6 32.3	14.2 13.4 29.7				
							20.6	19.1	19.8	-0.2	19.6	
Az. mark			D	A B C	140	53	14.7 14.4 32.1	14.2 13.5 30.0				
							20.4	19.2	19.8	-0.2	19.6	
Star	15 06 47.0		D	A B C	136	09	45.3 44.3 60.7	43.0 43.8 59.2				W. E. 43.5 27.0
							50.1	48.7	49.4	-0.5	48.9	
Star	15 10 23.3		D	A B C	136	11	07.0 07.2 22.6	06.5 06.3 21.0				53.7 17.5
							12.3	11.3	11.8	+0.3	12.1	97.2 44.5 +52.7
Star	15 15 57.8		R	A B C	316	13	41.3 32.0 44.0	40.5 30.3 43.7				39.5 32.3
							39.1	38.2	38.6	-0.2	38.4	
Star	15 19 41.5		R	A B C	316	15	09.5 57.5 10.5	08.5 57.3 10.0				27.4 44.6
Mean of 4 times	15 13 12.4						05.8	05.3	05.6	+0.5	06.1	66.9 76.9 -10.0
Az. mark			R	A B C	320	53	27.0 17.8 29.0	26.0 16.5 27.5				Mean circle reading:
							24.6	23.3	24.0	-0.2	23.8	On star: 136°12'26".38
Az. mark			R	A B C	320	53	28.3 18.7 29.7	26.5 16.7 28.7				On mark: 140°53'21".90
							25.6	24.0	24.8	-0.2	24.6	

* Abridged from example in Appendix No. 7, Report for 1897-98, U. S. Coast and Geodetic Survey.

AZIMUTH BY DIRECTION METHOD—COMPUTATION

Mount Nebo, Utah, July, 1887.		$\phi = 39^\circ 48' 33''.44$
Explanation.	July 21, X	July 21, XI
Date and position	July 21, X	July 21, XI
Mean chronometer time	15 ^h 13 ^m 12 ^s .44	0 ^h 55 ^m 10 ^s .06
Chronometer correction	-35 .40	-34 .62
Sidereal time	15 12 37 .04	0 54 35 .44
α of polaris	1 17 58 .16	1 17 58 .48
t of polaris (time)	13 54 38 .88	-0 23 23 .04
t of polaris (arc)	208°39' 43'' .20	-5°50' 45'' .60
δ of polaris	88 42 06 .13	88 42 06 .20
log cot δ	8.35532	8.35532
log tan ϕ	9.92087	9.92087
log cos t	9.94323 n	9.99773
log α	8.21942 n	8.27392
log cot δ	8.355325	8.355319
log sec ϕ	0.114537	0.114537
log sin t	9.680917 n	9.007983 n
log $1/1-a$	9.992861	0.008237
log $(-\tan A)$	8.143640 n	7.486076 n
A	+0° 47' 51'' .02	+0° 10' 31'' .68
Δt and $\frac{2 \sin^2 \frac{1}{2} \Delta t}{\sin 1''}$	6 ^m 25 ^s .4 81'' .0	7 ^m 08 ^s .8 100'' .3
	2 49 .2 15 .6	3 23 .1 22 .5
	2 45 .3 14 .9	3 19 .4 21 .7
	6 29 .3 82 .6	7 12 .4 102 .0
	194'' .1	246'' .5
	48 .5	61 .6
log $\frac{1}{n} \sum \frac{2 \sin^2 \frac{1}{2} \Delta t}{\sin 1''}$	1.68574	1.78958
log (curvature correction)	9.82938	9.27566
Curvature correction	+0'' .68	+0'' .19
Mean azimuth of star	+0° 47' 50'' .34	+0° 10' 31'' .49
Circle reads on star	136 12 26 .38	151 14 14 .30
Circle reads on north	135 24 36 .04	151 03 42 .81
Circle reads on mark	140 53 21 .90	156 32 25 .95
Approx. azimuth of mark	+5 28 45 .86	43 .14
Level correction	-3 .94	-0 .73
Azimuth of mark	5 28 41 .92	42 .41

123d. The Repeating Method. In this method the angle between the mark and the star may be measured with any of the usual engineering transits or with the regular geodetic repeating instrument (Arts. 38–41), the process being substantially the same as there described for measuring angles between triangulation stations. The observations and reductions are best made as described in Arts. 40, 40*a*, and 40*b*, ignoring for the time being the fact that the angle which is being repeated is constantly changing in value on account of the apparent motion of the star. Time must be correctly known and noted to the nearest second for each star pointing, but only the total angle readings are taken, as with terrestrial angles. The striding level (if the instrument has one) may be kept with the same ends on the same pivots throughout the observations, and both ends should be read immediately after the 1st, 3d, 4th and 6th star pointings in each series of six pointings. If the mark is more than a few degrees out of the horizon similar readings of the striding level are also required for its pointings. The observations may be made at any hour angle, but it is preferable to work within a couple of hours of elongation.

In making the reductions the azimuth of the mark from the north point is deduced separately from each series of six pointings, applying the level correction (*h*, Art. 123*a*) in each case, but omitting the aberration correction. The two results obtained from the two series of 6 D. and R. pointings are averaged together to obtain the value of the determination as given by that set. Two or more complete sets may be taken and averaged together as desired. The true azimuth of the mark (as given by these sets) is then found by applying the aberration correction (*i*, Art. 123*a*) to this final mean, and reducing this result to the south point (*j*, Art. 123*a*). In reducing each series of six pointings the accumulated angle is divided by six exactly as if the star had remained entirely stationary. The mean angle thus obtained is the same as it would have been if the star had remained all the time at the mean point of its six separate positions. The corresponding azimuth of this mean point is found by computing the azimuth for the mean of the six times at which the star pointings were made (*f*, Art. 123*a*) and applying the curvature correction (*g*, Art. 123*a*).

The accuracy attainable by this method depends on the char-

EXAMPLE.—AZIMUTH BY REPETITIONS *—RECORD

Station: Kahatchee Δ
 Instrument: 10-in. Gambey No. 63.
 Star: Polaris.

$\phi = 33^\circ 13' 40'' .33$

Date: June 6, 1898.
 Observer: O. B. F.
 $\lambda = 86^\circ 21' 36'' .7$

Object.	Chron. Time on Star.	Tel.	Repetitions.	Level Readings. W. E.	Circle Readings.				Angle.	
					o	'	Ver. A "	Ver. B "		Mean.
Mark Star	14 ^h 46 ^m 30 ^s	D	1	4.5 10.7	178	03	22.5	20.0	21.2	
	49 08		2	9.2 5.9						
	52 51	D	3	9.6 5.6						
	56 10	R	4	5.2 10.0						
	14 59 12		5	11.3 4.0						
	15 01 55	R	6	7.8 7.4	100	16	20.0	20.0	20.0	72° 57' 50'' .2
Star Mark	14 ^h 54 ^m 17 ^s .7			8.7 6.6						
				11.9 3.4						
	15 ^h 04 ^m 44 ^s	R	1	68.2 53.6						
	07 18		2	+14.6						
	09 54	R	3	11.9 3.4						
	14 15	D	4	8.5 6.8						
Set No. 6	16 14		5	7.9 7.3						
	15 18 24	D	6	11.2 4.1	177	27	00.0	00.0	0.00	72° 51' 46'' .7
				9.0 6.1						
				5.9 9.6						
				5.9 9.6						
				9.1 6.2						
	15 ^h 11 ^m 48 ^s .2			69.4 53.1						
				+16.3						

* From Appendix No. 7, Report for 1897-98, U. S. Coast and Geodetic Survey.

acter of the instrument with which the work is done. The probable error of the average value obtained from a complete double set of twenty-four pointings should not exceed about five seconds with a good engineer's transit, nor a single second with a 12-inch repeater; and these probable errors may be much further reduced by averaging many determinations together.

AZIMUTH BY REPETITIONS—COMPUTATION

KAHATCHEE, ALA.

Explanation.	June 6		June 6	
Date.....	June 6		June 6	
Chronometer time.....	14 ^h 54 ^m	17 ^s . 7	15 ^h 11 ^m	48 ^s . 2
Chronometer correction.....		-31 .1		-31 .1
Sidereal time.....	14 53	46 .6	15 11	17 .1
α	1 21	20 .3	1 21	20 .3
Hour-angle (t).....	13 32	26 .3	13 49	56 .8
t in arc.....	203° 06' 34" .5		207° 29' 12" .0	
$\log \sin \phi$	9.73876		9.73876	
$\log \cos t$	9.96367 n		9.94798 n	
$\log \sin \phi \cos t$	9.70243 n		9.68674 n	
$\sin \phi \cos t$	- 0.5040		- 0.4861	
$\cos \phi \tan \delta$	+38.7399		+38.7399	
$\cos \phi \tan \delta - \sin \phi \cos t$	+39.2439		+39.2260	
$\log \sin t$	9.593830 n		9.664211 n	
$\log (\cos \phi \tan \delta - \sin \phi \cos t)$..	1.593772		1.593574	
$\log (-\tan A)$	8.000058 n		8.070637 n	
A	+0° 34' 22" .7		0° 40' 26" .9	
dt and $\frac{2 \sin^2 \frac{1}{2} dt}{\sin 1''}$	7 ^m 47 ^s . 7	119" .3	7 ^m 04 ^s . 2	98" .1
	5 09 .7	52 .3	4 30 .2	39 .8
	1 26 .7	4 .1	1 54 .2	7 .1
	1 52 .3	6 .9	2 26 .8	11 .8
	4 54 .3	47 .2	4 25 .8	38 .5
	7 37 .3	114 .0	6 35 .8	85 .4
		343 .8	280 .7	
		57 .3	46 .8	
$\log \frac{1}{n} \sum \frac{2 \sin^2 \frac{1}{2} dt}{\sin 1''}$	1.7582		1.6702	
\log (curvature correction).....	9.7583		9.7408	
Curvature correction.....	+0.6		+0.6	
Mean azimuth of star.....	+ 0° 34' 22" .1		+ 0° 40' 26" .3	
Angle star-mark.....	72 57 50 .2		72 51 46 .7	
Level correction.....	- 1 .6		- 1 .8	
Corrected angle.....	48 .6		44 .9	
Azimuth of mark E. of N.....	73 32 10 .7		73 32 11 .2	

123e. The Micrometric Method. In this method the angle between the mark and the star is measured with an eyepiece micrometer, no use whatever being made of the horizontal-limb graduations. Any form of transit or theodolite may be used that contains an eyepiece micrometer arranged to measure angles in the plane defined by the optical axis and the horizontal axis of the telescope. An eyepiece micrometer is essentially the same as the micrometer found on the microscopes of direction instruments and described in Art. 45. When the observing telescope is fitted with an eyepiece micrometer the moving hairs lie in the focal plane of the objective and pass across the images of the objects viewed. When the angle between two objects is small (about two minutes or less) it may be assumed with great exactness to be proportional to the distance between the corresponding images in the telescope, and this distance is measured by the micrometer screw with great precision. In applying this method to the determination of azimuth the mark is placed nearly in the vertical plane through the star, and the small horizontal angle between the mark and the star is determined from measurements made entirely with the micrometer, leaving all the horizontal motions of the instrument clamped in a fixed position. The azimuth of the mark is then obtained by combining this angle with the computed azimuth of the star.

In the eyepiece micrometer the value of the angle measured is not given directly by the readings taken, as these indicate only the number of revolutions made by the screw. The reading is commonly taken to the nearest thousandth of a revolution, the whole number of revolutions being read from the comb scale, the tenths and hundredths from the graduations on the head, and the thousandths by estimation. In order to convert the reading into angular value it is necessary to know the angular value of one turn of the micrometer screw. The value of one turn of the screw is found by measuring therewith an angle whose value is already known. The value of such an angle may be found by measuring it directly with the horizontal circle, or by computing it from linear measurements. The value of one turn of the screw may also be obtained by observations on a close circumpolar star near culmination, since the angle between any two positions of the star is readily computed from the times of observation, and the necessary reductions are then easily made.

As already stated, the eyepiece micrometer measures angles in the plane defined by the optical axis and the horizontal axis of the telescope, and the corresponding horizontal angle must hence be obtained by a suitable reduction for the given altitude. To measure the horizontal angle between two objects at different elevations, therefore, it is necessary to find the micrometer value for the distance of each object from the line of collimation, reduce each value to the horizontal for the corresponding altitude, and combine the results for the complete horizontal angle. The reduction in each case is effected by multiplying the micrometer value by the secant of the altitude. In the case of azimuth determinations the reduction must necessarily be made for the star, but need not be made for the mark unless it is several degrees out of the horizon.

The micrometric method may be used at any hour angle, but unless the star is near elongation it will pass out of the safe range of the micrometer after but two or three sets of observations have been secured. If the mark is placed about one or two minutes nearer the meridian than the star at elongation, the observations may be carried on within an hour or more each way from elongation, and a small error in time will have little or no effect on the result. In Coast Survey Appendix No. 7, Report for 1897-98, the following procedure is recommended: "The micrometer line is placed nearly in the line of collimation of the telescope, a pointing made upon the mark by turning the horizontal circle, and the instrument is then clamped in azimuth. The program is then to take five pointings upon the mark; direct the telescope to the star; place the striding level in position; take three pointings upon the star with chronometer times; read and reverse the striding level; take two more pointings upon the star, noting the times; read the striding level. This completes a half-set. The horizontal axis of the telescope is then reversed in the wyes; the telescope pointed approximately to the star; the striding level placed in position; three pointings taken upon the star with observed chronometer times; the striding level is read and reversed; two more pointings are taken upon the star, with observed times; the striding level is read; and finally five pointings upon the mark are taken." In reducing such a set of observations the micrometer reading for the line of collimation is taken as the mean of all the readings on the mark,

EXAMPLE.—AZIMUTH BY MICROMETRIC METHOD *—RECORD

Station: No. 10, Mexican Boundary. Date: October 13, 1892.
 Instrument: Fauth Repeating Theodolite No. 725 (10. in.). Observer: J. F. H.
 Star: Polaris near eastern elongation. ζ = zenith distance of star.

Circle.	Level Readings.		Chronometer Time.	Δt	$\frac{2 \sin^2 \frac{1}{2} \Delta t}{\sin 1''}$	Micro meter Readings.		Means.
	W.	E.				On Star.	On Mark.	
E	8.0	9.9	9 ^h 06 ^m 38 ^s .0	3 ^m 58 ^s .6	31.05	18'.379	18'.310	$\lambda = 2^h 12^m W.$ of Washington. $\phi = 31^\circ 19' 35''.$ 1 div. of level = $3'' .68.$ 1 turn of microm. = $123'' .73.$
	10.0	7.3	07 32.0	3 04.6	18.59	.388	.315	
E	+18.0	-17.2	08 05.5	2 31.1	12.45	.400	.315	Means.
	+0.8		09 13.0	1 23.6	3.82	.424	.311	
W	9.0	9.0	9 12 01.8	1 25.2	3.96	18.100	18.290	Means.
	7.0	10.9	12 24.7	1 48.1	6.37	.100	.275	
W	+16.0	-19.9	12 48.3	2 11.7	9.46	.090	.279	Means.
	-3.9		13 36.3	2 59.7	17.61	.086	.281	
	Mean	-1 ^a .55	13 58.1	3 21.5	22.14	.080	.279	
			9 ^h 10 ^m 36 ^s .6		12.67	18.0912	18.02808	

ζ of star at middle of first half of set = $58^\circ 48'$ cosec $\zeta = 1.1690$ cot $58^\circ 47' = 0.606$
 ζ of star at middle of second half of set = $58^\circ 46'$ cosec $\zeta = 1.1695$
 $\alpha = 1^h 20^m 07^s .4$ $\delta = 88^\circ 44' 10'' .4$

* From A. endix No. 7, Report for 1897-98, U. S. Coast and Geodetic Survey.

AZIMUTH BY MICROMETRIC METHOD—COMPUTATION

Collimation reads $\frac{1}{2}(18.3134 + 18.2808)$	= 18 ^t .2971
Mark east of collimation, 18.3134 - 18.2971	= 0 .0163 = 02'' .02
Circle E., star E. of collimation (18.4042 - 18.2971)(1.1690)	= 0 .1252
Circle W., star E. of collimation (18.2971 - 18.0912)(1.1695)	= 0 .2408
Mean, star E. of collimation	= 0 .1835 = 22 .70
Mark west of star	= 20 .68
Level correction (1.55)(0.92)(0.606)	= - 0 .86
Mark west of star, corrected	= 19 .82
Mean chronometer time of observation	= 21 ^h 10 ^m 36 ^s .6
Chronometer correction	= - 2 11 28 .2
Sidereal time	= 18 59 08 .4
α	= 1 20 07 .4
Hour-angle, t , in time	17 ^h 39 ^m 01 ^s .0
Hour-angle, t , in arc	264° 45' 15'' .0
log cot δ	= 8.34362
log tan ϕ	= 9.78436
log cos t	= 8.96108 n
log a	= 7.08906 n
log cot δ	= 8.343618
log sec ϕ	= 0.068431
log sin t	= 9.998177 n
log $1/1-a$	= 9.999467
log (-tan A)	= 8.409693 n
A	= +1° 28' 16'' .91
log 12.67	= 1.10278
log curvature correction	= 9.51247
Curvature correction	= -0 .33
Diur. aber. corr.	= +0 .32
Mean azimuth of star	= +1° 28' 16'' .90
Mark west of star	19 .82
Azimuth of mark, E. of N.	= +1° 27' 57'' .08

and all micrometer readings are referred to this value. Since the star is changing rapidly in altitude the star micrometer readings are reduced to the horizontal for the mean altitude of each half-set, the altitude of the star being occasionally read and interpolated for any desired time. The mean azimuth of the star for each set is found by computing the azimuth corresponding to the average time of the pointings (*f*, Art. 123*a*), and applying the curvature correction (*g*, Art. 123*a*). The apparent azimuth of the mark is then found by combining the computed star azimuth with the measured angle (reduced to the horizontal). The true azimuth of the mark (as given by this set) is finally found by applying to the apparent azimuth the level correction and the aberration correction (*h* and *i*, Art. 123*a*), and reducing the result to the south point (*j*, Art. 123*a*).

The time occupied in taking a set of observations in the manner above specified should not average over fifteen minutes, so that a number of sets may be taken in a single night. By averaging the results of a number of nights' work a very close determination of azimuth may be secured. The method is more accurate than the direction method or the repeating method. With skilled observers the probable error of the mean of 25 or 30 sets should be less than a tenth of a second.

124. Azimuth Determinations at Sea. It is sometimes necessary to make an azimuth determination at sea in order to test the correctness of the ship's compasses. The method commonly employed is to measure the altitude of the sun or one of the brighter stars, and at the same instant take its bearing as shown by the compass to be tested. The azimuth of the given heavenly body is then computed from its observed altitude and the result reduced to a bearing. The difference between the observed bearing and the computed bearing is the error of the compass. The method and reductions for the azimuth observation are the same as explained in detail in Arts. 122, 122*a*, and 122*b*, except that the observation consists in measuring the altitude above the sea horizon by means of a sextant, and that a correction for dip (Art. 105) must be made. The latitude and longitude of the ship's position are always sufficiently well known for use in the reductions. The computed bearing should not be in error over a few minutes, which is very much closer than it is possible to take the compass bearing.

125. Periodic Changes in Azimuth. As explained in Art. 112, the poles of the earth are not fixed in position, but each one apparently revolves about a mean point in a period of about 425 days, the radius-vector varying (during a series of revolutions) between about $0''.16$ and $0''.36$. The result of this shifting of the poles is to cause the azimuth of a line from a given point to oscillate about a mean value, the amplitude of the oscillation depending on the location of the point. In precise azimuth work, therefore, the date of the determination is an essential part of the record.

CHAPTER VIII

GEODETTIC MAP DRAWING

126. General Considerations. The object of a geodetic map or chart is to represent on a flat surface, with as much accuracy of position as possible, the natural and the artificial features of a given portion of the earth's surface. It is presumed that the engineer is familiar with the lettering of maps and the usual methods of representing the natural or topographical features, and such matters are not here considered. The artificial features of a map are the meridians and parallels, the triangulation system or other plotted lines of location, and any lines which may be drawn to determine latitude, longitude, azimuth, angles, distances, or areas.

In an absolute y perfect map the meridians and other straight lines (in the surveying sense), would appear as straight lines; the meridians would show a proper convergence in passing towards the poles; the parallels of latitude would be parallel to each other and properly spaced, and would cross all meridians at right angles; all points would be properly plotted in latitude and longitude; and azimuths, angles, distances and areas would everywhere scale correctly. On account of the spheroidal shape of the earth, it is evident that such a map is an impossibility, except for very limited areas. Some form of distortion must necessarily exist in any representation of a double curved surface on a flat sheet. By selecting a type of projection depending on the use to be made of the map, however, the distortion may be minimized in those features where accuracy is most desired, and entirely satisfactory maps produced. The principal types of map projection, as explained in the following articles, are the *cylindrical*, the *trapezoidal*, and the *conical*, these terms referring to the considerations governing the plotting of the meridians and parallels.

In the work of plane surveying the areas involved are usually of such small extent that no appreciable error is introduced in plotting by plane angles and straight line distances, drawing all

meridians or other north and south lines perfectly straight and parallel, and all parallels or other east and west lines also straight and parallel and at right angles with the meridians. On account of the larger areas involved in geodetic work it is generally necessary to plot the meridians and parallels first (in accordance with the selected type of projection and the scale of the map), and then plot each fundamental point of the survey by means of its latitude and longitude without regard to angles or distances. The smaller details may then be plotted as in plane surveying. In a geodetic map thus plotted the unavoidable distortion is reduced and distributed as much as possible.

The true lengths of 1° of latitude and longitude at the latitude ϕ are given by the formulas

$$\begin{aligned} \left. \begin{array}{l} 1^\circ \text{ of latitude} \\ \text{at the lat. } \phi \end{array} \right\} &= \frac{\pi a(1 - e^2)}{180(1 - e^2 \sin^2 \phi)^{\frac{3}{2}}}, \\ \left. \begin{array}{l} 1^\circ \text{ of longitude} \\ \text{at the lat. } \phi \end{array} \right\} &= \frac{\pi a \cos \phi}{180(1 - e^2 \sin^2 \phi)^{\frac{3}{2}}}, \end{aligned}$$

in which formulas the letters have the significance and values of Arts. 67 and 69. The values of one degree of latitude and longitude are given for a number of latitudes in Table IX, and may be interpolated for intermediate latitudes.

Since the radius of curvature of the meridian section increases from the equator to the poles it follows that the above formula for the length of a degree of latitude can only be correct in the immediate vicinity of the given latitude. The true length L of a meridian arc extending from the equator to any latitude ϕ is given by the formula

$$L = a(1 - e^2)(M\phi - N \sin 2\phi + P \sin 4\phi - \text{etc.}),$$

in which

$$\begin{aligned} M &= 1 + \frac{3}{4}e^2 + \frac{45}{64}e^4 + \dots, \\ N &= \frac{3}{2}e^2 + \frac{15}{32}e^4 + \dots, \\ P &= \frac{15}{256}e^4 + \dots \end{aligned}$$

For the length l of a meridian arc from the latitude ϕ to the latitude ϕ' , therefore, we have practically

$$l = a(1 - e^2)[M(\phi' - \phi) - N(\sin 2\phi' - \sin 2\phi) + P(\sin 4\phi' - \sin 4\phi)].$$

Substituting the values of a and e from Art. 67, and reducing the formula to its simplest form, we have

$$l = A(\phi' - \phi) - B \sin(\phi' - \phi) \cos(\phi' + \phi) + C \sin 2(\phi' - \phi) \cos 2(\phi' + \phi),$$

in which ϕ and ϕ' in the first term of the second member are to be expressed in degrees and decimals, and in which

$$\begin{aligned} A &= \begin{cases} \text{metric, } 111133.30 \\ \text{feet, } 364609.84 \end{cases} & \log A &= \begin{cases} \text{metric, } 5.0458443 \\ \text{feet, } 5.5618285 \end{cases} \\ B &= \begin{cases} \text{metric, } 32434.25 \\ \text{feet, } 106411.37 \end{cases} & \log B &= \begin{cases} \text{metric, } 4.5110039 \\ \text{feet, } 5.0269881 \end{cases} \\ C &= \begin{cases} \text{metric, } 34.41 \\ \text{feet, } 112.89 \end{cases} & \log C &= \begin{cases} \text{metric, } 1.5366847 \\ \text{feet, } 2.0526689 \end{cases} \end{aligned}$$

127. Cylindrical Projections. The distinguishing feature of all cylindrical projections consists in the projection of the given area on the surface of a right cylinder (of special radius) whose axis is the same as the polar axis of the earth. The flat map desired is then produced by the development of this cylinder. In all forms of this projection the meridians are projected by the meridional planes into the corresponding right line elements of the cylinder, so that after development the meridians appear as equidistant parallel straight lines. The parallels of latitude are projected into the circular elements of the cylinder in a number of different ways, but in any case, after development, appear as parallel straight lines crossing the meridians everywhere at right angles. The three most common types of this projection are explained in the following articles.

127a. Simple Cylindrical Projection. In this type of projection, as illustrated in Fig. 54, page 230, the cylinder is so taken as to intersect the spheroid at the middle latitude of the area to be mapped, the parallels of latitude being projected into the cylinder by lines taken normal to the surface of the spheroid. It is evident from the figure that the parallels will not be represented by equidistant lines, but will separate more and more in advancing towards the poles. This distortion in latitude is offset to a certain extent by a similar error in longitude, caused by the lack of convergence in the plotted meridians, so that the various topographical features remain approximately true to shape. On account of the varying

distortion in both latitude and longitude no single scale can be correctly applied to all parts of such a map. For the true lengths of one degree of latitude or longitude see Table IX or Art. 126. The projected distance x between the meridians, per degree of longitude, due to the middle latitude ϕ' , is given by the formula

$$x = \frac{\pi a}{180} \left[\frac{\cos \phi'}{(1 - e^2 \sin^2 \phi')^{\frac{1}{2}}} \right],$$

and the projected distance y , from the equator to any parallel ϕ , by the formula

$$y = a \tan \phi \left[\frac{\cos \phi'}{(1 - e^2 \sin^2 \phi')^{\frac{1}{2}}} \right] - \frac{ae^2 \sin \phi}{(1 - e^2 \sin^2 \phi)^{\frac{1}{2}}},$$

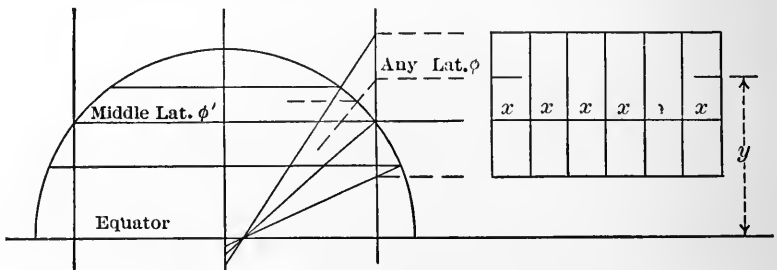

FIG. 54.—Simple Cylindrical Projection.

in which formulas the letters have the significance and values of Arts. 67 and 69.

When the cylinder is taken tangent to the equator (making $\phi' = 0$), the factor in the brackets reduces to unity, and we have

$$x = \frac{\pi a}{180}$$

and

$$y = a \tan \phi - \frac{ae^2 \sin \phi}{(1 - e^2 \sin^2 \phi)^{\frac{1}{2}}}.$$

In making a map by this method the meridians and parallels are spaced in accordance with the above formulas, and the fundamental points of the survey are then plotted by latitudes and longitudes. For small areas (10 square miles) within about 45° of the equator there is not much distortion in such a map. The amount of the distortion in any case is readily obtained by com-

paring the results given by the true formulas and the formulas used for the projection.

127b. Rectangular Cylindrical Projection. In this type of projection, as illustrated in Fig. 55, the cylinder is so taken as to intersect the spheroid at the middle latitude of the area to be mapped, and the meridians are correctly developed on the elements of the cylinder, so that in the finished map the parallels are spaced true to scale. The error due to the lack of convergence of the meridians still remains, so that the same scale can not be applied to all parts of the map. The distortion in longitude is more apparent than in the preceding projection, because no distortion exists in latitude. As in the previous case the meridians are spaced true to scale along the central parallel.

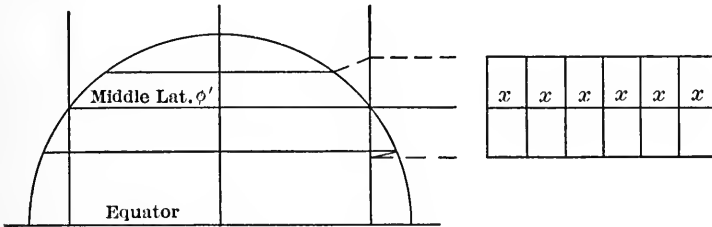

FIG. 55.—Rectangular Cylindrical Projection.

In making a map by this method the central meridian and parallel are first drawn and graduated to scale, using Table IX or the formulas of Art. 126. The remaining parallels and meridians are then drawn, and the survey plotted by latitudes and longitudes. For small areas (10 square miles) within about 45° of the equator there is not much distortion in such a map, straight lines on the ground being straight on the map, and angles and distances scaling correctly. The plotting for such an area may therefore be done by latitudes and longitudes, or by angles and distances, as in plane surveying.

127c. Mercator's Cylindrical Projection. This type of projection, which is largely used for nautical maps, is illustrated in Fig. 56, page 232. As in the simple cylindrical projection, the space between the parallels constantly increases in advancing from the equator towards the poles, but the spacing is governed by an entirely different law. In Mercator's cylindrical projection the cylinder is taken as tangent at the equator, so that the

spacing of the meridians along the equator is true to scale in the finished map. As the plotted meridians fail to converge, the distance between them is too great at all other points, the extent of the distortion becoming more and more pronounced as the latitude increases. To offset this condition the distance between the parallels is also distorted more and more as the latitude increases, making the law of distortion exactly the same in both cases. In that part of the map where the distance between the meridians scales twice its true value, for instance, the distance between the parallels should also scale twice its true value. Since this distortion factor changes with the slightest change of

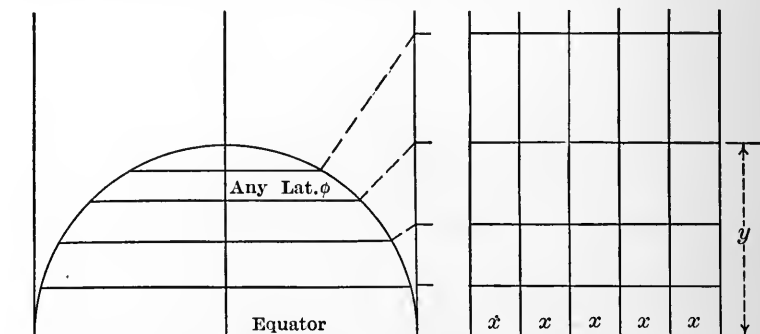

FIG. 56.—Mercator's Cylindrical Projection.

latitude, however, it is evident that a satisfactory map will require the meridian to be built up of a great many very small pieces, each multiplied in length by its own appropriate factor. A perfect map on this basis requires an infinitesimal subdivision of the meridian, and a summation of these elements by the methods of the integral calculus. Using the notation and the formulas of Arts. 67 and 69, and remembering that the distortion of any parallel is inversely proportional to its radius, we have for the distortion factor s at any latitude ϕ ,

$$s = \frac{a}{r} = \frac{a}{N \cos \phi} = \frac{(1 - e^2 \sin^2 \phi)^{\frac{1}{2}}}{\cos \phi}.$$

Multiplying the meridian element, $Rd\phi$, by the distortion factor s , we have for dy , the projected meridian element,

$$dy = s(Rd\phi) = \frac{a(1 - e^2)d\phi}{\cos \phi(1 - e^2 \sin^2 \phi)^{\frac{1}{2}}};$$

whence, by integration,

$$y = 1.1512925 a \left[\log \left(\frac{1 + \sin \phi}{1 - \sin \phi} \right) - e \log \left(\frac{1 + e \sin \phi}{1 - e \sin \phi} \right) \right],$$

in which y is the projected distance from the equator to any parallel of latitude ϕ , and in which the formula is adapted to the use of common logarithms. The value of x per degree of longitude, for the spacing of the meridians, is given by the formula

$$x = \frac{\pi a}{180}.$$

In making a map by this method the meridians and parallels are spaced in accordance with the above formulas, and the fundamental points of the map are then plotted by latitudes and longitudes. It is evident that such a map will be true to scale only in the vicinity of the equator, and that different scales must be used for every part of the map. If it is desired, however, to have the map true to any given scale along the central parallel ϕ' , it is only necessary to divide the above values of x and y by the distortion factor s' corresponding to the latitude ϕ' .

A *rhumb line* or *loxodrome* between any two points on a spheroid is a spiral line which crosses all the intermediate meridians at the same angle. Except for points very far apart such a line is not very much longer than the corresponding great circle distance. Great circle sailing is sometimes practised by navigators, but ordinarily vessels follow a rhumb line, keeping the same course for considerable distances. A rhumb line of any length or angle will always appear in Mercator's projection as an absolutely straight line, crossing the plotted meridians at exactly the same angle as that at which the rhumb line crosses the real meridians. When a ship sails from a known point in a given direction, therefore, its path is plotted on a Mercator chart by simply drawing a straight line through the given point and in the given direction. The distance traveled by the ship is plotted in accordance with the scale suitable to the given part of the map. Similarly the proper course to sail between any two points can be scaled directly from the map with a protractor. It is for these reasons that this type of projection is so valuable for nautical purposes.

128. Trapezoidal Projection. In this type of projection, as illustrated in Fig. 57, the meridians and parallels form a series of trapezoids. All the meridians and parallels are drawn as straight lines. The central meridian is first drawn and properly graduated in degrees or minutes. The parallels of latitude are then drawn through these points of division as parallel lines at right angles to this meridian. Two parallels, at about one-fourth and three-fourths the height of the map, are then properly graduated, and the corresponding points of division connected by a series of converging straight lines to represent the meridians. For the correct distances required in making the graduations see

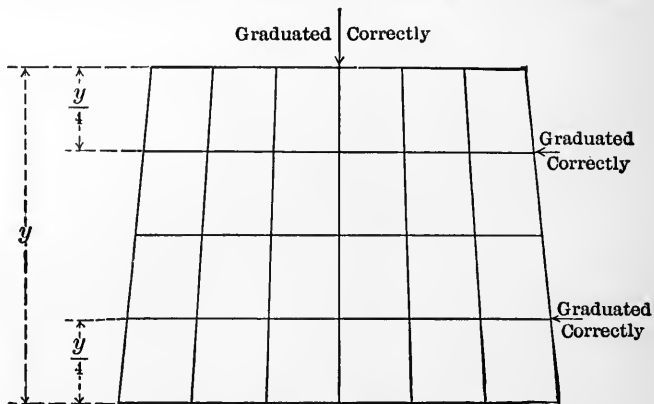

FIG. 57.—Trapezoidal Projection.

Table IX or Art. 126. From the nature of the construction it is plain that the central meridian is the only one which the parallels cross at right angles. The fundamental points of such a map are plotted by latitudes and longitudes. For small areas (25 square miles) the distortion in distance is very slight in this type of map.

129. Conical Projections. The distinguishing feature of the conical projections consists in the projection of the given area on the surface of one or more right cones (of special dimensions) whose axes are the same as the polar axis of the earth. The flat map desired is then produced by the development of the cone or cones thus used. In some forms of this projection the meridians are projected into the right line elements of the cones, while in other forms a different plan is adopted; so that in some forms the meridians become straight lines after development,

while in other forms they appear as curved lines. The parallels of latitude are always projected into the circular elements of the cone or cones, and after development always appear as circular arcs. The four most common types of this projection are explained in the following articles.

129a. Simple Conic Projection. In this type of projection, as illustrated in Fig. 58, the projection is made on a single cone taken tangent to the spheroid at the middle latitude of the area to be mapped. The meridians are projected into the right line elements of the cone by the meridional planes, and appear as straight lines after development. The meridians are correctly developed on the elements of the cone, so that the parallels are all spaced true to scale on the finished map. The parallels are

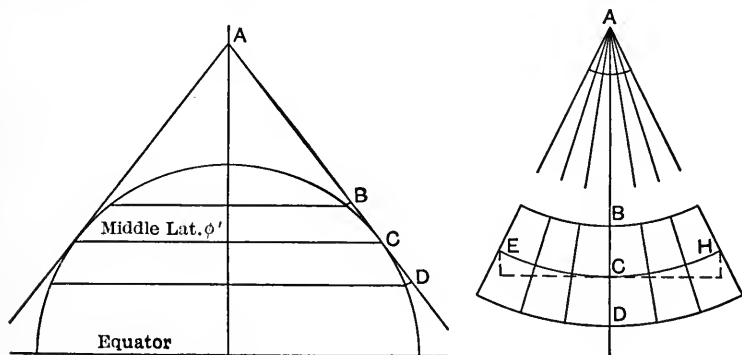

FIG. 58.—Simple Conic Projection.

drawn as concentric circles from the center A , the distance AC being the tangent distance for the middle latitude. The central parallel is graduated true to scale, and the meridians are drawn as straight lines from the center A through the points of division. For the tangent distance AC we have, from Art. 69,

$$AC = T = N \cot \phi = \frac{a \cot \phi}{(1 - e^2 \sin^2 \phi)^{\frac{1}{2}}}$$

The correct values for graduating the meridian and central parallel may be taken from Table IX or computed by the formulas of Art. 126.

When it is impracticable to draw the arc EH from the center A it may be located by rectangular coordinates from the point C , as indicated by the dotted lines. To find the coordinates of

any point H (see Fig. 59) let δ equal the angular difference of longitude subtended by the arc CH (radius = r), and δ' equal the developed angle subtended by the same arc CH (radius = $N \cot \phi$). Then, since equal lengths of arc in different circles subtend angles inversely as the radii, we have

$$\frac{\delta'}{\delta} = \frac{r}{N \cot \phi} = \frac{N \cos \phi}{N \cot \phi} = \sin \phi,$$

giving

$$\delta' = \delta \sin \phi;$$

whence

$$x = AH \sin \delta' = N \cot \phi \sin (\delta \sin \phi),$$

and

$$y = AH \text{ vers } \delta' = 2N \cot \phi \sin^2 \left(\delta \frac{\sin \phi}{2} \right).$$

These values of x and y are readily computed by means of the data given in Table IX. In this projection the coordinates of the different arcs vary directly as their radii, so that the coordinates of the remaining parallels may be found by a simple proportion. As a check on the work the meridians should be straight and uniformly spaced.

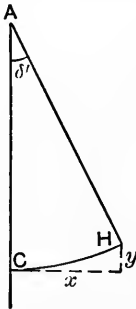

FIG. 59.

In making a map by this method the meridians and parallels are spaced in accordance with the above rules, and the fundamental points of the survey are then plotted by latitudes and longitudes. In this projection the meridians and parallels intersect at the proper angle of 90° , and the parallels are properly spaced; but the spacing

of the meridians is exaggerated everywhere except along the central parallel, and all areas are too large. Such a map is satisfactory up to areas measuring several hundred miles each way.

129b. Mercator's Conic Projection. In this type of projection, as illustrated in Fig. 60, the projection is made on a single cone, taken so as to intersect the spheroid midway between the middle parallel and the extreme parallels of the area to be mapped. The remaining parallels may be considered as projected into the cone so that the spacing along the line BF is exactly proportional to the true spacing along the meridian GHK ; or mathematically

$$\frac{BC}{GC} = \frac{CD}{CH} = \text{etc.} = \frac{\text{chord } CE}{\text{arc } CE}.$$

After development the entire figure is then proportionately enlarged until the spacing of the parallels is again true to scale; following which the developed angle and its subdivisions are correspondingly reduced in size, in order to make the projected parallels $C'C''$ and $E'E''$ true to the same scale. The distances $B'C' = \text{arc } GC$, $C'D' = \text{arc } CH$, etc., are found from Art. 126 or Table IX. The radius $A'C'$ is then computed from the formula

$$\frac{A'C'}{A'C' + \text{arc } CE} = \frac{\cos \phi (1 - e^2 \sin^2 \phi'')^{\frac{1}{2}}}{\cos \phi'' (1 - e^2 \sin^2 \phi)^{\frac{1}{2}}}$$

The remaining radii are found from $A'C'$ by a proper combination of the known distances along the line $A'F'$. The parallel

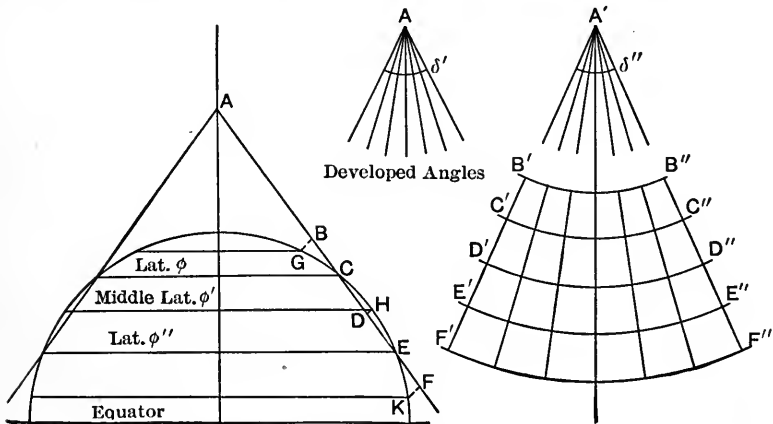

FIG. 60.—Mercator's Conic Projection.

$E'E''$ is then graduated both ways from the central meridian by means of the values found from Art. 126 or Table IX, and the meridians are drawn as straight lines from the point A' .

The parallels may be plotted by rectangular coordinates when it is impracticable to use the center A' , but the values given in Table IX are not correct for this type of projection. The individual angles at the apex A' are readily obtained from the radius $A'E'$ and the subdivisions along the arc $E'E''$, and the coordinates are then found for this arc and proportioned for the other arcs directly as their radii.

In making a map by this method the meridians and parallels are drawn in accordance with the above rules, and the fundamental

points of the survey are then plotted by latitudes and longitudes. In this projection the meridians are straight lines, the meridians and parallels cross at the proper angle of 90° , and the parallels of latitude are properly spaced. The meridians are properly spaced on the parallels $C'C''$ and $E'E''$, but are a little too widely spaced outside of these parallels, and a little too closely spaced within these parallels. Areas outside of these same parallels are too large, while areas within them are too small; but the total area is nearly correct. Mercator's conic projection is suitable for very large areas, having been used for whole continents. It has also been largely used for the maps in atlases and geographies.

129c. Bonne's Conic Projection. In this type of projection, as illustrated in Fig. 61, the projection is made on a single cone

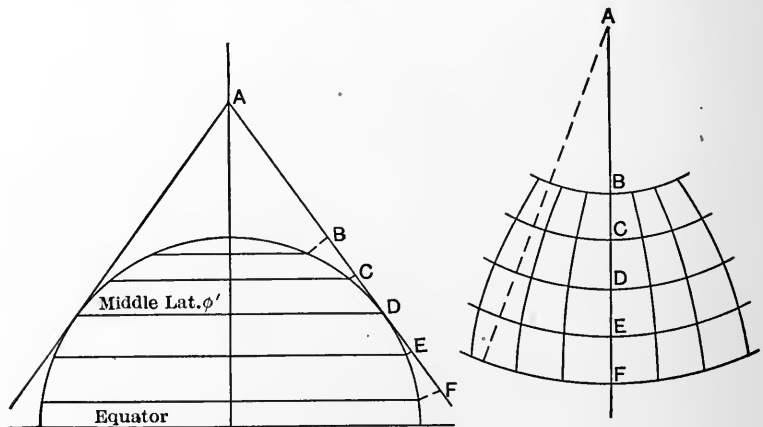

FIG. 61.—Bonne's Conic Projection.

taken tangent to the spheroid at the middle latitude of the area to be mapped. The central meridian is projected into the straight line AF , with the parallels spaced true to scale and drawn as concentric circles, in accordance with the rules and formulas for simple conic projection (Art. 129a). Each parallel is then graduated true to scale (see Art. 126 or Table IX), and the meridians are drawn as curved lines through corresponding divisions of the parallels.

In making a map by this method the fundamental points of the survey must be plotted by latitudes and longitudes. In this projection the meridians and parallels fail to cross at right angles,

but the same scale holds good for all the meridians and all the parallels. Bonne's conic projection is suitable for very large areas, having been used for whole continents. It has also been largely used for the maps in atlases and geographies.

129d. Polyconic Projection. In this type of projection, as illustrated in Fig. 62, a separate tangent cone is taken for each parallel of latitude, and made tangent to the spheroid at that parallel. Each parallel on the map results from the development of its own special cone, appearing as the arc of a circle with a radius equal to the corresponding tangent distance. The parallel

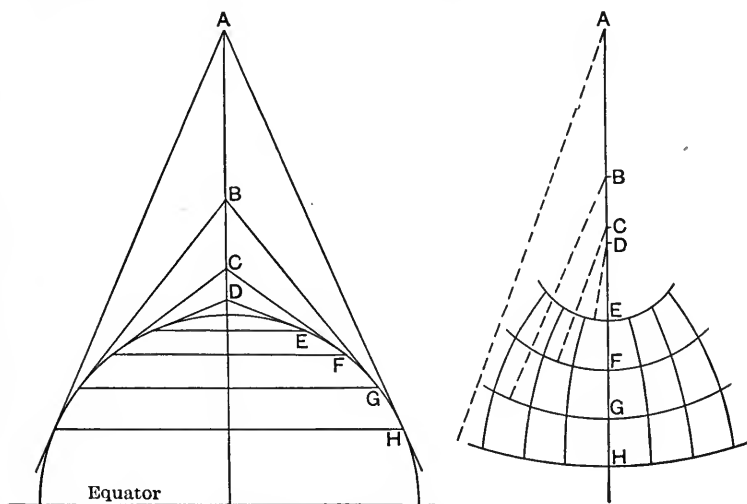

FIG. 62.—Polyconic Projection.

through the point G , for instance, is drawn as a circular arc with a radius equal to the tangent distance BG , and so on. The central meridian is drawn as a straight line, on which all the parallels are spaced true to scale, so that the division EF equals the arc EF , the division FG equals the arc FG , and so on. The arcs representing the various parallels are then drawn through these division points with the appropriate radii, and with the centers located on the central meridian. Each parallel as thus represented is then graduated true to scale, and the meridians are drawn as curved lines connecting the corresponding divisions.

In making a map by this method the meridians and parallels are plotted in accordance with the data given in Table IX, or

from corresponding values computed by the rules and formulas of Arts. 126 and 129*a*, remembering that each parallel is here equivalent to the central parallel of the simple conic projection. The plotting is customarily done by rectangular coordinates, the meridians and parallels being taken so close together that the intersection points may be connected by straight lines. The fundamental points of the survey are then plotted by latitudes and longitudes.

This type of projection is suitable for very large areas. The meridians are spaced true to scale throughout the map and cross the parallels nearly at right angles. The parallels are spaced true to scale only along the central meridian, and diverge more and more from each other as the distance from the central meridian increases. The whole of North America, however, may be represented without material distortion. The U. S. Coast and Geodetic Survey and the U. S. Geological Survey have adopted the polyconic system of projection to the exclusion of all others. For further information on this subject see "Tables for the Projection of Maps, Based upon the Polyconic Projection of Clarke's Spheroid of 1866, and computed from the Equator to the Poles; Special Publication No. 5, U. S. Coast and Geodetic Survey, U. S. Government Printing Office, 1900."

The above type of polyconic projection is sometimes called the *simple polyconic*, to distinguish it from the *rectangular polyconic*, in which the scales along the parallels are so taken as to make all the meridians and parallels cross at right angles. When not otherwise specified the simple polyconic is in general understood to be the one intended.

PART II

ADJUSTMENT OF OBSERVATIONS BY THE METHOD OF LEAST SQUARES

CHAPTER IX

DEFINITIONS AND PRINCIPLES

130. General Considerations. In various departments of science, such as Astronomy, Geodesy, Chemistry, Physics, etc., numerous values have to be determined either directly or indirectly by some process of measurement. When any fixed magnitude, however, is measured a number of times under the same apparent conditions, and with equal care, the results are always found to disagree more or less amongst themselves. With skillful observers, and refined methods and instruments, the absolute values of the discrepancies are decreased, but the relative disagreement often becomes more pronounced. The conclusion is obviously reached that all measurements are affected by certain small and unknown errors that can neither be foreseen nor avoided. The object of the method of Least Squares is to find the most probable values of unknown quantities from the results of observation, and to gage the precision of the observed and reduced values.

131. Classification of Quantities. The quantities observed are either independent or conditioned.

An *independent quantity* is one whose value is independent of the values of any of the associated quantities, or which may be so considered during a particular discussion. Thus in the case of level work the elevation of any individual bench mark is an independent quantity, since it bears no necessary relation to the elevation of any other bench mark. This is not the case in the case of a triangle

we may consider any two of the angles as independent quantities in any discussion in which the remaining angle is made to depend on these two.

A *conditioned quantity* (or *dependent quantity*) is one whose value bears some necessary relation to one or more associated quantities. In any case of conditioned quantities we may regard these quantities as being mutually dependent on each other, or any number of them as being dependent on the remaining ones. Thus if the angles of a triangle are denoted by x , y , and z , we may write the conditional equation

$$x + y + z = 180^\circ,$$

and regard each angle as a conditioned quantity; or we may write, for instance,

$$z = 180^\circ - x - y,$$

and regard z as conditioned and x and y as independent.

132. Classification of Values. In considering the value of any quantity it is necessary to distinguish between the true value, the observed value, and the most probable value.

The *true value* of a quantity is, as its name implies, that value which is absolutely free of all error. Since (Art. 130) all measurements are subject to certain unknown errors, it follows that the true value of a quantity may never be known with absolute precision. In any case such a value would seldom be any exact number of units, but could only be expressed as an unending decimal.

The *observed value* of a quantity is technically understood to mean the value which results from an observation *when corrections have been applied for all known errors*. Thus in measuring a horizontal angle with a sextant the vernier reading must be corrected for the index error to obtain the observed value of the angle; in measuring a base line with a steel tape the corrections for horizontal and vertical alignment, pull, sag, temperature, and absolute length, are understood to have been applied; and so on.

The *most probable value* of a quantity is that value which is most likely to be the true value in view of all the measurements on which it is based. The most probable value in any case is not supposed to be the same as the true value, but only that value which is more likely to be the true value than any other single value that might be proposed.

133. Observed Values and Weights. The observations which are made on unknown quantities may be direct or indirect, and in either case of equal or of unequal weight.

A *direct observation* is one that is made directly on the quantity whose value is desired. Thus a single measurement of an angle is a direct observation.

An *indirect observation* is one that is made on some function of one or more unknown quantities. Thus the measurement of an angle by repetition represents an indirect observation, since some multiple of the angle is measured instead of the single value. So also in ordinary leveling the observations are indirect, since they represent the difference of elevation from point to point instead of the elevations of the different points.

By the *weight* of an observation is meant its relative worth. When observations are made on any magnitude with all the conditions remaining the same, so that all the results obtained may be regarded as equally reliable, the observations are said to be of equal weight or precision, or of unit weight. When the conditions vary, so that the results obtained are not regarded as equally reliable, the observations are said to be of unequal weight or precision. It has been agreed by mathematicians that the most probable value of a quantity that can be deduced from two observations of unit weight shall be assigned a weight of two, from three such observations a weight of three, and so on. Hence when an observation is made under such favorable circumstances that the result obtained is thought to be as reliable as the most probable value due to two observations which would be considered of unit weight, we may arbitrarily assign a weight of two to such an observation; and so on. As the weights applied in any set of observations are purely relative, their meaning will not be changed by multiplying or dividing them all by the same number. The elementary conception of weight is therefore extended to include decimals and fractions as well as integers, since any set of weights could be reduced to integers by the use of a suitable factor.

134. Most Probable Values and Weights. In any set of observations the most probable value of the unknown quantity will evidently be some intermediate or mean value. There are many types of mean value, but manifestly they are all subject to the fundamental condition that in the case of equal values the mean value must be that common value. Three of the common

types of mean value are the arithmetic mean, the geometric mean, and the quadratic mean. If there are n quantities whose respective values are M_1, M_2 , etc., we have,

$$\left. \begin{aligned} \frac{\Sigma M}{n} &= \text{the arithmetic mean;} \\ \sqrt[n]{M_1 M_2 \dots M_n} &= \text{the geometric mean;} \\ \sqrt{\frac{\Sigma M^2}{n}} &= \text{the quadratic mean;} \end{aligned} \right\} \dots (1)$$

all of which satisfy the fundamental condition of a mean value.

In the case of direct observations of equal weight it has been universally agreed that the arithmetic mean is the most probable value. In accordance with this principle, and the definition of weight as given in Art. 133, it is evident that the weight of the arithmetic mean is equal to the number of observations. Similarly, an observation to which a weight of two has been assigned may be regarded as the arithmetic mean of two component observations of unit weight, and so on, provided no special assumption is made regarding the relative values of these components. For direct observations of *unequal* weight, therefore,

Let z = the most probable value of a given magnitude;
 M_1, M_2 , etc. = the values of the several measurements;
 p_1, p_2 , etc. = the respective weights of these measurements;
 ap_1, ap_2 , etc. = the corresponding integral weights due to the use of the factor a ;
 m_1', m_1'' , etc. = the ap_1 unit weight components of M_1 when considered as an arithmetic mean
 m_2', m_2'' , etc. = similarly for M_2 , and so on;

then we may write as equivalent expressions

$$M_1 = \frac{m_1' + m_1'' \dots}{ap_1} = \frac{\Sigma m_1}{ap_1},$$

$$M_2 = \frac{m_2' + m_2'' \dots}{ap_2} = \frac{\Sigma m_2}{ap_2}, \text{ etc.};$$

whence

$$\Sigma m_1 = ap_1 M_1,$$

$$\Sigma m_2 = ap_2 M_2, \text{ etc.};$$

and, since the various values of m are of unit weight,

$$z = \frac{\Sigma m_1 + \Sigma m_2 \dots}{ap_1 + ap_2 \dots},$$

or

$$z = \frac{\Sigma m}{\Sigma ap} = \frac{\Sigma (ap \cdot M)}{\Sigma ap} = \frac{\Sigma pM}{\Sigma p}, \quad \dots \dots \quad (2)$$

from which we have the general principle :

In the case of direct observations of unequal weight the most probable value is found by multiplying each observation by its weight and dividing the sum of these products by the sum of the weights. The result thus obtained is called the weighted arithmetic mean. In the above discussion the value of z is found by taking the arithmetic mean of Σap quantities whose sum is Σm , so that the *integral* weight of z is Σap . Dividing by a in order to express this result in accordance with the original scale of weights, we have

$$\text{Weight of } z = \Sigma p; \quad \dots \dots \dots (3)$$

or, expressed in words, the weight of the weighted arithmetic mean is equal to the sum of the individual weights.

135. True and Residual Errors. It is necessary to distinguish between true errors and residual errors.

A *true error*, as its name implies, is the amount by which any proposed value of a quantity differs from its true value. True errors are generally considered as positive when the proposed value is in excess and vice versa. Since (Art. 132) the true value of a quantity can never be known, it follows that the true error is likewise beyond determination.

A *residual error* is the difference between any observed value of a quantity and its most probable value, in the same set of observations. The subtraction is taken algebraically in whichever way is most convenient in the given discussion. In the case of indirect observations the most probable value of the observed quantity is found by substituting the most probable values of the individual unknowns in the given observation equation (Art. 158). Residual errors are frequently called simply *residuals*.

In the case of the arithmetic mean the sum of the residual errors is zero. This is proved as follows:

Let n = the number of observations;
 $M_1, M_2, \dots M_n$ = the observed values;
 z = the arithmetic mean;
 $v_1, v_2, \dots v_n$ = the residual errors;

then

$$\begin{aligned} v_1 &= z - M_1 \\ v_2 &= z - M_2 \\ &\dots \dots \dots \\ v_n &= z - M_n \\ \hline \Sigma v &= nz - \Sigma M; \end{aligned}$$

but

$$z = \frac{\Sigma M}{n},$$

or

$$nz = \Sigma M,$$

from which

$$nz - \Sigma M = 0;$$

whence

$$\Sigma v = 0, \dots \dots \dots (4)$$

which was to be proved.

In the case of the weighted arithmetic mean the sum of the weighted residuals equals zero. This is proved as follows:

Let n = the number of observations;
 $M_1, M_2, \dots M_n$ = the observed values;
 $p_1, p_2, \dots p_n$ = the corresponding weights;
 z = the weighted arithmetic mean;
 $v_1, v_2, \dots v_n$ = the residual errors;

then

$$\begin{aligned} p_1 v_1 &= p_1(z - M_1) \\ p_2 v_2 &= p_2(z - M_2) \\ &\dots \dots \dots \\ p_n v_n &= p_n(z - M_n) \\ \hline \Sigma p v &= \Sigma p \cdot z - \Sigma p M; \end{aligned}$$

but

$$z = \frac{\Sigma p M}{\Sigma p},$$

or

$$\Sigma p \cdot z = \Sigma p M,$$

stantly changing conditions during the progress of an observation. Each individual error is usually very minute, but the possible number of such errors that may occur in any one measurement is almost without limit. In general it may be said that any single observation is affected by a very large number of such errors, the total accidental error being due to the algebraic sum of these small individual errors. Thus in measuring a horizontal angle with a transit the instrument is seldom in a perfectly stable position; the leveling is not perfect; the lines and levels of the instrument are affected by the wind and varying temperatures; the graduations are not perfect; the reading is affected by the judgment of the observer; the target is bisected only by estimation; the line of sight is subject to irregular sidewise refraction due to changing air currents; and so on. As long as the component errors are all accidental, however, the total error may be regarded as a single accidental error.

138. The Laws of Chance. The errors remaining in observed values after all possible corrections have been made are presumed to be accidental errors, and must therefore be assumed to have occurred in accordance with the laws of chance. By the *laws of chance* are meant those laws which determine the probability of occurrence of events which happen by chance.

By the *probability* of an event is meant the relative frequency of its occurrence. It is not only a reasonable assumption but also a matter of common experience, that in the long run the relative frequency with which a proposed event occurs will closely approach the relative possibilities of the case. Thus in tossing a coin heads may come up as one possibility out of the two possibilities of heads or tails, so that the probability of a head coming up is one-half; and in a very large number of trials the occurrence of heads will closely approximate one-half the total number of trials. Probabilities are therefore represented by fractions ranging in value from zero to unity, in which *zero* represents *impossibility* of occurrence, while *unity* represents *certainty* of occurrence.

The three fundamental laws of chance are those relating to simple events, compound events, and concurrent events.

139. A Simple Event is one involving a single condition which must be satisfied. *The probability of a simple event is equal to the relative possibility of its occurrence.* Thus the probability of drawing an ace from a pack of cards is $\frac{1}{13}$, since there are four

such possibilities out of 52, and $\frac{4}{52} = \frac{1}{13}$; but the probability of drawing an ace of clubs, for instance, is only $\frac{1}{52}$, since there is only one such possibility out of 52.

140. A Compound Event is one involving two or more conditions of which only one is required to be satisfied. *The probability of a compound event is equal to the sum of the probabilities of the component simple events.* This law is evidently true, since the number of favorable possibilities for the compound event equals the sum of the corresponding simple possibilities, and the total number of possibilities remains unchanged. Thus the probability of getting either a club or a spade in a single draw from a pack of cards is one-half, because the probability of getting a club is one-quarter, and the probability of getting a spade is one-quarter, and $\frac{1}{4} + \frac{1}{4} = \frac{1}{2}$; or in other words the 13 chances for getting a club are added to the 13 chances for getting a spade, making 26 favorable possibilities out of a total of 52. The probability of drawing either a club, spade, heart, or diamond, equals $\frac{1}{4} + \frac{1}{4} + \frac{1}{4} + \frac{1}{4}$, which equals unity, since the proposed event is a certainty.

141. A Concurrent Event is one involving two or more conditions, all of which are required to be satisfied together. *The probability of a concurrent event is equal to the product of the probabilities of the component simple events.* This law is evidently true, since the number of favorable possibilities for the concurrent event is equal to the product of the corresponding simple possibilities; while the total number of possibilities is equal to the product of the corresponding totals for the component simple events. Thus the probability of cutting an ace in a pack of cards is $\frac{4}{52}$, so that the probability of getting two aces by cutting two packs of cards is $\frac{4}{52} \times \frac{4}{52} = \frac{4 \times 4}{52 \times 52} = \frac{1}{13} \times \frac{1}{13} = \frac{1}{169}$. It is evident that the required condition will be satisfied if any one of the four aces in one pack is matched with any one of the four aces in the other pack, so that there are 4×4 favorable possibilities. Also the cutting may result in getting any one of 52 cards in one pack against any one of 52 cards in the other pack, so that there are 52×52 total possibilities. Multiplying the two probabilities, therefore, gives the relative possibility and therefore the required probability for the given concurrent event. Similarly the proposition may be proved for a concurrent event involving any number of simple events. Thus in throwing three dice the probability of getting 3 fours, for instance, will be $\frac{1}{6} \times \frac{1}{6} \times \frac{1}{6} = \frac{1}{216}$;

the probability of drawing a deuce from a pack of cards at the same time that an ace is thrown with a die, will be $\frac{1}{3} \times \frac{1}{6} = \frac{1}{18}$; and so on.

In figuring the probability of a concurrent event it is necessary to guard against two possible sources of error. In the first place the probabilities of the simple events involved in a concurrent event may be changed by the concurrent condition. Thus the probability of drawing a red card from a pack is $\frac{2}{3}$, but the probability of drawing two red cards in succession from a pack is not $\frac{2}{3} \times \frac{2}{3}$, but $\frac{2}{3} \times \frac{1}{3}$, since the drawing of the first card changes the conditions under which the second card is drawn. In the second place, the probability of a concurrent event may be modified by the sense in which the order of simple events may be involved. Thus in cutting two packs of cards the probability that the first pack will cut an ace and the second a king is $\frac{1}{3} \times \frac{1}{3} = \frac{1}{9}$; but the probability that the first pack will cut a king and the second an ace is also $\frac{1}{3} \times \frac{1}{3} = \frac{1}{9}$; so that the probability of cutting an ace and a king without regard to specific packs becomes $\frac{2}{9}$, and not $\frac{1}{9}$, as might be inferred.

142. Misapplication of the Laws of Chance. The probability of a given event is the relative frequency of its occurrence in the *long run*, and not in a limited number of cases. It is not to be expected that every two tosses of a coin will result in one head and one tail, since other arrangements are possible, and the laws of chance are founded on the idea that every possible event will occur its proportionate number of times. Thus in the case of a coin we have for all possible events in two tosses,

Probability of 2 heads	= $\frac{1}{4}$
“ 1 head and 1 tail	= $\frac{1}{2}$
“ 1 tail and 1 head	= $\frac{1}{4}$
“ 2 tails	= $\frac{1}{4}$

Some one of these events must happen, so that the total probability is $\frac{1}{4} + \frac{1}{2} + \frac{1}{4} + \frac{1}{4}$, which equals unity, as it should in a case of certainty. The probability of two tosses including a head and a tail (which may occur in two ways) is $\frac{1}{4} + \frac{1}{4} = \frac{1}{2}$, so that the proposed event is not one that occurs at every trial, as is often inferred.

An event whose probability is extremely high will not necessarily happen on a given occasion, and this failure to happen

does not imply an error in the theory of probabilities. The very fact that the given probability is not quite unity indicates the chance of occasional failures. Similarly an event with a very small probability will sometimes happen, otherwise its probability should be precisely and not approximately zero.

The probability of a future event is not affected by the result of events which have already taken place. Thus if a tossed coin has resulted in heads ten times in succession it is natural to look on a new toss as much more likely to result in tails than in heads; but mature thought will show that the probabilities are still one-half and one-half for any new toss that may be made. The confusion in such a case comes from regarding the ten successive heads as an abnormal occurrence, whereas, being one of the possible occurrences, it should happen in due course along with all other possible events. If tails were more likely to come up than heads in any particular toss, it would imply some difference of conditions instead of any overlapping influence. If the toss of a coin is ever regarded as a matter of chance, it must always be so regarded.

CHAPTER X

THE THEORY OF ERRORS

143. The Laws of Accidental Error. The mathematical theory of errors relates entirely to those errors which are purely accidental, and which therefore follow the laws of probability. Mistakes or blunders, which follow no law, and systematic errors, which follow special laws for each individual case, can not be included in such a discussion. If a sufficient number of observations are taken it is found by experience that the accidental errors which occur in the results are governed by the four following laws:

1. *Plus and minus errors of the same magnitude occur with equal frequency.*

This law is a necessary consequence of the accidental character of the errors. An excess of plus or minus errors would indicate some *cause* favoring that condition, whereas only *accidental* errors are under consideration.

2. *Errors of increasing magnitude occur with decreasing frequency.*

This law is the result of experience, but for mathematical purposes it is replaced by the equivalent statement that errors of increasing magnitude occur with decreasing *facility*. For reasons yet to appear (Art. 146) the facility of an error is rated in units that make it *proportional* to the relative frequency with which that error occurs instead of equal thereto.

3. *Very large errors do not occur at all.*

This law is also the result of experience, but it is not in suitable form for mathematical expression. It is satisfactorily replaced by the assumption that very large errors occur with great infrequency.

4. *Accidental errors are systematically modified by the circumstances of observation.*

This law is a necessary consequence of the first three laws, and emphasizes the fact that these three laws always hold good

however much the absolute values of the errors may be modified by favorable or unfavorable conditions. The chief circumstances affecting a set of observations are the atmospheric conditions, the skill of the observer, and the precision of the instruments.

144. Graphical Representation of the Laws of Error. The four laws of error are graphically represented in Fig. 63, in which the solid curve corresponds to a series of observations taken under a certain set of conditions, and the dotted curve to a series of observations taken under more favorable conditions. For reasons which will appear in due course any such curve is called a probability curve. The line XX , or axis of x , is taken as the axis of errors, and the line AY , or axis of y , as the axis of facility, the point A being taken as the origin of coordinates. Thus in the case of the solid curve, if the line Aa represents any

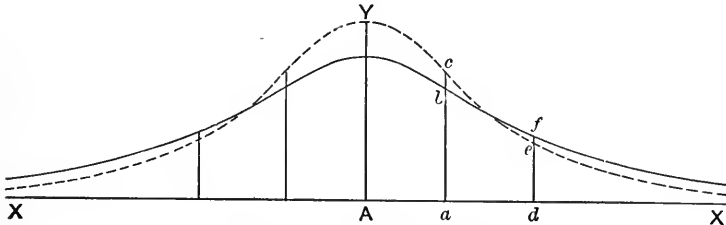

FIG. 63.—Probability Curves.

proposed error, then the ordinate ab represents the facility with which that error occurs in the case assumed. The first law is illustrated by making the curves symmetrical with reference to the axis of y , so that the ordinates are equal for corresponding plus and minus values of x . The second law is illustrated by the decreasing ordinates as the plus and minus abscissas are increased in length. The third law does not admit of exact representation, since a mathematical curve can not have all its ordinates equal to zero after passing a certain point; a satisfactory result is reached, however, by making all ordinates after a certain point extremely small, with the axis of x as an asymptote to the curves. The fourth law is illustrated by means of the solid curve and the dotted curve, both of which are consistent with the first three laws, but which have different ordinates for the same proposed error. Thus small errors, such as Aa , occur with greater frequency (or greater facility) in the case of the dotted curve than in the

case of the solid curve, as shown by the ordinate ac being longer than the ordinate ab ; while large errors, such as Ad , occur with less frequency (or less facility) in the case of the dotted curve than in the case of the solid curve, as shown by the ordinate de being shorter than the ordinate df .

145. The Two Types of Error. The recorded readings in any series of observations are subject to two distinct types of error. The first type of error includes all those errors involved in the *making* of the measurement, such as those due to imperfect instrumental adjustments, unfavorable atmospheric conditions, imperfect bisection of targets, imperfect estimation of scale readings, etc. The second type of error is that involved in the *reading* or *recording* of the result, which must be done in terms of some definite least count which excludes all intermediate values.

A given reading, therefore, does not indicate that precisely that value has been reached in the process of measurement, but only such a value as must be represented by that reading; so that a given reading may be due to any one of an infinite number of possible values lying within the limits of the least count. Similarly, the *error* in the recorded reading does not indicate that precisely that error has been made in the process of measurement, but only such an error as must be represented by that value; so that the error of the recorded reading may in fact be due to any one of an infinite number of possible errors lying within the limits of the least count. The first type of error is the true type or that which corresponds to the *accidental* conditions under which a series of observations are made, while the second type is a false type or *definite* condition or limitation under which the work must be done. Thus in sighting at a target a number of times the angular errors of bisection may vary among themselves by amounts which can only be expressed in indefinitely small decimals of a second. If the least count recognized in recording the scale readings is one second, however, the recorded readings and the corresponding errors will vary among themselves by amounts which differ by even seconds. The probability curve of the preceding article is based on the first type of error only, and is therefore a mathematically continuous curve, since all values of the error are possible with this type. In speaking of the errors of observations, however, the

errors of the recorded values are in general understood, and these must necessarily differ among themselves by exactly the value of the least count.

146. The Facility of Error. If an instrument is correctly read to any given least count, no reading can be in error by more than plus or minus a half of this least count; or, in other words, each reading is the central value of an infinite number of possible values lying within the limits of the least count. If a great many observations are taken on a given magnitude, each particular reading will be found to repeat itself with more or less frequency, since all values lying within a half of the least count of that particular reading must be recorded with the value of that reading. If the same instrument, however, carried finer graduations, with the least count half the previous value, each reading would represent only those values within half the previous limits. There would then be twice as many representative readings, with each one standing for half as many actual values as with the coarser graduations. It is thus seen that the relative frequency with which a given reading (and the corresponding error) occurs, is directly proportional to the least count of the instrument, or least count used in recording the readings. Just as each reading is taken to represent an infinite number of possible values within the limits of the least count, so that reading must correspond to an infinite number of possible errors within the same limits, each possible error having a different facility of occurrence. Since in the long run, however, each reading will be practically the average of all the values that it represents, so the facility of the error due to that reading may be taken practically as the average facility of all the corresponding errors. By definition (Art. 143) the facility of a given accidental error is proportional to the frequency of its occurrence. It is thus seen that the relative frequency with which a given error (representing all possible errors due to a given reading) occurs, is proportional to the facility of that error. Since the relative frequency with which a given error occurs is proportional to both its facility and the least count, it is proportional to their product, and is always made *equal* to this product by using a suitable scale of facility. The facility of a given error is hence equal to the relative frequency of occurrence of that error divided by the least count.

147. The Probability of Error. By the *probability* of an error is meant the relative frequency of its occurrence. Thus in the measurement of an angle, if a given error occurred (on the average) 27 times in 1000 observations, then the probability that an additional measurement would be in error by that same amount would be $\frac{27}{1000}$. The probability of a given error being identical with its relative frequency of occurrence is hence (Art. 146) equal to the product of the facility of that error by the least count. The probability of error for a certain set of conditions is illustrated in Fig. 64. In this figure the spaces da , ae , eb , and bf are each equal to one-half of the least count. The probability that an error Aa will occur is hence, in accordance with the above principles, equal to the product of am (the facility) by

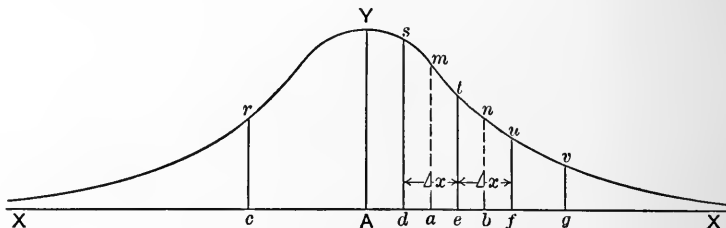

FIG. 64.—The Probability of Error.

de (the least count). As the least count is always very small, we may write without appreciable error,

$$\text{Probability of error } Aa = am \times de = \text{area } dste.$$

But (Art. 145) the error Aa in the recorded reading includes all the possible errors lying between Ad and Ae , that is, within half the least count each way from Aa . The area $dste$ therefore represents the probability that the actual error committed lies between the values Ad and Ae . Similarly the area $etuf$ represents the probability of an actual error between the values Ae and Af . The probability that an actual error shall lie either between Ad and Ae or between Ae and Af (compound event, Art. 140), or in other words between Ad and Af , is equal to the sum of the two separate probabilities, that is, to the combined area $dsuf$. Or, in general, the probability that an error shall fall between any two values Ac and Ag , is represented by the area included between the corresponding ordinates cr and gv . On account

of this characteristic property the curve of facilities is commonly called the probability curve. Strictly speaking the ordinates limiting the area can only occur at certain equally spaced intervals depending on the least count, but no material error is ever introduced by drawing them at any points whatever.

148. The Law of the Facility of Error is that law which connects all the possible errors in any set of observations with their corresponding facilities, and is expressed analytically by the equation of the probability curve. The law which governs the occurrence of errors in any particular set of observations is necessarily unknown and beyond determination, being the combined result of an uncertain number of variable and unknown causes. Fortunately, however, it is found by experience that there is one particular *form of law* which (with proper constants) very closely represents the facility of error in all classes of observations. This form of law is that which is in accordance with the assumption that the arithmetic mean of the observed values is the most probable value when the same magnitude has been observed a large number of times under the same conditions. The same *form of law* being accepted as satisfactory in all cases, therefore, the law for any particular case is determined by the substitution of the proper constants.

149. Form of the Probability Equation. If x represents any possible error and y the facility of its occurrence, we may write

$$y = \phi(x), \dots \dots \dots (6)$$

which is read y equals a function of x . When the form of this function has been determined the expression will be the general equation of the probability curve. Since the probability that the error x (of a recorded reading) will occur is equal (Art. 147) to its facility multiplied by the least count, we have

$$P = y\Delta x = \phi(x)\Delta x, \dots \dots \dots (7)$$

in which P is the probability of the occurrence of the error x , and Δx is the least count. If x_1, x_2, \dots, x_n are the true errors in the observed values of any magnitude Z , and P_1, P_2, \dots, P_n are the corresponding probabilities of occurrence, we thus have

$$P_1 = \phi(x_1)\Delta x, \quad P_2 = \phi(x_2)\Delta x, \quad \text{etc.}$$

The probability P of the occurrence of this particular series of errors, x_1, x_2 , etc., in a set of observations of equal weight, being a concurrent event (Art. 141), is equal to the product of the individual probabilities, giving

$$P = \phi(x_1) \cdot \phi(x_2) \dots \phi(x_n) \cdot (\Delta x)^n; \dots \dots \dots (8)$$

whence

$$\log P = \log \phi(x_1) + \log \phi(x_2) \dots + \log \phi(x_n) + n \log \Delta x. \quad (9)$$

The true value of the unknown quantity Z , and the errors x_1, x_2 , etc., can never be known. Any assumed value of Z will result in a particular series of values v_1, v_2 , etc., for the errors of the several observations. That value of Z will be the most probable which produces the series of errors which has the highest probability of occurrence. Replacing the true errors x_1, x_2 , etc., in Eq. (9) by the variable errors v_1, v_2 , etc., and making the first differential coefficient equal to zero to obtain a maximum value of P , we have

$$\frac{d \log \phi(v_1)}{dv_1} + \frac{d \log \phi(v_2)}{dv_2} \dots + \frac{d \log \phi(v_n)}{dv_n} = 0; \quad (10)$$

which may be written

$$\left(\frac{d \log \phi(v_1)}{v_1 dv_1} \right) v_1 + \left(\frac{d \log \phi(v_2)}{v_2 dv_2} \right) v_2 \dots + \left(\frac{d \log \phi(v_n)}{v_n dv_n} \right) v_n = 0. \quad (11)$$

But it has already been decided (Art. 134) that the arithmetic mean of such a series of observed values is the most probable value of the quantity observed. The adoption of the arithmetic mean as the most probable value, however, requires the algebraic sum of the residuals (Art. 135) to reduce to zero; whence

$$v_1 + v_2 \dots + v_n = 0. \dots \dots \dots (12)$$

Since v_1, v_2 , etc., are the result of chance, and hence independent of each other, it follows from Eq. (12) that the coefficients of v_1 , etc., in Eq. (11) must all have the same value. Representing this unknown value for any particular set of observations by the

constant k , we have as the general condition which makes the arithmetic mean the most probable value,

$$\frac{d \log \phi(v)}{v dv} = k,$$

whence by transposition

$$d \log \phi(v) = kv dv.$$

Integrating this equation

$$\log \phi(v) = \frac{1}{2}kv^2 + \log c,$$

in which $\log c$ represents the unknown constant of integration. Passing to numbers, we have

$$\phi(v) = ce^{\frac{1}{2}kv^2}, \quad (13)$$

in which e equals the base of the Napierian system of logarithms. It is necessary at this point to remember that the probability of the occurrence of a given error does not involve the question as to whether we are right or wrong in assuming that an error of that value has occurred in a particular observation. Thus in the preceding discussion the probabilities assigned to the assumed values of v_1, v_2 , etc., are the probabilities for true errors of these values, regardless of whether such errors have or have not occurred in the given case. It is of the utmost importance, therefore, to realize that Eq. (13) is not based on the assumption that the error v has occurred, but is a general statement of fact concerning any true error whose magnitude is v . Replacing v in Eq. (13) by x , the adopted symbol for true errors, we have

$$\phi(x) = ce^{\frac{1}{2}kx^2};$$

but from equation (6)

$$y = \phi(x);$$

whence

$$y = ce^{\frac{1}{2}kx^2}.$$

Since the facility y decreases as the numerical value of x increases, it follows that $\frac{1}{2}k$ is essentially negative, and it is therefore commonly replaced by $-h^2$. Making this substitution, we have

$$y = ce^{-h^2x^2}, \quad (14)$$

in which y equals the facility with which any error x occurs, c and h are unknown constants depending on the circumstances of observation, and e is the base of the Napierian system of logarithms. Though correct in apparent form, Eq. (14) must not yet be regarded as the general equation of the probability curve, since the quantities c and h appear as arbitrary constants, whereas it will be shown in the next article that these values are dependent on each other.

150. General Equation of the Probability Curve. The probability that an error shall fall between any two given values (Art. 147) is equal to the area between the corresponding ordinates of the probability curve. The probability that an error shall fall between $-\infty$ and $+\infty$ is therefore equal to the entire area of the curve. But it is absolutely certain that any error which may occur will fall between these extreme limits, and the probability of a certain event (Art. 138) is equal to unity. The entire area of any curve represented by Eq. (14) must therefore be equal to unity. Since all probability curves have the same total area, it follows that any change in h will require a compensating change in c ; or, in other words, c must be a function of h . The general expression for the area of any plane curve is

$$A = \int y dx.$$

Substituting the value of y from Eq. (14)

$$A = \int ce^{-h^2x^2} dx.$$

The probability P that an error x will fall between the limits a and b , is therefore

$$P = \int_a^b ce^{-h^2x^2} dx, \quad (15)$$

and between the limits $-\infty$ and $+\infty$, is

$$P = \int_{-\infty}^{\infty} ce^{-h^2x^2}dx = c \int_{-\infty}^{\infty} e^{-h^2x^2}dx.$$

But this probability, being a certainty, equals unity; whence

$$1 = c \int_{-\infty}^{\infty} e^{-h^2x^2}dx,$$

or

$$\frac{1}{c} = \int_{-\infty}^{\infty} e^{-h^2x^2}dx.$$

The second member of this equation is a definite integral whose evaluation by the methods of the calculus (for which such works should be seen) gives

$$\int_{-\infty}^{\infty} e^{-h^2x^2}dx = \frac{\sqrt{\pi}}{h};$$

hence

$$\frac{1}{c} = \frac{\sqrt{\pi}}{h},$$

and

$$c = \frac{h}{\sqrt{\pi}},$$

which substituted in Eq. (15) gives for the probability P that an error x will fall between any limits a and b ,

$$P = \frac{h}{\sqrt{\pi}} \int_a^b e^{-h^2x^2}dx. \dots \dots \dots (16)$$

Also substituting the above value of c in Eq. (14) we have for the general equation of the probability curve

$$y = \frac{h}{\sqrt{\pi}} e^{-h^2x^2}, \dots \dots \dots (17)$$

in which y is the facility with which any error x occurs, e ($= 2.7182818$) is the base of the Napierian system of logarithms, and h (called the precision factor) is a constant depending on the circumstances of observation. The constant h is the only element

in Eq. (17) which can vary with the precision of the work, and therefore of necessity becomes the measure of that precision.

151. The Value of the Precision Factor. The general equation of the probability curve is given by Eq. (17), but the definite equation for any particular set of observations is not known until the corresponding value of h has been determined. The probability that an error x will occur (Art. 149) is

$$P = y \Delta x = \phi(x) \Delta x.$$

Substituting the value of y from Eq. (17),

$$P = \frac{h}{\sqrt{\pi}} e^{-h^2 x^2} \Delta x = \phi(x) \Delta x. \quad (18)$$

With an infinite number of observations any residual v_1 would be infinitely close to the corresponding true error x_1 , and the relative frequency with which v_1 occurred would not differ appreciably from P_1 . The value of h for any particular case could thus be found from Eq. (18) by substituting these values for P and x . As the number of observations is always limited, however, the best that can be done is to find the most probable value of h for the given case. The probability that a given set of errors has occurred is, by Eq. (8),

$$P = \phi(x_1) \cdot \phi(x_2) \dots \phi(x_n) \cdot (\Delta x)^n.$$

But from Eqs. (6) and (17)

$$\phi(x_1) = \frac{h}{\sqrt{\pi}} e^{-h^2 x_1^2}, \text{ etc.};$$

so that

$$P = \left(\frac{h}{\sqrt{\pi}} \right)^n e^{-h^2 \Sigma x^2} (\Delta x)^n,$$

and

$$\log P = n \log h - h^2 \Sigma x^2 + n \log \Delta x - \frac{n}{2} \log \pi;$$

whence by making the first derivative with respect to h equal to zero

$$\frac{n}{h} - 2 \Sigma x^2 \cdot h = 0.$$

Solving for h we have

$$h = \sqrt{\frac{n}{2\Sigma x^2}}, \dots \dots \dots (19)$$

in which n is the number of observations taken, and Σx^2 is the sum of the squares of the true errors which have occurred. The true errors, however, can never be known, and formula (19) must therefore be modified so as to give the most probable value of h that can be determined from the residual errors. A discussion of this condition is beyond the scope of this book, but for observations of equal (or unit) weight results in the formula

$$h = \sqrt{\frac{n-1}{2\Sigma v^2}}, \dots \dots \dots (20)$$

in which n as before is the number of observations that have been taken, and Σv^2 is the sum of the squares of the residual errors.

For observations of unequal weight (Art. 133) formula (19) becomes

$$h = \sqrt{\frac{n-1}{2\Sigma pv^2}}, \dots \dots \dots (21)$$

in which Σpv^2 is the sum of the weighted squares of the residuals, and h as before is the precision factor for observations of unit weight.

For the general case of indirect observations (Art. 158) on independent quantities, that is, with *no conditional equations* (Art. 131), formula (19) becomes

$$h = \sqrt{\frac{n-q}{2\Sigma pv^2}}, \dots \dots \dots (22)$$

in which n is the number of observation equations, q is the number of unknown quantities, Σpv^2 is the sum of the weighted squares of the residuals, and h is the precision factor for observations of unit weight.

For the general case of indirect observations *involving conditional equations*, formula (19) becomes

$$h = \sqrt{\frac{n-q+c}{2\Sigma pv^2}}, \dots \dots \dots (23)$$

in which c is the number of conditional equations, n is the number of observation equations, q is the number of unknown quantities, Σpv^2 is the sum of the weighted squares of the residuals, and h is the precision factor for observations of unit weight. As will be understood later (Art. 166), the number of *independent* unknowns is always reduced by an amount which equals the number of conditional equations, so that q in Eq. (22) is simply replaced by $(q - c)$ in Eq. (23).

152. Comparison of Theory and Experience. In the *Fundamenta Astronomiæ* Bessel gives the following comparison of theory and experience. In a series of 470 observations by Bradley on the right ascensions of Sirius and Altair the value of h was found to be 1.80865, giving rise to the following table:

Numerical Errors between		Probability of Errors.	Number of Errors	
			By Theory.	By Experience.
"	"			
0.0	0.1	0.2018	94.8	94
0.1	0.2	0.1889	88.8	88
0.2	0.3	0.1666	78.3	78
0.3	0.4	0.1364	64.1	58
0.4	0.5	0.1053	49.5	51
0.5	0.6	0.0761	35.8	36
0.6	0.7	0.0514	24.2	26
0.7	0.8	0.0328	15.4	14
0.8	0.9	0.0194	9.1	10
0.9	1.0	0.0107	5.0	7
1.0	∞	0.0106	5.0	8
Totals.....		1.0000	470.0	470

The last column in this table tacitly assumes that the true errors do not differ materially from the residual errors, the true errors being of course unknown. The agreement of theory and experience is very satisfactory.

There are two important points to be observed in applying the theory of errors to the results obtained in practical work.

In the first place, the theory of errors presupposes that a very large number of observations have been made. It is customary, however, to apply the theory to any number of observations, however limited. It is evident in such cases that reasonable judgment must be used in interpreting the results obtained by the application of the theory. In the second place, the theory of errors is the theory of *accidental* errors. It is in general impossible to entirely prevent *systematic* errors in a process of observation; and such errors can not be discovered or eliminated by any number of observations, however great, if the circumstances of observation remain unchanged. The theory of errors, therefore, makes no pretense of discovering the truth in any case, but only to determine the best conclusions that can be drawn from the observations that have been made.

CHAPTER XI

MOST PROBABLE VALUES OF INDEPENDENT QUANTITIES

153. General Considerations. In accordance with the discussions of the previous chapter it is evident that the true value of an observed quantity can never be found. Adopting any particular value for the observed quantity is equivalent to assuming that a certain series of errors has occurred in the observed values. Manifestly the most probable value of the observed quantity is that which corresponds to the most probable series of errors; or, in other words, that series of errors which has the highest probability of occurrence. It is therefore by means of the theory of errors (Chapter X) that rules are established for determining the most probable values of observed quantities.

154. Fundamental Principle of Least Squares. For the general equation of the probability curve, Eq. (17), Art. 150, we have

$$y = \frac{h}{\sqrt{\pi}} e^{-h^2 x^2},$$

in which y is the facility of occurrence of any error x under the conditions represented by the precision factor h . The probability that any error x will occur (Art. 147) is equal to its facility multiplied by the least count, or

$$P = y \Delta x.$$

Hence if x_1, x_2, \dots, x_n are the errors in the observed values of any magnitude Z , and P_1, P_2, \dots, P_n are the corresponding probabilities of occurrence, we have

$$y_1 = \frac{h}{\sqrt{\pi}} e^{-h^2 x_1^2}, \quad y_2 = \frac{h}{\sqrt{\pi}} e^{-h^2 x_2^2}, \quad \text{etc.},$$

and

$$P_1 = y_1 \Delta x, \quad P_2 = y_2 \Delta x, \quad \text{etc.}$$

The probability P of the occurrence of this particular series of errors x_1, x_2 , etc., in the given set of observations, being a concurrent event (Art. 141), is equal to the product of the individual probabilities, giving

$$P = (y_1 y_2 \dots y_n) (\Delta x)^n = \left(\frac{h}{\sqrt{\pi}}\right)^n e^{-h^2 \Sigma x^2} (\Delta x)^n.$$

This equation is true for any proposed series of errors, and hence for that series of residual errors $v_1, v_2, \dots v_n$, which results from assigning the most probable value to the observed quantity. In this case Σx^2 becomes Σv^2 , and we have

$$P = \left(\frac{h}{\sqrt{\pi}}\right)^n e^{-h^2 \Sigma v^2} (\Delta x)^n. \dots \dots \dots (24)$$

But (Art. 153) the most probable value of the observed quantity corresponds to that series of errors which has the highest probability of occurrence. The most probable value z of any observed quantity Z , therefore, requires P in Eq. (24) to be a maximum, and this in turn requires Σv^2 to be a minimum. We thus have the following

PRINCIPLE: *In observations of equal precision the most probable values of the observed quantities are those that render the sum of the squares of the residual errors a minimum.*

It is on account of this principle that the Method of Least Squares has been so named.

155. Direct Observations of Equal Weight. A direct observation (Art. 133) is one that is made directly on the quantity whose value is to be determined. When the given magnitude is measured a number of times under the same conditions (as represented by the same precision factor h in the probability curve), the results obtained are said to be of equal weight or precision. In such a case the most probable value of the quantity sought must accord with the principle of the previous article, that is, the sum of the squares of the residual errors must be a minimum.

Let z = the most probable value of a given magnitude;

n = the number of measurements taken;

$M_1, M_2, \dots M_n$ = the several measured values;

then (Art. 154)

$$(M_1 - z)^2 + (M_2 - z)^2 \dots + (M_n - z)^2 = \text{a minimum.}$$

Placing the first derivative equal to zero,

$$2(M_1 - z) + 2(M_2 - z) \dots + 2(M_n - z) = 0;$$

whence

$$(M_1 + M_2 \dots + M_n) - nz = 0,$$

and

$$z = \frac{M_1 + M_2 \dots + M_n}{n} = \frac{\Sigma M}{n}; \quad \dots \quad (25)$$

or, expressed in words, in the case of direct observations of equal weight the most probable value of the unknown quantity is equal to the arithmetic mean of the observed values. The above discussion, however, must not be regarded as a proof of this principle of the arithmetic mean, since (Art. 149) this very principle was one of the conditions under which the equation of the probability curve was deduced. Eq. (25) therefore simply shows that the equation of the probability curve is correct in form and consistent with this principle.

Example. The observed values (of equal weight) of an angle A are $29^\circ 21' 59''.1$, $29^\circ 22' 06''.4$, and $29^\circ 21' 58''.1$. What is the most probable value?

$$\begin{array}{r} 29^\circ 21' 59''.1 \\ 29 \quad 22 \quad 06 \quad .4 \\ 29 \quad 21 \quad 58 \quad .1 \\ \hline 3) 88 \quad 06 \quad 03 \quad .6 \\ 29 \quad 22 \quad 01 \quad .2 \end{array}$$

The most probable value is therefore $29^\circ 22' 01''.2$.

156. General Principle of Least Squares. When a given magnitude is measured a number of times under different conditions (so that the precision factor corresponding to some of the observations is not the same for all of them), the results obtained are said to be of unequal weight or precision. In accordance with the sense in which weights are understood (Art. 133), an observation assigned a weight of two means it is considered as good a determination as the arithmetic mean of two observations of unit weight, and so on. It is immaterial whether any one of the observed values is considered of unit weight, as this is merely a basis of comparison.

- Let z = the most probable value of a given magnitude;
 $M_1, M_2, \text{etc.}$ = the values of the several measurements;
 $p_1, p_2, \text{etc.}$ = the respective weights of these measurements;
 $ap_1, ap_2, \text{etc.}$ = the corresponding integral weights due to the use of the factor a ;
 $m_1', m_1'', \text{etc.}$ = the ap_1 unit weight components of M_1 when considered as an arithmetical mean;
 $m_2', m_2'', \text{etc.}$ = similarly for M_2 , and so on;
 $v_1, v_2, \text{etc.}$ = the residuals due to $M_1, M_2, \text{etc.}$;

then, as in Art. 134, we have

$$\begin{aligned}
 M_1 &= \frac{m_1' + m_1'' \dots}{ap_1} = \frac{\Sigma m_1}{ap_1}, \\
 M_2 &= \frac{m_2' + m_2'' \dots}{ap_2} = \frac{\Sigma m_2}{ap_2}, \\
 z &= \frac{\Sigma m}{\Sigma ap} = \frac{\Sigma ap \cdot M}{\Sigma ap} = \frac{\Sigma pM}{\Sigma p} \dots \dots \dots (26)
 \end{aligned}$$

The value of z thus obtained is evidently independent of any particular set of values that may be assigned to the components $m_1', m_1'', \text{etc.}$, the components $m_2', m_2'', \text{etc.}$, and so on. Since these various components are all of equal weight we must have in accordance with Art. 154,

$$\Sigma(z - m_1)^2 + \Sigma(z - m_2)^2 \dots + \Sigma(z - m_n)^2 = \text{a minimum, } (27)$$

as a criterion that must be satisfied when z is the most probable value of the quantity Z . But, in accordance with Eq. (26), this criterion must determine the *same* value of z no matter what particular sets of values may be substituted for the components $m_1', m_1'', \text{etc.}$, $m_2', m_2'', \text{etc.}$, and so on. Adopting, therefore, the particular sets of values

$$\begin{aligned}
 m_1' &= m_1'' = \dots = M_1, \\
 m_2' &= m_2'' = \dots = M_2, \\
 \text{etc.} & \quad \text{etc.,}
 \end{aligned}$$

whence

$$\begin{aligned}\Sigma(z - m_1)^2 &= ap_1 (z - M_1)^2 = ap_1 \cdot v_1^2, \\ \Sigma(z - m_2)^2 &= ap_2 (z - M_2)^2 = ap_2 \cdot v_2^2, \\ &\text{etc.} \qquad \qquad \text{etc.,}\end{aligned}$$

and substituting in Eq. (27), we have

$$ap_1 \cdot v_1^2 + ap_2 \cdot v_2^2 \dots + ap_n \cdot v_n^2 = \text{a minimum};$$

or, dividing out the common factor a ,

$$p_1 v_1^2 + p_2 v_2^2 \dots + p_n v_n^2 = \text{a minimum.} \quad \dots \quad (28)$$

We thus have the following

GENERAL PRINCIPLE: *In observations of unequal precision the most probable values of the observed quantities are those that render the sum of the weighted squares of the residual errors a minimum.*

157. Direct Observations of Unequal Weight. When a given magnitude is directly measured a number of times it may be necessary to assign different weights to the results obtained, on account of some change in the conditions governing the measurements. In such a case the most probable value of the quantity sought must accord with the principle of the previous article, that is, the sum of the weighted squares of the residual errors must be a minimum.

Let z = the most probable value of a given magnitude;

$M_1, M_2, \dots M_n$ = the several measured values;

$p_1, p_2, \dots p_n$ = the corresponding weights;

then (Art. 156)

$$p_1(M_1 - z)^2 + p_2(M_2 - z)^2 \dots + p_n(M_n - z)^2 = \text{a minimum.}$$

Placing the first derivative equal to zero,

$$2p_1(M_1 - z) + 2p_2(M_2 - z) \dots + 2p_n(M_n - z) = 0;$$

whence

$$(p_1 M_1 + p_2 M_2 \dots + p_n M_n) - (p_1 + p_2 \dots + p_n) z = 0,$$

and

$$z = \frac{p_1 M_1 + p_2 M_2 \dots + p_n M_n}{p_1 + p_2 \dots + p_n} = \frac{\Sigma p M}{\Sigma p}; \dots \dots (29)$$

or, expressed in words, in the case of direct observations of unequal weight the most probable value of the unknown quantity is equal to the weighted arithmetic mean of the observed values. The above discussion, however, must not be regarded as a proof of this principle of the weighted arithmetic mean, since Eq. (29) is deduced from a principle based in part on the truth of Eq. (26), which is identical with Eq. (29). As the truth of Eq. (26) is established in Art. 156, however, Eq. (29) shows that the general principle of least squares leads to a correct result in a case where the answer is already known.

Example. The observed values for the length of a certain base line are 4863.241 ft. (weight 2), and 4863.182 ft. (weight 1). What is the most probable value?

$$\begin{array}{r} 4863.241 \times 2 = 9726.482 \\ 4863.182 \times 1 = 4863.182 \\ \hline 3)14589.664 \\ \hline 4863.221 \end{array}$$

The most probable value is therefore 4863.221 ft.

158. Indirect Observations. An *indirect observation* is one that is made on some *function* of one or more quantities, instead of being made directly on the quantities themselves. Thus in measuring an angle by repetition the observation is indirect, as the angle actually read is not the angle sought, but some multiple thereof. Similarly when angles are measured in combination the observations are indirect, since the values of the individual angles must be deduced from the results obtained by some process of computation.

An *observation equation* is an equation expressing the function observed and the value obtained. Thus if x, y , etc., represent the unknown quantities whose values are to be deduced from the

observation, we may have as observation equations such expressions as

$$6x = 185^\circ 19' 40'',$$

or

$$7x + 10y - 3z = 65.73,$$

according to the function observed.

In general the observation equations which occur in geodetic work may be written in the following form:

$$\left. \begin{aligned} a_1x + b_1y + c_1z \dots &= M_1 \text{ (weight } p_1) \\ a_2x + b_2y + c_2z \dots &= M_2 \text{ (weight } p_2) \\ \cdot & \cdot \cdot \cdot \cdot \cdot \cdot \cdot \cdot \cdot \cdot \\ a_nx + b_ny + c_nz \dots &= M_n \text{ (weight } p_n) \end{aligned} \right\}, \quad (30)$$

in which a_1, a_2, b_1, b_2 etc., are known coefficients; x, y , etc., are the unknown quantities; M_1, M_2 , etc., are the observed values; and p_1, p_2 , etc., are the respective weights of these values. If the number of observation equations is less than the number of unknown quantities, the values of x, y, z , etc., can not be found, nor even their most probable values. If the number of observation equations equals the number of unknown quantities, the equations may be solved as simultaneous equations, and each equation will be exactly satisfied by the values obtained for x, y, z , etc., even though these values are not the true values sought. If the number of observation equations exceeds the number of unknown quantities there will in general be no values of x, y, z , etc., which will exactly satisfy all the equations, on account of the unavoidable errors of observation. Hence if the *most probable* values of the unknown quantities be substituted the equations will not be exactly satisfied, but will reduce to small residuals v_1, v_2, v_3 , etc. If, therefore, x, y, z , etc., be understood to mean the most probable values of these quantities, we will have

$$\left. \begin{aligned} a_1x + b_1y + c_1z \dots - M_1 &= v_1 \text{ (weight } p_1) \\ a_2x + b_2y + c_2z \dots - M_2 &= v_2 \text{ (weight } p_2) \\ \cdot & \cdot \cdot \cdot \cdot \cdot \cdot \cdot \cdot \cdot \cdot \\ a_nx + b_ny + c_nz \dots - M_n &= v_n \text{ (weight } p_n) \end{aligned} \right\} \quad (31)$$

By a consideration of these equations, together with any special conditions which must be satisfied, rules may be established for finding the most probable values of the unknown quantities in all cases of indirect observations.

159. Indirect Observations of Equal Weight on Independent Quantities. An *independent quantity* is one whose value is independent of the value of any other quantity under consideration. Thus in a line of levels the elevation of any particular bench mark bears no necessary relation to the elevation of any other bench mark; whereas in a triangle the three angles are not independent of each other, as their sum must necessarily equal 180°.

In the case of indirect observations of equal weight on independent quantities, the most probable values of the unknown quantities are found by a direct application of the method of normal equations. A *normal equation* is an equation of condition which determines the most probable value of any one unknown quantity corresponding to any particular set of values assigned to the remaining unknowns. A normal equation must therefore be specifically a normal equation in x , or in y , etc. By forming a normal equation for each of the unknowns there will be as many equations as unknown quantities. The solution of these equations as simultaneous will give a set of values for the unknowns in which each value is the most probable that is consistent with the remaining values, which can only be the case when all the values are simultaneously the most probable values of the unknown quantities.

To establish a rule for forming the normal equations in the case of equal weights let us re-write Eqs. (31), omitting the weights, thus:

$$\left. \begin{aligned} a_1x + b_1y + c_1z \dots - M_1 &= v_1 \\ a_2x + b_2y + c_2z \dots - M_2 &= v_2 \\ \dots & \dots \dots \dots \dots \dots \\ a_nx + b_ny + c_nz \dots - M_n &= v_n \end{aligned} \right\} \dots \dots \dots (32)$$

In accordance with Art. 154 the most probable values of the unknown quantities are those which give

$$v_1^2 + v_2^2 \dots + v_n^2 = \text{a minimum.}$$

Since (in forming the normal equations) the most probable value of x is desired for any assumed set of values for the remaining unknowns, we place the first derivative with respect to x equal to zero; whence, omitting the common factor 2, we have

$$v_1 \left(\frac{dv_1}{dx} \right) + v_2 \left(\frac{dv_2}{dx} \right) \dots + v_n \left(\frac{dv_n}{dx} \right) = 0.$$

But from Eqs. (32), under the given assumption of fixed values for all quantities excepting x , we obtain

$$\frac{dv_1}{dx} = a_1, \quad \frac{dv_2}{dx} = a_2, \text{ etc.};$$

whence by substitution,

$$a_1 v_1 + a_2 v_2 \dots + a_n v_n = 0 = \text{normal equation in } x.$$

In a similar manner we have

$$b_1 v_1 + b_2 v_2 \dots + b_n v_n = 0 = \text{normal equation in } y;$$

$$c_1 v_1 + c_2 v_2 \dots + c_n v_n = 0 = \text{normal equation in } z;$$

$$\text{etc.}, \quad \text{etc.};$$

and hence for forming the several normal equations in the case of indirect observations of equal weight on independent quantities, we have the following

RULE: *To form the normal equation for each one of the unknown quantities, multiply each observation equation by the algebraic coefficient of that unknown quantity in that equation, and add the results.*

Having formed the several normal equations, their solution as simultaneous equations gives the most probable values of the unknown quantities.

Example 1. Given the observation equation

$$6x = 90^\circ 15' 30''.$$

In applying the above rule to this case we would have to multiply the whole equation by 6, and then divide by 36 to obtain the most probable value of x . It is evident that we would obtain the same value of x by dividing the original equation by 6, so that in the case of a single equation with a single unknown quantity the most probable value of that quantity is obtained by simply solving the equation.

Example 2. Given the observation equations

$$\begin{aligned} 2x &= 124.72, \\ x &= 62.31, \\ 7x &= 439.00. \end{aligned}$$

Multiplying the first equation by 2, the second by 1, and the third by 7, we have

$$\begin{aligned} 4x &= 249.44; \\ x &= 62.31; \\ 49x &= 3073.00; \end{aligned}$$

whence by addition we obtain the normal equation

$$54x = 3384.75,$$

the solution of which gives

$$x = 62.68,$$

which is hence the most probable value that can be obtained from the given set of observations. The student is cautioned against adding up the observation equations and solving for x , as this plan does not give the most probable value in such cases.

Example 3. Given the observation equations

$$\begin{aligned} 2x + y &= 31.65, \\ x - 3y &= 5.03, \\ x - y &= 11.26. \end{aligned}$$

Following the rule for normal equations, we have

$$\begin{aligned} 4x + 2y &= 63.30 \\ x - 3y &= 5.03 \\ \hline x - y &= 11.26 \\ 6x - 2y &= 79.59 = \text{normal equation in } x; \end{aligned}$$

and

$$\begin{aligned} 2x + y &= 31.65 \\ -3x + 9y &= -15.09 \\ -x + y &= -11.26 \\ \hline -2x + 11y &= 5.30 = \text{normal equation in } y. \end{aligned}$$

It is absolutely essential in forming the normal equations to multiply by the algebraic coefficients as illustrated above, and not simply by the numerical value of the coefficient. Bringing the normal equations together, we have

$$\begin{aligned} 6x - 2y &= 79.59, \\ -2x + 11y &= 5.30. \end{aligned}$$

Attention is called to the fact that the coefficients in the first row and first column are identical in sign, value, and order, and that the same is true of the second row and second column. The same law would hold good if there were a third row and a third column, and so on (Art. 162); and this is a check that must never be neglected. Solving the two normal equations as simultaneous equations, we have

$$x = 14.29 \quad \text{and} \quad y = 3.08,$$

and these are hence their most probable values.

and hence for forming the several normal equations in the case of indirect observations of unequal weight on independent quantities, we have the following

RULE: To form the normal equation for each one of the unknown quantities, multiply each observation equation by the product of the weight of that observation and the algebraic coefficient of that unknown quantity in that equation, and add the results.

Having formed the several normal equations, their solution as simultaneous equations gives the most probable values of the unknown quantities.

Example 1. Given the observation equations

$$\begin{aligned} 3x &= 15^\circ 30' 34'' .6 \text{ (weight 2),} \\ 5x &= 25 \quad 50 \quad 55 \quad .0 \text{ (weight 3).} \end{aligned}$$

Multiplying the first equation by 6 ($= 3 \times 2$), and the second equation by 15 ($= 5 \times 3$), we have

$$\begin{aligned} 18x &= 93^\circ 03' 27''.6; \\ 75x &= 387 \quad 43 \quad 45 \quad .0; \end{aligned}$$

whence by addition we obtain the normal equation

$$93x = 480^\circ 47' 12''.6,$$

the solution of which gives

$$x = 5^\circ 10' 11''.1,$$

which is hence the most probable value that can be obtained from the given set of observations.

Example 2. Given the observation equations

$$\begin{aligned} x + y &= 10.90 \text{ (weight 3),} \\ 2x - y &= 1.61 \text{ (weight 1),} \\ x + 3y &= 24.49 \text{ (weight 2).} \end{aligned}$$

Following the rule for normal equations, we have

$$\begin{aligned} 3x + 3y &= 32.70 \\ 4x - 2y &= 3.22 \\ 2x + 6y &= 48.98 \\ \hline 9x + 7y &= 84.90 = \text{normal equation in } x; \end{aligned}$$

and

$$\begin{aligned} 3x + 3y &= 32.70 \\ -2x + y &= -1.61 \\ 6x + 18y &= 146.94 \\ \hline 7x + 22y &= 178.03 = \text{normal equation in } y. \end{aligned}$$

Solving these two normal equations as simultaneous, we have

$$x = 4.172, \quad \text{and} \quad y = 6.765,$$

and these are hence their most probable values.

161. Reduction of Weighted Observations to Equivalent Observations of Unit Weight. To establish a rule for this purpose let us re-write Eqs. (30), thus:

$$\begin{aligned} a_1x + b_1y + c_1z \dots &= M_1 \text{ (weight } p_1), \\ a_2x + b_2y + c_2z \dots &= M_2 \text{ (weight } p_2), \\ \cdot & \quad \cdot \quad \cdot \quad \cdot \quad \cdot \\ a_nx + b_ny + c_nz \dots &= M_n \text{ (weight } p_n). \end{aligned}$$

Let C be such a factor as will change the first of these equations to an equivalent equation of unit weight, so that we may write

$$\begin{aligned} Ca_1x + Cb_1y + Cc_1z \dots &= CM_1 \text{ (weight 1),} \\ a_2x + b_2y + c_2z \dots &= M_2 \text{ (weight } p_2), \\ \cdot & \quad \cdot \quad \cdot \quad \cdot \quad \cdot \\ a_nx + b_ny + c_nz \dots &= M_n \text{ (weight } p_n); \end{aligned}$$

in which the most probable values of x, y, z , etc., are to remain the same as in the original equations; or, in other words, the two sets of equations are to lead to the same normal equations. In accordance with the rule of Art. 160, we have from the first set of equations

$$\left. \begin{array}{l} \text{Normal} \\ \text{equation} \\ \text{in } x \end{array} \right\} = \left\{ \begin{array}{l} (p_1a_1^2x + p_1a_1b_1y + p_1a_1c_1z \dots = p_1a_1M_1) \\ + (p_2a_2^2x + p_2a_2b_2y + p_2a_2c_2z \dots = p_2a_2M_2) \\ + (\dots \text{etc., } \dots \text{etc.} \dots) \end{array} \right\} \quad (34)$$

and from the second set of equations

$$\left. \begin{array}{l} \text{Normal} \\ \text{equation} \\ \text{in } x \end{array} \right\} = \left\{ \begin{array}{l} (C^2a_1^2x + C^2a_1b_1y + C^2a_1c_1z \dots = C^2a_1M_1) \\ + (p_2a_2^2x + p_2a_2b_2y + p_2a_2c_2z \dots = p_2a_2M_2) \\ + (\dots \text{etc., } \dots \text{etc.} \dots) \end{array} \right\} \quad (35)$$

Comparing Eq. (34) with Eq. (35), term by term, we find they are in all respects identical provided we write

$$C^2 = p_1;$$

whence

$$C = \sqrt{p_1}. \quad \dots \quad (36)$$

From the symmetry of the equations involved it is evident that the same conclusion would result from a comparison of the normal equations in y, z , etc. Hence it is seen that an observation equation of any given weight may be reduced to an equivalent equation of unit weight by multiplying the given equation by the square root of the given weight. Evidently the converse of this proposition is also true, so that an equation of unit weight can be raised to an equivalent equation of any given weight by dividing the given equation by the square root of the given weight. The general laws of weights, as given in Art. 53, are readily derived by an application of these two principles. The new equations formed in the manner described, and taken in conjunction with the new weights, may be used in any computations in place of the original equations, whenever so desired.

Example 1. Given the observation equation

$$3x = 8.66 \text{ (weight 4).}$$

What is the equivalent observation equation of unit weight?

Since the square root of 4 is 2, we have

$$6x = 17.32 \text{ (weight 1)}$$

as the equivalent equation.

Example 2. Given the observation equation

$$3x + 6y = 11.04 \text{ (weight 1).}$$

What is the equivalent observation equation of the weight 9?

Since the square root of 9 is 3, we have

$$x + 2y = 3.68 \text{ (weight 9)}$$

as the equivalent equation.

Example 3. Given the observation equation

$$x + y - 2z = a \text{ (weight 3).}$$

What is the equivalent observation equation of the weight 7?

Multiplying by $\sqrt{3}$ and dividing by $\sqrt{7}$, we have

$$\sqrt{\frac{3}{7}}x + \sqrt{\frac{3}{7}}y - 2\sqrt{\frac{3}{7}}z = \sqrt{\frac{3}{7}}a \text{ (weight 7)}$$

as the equivalent equation.

162. Law of the Coefficients in Normal Equations. In accordance with Art. 158, we may write in general for any set of observations

$$\begin{aligned} a_1x + b_1y + c_1z \dots &= M_1 \text{ (weight } p_1), \\ a_2x + b_2y + c_2z \dots &= M_2 \text{ (weight } p_2), \\ &\vdots \\ a_nx + b_ny + c_nz \dots &= M_n \text{ (weight } p_n). \end{aligned}$$

Forming the normal equation in x in accordance with the rule of Art. 160, the multiplying factors are p_1a_1 , p_2a_2 , etc., giving

$$\begin{aligned} p_1a_1^2x + p_1a_1b_1y + p_1a_1c_1z \dots &= p_1a_1M_1 \\ p_2a_2^2x + p_2a_2b_2y + p_2a_2c_2z \dots &= p_2a_2M_2 \\ &\vdots \\ \hline p_na_n^2x + p_na_nb_ny + p_na_nc_nz \dots &= p_na_nM_n \end{aligned}$$

$\Sigma(pa^2)x + \Sigma(pab)y + \Sigma(pac)z \dots = \Sigma(paM) = \text{normal equation in } x.$

Similarly, for the normal equation in y , the multiplying factors are p_1b_1 , p_2b_2 , etc., giving

$\Sigma(pab)x + \Sigma(pb^2)y + \Sigma(pbc)z \dots = \Sigma(pbM) = \text{normal equation in } y.$

Similarly, for the normal equation in z , the multiplying factors are p_1c_1 , p_2c_2 , etc., giving

$\Sigma(pac)x + \Sigma(pbc)y + \Sigma(pc^2)z \dots = \Sigma(pcM) = \text{normal equation in } z;$

and so on for any additional unknown quantities. Collecting the several normal equations together, we have

$$\begin{aligned} \Sigma(pa^2)x + \Sigma(pab)y + \Sigma(pac)z \dots &= \Sigma(paM); \\ \Sigma(pab)x + \Sigma(pb^2)y + \Sigma(pbc)z \dots &= \Sigma(pbM); \\ \Sigma(pac)x + \Sigma(pbc)y + \Sigma(pc^2)z \dots &= \Sigma(pcM); \\ \text{etc.,} & \qquad \qquad \text{etc.} \end{aligned}$$

An examination of these equations shows that the coefficients in the first row and in the first column are identical in sign, value, and order. The same proposition is true of the second row and second column, the third row and third column, and so on. This is hence the general law of the coefficients in any set of normal equations, and furnishes a check on the work that should never be neglected.

Example. Let the following observation equations be given:

$$\begin{aligned} 2x - z &= 8.71 \text{ (weight 2),} \\ x - 2y + 3z &= 2.16 \text{ (weight 1),} \\ y - 2z &= 1.07 \text{ (weight 2),} \\ x - 3y &= 1.93 \text{ (weight 1).} \end{aligned}$$

The corresponding normal equations are

$$\begin{aligned} 10x - 5y - z &= 38.93 = \text{normal equation in } x; \\ - 5x + 15y - 10z &= - 7.97 = \text{normal equation in } y; \\ - x - 10y + 19z &= - 15.22 = \text{normal equation in } z; \end{aligned}$$

from which we have

$$\begin{aligned} \text{Coefficients in } \left\{ \begin{array}{l} \text{First row are} \quad + 10, - 5, - 1. \\ \text{First column are} \quad + 10, - 5, - 1. \end{array} \right. \\ \text{Coefficients in } \left\{ \begin{array}{l} \text{Second row are} \quad - 5, + 15, - 10. \\ \text{Second column are} \quad - 5, + 15, - 10. \end{array} \right. \\ \text{Coefficients in } \left\{ \begin{array}{l} \text{Third row are} \quad - 1, - 10, + 19. \\ \text{Third column are} \quad - 1, - 10, + 19. \end{array} \right. \end{aligned}$$

163. Reduced Observation Equations. Such observation equations as are likely to occur in geodetic work may be written under the general form

$$ax + by + cz + \text{etc.} = M. \quad . \quad . \quad . \quad . \quad (37)$$

Substituting

$$\left. \begin{aligned} x &= x_1 + v_1 \\ y &= y_1 + v_2 \\ z &= z_1 + v_3 \\ . & . . . \end{aligned} \right\}, \quad . \quad . \quad . \quad . \quad . \quad (38)$$

in which $x_1, y_1, z_1, \text{etc.}$, are any assumed constants, and $v_1, v_2, v_3, \text{etc.}$, are new unknowns, the equation takes the reduced form

$$av_1 + bv_2 + cv_3 + \text{etc.} = M - (ax_1 + by_1 + cz_1 + \text{etc.}). \quad (39)$$

In this new equation it will be noticed that the first member is identical in form with the first member of the original equation, the only change being the substitution of the new variables for the old ones; and that the second member is what the original equation reduces to when the assumed constants are substituted for the corresponding variables. The reduced observation Eq. (39) may therefore be written out at once from the observa-

tion Eq. (37), without going through the direct substitution of Eqs. (38). Particular attention is called to the second member of Eq. (39), in which it is seen that the result due in any case to the use of the assumed values of x , y , etc., must always be subtracted from the corresponding measured value, and not vice versa, as any error in sign will render the whole computation worthless. It is also to be noted that the original weights apply also to the reduced observation equations, since these are simply different expressions for the original equations.

In view of the meaning of the terms in Eqs. (38) it is evident that the most probable value of x is that which is due to the most probable value of v_1 , and correspondingly with all the other unknowns. We may, therefore, in any case, reduce all the original observation equations to the form of Eq. (39), determine from these reduced equations the most probable values of v_1 , v_2 , etc., and then by means of Eqs. (38) determine the most probable values of x , y , z , etc. The object of this method of computation is to save labor by keeping all the work in small numbers. This result is accomplished by assigning to x_1 , y_1 , etc., values which are known to be approximately equal to x , y , etc., as this will evidently reduce the second term of equations like Eq. (39) to values approximating zero. Approximate values of the unknowns are always obtainable from an inspection of the observation equations, or by obvious combinations thereof.

Example 1. Given the following observation equations:

$$\begin{aligned}x &= 178.651, \\y &= 204.196, \\x + y &= 382.859, \\2x + y &= 561.522;\end{aligned}$$

to find the most probable values of the unknowns by the method of reduced observation equations.

Assuming for the most probable values

$$\begin{aligned}x &= 178.651 + v_1, \\y &= 204.196 + v_2,\end{aligned}$$

we have by substitution in the observation equations, or directly in accordance with Eq. (39),

$$\begin{aligned}v_1 &= 0.000; \\v_2 &= 0.000; \\v_1 + v_2 &= 0.012; \\2v_1 + v_2 &= 0.024.\end{aligned}$$

Forming the normal equations from these reduced observation equations, we have

$$\begin{aligned} 6v_1 + 3v_2 &= 0.060; \\ 3v_1 + 3v_2 &= 0.036; \end{aligned}$$

whose solution gives

$$v_1 = 0.008 \quad \text{and} \quad v_2 = 0.004;$$

whence for the most probable values of x and y we have

$$\begin{aligned} x &= 178.651 + 0.008 = 178.659; \\ y &= 204.196 + 0.004 = 204.200. \end{aligned}$$

These results are identical with what would have been obtained if any other values had been used for x_1 and y_1 , or if the normal equations had been formed directly from the original observation equations.

Example 2. Given the following observation equations:

$$\begin{aligned} 2x + y &= 116^\circ 38' 19''.7 \text{ (weight 2),} \\ x + y &= 73 17 22 .1 \text{ (weight 1),} \\ x - y &= 13 24 28 .3 \text{ (weight 3),} \\ x + 2y &= 103 13 47 .7 \text{ (weight 1);} \end{aligned}$$

to find the most probable values of the unknowns by the method of reduced observation equations.

It is readily seen that the first two of these equations are exactly satisfied if we write

$$\begin{aligned} x &= 43^\circ 20' 57''.6; \\ y &= 29 56 24 .5. \end{aligned}$$

Adopting these as the approximate values we have for the most probable values

$$\begin{aligned} x &= 43^\circ 20' 57''.6 + v_1; \\ y &= 29 56 24 .5 + v_2; \end{aligned}$$

whence by substitution in the observation equations, or directly in accordance with Eq. (39), we have

$$\begin{aligned} 2v_1 + v_2 &= 0''.0 \text{ (weight 2);} \\ v_1 + v_2 &= 0 .0 \text{ (weight 1);} \\ v_1 - v_2 &= -4 .8 \text{ (weight 3);} \\ v_1 + 2v_2 &= 1 .1 \text{ (weight 1).} \end{aligned}$$

Forming the normal equations from these reduced observation equations, we have

$$\begin{aligned} 13v_1 + 4v_2 &= -13''.3; \\ 4v_1 + 10v_2 &= 16 .6; \end{aligned}$$

whose solution gives

$$v_1 = -1''.75 \quad \text{and} \quad v_2 = +2''.36;$$

whence for the most probable values of x and y we have

$$\begin{aligned} x &= (43^\circ 20' 57''.6) - 1''.75 = 43^\circ 20' 55''.85; \\ y &= (29 56 24 .5) + 2 .36 = 29 56 26 .86. \end{aligned}$$

As in the previous example these results are identical with what would have been obtained if any other values had been used for x_1 and y_1 , or if the normal equations had been formed directly from the original observation equations.

CHAPTER XII

MOST PROBABLE VALUES OF CONDITIONED AND COMPUTED QUANTITIES

164. Conditional Equations. The methods heretofore given determine the most probable values in all cases where the quantities observed are independent of each other. In many cases, however, certain rigorous conditions must also be satisfied, so that any change in one quantity demands an equivalent change in one or more other quantities. Thus in a triangle the three angles can not have independent values, but only such values as will add up to exactly 180° . When quantities are thus dependent on each other they are called *conditioned quantities*. By an *equation of condition* or a *conditional equation* is meant an equation which expresses a relation that must exist among dependent quantities. Thus if x , y , and z denote the three angles of a triangle we have the corresponding conditional equation

$$x + y + z = 180^\circ.$$

In such a case the most probable values of x , y , and z are not those values which may be *individually* the most probable, but those values which belong to the most probable *set* of values that will satisfy the given conditional equation. In accordance with the principles heretofore established that *set* of values is the most probable which leads to a minimum value for the sum of the weighted squares of the resulting residuals in the observation equations.

In the problems which occur in geodetic work the conditional equations may in general be expressed in the form

$$\left. \begin{aligned} a_1x + a_2y \dots + a_ut &= E_a \\ b_1x + b_2y \dots + b_ut &= E_b \\ \dots &\dots \\ m_1x + m_2y \dots + m_ut &= E_m \end{aligned} \right\}, \dots (40)$$

in which x, y, t , etc., are the most probable values of the unknown quantities, and u is the number of such quantities. It is evident that the number of *independent* conditional equations must be less than the number of unknown quantities. For if these equations are equal in number with the unknown quantities their solution as simultaneous equations will determine absolute values for the unknowns, so that such quantities can not be the subject of measurement. While if the number of these equations exceeds the number of unknowns, such equations can not all be independent without some of them being inconsistent. On the other hand the *total* number of equations (sum of the observation and the independent conditional equations) must *exceed* the number of unknown quantities. For if the total number of equations is equal to the number of unknown quantities, their solution as simultaneous equations will furnish a set of values which will exactly satisfy all the equations, without involving any question of what values may be the most probable. While if the total number of equations is less than the number of unknown quantities the problem becomes indeterminate.

There are in general two methods of finding the most probable values of the unknown quantities in cases involving conditioned quantities. In the first method the *conditional* equations are avoided (or eliminated) by impressing their significance on the observation equations, which reduces the problem to the cases previously given. In the second method the *observation* equations are eliminated by impressing their significance on the conditional equations, when the solution may be effected by the method of correlatives (Art. 167). The first method is the most direct in elementary problems, but the second method greatly reduces the work of computation in the case of complicated problems.

165. Avoidance of Conditional Equations. In a large number of problems it is possible to avoid the use of conditional equations by the manner in which the observation equations are expressed. The conditions which have to be satisfied in any given case are never alone sufficient to determine the values of any of the unknown quantities, as otherwise these quantities would not be the subject of observation. It is only after definite values have been assigned to some of the unknown quantities that the conditional equations limit the values of the remaining

ones. In any problem, therefore, a certain number of values may be regarded as independent of the conditional equations, whence the remaining values become dependent on the independent ones. Thus in a triangle any two of the angles may be regarded as independent, whence the remaining one becomes dependent on these two, since the total sum must be 180° . In any elementary problem it is generally self evident as to how many quantities must be regarded as independent, and which ones may be so taken. In such cases the conditional equations may be avoided by writing out all of the observation equations in terms of the independent quantities. The most probable values of these quantities may then be found by the regular rules for independent quantities, whence the most probable values of the remaining quantities are determined by the surrounding conditions that must be satisfied.

Example 1. Referring to Fig. 65, the following angular measurements have been made:

$$\begin{aligned}x &= 28^\circ 11' 52''.2; \\y &= 30 \quad 42 \quad 22 \quad .7; \\z &= 58 \quad 54 \quad 17 \quad .6.\end{aligned}$$

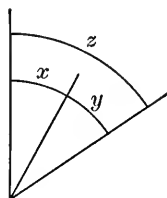

FIG. 65.

What are the most probable values of these angles?

It is evident from the figure that these angles are subject to the condition

$$x + y = z.$$

If, however, we write the observation equations in the form

$$\begin{aligned}x &= 28^\circ 11' 52''.2; \\y &= 30 \quad 42 \quad 22 \quad .7; \\x + y &= 58 \quad 54 \quad 17 \quad .6;\end{aligned}$$

the conditional equation is avoided, since x and y are manifestly independent angles. The second set of observation equations must lead to exactly the same figures for the most probable values of x and y (and hence for z) as the first set, since it is only another way of stating exactly the same thing. Since x and y are independent angles we may write for the most probable values

$$\begin{aligned}x &= 28^\circ 11' 52''.2 + v_1; \\y &= 30 \quad 42 \quad 22 \quad .7 + v_2;\end{aligned}$$

whence the reduced observation equations are

$$\begin{aligned}v_1 &= 0''.0; \\v_2 &= 0 \quad .0; \\v_1 + v_2 &= 2 \quad .7.\end{aligned}$$

The corresponding normal equations are

$$\begin{aligned} 2v_1 + v_2 &= 2''.7; \\ v_1 + 2v_2 &= 2''.7; \end{aligned}$$

whose solution gives

$$v_1 = +0''.9 \quad \text{and} \quad v_2 = +0''.9.$$

The most probable values of the given angles are therefore

$$\begin{aligned} x &= 28^\circ 11' 53''.1; \\ y &= 30 \quad 42 \quad 23 \quad .6; \\ z &= 58 \quad 54 \quad 16 \quad .7. \end{aligned}$$

Example 2. Referring to Fig. 66, the following angular measurements have been made:

$$\begin{aligned} x &= 80^\circ 45' 37''.6 \text{ (weight 2);} \\ y &= 135 \quad 08 \quad 14 \quad .9 \text{ (weight 1);} \\ z &= 144 \quad 06 \quad 10 \quad .8 \text{ (weight 3).} \end{aligned}$$

What are the most probable values of these angles?

It is evident from the figure that these angles are subject to the condition

$$x + y + z = 360^\circ.$$

Any two angles at a point, such as x and y , may be regarded as independent, so that the conditional equation is avoided by writing all the observation equations in terms of these two quantities. Thus we write:

$$\begin{aligned} x &= 80^\circ 45' 37''.6 \text{ (weight 2);} \\ y &= 135 \quad 08 \quad 14 \quad .9 \text{ (weight 1);} \\ 360^\circ - (x + y) &= 144 \quad 06 \quad 10 \quad .8 \text{ (weight 3);} \end{aligned}$$

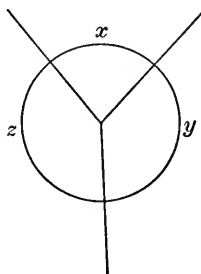

FIG. 66.

whence by substituting

$$\begin{aligned} x &= 80^\circ 45' 37''.6 + v_1, \\ y &= 135 \quad 08 \quad 14 \quad .9 + v_2, \end{aligned}$$

we have

$$\begin{aligned} v_1 &= 0''.0 \text{ (weight 2);} \\ v_2 &= 0 \quad .0 \text{ (weight 1);} \\ v_1 + v_2 &= -3 \quad .3 \text{ (weight 3);} \end{aligned}$$

from which the normal equations are

$$\begin{aligned} 5v_1 + 3v_2 &= -9''.9; \\ 3v_1 + 4v_2 &= -9 \quad .9; \end{aligned}$$

whose solution gives

$$v_1 = -0''.9 \quad \text{and} \quad v_2 = -1''.8.$$

The most probable values of the given angles are therefore

$$\begin{aligned} x &= 80^\circ 45' 36''.7; \\ y &= 135 \quad 08 \quad 13 \quad .1; \\ z &= 144 \quad 06 \quad 10 \quad .2. \end{aligned}$$

166. Elimination of Conditional Equations. If the conditional equations can not be directly avoided, as in the preceding article, the same result may be indirectly accomplished by algebraic elimination, as about to be explained. The number of unknown quantities (Art. 164) necessarily exceeds the number of independent conditional equations. The number of dependent unknowns, however, can not exceed the number of independent conditional equations, since any values whatever may be assigned to the remaining unknowns and still leave the equations capable of solution. Thus if there are five unknowns and three independent conditional equations, any values may be assigned to any two of the unknowns, leaving three equations with three unknowns and hence capable of solution. The unknowns selected as arbitrary values thus become independent quantities on which all the others must depend, and the number of unknowns which may be thus selected as independent quantities is evidently equal to the difference between the total number of unknowns and the number of independent conditional equations. If the most probable values are assigned to the independent quantities, the most probable values of the dependent quantities then become known by substituting the values of the independent quantities in the dependent equations. The general plan of procedure is as follows:

1. Determine the number of independent unknowns by subtracting the number of conditional equations from the number of unknown quantities.
2. Select this number of unknowns as independent quantities.
3. Transpose the conditional equations so that the dependent quantities are all on the left-hand side and the independent quantities on the right-hand side.
4. Solve the conditional equations for the dependent unknowns, which will thus express each of these dependent unknowns in terms of the independent unknowns.
5. Substitute these values of the dependent unknowns in the observation equations, which will then contain nothing but independent unknowns.
6. Find the most probable values of the independent unknowns from these modified observation equations by the regular rules for independent quantities.
7. Substitute these values of the independent unknowns in

the expressions for the dependent unknowns, and thus determine the most probable values of the remaining quantities.

Example. Given the following data, to find the most probable values of x , y , and z :

$$\begin{aligned} \text{Observation equations} & \begin{cases} x = 17.82 \text{ (weight 2);} \\ y = 15.11 \text{ (weight 4);} \\ z = 29.16 \text{ (weight 3).} \end{cases} \\ \text{Conditional equations} & \begin{cases} 2x + 5y = 112.00; \\ 3x + y - z = 39.00. \end{cases} \end{aligned}$$

The solution is as follows:

$$\begin{aligned} \text{Number of unknown quantities} & = 3. \\ \text{Number of conditional equations} & = 2. \\ \hline \text{Number of independent quantities} & = 1. \end{aligned}$$

Let x be the independent quantity, and y and z the dependent quantities. Transpose the conditional equations so as to leave only the dependent quantities on the left hand side, thus:

$$\begin{aligned} 5y & = 112.00 - 2x; \\ y - z & = 39.00 - 3x. \end{aligned}$$

Solve for the dependent quantities, giving the dependent equations

$$\begin{aligned} y & = 22.40 - 0.4x; \\ z & = -16.60 + 2.6x. \end{aligned}$$

Substitute in the observation equations, giving

$$\begin{aligned} x & = 17.82 \text{ (weight 2);} \\ 22.40 - 0.4x & = 15.11 \text{ (weight 4);} \\ -16.60 + 2.6x & = 29.16 \text{ (weight 3);} \end{aligned}$$

whence

$$\begin{aligned} x & = 17.82 \text{ (weight 2);} \\ 0.4x & = 7.29 \text{ (weight 4);} \\ 2.6x & = 45.76 \text{ (weight 3);} \end{aligned}$$

in which x is an independent unknown. Forming the normal equation by multiplying the above equations respectively by 2, 1.6, and 7.8, we have

$$\begin{aligned} 2.00x & = 35.640, \\ 0.64x & = 11.664, \\ 20.28x & = 356.928 \\ \hline 22.92x & = 404.232; \\ x & = 17.637; \end{aligned}$$

which, substituted in the first dependent equation, gives,

$$y = 22.40 - 0.4(17.637) = 15.345,$$

and substituted in the second dependent equation, gives

$$z = -16.60 + 2.6(17.637) = 29.255;$$

so that for the most probable values of the unknown quantities, we have

$$x = 17.637;$$

$$y = 15.345;$$

$$z = 29.255.$$

As a check on the work of computation, we may substitute these values in the conditional equations, giving

$$\begin{aligned} 2x + 5y &= 35.274 + 76.725 &= 111.999; \\ 3x + y - z &= 52.911 + 15.345 - 29.255 &= 39.001; \end{aligned}$$

from which it is seen that each equation checks with the corresponding conditional equation within 0.001, which is an entirely satisfactory check. The essential feature of the above method is the elimination of the conditional equations. In Art. 167 the same problem is worked out by eliminating the observation equations. The results obtained are of course identical.

167. Method of Correlatives. The general method of correlatives is beyond the scope of the present volume. The case here given is the only one that is likely to be of service to the civil engineer. In this case the observations are made directly on each unknown quantity, and the number of observation equations equals the number of unknown quantities. Let u be the number of unknown quantities, for which the observation equations may be written

$$x = M_1 \quad (\text{weight } p_1);$$

$$y = M_2 \quad (\text{weight } p_2);$$

$$\cdot \quad \cdot \quad \cdot \quad \cdot \quad \cdot$$

$$t = M_u \quad (\text{weight } p_u);$$

and for which (Art. 164) the conditional equations may be written

$$\left. \begin{aligned} a_1x + a_2y \dots + a_ut &= E_a \\ b_1x + b_2y \dots + b_ut &= E_b \\ \cdot \quad \cdot \quad \cdot \quad \cdot \quad \cdot & \\ m_1x + m_2y \dots + m_ut &= E_m \end{aligned} \right\} \dots \dots \dots (41)$$

If, as heretofore, x, y, t , etc., be understood to represent the most probable values of the unknown quantities, and v_1, v_2, v_u , etc.,

represent the corresponding residuals in the given equations, we may write

$$\left. \begin{aligned} x &= M_1 + v_1 \quad (\text{weight } p_1) \\ y &= M_2 + v_2 \quad (\text{weight } p_2) \\ &\cdot \quad \cdot \quad \cdot \\ t &= M_u + v_u \quad (\text{weight } p_u) \end{aligned} \right\}; \dots \dots (42)$$

which, substituted in Eqs. (41), give the conditional equations

$$\left. \begin{aligned} a_1v_1 + a_2v_2 \dots + a_uv_u &= E_a - \Sigma aM \\ b_1v_1 + b_2v_2 \dots + b_uv_u &= E_b - \Sigma bM \\ \cdot \quad \cdot \quad \cdot \quad \cdot \quad \cdot \quad \cdot \\ m_1v_1 + m_2v_2 \dots + m_uv_u &= E_m - \Sigma mM \end{aligned} \right\} \dots \dots (43)$$

As explained in Art. 164, these conditional equations must be less in number than the number of unknown quantities. The values of v_1, v_2 , etc., thus become indeterminate, and an infinite number of sets of values will satisfy the equations. The values in any one set (called simultaneous values) are not independent, however, as they must be such as will satisfy the above equations.

If v_1, v_2 , etc., in Eqs. (43) are assumed to vary through all possible simultaneous values due to any set of values dv_1, dv_2 , etc., and all possible sets of values dv_1, dv_2 , etc., are taken in turn, the most probable set of values v_1, v_2 , etc., for the given set of observations will eventually be reached. The values dv_1, dv_2 , etc., in any one set, however, can not be independent, as it is evident that dependent quantities can not be varied independently. Differentiating Eqs. (43), we have

$$\left. \begin{aligned} a_1dv_1 + a_2dv_2 \dots + a_dv_u &= 0 \\ b_1dv_1 + b_2dv_2 \dots + b_dv_u &= 0 \\ \cdot \quad \cdot \quad \cdot \quad \cdot \quad \cdot \\ m_1dv_1 + m_2dv_2 \dots + m_dv_u &= 0 \end{aligned} \right\}; \dots \dots (44)$$

and these new equations of condition show the relations that must exist among the quantities dv_1, dv_2 , etc. Since the number of equations is less than the number of quantities dv_1, dv_2 , etc., it follows that an infinite number of sets of simultaneous values of dv_1, dv_2 , etc., is possible. In order to involve Eqs. (44) simul-

taneously in an algebraic discussion it is necessary to replace them by a single equivalent equation, meaning an equation so formed that the only values which will satisfy it are those which will individually satisfy the original equations which it replaces. This is done by writing

$$\left\{ \begin{array}{l} k_1(a_1dv_1 + a_2dv_2 \dots + a_udev_u) \\ + k_2(b_1dv_1 + b_2dv_2 \dots + b_udev_u) \\ \cdot \\ \cdot \\ + k_m(m_1dv_1 + m_2dv_2 \dots + m_udev_u) \end{array} \right\} = 0; \quad (45)$$

in which k_1, k_2 , etc., are independent constants which may have any possible values assigned to them at pleasure. Since Eq. (45) must by agreement remain true for all possible sets of values k_1, k_2 , etc., its component members must individually remain equal to zero. But these component members are identical with the first members of the original conditional equations, so that no set of values dv_1, dv_2 , etc., can satisfy Eq. (45) unless it can also satisfy each of Eqs. (44). The values in any such set are called simultaneous values.

In order to determine the most probable values of v_1, v_2 , etc., we must have (Art. 156)

$$p_1v_1^2 + p_2v_2^2 \dots + p_udev_u^2 = \text{a minimum.}$$

In accordance with the principles of the calculus *for the case of dependent quantities* the first derivative of this expression must equal zero for every possible set of values dv_1, dv_2 , etc. Hence, by differentiating, and omitting the factor 2, we have

$$p_1v_1dv_1 + p_2v_2dv_2 \dots + p_udev_udev_u = 0, \dots \quad (46)$$

in which dv_1, dv_2 , etc., must be simultaneous values. Since these values are also simultaneous in Eq. (45), we may combine this equation with Eq. (46) and write

$$p_1v_1dv_1 + p_2v_2dv_2 \dots + p_udev_udev_u = \left\{ \begin{array}{l} k_1(a_1dv_1 + a_2dv_2 \dots + a_udev_u) \\ + k_2(b_1dv_1 + b_2dv_2 \dots + b_udev_u) \\ \cdot \\ \cdot \\ + k_m(m_1dv_1 + m_2dv_2 \dots + m_udev_u) \end{array} \right\};$$

whence, by rearranging the terms, we have

$$\left\{ \begin{array}{l} [p_1v_1 - (k_1a_1 + k_2b_1 \dots + k_m m_1)]dv_1 \\ + [p_2v_2 - (k_1a_2 + k_2b_2 \dots + k_m m_2)]dv_2 \\ \cdot \quad \cdot \quad \cdot \quad \cdot \quad \cdot \quad \cdot \\ + [p_uv_u - (k_1a_u + k_2b_u \dots + k_m m_u)]dv_u \end{array} \right\} = 0. \quad (47)$$

Since $k_1, k_2, \text{ etc.}$, are independent and arbitrary constants, it is evident that this equation can not be true unless its component members are each equal to zero, so that

$$\begin{array}{l} [p_1v_1 - (k_1a_1 + k_2b_1 \dots + k_m m_1)]dv_1 = 0; \\ \text{etc.,} \qquad \qquad \qquad \text{etc.;} \end{array}$$

from which we have

$$\left. \begin{array}{l} p_1v_1 = k_1a_1 + k_2b_1 \dots + k_m m_1 \\ p_2v_2 = k_1a_2 + k_2b_2 \dots + k_m m_2 \\ \cdot \quad \cdot \quad \cdot \quad \cdot \quad \cdot \quad \cdot \\ p_uv_u = k_1a_u + k_2b_u \dots + k_m m_u \end{array} \right\}, \dots (48)$$

as the general equations of condition for the most probable values of $v_1, v_2, \text{ etc.}$

It is evident that Eqs. (48) can not be solved for $v_1, v_2, \text{ etc.}$, until definite values have been assigned to $k_1, k_2, \text{ etc.}$ In the general discussion of the problem the values of $k_1, k_2, \text{ etc.}$, have been entirely arbitrary, since the numerical requirements of Eqs. (43) vanished in the differentiation. In any particular case, however, the m conditional Eqs. (43) must be numerically satisfied in order to satisfy the rigid geometrical conditions of the case, while the u conditional Eqs. (48) must be satisfied in order to have the most probable values for $v_1, v_2, \text{ etc.}$ There are thus $m + u$ simultaneous equations to be satisfied. But there are also $m + u$ unknown quantities, since the m unknown quantities $k_1, k_2, \text{ etc.}$, corresponding to the m conditional Eqs. (43), have been added to the u unknown quantities $v_1, v_2, \text{ etc.}$ In any particular case, therefore, there is but one set of values for the m unknown quantities $k_1, k_2, \text{ etc.}$, and the u unknown quantities $v_1, v_2, \text{ etc.}$, that will satisfy the $m + u$ equations consisting of Eqs. (43) and (48). The auxiliary quantities $k_1, k_2, \text{ etc.}$, are called the *correlatives*

in which x, y, t , etc., are the most probable values of the quantities whose observed values were M_1, M_2, M_u , etc.

Example. Given the following data, to find the most probable values of x, y , and z :

$$\begin{aligned} \text{Observation equations } & \begin{cases} x = 17.82 & (\text{weight } 2); \\ y = 15.11 & (\text{weight } 4); \\ z = 29.16 & (\text{weight } 3). \end{cases} \\ \text{Conditional equations } & \begin{cases} 2x + 5y & = 112.00; \\ 3x + y - z & = 39.00. \end{cases} \end{aligned}$$

In this case we have

$$\begin{array}{rcl} E_a & = & 112.00 \\ \Sigma aM & = & 111.19 \\ \hline E_a - \Sigma aM & = & 0.81 \end{array} \qquad \begin{array}{rcl} E_b & = & 39.00 \\ \Sigma bM & = & 39.41 \\ \hline E_b - \Sigma bM & = & -0.41 \end{array}$$

$$\begin{array}{rcl} M_1 = 17.82 & a_1 = 2 & b_1 = 3 & p_1 = 2 \\ M_2 = 15.11 & a_2 = 5 & b_2 = 1 & p_2 = 4 \\ M_3 = 29.16 & a_3 = 0 & b_3 = -1 & p_3 = 3 \end{array}$$

$$\Sigma \frac{a^2}{p} = \frac{33}{4} \qquad \frac{a_1}{p_1} = 1 \qquad \frac{b_1}{p_1} = \frac{3}{2}$$

$$\Sigma \frac{ab}{p} = \frac{17}{4} \qquad \frac{a_2}{p_2} = \frac{5}{4} \qquad \frac{b_2}{p_2} = \frac{1}{4}$$

$$\Sigma \frac{b^2}{p} = \frac{61}{12} \qquad \frac{a_3}{p_3} = 0 \qquad \frac{b_3}{p_3} = -\frac{1}{3}$$

$$\left. \begin{array}{l} \frac{33}{4}k_1 + \frac{17}{4}k_2 = 0.81 \\ \frac{17}{4}k_1 + \frac{61}{12}k_2 = -0.41 \end{array} \right\} \text{giving } \begin{cases} k_1 = +0.2454. \\ k_2 = -0.2859. \end{cases}$$

We thus have

$$\begin{aligned} v_1 &= 0.2454 \times 1 - 0.2859 \times \frac{3}{2} = -0.183; \\ v_2 &= 0.2454 \times \frac{5}{4} - 0.2859 \times \frac{1}{4} = +0.235; \\ v_3 &= 0.2454 \times 0 + 0.2859 \times \frac{1}{3} = +0.095; \end{aligned}$$

whence, for the most probable values of x, y , and z , we have

$$\begin{aligned} x &= M_1 + v_1 = 17.82 - 0.183 = 17.637; \\ y &= M_2 + v_2 = 15.11 + 0.235 = 15.345; \\ z &= M_3 + v_3 = 29.16 + 0.095 = 29.255. \end{aligned}$$

As a check on the work of computation we may substitute these values in the conditional equations, giving

$$\begin{aligned} 2x + 5y &= 35.274 + 76.725 &= 111.999; \\ 3x + y - z &= 52.911 + 15.345 - 29.255 &= 39.001; \end{aligned}$$

from which it is seen that each equation checks with the corresponding conditional equation within 0.001, which is an entirely satisfactory check. The

essential feature of the above method is the elimination of the observation equations. In Art. 166 the same problem is worked out by eliminating the conditional equations. The results obtained are of course identical.

168. Most Probable Values of Computed Quantities. By a *computed quantity* is meant a value derived from one or more observed quantities by means of some geometric or analytic relation. The most probable values of computed quantities are found from the most probable values of the observed quantities by employing the same rules that are used with mathematically exact quantities. Thus the most probable value of the area of a rectangle is that which is given by the product of the most probable values of its base and altitude; the most probable value of the circumference of a circle is equal to π times the most probable value of its diameter; and so on.

CHAPTER XIII

PROBABLE ERRORS OF OBSERVED AND COMPUTED QUANTITIES

A. OF OBSERVED QUANTITIES

169. General Considerations. The most probable value of a quantity does not in itself convey any idea of the precision of the determination, nor of the favorable or unfavorable circumstances surrounding the individual measurements. Any single measurement tends to lie closer to the truth the finer the instrument and the method used, the greater the skill of the observer, the better the atmospheric conditions, etc. The accidental errors of observation tend to be more thoroughly eliminated from the average value of a series of measurements the greater the number of measurements which are averaged together. Some criterion or standard of judgment is therefore necessary as a gage of precision. Since the probability curve for any particular case shows the facility of error in that case, and thus represents all the surrounding circumstances under which the given observations were taken, it is evident that some suitable function of the probability curve must be adopted as an indication of the precision of the results obtained. The function which is commonly adopted as the gage of precision is called the *probable error*.

170. Fundamental Meaning of the Probable Error. By the *probable error* of a quantity is meant an error of such a magnitude that errors of either greater or lesser numerical value are equally likely to occur under the same circumstances of observation. Or, in other words, in any extended series of observations the probability is that the number of errors numerically greater than the probable error will equal the number of errors numerically less than the probable error. The probable error of a single observation thus becomes the critical value that the numerical error of any single observation is equally likely to exceed or fall short of. Similarly the probable error of the arithmetic mean

becomes the critical value that the numerical error of any identically obtained arithmetic mean is equally likely to exceed or fall short of. Thus if the probable error of any angular measurement is said to be five seconds, the meaning is that the probability of the error lying between the limits of minus five seconds and plus five seconds equals the probability of its lying outside of these limits. The probable error is always written after a measured quantity with the plus and minus sign. Thus if an angular measurement is written

$$72^{\circ} 10' 15''.8 \pm 1''.3,$$

it indicates that $1''.3$ is the probable error of the given determination. The probable error of a quantity can not be a positive quantity only, or a negative quantity only, but always requires both signs. It is important to note that the probable error is an altogether different thing from the *most* probable error. Since errors of decreasing magnitude occur with increasing frequency, the most probable error in any case is always zero.

171. Graphical Representation of the Probable Error. The probability that an error will fall between any two given limits (Art. 147) is equal to the area included between the corresponding ordinates of the probability curve. The probability that an error will fall *outside* of any two given limits must hence be equal to the sum of the areas outside of these limits. If these two probabilities are equal, therefore, each such probability must be represented by one-half of the total area. The probable error thus becomes that error (plus and minus) whose two ordinates include one-half the area of the probability curve. Referring to Fig. 67, the solid curve corresponds to a series of observations taken under a certain set of conditions, and the dotted curve to a series of observations taken under more favorable conditions. The ordinates y_1, y_1 , correspond to the probable error r_1 of an observation of unit weight taken under the conditions producing the solid probability curve, and include between themselves one-half of the area of that curve. The ordinates y', y' , correspond to the probable error r' of an observation of unit weight taken under the conditions producing the dotted probability curve, and include between themselves one-half of the area of the dotted curve. The area for any probability curve (Art. 150) being always equal to unity, it follows that y_1, y_1 ,

and y', y' , include equal areas. Hence as the center ordinate at A grows higher and higher with increasing accuracy of observation, so also must the ordinates y_1, y_1 , draw closer together. It is thus seen that the probable error r_1 grows smaller and smaller as the accuracy of the work increases, and therefore furnishes a satisfactory gage of precision.

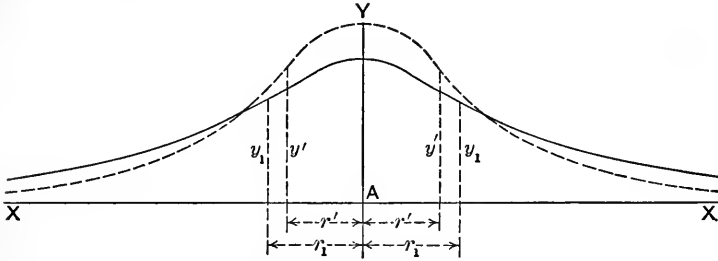

FIG. 67.—The Probable Error.

172. General Value of the Probable Error. The area of any probability curve (Art. 150) equals unity. The area between any probable error ordinates y_1, y_1 (Art. 171), is equal to half the area of the corresponding probability curve. But the area between the ordinates y_1, y_1 (Art. 147), is equal to the probability that an error will fall between the values $x = -r_1$ and $x = +r_1$. Hence from Eq. (16) we have

$$P = \frac{1}{2} = \frac{h}{\sqrt{\pi}} \int_{-r_1}^{r_1} e^{-h^2x^2} dx. \dots \dots (52)$$

Since (Art. 150) the precision of any set of observations depends entirely on the value of h , it follows that the probable error r_1 must be some function of h . The last member of Eq. (52) is not directly integrable, so that the numerical relation of the quantities h and r_1 can only be found by an indirect method of successive approximation which is beyond the scope of this volume. As the result of such a discussion we have,

$$r_1 = \frac{0.4769363 \dots \dots \dots}{h} \dots \dots \dots (53)$$

It is thus seen that for different grades of work the probable error r_1 varies inversely as the precision factor h .

By more or less similar processes of reasoning it is also established that the probable error of any quantity or observation varies inversely as the square root of its weight. Thus if r_1 is the probable error of an observation of unit weight, then for the probable error r_p of any value with the weight p , we have

$$r_p = \frac{r_1}{\sqrt{p}} \dots \dots \dots (54)$$

173. Direct Observations of Equal Weight. From Eq. (20) we have

$$h = \sqrt{\frac{n-1}{2\Sigma v^2}}$$

Substituting this value of h in Eq. (53) and reducing, we have

$$r_1 = 0.6745 \sqrt{\frac{\Sigma v^2}{n-1}}, \dots \dots \dots (55)$$

in which r_1 is the probable error of a single observation in the case of direct observations of equal weight on a single unknown quantity, and n is the number of observations.

Since in this case (Art. 134) the weight of the arithmetic mean is equal to the number of observations, we have (Art. 172),

$$r_a = \frac{r_1}{\sqrt{n}} = 0.6745 \sqrt{\frac{\Sigma v^2}{n(n-1)}}, \dots \dots (56)$$

in which r_a is the probable error of the arithmetic mean in the case of direct observations of equal weight on a single unknown quantity, and n is the number of observations.

Example. Direct observations on an angle A :

Observed values	v	v^2
29° 21' 59".1	- 2".1	4.41
29 22 06 .4	+ 5 .2	27.04
29 21 58 .1	- 3 .1	9.61
<hr style="width: 100%; border: 0.5px solid black;"/> 3)88 06 03 .6		<hr style="width: 100%; border: 0.5px solid black;"/> $\Sigma v^2 = 41.06$
$z = 29 \ 22 \ 01 \ .2$		$n = 3$

The probable error of a single observation is therefore

$$r_1 = 0.6745 \sqrt{\frac{\Sigma v^2}{n-1}} = 0.6745 \sqrt{\frac{41.06}{2}} = \pm 3''.06;$$

and of the arithmetic mean,

$$r_a = \frac{r_1}{\sqrt{n}} = \frac{3.06}{\sqrt{3}} = \pm 1''.76;$$

whence we have

$$\text{Most probable value of } A = 29^\circ 22' 01''.2 \pm 1''.76.$$

174. Direct Observations of Unequal Weight. From Eq. (21) we have

$$h = \sqrt{\frac{n-1}{2 \sum p v^2}}.$$

Substituting this value of h in Eq. (53) and reducing, we have

$$r_1 = 0.6745 \sqrt{\frac{\sum p v^2}{n-1}}, \dots \dots \dots (57)$$

in which r_1 is the probable error of an *observation of unit weight* in the case of direct observations of *unequal weight* on a single unknown quantity, and n is the number of observations. The value of r_1 thus becomes purely a standard of reference, and it is entirely immaterial whether or not any one of the observations has been assigned a unit weight. Having found the value of r_1 we have, from Eq. (54),

$$r_p = \frac{r_1}{\sqrt{p}},$$

in which r_p is the probable error of any observation whose weight is p .

Since in the case of weighted observations (Art. 134) the weight of the weighted arithmetic mean is equal to the sum of the individual weights, we have (Art. 172),

$$r_{pa} = \frac{r_1}{\sqrt{\sum p}} = 0.6745 \sqrt{\frac{\sum p v^2}{\sum p (n-1)}}, \dots \dots (58)$$

in which r_{pa} is the probable error of the weighted arithmetic mean in the case of direct observations of unequal weight on a single unknown quantity.

Example. Direct base-line measurements of unequal weight:

Observed values	p	pM	v	v^2	pv^2
4863.241 ft.	2	9726.482	0.020	0.000400	0.000800
4863.182 ft.	1	4863.182	- 0.039	0.001521	0.001521
	$\Sigma p = 3 \mid 14589.664$			$\Sigma pv^2 = 0.002321$	
	$z = 4863.221$ ft.		$n = 2.$		

The probable error of an observation of unit weight is therefore

$$r_1 = 0.6745 \sqrt{\frac{\Sigma pv^2}{n-1}} = 0.6745 \sqrt{\frac{0.002321}{1}} = \pm 0.032 \text{ ft.};$$

of an observation of the weight 2,

$$r_2 = \frac{r_1}{\sqrt{p}} = \frac{0.032}{\sqrt{2}} = \pm 0.023 \text{ ft.};$$

and of the weighted arithmetic mean,

$$r_{pa} = \frac{r_1}{\sqrt{\Sigma p}} = \frac{0.032}{\sqrt{3}} = \pm 0.019 \text{ ft.};$$

whence we have

$$\text{Most probable value} = 4861.221 \pm 0.019 \text{ ft.}$$

175. Indirect Observations on Independent Quantities. From Eq. (22) we have

$$h = \sqrt{\frac{n-q}{2\Sigma pv^2}}$$

Substituting this value of h in Eq. (53) and reducing, we have

$$r_1 = 0.6745 \sqrt{\frac{\Sigma pv^2}{n-q}}, \dots \dots \dots (59)$$

in which r_1 is the probable error of an observation of unit weight in the case of indirect observations on independent quantities (that is with no conditional equations), n is the number of observation equations, and q is the number of unknown quantities. Having found the value of r_1 , we have, from Art. 172,

$$r_p = \frac{r_1}{\sqrt{p}}, \quad r_x = \frac{r_1}{\sqrt{p_x}}, \quad r_y = \frac{r_1}{\sqrt{p_y}}, \text{ etc.,}$$

in which r_p is the probable error of any observation whose weight is p , and r_x is the probable error of any unknown, x , in terms of its weight p_x , and so on.

The weights p_x, p_y , etc., of the unknown quantities are found from the normal equations by means of the following

RULE: *In solving the normal equations preserve the absolute terms in literal form; then the weight of any unknown quantity is contained in the expression for that quantity, and is the reciprocal of the coefficient of the absolute term which belonged to the normal equation for that unknown quantity.*

In applying the above rule *no change whatever* is to be made in the original form of any normal equation until the absolute term has been replaced by a literal term. If the normal equations are correctly solved the coefficients in the literal expressions for the unknown quantities will follow the same law (Art. 162) as the coefficients of normal equations, and this check must never be neglected.

Example. Given the following observation equations to determine the most probable values and the probable errors of the unknown quantities:

$$\begin{aligned} x + y &= 10.90 \text{ (weight 3);} \\ 2x - y &= 1.61 \text{ (weight 1);} \\ x + 3y &= 24.49 \text{ (weight 2).} \end{aligned}$$

Forming the normal equations, we have

$$\begin{aligned} 9x + 7y &= 84.90 = N_x = \text{normal equation in } x; \\ 7x + 22y &= 178.03 = N_y = \text{normal equation in } y; \end{aligned}$$

whence

$$\begin{aligned} x &= \frac{22}{146}N_x - \frac{7}{146}N_y = 4.172, \text{ nearly;} \\ y &= -\frac{7}{146}N_x + \frac{9}{146}N_y = 6.765, \text{ nearly;} \end{aligned}$$

and, by the rule,

$$\begin{aligned} \text{Weight of } x &= \frac{146}{22} = 6.773, \text{ nearly} = p_x; \\ \text{'' } y &= \frac{146}{9} = 16.556 \text{ ''} = p_y. \end{aligned}$$

Substituting in the original equations the values obtained for x and y , there results

$$\begin{aligned} x + y &= 10.937; \\ 2x - y &= 1.579; \\ x + 3y &= 24.467; \end{aligned}$$

whence, for the residuals, we have,

$$\begin{aligned} v_1 &= 10.90 - 10.937 = -0.037 \text{ (weight 3);} \\ v_2 &= 1.61 - 1.579 = +0.031 \text{ (weight 1);} \\ v_3 &= 24.49 - 24.467 = +0.023 \text{ (weight 2).} \end{aligned}$$

We therefore have for the probable error of an observation of unit weight,

$$r_1 = 0.6745 \sqrt{\frac{\sum pv^2}{n - q}} = 0.6745 \sqrt{\frac{0.006126}{3 - 2}} = \pm 0.053;$$

for the probable error of x ,

$$r_x = \frac{r_1}{\sqrt{p_x}} = \frac{0.053}{\sqrt{6.773}} = \pm 0.020;$$

and for the probable error of y ,

$$r_y = \frac{r_1}{\sqrt{p_y}} = \frac{0.053}{\sqrt{16.556}} = \pm 0.013;$$

whence we write

$$x = 4.172 \pm 0.020 \quad \text{and} \quad y = 6.765 \pm 0.013.$$

176. Indirect Observations Involving Conditional Equations.

From Eq. (23) we have

$$h = \sqrt{\frac{n - q + c}{2 \sum p v^2}}.$$

Substituting this value of h in Eq. (53) and reducing, we have

$$r_1 = 0.6745 \sqrt{\frac{\sum p v^2}{n - q + c}}, \quad \dots \quad (60)$$

in which r_1 is the probable error of an observation of unit weight in the case of indirect observations involving conditional equations, n is the number of observation equations, q is the number of unknown quantities, and c is the number of conditional equations. Having found the value of r_1 , we have, from Art. 172,

$$r_p = \frac{r_1}{\sqrt{p}}, \quad r_x = \frac{r_1}{\sqrt{p_x}}, \quad r_y = \frac{r_1}{\sqrt{p_y}}, \quad \text{etc.},$$

in which, as in the previous article, r_p is the probable error of any observation whose weight is p , and r_x is the probable error of any unknown, x , in terms of its weight p_x , and so on.

In order to find the value of the weights p_x , p_y , etc., the conditional equations are first eliminated (Art. 166), and the normal equations due to the resulting observation equations are then treated by the rule of the preceding article. By repeating the process with different sets of unknowns eliminated, the weight of each unknown will eventually be determined.

177. Other Measures of Precision. The measures of precision thus far introduced are the precision factor h , and the probable error r . Two other measures of precision are sometimes used,

and are of great theoretic value. These are known as the *mean error*, and the *mean absolute error*.

By the *mean error* is meant the square root of the arithmetic mean of the squares of the true errors.

By the *mean absolute error* (often called the *mean of the errors*) is meant the arithmetic mean of the absolute values (numerical values) of the true errors.

Referring to Fig. 68, the precision factor h is equal to $\sqrt{\pi}$ times the central ordinate AY . Considering either half of the

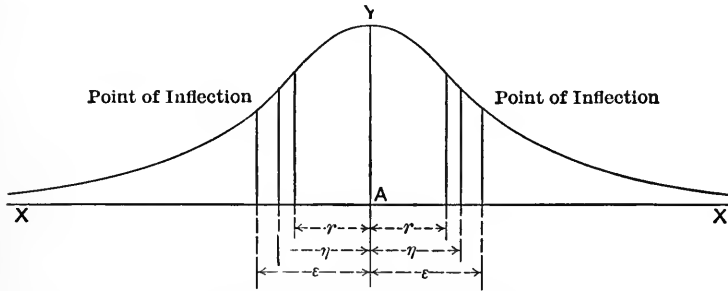

FIG. 68.—Measures of Precision.

curve alone, the ordinate for the probable error r bisects the included area, the ordinate for the mean absolute error η passes through the center of gravity, and the ordinate for the mean error ϵ passes through the center of gyration about the axis AY . The ordinate for ϵ also passes through the point of inflection of the curve.

The measure of precision most commonly used in practice is the probable error r , but as the different measures bear fixed relations to each other a knowledge of any one of them determines the value of all the others, as shown in the following summary:

$$\begin{aligned}
 \text{Precision factor} &= h. \\
 \text{Probable error} &= r = \frac{0.4769363}{h}. \\
 \text{Mean absolute error} &= \eta = \frac{1}{h\sqrt{\pi}} = 1.1829 r. \\
 \text{Mean error} &= \epsilon = \frac{1}{h\sqrt{2}} = 1.4826 r.
 \end{aligned}$$

B. OF COMPUTED QUANTITIES

178. Typical Cases. When the probable error is known for each of the quantities from which a computed quantity is derived, the probable error of the computed quantity may also be determined. Any problem which may arise will come under one or more of the five following cases:

1. *The computed quantity is the sum or difference of an observed quantity and a constant.*
2. *The computed quantity is obtained from an observed quantity by the use of a constant factor.*
3. *The computed quantity is any function of a single observed quantity.*
4. *The computed quantity is the algebraic sum of two or more independently observed quantities.*
5. *The computed quantity is any function of two or more independently observed quantities.*

The fifth case is general, and embraces all the other cases. The first four cases, however, are of such frequent occurrence that special rules are developed for them. Any combination of the rules is therefore admissible that does not violate their fundamental conditions, since the first four rules are only special cases of the fifth rule.

179. The Computed Quantity is the Sum or Difference of an Observed Quantity and a Constant.

Let u and r_u = the computed quantity and its probable error;
 x and r_x = the observed quantity and its probable error;
 a = a constant;

then

$$u = \pm x \pm a;$$

and

$$r_u = r_x. \quad \dots \dots \dots (61)$$

It is evidently immaterial whether x is directly observed or is the result of computation on one or more observed quantities. The only essential condition is satisfied if r_x is the probable error of x . If x is a computed quantity the probable error r_x may be derived by any one of the present rules.

Example. Referring to Fig. 69, the most probable value of the angle x is

$$x = 30^\circ 45' 17''.22 \pm 1''.63.$$

What is the most probable value of its supplement y , and the probable error of this value?

From the conditions of the problem we have

$$y = 180^\circ - x;$$

whence

$$r_u = r_x = \pm 1''.63,$$

and

$$y = 149^\circ 14' 42''.78 \pm 1''.63.$$

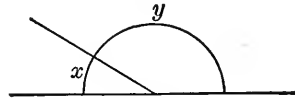

FIG. 69.

180. The Computed Quantity is Obtained from an Observed Quantity by the Use of a Constant Factor.

Let u and r_u = the computed quantity and its probable error;
 x and r_x = the observed quantity and its probable error;
 a = a constant;

then

$$u = ax$$

and

$$r_u = ar_x. \quad . \quad . \quad . \quad . \quad . \quad . \quad (62)$$

Evidently, as in the previous case, x may be any function of one or more observed quantities, provided that r_x is its correct probable error. The rule of this article is only true when the constant a represents a strictly mathematical relation, such as the relation between the diameter and the circumference of a circle. Staking out 100 feet by marking off successively this number of single feet is not such a case, as the total space staked out is not necessarily exactly 100 times any one of the single spaces as actually marked off. In all probability some of the feet will be too long and others will be too short, so that (owing to this compensating effect) the total error will be very much less than 100 times any single error, and the probable error must be found by Art. 182. In the case of the circle, however, the circumference is of necessity exactly equal in every case to π times the diameter.

Example. The radius of a circle, as measured, equals 271.16 ± 0.04 ft. What is the most probable value of the circumference, and the probable error of this value?

$$\begin{aligned} \text{Circumference} &= 271.16 \times 2\pi = 1703.75 \text{ ft.;} \\ r_u &= r_x \times 2\pi = \pm 0.04 \times 2\pi = \pm 0.25 \text{ ft.;} \end{aligned}$$

whence we write

$$\text{Circumference} = 1703.75 \pm 0.25 \text{ ft.}$$

181. The Computed Quantity is any Function of a Single Observed Quantity.

Let u and r_u = the computed quantity and its probable error;
 x and r_x = the observed quantity and its probable error;
 then

$$u = \phi(x);$$

and

$$r_u = r_x \frac{du}{dx} \dots \dots \dots (63)$$

Evidently, as in the two previous cases, x may be any function of one or more observed quantities, provided that r_x is its correct probable error.

Example. The radius x of a circle equals 42.27 ± 0.02 ft. What is the most probable value and the probable error of the area?

$$\begin{aligned} u &= \pi x^2 = (42.27)^2 \times \pi = 5613.26; \\ du &= 2\pi x dx, \quad \frac{du}{dx} = 2\pi x, \\ r_u &= r_x \frac{du}{dx} = r_x(2\pi x) = \pm 0.02 \times 2\pi \times 42.27 = \pm 5.31; \end{aligned}$$

whence we write

$$\text{Area} = 5613.26 \pm 5.31 \text{ sq.ft.}$$

182. The Computed Quantity is the Algebraic Sum of Two or More Independently Observed Quantities.

Let u and r_u = the computed quantity and its probable error;

$x, y,$ etc. = the independently observed quantities;
 $r_x, r_y,$ etc. = the probable errors of $x, y,$ etc.;

then

$$u = \pm x \pm y \pm \text{etc.};$$

and

$$r_u = \sqrt{r_x^2 + r_y^2 + \text{etc.}} \dots \dots \dots (64)$$

The observed quantities x , y , z , etc., may each be a different function of one or more observed quantities, but the *absolute independence* of x , y , z , etc., must be maintained. In other words, x must be independent of any observed quantity involved in y , z , etc.; y independent of any observed quantity involved in x , z , etc.; and so on. Thus, for instance, we can not regard $2x$ as equal to $x + x$, and substitute in the above formula, since x and x in the quantity $2x$ are not independent quantities. Attention is also called to the fact that the signs under the radical are always positive, whether the computed quantity is the result of addition or subtraction or both combined.

Example 1. Referring to Fig. 70, given

$$x = 70^\circ 13' 27''.60 \pm 2''.16;$$

$$y = 40 \quad 57 \quad 19 \quad .32 \pm 1 \quad .07;$$

to find the most probable value and the probable error of z .

In this case

$$z = x + y = 111^\circ 10' 46''.92;$$

$$r_u = \sqrt{(2.16)^2 + (1.07)^2} = \pm 2''.41;$$

whence we write

$$z = 111^\circ 10' 46''.92 \pm 2''.41.$$

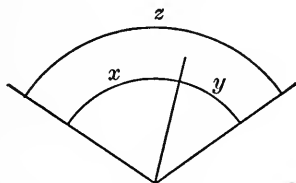

FIG. 70.

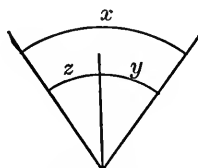

FIG. 71.

Example 2. Referring to Fig. 71, given

$$x = 70^\circ 13' 27''.60 \pm 2''.16;$$

$$y = 40 \quad 57 \quad 19 \quad .32 \pm 1 \quad .07;$$

to find the most probable value and the probable error of z .

In this case

$$z = x - y = 29^\circ 16' 08''.28;$$

$$r_u = \sqrt{(2.16)^2 + (1.07)^2} = \pm 2''.41;$$

whence we write

$$z = 29^\circ 16' 08''.28 \pm 2''.41.$$

183. The Computed Quantity is any Function of Two or More Independently Observed Quantities.

Let u and r_u = the computed quantity and its probable error;
 $x, y,$ etc. = the independently observed quantities;
 $r_x, r_y,$ etc. = the probable errors of $x, y,$ etc.;

then

$$u = \phi(x, y, \text{etc.});$$

and

$$r_u = \sqrt{\left(r_x \frac{du}{dx}\right)^2 + \left(r_y \frac{du}{dy}\right)^2 + \text{etc.}} \quad \dots \quad (65)$$

All the remarks under the previous case apply with equal force to the present case.

Example 1. The measured values for the two sides of a rectangle are

$$\begin{aligned} x &= 55.28 \pm 0.03 \text{ ft.} \\ y &= 85.72 \pm 0.05 \text{ ft.} \end{aligned}$$

What is the most probable value of the area and its probable error?

$$u = xy = 55.28 \times 85.72 = 4738.60;$$

$$\frac{du}{dx} = y, \qquad \frac{du}{dy} = x,$$

$$\begin{aligned} r_u &= \sqrt{(r_x y)^2 + (r_y x)^2} \\ &= \sqrt{(0.03 \times 85.72)^2 + (0.05 \times 55.28)^2} = \pm 3.78; \end{aligned}$$

whence we write

$$\text{Area} = 4738.60 \pm 3.78 \text{ sq.ft.}$$

Example 2. Referring to the right-angled triangle in Fig. 72, given

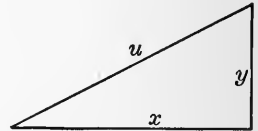

FIG. 72.

$$\begin{aligned} x &= 38.17 \pm 0.05 \text{ ft.}; \\ y &= 19.16 \pm 0.04 \text{ ft.}; \end{aligned}$$

to find the most probable value of the hypotenuse u and its probable error.

$$u = \sqrt{x^2 + y^2} = \sqrt{(38.17)^2 + (19.16)^2} = 42.71;$$

$$\frac{du}{dx} = \frac{x}{\sqrt{x^2 + y^2}}, \qquad \frac{du}{dy} = \frac{y}{\sqrt{x^2 + y^2}},$$

$$\begin{aligned} r_u &= \sqrt{\left(\frac{r_x x}{\sqrt{x^2 + y^2}}\right)^2 + \left(\frac{r_y y}{\sqrt{x^2 + y^2}}\right)^2} = \sqrt{\frac{(r_x x)^2 + (r_y y)^2}{x^2 + y^2}} \\ &= \sqrt{\frac{(38.17 \times 0.05)^2 + (19.16 \times 0.04)^2}{(38.17)^2 + (19.16)^2}} = \pm 0.05; \end{aligned}$$

whence we write

$$\text{Hypotenuse} = 42.71 \pm 0.05 \text{ ft.}$$

Example 3. Referring to Fig. 73, in which the horizontal distance x and the vertical angle ϕ have been measured, given

$$x = 489.11 \pm 0.32 \text{ ft.};$$

$$\phi = 12^\circ 17' \pm 1';$$

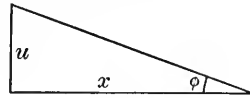

FIG. 73.

to find the most probable value of the elevation u and its probable error

$$u = x \tan \phi = 106.49;$$

$$\frac{du}{dx} = \tan \phi, \quad \frac{du}{d\phi} = \frac{x}{\cos^2 \phi},$$

$$r_u = \sqrt{(r_x \tan \phi)^2 + \left(\frac{r_\phi x}{\cos^2 \phi}\right)^2}.$$

It is necessary at this point to remember that expressing an angle in degrees, minutes, and seconds, is only a trigonometrical convenience, and that the true measure of an angle is the ratio of the subtending arc to its radius. An arc expressed in minutes must therefore be compared with a radian expressed in minutes (that is, an arc whose length equals that of the describing radius) in order to complete its angular meaning.

$$1 \text{ radian} = 3438', \text{ nearly.}$$

$$r_\phi = \frac{1}{3438}.$$

$$r_u = \sqrt{(0.32 \tan \phi)^2 + \left(\frac{1}{3438} \times \frac{489.11}{\cos^2 \phi}\right)^2} = \pm 0.16;$$

whence we write

$$u = 106.49 \pm 0.16 \text{ ft.}$$

CHAPTER XIV

APPLICATION TO ANGULAR MEASUREMENTS

184. General Considerations. In the adjustment of angular measurements three classes of problems may arise, known as single angle adjustment, station adjustment, and figure adjustment.

By *single angle adjustment* is meant the determination of the most probable value of an angle which can be obtained from the measurements made directly upon it.

By *station adjustment* is meant the determination of the most probable values of two or more angles at a single station, in order to meet the condition of being geometrically consistent.

By *figure adjustment* is meant the determination of the most probable values of the angles involved in any geometric figure, in order to meet the condition of being geometrically consistent.

In trigonometric work of any importance each individual angle is always measured a large number of times, and the most probable value due to these results is considered as its measured value. The station adjustment or figure adjustment is then made in accordance with the conditions of the given case.

SINGLE ANGLE ADJUSTMENT

185. The Case of Equal Weights. In this case (Art. 155) the most probable value is the arithmetic mean of the individual measurements.

Example. Three equally reliable measurements of the angle x give $29^{\circ} 21' 59''.1$, $29^{\circ} 22' 06''.4$, $29^{\circ} 21' 58''.1$. What is its most probable value?

$$\begin{array}{r} 29^{\circ} 21' 59''.1 \\ 29 \quad 22 \quad 06 \quad .4 \\ 29 \quad 21 \quad 58 \quad .1 \\ \hline 3)88 \quad 06 \quad 03 \quad .6 \\ \hline 29^{\circ} 22' 01''.2 \end{array}$$

The most probable value is therefore $29^{\circ} 22' 01''.2$.

186. The Case of Unequal Weights. In this case (Art. 157) the most probable value is the weighted arithmetic mean of the individual measurements.

Example. Three measurements of an angle x give $38^\circ 15' 17''.2$ (weight 1), $38^\circ 15' 15''.5$ (weight 3), and $38^\circ 15' 18''.0$ (weight 2). What is its most probable value?

$$\begin{array}{r}
 38^\circ 15' 17''.2 \times 1 = 38^\circ 15' 17''.2 \\
 38^\circ 15' 15''.5 \times 3 = 114^\circ 45' 46''.5 \\
 38^\circ 15' 18''.0 \times 2 = 76^\circ 30' 36''.0 \\
 \hline
 6) 229^\circ 31' 39''.7 \\
 \underline{38^\circ 15' 16''.6}
 \end{array}$$

The most probable value is therefore $38^\circ 15' 16''.6$.

STATION ADJUSTMENT

187. General Considerations. All cases of station adjustment necessarily imply one or more conditional equations. In the determination of the most probable values of the several angles these equations may be avoided (Art. 165), eliminated (Art. 166), or involved in the computation (Art. 167), as found most convenient. The angles at a station are in general measured under similar conditions, so that in making the adjustment it is customary to give to each angle a weight equal to the number of observations (or the sum of the weights in the case of weighted observations) on which it depends. Angles are seldom measured a sufficient number of times to make it justifiable to weight them inversely as the squares of their probable errors, as would be required by the last paragraph of Art. 172. The following cases of station adjustment show the general principles involved:

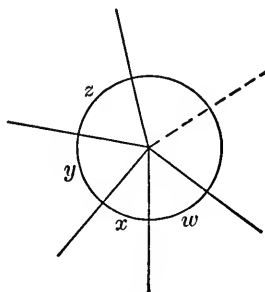

FIG. 74.

188. Closing the Horizon with Angles of Equal Weight. Referring to Fig. 74,

- Let $x, y, z, \dots w$ = the angles measured;
- $a, b, c, \dots m$ = their measured values;
- n = the number of angles measured;
- $d = (a + b + c \dots + m) - 360^\circ$ = the discrepancy to be adjusted;

then the observation equations are

$$\begin{aligned}x &= a; \\y &= b; \\z &= c; \\&\dots \\w &= m;\end{aligned}$$

and the conditional equation is

$$x + y + z \dots + w = 360^\circ.$$

It is evident from the figure, however, that this conditional equation may be avoided (Art. 165) by regarding all the angles except w , for instance, as independent, and involving the required condition by expressing this angle in terms of the others. The observation equations thus become

$$\begin{aligned}x &= a; \\y &= b; \\z &= c; \\&\dots\end{aligned}$$

$$360^\circ - (x + y + z \dots) = m.$$

Passing to the reduced observation equations (Art. 163) by substituting for the most probable values of the unknown quantities,

$$\begin{aligned}x &= a + v_1; \\y &= b + v_2; \\z &= c + v_3; \\&\text{etc.}\end{aligned}$$

we have

$$\begin{aligned}v_1 &= 0; \\v_2 &= 0; \\v_3 &= 0; \\&\dots\end{aligned}$$

$$v_1 + v_2 + v_3 \dots = 360^\circ - (a + b + c \dots + m) = -d;$$

giving the normal equations

$$\begin{aligned}2v_1 + v_2 + v_3 + v_4 + v_5 \dots &= -d; \\v_1 + 2v_2 + v_3 + v_4 + v_5 \dots &= -d; \\v_1 + v_2 + 2v_3 + v_4 + v_5 \dots &= -d; \\&\text{etc.,} \qquad \qquad \qquad \text{etc.}\end{aligned}$$

Subtracting the second equation from the first, we have

$$v_1 - v_2 = 0, \text{ or } v_1 = v_2.$$

Subtracting the third equation from the second, we have

$$v_2 - v_3 = 0, \text{ or } v_2 = v_3.$$

Or, in general,

$$v_1 = v_2 = v_3 = v_4 = v_5 = \text{etc.}$$

But

$$v_1 + v_2 + v_3 \dots = -d;$$

whence

$$v_1 = v_2 = v_3 = \text{etc.} = -\frac{d}{n} \dots \dots (66)$$

Eq. (66) shows that when angles of equal weight are arranged around a point so as to close the horizon, the most probable value for each angle is found by a uniform distribution of the discrepancy.

Example. Referring to Fig. 75, the following observations are to be adjusted:

$x = 45^\circ$	$20'$	$19''.3$	(weight 1);
$y = 151$	52	48.6	(weight 1);
$z = 162$	46	58.4	(weight 1).

360°	$00'$	$06''.3$
360	00	00.0

$$d = +06''.3$$

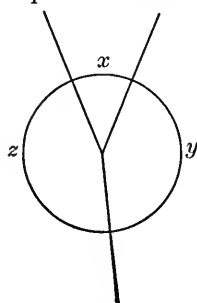

FIG. 75.

In accordance with the above principle each angle must be reduced by $2''.1$, giving for the most probable values

$x = 45^\circ$	$20'$	$17''.2;$
$y = 151$	52	$46.5;$
$z = 162$	46	$56.3.$

189. Closing the Horizon with Angles of Unequal Weight.

Referring to Fig. 74, page 313,

- Let $x, y, z, \dots w$ = the angles measured;
- $a, b, c, \dots m$ = their measured values;
- $p_1, p_2, p_3, \dots p_n$ = their respective weights;
- n = the number of angles measured;
- $d = (a + b + c \dots + m) - 360^\circ$ = the discrepancy to be adjusted;

then the observation equations are

$$\begin{aligned}x &= a \quad (\text{weight } p_1); \\y &= b \quad (\text{weight } p_2); \\z &= c \quad (\text{weight } p_3); \\&\cdot \quad \cdot \quad \cdot \quad \cdot \\w &= m \quad (\text{weight } p_n); \end{aligned}$$

and the conditional equation is

$$x + y + z \dots + w = 360^\circ.$$

It is evident that this conditional equation may be avoided, as in Art. 188, by writing the observation equations in the form

$$\begin{aligned}x &= a \quad (\text{weight } p_1); \\y &= b \quad (\text{weight } p_2); \\z &= c \quad (\text{weight } p_3); \\&\cdot \quad \cdot \quad \cdot \quad \cdot \\360^\circ - (x + y + z \dots) &= m \quad (\text{weight } p_n). \end{aligned}$$

Passing to the reduced observation equations, as before, by substituting

$$\begin{aligned}x &= a + v_1; \\y &= b + v_2; \\&\text{etc.}; \end{aligned}$$

we have

$$\begin{aligned}v_1 &= 0 \quad (\text{weight } p_1); \\v_2 &= 0 \quad (\text{weight } p_2); \\v_3 &= 0 \quad (\text{weight } p_3); \\&\cdot \quad \cdot \quad \cdot \quad \cdot \\v_1 + v_2 + v_3 \dots &= -d \quad (\text{weight } p_n); \end{aligned}$$

giving the normal equations

$$\begin{aligned}p_1 v_1 + p_n (v_1 + v_2 + v_3 \dots) &= -p_n d; \\p_2 v_2 + p_n (v_1 + v_2 + v_3 \dots) &= -p_n d; \\p_3 v_3 + p_n (v_1 + v_2 + v_3 \dots) &= -p_n d. \\&\text{etc.,} \qquad \qquad \qquad \text{etc.} \end{aligned}$$

Subtracting the second equation from the first, the third equation from the second, and so on, we have

$$\begin{aligned}
 p_1v_1 - p_2v_2 &= 0, & \text{or } p_1v_1 &= p_2v_2; \\
 p_2v_2 - p_3v_3 &= 0, & \text{or } p_2v_2 &= p_3v_3; \\
 & \text{etc.,} & & \text{etc.;}
 \end{aligned}$$

or, in general,

$$p_1v_1 = p_2v_2 = p_3v_3 = p_4v_4 = \text{etc.} \quad . \quad . \quad . \quad (67)$$

Eq.(67) shows that when angles of unequal weight are arranged around a point so as to close the horizon, the most probable value for each angle is found by distributing the discrepancy inversely as the corresponding weights.

Example. Referring to Fig. 75, page 315, the following observations are to be adjusted:

$$\begin{array}{r}
 x = 50^\circ \quad 49' \quad 27''.6 \quad (\text{weight } 2); \\
 y = 149 \quad 22 \quad 22.8 \quad (\text{weight } 1); \\
 z = 159 \quad 48 \quad 05.9 \quad (\text{weight } 3). \\
 \hline
 359^\circ \quad 59' \quad 56''.3 \\
 360 \quad 00 \quad 00.0 \\
 \hline
 d = -03''.7
 \end{array}$$

In accordance with the above principle this discrepancy is to be distributed as

$$\frac{1}{2} : \frac{1}{1} : \frac{1}{3};$$

which, cleared of fractions, equals

$$3 : 6 : 2.$$

The three corrections are thus

$$3.7 \times \frac{3}{11} = 1''.01, \quad 3.7 \times \frac{6}{11} = 2''.02, \quad \text{and} \quad 3.7 \times \frac{2}{11} = 0''.67.$$

The most probable values are therefore

$$\begin{array}{r}
 x = 50^\circ \quad 49' \quad 28''.61; \\
 y = 149 \quad 22 \quad 24.82; \\
 z = 159 \quad 48 \quad 06.57.
 \end{array}$$

190. Simple Summation Adjustments. Referring to Fig. 76, page 318, let $x, y, z,$ etc., represent a series of angles at the point $C,$

and let w represent the corresponding summation angle. Then we must have geometrically,

$$w = x + y + z + \text{etc.}$$

But the measured values of these angles will seldom satisfy this conditional equation, and an adjustment becomes necessary to remove the discrepancy. In making the adjustment it is evidently immaterial whether we regard w or w' as the angle actually measured, since these values are mutually convertible and only different expressions for the same fundamental idea. The adjustment may therefore be made in any case by subtracting the measured value of w from 360° to obtain the apparent value of w' , and then applying the rule of Arts. 188 or 189, as may be necessary. Since the correction to w' will have the same sign as all the remaining corrections, it is evident that the correction to w must have the opposite sign. We are thus led to the following conclusions:

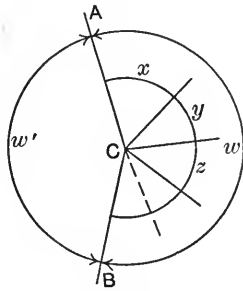

FIG. 76.

remove the discrepancy. In making the adjustment it is evidently immaterial whether we regard w or w' as the angle actually measured, since these values are mutually convertible and only different expressions for the same fundamental idea. The adjustment may therefore be made in any case by subtracting the measured value of w from 360° to obtain the apparent value of w' , and then applying the rule of Arts. 188 or 189, as may be necessary. Since the correction to w' will have the same sign as all the remaining corrections, it is evident that the correction to w must have the opposite sign. We are thus led to the following conclusions:

In the case of equal weights the most probable values of the measured angles are obtained by an equal numerical distribution of the discrepancy, with opposite signs for the summation-angle correction and all the remaining corrections.

In the case of unequal weights the most probable values of the measured angles are obtained by a numerical distribution of the discrepancy inversely proportional to the several weights, with opposite signs for the summation-angle correction and all the remaining corrections.

In the case of unequal weights the most probable values of the measured angles are obtained by a numerical distribution of the discrepancy inversely proportional to the several weights, with opposite signs for the summation-angle correction and all the remaining corrections.

Example 1. Referring to Fig. 77, the following observations are to be adjusted:

- $x = 39^\circ 12' 32''.6$ (weight 1);
- $y = 44 \ 47 \ 59 \ .3$ (weight 1);
- $x + y = 84 \ 00 \ 35 \ .8$ (weight 1).

39° 12' 32''.6
44 47 59 .3
84 00 31 .9
84 00 35 .8

3)03 .9
1 .3

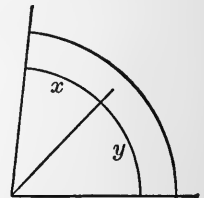

FIG. 77.

In accordance with the above principles the most probable corrections to the measured angles are

$$+ 1''.3, \quad + 1''.3, \quad - 1''.3;$$

giving as the most probable values,

$$\begin{aligned} x &= 39^\circ 12' 33''.9; \\ y &= 44 \quad 48 \quad 00 \quad .6; \\ x + y &= 84 \quad 00 \quad 34 \quad .5. \end{aligned}$$

Example 2. Referring to Fig. 77, the following observations are to be adjusted:

$$\begin{aligned} x &= 40^\circ 16' 23''.7 \text{ (weight 2);} \\ y &= 46 \quad 36 \quad 48 \quad .5 \text{ (weight 3);} \\ x + y &= 86 \quad 53 \quad 08 \quad .0 \text{ (weight 4).} \end{aligned}$$

$$\begin{array}{r} 40^\circ 16' 23''.7 \\ 46 \quad 36 \quad 48 \quad .5 \\ \hline 86 \quad 53 \quad 12 \quad .2 \\ 86 \quad 53 \quad 08 \quad .0 \\ \hline d = 04 \quad .2 \end{array}$$

In accordance with the above principles this discrepancy is to be distributed numerically as

$$\frac{1}{2} : \frac{1}{3} : \frac{1}{4};$$

which, cleared of fractions, equals

$$6 : 4 : 3;$$

giving as the most probable corrections

$$\begin{aligned} - 4.2 \times \frac{6}{13} &= - 1''.94; \\ - 4.2 \times \frac{4}{13} &= - 1''.29; \\ + 4.2 \times \frac{3}{13} &= + 0''.97; \end{aligned}$$

and therefore as the most probable values

$$\begin{aligned} x &= 40^\circ 16' 21''.76; \\ y &= 46 \quad 36 \quad 47 \quad 21; \\ x + y &= 86 \quad 53 \quad 08 \quad .97. \end{aligned}$$

191. The General Case. The cases given in Arts. 188, 189, and 190, are the only ones in which it is desirable to establish special rules. Any case of station adjustment may be solved by writing out the observation and conditional equations and then applying the principles developed in Chapters XI and XII.

Example 1. Referring to Fig. 78, find the most probable values of the angles x , y , and z , from the following observations:

$$\begin{aligned} x &= 25^\circ 17' 10''.2 \text{ (weight 1);} \\ y &= 28 \quad 22 \quad 16.4 \text{ (weight 2);} \\ z &= 32 \quad 40 \quad 28.5 \text{ (weight 2);} \\ x + y &= 53 \quad 39 \quad 23.1 \text{ (weight 2);} \\ x + y + z &= 86 \quad 19 \quad 57.8 \text{ (weight 1).} \end{aligned}$$

Letting v_1, v_2, v_3 , be the most probable corrections for x, y , and z , we may write (Art. 163) the reduced observation equations

$$\begin{aligned} v_1 &= 0''.0 \text{ (weight 1);} \\ v_2 &= 0.0 \text{ (weight 2);} \\ v_3 &= 0.0 \text{ (weight 2);} \\ v_1 + v_2 &= -3.5 \text{ (weight 2);} \\ v_1 + v_2 + v_3 &= +2.7 \text{ (weight 1);} \end{aligned}$$

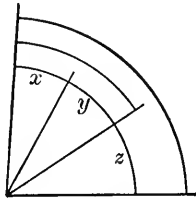

FIG. 78.

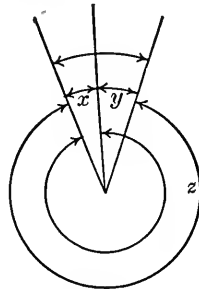

FIG. 79.

from which we have the normal equations

$$\begin{aligned} 4v_1 + 3v_2 + v_3 &= -4.3; \\ 3v_1 + 5v_2 + v_3 &= -4.3; \\ v_1 + v_2 + 3v_3 &= 2.7; \end{aligned}$$

whose solution gives

$$v_1 = -1''.04, \quad v_2 = -0''.52, \quad v_3 = +1''.42.$$

The most probable values of the given angles are therefore

$$\begin{aligned} x &= 25^\circ 17' 09''.16; \\ y &= 28 \quad 22 \quad 15.88; \\ z &= 32 \quad 40 \quad 29.92. \end{aligned}$$

Example 2. Referring to Fig. 79, find the most probable values of the angles x, y , and z , from the following observations:

$$\begin{aligned} x &= 14^\circ 11' 17''.1 \text{ (weight 1);} \\ y &= 19 \quad 07 \quad 21.3 \text{ (weight 2);} \\ x + y &= 33 \quad 18 \quad 43.4 \text{ (weight 1);} \\ z &= 326 \quad 41 \quad 18.2 \text{ (weight 2);} \\ y + z &= 345 \quad 48 \quad 39.2 \text{ (weight 3).} \end{aligned}$$

As the angles x , y , and z close the horizon they must satisfy the conditional equation

$$x + y + z = 360^\circ.$$

Avoiding this conditional equation by subtracting all angles containing z from 360° , we have

$$\begin{aligned} x &= 14^\circ 11' 17''.1 \text{ (weight 1);} \\ y &= 19 07 21 .3 \text{ (weight 2);} \\ x + y &= 33 18 43 .4 \text{ (weight 1);} \\ x + y &= 33 18 41 .8 \text{ (weight 2);} \\ x &= 14 11 20 .8 \text{ (weight 3);} \end{aligned}$$

in which x and y may be regarded as independent quantities.

Letting v_1 and v_2 be the most probable corrections for x and y , and writing the reduced observation equations in accordance with Art. 163, we have

$$\begin{aligned} v_1 &= 0''.0 \text{ (weight 1);} \\ v_2 &= 0 .0 \text{ (weight 2);} \\ v_1 + v_2 &= 5 .0 \text{ (weight 1);} \\ v_1 + v_2 &= 3 .4 \text{ (weight 2);} \\ v_1 &= 3 .7 \text{ (weight 3);} \end{aligned}$$

from which we have the normal equations

$$\begin{aligned} 7v_1 + 3v_2 &= 22.9; \\ 3v_1 + 5v_2 &= 11.8; \end{aligned}$$

whose solution gives

$$v_1 = +3''.04, \quad v_2 = +0''.53.$$

The most probable values of x and y are therefore

$$\begin{aligned} x &= 14^\circ 11' 20''.14; \\ y &= 19 07 21 .83; \end{aligned}$$

and hence the most probable value for z must be

$$z = 326^\circ 41' 18''.03,$$

in order to make the sum total of 360° .

FIGURE ADJUSTMENT

192. General Considerations. All cases of figure adjustment necessarily imply one or more conditional equations. In the determination of the most probable values of the several angles these equations may be avoided (Art. 165), eliminated (Art. 166), or involved in the computation (Art. 167), as found most convenient. The angles in a triangulation system are in general measured under similar conditions, so that in making the adjustment it is customary to give to each angle a weight equal to the number of observations (or the sum of the weights in the case of weighted observations) on which it depends. Angles are seldom measured a sufficient number of times to make it justifiable to weight them inversely as the squares of their probable errors,

as would be required by the last paragraph of Art. 172. In work of moderate extent any required station adjustment may be made prior to the figure adjustment, but in very important work it may be desirable to make both adjustments in one operation. Except in very important work, the triangles, quadrilaterals, or other figures in a system may be adjusted independently. In work of the highest importance the whole system would be adjusted in one operation. The following cases of figure adjustment show the general principles involved, assuming that the reduction for spherical excess (Arts. 56, 57, 58) has already been made.

193. Triangle Adjustment with Angles of Equal Weight.
Referring to Fig. 80,

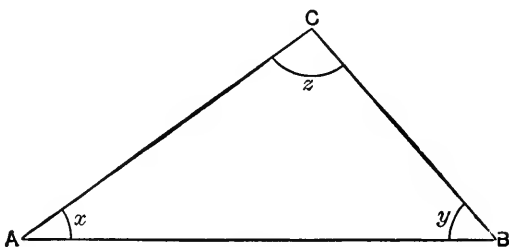

FIG. 80.

Let x, y, z = the unknown angles;

a, b, c = the measured values;

$d = (a + b + c) - 180^\circ$ = the discrepancy to be adjusted.

Avoiding the conditional equation (Art. 163) for the sum of the three angles by writing the observation equations in terms of x and y as independent quantities, we have

$$x = a;$$

$$y = b;$$

$$x + y = 180^\circ - c.$$

Substituting for the most probable values

$$x = a + v_1;$$

$$y = b + v_2;$$

we have

$$v_1 = 0;$$

$$v_2 = 0;$$

$$v_1 + v_2 = 180^\circ - (a + b + c) = -d;$$

giving the normal equations,

$$\begin{aligned} 2v_1 + v_2 &= -d; \\ v_1 + 2v_2 &= -d; \end{aligned}$$

whence by subtraction,

$$v_1 - v_2 = 0, \text{ or } v_1 = v_2.$$

In a similar manner it may be shown that v_1 or v_2 is equal to v_3 , or in general,

$$v_1 = v_2 = v_3.$$

But evidently,

$$v_1 + v_2 + v_3 = -d;$$

whence,

$$v_1 = v_2 = v_3 = -\frac{d}{3}. \quad \dots \quad (68)$$

Equation (68) shows that when the measured angles of a triangle are considered of equal weight, the most probable values of these angles are found by adjusting each angle equally for one-third of the discrepancy.

Example. The measured values (of equal weight) for the three angles of a triangle are $92^\circ 33' 15''.4$, $48^\circ 11' 29''.6$, and $39^\circ 15' 12''.3$. What are the most probable values?

Measured Values	Most Probable Values
92° 33' 15".4	92° 33' 16".3
48 11 29 .6	48 11 30 .5
39 15 12 .3	39 15 13 .2
179° 59' 57".3	180° 00' 00".0
180 00 00 .0	
3) 02".7	
- 0".9	

194. Triangle Adjustment with Angles of Unequal Weight.

Referring to Fig. 80,

Let x, y, z = the unknown angles;

a, b, c = the measured values;

p_1, p_2, p_3 = the respective weights;

$d = (a + b + c) - 180^\circ =$ the discrepancy to be adjusted.

Avoiding the conditional equation as before by making x and y the independent quantities, we have

$$\begin{aligned} x &= a && \text{(weight } p_1); \\ y &= b && \text{(weight } p_2); \\ x + y &= 180^\circ - c && \text{(weight } p_3). \end{aligned}$$

Substituting, as before,

$$\begin{aligned}x &= a + v_1; \\y &= b + v_2;\end{aligned}$$

we have

$$\begin{aligned}v_1 &= 0 && \text{(weight } p_1); \\v_2 &= 0 && \text{(weight } p_2); \\v_1 + v_2 &= 180^\circ - (a + b + c) = -d && \text{(weight } p_3); \end{aligned}$$

giving the normal equations

$$\begin{aligned}p_1v_1 + p_3(v_1 + v_2) &= -p_3d; \\p_2v_2 + p_3(v_1 + v_2) &= -p_3d;\end{aligned}$$

whence, by subtraction,

$$p_1v_1 - p_2v_2 = 0, \quad \text{or} \quad p_1v_1 = p_2v_2.$$

In a similar manner it may be shown that p_1v_1 or p_2v_2 is equal to p_3v_3 . Hence, in any case,

$$\left. \begin{aligned}v_1 + v_2 + v_3 &= -d \\p_1v_1 = p_2v_2 = p_3v_3\end{aligned} \right\} \dots \dots \dots (69)$$

Eqs. (69) show that when the measured angles of a triangle are considered of unequal weight, the most probable values of these angles are found by distributing the discrepancy inversely as the corresponding weights.

Example. The measured values for the three angles of a triangle are $97^\circ 49' 56''.8$ (weight 2), $38^\circ 06' 05''.0$ (weight 1), and $44^\circ 04' 01''.1$ (weight 3). What are the most probable values?

$$\begin{array}{r}97^\circ 49' 56''.8 \\38 \quad 06 \quad 05 \quad .0 \\44 \quad 04 \quad 01 \quad .1 \\ \hline 180^\circ 00' 02''.9 \\180 \quad 00 \quad 00 \quad .0 \\ \hline d = + 02''.9\end{array}$$

$$\frac{1}{2} : \frac{1}{1} : \frac{1}{3} = 3:6:2; \quad 3 + 6 + 2 = 11;$$

$$\begin{aligned}+ 02.9 \times \frac{3}{11} &= + 00''.79, & + 02.9 \times \frac{6}{11} &= + 01''.58, \\+ 02.9 \times \frac{2}{11} &= + 00''.53.\end{aligned}$$

The most probable values are therefore

$$\begin{array}{r}97^\circ 49' 56''.01 \\38 \quad 06 \quad 03 \quad .42 \\44 \quad 04 \quad 00 \quad .57 \\ \hline 180^\circ 00' 00''.00\end{array}$$

195. Two Connected Triangles. A simple case of figure adjustment is illustrated in Fig. 81. Two triangles are here connected by the common side AB , and the eight indicated angles are measured. It is evident from the figure that four independent conditional equations must be satisfied by the adjusted values of the angles, for the summation angles at A and B must agree with their component angles, and the angles in each of the two triangles must add up to 180° . The problem may be worked out by the methods of Arts. 165, 166, or 167. The fol-

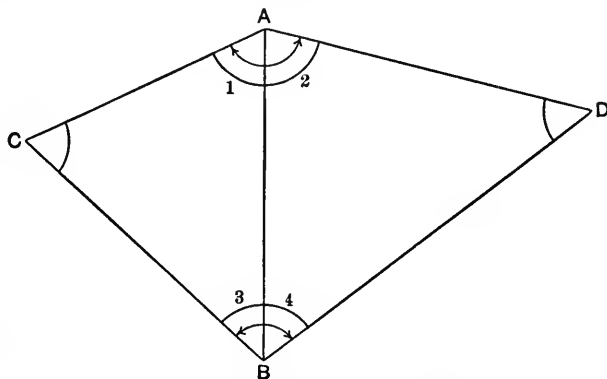

FIG. 81.—Two Connected Triangles.

lowing example is worked out by the algebraic elimination of the conditional equations (Art. 166) in order to illustrate this method.

Example. Referring to Fig. 81, given the following observed values of equal weight, to find the most probable values of the measured angles:

Observed Values of Angles			
$A_1 = 65^\circ$	25'	18''.1;	$A = 141^\circ$ 09' 02''.2;
$A_2 = 75$	43	45 .1;	$B = 100$ 46 06 .6;
$B_3 = 47$	26	11 .9;	$C = 67$ 08 28 .4;
$B_4 = 53$	19	51 .8;	$D = 50$ 56 25 .2.

Writing out the four conditional equations, we have

$$\begin{aligned} A &= A_1 + A_2; \\ B &= B_3 + B_4; \\ C + A_1 + B_3 &= 180^\circ; \\ D + A_2 + B_4 &= 180^\circ. \end{aligned}$$

In accordance with Art. 166, four of the unknowns may be regarded as independent quantities. It is evident from the figure or from the conditional equations that A_1 , A_2 , B_3 , B_4 may be taken as the independent unknowns, whence A , B , C , D become the dependent ones. These latter quantities are selected as the dependent ones in preference to any other

four because they are so easily found from the given conditional equations. Solving for these quantities, we have

$$\begin{aligned} A &= A_1 + A_2; \\ B &= B_3 + B_4; \\ C &= 180^\circ - (A_1 + B_3); \\ D &= 180^\circ - (A_2 + B_4). \end{aligned}$$

Substituting in the observation equations and reducing, we have

$$\begin{array}{r r r r r r r} A_1 = 65^\circ & 25' & 18''.1; & A_1 + A_2 = 141^\circ & 09' & 02''.2; \\ A_2 = 75 & 43 & 45 .1; & B_3 + B_4 = 100 & 46 & 06 .6; \\ B_3 = 47 & 26 & 11 .9; & A_1 + B_3 = 112 & 51 & 31 .6; \\ B_4 = 53 & 19 & 51 .8; & A_2 + B_4 = 129 & 03 & 34 .8. \end{array}$$

Letting v_1, v_2, v_3, v_4 , be the most probable corrections for A_1, A_2, B_3, B_4 , respectively, we may write the reduced observation equations (Art. 163) as follows:

$$\begin{array}{r r} v_1 = 0''.0; & v_1 + v_2 = -1''.0; \\ v_2 = 0 .0; & v_3 + v_4 = +2 .9; \\ v_3 = 0 .0; & v_1 + v_3 = +1 .6; \\ v_4 = 0 .0; & v_2 + v_4 = -2 .1. \end{array}$$

In a simple case like this the reduced observation equations would usually be written directly from the figure instead of going through the above algebraic work. Having decided on the proper independent quantities, these equations are simply written so as to represent the apparent discrepancy in each observation, always subtracting the independent quantities from the values they are compared with. Forming the normal equations, we have

$$\begin{array}{r r r r} 3v_1 + v_2 + v_3 & & & = +0''.6; \\ v_1 + 3v_2 & & + v_4 & = -3 .1; \\ v_1 & + 3v_3 + v_4 & & = +4 .5; \\ & v_2 + v_3 + 3v_4 & & = +0 .8; \end{array}$$

whose solution gives

$$\begin{array}{r r} v_1 = +0''.10, & v_3 = +1''.41, \\ v_2 = -1 .13, & v_4 = +0 .17. \end{array}$$

Using these corrections to find A_1, A_2, B_3 , and B_4 , and then the conditional equations to find A, B, C , and D , we have for the most probable values

$$\begin{array}{r r r r r r} A_1 = 65^\circ & 25' & 18''.20; & A = 141^\circ & 09' & 02''.17; \\ A_2 = 75 & 43 & 43 .97; & B = 100 & 46 & 05 .28; \\ B_3 = 47 & 26 & 13 .31; & C = 67 & 08 & 28 .49; \\ B_4 = 53 & 19 & 51 .97; & D = 50 & 56 & 24 .06. \end{array}$$

196. Quadrilateral Adjustment. The best method to use in adjusting a geodetic quadrilateral, Fig. 82, is the method of correlatives, Art. 167. In accordance with Art. 58 the adjusted angles must satisfy the following three angle equations:

$$\left. \begin{array}{l} a + b + c + d + e + f + g + h = 360^\circ \\ a + b = e + f \\ c + d = g + h \end{array} \right\} \dots \dots (70)$$

and also the following side equation:

$$\frac{\sin a \sin c \sin e \sin g}{\sin b \sin d \sin f \sin h} = 1,$$

which may be written in the logarithmic form

$$\bar{\Sigma} \log \sin(a, c, e, g) - \Sigma \log \sin(b, d, f, h) = 0. \quad (71)$$

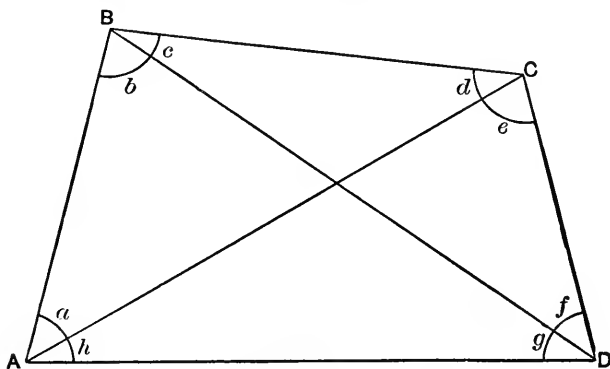

FIG. 82.—The Geodetic Quadrilateral.

Letting M_a, M_b , etc., represent the measured values of the angles a, b , etc., and l_1, l_2, l_3, l_4 , represent the discrepancies in these equations due to the errors in the measured angles, we have

$$\left. \begin{aligned} \Sigma(M_a \text{ to } M_h) - 360^\circ &= l_1 \\ (M_a + M_b) - (M_e + M_f) &= l_2 \\ (M_c + M_d) - (M_g + M_h) &= l_3 \\ \Sigma \log \sin(M_a, M_c, M_e, M_g) - \Sigma \log \sin(M_b, M_d, M_f, M_h) &= l_4 \end{aligned} \right\} (72)$$

The corrections v_a, v_b , etc., to be added algebraically to the measured values M_a, M_b , etc., must reduce these equations to zero in order that the conditional equations (70) and (71) may be satisfied. Therefore we must have

$$\left. \begin{aligned} v_a + v_b + v_c + v_d + v_e + v_f + v_g + v_h &= -l_1 \\ v_a + v_b & - v_e - v_f &= -l_2 \\ & v_c + v_d & - v_g - v_h &= -l_3 \\ d_a v_a - d_b v_b + d_c v_c - d_d v_d + d_e v_e - d_f v_f + d_g v_g - d_h v_h &= -l_4 \end{aligned} \right\} (73)$$

in which v_a, v_b , etc., are to be expressed in seconds, and in which d_a, d_b , etc., are the tabular differences for one second for the

$\log \sin M_a, \log \sin M_b$, etc. If any angle is greater than 90° it is evident that the corresponding tabular difference must be considered negative, since the sine will then decrease as the angle increases in value. The conditional Eqs. (73) being in the form of Eqs. (43), the most probable values of v_a, v_b , etc., may now be found by the method of correlatives (Art. 167), by means of Eqs. (49) and (50). Re-writing these equations with the symbols used in the present article, and remembering that there are four conditional equations and hence four correlatives required, we have in the general case, from Eqs. (49) and (73),

$$\left. \begin{aligned} k_1 \Sigma \frac{a^2}{p} + k_2 \Sigma \frac{ab}{p} + k_3 \Sigma \frac{ac}{p} + k_4 \Sigma \frac{ad}{p} &= -l_1 \\ k_1 \Sigma \frac{ab}{p} + k_2 \Sigma \frac{b^2}{p} + k_3 \Sigma \frac{bc}{p} + k_4 \Sigma \frac{bd}{p} &= -l_2 \\ k_1 \Sigma \frac{ac}{p} + k_2 \Sigma \frac{bc}{p} + k_3 \Sigma \frac{c^2}{p} + k_4 \Sigma \frac{cd}{p} &= -l_3 \\ k_1 \Sigma \frac{ad}{p} + k_2 \Sigma \frac{bd}{p} + k_3 \Sigma \frac{cd}{p} + k_4 \Sigma \frac{d^2}{p} &= -l_4 \end{aligned} \right\} \quad (74)$$

and from Eqs. (50) and (73),

$$\left. \begin{aligned} v_a &= k_1 \frac{1}{p_a} + k_2 \frac{1}{p_a} + k_4 \frac{d_a}{p_a} \\ v_b &= k_1 \frac{1}{p_b} + k_2 \frac{1}{p_b} - k_4 \frac{d_b}{p_b} \\ v_c &= k_1 \frac{1}{p_c} + k_3 \frac{1}{p_c} + k_4 \frac{d_c}{p_c} \\ v_d &= k_1 \frac{1}{p_d} + k_3 \frac{1}{p_d} - k_4 \frac{d_d}{p_d} \\ v_e &= k_1 \frac{1}{p_e} - k_2 \frac{1}{p_e} + k_4 \frac{d_e}{p_e} \\ v_f &= k_1 \frac{1}{p_f} - k_2 \frac{1}{p_f} - k_4 \frac{d_f}{p_f} \\ v_g &= k_1 \frac{1}{p_g} - k_3 \frac{1}{p_g} + k_4 \frac{d_g}{p_g} \\ v_h &= k_1 \frac{1}{p_h} - k_3 \frac{1}{p_h} - k_4 \frac{d_h}{p_h} \end{aligned} \right\} \quad (75)$$

in which p_a represents the weight of M_a , p_b the weight of M_b , and so on.

In the case of equal weights we have, from Eqs. (73) and (74),

$$\left. \begin{aligned} 8k_1 + [(d_a + d_c + d_e + d_g) - (d_b + d_d + d_f + d_h)]k_4 &= -l_1 \\ 4k_2 + (d_a - d_b - d_e + d_f)k_4 &= -l_2 \\ 4k_3 + (d_c - d_d - d_g + d_h)k_4 &= -l_3 \\ [(d_a + d_c + d_e + d_g) - (d_b + d_d + d_f + d_h)]k_1 \\ + (d_a - d_b - d_e + d_f)k_2 + (d_c - d_d - d_g + d_h)k_3 + \Sigma d^2 k_4 &= -l_4 \end{aligned} \right\} (76)$$

and from Eqs. (75),

$$\left. \begin{aligned} v_a &= k_1 + k_2 + d_a k_4 \\ v_b &= k_1 + k_2 - d_b k_4 \\ v_c &= k_1 + k_3 + d_c k_4 \\ v_d &= k_1 + k_3 - d_d k_4 \\ v_e &= k_1 - k_2 + d_e k_4 \\ v_f &= k_1 - k_2 - d_f k_4 \\ v_g &= k_1 - k_3 + d_g k_4 \\ v_h &= k_1 - k_3 - d_h k_4 \end{aligned} \right\} \dots \dots \dots (77)$$

Having found the values of v_a, v_b , etc., we have in any case for the most probable values of the angles a, b , etc.,

$$\left. \begin{aligned} a &= M_a + v_a; & e &= M_e + v_e; \\ b &= M_b + v_b; & f &= M_f + v_f; \\ c &= M_c + v_c; & g &= M_g + v_g; \\ d &= M_d + v_d; & h &= M_h + v_h. \end{aligned} \right\} \dots \dots (78)$$

197. Other Cases of Figure Adjustment. There is evidently no limit to the number of cases of figure adjustment that may be made the subject of consideration, but few of them are likely to be of interest to the civil engineer. Any case that may arise may be adjusted by the method of correlatives (Art. 167), similarly to the quadrilateral adjustment (Art. 196), provided the observation equations and conditional equations are properly expressed. In any case the conditional equations must cover all the geometrical conditions which must be satisfied, and at the same time must be absolutely independent of each other. The number of

QUADRILATERAL ADJUSTMENT BY METHOD OF LEAST SQUARES

Measured Angles.	p	log sin	d	ζ^2	Adjustments.	Adjusted Angles.	Check log sines.
a 46° 18' 38".3	1	9.8591956	20.1	404.01	$k_1 + k_2 + d_c k_4 + 0".18$	46° 18' 38".48	9.8591960
b 53 26 08 .2	1	9.9048172	15.7	246.49	$k_1 + k_2 - d_b k_4 + 3 .74$	53 26 11 .94	9.9048231
c 42 11 29 .6	1	9.8271181	23.2	538.24	$k_1 + k_3 + d_c k_4 - 2 .35$	42 11 27 .25	9.8271126
d 38 03 39 .7	1	9.7899334	26.9	723.61	$k_1 + k_3 - d_d k_4 + 2 .63$	38 03 42 .33	9.7899405
e 58 19 12 .3	1	9.9299271	13.0	169.00	$k_1 - k_2 + d_e k_4 - 1 .77$	58 19 10 .53	9.9299248
f 41 25 38 .0	1	9.8206402	23.8	566.44	$k_1 - k_2 - d_f k_4 + 1 .89$	41 25 39 .89	9.8206447
g 34 33 48 .7	1	9.7538278	30.6	936.36	$k_1 - k_3 + d_g k_4 - 1 .31$	34 33 47 .39	9.7538238
h 45 41 18 .4	1	9.8546411	20.6	424.36	$k_1 - k_3 - d_h k_4 + 3 .79$	45 41 22 .19	9.8546489
359° 59' 53".2	$l_4 = + 367$	$\Sigma d^2 = 4008.51$	360° 00' 00".00	$l_4 = 0$

$a + b = 99^\circ 44' 46".5$ $c + d = 80^\circ 15' 09".3$
 $e + f = 99^\circ 44' 50".3$ $g + h = 80^\circ 15' 07".1$

 $l_2 = - 3".8$ $l_3 = + 2".2$

 $d_a + d_c + d_e + d_g = 86.9$
 $d_b + d_d + d_f + d_h = 87.0$
 $d_a - d_b - d_e + d_f = 15.2$
 $d_c - d_d - d_g + d_h = - 13.7$

 $8k_1$ $4k_2$ $4k_3$ $4k_4$
 $- 0.1k_1 + 15.2k_2 - 13.7k_3 + 4008.51k_4 = - 367.0$

 $k_1 = + 0.8488$ $k_3 = - 0.8905$
 $k_2 = + 1.3277$ $k_4 = - 0.0994$

independent conditional equations can always be ascertained by subtracting the number of independent quantities from the number of observed quantities. The number of independent quantities is in general easily determined by an inspection of the given figure, being that number of independent values which fixes a single location for each angular point. A study of the following examples will illustrate the principles involved.

Example 1. Referring to Fig. 83, the base AB and the indicated angles have been measured; determine the number and nature of the independent conditional equations.

It is evident from the figure that it will take two angles from the fixed points A and B to locate either C or D , and that these four angles are independent. We may therefore select A_1, A_2, B_1, B_2 , as independent angles, and as this will fix the points C and D it will also fix the values of the angles C_1 and C_2 , so that we can not have more than four independent angles. In this particular case any four of the angles can be taken as the independent ones, but this freedom of choice is not a general rule. As there are six observations of which only four are independent, it follows (Art. 166) that two independent conditional equations must be involved. Starting from any known side, AB , we may in general compute any other line of a system through two different sets of triangles, and the requirement that these two results shall be identical will always lead to a corresponding side equation. In the present case, therefore, the two conditional equations must consist of one angle equation and one side equation. The angle equation is evidently,

$$A_1 + A_2 + B_1 + B_2 + C_1 + C_2 = 180^\circ.$$

Taking CD as a convenient line from which to determine the side equation, and equating its values as computed through the triangles ABD and ACD , and through the triangles ABD and BCD , the side equation is easily found to be,

$$\sin A_1 \sin B_1 \sin C_1 = \sin A_2 \sin B_2 \sin C_2.$$

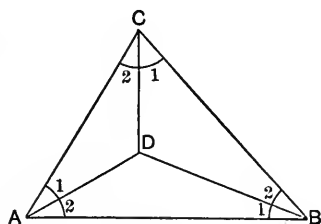

FIG. 83.

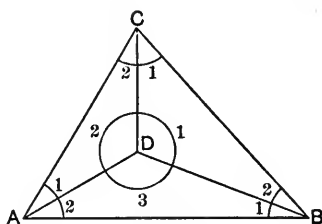

FIG. 84.

Example 2. Referring to Fig. 84, the base AB and the indicated angles have been measured; determine the number and nature of the independent conditional equations.

In this case, as in the previous one, four independent angles will fix the whole figure, so that the fact that nine angles have been measured demands the existence of five independent conditional equations, as nine minus four

equals five. In regarding any four of the angles as independent, it is evident that no three of them must lie in any one triangle, as this would at once destroy the independence of these three angles by setting a condition on their sum. Since, as explained in Example 1, there must be one side equation, on account of the one known line AB , it follows that the present case must involve four independent angle equations to make up the total of five independent conditional equations required. An examination of the figure, however, furnishes five angle equations, as follows:

$$\begin{aligned} A_1 + C_2 + D_2 &= 180^\circ \\ A_2 + B_1 + D_3 &= 180^\circ \\ B_2 + C_1 + D_1 &= 180^\circ \\ A_1 + A_2 + B_1 + B_2 + C_1 + C_2 &= 180^\circ \\ D_1 + D_2 + D_3 &= 360^\circ \end{aligned}$$

As there can be but four independent angle equations, it follows that any one of these five must be dependent on the other four. An examination of the equations will show at once that any one of them may be derived from the remaining four. We may therefore choose any four of these five equations for our four angle equations. Since the figure is identical with the one in Example 1, our side equation as before will be,

$$\sin A_1 \sin B_1 \sin C_1 = \sin A_2 \sin B_2 \sin C_2.$$

Example 3. Referring to Fig. 85, the base AB and the indicated angles have been measured, the interior station being a random point not purposely falling on any diagonal of the figure; determine the number and nature of the independent conditional equations.

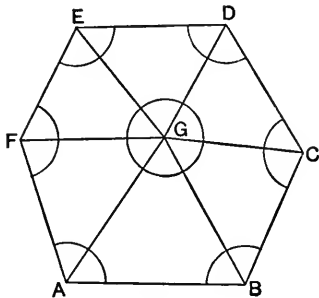

FIG. 85.

In this case the angles in any five of the six triangles will fix the whole figure; and since there can be but two independent angles in each of the five triangles so selected, it follows that we must have ten independent angles. As there are eighteen measured angles and ten independent angles, we must have eight independent conditional equations. As before there must be one side equation, leaving seven angle equations required. Eight such equations may be formed, to meet the conditions that six triangles must each contain

180° , that the corner angles of the hexagon must add up to 720° , and that the central angles must add up to 360° . Any seven of these eight angle equations may be taken as the independent ones, when the requirement of the other one will also be satisfied. For the side equation we may compute any side, such as ED , by going around the figure in both directions from AB , from which it will appear, as in the previous examples, that the product of the sines of one set of alternate corner angles must equal the product of the sines of the other set of alternate corner angles,

CHAPTER XV

APPLICATION TO BASE-LINE WORK

198. Unweighted Measurements. If a base line is measured from end to end a number of times in the same manner, and under such conditions that the different determinations of its length may be regarded as of equal weight, then (Art. 155) the arithmetic mean of the several results is the most probable value of its length. The probable error of a single measurement (Art. 173) is given by the formula

$$r_1 = 0.6745 \sqrt{\frac{\sum v^2}{n-1}}, \dots \dots \dots (79)$$

and the probable error of the arithmetic mean (Art. 173) of n measurements; by the formula

$$r_a = \frac{r_1}{\sqrt{n}} = 0.6745 \sqrt{\frac{\sum v^2}{n(n-1)}}, \dots \dots \dots (80)$$

Example. Direct base-line measurements of equal weight:

Observed Values	v	v^2
6717.601 ft.	- 0.025	0.000625
6717.632 ft.	+ 0.006	0.000036
6717.645 ft.	+ 0.019	0.000361
3)20152.878 ft.		$\Sigma v^2 = 0.001022$
$z = 6717.626$ ft.		$n = 3$

$$r_1 = 0.6745 \sqrt{\frac{0.001022}{2}} = \pm 0.0152 \text{ ft.}$$

$$r_a = \frac{0.0152}{\sqrt{3}} = \pm 0.0088 \text{ ft.}$$

Most probable value = 6717.626 \pm 0.0088 ft.

199. Weighted Measurements. If a base line is measured from end to end a number of times in the same manner, but under

such conditions that the different determinations of its length must be regarded as of unequal weight, then (Art. 157) the weighted arithmetic mean of the several results is the most probable value of its length. The probable error of single measurement of unit weight (Art. 174) is given by the formula

$$r_1 = 0.6745 \sqrt{\frac{\sum pv^2}{n-1}}, \dots \dots \dots (S1)$$

the probable error of any measurement of the weight p (Art. 174) by the formula

$$r_p = \frac{r_1}{\sqrt{p}} = 0.6745 \sqrt{\frac{\sum pv^2}{p(n-1)}}, \dots \dots \dots (S2)$$

and the probable error of the weighted arithmetic mean (Art. 174) by the formula

$$r_{pa} = \frac{r_1}{\sqrt{\sum p}} = 0.6745 \sqrt{\frac{\sum pv^2}{\sum p \cdot (n-1)}}. \dots \dots (S3)$$

Example. Direct base-line measurements of unequal weight:

Observed Values	p	pM	v	v^2	pv^2
7829.614 ft.	1	7829.614	- 0.026	0.000676	0.000676
7829.657 ft.	2	15659.314	+ 0.017	0.000289	0.000578
7829.668 ft.	1	7829.668	+ 0.028	0.000784	0.000784
7829.628 ft.	3	23488.884	- 0.012	0.000144	0.000432
$\sum p = 7$		54807.480		$\sum pv^2 = 0.002470$	
$z = 7829.640$ ft.				$n = 4$	

$$r_1 = 0.6745 \sqrt{\frac{0.002470}{3}} = \pm 0.0194 \text{ ft.}$$

$$r_2 = \frac{0.0194}{\sqrt{2}} = \pm 0.0137 \text{ ft.}$$

$$r_3 = \frac{0.0194}{\sqrt{3}} = \pm 0.0112 \text{ ft.}$$

$$r_{pa} = \frac{0.0194}{\sqrt{7}} = \pm 0.0073 \text{ ft.}$$

Most probable value = 7829.640 ± 0.0073 ft.

200. Duplicate Lines. In work of ordinary importance or moderate extent it is sufficient to measure a base line twice and average the results for the adopted length. When the same line

is measured twice with equal care it is called a *duplicate line*. The rules of Art. 198 necessarily include duplicate lines, but this case is of such frequent occurrence that special rules are found convenient for the probable errors. Letting d represent the discrepancy between the two measurements, and remembering that the arithmetic mean is the most probable value, we have

$$v_1 = + \frac{d}{2} \quad \text{and} \quad v_2 = - \frac{d}{2}.$$

Substituting these values in Eq. (79) and replacing r_1 with r_l for the case of duplicate lines, we have for the probable error of a single measurement of the length l ,

$$r_l = 0.4769\sqrt{d^2} = \pm 0.4769d. \quad \dots \quad (84)$$

Substituting the same values in Eq. (80), we have for the probable error of the arithmetic mean,

$$r_a = \pm 0.3373 d; \quad \dots \quad (85)$$

whence

$$r_a \text{ (approximately) } = \pm \frac{1}{3}d. \quad \dots \quad (86)$$

Example. Measurement of a duplicate base line:

Observed Values	
4998.693 ft.	$0.4769 \times 0.034 = 0.0162.$
4998.659 ft.	$0.3373 \times 0.034 = 0.0115.$
$d = 0.034$ ft.	
$r_l = \pm 0.0162$ ft.	$r_a = \pm 0.0115$ ft.
Most probable value = 4998.676 \pm 0.0115 ft.	

201. Sectional Lines. A base line may be divided up into two or more sections, and each section measured a number of times as a separate line. Each section, on account of its several measurements, will thus have a most probable length and a probable error independent of any other section of the line. If l_1, l_2, \dots, l_n be the most probable lengths of the several sections, then (Art. 168) the most probable length L for the whole line, is

$$L = l_1 + l_2 \dots + l_n = \Sigma l. \quad \dots \quad (87)$$

And if r_1, r_2, \dots, r_n , be the probable errors of the several values l_1, l_2 , etc., then (Art. 182) the probable error r_L for the whole line, is

$$r_L = \sqrt{r_1^2 + r_2^2 \dots + r_n^2} = \sqrt{\Sigma r^2}. \quad \dots \quad (88)$$

Example. Sectional base-line measurement. Given

$$l_1 = 3816.172 \pm 0.022 \text{ ft.}$$

$$l_2 = 4122.804 \pm 0.019 \text{ ft.}$$

$$l_3 = 3641.763 \pm 0.017 \text{ ft.}$$

$$L = 3816.172 + 4122.804 + 3641.763 = 11580.739 \text{ ft.}$$

$$r_L = \sqrt{(0.022)^2 + (0.019)^2 + (0.017)^2} = \pm 0.034 \text{ ft.}$$

$$\text{Most probable value } L = 11580.739 \pm 0.034 \text{ ft.}$$

202. General Law of the Probable Errors. In measuring a base line bar by bar or tape-length by tape-length, the case is essentially one of sectional measurement (Art. 201), in which each section is measured a single time, and in which each full section is of the same measured bar- or tape-length. If the conditions remain unchanged throughout the measurement, therefore, the probable error will be the same for each full section. As explained in Art. 180, however, this is not a case of computed values depending on a constant factor, so that the probable error of the whole line will not follow the law of that article.

Let L = the total length for a line of full sections;

r_L = the probable error of this line;

t = the length of the measuring instrument;

r_t = the probable error for each length measured;

n = the number of lengths measured;

then (Art. 201)

$$r_L = \sqrt{\sum r^2} = \sqrt{nr_t^2}.$$

But evidently

$$n = \frac{L}{t};$$

whence

$$r_L = \sqrt{\frac{L}{t} r_t^2} = \frac{r_t}{\sqrt{t}} \sqrt{L}. \quad \dots \quad (89)$$

Eq. (89) is derived on the assumption that only full bar- or tape-lengths are used. The fractional lengths that occur at the ends of a base (or elsewhere) form such a small proportion of the total length, however, that no appreciable error can arise by assuming Eq. (89) as generally true. A consideration of the various methods and instruments used in measuring base lines also shows

that in any case nothing but systematic errors could modify the truth of this equation. We may therefore write as a

GENERAL LAW: *Under the same conditions of measurement the probable error of a base line varies directly as the square root of its length.*

From the manner in which this law has been derived it is evident that it is theoretically true whether the length assigned to a base line is the result of a single measurement, or the average of a number of measurements, so long as the lines being compared have all been measured in the same way. In cases where the given lines have been measured more than once, so that each line has its own direct probable error, we can not expect an exact agreement with the law. But this relation of the probable errors is more likely than any other that can be assigned, and hence shows the relative accuracy that may be reasonably expected in lines of different length. The chief point of interest in the law lies in the fact that the error in a base line is not likely to increase any faster than the square root of its length, so that the probable error where a line is made four times as long should not be more than doubled, and so on.

Example. A base line measured under certain conditions has the value 7716.982 \pm 0.028 ft. What is the theoretical probable error of a base line 15693.284 ft. long, measured under the same conditions?

$$0.028 \sqrt{\frac{15693.284}{7716.982}} = \pm 0.0399.$$

Theoretical probable error of new line = \pm 0.0399 ft.

203. The Law of Relative Weight. In accordance with the law of the previous article, we may write for the probable error of a base line of any length

$$r_L = m\sqrt{L}, \quad (90)$$

in which m is a coefficient depending on the conditions of measurement. Also in accordance with the law of Art. 172, we may write

$$r_L = s \frac{1}{\sqrt{p}},$$

in which p is the weight assigned to the line and s is a coefficient depending on the unit of weight and the conditions of measure-

ment. Since the unit of weight is entirely arbitrary we may assign that value to p which will make s equal m , and write

$$r_L = m \frac{1}{\sqrt{p}}. \quad \dots \quad (91)$$

Combining Eqs. (90) and (91), we have

$$m\sqrt{L} = m \frac{1}{\sqrt{p}};$$

from which

$$p = \frac{1}{L}; \quad \dots \quad (92)$$

whence we have the

GENERAL LAW: *Under the same conditions of measurement the weight of a base line varies inversely as its length.*

From the manner in which this law has been derived it is evident that it is theoretically true whether the length assigned to a base line is the result of a single measurement, or the average of a number of measurements, provided the lines compared have all been measured in the same way.

If two or more base lines are measured under different conditions, they may be first weighted so as to offset this circumstance, and then weighted inversely as their lengths. The relative weight of each line will then be the product of the weights applied to it.

204. Probable Error of a Line of Unit Length. The probable error of an angular measurement conveys an absolute idea of its precision without regard to the size of the angle. The probable error of a base line, however, conveys no idea of the precision of the work unless accompanied by the length of the line. It is therefore convenient to reduce the probable error of a base line to its corresponding value for a similar line of unit length. A unit of comparison is thus established for different grades or pieces of work which is independent of the length of the bases. Such a unit has no actual existence, but is purely a mathematical basis of comparison.

From Eq. (89) we have

$$r_L = \frac{r_t}{\sqrt{t}} \sqrt{L}.$$

Hence, when L equals 1, we have for r_0 , the probable error of a unit length of line,

$$r_0 = \frac{r_t}{\sqrt{t}};$$

whence in general

$$r_L = r_0\sqrt{L}, \quad (93)$$

in which all the values refer to single measurements. From this equation we see that the probable error of any base line is equal to the square root of its length multiplied by the probable error of a unit length of such a line. If r_0 is well determined for given instruments, conditions, and methods, Eq. (93) informs us in advance what is a suitable probable error for a single measurement, and hence (Art. 198) for the average of any number of measurements of a line of the given length L . The base-line party therefore knows whether its work is up to standard, or whether additional measurements are required.

205. Determination of the Numerical Value of the Probable Error of a Line of Unit Length. From Eq. (93) we have,

$$r_L = r_0\sqrt{L};$$

whence

$$r_0 = \frac{r_L}{\sqrt{L}}. \quad (94)$$

So that in any case where the length of a line and the corresponding probable error are known, the formula determines a value for r_0 . In order for the value of r_0 to be reliable it must be based on many such determinations, but the expense prohibits many measurements of a long base line. As the law is known, however, which connects the values of the probable error for all lengths of line, it is just as satisfactory to determine r_0 from much shorter lines, which may be quickly and cheaply measured many times. The usual plan is to measure a series of duplicate lines, so that the probable error for a single measurement is known in each case from the discrepancy in each pair of lines. Since all results are reduced to the same unit length it is immaterial whether the different duplicate lines are of equal length or not.

In accordance with Eq. (84) we have, for any single measurement of the duplicate line l ,

$$r_l = 0.4769\sqrt{d^2};$$

whence, in accordance with Eq. (94),

$$r_0 = \frac{r_l}{\sqrt{l}} = r_l\sqrt{\frac{1}{l}} = 0.4769\sqrt{\frac{1}{l}d^2};$$

but, in accordance with Eq. (92), we have for any length of line l

$$p = \frac{1}{l};$$

whence

$$r_0 = 0.4769\sqrt{pd^2}, \quad (95)$$

when determined from a single duplicate line. If a number of duplicate lines are measured we will have a corresponding number of values $(r_0)_1, (r_0)_2, \text{ etc.}$, based on the discrepancies $d_1, d_2, \text{ etc.}$, of the several duplicate lines. It might at first be supposed that the average value of these determinations of r_0 would best represent the result of all the measurements. What is really wanted, however, is that value of r_0 which gives equal recognition to the conditions which caused its different values. A just recognition of each value of r_0 , therefore, will require us to consider *equal sections* of any line as having been measured respectively under those conditions that produced the several values of r_0 . The probable error for the whole line is then found from the probable errors of the different sections, and this result reduced to the probable error of a unit length.

Let n = the number of values $(r_0)_1, (r_0)_2, \text{ etc.}$;

L = the length of any given line;

whence the required equal sections will be

$$\left(\frac{L}{n}\right)_1 = \left(\frac{L}{n}\right)_2 = \text{etc.} = \frac{L}{n},$$

and, in accordance with Eq. (93),

$$r\left(\frac{L}{n}\right)_1 = (r_0)_1\sqrt{\frac{L}{n}}, \quad r\left(\frac{L}{n}\right)_2 = (r_0)_2\sqrt{\frac{L}{n}}, \quad \text{etc.};$$

whence, in accordance with Eq. (88),

$$r_L = \sqrt{\Sigma r_0^2} \sqrt{\frac{L}{n}} = \sqrt{\frac{\Sigma r_0^2}{n}} \sqrt{L};$$

and, in accordance with Eq. (94),

$$r_0 = \sqrt{\frac{\Sigma r_0^2}{n}}; \dots \dots \dots (96)$$

but, in accordance with Eq. (95),

$$(r_0)_1 = 0.4769\sqrt{pd_1^2}, \quad (r_0)_2 = 0.4769\sqrt{pd_2^2}, \text{ etc.};$$

so that

$$\Sigma r_0^2 = (0.4769)^2 \Sigma pd^2;$$

whence

$$r_0 = 0.4769 \sqrt{\frac{\Sigma pd^2}{n}}, \dots \dots \dots (97)$$

when determined from a number of duplicate lines. In using formulas (95) and (97) it is to be remembered that d is the discrepancy in any duplicate line, p is the weight (reciprocal of the length) of that line, n is the number of duplicate lines, and r_0 is the probable error of a single measurement of a line of unit length.

Example. Determination and application of the probable error of a base line of unit length:

Duplicate Lines	d	d^2	p	pd^2
512.017 ft. } 512.011 " }	0.006	0.000036	$\frac{1}{512}$	0.000000703
619.184 ft. } 619.176 " }	0.008	0.000064	$\frac{1}{619}$	0.0000001034
750.962 ft. } 750.971 " }	0.009	0.000081	$\frac{1}{751}$	0.0000001079
619.180 ft. } 619.184 " }	0.004	0.000016	$\frac{1}{619}$	0.0000000258
750.960 ft. } 750.972 " }	0.012	0.000144	$\frac{1}{751}$	0.0000001917

from which we have

$$\Sigma pd^2 = 0.0000004991 \quad \text{and} \quad n = 5;$$

whence

$$r_0 = 0.4769 \sqrt{\frac{0.0000004991}{5}} = \pm 0.000151 \text{ ft.},$$

which is therefore the probable error for a single measurement of one foot made under the given conditions. For a single measurement of a base line of any length L , therefore, made under these same conditions, the probable error would be, in accordance with Eq. (93),

$$r_L = r_0\sqrt{L} = \pm 0.000151\sqrt{L} \text{ ft.}$$

Thus if L is 10,000 feet, we would have

$$r_L = \pm 0.000151 \times \sqrt{10000} = \pm 0.0151 \text{ ft.}$$

And if such a line were measured four times we should have, theoretically, for the probable error of the average length,

$$r_a = \pm 0.0151 \div \sqrt{4} = \pm 0.0076 \text{ ft.}$$

It thus becomes known in advance what probable error is to be expected under the given conditions.

206. The Uncertainty of a Base Line. By the *uncertainty* of a base line is meant the value obtained by dividing its probable error by its length. In accordance with Art. 202, the probable error of a base line varies as the square root of its length, so that the probable error increases much more slowly than the length of the line. On account of the greater opportunity for the compensation of errors, therefore, long lines are relatively more accurate than short lines. While the unit probable error r_0 very satisfactorily indicates the *grade* of accuracy, whether a line be long or short, it does not furnish any idea of the *degree* of accuracy with which the length of a given line is known. The uncertainty of a base line, however, shows at once the precision attained in its measurement. If r_1 be the probable error of a single measurement of a base line whose length is l , then for the uncertainty U_1 of a single measurement, we have

$$U_1 = \frac{r_1}{l};$$

and for the uncertainty U_a of the arithmetic mean of n measurements,

$$U_a = \frac{r_a}{l} = \frac{r_1}{l\sqrt{n}}.$$

But, in accordance with Eq. (93),

$$r_1 = r_0\sqrt{l};$$

whence

$$U_1 = \frac{r_0 \sqrt{l}}{l} = \frac{r_0}{\sqrt{l}},$$

and

$$U_a = \frac{r_0 \sqrt{l}}{l \sqrt{n}} = \frac{r_0}{\sqrt{nl}};$$

so that we may write,

$$U_1 = \frac{r_1}{l} = \frac{r_0}{\sqrt{l}}, \dots \dots \dots (98)$$

and

$$U_a = \frac{r_a}{l} = \frac{r_0}{\sqrt{nl}} \dots \dots \dots (99)$$

Example 1. Three measurements of a base line under the same conditions give $z = 6717.626 \pm 0.0088$ ft. and $r_1 = \pm 0.0152$ ft. What is the uncertainty of a single measurement and also of the arithmetic mean?

$$U_1 = \frac{r_1}{l} = \frac{0.0152}{6717.626} = \frac{1}{441949};$$

$$U_a = \frac{r_a}{l} = \frac{0.0088}{6717.626} = \frac{1}{763366}.$$

Example 2. A base line of 10,000 ft. length is to be measured four times under conditions which make the probable error of a unit length of line equal ± 0.000316 ft. What should be the uncertainty of each measurement and of the average of the four measurements?

$$U_1 = \frac{r_0}{\sqrt{l}} = \frac{0.000316}{\sqrt{10000}} = \frac{1}{316456};$$

$$U_a = \frac{r_0}{\sqrt{nl}} = \frac{0.000316}{\sqrt{40000}} = \frac{1}{632912}.$$

CHAPTER XVI

APPLICATION TO LEVEL WORK

207. Unweighted Measurements. If the difference of elevation of two stations is measured a number of times in the same manner, over the same length of line, and under such conditions that the different determinations may be regarded as of equal weight, then (Art. 155) the arithmetic mean of the several results is the most probable value of this difference of elevation. The probable error of a single measurement (Art. 173) is given by the formula

$$r_1 = 0.6745 \sqrt{\frac{\Sigma v^2}{n-1}}, \quad \dots \dots \dots (100)$$

and the probable error of the arithmetic mean (Art. 173) of n measurements by the formula

$$r_a = \frac{r_1}{\sqrt{n}} = 0.6745 \sqrt{\frac{\Sigma v^2}{n(n-1)}}. \quad \dots \dots (101)$$

Example. Difference of elevation by direct observations of equal weight:

Observed Values	v	v^2
11.501 ft.	+ 0.009	0.000081
11.509 ft.	+ 0.017	0.000289
11.480 ft.	- 0.012	0.000144
11.478 ft.	- 0.014	0.000196
4)45.968 ft.		$\Sigma v^2 = 0.000710$
$z = 11.492$ ft.		$n = 4$

$$r_1 = 0.6745 \sqrt{\frac{0.000710}{3}} = \pm 0.0104 \text{ ft.}$$

$$r_a = \frac{0.0104}{\sqrt{4}} = \pm 0.0052 \text{ ft.}$$

Most probable value = 11.492 \pm 0.0052 ft.

208. Weighted Measurements. If the difference of elevation of two stations is measured a number of times in the same manner, and over the same length of line, but under such conditions that the different determinations must be regarded as of unequal weight, then (Art. 157) the weighted arithmetic mean of the several results is the most probable value of this difference of elevation. The probable error of a single measurement of unit weight (Art. 174) is given by the formula

$$r_1 = 0.6745 \sqrt{\frac{\sum pv^2}{n-1}}, \dots \dots \dots (102)$$

the probable error of any measurement of the weight p (Art. 174) by the formula

$$r_p = \frac{r_1}{\sqrt{p}} = 0.6745 \sqrt{\frac{\sum pv^2}{p(n-1)}}, \dots \dots \dots (103)$$

and the probable error of the weighted arithmetic mean (Art. 174) by the formula

$$r_{pa} = \frac{r_1}{\sqrt{\sum p}} = 0.6745 \sqrt{\frac{\sum pv^2}{\sum p(n-1)}}. \dots \dots (104)$$

Example. Difference of elevation by direct observations of unequal weight:

Observed Values	p	pM	v	v^2	pv^2
17.643 ft.	1	17.643	-0.028	0.000784	0.000784
17.647 ft.	1	17.647	-0.024	0.000576	0.000576
17.679 ft.	2	35.358	+0.008	0.000064	0.000128
17.683 ft.	3	53.049	+0.012	0.000144	0.000432
$\sum p = 7$		123.697		$\sum pv^2 = 0.001920$	
$z =$		17.671		$n = 4$	

$$r_1 = 0.6745 \sqrt{\frac{0.001920}{3}} = \pm 0.0171 \text{ ft.}$$

$$r_2 = \frac{0.0171}{\sqrt{2}} = \pm 0.0121 \text{ ft.}$$

$$r_3 = \frac{0.0171}{\sqrt{3}} = \pm 0.0099 \text{ ft.}$$

$$r_{pa} = \frac{0.0171}{\sqrt{7}} = \pm 0.0064 \text{ ft.}$$

Most probable value = 17.671 ± 0.0064 ft.

209. Duplicate Lines. In precise level work a duplicate line of levels is understood to mean a line which is run twice over the same route with equal care, but in opposite directions. The object of running in opposite directions is to eliminate from the mean result those systematic errors which are liable to occur in leveling, due to a rising or settling of the instrument or turning points during the progress of the work. As explained in Art. 88 the details of the work are so arranged that these errors tend to neutralize each other to a large extent as the work progresses, so that no material error is committed by assuming that the results obtained are affected only by accidental errors. The most probable value for the difference of elevation of any two stations, based on a duplicate line, is equal to the average of the two results furnished by such a line. Letting d represent the discrepancy between the result obtained from the forward line and that obtained from the reverse line, we thus have

$$v_1 = +\frac{d}{2} \quad \text{and} \quad v_2 = -\frac{d}{2}.$$

Substituting these values in Eq. (100) and replacing r_1 with r_l for the case of duplicate lines, we have for the probable error of a single determination (forward or reverse) by a line of the length l ,

$$r_l = 0.4769\sqrt{d^2} = \pm 0.4769l. \quad (105)$$

Substituting the same values in Eq. (101), we have for the probable error of the arithmetic mean of the results obtained by the forward and reverse lines,

$$r_a = \pm 0.3373d; \quad (106)$$

whence

$$r_a \text{ (approximately) } = \pm \frac{1}{3}d. \quad (107)$$

Example. Duplicate line of levels:

Observed Values	
29.648 ft.	$0.4769 \times 0.028 = 0.0134.$
29.676 ft.	$0.3373 \times 0.028 = 0.0094.$
$d = 0.028 \text{ ft.}$	

$$r_l = \pm 0.0134 \text{ ft.} \qquad r_a = \pm 0.0094 \text{ ft.}$$

$$\text{Most probable value} = 29.662 \pm 0.0094 \text{ ft.}$$

210. Sectional Lines. Every line of levels which includes one or more intermediate bench marks may be regarded as made up of a series of sections connecting these bench marks. In general the work will be done by the method of duplicate leveling (Art. 209), so that a value for the difference of elevation of any two successive bench marks (limiting a section) will be obtained from the forward line, and another value from the reverse line. From these two values (Art. 209) we will have a most probable value and a probable error for any given section, which will be independent of all other sections. In whatever manner the leveling may be done, however, the subsequent treatment of the results will be the same, provided the determinations for each section are kept independent. If e_1, e_2, \dots, e_n , be the most probable values for the difference of elevation between the successive bench marks, then (Art. 168) the most probable difference of elevation E between the terminal bench marks, is

$$E = e_1 + e_2 \dots + e_n = \Sigma e. \quad (108)$$

And if r_1, r_2, \dots, r_n , be the probable errors of the several values e_1, e_2 , etc., then (Art. 182) the probable error r_E for the total difference of elevation E , is

$$r_E = \sqrt{r_1^2 + r_2^2 \dots + r_n^2} = \sqrt{\Sigma r^2}. \quad (109)$$

Example. Level work on sectional lines. Given

$$e_1 = 9.116 \pm 0.008 \text{ ft.}$$

$$e_2 = 31.659 \pm 0.031 \text{ ft.}$$

$$e_3 = 22.427 \pm 0.018 \text{ ft.}$$

$$E = 9.116 + 31.659 + 22.427 = 63.202 \text{ ft.}$$

$$r_E = \sqrt{(0.008)^2 + (0.031)^2 + (0.018)^2} = \pm 0.037 \text{ ft.}$$

$$\text{Most probable value } E = 63.202 \pm 0.037 \text{ ft.}$$

211. General Law of the Probable Errors. In measuring the difference of elevation between any two bench marks by passing (in the usual way) through a series of turning points, the case is essentially one of sectional measurement (Art. 210), in which the difference of elevation for each section is measured a single time, and in which under similar conditions the average distance between turning points may be assumed to be the same for any length of line. Running a line of levels is thus entirely analogous

to measuring a base line, and hence the same laws must hold good. In accordance with Art. 202, and without further demonstration, we may therefore write as a

GENERAL LAW: *Under the same conditions of measurement the probable error of a line of levels varies as the square root of its length.*

From the considerations on which this law is based it is evident that it is theoretically true whether the difference of elevation assigned to the terminals of a line is the result of a single measurement, a number of measurements, or a duplicate measurement, so long as the lines being compared are all identical in these details.

Example. A line of levels 10 miles long has a probable error of ± 0.156 ft. What is the theoretical value of the probable error for a line 60 miles long, run under the same conditions?

$$0.156\sqrt{\frac{60}{10}} = 0.156\sqrt{6} = \pm 0.382 \text{ ft.}$$

Theoretical probable error of new line = ± 0.382 ft.

212. The Law of Relative Weight. As explained in the previous article, the laws derived for base-line work are equally applicable to level work. In accordance with Art. 203, and without further demonstration, we may therefore write as a

GENERAL LAW: *Under the same conditions of measurement the weight of the result due to any line of levels varies inversely as the length of the line.*

From the considerations on which this law is based it is evident that it is theoretically true whether the difference of elevation assigned to the terminals of the line is the result of a single measurement, a number of measurements, or a duplicate measurement, so long as the lines being compared are all identical in these details.

If two or more level lines are run under different conditions, they may be first weighted so as to offset this circumstance, and then weighted inversely as their lengths. The relative weight of each line will then be the product of the weights applied to it.

213. Probable Error of a Line of Unit Length. The probable error corresponding to a given line of levels conveys no idea of the precision of the work unless accompanied by the length of the line. It is therefore convenient to reduce the probable error of a line of levels to its corresponding value for a similar line of unit length.

A unit of comparison is thus established for different grades or pieces of work which is independent of the length of the lines. Such a unit has no actual existence, but is purely a mathematical basis of comparison.

As explained in Art. 211, the laws derived for base-line work are equally applicable to level work. In accordance with Art. 204, and without further demonstration, we may therefore write

$$r_L = r_0 \sqrt{L}, \quad (110)$$

in which r_L is the probable error for a given line of levels of the length L , r_0 is the probable error for a unit length of such a line, and in which all the values refer to single measurements. This equation indicates that the probable error of any given line of levels is equal to the square root of its length multiplied by the probable error for a unit length of such a line. If r_0 is well determined for given instruments, conditions, and methods, Eq. (110) informs us in advance what is a suitable probable error for a single line of levels, and hence (Art. 207) for the average result obtained by re-running such a line any number of times. In accordance with this article the probable error in the mean result of a duplicate line is equal to the second member of Eq. (110) divided by $\sqrt{2}$. In any case, therefore, the level party knows whether its work is up to standard, or whether additional measurements are required.

214. Determination of the Numerical Value of the Probable Error of a Line of Unit Length. As explained in Art. 211, the laws and rules for base-line work are equally applicable to level work. The method of Art. 205 is consequently adapted to the present case by running one or more duplicate level lines of moderate length, and noting the length of line (one way) and the discrepancy for each duplicate line. In accordance with Eq. (97), and without further demonstration, we may therefore write

$$r_0 = 0.4769 \sqrt{\frac{\sum pd^2}{n}}, \quad (111)$$

in which r_0 is the probable error in running a single line of levels of unit length, d is the discrepancy in any duplicate line, p is the weight (reciprocal of the one way length) of that line, and n is the number of duplicate lines.

Example. Determination and application of the probable error of a level line of unit length:

Difference of Elevation	d	d^2	l	p	pd^2
16.298 ft.	} 0.016	0.000256	810	$\frac{1}{810}$	0.0000003160
16.314 "					
16.308 ft.	} 0.012	0.000144	810	$\frac{1}{810}$	0.0000001778
16.296 "					
18.540 ft.	} 0.009	0.000081	560	$\frac{1}{560}$	0.0000001446
18.549 "					
18.552 ft.	} 0.010	0.000100	560	$\frac{1}{560}$	0.0000001786
18.542 "					
21.663 ft.	} 0.015	0.000225	782	$\frac{1}{782}$	0.0000003085
21.648 "					
21.661 ft.	} 0.012	0.000144	782	$\frac{1}{782}$	0.0000001841
21.649 "					
21.664 ft.	} 0.014	0.000196	782	$\frac{1}{782}$	0.0000002506
21.650 "					

from which we have

$$\Sigma pd^2 = 0.0000015602 \quad \text{and} \quad n = 7;$$

whence

$$r_0 = 0.4769 \sqrt{\frac{0.0000015602}{7}} = \pm 0.000225 \text{ ft.},$$

which is therefore the probable error in running a single line of levels for a distance of one foot under the given conditions. For a single line of levels of any length L , run under the same conditions, the probable error would be, in accordance with Eq. (110),

$$r_L = r_0 \sqrt{L} = \pm 0.000225 \sqrt{L} \text{ ft.}$$

Thus if L is 10,000 feet, we would have

$$r_L = \pm 0.000225 \sqrt{10000} = \pm 0.0225 \text{ ft.}$$

And if such a line of levels were run four successive times we should have, theoretically, for the probable error of the average difference of elevation,

$$r_a = \pm 0.0225 \div \sqrt{4} = \pm 0.0113 \text{ ft.}$$

It thus becomes known in advance what probable error is to be expected under the given conditions.

215: Multiple Lines. By a *multiple line* of levels is meant a set of two or more lines connecting the same two bench marks by routes of different length. In order to find the most probable value for the difference of elevation between the terminals of a multiple line, it is necessary (Art. 212) to weight each constituent line inversely at its length. If the character of the work requires any of the lines to be also weighted for other causes, then the

final weight of such line must be taken as the product of its individual weights. Having weighted the several lines as thus explained the case becomes identical with any case of weighted measurements (Art. 208), and hence the probable error of a single measurement of unit weight is given by the formula

$$r_1 = 0.6745 \sqrt{\frac{\sum pv^2}{n-1}}, \dots \dots \dots (112)$$

the probable error of any of the lines of the weight p by the formula

$$r_p = \frac{r_1}{\sqrt{p}} = 0.6745 \sqrt{\frac{\sum pv^2}{p(n-1)}}, \dots \dots (113)$$

and the probable error of the weighted arithmetic mean by the formula

$$r_{pa} = \frac{r_1}{\sqrt{\sum p}} = 0.6745 \sqrt{\frac{\sum pv^2}{\sum p(n-1)}} \dots \dots (114)$$

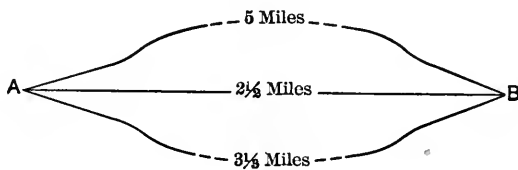

FIG. 86.

Example. Three lines of levels, as shown in Fig. 86, give the following results:

- A to B, 5 mile line, + 95.659 ft.
- A to B, 2½ mile line, + 95.814 ft.
- A to B, 3¼ mile line, + 95.867 ft.

The elevation of A is 416.723 feet. What is the most probable value for the elevation of B, and the probable error of this result?

<i>M</i>	<i>p</i>	<i>pM</i>	<i>v</i>	<i>v</i> ²	<i>pv</i> ²
95.659	0.2	19.1318	- 0.138	0.019044	0.0038088
95.814	0.4	38.3256	+ 0.017	0.000289	0.0001156
95.867	0.3	28.7601	+ 0.070	0.004900	0.0014700
$\Sigma p = 0.9$ 86.2175				$\Sigma pv^2 = 0.0053944$	
95.797				$n = 3$	

$$r_{pa} = 0.6745 \sqrt{\frac{0.0053944}{0.9 \times 2}} = \pm 0.0369 \text{ ft.}$$

$$416.723 + 95.797 = 512.520 \text{ ft.}$$

Most probable value for elevation of B = 512.520 ± 0.0369 ft.

216. Level Nets. When three or more bench marks are interconnected by level lines so as to form a combination of closed rings, the resulting figure is called a *level net*. Fig. 87 represents such a level net, involving nine bench marks. The elevation of any bench mark is necessarily independent of any other bench mark, but the differences between the elevations of adjacent bench marks are not independent quantities, since in any closed circuit their algebraic sum must equal zero. In the given figure there are evidently fifteen observation equations, namely, the observed difference of elevation between *A* and *B*, *B* and *C*, etc. But there are also seven closed rings, *ABCD*, *ADA*,

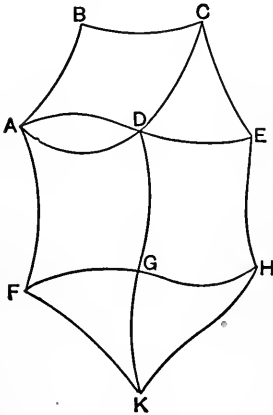

FIG. 87.

etc., forming seven independent conditional equations. Fifteen minus seven leaves eight, so that (Art. 166) there can be but eight independent quantities involved in the fifteen observation equations. The number of independent quantities must evidently be one less than the number of bench marks, since one of these must be assumed as known or fixed, and nine minus one gives eight as before. It sometimes happens that more than one line connects the same two points, as between *A* and *D* in the figure; but this fact makes no difference in the method of computation. Sometimes a point *B*

occurs on a line without being connected with any other point. Such a point has no influence on the adjustments of any other point, and may be included or omitted, as preferred, in making such other adjustments. If omitted in adjusting the other points its own most probable value can be found afterwards by Art. 217.

There are two general methods of making the computations for the adjustments of a level net, each of which may be modified in a number of ways. In the *first* method the most probable values are found for the several *differences* of elevation between the bench marks, the most probable values for the *elevations* of the different bench marks being then found by combining these differences. In the *second* method the computations are arranged so

as to lead *directly* to the most probable values for the *elevations* of the bench marks. In any case each of the connecting lines must be properly weighted. If the lines are all run singly they are weighted inversely as their lengths unless some special condition requires some of these weights to be modified. If all the lines are duplicate lines, the average difference of elevation in each case may be treated as if due to a single line, and weighted inversely as its length. If special conditions exist the weights must be made to correspond. The manner in which each method is worked out is illustrated by the following example.

Example. Referring to the level net indicated in Fig. 88, the field notes show the following results:

A to B	= + 11.841 ft.
B to C	= - 5.496 ft.
C to D	= + 8.207 ft.
D to E	= - 5.720 ft.
E to A	= - 8.515 ft.
B to E	= - 3.218 ft.
C to E	= + 2.619 ft.

The figures on the diagram are the lengths in miles of the various lines. The arrow-heads show the direction in which each line was run. The elevation of the point A is 610.693 ft. What are the most probable values for the elevations of the remaining stations?

First method. As there are but four unknown bench marks (B, C, D, E), there can be but four independent unknowns in the observation equations. As the lines AB, BC, CD, DE, may evidently be selected as the independent unknowns, we may write for the most probable values of the corresponding differences of elevation

A to B	= + 11.841 + v_1 ;
B to C	= - 5.496 + v_2 ;
C to D	= + 8.207 + v_3 ;
D to E	= - 5.720 + v_4 .

The conditional equations involved in the several closed circuits may then be avoided (Art. 165) by writing all the observation equations in terms of these quantities. Writing the reduced observation equations (Art. 163) directly from the figure, we have, by comparison with the observed values,

(A to B)	v_1	=	0.000 (weight 0.4);
(B to C)	v_2	=	0.000 (weight 0.3);
(C to D)	v_3	=	0.000 (weight 0.4);
(D to E)	v_4	=	0.000 (weight 0.3);
(E to A)	$-v_1 - v_2 - v_3 - v_4$	=	+ 0.317 (weight 0.2);
(B to E)	$v_2 + v_3 + v_4$	=	- 0.209 (weight 0.5);
(C to E)	$v_3 + v_4$	=	+ 0.132 (weight 0.5).

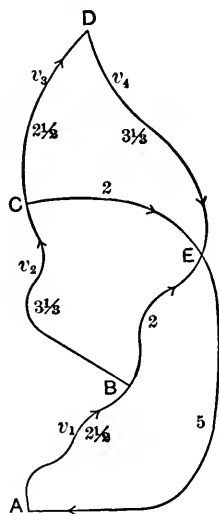

FIG. 88.

As an illustration of how these equations are formed let us consider the observed line CE .

$$\text{Most probable value, } C \text{ to } D = + 8.207 + v_3.$$

$$\text{Most probable value, } D \text{ to } E = - 5.720 + v_4.$$

Hence, by addition,

$$\text{Most probable value, } C \text{ to } E = + 2.487 + v_3 + v_4.$$

$$\text{Observed value, } C \text{ to } E = + 2.619.$$

Hence this observation equation requires

$$v_3 + v_4 = + 0.132.$$

No values of v_1, v_2, v_3, v_4 , can meet the requirements of all the observation equations, and hence to find the most probable values of v_1, v_2, v_3, v_4 , we form the normal equations in the usual way, giving,

$$0.6v_1 + 0.2v_2 + 0.2v_3 + 0.2v_4 = - 0.0634;$$

$$0.2v_1 + 1.0v_2 + 0.7v_3 + 0.7v_4 = - 0.1679;$$

$$0.2v_1 + 0.7v_2 + 1.6v_3 + 1.2v_4 = - 0.1019;$$

$$0.2v_1 + 0.7v_2 + 1.2v_3 + 1.5v_4 = - 0.1019;$$

whose solution gives

$$\begin{aligned} v_1 &= - 0.0556 \text{ ft.}; & v_3 &= + 0.0092 \text{ ft.}; \\ v_2 &= - 0.1718 \text{ ft.}; & v_4 &= + 0.0123 \text{ ft.}; \end{aligned}$$

whence, for the most probable values, we have

$$\begin{array}{ll} A \text{ to } B = + 11.7854 \text{ ft.} & \\ B \text{ to } C = - 5.6678 \text{ ''} & A = 610.693 \text{ ft.} \\ C \text{ to } D = + 8.2162 \text{ ''} & B = 622.478 \text{ ''} \\ D \text{ to } E = - 5.7077 \text{ ''} & C = 616.811 \text{ ''} \\ E \text{ to } A = - 8.6261 \text{ ''} & D = 625.027 \text{ ''} \\ B \text{ to } E = - 3.1593 \text{ ''} & E = 619.319 \text{ ''} \\ C \text{ to } E = + 2.5085 \text{ ''} & \end{array}$$

Second method. In this method we first find approximate values for the unknown elevations by combining the observed values in any convenient way, thus:

$$\begin{array}{ll} A = 610.693 & C = 617.038 \text{ (approx.)} \\ + 11.841 & + 8.207 \\ \hline B = 622.534 \text{ (approx.)} & D = 625.245 \text{ (approx.)} \\ - 5.496 & - 5.720 \\ \hline C = 617.038 \text{ (approx.)} & E = 619.525 \text{ (approx.)} \end{array}$$

and then write, for the most probable values,

$$\begin{aligned} A &= 610.693; \\ B &= 622.534 + v_1; \\ C &= 617.038 + v_2; \\ D &= 625.245 + v_3; \\ E &= 619.525 + v_4. \end{aligned}$$

Substituting these values in the observation equations, we have

$$\begin{aligned} A \text{ to } B &= + 11.841 + v_1 &= + 11.841; \\ B \text{ to } C &= - 5.496 - v_1 + v_2 &= - 5.496; \\ C \text{ to } D &= + 8.207 - v_2 + v_3 &= + 8.207; \\ D \text{ to } E &= - 5.720 - v_3 + v_4 &= - 5.720; \\ E \text{ to } A &= - 8.832 - v_4 &= - 8.815; \\ B \text{ to } E &= - 3.009 - v_1 + v_4 &= - 3.218; \\ C \text{ to } E &= + 2.487 - v_2 + v_4 &= + 2.619. \end{aligned}$$

Reducing and weighting inversely as the distances, we have

$$\begin{aligned} v_1 &= 0.000 \text{ (weight 0.4);} \\ -v_1 + v_2 &= 0.000 \text{ (weight 0.3);} \\ -v_2 + v_3 &= 0.000 \text{ (weight 0.4);} \\ -v_3 + v_4 &= 0.000 \text{ (weight 0.3);} \\ -v_4 &= + 0.317 \text{ (weight 0.2);} \\ -v_1 &+ v_4 = - 0.209 \text{ (weight 0.5);} \\ -v_2 &+ v_4 = + 0.132 \text{ (weight 0.5).} \end{aligned}$$

Forming the normal equations, we have

$$\begin{aligned} 1.2v_1 - 0.3v_2 &- 0.5v_4 = + 0.1045; \\ -0.3v_1 + 1.2v_2 - 0.4v_3 - 0.5v_4 &= - 0.0660; \\ &- 0.4v_2 + 0.7v_3 - 0.3v_4 = 0.0000; \\ -0.5v_1 - 0.5v_2 - 0.3v_3 + 1.5v_4 &= - 0.1019; \end{aligned}$$

whose solution gives

$$\begin{aligned} v_1 &= - 0.0556 \text{ ft.;} & v_3 &= - 0.2182 \text{ ft.;} \\ v_2 &= - 0.2274 \text{ " " } & v_4 &= - 0.2059 \text{ " " } \end{aligned}$$

whence, for the most probable values, we have (as before)

$$\begin{aligned} A &= 610.693 \text{ ft.} \\ B &= 622.478 \text{ " " } \\ C &= 616.811 \text{ " " } \\ D &= 625.027 \text{ " " } \\ E &= 619.319 \text{ " " } \end{aligned}$$

217. Intermediate Points. By an *intermediate point* is meant one lying only on a single line of levels, and hence having no influence on the general adjustment. Thus in Fig. 89 the bench marks A and B are adjusted as a part of the complete level net $ABCDEFGG$. The point I is an intermediate point, having no influence on the general adjustment, but simply lying between the adjusted bench marks A and B . In adjusting level net it is not necessary to separate the intermediate points from the others, as the results will come out the same whether any or all of the intermediate points are omitted or included. The work of compu-

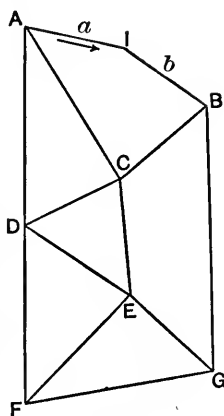

FIG. 89.

tation may be reduced, however, where there are many intermediate points, by adjusting the main system first and the intermediate points afterwards. Referring to Fig. 89, page 355,

Let I be an intermediate point lying between the adjusted bench marks A and B ;

a = the distance A to I ;

b = the distance I to B ;

d = the discrepancy between the line AB as run and the difference between the adjusted values of A and B (+ if the line as run makes B too high);

e = observed change in elevation from A to I ;

e' = observed change in elevation from I to B ;

then

$$A + e + e' = B + d,$$

or

$$e' = B - A - e + d;$$

and

$$I \text{ (observed)} = A + e \quad (\text{weight } b);$$

$$I \text{ (observed)} = B - e' = A + e - d \text{ (weight } a);$$

or, taking the weighted arithmetic mean,

$$\begin{aligned} I \text{ (most probable)} &= \frac{bA + be + aA + ae - ad}{b + a} \\ &= (A + e) - \left(\frac{a}{a + b} \right) d. \quad (115) \end{aligned}$$

As I represents any intermediate point, and a the corresponding distance from the commencement A of the given line, it follows from this equation that the most probable values for any intermediate points are arrived at by adjusting for the discrepancy d in direct proportion to the distances from the initial point A . This law may be otherwise expressed by saying that the discrepancy is to be distributed uniformly along the line on the basis of distance.

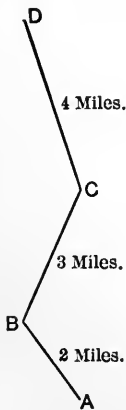

FIG. 90.

Example. In the line of levels indicated in Fig. 90 the field notes show the following changes in elevation:

A to B = + 2.626 ft.

B to C = - 3.483 "

C to D = + 6.915 "

The adjusted elevations at A and D are

$$A = 28.655 \text{ ft.}$$

$$D = 34.317 \text{ ''}$$

What are the most probable elevations of the intermediate points B and C ?

$$\begin{array}{r} 28.655 \\ + 2.626 \\ \hline 31.281 \\ - 3.483 \\ \hline \end{array}$$

$$\text{Discrepancy} = + 0.396 \text{ ft.}$$

$$0.396 \times \frac{2}{5} = 0.088 \text{ ft.}$$

$$\text{Total distance} = 9 \text{ miles.}$$

$$0.396 \times \frac{5}{9} = 0.220 \text{ ft.}$$

	Station	Apparent Elevation	Correction	Adjusted Elevation
27.798	A	28.655	0.000	28.655 ft.
+ 6.915	B	31.281	- 0.088	31.193 ''
34.713	C	27.798	- 0.220	27.578 ''
34.317	D	34.713	- 0.396	34.317 ''
<hr/>				
+ 0.396				

218. Closed Circuits. By a *closed circuit* in level work is meant a line of levels which returns to the initial point, or, in other words, forms a single closed ring. The shape of such a circuit is entirely immaterial, whether approximately circular, narrow and elongated, or irregular in any degree. A level net is in general a combination of closed circuits, but these circuits can not be adjusted separately, as they are not independent. So also if any part of the ring is leveled over more than once it becomes essentially a level net, and must be adjusted accordingly. If, however, the circuit is independent of all other work, and has been run around but once under uniform conditions, it may be adjusted by a simpler process. Referring to Fig. 91,

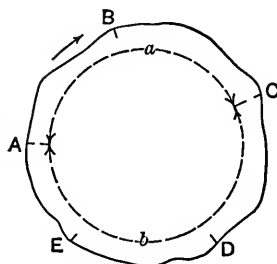

FIG. 91.

Let A, B, C, D, E be the bench marks on an independent closed circuit;

A = the initial bench mark;

a = distance $A-B-C$ to any point C ;

b = distance $C-D-E-A$ back to A ;

d = discrepancy on arriving at A (+ if too high);

e = observed change in elevation from A to C ;

e' = observed change in elevation from C to A ;

then

$$A + e + e' = A + d,$$

or

$$e' = -e + d;$$

and

$$C \text{ (observed)} = A + e \quad (\text{weight } b);$$

$$C \text{ (observed)} = A - e' = A + e - d \quad (\text{weight } a);$$

or, taking the weighted arithmetic mean,

$$\begin{aligned} C \text{ (most probable)} &= \frac{bA + be + aA + ae - ad}{b + a} \\ &= (A + e) - \left(\frac{a}{a + b}\right)d. \quad \dots (116) \end{aligned}$$

As C represents any point in the circuit, and a the corresponding distance from the initial point A , it follows from this equation that the most probable values for the elevations of any points B, C, D, E , etc., are arrived at by adjusting the observed elevations for the discrepancy d directly as the respective distances from the initial point. This law may be otherwise expressed by saying that the discrepancy is to be distributed uniformly around the circuit on the basis of distance.

Example. In the closed line of levels indicated in Fig. 91, page 357, the field notes show the following changes in elevation:

A to B = - 2.176 ft., distance = 3 miles.

B to C = + 6.481 ft., distance = 1 mile.

C to D = - 1.712 ft., distance = 2 miles.

D to E = - 4.820 ft., distance = 2 miles.

E to A = + 2.017 ft., distance = 3 miles.

Given the elevation of A as 47.913 feet, what are the adjusted elevations around the line?

47.913
- 2.176

45.737
+ 6.481

52.218
- 1.712

50.506
- 4.820

45.686
+ 2.017

47.703
47.913

- 0.210

Discrepancy = - 0.210 ft. Total distance = 11 miles.
 $0.210 \times \frac{3}{11} = 0.057$ ft. $0.210 \times \frac{1}{11} = 0.105$ ft.
 $0.210 \times \frac{4}{11} = 0.076$ ft. $0.210 \times \frac{2}{11} = 0.153$ ft.

Station	Apparent Elevation	Correction	Adjusted Elevation
A	47.913	0.000	47.913 ft.
B	45.737	+ 0.057	45.794 "
C	52.218	+ 0.076	52.294 "
D	50.506	+ 0.105	50.611 "
E	45.686	+ 0.153	45.839 "

219. Branch Lines, Circuits, and Nets. Any level line, circuit, or net that is independent of another system except for one common point, is called a *branch system*. Thus in Fig. 92 the dotted lines represent the original system, $ABCD$ a *branch line*, $HKLMN$ a *branch circuit*, and $PRSTV$ a *branch net*. In adjusting the main system the results will be the same whether any or all of the branch systems are included or omitted. If there is much branch work, however, the labor of computation may be reduced by adjusting the main system first and the branch systems afterwards. When the main system is adjusted the elevations of A, H, P , etc., become fixed quantities which must not be disturbed in adjusting the branch systems.

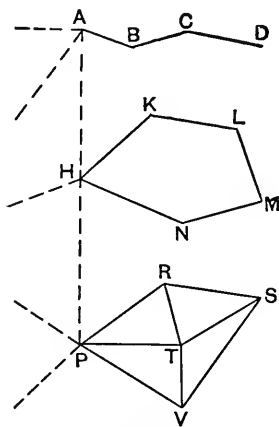

FIG. 92.

TABLES

TABLES

TABLE I.—CURVATURE AND REFRACTION (IN ELEVATION)*

Dis- tance, Miles.	Difference in Feet for			Dis- tance, Miles.	Difference in Feet for		
	Curvature.	Refraction.	Curvature and Refraction.		Curvature.	Refraction.	Curvature and Refraction.
1	0.7	0.1	0.6	34	771.3	108.0	663.3
2	2.7	0.4	2.3	35	817.4	114.4	703.0
3	6.0	0.8	5.2	36	864.8	121.1	743.7
4	10.7	1.5	9.2	37	913.5	127.9	785.6
5	16.7	2.3	14.4	38	963.5	134.9	828.6
6	24.0	3.4	20.6	39	1014.9	142.1	872.8
7	32.7	4.6	28.1	40	1067.6	149.5	918.1
8	42.7	6.0	36.7	41	1121.7	157.0	964.7
9	54.0	7.6	46.4	42	1177.0	164.8	1012.2
10	66.7	9.3	57.4	43	1233.7	172.7	1061.0
11	80.7	11.3	69.4	44	1291.8	180.8	1111.0
12	96.1	13.4	82.7	45	1351.2	189.2	1162.0
13	112.8	15.8	97.0	46	1411.9	197.7	1214.2
14	130.8	18.3	112.5	47	1474.0	206.3	1267.7
15	150.1	21.0	129.1	48	1537.3	215.2	1322.1
16	170.8	23.9	146.9	49	1602.0	224.3	1377.7
17	192.8	27.0	165.8	50	1668.1	233.5	1434.6
18	216.2	30.3	185.9	51	1735.5	243.0	1492.5
19	240.9	33.7	207.2	52	1804.2	252.6	1551.6
20	266.9	37.4	229.5	53	1874.3	262.4	1611.9
21	294.3	41.2	253.1	54	1945.7	272.4	1673.3
22	322.9	45.2	277.7	55	2018.4	282.6	1735.8
23	353.0	49.4	303.6	56	2092.5	292.9	1799.6
24	384.3	53.8	330.5	57	2167.9	303.5	1864.4
25	417.0	58.4	358.6	58	2244.6	314.2	1930.4
26	451.1	63.1	388.0	59	2322.7	325.2	1997.5
27	486.4	68.1	418.3	60	2402.1	336.3	2065.8
28	523.1	73.2	449.9	61	2482.8	347.6	2135.2
29	561.2	78.6	482.6	62	2564.9	359.1	2205.8
30	600.5	84.1	516.4	63	2648.3	370.8	2277.5
31	641.2	89.8	551.4	64	2733.0	382.6	2350.4
32	683.3	95.7	587.6	65	2819.1	394.7	2424.4
33	726.6	101.7	624.9	66	2906.5	406.9	2499.6

* From Appendix No. 9, Report for 1882, United States Coast and Geodetic Survey.

TABLE II.—LOGARITHMS OF THE PUISSANT FACTORS *

(In U. S. Legal Meters)

Lat.	A	B	C	D	E	F
°	- 10	- 10	- 10	- 10	- 20	- 20
20	8.5095499	8.5121555	0.96732	2.1996	5.7574	7.772
21	8.5095330	8.5121049	0.99036	2.2170	5.7711	7.787
22	8.5095155	8.5120524	1.01252	2.2333	5.7851	7.800
23	8.5094973	8.5119979	1.03389	2.2485	5.7997	7.812
24	8.5094786	8.5119416	1.05455	2.2627	5.8146	7.823
25	8.5094592	8.5118834	1.07456	2.2759	5.8300	7.832
26	8.5094392	8.5118236	1.09399	2.2882	5.8458	7.841
27	8.5094187	8.5117620	1.11289	2.2997	5.8620	7.849
28	8.5093977	8.5116989	1.13131	2.3104	5.8785	7.855
29	8.5093761	8.5116342	1.14931	2.3203	5.8955	7.861
30	8.5093541	8.5115682	1.16691	2.3294	5.9127	7.866
31	8.5093316	8.5115007	1.18415	2.3379	5.9304	7.870
32	8.5093087	8.5114321	1.20107	2.3456	5.9484	7.873
33	8.5092854	8.5113622	1.21771	2.3527	5.9667	7.875
34	8.5092618	8.5112912	1.23408	2.3592	5.9853	7.877
35	8.5092378	8.5112192	1.25023	2.3651	6.0043	7.877
36	8.5092135	8.5111463	1.26616	2.3704	6.0237	7.877
37	8.5091889	8.5110725	1.28192	2.3750	6.0433	7.876
38	8.5091640	8.5109980	1.29752	2.3792	6.0633	7.874
39	8.5091390	8.5109228	1.31298	2.3827	6.0836	7.872
40	8.5091137	8.5108470	1.32832	2.3857	6.1043	7.869
41	8.5090883	8.5107708	1.34357	2.3882	6.1253	7.864
42	8.5090628	8.5106942	1.35874	2.3901	6.1467	7.860
43	8.5090372	8.5106173	1.37385	2.3914	6.1684	7.854
44	8.5090115	8.5105402	1.38893	2.3923	6.1905	7.848
45	8.5089857	8.5104630	1.40399	2.3926	6.2130	7.840
46	8.5089600	8.5103858	1.41905	2.3924	6.2359	7.832
47	8.5089343	8.5103087	1.43413	2.3917	6.2592	7.824
48	8.5089086	8.5102317	1.44925	2.3904	6.2830	7.814
49	8.5088831	8.5101551	1.46442	2.3886	6.3071	7.804
50	8.5088576	8.5100788	1.47967	2.3862	6.3318	7.792
51	8.5088324	8.5100029	1.49501	2.3833	6.3569	7.780
52	8.5088073	8.5099276	1.51047	2.3799	6.3826	7.767
53	8.5087824	8.5098530	1.52607	2.3759	6.4088	7.753
54	8.5087577	8.5097791	1.54182	2.3713	6.4355	7.738
55	8.5087334	8.5097060	1.55776	2.3661	6.4629	7.723
56	8.5087093	8.5096338	1.57390	2.3603	6.4909	7.706
57	8.5086856	8.5095626	1.59027	2.3539	6.5196	7.688
58	8.5086622	8.5094925	1.60691	2.3469	6.5490	7.669
59	8.5086393	8.5094236	1.62383	2.3392	6.5792	7.649
60	8.5086167	8.5093560	1.64108	2.3309	6.6102	7.627
61	8.5085946	8.5092897	1.65868	2.3218	6.6422	7.605
62	8.5085730	8.5092248	1.67667	2.3120	6.6750	7.581
63	8.5085519	8.5091614	1.69509	2.3014	6.7089	7.556
64	8.5085313	8.5090996	1.71399	2.2901	6.7440	7.529
65	8.5085112	8.5090395	1.73342	2.2778	6.7802	7.501
66	8.5084917	8.5089811	1.75343	2.2647	6.8177	7.471
67	8.5084729	8.5089245	1.77409	2.2506	6.8567	7.440
68	8.5084546	8.5088698	1.79546	2.2354	6.8972	7.406
69	8.5084370	8.5088170	1.81762	2.2192	6.9395	7.371

* Based on tables in App. No. 9, Report for 1894, U. S. Coast and Geodetic Survey.

TABLE II.—LOGARITHMS OF THE PUISSANT FACTORS—
(Continued)Log $G = \log \text{diff. for } (\log \Delta \lambda) - \log \text{diff. for } (\log s)$

log s	log difference.	log $\Delta \lambda$	log s	log difference.	log $\Delta \lambda$
3.876	0.0000001	2.385	4.922	0.0000124	3.431
4.026	002	2.535	4.932	130	3.441
4.114	003	2.623	4.941	136	3.450
4.177	004	2.686	4.950	142	3.459
4.225	005	2.734	4.959	147	3.468
4.265	006	2.774	4.968	153	3.477
4.298	007	2.807	4.976	160	3.485
4.327	008	2.836	4.985	166	3.494
4.353	009	2.862	4.993	172	3.502
4.376	010	2.885	5.002	179	3.511
4.396	011	2.905	5.010	186	3.519
4.415	012	2.924	5.017	192	3.526
4.433	013	2.942	5.025	199	3.534
4.449	014	2.958	5.033	206	3.542
4.464	015	2.973	5.040	213	3.549
4.478	016	2.987	5.047	221	3.556
4.491	017	3.000	5.054	228	3.563
4.503	018	3.012	5.062	236	3.571
4.526	020	3.035	5.068	243	3.577
4.548	023	3.057	5.075	251	3.584
4.570	025	3.079	5.082	259	3.591
4.591	027	3.100	5.088	267	3.597
4.612	030	3.121	5.095	275	3.604
4.631	033	3.140	5.102	284	3.611
4.649	036	3.158	5.108	292	3.617
4.667	039	3.176	5.114	300	3.623
4.684	042	3.193	5.120	309	3.629
4.701	045	3.210	5.126	318	3.635
4.716	048	3.225	5.132	327	3.641
4.732	052	3.241	5.138	336	3.647
4.746	056	3.255	5.144	345	3.653
4.761	059	3.270	5.150	354	3.659
4.774	063	3.283	5.156	364	3.665
4.788	067	3.297	5.161	373	3.670
4.801	071	3.310	5.167	383	3.676
4.813	075	3.322	5.172	392	3.681
4.825	080	3.334	5.178	402	3.687
4.834	084	3.343	5.183	412	3.692
4.849	089	3.358	5.188	422	3.697
4.860	094	3.369	5.193	433	3.702
4.871	098	3.380	5.199	443	3.708
4.882	103	3.391	5.204	453	3.713
4.892	108	3.401	5.209	464	3.718
4.903	114	3.412	5.214	474	3.723
4.913	119	3.422	5.219	486	3.728

NOTE.—The logarithms in the above table require s to be expressed in meters and $\Delta \lambda$ in seconds of arc. If s is expressed in feet its logarithm must be reduced by 0.516 before using in this table.

TABLE III.—BAROMETRIC ELEVATIONS *

Containing $H = 62737 \log \frac{30}{B}$.

B.	H.	Dif. for .01.	B.	H.	Dif. for .01.	B.	H.	Dif. for .01.
Inches.	Feet.	Feet.	Inches.	Feet.	Feet.	Inches.	Feet.	Feet.
11.0	27,336	-24.6	14.0	20,765	-19.5	17.0	15,476	-16.0
11.1	27,090	24.4	14.1	20,570	19.3	17.1	15,316	15.9
11.2	26,846	24.2	14.2	20,377	19.1	17.2	15,157	15.8
11.3	26,604	24.0	14.3	20,186	18.9	17.3	14,999	15.7
11.4	26,364	23.8	14.4	19,997	18.8	17.4	14,842	15.6
11.5	26,126	23.6	14.5	19,809	18.6	17.5	14,686	15.5
11.6	25,890	23.4	14.6	19,623	18.6	17.6	14,531	15.4
11.7	25,656	23.2	14.7	19,437	18.5	17.7	14,377	15.4
11.8	25,424	23.0	14.8	19,252	18.4	17.8	14,223	15.3
11.9	25,194	22.8	14.9	19,068	18.2	17.9	14,070	15.2
12.0	24,966	22.6	15.0	18,886	18.1	18.0	13,918	15.1
12.1	24,740	22.4	15.1	18,705	18.0	18.1	13,767	15.0
12.2	24,516	22.2	15.2	18,525	17.9	18.2	13,617	14.9
12.3	24,294	22.1	15.3	18,346	17.8	18.3	13,468	14.9
12.4	24,073	21.9	15.4	18,168	17.6	18.4	13,319	14.7
12.5	23,854	21.7	15.5	17,992	17.5	18.5	13,172	14.7
12.6	23,637	21.6	15.6	17,817	17.4	18.6	13,025	14.6
12.7	23,421	21.4	15.7	17,643	17.3	18.7	12,879	14.6
12.8	23,207	21.2	15.8	17,470	17.2	18.8	12,733	14.4
12.9	22,995	21.0	15.9	17,298	17.1	18.9	12,589	14.4
13.0	22,785	20.9	16.0	17,127	16.9	19.0	12,445	14.3
13.1	22,576	20.8	16.1	16,958	16.9	19.1	12,302	14.2
13.2	22,368	20.6	16.2	16,789	16.8	19.2	12,160	14.2
13.3	22,162	20.4	16.3	16,621	16.7	19.3	12,018	14.1
13.4	21,958	20.1	16.4	16,454	16.6	19.4	11,877	14.0
13.5	21,757	20.0	16.5	16,288	16.4	19.5	11,737	13.9
13.6	21,557	19.9	16.6	16,124	16.3	19.6	11,598	13.9
13.7	21,358	19.8	16.7	15,961	16.3	19.7	11,459	13.8
13.8	21,160	19.8	16.8	15,798	16.2	19.8	11,321	13.7
13.9	20,962	-19.7	16.9	15,636	-16.0	19.9	11,184	-13.7
14.0	20,765		17.0	15,476		20.0	11,047	

* From Appendix No. 10, Report for 1881, United States Coast and Geodetic Survey.

TABLE III.—BAROMETRIC ELEVATIONS—(Continued)

Containing $H = 62737 \log \frac{30}{B}$.

B.	H.	Dif. for .01.	B.	H.	Dif. for .01.	B.	H.	Dif. for .01.
Inches.	Feet.	Feet.	Inches.	Feet.	Feet.	Inches.	Feet.	Feet.
20.0	11,047	-13.6	23.0	7,239	-11.8	26.0	3,899	-10.5
20.1	10,911	13.5	23.1	7,121	11.7	26.1	3,794	10.4
20.2	10,776	13.4	23.2	7,004	11.7	26.2	3,690	10.4
20.3	10,642	13.4	23.3	6,887	11.7	26.3	3,586	10.3
20.4	10,508	13.3	23.4	6,770	11.6	26.4	3,483	10.3
20.5	10,375	13.3	23.5	6,654	11.6	26.5	3,380	10.3
20.6	10,242	13.2	23.6	6,538	11.5	26.6	3,277	10.2
20.7	10,110	13.1	23.7	6,423	11.5	26.7	3,175	10.2
20.8	9,979	13.1	23.8	6,308	11.4	26.8	3,073	10.1
20.9	9,848	13.0	23.9	6,194	11.4	26.9	2,972	10.1
21.0	9,718	12.9	24.0	6,080	11.3	27.0	2,871	10.1
21.1	9,589	12.9	24.1	5,967	11.3	27.1	2,770	10.0
21.2	9,460	12.8	24.2	5,854	11.3	27.2	2,670	10.0
21.3	9,332	12.8	24.3	5,741	11.2	27.3	2,570	10.0
21.4	9,204	12.7	24.4	5,629	11.1	27.4	2,470	9.9
21.5	9,077	12.6	24.5	5,518	11.1	27.5	2,371	9.9
21.6	8,951	12.6	24.6	5,407	11.1	27.6	2,272	9.9
21.7	8,825	12.5	24.7	5,296	11.0	27.7	2,173	9.8
21.8	8,700	12.5	24.8	5,186	10.9	27.8	2,075	9.8
21.9	8,575	12.4	24.9	5,077	10.9	27.9	1,977	9.7
22.0	8,451	12.4	25.0	4,968	10.9	28.0	1,880	9.7
22.1	8,327	12.3	25.1	4,859	10.8	28.1	1,783	9.7
22.2	8,204	12.2	25.2	4,751	10.8	28.2	1,686	9.7
22.3	8,082	12.2	25.3	4,643	10.8	28.3	1,589	9.6
22.4	7,960	12.2	25.4	4,535	10.7	28.4	1,493	9.6
22.5	7,838	12.1	25.5	4,428	10.7	28.5	1,397	9.5
22.6	7,717	12.0	25.6	4,321	10.6	28.6	1,302	9.5
22.7	7,597	12.0	25.7	4,215	10.6	28.7	1,207	9.5
22.8	7,477	11.9	25.8	4,109	10.5	28.8	1,112	9.4
22.9	7,358	-11.9	25.9	4,004	-10.5	28.9	1,018	-9.4
23.0	7,239		26.0	3,899		29.0	924	

TABLE III.—BAROMETRIC ELEVATIONS—*Continued*Containing $H = 62737 \log \frac{30}{B}$.

B.	H.	Dif. for .01.	B.	H.	Dif. for .01.	B.	H.	Dif. for .01.
Inches.	Feet.	Feet.	Inches.	Feet.	Feet	Inches.	Feet.	Feet.
29.0	924	-9.4	29.7	274	-9.2	30.4	-361	-9.0
29.1	830	9.4	29.8	182	9.1	30.5	451	8.9
29.2	736	9.3	29.9	91	9.1	30.6	540	8.9
29.3	643	9.3	30.0	00	9.1	30.7	629	8.8
29.4	550	9.2	30.1	- 91	9.0	30.8	717	8.8
29.5	458	9.2	30.2	181	9.0	30.9	805	-8.8
29.6	366	-9.2	30.3	271	-9.0	31.0	-893	
29.7	274		30.4	-361				

TABLE IV.—CORRECTION COEFFICIENTS TO BAROMETRIC ELEVATIONS FOR TEMPERATURE (FAHRENHEIT) AND HUMIDITY *

$t+t'$	C	$t+t'$	C	$t+t'$	C
0°	-0.1025	60°	-0.0380	120°	+0.0262
5	-0.0970	65	-0.0326	125	+0.0315
10	-0.0915	70	-0.0273	130	+0.0368
15	-0.0860	75	-0.0220	135	+0.0420
20	-0.0806	80	-0.0166	140	+0.0472
25	-0.0752	85	-0.0112	145	+0.0524
30	-0.0698	90	-0.0058	150	+0.0575
35	-0.0645	95	-0.0004	155	+0.0626
40	-0.0592	100	+0.0049	160	+0.0677
45	-0.0539	105	+0.0102	165	+0.0728
50	-0.0486	110	+0.0156	170	+0.0779
55	-0.0433	115	+0.0209	175	+0.0829
60	-0.0380	120	+0.0262	180	+0.0879

* Based on Tables I and IV, Appendix No. 10, Report for 1881, United States Coast and Geodetic Survey.

TABLE V.—LOGARITHMS OF RADIUS OF CURVATURE
(In U. S. Legal Meters)

Azimuth.			Latitude.				
			24°	26°	28°	30°	32°
0°	180°	Meridian	6.802484	6.802602	6.802726	6.802857	6.802993
5	175	185° 355°	2503	2620	2744	2874	3009
10	170	190 350	2558	2674	2796	2924	3057
15	165	195 345	2649	2761	2880	3005	3135
20	160	200 340	2771	2880	2995	3116	3241
30	150	210 330	3098	3197	3301	3410	3523
40	140	220 320	3501	3585	3676	3771	3869
50	130	230 310	6.803928	6.803999	6.804075	6.804155	6.804238
60	120	240 300	4330	4389	4451	4517	4585
70	110	250 290	4658	4707	4758	4812	4868
75	105	255 285	4781	4827	4874	4923	4974
80	100	260 280	4872	4914	4958	5004	5052
85	95	265 275	4928	4968	5011	5054	5101
90	Prime Vert.	270	4947	4986	5028	5071	5117
			34°	36°	38°	40°	42°
0°	180°	Meridian	6.803134	6.803279	6.803427	6.803578	6.803731
5	175	185° 355°	3150	3294	3441	3591	3744
10	170	190 350	3195	3337	3483	3631	3780
15	165	195 345	3270	3409	3551	3695	3840
20	160	200 340	3371	3505	3642	3781	3922
30	150	210 330	3641	3762	3885	4011	4138
40	140	220 320	3972	4077	4184	4294	4405
50	130	230 310	6.804324	6.804412	6.804503	6.804595	6.804688
60	120	240 300	4655	4728	4802	4878	4954
70	110	250 290	4926	4985	5046	5109	5171
75	105	255 285	5027	5081	5138	5195	5253
80	100	260 280	5102	5153	5206	5259	5313
85	95	265 275	5148	5197	5247	5299	5350
90	Prime Vert.	270	5164	5212	5261	5312	5363
			44°	46°	48°	50°	52°
0°	180°	Meridian	6.803885	6.804040	6.804194	6.804347	6.804498
5	175	185° 355°	3897	4050	4204	4356	4506
10	170	190 350	3931	4082	4233	4383	4531
15	165	195 345	3987	4135	4282	4428	4573
20	160	200 340	4064	4206	4348	4489	4629
30	150	210 330	4267	4396	4524	4652	4778
40	140	220 320	4516	4628	4740	4851	4960
50	130	230 310	6.804782	6.804876	6.804970	6.805063	6.805155
60	120	240 300	5030	5109	5186	5262	5338
70	110	250 290	5234	5298	5362	5425	5487
75	105	255 285	5312	5369	5428	5486	5543
80	100	260 280	5368	5422	5477	5531	5584
85	95	265 275	5402	5455	5507	5559	5610
90	Prime Vert.	270	5414	5465	5517	5568	5618

TABLE VI.—LOGARITHMS OF RADIUS OF CURVATURE
 (In feet)

Azimuth.			Latitude.				
			28°	30°	32°	34°	36°
0°	180°	Meridian	7.318711	7.318841	7.318978	7.319118	7.319263
5	175	185° 355°	8728	8858	8993	9134	9278
10	170	190 350	8780	8908	9041	9179	9321
15	165	195 345	8864	8989	9119	9254	9393
20	160	200 340	8979	9100	9225	9355	9489
30	150	210 330	9285	9394	9507	9625	9746
40	140	220 320	9660	9755	9853	9956	320061
50	130	230 310	7.320059	7.320139	7.320222	7.320308	7.320396
60	120	240 300	0435	0501	0569	0639	0712
70	110	250 290	0742	0796	0852	0910	0969
75	105	255 285	0858	0907	0958	1011	1065
80	100	260 280	0942	0988	1036	1086	1137
85	95	265 275	0995	1038	1085	1132	1181
90	Prime Vert.	270	1012	1055	1101	1148	1196
			38°	40°	42°	44°	46°
0°	180°	Meridian	7.319412	7.319562	7.319715	7.319869	7.320024
5	175	185° 355°	9425	9575	9728	9881	0034
10	170	190 350	9467	9615	9764	9915	0066
15	165	195 345	9535	9679	9824	9971	0119
20	160	200 340	9626	9765	9906	320048	0190
30	150	210 330	9869	9995	320122	0251	0380
40	140	220 320	320168	320278	0389	0500	0612
50	130	230 310	7.320487	7.320579	7.320672	7.320766	7.320860
60	120	240 300	0786	0862	0938	1014	1093
70	110	250 290	1030	1093	1155	1218	1282
75	105	255 285	1122	1179	1237	1296	1353
80	100	260 280	1190	1243	1297	1352	1406
85	95	265 275	1231	1283	1334	1386	1439
90	Prime Vert.	270	1246	1296	1347	1398	1449

 TABLE VII.—CORRECTIONS FOR CURVATURE AND REFRACTION
 IN PRECISE SPIRIT LEVELING

Distance.	Correction to Rod Reading.	Distance.	Correction to Rod Reading.	Distance.	Correction to Rod Reading.
Meters	mm.	Meters.	mm.	Meters.	mm.
0 to 27	0.0	100	-0.68	200	-2.73
28 to 47	-0.1	110	-0.83	210	-3.01
48 to 60	-0.2	120	-0.98	220	-3.31
61 to 72	-0.3	130	-1.15	230	-3.61
73 to 81	-0.4	140	-1.34	240	-3.94
82 to 90	-0.5	150	-1.54	250	-4.27
91 to 98	-0.6	160	-1.75	260	-4.62
99 to 105	-0.7	170	-1.97	270	-4.98
106 to 112	-0.8	180	-2.21	280	-5.36
113 to 118	-0.9	190	-2.47	290	-5.75

TABLE VIII.—MEAN ANGULAR REFRACTION

Apparent Altitude.		Refraction.		Apparent Altitude.		Refraction.		Apparent Altitude.		Refraction.		Apparent Zenith Distance.	
°	'	'	"	°	'	"	°	'	"	°	'	"	°
0	00	34	54.1	10	5	16.2	50	0	48.4	40			
	10	32	49.2	11	4	48.5	51	0	46.7	39			
	20	30	52.3	12	4	25.0	52	0	45.1	38			
	30	29	03.5	13	4	04.9	53	0	43.5	37			
	40	27	22.7	14	3	47.4	54	0	41.9	36			
	50	25	49.8										
1	00	24	24.6	15	3	32.1	55	0	40.4	35			
	10	23	06.7	16	3	18.6	56	0	38.9	34			
	20	21	55.6	17	3	06.6	57	0	37.5	33			
	30	20	50.9	18	2	55.8	58	0	36.1	32			
	40	19	51.9	19	2	46.1	59	0	34.7	31			
	50	18	58.0	20	2	37.3	60	0	33.3	30			
2	00	18	08.6	21	2	29.3	61	0	32.0	29			
	10	17	23.0	22	2	21.9	62	0	30.7	28			
	20	16	40.7	23	2	15.2	63	0	29.4	27			
	30	16	00.9	24	2	08.9	64	0	28.2	26			
	40	15	23.4	25	2	03.2	65	0	26.9	25			
	50	14	47.8	26	1	57.8	66	0	25.7	24			
3	00	14	14.6	27	1	52.8	67	0	24.5	23			
	10	13	43.7	28	1	48.2	68	0	23.3	22			
	20	13	15.0	29	1	43.8	69	0	22.2	21			
	30	12	48.3	30	1	39.7	70	0	21.0	20			
	40	12	23.7	31	1	35.8	71	0	19.9	19			
	50	12	00.7	32	1	32.1	72	0	18.8	18			
4	00	11	38.9	33	1	28.7	73	0	17.7	17			
	10	11	18.3	34	1	25.4	74	0	16.6	16			
	20	10	58.6	35	1	22.3	75	0	15.5	15			
	30	10	39.6	36	1	19.3	76	0	14.5	14			
	40	10	21.2	37	1	16.5	77	0	13.4	13			
	50	10	03.3	38	1	13.8	78	0	12.3	12			
5	00	9	46.5	39	1	11.2	79	0	11.2	11			
	30	9	01.9	40	1	08.7	80	0	10.2	10			
6	00	8	23.3	41	1	06.3	81	0	09.1	9			
	30	7	49.5	42	1	04.0	82	0	08.1	8			
7	00	7	19.7	43	1	01.8	83	0	07.1	7			
	30	6	53.3	44	0	59.7	84	0	06.1	6			
8	00	6	29.6	45	0	57.7	85	0	05.1	5			
	30	6	08.4	46	0	55.7	86	0	04.1	4			
9	00	5	49.3	47	0	53.8	87	0	03.0	3			
	30	5	32.0	48	0	51.9	88	0	02.0	2			
				49	0	50.2	89	0	01.0	1			
				50	0	48.4	90	0	00.0	0			

TABLE IX.—ELEMENTS OF MAP PROJECTIONS

Lat. ϕ	Logarithms (U. S. Legal Meters).			1° in Meters.		Logarithm ($1 - e^2 \sin^2 \phi$). (-10)
	R	N	r	Latitude. ($\phi - 30'$ to $\phi + 30'$)	Longitude. (On Par. of Latitude.)	
20°	6.8022696	6.8048752	6.7778610	110700	104650	9.9996560
22	3727	9096	.7720755	726	103265	5873
24	4835	9465	.7656767	754	101755	5134
26	6015	9859	.7586461	785	100121	4347
28	7262	6.8050274	.7509623	816	98365	3516
30	6.8028569	6.8050710	6.7426016	110850	96489	9.9992645
32	9930	1164	.7335369	884	94496	1738
34	6.8031339	1633	.7237375	920	92388	0798
36	2788	2116	.7131692	957	90167	9.9989832
38	4271	2611	.7017932	995	87836	8843
40	6.8035781	6.8053114	6.6895654	111034	85397	9.9987837
42	7309	3623	.6764358	073	82854	6818
44	8849	4136	.6623477	112	80209	5792
46	6.8040393	4651	.6472364	152	77466	4762
48	1934	5165	.6310274	191	74629	3735
50	6.8043463	6.8055675	6.6136350	111231	71699	9.9982715
52	4975	6178	.5949598	269	68681	1708
54	6460	6674	.5748861	307	65579	0717
56	7913	7158	.5532775	345	62396	9.9979749
58	9326	7629	.5299726	381	59136	8807
60	6.8050691	6.8058084	6.5047784	111416	55803	9.9977897

Lat. ϕ	Element of Tangent Cone.	Coordinates of Developed Arcs.					
		x			y		
		for 1° of Long.		for n° of Long.	for 1° of Long.		for n°.
		Miles.	Meters.	Value for (1°) ×	Miles.	Meters.	(1°) ×
20°	10893	65.03	104649	$n \cdot \cos (0.197n^\circ)$	0.1941	312.3	n^2
22	9814	64.17	103264	$n \cdot \cos (0.216n^\circ)$	0.2098	337.6	n^2
24	8907	63.23	101754	$n \cdot \cos (0.235n^\circ)$	0.2244	361.2	n^2
26	8131	62.21	100120	$n \cdot \cos (0.253n^\circ)$	0.2380	383.0	n^2
28	7459	61.12	98364	$n \cdot \cos (0.271n^\circ)$	0.2504	403.0	n^2
30	6870	59.95	96488	$n \cdot \cos (0.288n^\circ)$	0.2616	421.0	n^2
32	6349	58.72	94495	$n \cdot \cos (0.305n^\circ)$	0.2715	437.0	n^2
34	5882	57.41	92386	$n \cdot \cos (0.322n^\circ)$	0.2801	450.8	n^2
36	5461	56.03	90165	$n \cdot \cos (0.339n^\circ)$	0.2874	462.5	n^2
38	5079	54.58	87834	$n \cdot \cos (0.355n^\circ)$	0.2932	471.9	n^2
40	4730	53.06	85395	$n \cdot \cos (0.371n^\circ)$	0.2976	479.0	n^2
42	4408	51.48	82852	$n \cdot \cos (0.386n^\circ)$	0.3006	483.8	n^2
44	4111	49.84	80207	$n \cdot \cos (0.400n^\circ)$	0.3021	486.2	n^2
46	3834	48.13	77464	$n \cdot \cos (0.414n^\circ)$	0.3022	486.3	n^2
48	3575	46.37	74627	$n \cdot \cos (0.428n^\circ)$	0.3007	484.0	n^2
50	3332	44.55	71697	$n \cdot \cos (0.441n^\circ)$	0.2978	479.3	n^2
52	3103	42.68	68679	$n \cdot \cos (0.454n^\circ)$	0.2935	472.3	n^2
54	2886	40.75	65577	$n \cdot \cos (0.466n^\circ)$	0.2877	463.0	n^2
56	2679	38.77	62394	$n \cdot \cos (0.478n^\circ)$	0.2805	451.4	n^2
58	2483	36.74	59134	$n \cdot \cos (0.489n^\circ)$	0.2719	437.6	n^2
60	2294	34.67	55801	$n \cdot \cos (0.499n^\circ)$	0.2620	421.7	n^2

TABLE X.—CONSTANTS AND THEIR LOGARITHMS

General Constants.	Number.	Logarithm.	
π	3.141592654	0.4971498727	
$\frac{1}{\pi}$	0.318309886	9.5028501273	-10
π^2	9.869604401	0.9942997454	
$\frac{1}{\pi^2}$	0.101321184	9.0057002546	-10
$\sqrt{\pi}$	1.772453851	0.2485749363	
$\frac{1}{\sqrt{\pi}}$	0.564189584	9.7514250637	-10
Degrees in a radian	57.29577951	1.7581226324	
Minutes in a radian	3437.746771	3.5362738828	
Seconds in a radian	206264.8062	5.3144251332	
Arc 1°	0.017453293	8.2418773676	-10
Sin 1°	0.017452406	8.2418553184	-10
Arc 1'	0.000290888	6.4637261172	-10
Sin 1'	0.000290888	6.4637261109	-10
Arc 1''	0.000004848	4.6855748668	-10
Sin 1''	0.000004848	4.6855748668	-10
Base of natural logarithms (<i>e</i>)	2.718281828	0.4342944819	
Modulus of common logarithms (<i>M</i>)	0.434294482	9.6377843113	-10
Common log <i>x</i> + natural log <i>x</i>	0.434294482	9.6377843113	-10
Natural log <i>x</i> + common log <i>x</i>	2.302585093	0.3622156887	
1 Clarke meter = 3.2808693 ft.	3.2808693..	0.5159889297	
1 U. S. legal meter = 3.2808333 + ft.	3.280833333	0.5159841687	
1 kilometer = five-eighths mile, nearly ...	0.621369949	9.7933502462	-10
1 statute mile = 1609 + meters	1609.347219	3.2066497538	
Probable error function <i>hr</i>	0.4769363..	9.6784604...	-10
Probable error constant <i>hr</i> $\sqrt{2}$	0.6744897..	9.8289754...	-10
Geodetic Constants. (Clarke's 1866 Spheroid.)		Logarithms.	
	U. S. Legal Meters.	Feet.	
Semi-major axis = <i>a</i>	6.8047033	7.3206875	
Semi-minor axis = <i>b</i> = <i>a</i> $\sqrt{1 - e^2}$	6.8032285	7.3192127	
Ratio of axes = 293.98 + 294.98	9.9985252	9.9985252	-10
Mean radius	6.8039665	7.3199507	
Ellipticity = $\frac{a-b}{a} = \epsilon$	7.5302093	7.5302093	-10
Eccentricity = $\sqrt{\frac{a^2 - b^2}{a^2}} = e$	8.9152513	8.9152513	-10
(Eccentricity) ² = $\frac{a^2 - b^2}{a^2} = e^2$	7.8305026	7.8305026	-10
$\frac{b^2}{a^2} = 1 - e^2$	9.9970504	9.9970504	-10
$\frac{b}{a} = a(1 - e^2)$	6.8017537	7.3177379	
$\frac{a^2}{b} = \frac{a}{\sqrt{1 - e^2}}$	6.8061781	7.3221623	

BIBLIOGRAPHY

REFERENCES ON GEODETIC SURVEYING

- Adjustment of Observations, Wright and Hayford. D. Van Nostrand & Co., New York, 1904.
- Elements of Geodesy, Gore. John Wiley & Sons, New York, 1893.
- Gillespie's Higher Surveying, Staley. D. Appleton & Co., New York, 1897.
- Johnson's Theory and Practice of Surveying, Smith. John Wiley & Sons, New York, 1910.
- Manual of Spherical and Practical Astronomy, Chauvenet. J. B. Lippincott & Co., Philadelphia, 1885.
- Practical Astronomy as Applied to Geodesy and Navigation, Doolittle. John Wiley & Sons, New York, 1893.
- Precise Surveying and Geodesy, Merriman. John Wiley & Sons, New York, 1899.
- Principles and Practice of Surveying, Breed and Hosmer. John Wiley & Sons, New York, 1906.
- Text Book of Field Astronomy for Engineers, Comstock. John Wiley & Sons, New York, 1902.
- Text Book of Geodetic Astronomy, Hayford. John Wiley & Sons, New York, 1898.
- Text Book on Geodesy and Least Squares, Crandall. John Wiley & Sons, New York, 1907.
- Geodesic Night Signals, Appendix No. 8, Report for 1880, U. S. Coast and Geodetic Survey.
- Field Work of the Triangulation, Appendix No. 9, Report for 1882, U. S. Coast and Geodetic Survey.
- Observing Tripods and Scaffolds, Appendix No. 10, Report for 1882, U. S. Coast and Geodetic Survey.
- Geodetic Reconnaissance, Appendix No. 10, Report for 1885, U. S. Coast and Geodetic Survey.
- Relation of the Yard to the Meter, Appendix No. 16, Report for 1890, U. S. Coast and Geodetic Survey.
- Fundamental Standards of Length and Mass, Appendix No. 6, Report for 1893, U. S. Coast and Geodetic Survey.
- Perfected Form of Base Apparatus, Appendix No. 17, Report for 1880, U. S. Coast and Geodetic Survey.

- Description of a Compensating Base Apparatus, Appendix No. 7, Report for 1882, U. S. Coast and Geodetic Survey.
- The Eimbeck Duplex Base-bar, Appendix No. 11, Report for 1897, U. S. Coast and Geodetic Survey.
- Measurement of Base Lines (J. J. J. Method) with Steel Tapes and with Steel and Brass Wires, Appendix No. 5, Report for 1893, U. S. Coast and Geodetic Survey.
- Measurement of Base Lines with Steel and Invar Tapes, Appendix No. 4, Report for 1907, U. S. Coast and Geodetic Survey.
- Run of the Micrometer, Appendix No. 8, Report for 1884, U. S. Coast and Geodetic Survey.
- Synthetic Adjustment of Triangulation Systems, Appendix No. 12, Report for 1892, U. S. Coast and Geodetic Survey.
- Formulas and Tables for the Computation of Geodetic Positions, Appendix No. 9, Report for 1894, and Appendix No. 4, Report for 1901, U. S. Coast and Geodetic Survey.
- Barometric Hypsometry, Appendix No. 10, Report for 1881, U. S. Coast and Geodetic Survey.
- Transcontinental Line of Leveling in the United States, Appendix No. 11, Report for 1882, U. S. Coast and Geodetic Survey.
- Self-registering Tide Gauges, Appendix No. 7, Report for 1897, U. S. Coast and Geodetic Survey.
- Precise Leveling in the United States, Appendix No. 8, Report for 1899, and Appendix No. 3, Report for 1903, U. S. Coast and Geodetic Survey.
- Variations in Latitude, Appendix No. 13, Report for 1891, Appendix No. 1, Report for 1892, Appendix No. 2, Report for 1892, and Appendix No. 11, Report for 1893, U. S. Coast and Geodetic Survey.
- Tables of Azimuth and Apparent Altitude of Polaris, Appendix No. 10, Report for 1895, U. S. Coast and Geodetic Survey.
- Determination of Time, Latitude, Longitude, and Azimuth, Appendix No. 7, Report for 1898, U. S. Coast and Geodetic Survey.
- A Treatise on Projections, U. S. Coast and Geodetic Survey, 1882.
- Tables for the Polyconic Projection of Maps (Clarke's 1866 Spheroid), Appendix No. 6, Report for 1884, U. S. Coast and Geodetic Survey.
- Geographical Tables and Formulas, U. S. Geological Survey, 1908.
- Bibliography of Geodesy (Gore), Appendix No. 8, Report for 1902, U. S. Coast and Geodetic Survey.

REFERENCES ON METHOD OF LEAST SQUARES.

- Manual of Spherical and Practical Astronomy, Chauvenet. J. B. Lippincott Co., Philadelphia, 1885.
- Approximate Determination of Probable Error, Appendix No. 13, Report for 1890, U. S. Coast and Geodetic Survey.
- Theory of Errors and Method of Least Squares, Johnson. John Wiley & Sons, New York, 1893.
- Practical Astronomy as Applied to Geodesy and Navigation, Doolittle. John Wiley & Sons, New York, 1893.

Precise Surveying and Geodesy, Merriman. John Wiley & Sons, New York, 1899.

Adjustment of Observations, Wright and Hayford. D. Van Nostrand & Co., New York, 1904.

Text Book on Geodesy and Least Squares, Crandall. John Wiley & Sons, New York, 1907.

INDEX

	PAGE
Aberration of light (diurnal)	213
Absolute length, correction for	36
Absolute locations	4
Accidental errors:	
laws of	252
nature of	247
theory of	252-265
Accuracy attainable in	
angle measurements	78
barometric leveling	129
base-line measurement	45
closing triangles	102
precise spirit leveling	161
trigonometric leveling	139
Adjustment of	
angle measurements	81, 100, 312-332
base-line measurements	333
level work	160, 344-359
observations	3, 241-359
quadrilaterals	90-100, 327
triangles	89, 322-326
Adjustments of	
Coast Survey precise level	155-156
direction instrument	65
European type of precise level	146-152
repeating instrument	59
Alignment corrections:	
horizontal	40
vertical	42
Alignment curve	64
Altazimuth instrument	48, 51
Altitude	167
American Ephemeris	164
Aneroid barometer	126, 127

	PAGE
Angles:	
accuracy of measurements	78
adjustment of	81, 100, 312-332
eccentric	75
exterior and interior	53
instruments for measuring	47, 52, 60
measurement of	47-80
Apparent time	165
Arcs, elliptic	108
Arithmetic mean	244
Associations, geodetic	1
Astronomical determinations	163-226
<i>See also</i> Azimuth, Latitude, Longitude, and Time.	
Azimuth	4, 109, 167, 203
astronomical	204
geodetic	204
lines, planes and sections	111
marks	204
periodic changes in	226
Azimuthal angles	109, 117
Azimuth determinations	203-226
approximate	214
at sea	225
by meridian altitudes of sun or stars	205
by observations on circumpolar stars	207-225
direction method	215
fundamental formulas	208
micrometric method	221
repeating method	218
Back azimuth	109, 113, 122
errors	122
Barometers, aneroid and mercurial	126, 127
Barometric leveling	125, 126-130
Base-bars	24-29
compensating	26
Eimbeck duplex	26
general features of	25
standardizing	33
thermometric	26
tripods for	27
Base-line measurements	24-46, 333-343
accuracy of	45
adjustment of	333
check bases	5
corrections required	24, 35-44
duplicate lines	334

	PAGE
Base-line measurements—(<i>continued</i>)	
gaps, computing length of	44
general law of probable error	336
law of relative weight	337
probable error of	65
probable error of lines of unit length	338, 339
sectional lines	335
standardizing bars and tapes	33
with base-bars	24-29
with steel and brass wires	32
with steel and invar tapes	30-32
uncertainty of	46, 342
Bessel's solution of geodetic problem	118
Bessel's spheroid	106
Bibliography	374
Board signals	20
Bonne's map projection	238
Celestial sphere	166
Chance, laws of	248
Changes, periodic:	
in azimuth	226
in latitude	196
in longitude	203
Check bases	5
Chronograph	184
Circumpolar stars	190, 207
Clarke's spheroid	106
Clarke's solution of geodetic problem:	
direct	116
inverse	118
Closed level circuits	160, 357
Closing the horizon	53, 313, 315
Coast and Geodetic Survey, United States	1
papers of	1
precise level	153
Coefficient of refraction	138
Co-functions:	
altitude	167
declination	167
latitude	167
Comparator	34
Compensating base-bars	26
Computation of geodetic positions	103-124
Bessel's solution	118
Clarke's solution	116
Helmert's solution	118

	PAGE
Computations of geodetic positions—(<i>continued</i>)	
inverse problem	118
Puissant's solution	113
Computed quantities:	
most probable values of	296
probable errors of	306-311
Conditional equations	284
Conditioned quantities:	
definition of	242, 284
most probable values of	284-295
probable errors of	304
Convergence of meridians	88, 111
Corrections in base-line work	24, 35-44
Correlative equations	290
Cross-section of tapes	38
Culmination, meaning of	190
Curvature and refraction (in elevation)	12
Declination	167
Degree, length of:	
meridian	228
parallel of latitude	228
Dependent equations	284
Dependent quantities:	
definition of	242, 284
most probable values of	284-295
probable errors of	304
Deviation of plumb line	124
Dip of horizon	184
Direction instrument	47, 50, 60
adjustments of	71
Direct observations	243
Distances, polar and zenith	167
Diurnal aberration	213
Duplex base-bars	26
Duplicate base lines	334
Duplicate level lines	160, 346
Earth, figure of:	
general figure	104
practical figure	106
precise figure	105
Eccentric signals	20, 78
stations	75
Eimbeck duplex base-bar	26
Elevation of stations	62
Ellipsoid, definition of	105

	PAGE
Elliptic arcs	108
Elongation, definition of	208
Ephemeris, American	164
Equation of time	165
Equations:	
conditional	284
correlative	290
dependent	284
normal	273, 275
observation	271
probability	257
reduced observation	281
Errors:	
classification of	245, 247
facility of	255
in precise leveling	143
laws of	252
probability of	256
theory of	252-265
types of	254
European precise level	141, 145
adjustments of	146-152
Exterior angles	53
Figure adjustment	81, 87, 100, 312, 321-332
Figure of earth:	
analytical considerations	110
constants of	106
general figure	104
geometrical considerations	106
practical figure	106
precise figure	105
Filar micrometer:	
description of	66
reading the micrometer	67
run of the micrometer	68
Flattening of the earth's poles	104, 105
Foot pins and plates	158
Gaps in base lines	44
Geodesic line	109
Geodesy:	
definition of	1
history of	1
scope of	2
Geodetic associations	1
Geodetic leveling	125-162

	PAGE
Geodetic map drawing	227-240
Geodetic positions, computation of	103-124
Geodetic quadrilateral	7, 90, 327
Geodetic surveying	1-240
Geodetic work in the United States	1
Geoid, definition of	106
Geometric mean	244
Harrebow-Talcott latitude method	193
Heat radiation	47
Height of stations	17
Heliotropes	21
Helmert's solution of geodetic problem	118
History of plane and geodetic surveying	1
Horizontal alignment	40
Hour angle	164, 167
Independent quantities:	
definition of	241
most probable values of	266-283
probable errors of	300-304
Indirect observations	243
Instruments, geodetic; <i>see</i> Angles, Astronomical determinations, Base-line measurements and Geodetic leveling.	
Interior angles	53
Intermediate points in leveling	160, 217
International Geodetic Association	1
Intervisibility of stations	11, 14
Invar tapes	32
Inverse geodetic problem	118
Jäderin base-line methods:	
with tapes	31
with wires	32
Latitude	109, 167, 186
astronomical	186
geocentric	187
geodetic	186
locating a parallel of	120
periodic changes in	196
Latitude determinations	188-196
at sea	196
by circumpolar culminations	190
by Harrebow-Talcott method	193
by meridian altitudes of sun	188
by prime-vertical transits	192
by zenith telescope	193

	PAGE
Law of	
coefficients in correlative equations	294
coefficients in normal equations	280
facility of error	257
Laws of	
chance	248-250
errors	252
weights	82
Least squares, method of	241-359
Lengths of bars and tapes	24, 33
Leveling:	
barometric	125, 126-130
geodetic	125-162
precise spirit	125, 139-162
trigonometric	125, 130-139
Level work:	
adjustments	160, 344-359
branch lines, circuits and nets	359
closed circuits	160, 357
duplicate lines	160, 346
general law of probable error	347
intermediate points	160, 355
law of relative weight	348
level nets	161, 352
multiple lines	160, 350
probable error of lines of unit length	348, 349
sectional lines	347
simultaneous lines	160
Light, diurnal aberration of	213
L. M. Z. problem	103
Locating a parallel of latitude	120
Locations, absolute and relative	4
Longitude	109, 197
astronomical	197
geodetic	197
periodic changes in	203
Longitude determinations	197-203
at sea	203
by lunar observations	198
lunar culminations	199
lunar distances	199
lunar occultations	199
by special methods	198
flash signals	198
special phenomena	198
by telegraph	200
arbitrary signals	202

	PAGE
by telegraph—(<i>continued</i>)	
standard time signals	201
star signals	201
by transportation of chronometers	199
Loxodrome	233
Map projections	227-240
conical	234
Bonne's projection	238
Mercator's conic	236
simple conic	235
cylindrical	229
Mercator's cylindrical	231
rectangular cylindrical	231
simple cylindrical	229
polyconic	240
rectangular polyconic	241
simple polyconic	240
trapezoidal	234
Mean absolute error	305
Mean error	305
Mean of errors	305
Mean radius of the earth	44
Mean sea level	43, 125
Mean solar time	165
Measures of precision	262, 304
Mercator's projections:	
conic	236
cylindrical	231
Mercurial barometer	126, 127
Meridian	167
lengths	228
line, plane, and section	167
Meridians, convergence of	88, 111
Method of least squares	241-359
Micrometer:	
filar	66
microscope	65
reading of	67
run of	68
Mistakes	247
Modulus of elasticity	39
Molitor's precise level rod	158
Most probable values of	
computed quantities	296
conditioned quantities	284-295
dependent quantities	284-295

Most probable values of—(<i>continued</i>)	
independent quantities	266-283
observed quantities	242, 266, 295
Multiple level lines	169, 350
Nadir	167
Nautical Almanac	164
Night signals	23
Normal	110
Normal equations	273, 276
law of coefficients	280
Normal tension	40
Observation equations:	
definition of	271
reduced	281
reduction to unit weight	278
Observations:	
adjustment of	3, 241-359
classification of	243
Observed quantities:	
most probable values of	266-295
probable errors of	297-305
Observed values, definition of	242
Ovaloid, definition of	105
Papers of U. S. Coast and Geodetic Survey	1
Parallax (in altitude)	167, 171
Parallel of latitude, location of	120
Parallels, length of one degree	228
Phase	20
Phaseless targets	20
Plane surveying, history of	1
Plumb-line deviation	124
Polar distance	167
Pole signals	20
Precise spirit leveling	125, 139-162
accuracy attainable	161
adjustment of results	160, 344-359
Coast Survey precise level	142, 153
adjustments of	155
constants of	155
use of	156
European type of precise level	141, 145
adjustments of	146, 150
constants of	146
use of	152

	PAGE
Precise spirit leveling—(<i>continued</i>)	
instruments used	139, 145, 153
methods	143, 145
rods and turning points	158
sources of error	143
Primary triangles and systems	9
Prime vertical	110, 167
Prime-vertical transits	192
Probability:	
equation of	257, 260
laws of chance	248
Probable error:	
general value of	299
meaning of	297
Probable errors of	
angle measurements	79
base-line measurements	46
computed quantities	306-311
conditioned quantities	304
dependent quantities	304
independent quantities	300-304
observed quantities	297-305
Projection of maps	227-240
<i>See</i> Map projections for list of types.	
Puissant's solution of geodetic problem:	
direct	113
inverse	118
Pull, with tapes and wires	24, 30, 38
Quadratic mean	244
Quadrilateral, geodetic	7, 90, 327
algebraic adjustment of	90-102
approximate	92
rigorous	96
least square adjustment of	327
Quantities:	
classification of	241
most probable values of	266-296
computed quantities	296
observed quantities	266-296
probable errors of	297-311
computed quantities	306-311
observed quantities	297-305
Radiation, heat	47
Reading micrometers	67
Reconnaissance	10

	PAGE
Reduced observation equations	281
Reduction to center	75
Reduction to mean sea level	43
Refraction:	
angular	167
coefficient of	138
in elevation	12
Relative locations	4
Repeating instruments	47, 49, 52
adjustments of	59
Residual errors	245
Residuals	245
Rhumb line	233
Right ascension	167
Run of micrometer	68
Sag	24, 30, 39
Secondary triangles and systems	9
Sectional lines:	
base lines	335
level lines	347
Sidereal time	165, 168
Signals at stations	18
board	20
eccentric	20, 78
heliotrope	21
night	23
phaseless	20
pole	20
Simultaneous level lines	160
Single angle adjustment	312
Solar time	165
Spherical excess	88, 89, 90
Spheroid:	
Bessel's	106
Clarke's	106
definition of	105
Spirit leveling, <i>see</i> Precise spirit leveling.	
Standardizing bars and tapes	33
Standard time	165
Station adjustment	81, 84, 312, 313-319
Stations:	
elevation of	14, 17
height of	17
intervisibility of	11, 14
marks	17
selection of	10

	PAGE
Stations—(<i>continued</i>)	
signals and targets	18
towers	17, 18
triangulation	5
Steel tapes	24, 30, 32
corrections required in tape measurements	24, 33-39
standardizing	33
Steel and brass wires	32
Systematic errors	247
Tables	361-373
Tangents	110, 120
Targets	18
Telegraphic determination of longitude	200
Telescope, zenith	193
Temperature corrections in base-line work	24, 31, 36
Tension, tapes and wires	40
Tertiary triangles and systems	9
Theodolite	48
Theory of errors	252-265
comparison of theory and experience	264
Theory of weights	81, 243
Thermometric base-bars	26
Tide gauges:	
automatic	125
staff	126
Time	164
conversion of	165, 169, 170
general principles	164
varieties of	165
Time determinations	164-186
at sea	184
by equal altitudes of sun	176
by single altitudes of sun	171
by sun and star transits	181
choice of methods	184
Towers, station and signal	17, 18, 47
Transit, astronomical	183, 185
Triangles:	
accuracy in closing	102
adjustment of	89, 322-326
classification of	9
computation of	102
Triangulation:	
adjustments and computations	81-102, 312-332
general scheme	4
principles of	4-23

	PAGE
Triangulation—(<i>continued</i>)	
stations	5, 10
systems	5-9
Trigonometrical leveling	125, 130-139
accuracy attainable	139
observations at one station	133
reciprocal observations	136
sea-horizon method	131
Tripods for	
angle-measuring instruments	18
base-bars	27
leveling instruments	143
True errors	245
True values	242
Turning points	158
Uncertainty of base-line measurements	46, 342
United States Coast and Geodetic Survey	1
papers of	1
precise level	153
Values, classification of	242, 244
Variations, periodic:	
in azimuth	226
in latitude	196
in longitude	203
Vertical alignment	42
Weight:	
laws of	82
theory of	81, 243
Wires, steel and brass	32
Zenith	167
Zenith distance	167
Zenith telescope	193

