

FARMERS' BULLETIN 1230  
UNITED STATES DEPARTMENT OF AGRICULTURE

# CHIMNEYS & FIREPLACES

They Contribute to the Health  
Comfort and Happiness of the Farm Family

## HOW TO BUILD THEM

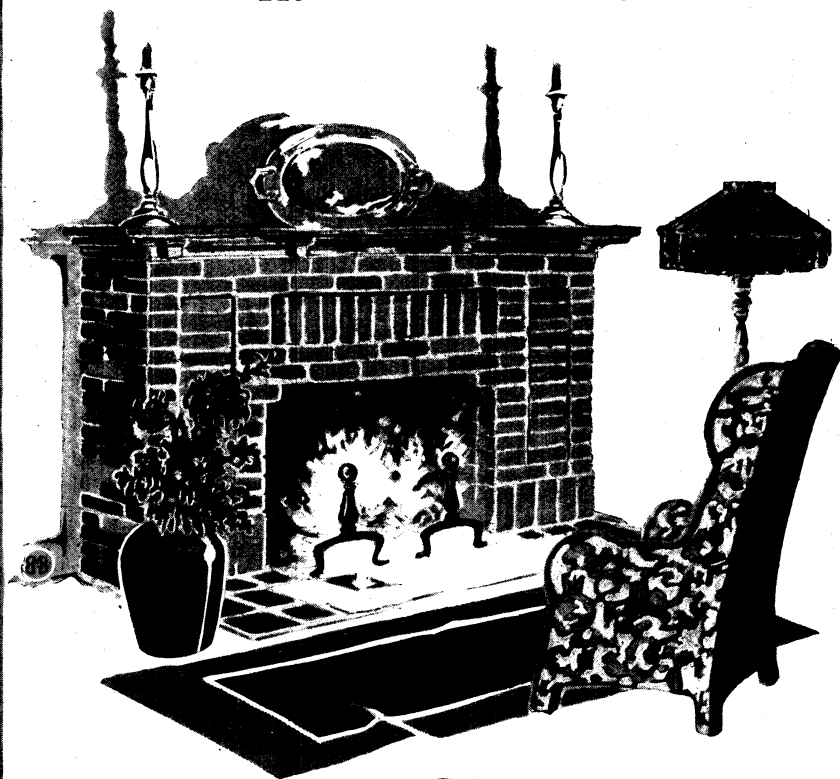

**O**F THE mistakes commonly made in home building none is more frequent than faulty design and construction of chimneys and fireplaces. Though the use of the fireplace is one of the oldest methods of house heating there are few who understand the principles of its action, and even experienced masons frequently fall into errors in building which seriously detract from the efficiency of the installation. No defect in the construction of the house detracts more from the comfort of the home and none is a greater menace to life and property than a poor chimney and fireplace. Bad chimney design is also the cause of much avoidable expense in heating the house.

This bulletin is designed to give the householder and prospective builder, and especially the farmer or other rural resident who builds or superintends the building of his own home, a working knowledge of the principles to be observed in planning and building these important parts of the house, which, if they are observed, will go a long way to promote the comfort of the home and insure the safety of the property.

Contribution from the Bureau of Public Roads  
THOS. H. MacDONALD, Chief

Washington, D. C.

Issued, December, 1921

# CHIMNEYS AND FIREPLACES.

A. M. DANIELS, *Assistant Mechanical Engineer, Division of Agricultural Engineering, Bureau of Public Roads.*

## CONTENTS.

Chimneys :	Page.	Fireplaces :	Page.
Function of chimneys-----	3	Essentials of fireplace construction-----	15
The chimney draft-----	4	Area of the flue-----	16
Shapes and sizes of flues-----	5	The throat-----	17
Height of chimney-----	7	Smoke shelf and chamber-----	18
Flue linings-----	7	Shape of fireplace-----	19
Location and wall thickness-----	8	Throat damper-----	19
Openings into the chimney-----	10	Placing the throat damper-----	20
Supporting the chimney-----	10	Size of fireplace opening-----	20
Capping the chimney-----	11	Depth of fireplace opening-----	20
Chimney and roof connections-----	12	The hearth-----	21
Chimney connections-----	12	The jambs-----	21
Chimney insulation-----	14	Fireplace back and sides-----	21
Smoke test for leakage-----	14	Supporting irons-----	21
Cleaning and repairing the flue-----	15	Improving fireplace heating-----	22

## FUNCTION OF CHIMNEYS.

**T**HE prime function of a chimney is to produce a draft that will cause sufficient combustion and carry off the resulting smoke; incidentally it assists ventilation. Many unsatisfactory heating plants and much excessive fuel consumption are due to improperly constructed chimneys, which are the rule rather than the exception. Although many of these are more inefficient than dangerous, yet reports of the National Board of Fire Underwriters<sup>1</sup> show that a larger number of fires are caused by defective chimney construction than by anything else. The annual loss resulting from such fires is greater than the fire loss from any other cause. Poor chimney construction is responsible for smoke pollution of the air, waste of fuel, and poor heating.

The most common faults in chimney construction are:

1. The use of unsuitable materials. Clay sewer pipe, hollow building blocks, or unprotected concrete should not be used.
2. Improper laying of brick. Brick should not be laid on edge and should be properly bonded. Lining should be used in all brick chimneys the walls of which are less than 8 inches thick. Lack of mortar, especially in the perpendicular joints, ruins many an otherwise good chimney.

<sup>1</sup> "Dwelling Houses," a publication issued by the National Board of Fire Underwriters in the interest of fire protection, has been used as a basis for the matter relating to the requirements and construction of chimneys and methods of fire protection.

3. Failure to support the chimney properly. It should never be carried on any timber construction of the building, and when it rests upon the ground sufficient masonry foundation should be provided to prevent settling.

4. Building inflammable material into the chimney or against it without proper insulation.

5. Failure to anchor the smoke pipe properly to the chimney.

6. Neglect of the connection between smoke pipe and flue or of the flue itself. The connection should be tight; rusted pipe should be replaced; the chimney should be kept clean and the joints in the brickwork properly pointed.

7. Lack of a tight flue. A flue free from leakage is unusual. Every flue should be tight enough to prevent escape of smoke when tested as described on page 14. A leaky flue is the most frequent cause of heating troubles, high fuel bills, and destructive fires.

8. Failure to maintain the full sectional area at the bend when a flue is offset.

9. Use of the main heating apparatus flue for water heater or other auxiliary equipment. The furnace or heater should have a separate flue.

10. Failure to provide a separate tight cleanout for each flue. Two or more otherwise good flues may be rendered inefficient if led into one cleanout, since air may be drawn from one into another and the draft in all affected.

11. Presence of deep pockets leading to cleanouts. They may cause eddying currents that are detrimental. Pockets should be only deep enough to permit installing a cast-iron cleanout frame and door just below the smoke-pipe entrance. Deep pockets allow soot accumulation that may take fire.

#### THE CHIMNEY DRAFT.

The draft depends entirely upon the chimney flue. The better the flue the more satisfactory and efficient will be the operation of the entire heating apparatus. The strength or intensity of the draft is dependent mainly upon the tightness, size, and height of the chimney flue. The most common error in chimney construction is failure to distinguish between the size of flue necessary for free passage of the volume of smoke from a given amount of fuel and that which with proper height will produce the required draft. A chimney may be high enough, yet have an area too small to carry properly the volume of smoke. On the other hand, the size may be sufficient but the chimney too low to produce a draft strong enough to pull the air through the fire at a sufficiently rapid rate. Either fault or a combination of the two will result in unsatisfactory service.

Draft in a chimney flue is caused by the difference in weight between a volume of air on the outside and an equal volume of products of combustion from the fire on the inside. The higher the temperature of a given weight of air, the greater is its total volume and the lighter the weight of its unit volume. This produces a condition of unbalanced pressures at the base of the flue. The rising of the lighter gases within the chimney tends to equalize the pressures. So long as the fire burns this condition of unbalanced pressure persists, the result being draft.

This is the basic principle which governs chimney action and upon which the draft depends. The greater the difference between the temperature in the flue and that outside the greater the tendency toward equalization of pressure and hence the better the draft. In summer the draft of a chimney is not as good as in winter because the difference in temperature between the outside air and that of the gases in the flue is less.

#### SHAPES AND SIZES OF FLUES.

The most efficient chimney is one built perfectly straight with a round or nearly round flue and a smooth interior surface. There is no advantage in reducing the sectional area toward the top. The cross section and height are determining factors. The transverse area must be sufficient to pass the volume of air required to burn the fuel

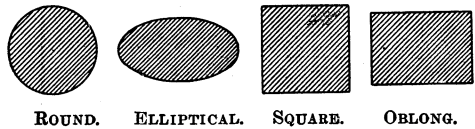

FIG. 1.—Round flues offer the least resistance to the passage of gases, but most residence flues are made either square or oblong for structural reasons.

properly, and the height must be great enough to insure against interference with the draft by adjoining buildings or projections of the same building and to produce a sufficiently strong draft.

Loss in draft strength is due to air leakage, and friction of the gases against the sides of the chimney. A round flue (see fig. 1) is the most desirable because it offers less resistance to the spirally ascending column of smoke and gases. The elliptical is second choice so far as the movement of the gases is concerned, but the difficulties that it presents in manufacture and construction eliminate this shape. A rectangular chimney either square or oblong is not effective over its full transverse area; for the rising column, being approximately circular in section, does not fill the corners. However, square or oblong forms are far more common than the round, owing to the greater cost of round flue construction. Square flues are preferable to oblong so far as efficiency is concerned, but in the larger sizes of house flues the oblong shape is more generally used because it fits

to better advantage into the plan of the house. An oblong flue should never have the long side more than 4 inches greater than the short side. A flue 8 inches by 16 inches is bad flue construction for draft purposes. The sizes given in Table 1 are recommended by the National Warm Air Heating and Ventilating Association. Like all data for both high and low pressure flues, these sizes are based on experience, not on scientific data, and are subject to modification by further research. The dimensions given are for unlined flues. The actual inside dimensions of flue tile are slightly different because of the lack of standardization. In selecting the flue for a furnace or other large heating unit an 8-inch by 12-inch size should be considered the minimum for a lined or unlined flue, and 12 inches by 12 inches the minimum for a lined or unlined flue whose height is more than 35

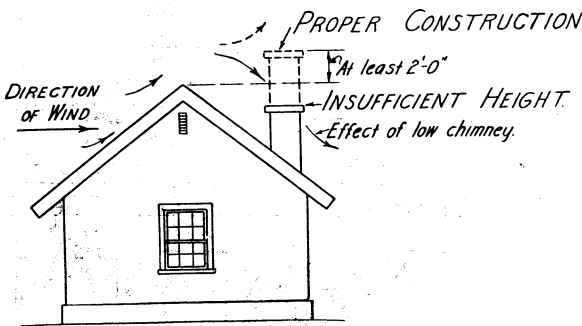

FIG. 2.—Top of chimney should be at least 2 feet above the top of ridge in order that the wind currents may not be deflected down the chimney.

feet measured above the grate level. If the chimney is designed for a small unit such as a laundry stove or kitchen range an 8-inch by 8-inch flue may be used.

The proper size of flue depends upon the size of the heater or furnace for which it is to be used. All manufacturers' catalogues contain the size of the smoke pipe for each particular heater, and from Table 1 (minimum) dimensions for round, square, and oblong flues may be selected; or if the catalogue contains stack sizes select the proper one. The flue tile to be used should have a transverse net inside area approximately equal to that of the smoke pipe.

TABLE 1.

Diameter of smoke pipe or round chimney flue.	Size of chimney flue.	Height of chimney flue above grate.	Diameter of smoke pipe or round chimney flue.	Size of chimney flue.	Height of chimney flue above grate.
<i>Inches.</i>	<i>Inches.</i>	<i>Feet.</i>	<i>Inches.</i>	<i>Inches.</i>	<i>Feet.</i>
8	8 by 12	35	15	16 by 16	45
9	8 by 12	35	16	16 by 18	45
10	12 by 12	35	17	16 by 20	50
11	12 by 12	40	18	16 by 20	55
12	12 by 12	40	19	20 by 20	55
13	12 by 16	40	20	20 by 24	60
14	12 by 16	45			

## HEIGHT OF CHIMNEY.

In Table 1 the minimum height of the chimney above the grate is given as 35 feet. Higher chimneys are considered more satisfactory, and authorities claim that any flue under 40 feet in height will produce an erratic draft, good on some days but poor on others. The force or direction of the wind may be the cause, or the amount of moisture in the air, or the quality of the fuel may be responsible. The higher the chimney the less will be the possibility of counter air currents and the stronger and more constant the draft. Soft coal and the sizes of hard coal known as pea and buckwheat are apt to cake and fill up the air spaces through the bed of the fire, with the result that an intense draft is required to give the fuel sufficient air.

The top of the chimney should extend at least 3 feet above flat roofs and 2 feet above the ridge of peak roofs (see figs. 2 and 3), and it should not be on the side of the house adjacent to a large tree or a structure higher than itself (see fig. 4), for these may cause eddies and force air down the chimney.

A poor draft will most likely result when the wind is blowing in the direction indicated.



FIG. 3.—Extensions to the chimney required in order that it might draw properly.

## FLUE LININGS.

Although chimneys are built unlined to save expense, those properly lined with tile are undoubtedly more efficient. Linings prevent disintegration of mortar and bricks through the action of flue gases. This disintegration and that occurring from changes in temperature result frequently in open cracks in the flue (see fig. 5-B) which reduce or check the draft. If loose brick and mortar should fall within they may lodge so as to cause partial or almost complete stoppage (see fig. 5-D). The danger of this latter condition is

greater if the flue be built with offsets or bends. Any change in direction should be made as gradual as possible and with an angle not greater than 30 degrees with the perpendicular.

The most important requirement for a flue lining is that it withstand high temperatures and not be subject to disintegration by ordinary flue gases. It should be made of fire clay and for the purpose. The thickness should be 1 inch. It should be set in cement mortar with the joints struck smooth on the inside. Each length of flue lining should be placed in position, and the brick should then be laid around it; if the lining is slipped down after several courses of brick have been laid, the joints can not properly be filled with mortar and leakage is almost sure to result.

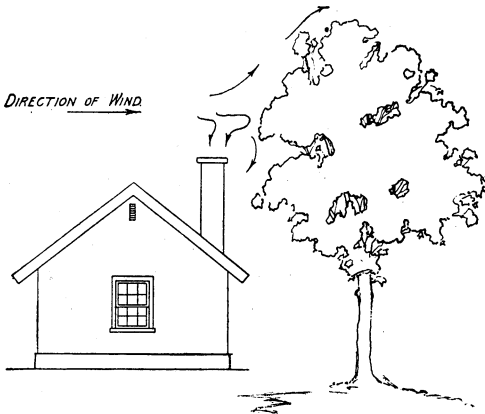

FIG. 4.—Large trees located near chimney tops may deflect wind currents down the chimney. This may be avoided by placing the chimney on the opposite side of the building.

Linings are manufactured in round, square, and oblong shapes, but not in elliptical. The oblong and square shapes are better adapted to brick construction than the round. They permit of simpler and less expensive masonry work. On the other hand, the round shape produces better draft and is easier to clean.

A fireplace flue, if straight, should be lined from the throat continuously to the top. The smoke chamber should be lined with fire clay or cement mortar one-half inch thick. In case the masonry in front of the throat is less than 8 inches thick the lining should start at the bottom of the lintel. The hottest part of the flue is at its throat, and if it is not lined at that point or if the masonry is not of sufficient thickness, there is danger of overheating. Careful attention should be given to details of flue construction in order to assure satisfactory operation and reduce the fire hazard.

#### LOCATION AND WALL THICKNESS.

The best location for the chimney is near the center of the building, for when so located its four walls are kept warm; cold winds can



not chill it and cause it to draw poorly. However, it is not always possible to plan the arrangement of rooms so that the chimney may be thus located. The outside wall of a chimney should be at least 8 inches thick in order to reduce heat loss and the chance of air leakage into the flue.

If the flue is lined and the chimney is not higher than 30 feet, its walls, if of brick, may be made 4 inches thick, provided adjacent inflammable material is properly insulated. If unlined, the walls should not be less than 8 inches thick. It is not good practice to place the linings of two flues side by side. If there is more than one flue in a chimney, the flues should be separated from each other by a division wall of brick at least 4 inches thick (see fig. 6), bonded into the side walls, and the joints of the flue linings should be staggered or offset at least 6 inches (see fig. 7). This construction insures stability, reduces the chance for air leakage between flues, and prevents the possibility of a fire in one flue involving an adjacent flue. If stone is used in chimney construction, the walls should be at least 4 inches thicker than brick walls.

Walls of concrete chimneys should be not less than 4 inches thick or else they should be reinforced in both directions; otherwise cracking during the setting of the concrete or, later, due to temperature changes or unequal settlement of the foundation is apt to occur. Concrete blocks are not recommended, but if they are used each block should be reinforced with steel running continuously around it and the blocks should be not less than 4 inches thick. They should be lined with the best flue lining. All monolithic concrete chimneys with walls less than 8 inches thick should be lined.

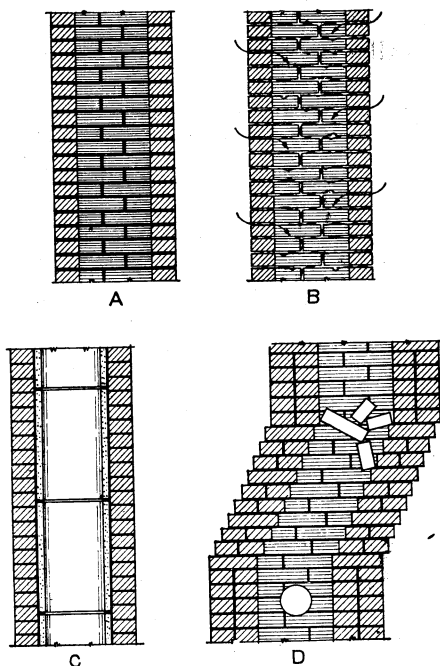

FIG. 5.—A. An unlined chimney before use. B. Same chimney, after being in service. Frequently the heat and weather cause the mortar to disintegrate so that air leaks in through the joints, causing a reduction in the draft. C. Same chimney as A, showing terra cotta flue lining in place. D. An unlined chimney with offset. Loose brick and mortar may fall and become lodged at the offset during construction or loosening of the points and disintegration may cause bricks from an uncapped chimney to check the draft completely.

## OPENINGS INTO THE CHIMNEY.

It is not unusual to find an opening into a chimney other than for the smoke pipe of the main heating apparatus. This is a frequent cause of unsatisfactory operation. No range, stove, fireplace, or ventilating register should be connected with the chimney flue built for the heating apparatus. If it should be desired to use an existing abandoned fireplace chimney for a range or stove the fireplace flue should be closed tight about a foot below the place where the smoke pipe enters.

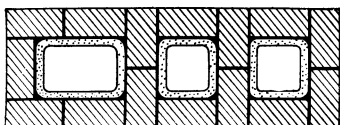
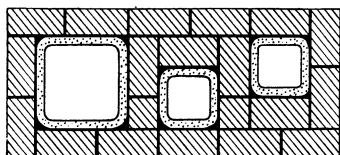

FIG. 6.—A division wall of at least 4 inches of brick should separate each flue from any others in the same chimney. Either of the arrangements shown will produce a good bond.

There should be but one connection with a flue, if for no other reason than to decrease the fire hazard. Fires frequently occur from sparks that pass into the flue through one opening and out through another. Two stoves, one on the first floor and one on the second, may be connected with the same chimney flue, but if the fire in the upper stove is hotter than in the lower, the lower will have practically no draft.

A soot pocket provided with a door for cleaning it out is very convenient. The door should be placed just below the smoke-pipe opening, and care must be taken to see that it fits snugly and is always closed so tight that no air can get in.

## SUPPORTING THE CHIMNEY.

All chimneys should be built from the ground up. None of the weight should be carried by any part of the building except the foundation. Proper foundations should be provided at least 12 inches wider all round than the chimney. If the chimney is an exterior one, and there is no basement or cellar, its foundation should be started well below the frost line. Otherwise the base of the chimney should be at the same level as the bottom of the foundation of the building.

No chimney should rest upon or be carried by wooden floors, beams, or brackets, nor should it be hung from wooden rafters. Wood construction shrinks, and beams supporting heavy loads always deflect in time. Sagging of the beams injures the walls and ceilings of the house and is apt to crack the chimney and render it dangerous. Chimneys usually extend several feet above the roof, exposing considerable surface to the wind, and unless the support is stable they are likely to sway during a gale with the possibility of the joints at

the roof-line opening. Openings in a flue at this point are especially dangerous, for sparks from the flue may come into contact with the woodwork of the roof. This swaying may also cause leaks in the roof.

The brickwork around all fireplaces and flues should be laid with cement mortar, as it is more resistant than lime mortar to the action

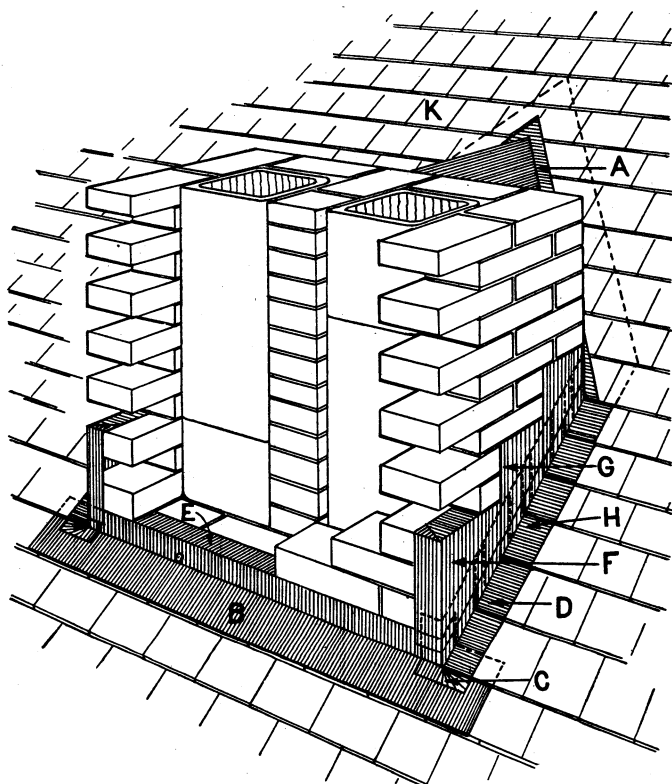

FIG. 7.—Chimney and roof connection. Sheet metal A should have shingles K over it at least 4 inches. Apron B bent as at E with base flashings C, D, and H and cap flashings F and G, lapping over the base flashings provide watertight construction. When the chimney contains two flues the joints should be separated as shown.

of heat and flue gases. It is well to use cement mortar for the entire chimney construction. All mortar used for chimney construction, except for laying fire brick, should be proportioned as follows: Two bags of Portland cement, not less than 188 pounds, and one bag of dry hydrated lime, 50 pounds, thoroughly mixed dry, and to this mixture should be added three times its volume of clean sand with sufficient water to produce proper consistency. When dry hydrated lime is not available, 1 cubic foot of completely slaked lime putty may be substituted for the dry hydrate.

## CAPPING THE CHIMNEY.

Brick chimneys should be capped with stone, concrete, or cast iron. Unless a chimney is capped the top courses of brick may become loosened and therefore dangerous. Plain topped chimneys will last longer and are safer than those of an ornamental character. The opening in the cap piece should be the full size of the flue.

## CHIMNEY AND ROOF CONNECTION.

Where the chimney passes through the roof the construction should provide space for expansion due to temperature changes, settlement, or slight movement of the chimney during heavy winds. (See fig. 7.) Copper is the best material for flashings. It is easier to handle than galvanized sheet metal, which is more often used

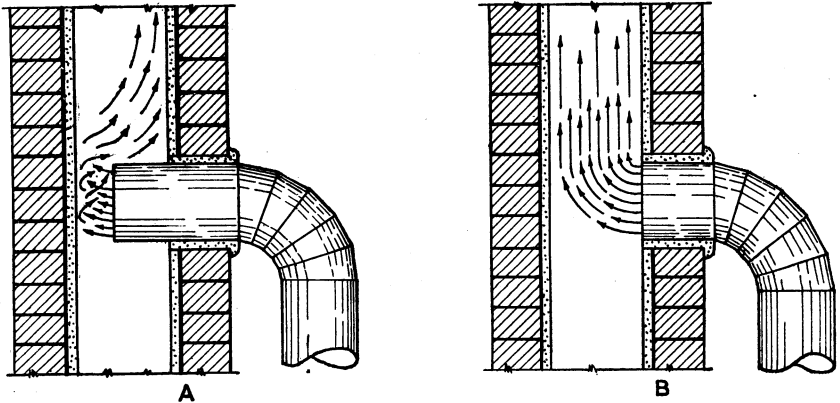

FIG. 8.—A. Wrong connection, producing interference and a poor draft. B. Correct construction, producing a good draft by providing a free passage for the gases.

because of its lesser cost, but which will corrode in time, both from inside and outside exposure. Tin or black iron are cheaper but will rust quickly unless frequently painted. Lead and zinc are expensive and should not be used for chimney flashings, for in case of fire under the roof they will melt and leave an opening to create a draft by which the intensity of the fire will be increased.

## CHIMNEY CONNECTIONS.

Proper care in setting and looking after smoke pipes connecting with chimneys would greatly lessen the number of fires chargeable to defective construction.

In fitting the smoke pipe no opening should be left around it, and the pipe should not project into the flue lining. (See fig. 8.) The joint should be made air-tight by a closely fitting collar and boiler putty or fireproof cement. The proper construction is shown in fig-

ure 8-B, but if the pipe extends into the flue a shelf is formed on which soot will accumulate, the flue area will be reduced and a poor draft may result.

Smoke pipes should enter the chimney horizontally, and the connection through the chimney wall to the flue should be made with fire clay or metal thimbles securely and tightly set in the masonry. If the walls are furred, no wood should be within 12 inches of thimbles or any part of the smoke pipe. The space between the thimble and wood furring should be covered with metal lath and plaster.

Flue holes when not in use should be closed with tight fitting metal covers. If the room is papered the metal covers may also be papered, provided there is no other smoke connection with the flue, or provided a protective coating of asbestos paper is first applied over the metal. If there is another connection the metal may become hot enough to scorch the unprotected wall paper or set it afire. No smoke pipe should be permitted within 18 inches of any woodwork unless at least that half of the pipe nearest the woodwork is protected properly by 1 inch or more of fireproof covering. A metal casing 2 inches from the upper half of the pipe is sometimes employed to protect woodwork directly above it. When a smoke pipe is so protected it should never be less than 9 inches from any woodwork or combustible material. The storage of wooden boxes, barrels, or any combustible should not be permitted under or near a furnace smoke pipe.

If a smoke pipe must be carried through a wood partition the woodwork should be properly protected. This can be done by cutting an opening in the partition and inserting a galvanized iron double-walled ventilating thimble at least 12 inches larger than the smoke pipe (see fig. 9), or protection may be afforded by at least 4 inches of brickwork or other incombustible material. Smoke pipes should not pass through floors, closets, or concealed spaces. They should not enter a chimney in a garret. They should be cleaned at least once a year.

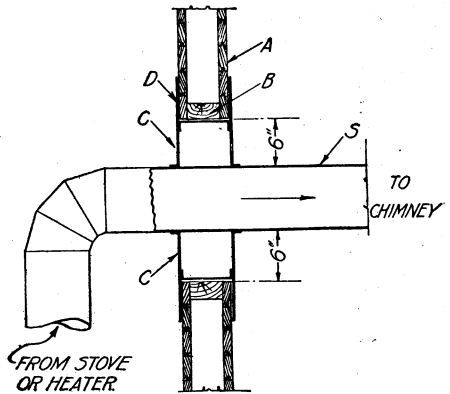

FIG. 9.—Smoke pipe passing through a partition. A,  $\frac{1}{2}$ -inch sides of partition; B, 2 by 4 studs in partition; C, ventilating holes in the double galvanized iron ventilating thimble D. Thimble should be at least 12 inches larger than pipe S.

## CHIMNEY INSULATION.

All wooden construction adjacent to chimneys should be insulated. A space of 2 inches should be left between the outside face of a chimney

and all wooden beams or joists. This space should be filled with some porous, nonmetallic, incombustible material. Loose cinders serve well. (See fig. 10.) Do not use brickwork, mortar, or solid concrete. The filling should be done before the floor is laid, as it not only forms a fire stop but prevents accumulation of shavings or other combustible material. Baseboards fastened to plaster which is directly in contact with the outside wall of a chimney should be protected by placing a layer of fire-proof material at least one-eighth inch thick between the woodwork and the plaster. (See fig. 10.)

Wooden studding, furring, or lathing should not under any circumstances be placed against a chimney. Wooden construction should be set back from the chimney as indicated in figures

11 and 12; or the plaster may be applied directly to the masonry or to metal lathing laid over the masonry. The former is the better method, as settlement of the chimney will not crack the plaster. It is recommended that a coat of cement plaster be applied directly upon the masonry of any parts of a chimney that are to be incased by a wooden partition or other combustible construction.

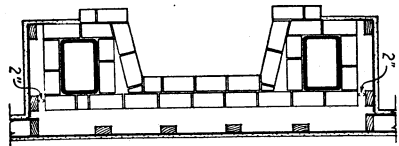

FIG. 11.—No wooden studding, furring, or lathing should be placed against the chimney. It should be set back as indicated in this figure and in fig. 12.

## SMOKE TEST FOR LEAKAGE.

Every flue should be subjected to a smoke test before the heater is connected with it. This may be done as follows: Build a paper, straw, wood, or tar-paper fire at the base of the flue, and when the smoke is passing in a dense column tightly block the outlet at the top by laying a wet blanket over it. If leakage exists at any point, it will immediately become apparent by

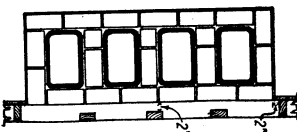

FIG. 12.

the appearance of smoke at the opening. Flues so tested frequently reveal very bad leaks into adjoining flues or directly

through the walls or between the linings and the wall. When the smoke test indicates leakage, the defect should be remedied before the chimney is accepted for use. Remedying such defects is usually difficult, hence it is wise to watch the construction closely as it progresses. Many brick masons say that all flues leak. This is not true; every flue should be tight.

#### CLEANING AND REPAIRING THE FLUE.

If a smoke test shows no leakage and the flue is straight, a hand mirror held at the proper angle at the base affords a means of examination for obstructions. Usual causes of stoppage are broken tile leaning inward, mortar accumulations, loose bricks, bird's nests, partly burned paper, soot from soft coal, tarry deposits from burning wood, etc. A weighted bag of hay or straw attached to the end of a rope may be passed up and down the flue to clean it if there is not too great an offset in it.

#### FIREPLACES.

The use of the fireplace is a very old method of house heating. As ordinarily constructed fireplaces are not efficient and economical. The only warming effect is produced by the heat given off by radiation from the back, sides, and hearth of the fireplace. Practically no heating effect is produced by convection; that is, by air currents. The air passes through the fire, is heated, and passes up the chimney, carrying with it the heat required to raise its temperature from that at which it entered the room and at the same time drawing into the room outside air of a lower temperature. The effect of the cold air thus brought into the room is particularly noticeable in parts of the room farthest from the fire.

The open fireplace, however, has its place as an auxiliary to the heating plant and for the *hominess* that a burning fire imparts to the room. If one is to be provided, the essentials of construction should be understood and followed so that it will not smoke.

#### ESSENTIALS OF FIREPLACE CONSTRUCTION.

In order that satisfactory results may be obtained from an open fireplace, it is essential: First, that the flue have the proper area; second, that the throat be correctly proportioned and located; third, that a properly-constructed smoke shelf and chamber be provided; fourth, that the chimney be carried high enough to avoid interference; and fifth, that the shape of the fireplace be such as to direct a maximum amount of radiated heat into the room.

## AREA OF THE FLUE.

The sectional area of the flue bears a direct relation to the area of the fireplace opening. The area of lined flues should be a tenth or more of that of the fireplace opening. If the flues are unlined the proportion should be increased slightly because of greater friction. Thirteen square inches of area for the chimney flue to every square

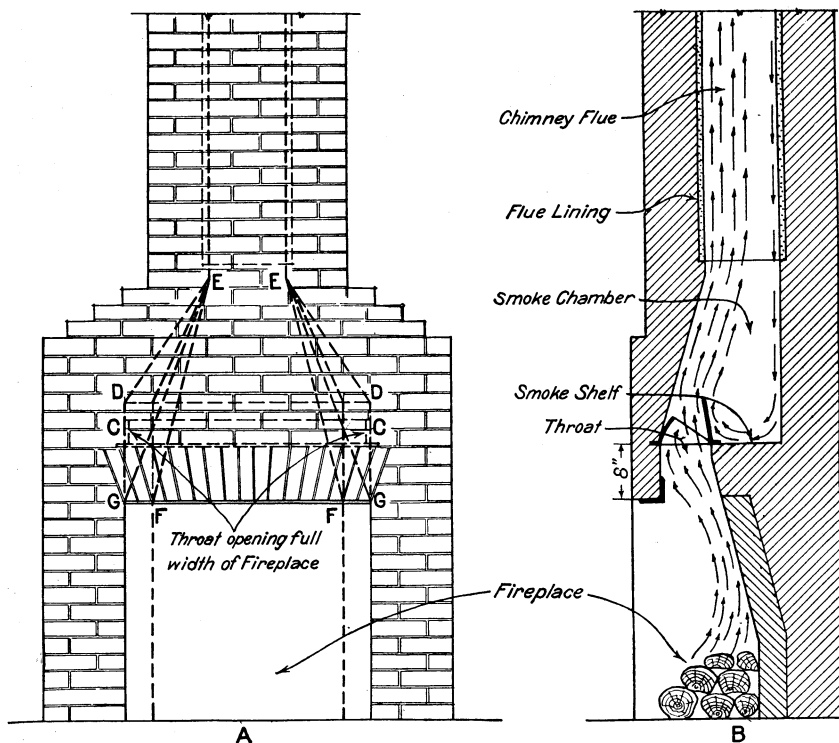

FIG. 13.—A. Top of throat damper is at DD, smoke shelf at CC. Side wall should not be drawn in until the height DD is passed. This assures full area. If the drawing in is done as indicated by lines EF and EG, the width of the throat becomes less than the width of the opening and causes the air currents to pile up in the corners of the throat, resulting frequently in a smoky fireplace. B. Correct fireplace construction.

foot of fireplace opening is a good rule to follow. For the fireplace shown in figure 13-A, the opening of which has an area of 8.25 square feet, there is required a flue having an area of 107 square inches. If this flue were built of brick and unlined it would probably be made 8 inches by 16 inches, or 128 square inches, because brickwork can be laid to better advantage when the dimensions of the flue are multiples of 4 inches. If the flue is lined the lining should have an inside area approximating 107 square inches. It is seldom possible to secure lining having the exact required area, but the clear area should never be less than that prescribed above.



Failure to provide a chimney flue of sufficient sectional area is in many instances the cause of an unsatisfactory fireplace. The cross section should be the same throughout the entire length of the chimney. Do not contract the flue at the chimney top, for that would nullify the larger opening below; if it is necessary to change the direction of a flue the full area should be preserved through all turns and bends, and the change should be made as gradual as possible.

#### THE THROAT.

In figure 13-B is shown the throat, the narrow opening between the fireplace and the smoke chamber. Correct throat construction contributes more to efficiency than any other feature except proper flue design. A flue twice as large as is necessary brought straight down to the fireplace without constriction at the throat would result in a poor draft, for the draft does not depend upon the largeness of the flue but upon its proper proportioning to the fireplace and throat. The arrows indicate the upward flowing currents of warm air which are thrown forward at the throat and pass through the smoke chamber into the flue on the inner side. This rapid upward passage of air causes a down current on the opposite side, as indicated by the descending arrows. The down current is not nearly as strong as the up current, but it may be of such force that if there be no throat to the fireplace (see fig. 14) to increase the velocity of the upward current by constricting it, the meeting of the two currents will result in smoke being forced out into the room. Thus it frequently happens that a fireplace has an ample flue area and yet smokes badly. The influence of the throat upon the upward and downward air currents is shown in figure 13-B.

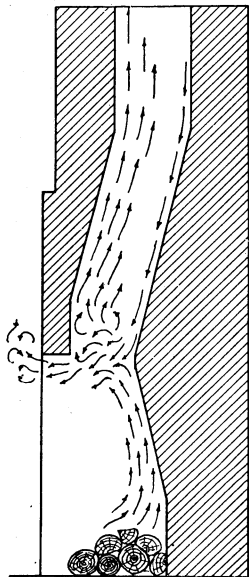

FIG. 14.—Fireplaces constructed like this without throat will very likely smoke.

The area of the throat should not be less than that of the flue. Its length should always be equal to the width of the fireplace opening. (See fig. 13-A.) The sides of the fireplace should be vertical until the throat is passed. (DD in fig. 13-A.) Above the throat the sides should be drawn in until the desired flue area is attained. The throat should be set 8 inches above the location of the lintel, as shown in figure 13, A and B. The wrong way to place the throat damper is shown in figure 15. The throat should not be more than 4 or 5 inches wide. The lesser width is a safe standard.

If a damper is installed the width of the brick opening at the throat will depend upon the width of the frame of the damper, the width of the throat proper being regulated by the hinged cover of the damper. If the throat damper is omitted the opening should be 4 inches, as shown in figure 16. The smoke shelf should not be bricked up but should conform to the dotted lines. The depth of the smoke shelf should be the same for a 2-foot as for a 10-foot fireplace opening.

Proper throat construction is so necessary to a successful fireplace that the work should be carefully watched to see that the width is not made more than 4 inches and that the side walls are carried up perpendicularly until the throat is passed, so that the full length of opening is provided. All masons do not appreciate these fine but necessary points. Many prefer their own and sometimes will ignore the proper methods. It is therefore advisable to inspect the work several times a day as it progresses and thus avoid poor results. When trouble is experienced in an existing fireplace that has ample flue area, it is usually found that the formation of the throat is the cause.

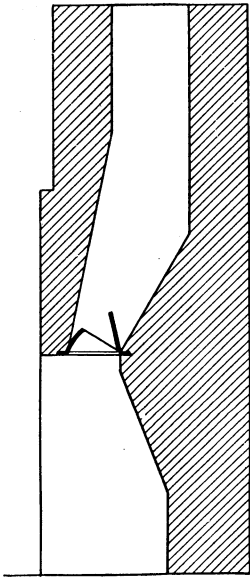

FIG. 15.—Wrong location for throat damper. The throat is so low that the accumulation of gases at the point constricted weakens rather than improves the draft with greater likelihood of a smoky fireplace. Note that the smoke shelf is bricked up. This is wrong.

#### SMOKE SHELF AND CHAMBER.

A smoke shelf and chamber are absolutely essential. The shelf is formed by setting the brickwork back at the top of the throat to the line of the flue wall. The shelf should be the full length of the throat. The depth of the shelf should be not less than 4 inches. It may vary from this to 12 or more, depending upon the depth of the fireplace.

The purpose of the smoke shelf is to change the direction of the down draft so that the hot gases at the throat will strike it approximately at a right angle instead of head on.

Therefore the shelf should not be bricked up as shown in figures 15 and 16, but should be made as wide as the construction will permit at a height of 8 inches above the top of the fireplace opening.

The smoke chamber is the space extending from the top of the throat up to the bottom of the flue proper and between the side walls, which may be drawn in after the top of the throat is passed. The

area at the bottom of the chamber is quite large, since its width includes that of the throat added to the depth of the smoke shelf. This space is capable of holding accumulated smoke temporarily in case a gust of wind across the top of the chimney momentarily cuts off the draft. Smoke might be forced into the room if there were no reservoir to hold it. The smoke chamber also lessens the force of the down draft by increasing the area through which it passes. If the walls are drawn inward 1 foot for each 18 inches of rise, friction is reduced and interference with the draft lessened. The walls should be smooth inside, for roughness seriously impedes the upward movement of the air currents.

#### SHAPE OF THE FIREPLACE.

The shape of the fireplace proper should be as indicated in figure 13-A. The back should pitch forward from a point a little less than half way from the hearth to the top of the opening, and the sides should be beveled as indicated. Straight back and sides do not radiate as much heat into the room.

#### THE THROAT DAMPER.

A properly designed throat damper affords a means of regulating the fire. The damper consists of a cast-iron frame with a lid hinged preferably at the back so that the width of the throat opening may be varied from nothing to 6 inches. There are a number of patterns on the market, some of which are designed to support the masonry over the fireplace opening.

A roaring pine fire requires a full throat opening, but slow-burning hardwood logs require but 1 or 2 inches of opening. Regulating the opening according to the kind of fire prevents waste of heat up the chimney. Closing the opening completely in summer keeps flies, mosquitoes, and other insects from entering the house by way of the chimney.

In houses heated by furnaces or other modern systems fireplaces without throat dampers interfere with even heating, particularly in very cold weather. An open fire must be supplied with air and the larger the fire the greater the quantity required; a fireplace with a width of 5 feet or more may pull air from distant parts of the

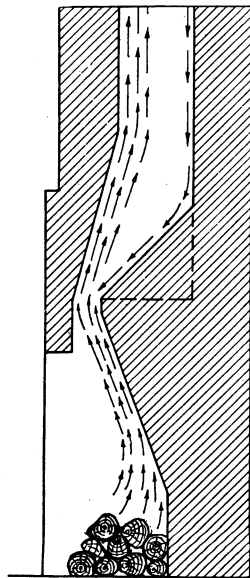

FIG. 16.—This construction without a throat damper directs the down draft so that it meets the up draft almost at the throat, which is more faulty than the construction shown in fig. 13, for there the lid of the damper deflects the down current.

house. This air that is heated at the expenditure of fuel in the furnace is carried up the chimney and wasted, but with a throat damper open only 1 or 2 inches a slow fire of hardwood can be kept going without smoking the room, thus reducing materially the waste of hot air.

#### PLACING THE THROAT DAMPER.

The throat damper should be as wide as the fireplace, so the side walls should not be drawn in until after the throat is passed. Smoke

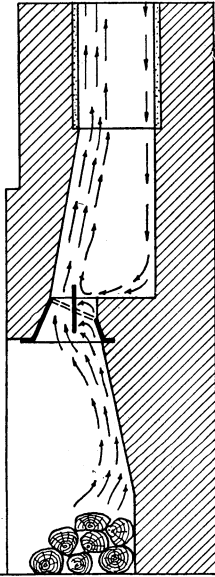

FIG. 17.—Smoke dampers with lids hinged in the center do not turn the up draft as well as do those hinged at the rear side.

dampers with lid hinged at the back will help the smoke shelf to turn the down draft; if the lid is hinged in the center the downward and upward currents are apt to conflict. The placing of the damper varies with the type, but generally the bottom of the frame is built into the brickwork at the level of the top of the fireplace opening, forming the throat and supporting the masonry above it.

#### SIZE OF FIREPLACE OPENING.

Pleasing proportions in the fireplace opening are desirable. The width should generally be greater than the height, but as 30 inches is about the minimum height consistent with convenience in tending the fire, a narrow opening may be made square. Three feet and a half is a good maximum for height of opening unless the fireplace is over 6 feet wide. The higher the opening the greater the chance of a smoky fireplace.

A fireplace should be in harmony with the rest of the room in proportions and details.

This consideration and the kind of fuel to be used largely determine the size of opening.

Generally speaking the day of large farmhouse fireplaces capable of receiving cordwood is past. The tending of fires usually falls to the housewife, and cordwood is a heavier weight than she should handle and can not be stored near at hand. Cordwood cut in two is easily handled; so that a 30-inch width is about the minimum for farmhouses where wood is used for fuel. If coal is burned the opening may be made narrower.

#### DEPTH OF FIREPLACE OPENING.

Unless a fireplace with a 6-foot opening is made fully 28 inches deep, in order that large logs will lie well inside, the advantage of

the wide opening is lost, for the logs will have to be split. A shallow opening throws out more heat than a deep one of the same width, but can take only sticks of smaller diameter; thus it becomes a question of preference between the greater depth which permits of large logs that burn longer and require less frequent replenishing and the shallower which takes lighter sticks and throws more heat.

In small fireplaces a depth of 12 inches will permit good draft if the throat is constructed as explained above, but a minimum depth of 18 inches is advised, to lessen the danger of brands falling out on the floor. Wire guards should be placed in front of all fireplaces. In general, the wider the opening the greater should be the depth.

#### THE HEARTH.

The hearth should be flush with the floor, for sweepings may then be brushed into the fireplace. An ash dump located in the hearth near the back of the fireplace is convenient for clearing ashes and other refuse from the hearth provided there is space below for an ash pit. The dump consists of a cast-iron metal frame, with pivoted cover, through which the refuse can be brushed into the ash pit below. The ash pit should be of perfectly tight masonry and provided with a tightly fitting clean-out door. If a warm-air flue, as described on page 27, is provided, the ash dump will have to be located near one side of the hearth instead of in the center.

#### THE JAMBS.

The jambs of the fireplace should be of sufficient width to give stability to the structure both actually and in appearance. For a fireplace opening 3 feet wide or less, 16 inches is generally sufficient; for wider openings similar proportions should be kept. Greater widths may be required to harmonize with the proportions of the rooms, and the above should be taken as a minimum.

#### FIREPLACE BACK AND SIDES.

The back and sides of the fireplace should be constructed of fire-brick only. The bricks should be laid flat with the long sides exposed, for if placed with the face exposed there is danger of their falling out.

#### SUPPORTING IRONS.

In small fireplaces sagging of the arch over the opening seldom occurs, but in fireplaces over 4 feet wide it is not uncommon. It is due to insufficient support of the masonry. Except in massive construction there generally is not sufficient masonry at the sides of the opening to resist the thrust of arch construction; hence it is usual to sup-

port the masonry with iron, which, if too light, will sag. Too small an iron will become so hot that its tensile strength is lowered until it bends. A heavy flat bar at least one-half inch thick is sometimes used or a T-bar which has greater strength, but less metal; the wider the opening the heavier the bar required.

#### IMPROVING FIREPLACE HEATING.

A number of patents have been obtained for improvements in fireplace heating. Most of them, depending on the fact that hot air rises, deliver air heated in or around the fireplace through a register, located above the fire, into the upper part of the room, which is always the warmest part. Furthermore, they require a specially built chimney, precluding the installation of such a device in an existing fireplace. Unless fresh outside air is supplied there is no improvement in the warming of the room.

Patent No. 1251916, issued to Joseph Parsons, of Lakeville, Conn., and by him assigned to the United States Government, presents means of greatly increasing the efficiency of fireplace heating. The inventor's claim differs from other claims for improving fireplace heating in that the operation of his device depends upon the suction created in the chimney by the hot air rising from the fireplace and therefore makes possible the delivery of heated air through a register located at any place in the room or at the hearth. Furthermore, it permits of installation of one of the simpler types in an existing chimney.

For a fire to burn it must be supplied with oxygen. If a fire were built in a fireplace in an air-tight room it would go out as soon as the oxygen present had been consumed unless a down draft in the chimney supplied the needed air. As our fireplace fires do not go out so long as they are fed with fuel it is obvious that the required air supply is obtained from somewhere. Any one who has depended upon a fireplace to heat a room knows that the part of the room farthest from the fire is the coldest and that the temperature around the windows is especially low. In fact the harder the fire burns the colder it is at the windows. The fire must have air, and as cracks exist around windows and doors the air enters through them. The volume entering is equal to that passing up the chimney. This air comes from outside at a low temperature. Figure 18 illustrates how a fireplace fire supplies its needs. When it grows colder outside a bigger fire is made. The bigger the blaze the greater the quantity of outside air drawn into the room through every crack and crevice until, when the outside temperature gets below the freezing point, there is no comfort in the room beyond the immediate vicinity of the fire.

If a room were so tight that the air leakage were insufficient to supply a fireplace fire, it would not burn properly and would smoke. If a pane of glass were removed from a window cold air would rush in through the opening. If the glass were replaced and an opening of equal area be made through the chimney, as shown in figures 19, A and B, so that air could be admitted into the room as indicated by the arrows in the plan, figure 19-B, an equal volume of cold air would be drawn through this opening. As it comes into contact with the metal form the air becomes heated, so that when delivered into the room its temperature would be 100 degrees or higher, depending upon the radiating surface of the hearth, assuming an outside tem-

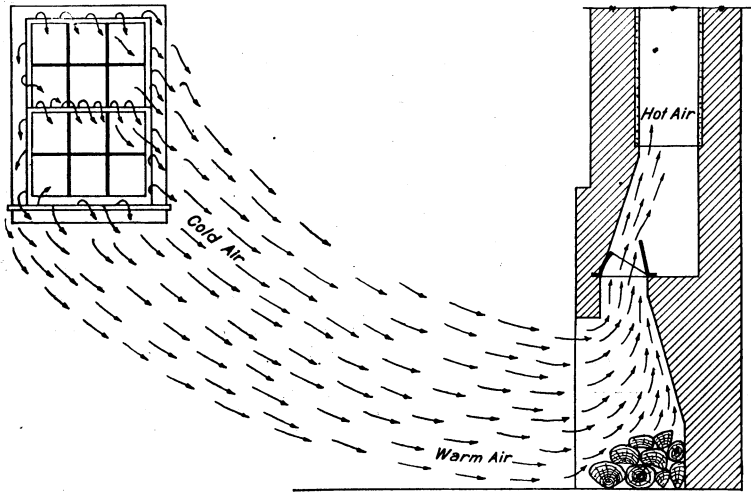
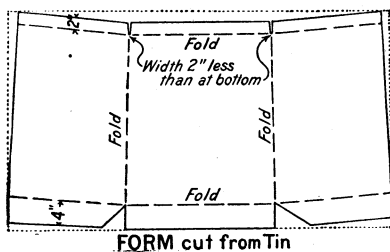
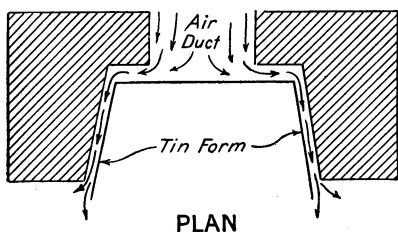
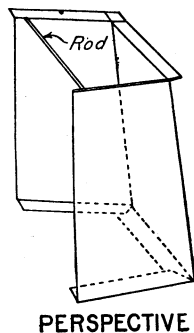

FIG. 18.—All air required for feeding the fire must pass through the room, entering through cracks around windows and doors and producing an uncomfortable temperature in all parts of the room except near the hearth.

perature of 32 degrees. (Tests by the writer have shown this temperature to be higher than 125 degrees.) If the chimney opening be closed and the pane of glass be again removed the temperature of the air entering through the window would be 32 degrees. It is obvious that the room will be more effectually heated when the air required for combustion is supplied at a high temperature than when supplied through cracks and crevices at a low temperature. All our homes should be made fairly tight for greater comfort in winter. In such a house, with doors and windows closed, the suction caused by the fire can thus be utilized to draw into the room outside air heated by the fire on passing through a metal flue on which the fire is burning.

The principle may be applied in various forms. Figure 19-A illustrates a simple form for use in connection with an outside chimney.

A piece of galvanized sheet iron is bent to the proper form and set into the fireplace so as to leave an air space between it and the back and sides of the fireplace. An opening to the outside is made by removing two or three courses of brick. Air enters through this, becomes heated by contact with the metal, and is delivered into the room at the sides of the fireplace, as indicated in the plan of figure 19-B. It immediately rises within the room, gives up part of its heat, and eventually whirls about and into the fire, as indicated by the arrows in figure 19-A. This form would not necessarily heat the entire room effectually; it would, however, supply heated air for the fire in volume sufficient to replace or materially reduce the quantity of cold



B

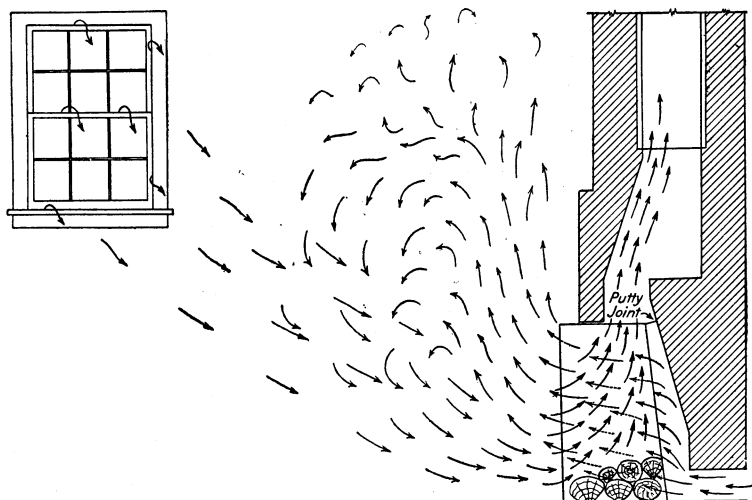

FIG. 19.—Simple form of warm-air flue for outside chimney. Air required for feeding the fire is brought in from the outside around a metal form set in the fireplace, with a space between it and the back and sides of the brickwork. As the cold outside air passes around the metal it becomes heated and is delivered into the room at a temperature much higher than where it is pulled in through window and door cracks. The result is a much more comfortable room.



air which would otherwise enter through window and door cracks. With a brisk fire burning, a rush of warm air can be felt 6 or 8 feet away from the fireplace.

This simple form may be built as follows: A piece of roofing tin about 6 inches wider than the height of the fireplace opening, with length equal to the width of the opening plus twice the depth of the side, should be secured. It should then be marked and cut as indicated in the form (fig. 19-B), and bent into a shape similar to that

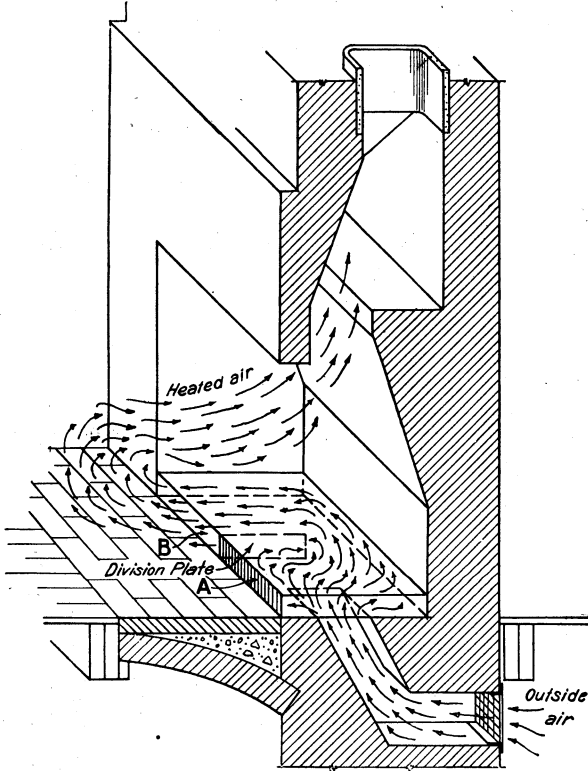

FIG. 20.—Simple form of warm-air flue for inside chimney.

shown in the perspective, same figure. When placing it, there should be a space left between the tin and the brickwork at both back and top. The back and sides at the top should be bent back 2 inches to meet the brickwork. The crack or joint should be tightly closed with asbestos or furnace cement. The tin form rests on the 4-inch bottom flange. The joint here can be made tight by placing a few bricks on the flange and covering with ashes, or a metal plate cut to the proper shape may be laid upon and preferably riveted to the lower flanges of the back and sides. The form should be as high as the opening and the metal sides should project about 3 inches beyond the jambs, so as to throw the heated air well out into the room. A one-fourth-inch rod

placed across the top of the tin form directly under the arch iron of the fireplace assists in holding the top of the tin firmly against the brickwork.

Figure 20 shows a simple form for use with an inside chimney. A hole may be cut in the hearth on one side and connected with the outside by means of a passage through the chimney foundation. The manner of providing this passage will depend upon the construction in the particular case. A galvanized sheet-metal box with a division

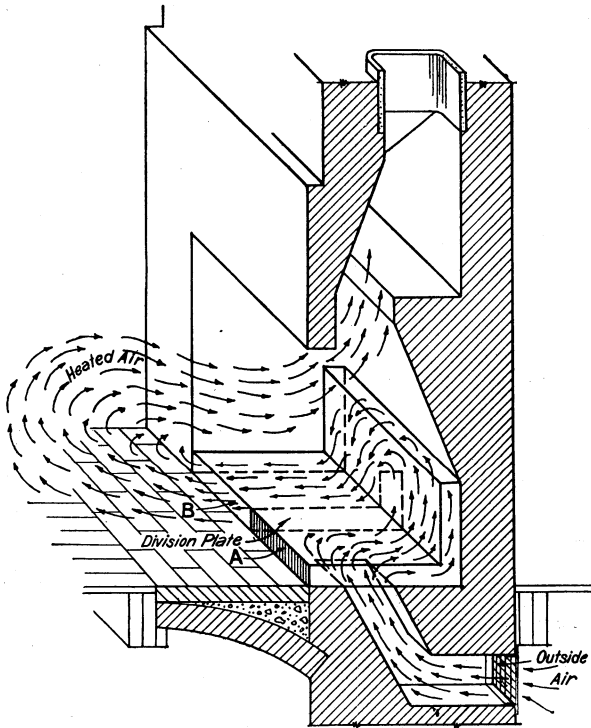

FIG. 21.—Improved form of warm-air flue for inside chimney. The increased radiating surface obtained by conducting the metal flue up the back of the fireplace heats the air to a higher temperature so that it is delivered into the room farther from the outlet duct.

plate extending part way through it is set on the hearth. The side over the opening is bent down in front, as at A, so that the entering cold air must pass to the rear around the division plate and then out into the room in front of the hearth, as at B. The fire, on top of the metal flue, heats the air issuing at B as it flows under it. Figure 21 shows an improved form in which the flue and division plate are extended up the back of the fireplace. This presents considerably more radiating surface, so that the air can be heated to a higher temperature. The air issuing from this flue at B is discharged farther out into the room. If there is a cellar under the floor a metal duct must

be employed to bring fresh air from an opening in the outside wall, just below the joists, to the hole in the hearth. Cellar air should never be sucked through the flue. All openings under the house or through the wall should be screened to keep out rats and mice, and doors should be provided to close the openings entirely if desired.

Figure 22 shows a more elaborate installation. This insures very satisfactory heating with a fireplace fire. The piece A B C D of galvanized metal has a rectangular cross-section. Two or three courses of brickwork are omitted and the metal duct is set into the fireplace, so that radiation from the fire impinges upon its surface

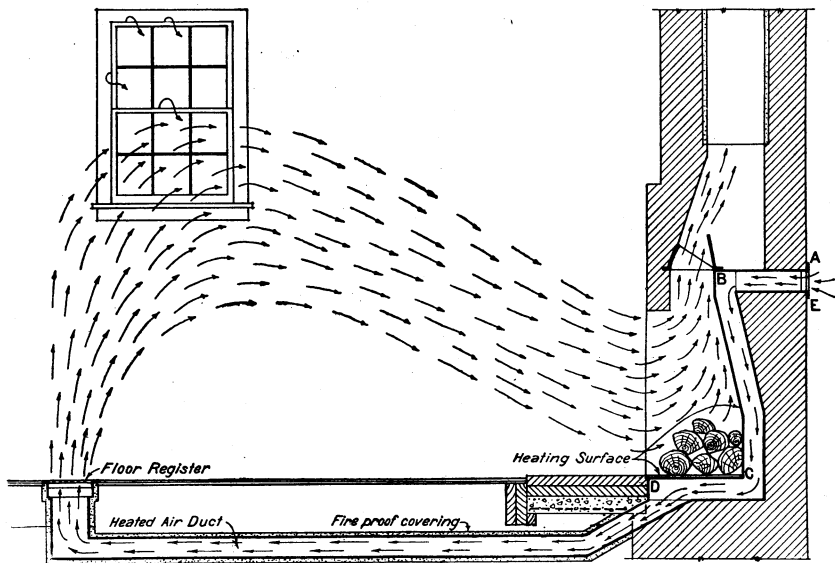

FIG. 22.—Improved form of warm-air flue with floor register. This method increases the efficiency of fireplaces many times by delivering the air that must be supplied, to the fire into the room at temperatures of 100° and higher, depending upon the form and extent of the heating surface at the back of the fireplace, and delivering it to the coldest part of the room so that heat is distributed more effectively and the entrance of cold air around windows and doors is reduced to a minimum.

from B to D. The air entering from outside at AE is heated as it passes through the flue behind and under the fire and is carried through another rectangular duct under the floor to a register located in a far part of the room. Out of this register air in large volume is discharged at a high temperature. This air heats the far part of the room and other parts as it travels from the register upward and through the room to the fireplace. Thus the fireplace heats the room by convection of heat as well as by radiation, and all parts of the room are more comfortable than if radiation alone were depended upon. A test of an installation similar to that shown in figure 22 was made by the writer. The fireplace and suction flue

were built in a cabin measuring 24 feet square by 9 feet high. The test was conducted late in November on a night when the outside temperature was 24° F. It was the first fire built in the fireplace in that season, consequently all the materials of the building were cold. The room was practically airtight; very little leakage could be felt around the windows. A temperature of slightly over 100° was recorded directly over the register, in the center of the room it was 72°, and in the farthest corner a thermometer, hung about 18 inches from the wall between two windows, showed 65°.

Thus the efficiency of fireplaces may be materially increased, the degree depending upon the character of the air duct installed. Even in the simple types the air required to make the fire burn enters the room at a higher temperature at the floor instead of around windows and doors at a low temperature; windows and doors may therefore be made tight, so as to reduce the cold-air leakage. The type with a register in the far part of the room supplies heat to parts of the room or to an adjoining room, which would receive little heat if radiation only were relied upon. This means of improving fireplace heating is particularly adapted to small houses in the South, where the open fire is the most common method of house heating. As the simple types require only galvanized sheet metal bent at right angles, it is within the means and ability of many to supply themselves with flues of their own making.