



DUDLEY KNOX LIBRARY
NAVAL POSTGRADUATE SCHOOL
MONTEREY, CALIF 93940

UNCLASS

DUDLEY KNOX LIBRARY
NAVAL POSTGRADUATE SCHOOL
MONTEREY, CALIF 93940

SECURITY CLASSIFICATION OF THIS PAGE (When Data Entered)

REPORT DOCUMENTATION PAGE		READ INSTRUCTIONS BEFORE COMPLETING FORM
1. REPORT NUMBER	2. GOVT ACCESSION NO.	3. RECIPIENT'S CATALOG NUMBER
4. TITLE (and Subtitle) Passive Solar Heating Residences		5. TYPE OF REPORT & PERIOD COVERED MASTER'S THESIS
		6. PERFORMING ORG REPORT NUMBER
7. AUTHOR(s) Olson, William E.		8. CONTRACT OR GRANT NUMBER(s)
9. PERFORMING ORGANIZATION NAME AND ADDRESS		10. PROGRAM ELEMENT, PROJECT, TASK AREA & WORK UNIT NUMBERS
11. CONTROLLING OFFICE NAME AND ADDRESS CODE 031 (Oregon State Univ.) NAVAL POSTGRADUATE SCHOOL MONTEREY, CALIFORNIA 93940		12. REPORT DATE July 1979
		13. NUMBER OF PAGES 138
14. MONITORING AGENCY NAME & ADDRESS (if different from Controlling Office)		15. SECURITY CLASS. (of this report) UNCLASS
		15a. DECLASSIFICATION/DOWNGRADING SCHEDULE
16. DISTRIBUTION STATEMENT (of this Report) APPROVED FOR PUBLIC RELEASE; DISTRIBUTION UNLIMITED		
17. DISTRIBUTION STATEMENT (of the abstract entered in Block 20, if different from Report)		
18. SUPPLEMENTARY NOTES		
19. KEY WORDS (Continue on reverse side if necessary and identify by block number) Solar Heating, Passive Solar System, Solar Energy		
20. ABSTRACT (Continue on reverse side if necessary and identify by block number) SEE REVERSE		

ABSTRACT

Passive solar heating systems can supply a major portion of a house heating load if properly designed. The four basic concepts used are direct thermal storage in wall or roof, solar greenhouse and convective loop. In applications some of these concepts will be combined to give better overall performance. Technical advances will make passive solar system function better. How far the technology advances to, will depend on how well passive solar systems become accepted. To further the use of solar energy an integrated approach will need to be taken. One which will combine the best of active and passive systems to produce a system that supplies 100% of the house's heating load.

PASSIVE SOLAR HEATING
RESIDENCES

William E. Olson
July 1979
Master's Project

Approved for public release;
distribution unlimited.

T197442

1962
O-5445
11

Approved for public release;
distribution unlimited.

PREFACE

Passive solar heating systems can supply a major portion of a house's heating load if properly designed. The four basic concepts used are direct gain, thermal storage in wall or roof, solar greenhouse and convective loop. In most applications some of these concepts will be combined to give better overall performance. Technical advances will make passive solar system function even better. How far the technology advances to, will depend on how well passive solar systems become accepted. To further the use of solar energy an integrated approach will need to be taken. One which will combine the best of active and passive systems to produce a system that supplies 100% of the house's heating load.

INDEX

	Page
INTRODUCTION.....	1
DIRECT GAIN.....	5
House at Crooked Creek (Severe Climate).....	5
House in Central California (Mild Climate).....	8
Retrofit New Mexico Adobe	8
THERMAL STORAGE IN A WALL OR ROOF	11
Trombe Wall.....	11
Doug Kelbaugh House.....	15
Retrofits	18
Wickle House.....	18
Upper Black Eddy House.....	19
Water Wall.....	20
Focusing Roof Aperature/House in New Jersey.....	22
Retrofits.....	23
Water Roof	23
SOLAR GREENHOUSE	26
Double Box	26
Doug Kelbaugh House.....	29
Hybrid System	29
Retrofits	30
CONVECTIVE LOOP	32
MODIFICATIONS	33
Vertical Solar Louvers	33
HYBRIDS	36
Unit 1 First Villiage	36
Bruce Hunn House	38
Markle Residence.....	39
Solar Atrium	42
Linderberg Residence	44
TECHNICAL ADVANCES TO AID PASSIVE SOLAR HEATING	47
Transparent Insulation	47
Heat Mirror	47
Solar Membrane	49
Optical Shutter	49
Cloud Gel	49
Phase Change Heat Storage	50
Thermocrete	50
Paraffin Base	50
Polyhedral Wall	50
Heat Mirror, Cloud Gel and Thermocrete used Together	51
Movable Insulation	51
Nightwall Panel	51
Beadwall	52

	Page
Movable Insulation con't	
Exterior Shutters	52
Self-Inflating Curtain	52
Heat Pipe	54
WINDOWS	56
Window Design for Energy Conservation	56
Three Generations of Window Development	58
Energy Transport Control in Windows	58
Window Quilt	59
THERMAL DATA REQUIREMENT AND PERFORMANCE EVALUATION	61
Standarized Evaluation Procedures	61
Simulations	62
Simplified Technique/Crosley Home	62
Computer Simulation/PASOLE	63
Evaluation of Passive Solar Heating System Performance.	67
CONCLUSION	71

Appendix 1 through 4

INTRODUCTION

Passive solar heating is defined as using solar energy to heat a building, without the use of non renewable energy. The heating is basically done by letting the sun's radiation into a building's interior, to be stored in some kind of thermal mass or to heat up the air space. Using the sun for heating and cooling goes back to "the ancient Greeks, who enunicated the basic principle of passive heating: face south, where the sun spends the winter; keep the winter winds away by embankments or vegetating; shade against the summer sun; let cooling be done by evaporation water; work with, rather than against, nature. 5A This project will only cover passive heating, but most passive systems can do some cooling. The four basic concepts are direct gain, thermal storage in a wall or roof, solar greenhouse and convective loop. The direct gain concept allows the solar radiation through south facing windows or clerestories to be stored in the walls or floor of the house. Thermal storage in a wall or roof allows the solar radiation to come through south facing glazing and then directly onto thermal storage, with no direct solar radiation entering the living space. Masonry material or water are normally the thermal storage mediums. The solar greenhouse concept uses the solar radiation captured by a south facing greenhouse for heating. Convective loop is similar to flat plate air solar collector, except the air is circulated by the thermosiphon process instead of by a fan. Many houses use a combination of the above concepts to make up their passive solar heating system. These concepts will be covered in detail later.

A house that uses a passive solar system for heating will have to be sealed as well as possible to reduce the, infiltration heating load. In this time of dwindling energy resources any house should be sealed to insure the minimum heating load. Generally the economics of passive solar systems will not be addressed in the project, because it is difficult to assess the cost of the system. The economics analysis that has been done has shown that passive solar heating is economically attractive.

How the sun's path across the sky changes with the seasons, aides the operation of passive solar heating systems. During the winter months the sun is low in the sky, which is good for the collection of solar radiation on a vertical surface. During the summer months the sun is high in the sky, which will help prevent the collection of solar radiation, on a vertical surface. Thus the sun's position in the sky directly enhances passive solar systems operation, by allowing good collection during the winter months and poor collection during the summer months. The farther north a house is located the lower in the sky the sun will be, which will improve the collection of available solar radiation on a vertical surface. For a house to have an effective passive solar system it will have to have a wall that is within 20 degrees east or west of south, which has no obstacles in the path of the solar radiation to the wall area. The house shape that will provide the optimum collection of solar radiation is a form elongated along the east-west direction.

Exhibits 1, and 2, will give some idea of how well passive solar

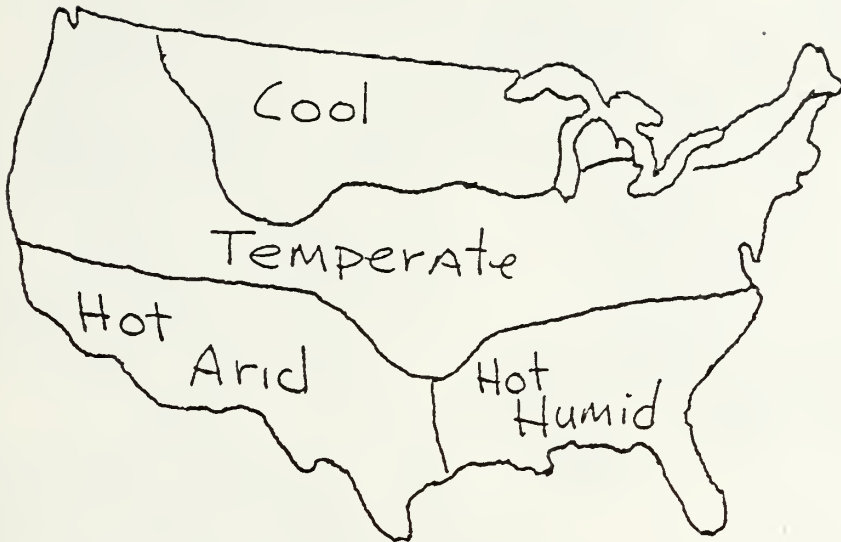

(Based on national averages; not to be used for design purposes)

CLIMATE REGIONS OF U.S.

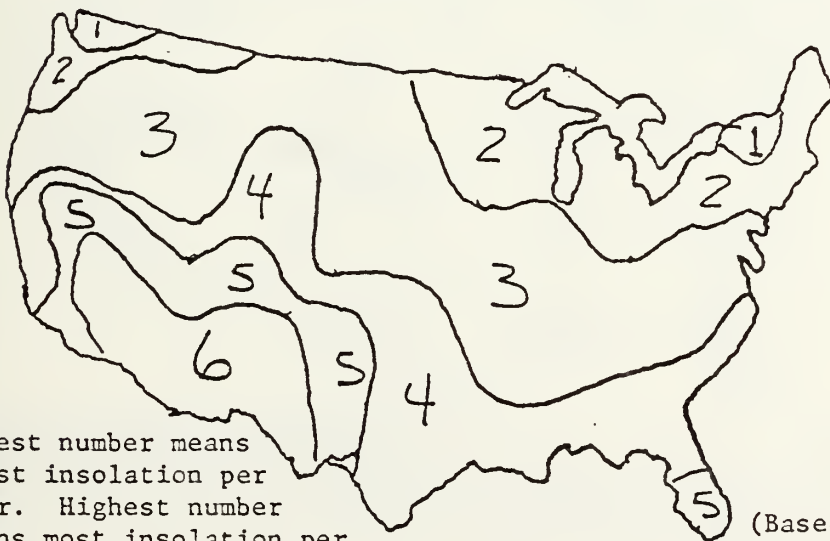

Lowest number means least insolation per year. Highest number means most insolation per year.

(Based on national averages; not to be used for design purposes)

ANNUAL MEAN DAILY SOLAR RADIATION

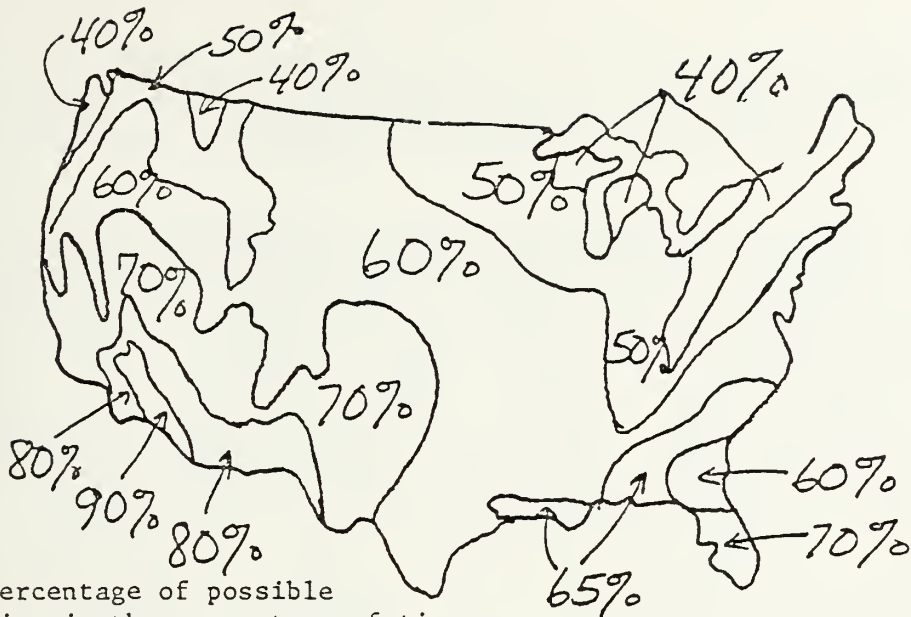

The percentage of possible sunshine is the percentage of time during the average year that the sun is bright enough to cast a shadow across a surface, divided by the number of hours the sun is above the horizon.

ANNUAL MEAN PERCENTAGE OF POSSIBLE SUNSHINE

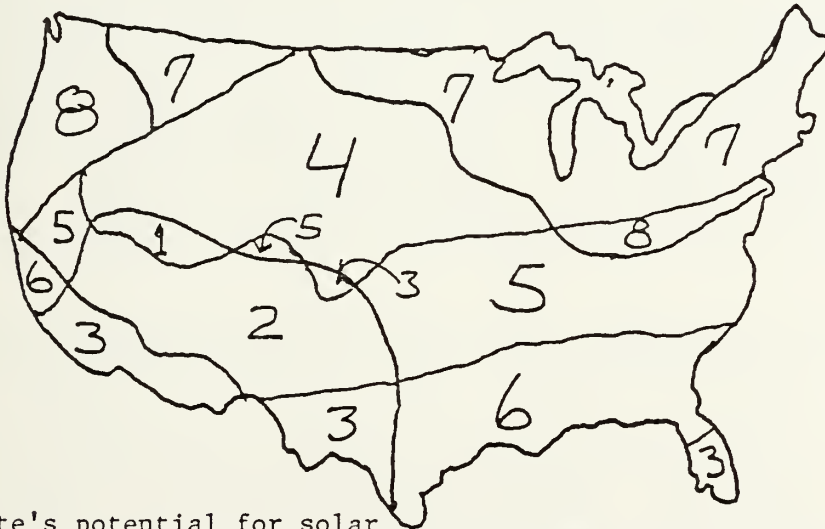

Climate's potential for solar heating during heating season: Excellent sunshine is combined with high heat demand in area 1, moderate heat demand in area 2, and low heat demand in area 3. Good sunshine with high heat demand in area 4, moderate heat demand in area 5, and low heat demand in area 6. Fair sunshine is taken from TRW, Phase 0 Study, "Solar Heating and Cooling of Buildings," National Science Foundation, 1974

systems will perform in different parts of the country.³ These maps show that passive solar systems could be used throughout the United States, with the worst performance in area seven of exhibit 2.

An important factor to consider when designing a passive solar system is the microclimate of the area the house is located. Often the weather patterns surrounding one house will be different from a neighbors house. These factors may be natural wind breaks, large bodies of water, mountains, valleys, open plains, landscaping and or proximity to surrounding buildings. Whatever the microclimate is it should be considered when designing a system. Another thing to consider is the benefit gained from broad leaf trees. These trees will be bare during the winter months, thus allowing solar radiation through, and full of leaves during the summer months providing shade to keep the house from overheating. The biggest problem with passive solar systems is the temperature fluctuations. For a passive system to work there has to be changes in temperature, but if the system is improperly designed the temperature changes can be too great. Initially, the lack of adequate design parameters resulted in some poorly designed systems, which had large temperature fluctuations, and has given passive solar systems a bad name. The expericene gained from the initial design attempts has produced better design procedures, but the procedures are still too complicated for general use to be adopted.

The problem of overheating has resulted in the use of fans to transport the excess heat to a separate storage medium. The use of a fan in passive systems has created a conflict among designers. The purest position is that the use of an electric fan makes the system an active one. Others try to put a coefficient of performance (50) limit on when a system is passive or active. As far as this project is concerned, as long as the basic system falls within one of the passive concepts, then it is a passive system. If a fan can increase the system's performance then it is the logical thing to do. The systems with a fan will be referred to as hybrid passive solar systems.

People who have lived in houses with passive solar systems, that operate correctly, have liked the interior environmental conditions. Passive systems do take some time to learn how to operate, to get the most comfort, but once the system is learned the interior areas can be kept comfortable. A factor to consider with systems that use radiant heat, is the interior air temperature can be lower than conventional systems and still be comfortable. The reason for this is the radiant heat from the wall or floor can be felt as warmth. Also to be considered with a passive system is that there is no noise from mechanical equipment.

DIRECT GAIN

The direct gain passive solar system is the simplest approach when using solar energy. The system simply allows the solar energy to enter through south facing windows and be absorbed in the mass of the house. The reason this system works is solar energy (short wave radiation) will pass through the glass, with very little loss in energy, and be absorbed by the mass of the house, which will then emit long wave radiation that will not pass easily through the windows. The windows will be a large source of heat loss due to the inside-outside temperature difference and the window heat transfer coefficient (U). A method used to overcome this heat loss is to use movable insulation, to be covered later, to cover the windows when there is no solar energy available, mostly at night. A direct gain system will need an overhang to prevent the summer sun, which comes from large angles from the horizontal, from coming into the house. 5B

The problems with direct gain systems are large temperature swings, expensive thermal storage mass, strong directional daylighting, glare, and ultraviolet degradation of fabrics. There will also be temperature swings of 15 to 22 degree fahrenheit during the winter months, which can be unacceptable to some families. These large temperature swings are also an indication that the system is not working very well. The movable insulation can help the situation, but there is still the overheating which is energy that could be stored at a lower temperature, and thus last longer and be available when there is no solar energy. 5B

The best and most economical place to put the thermal mass is the floor, but a masonry floor that can't be covered by rugs, furniture and other things normally used in a living space would be unacceptable to most families. The area generally used is the walls, which is more expensive to install. There is also the problem of getting sufficient area that is directly in the sun's rays. Thus the walls will require extensive and expensive mass. The roof can be used for thermal storage, which would be very effective because heat raises. The obvious drawback is the expense of using heavy thermal mass on the roof. With the use of a phase change material the excessive weight could be somewhat eliminated. The following exhibit 3, shows the basics of direct gain passive solar heating.

HOUSE AT CROOKED CREEK (SEVERE CLIMATE)

A house constructed in Dubois, Wyoming, which has a 10 month heating season and is very cold, was designed to use passive solar energy. The house was designed as a long structure with three large clerestories facing south. The clerestories allowed the direct radiation to enter the rooms above eye level, thus reducing glare and filling the space with reflected light. The house is very well insulated and includes an air-lock entry. Reinforced concrete block forms most of the house, and along with an 8" concrete floor slab make up the thermal storage of the house. The insulation in the wood walls and roof is R-22, in the block walls (urea-formaldehyde foam sprayed in wall cavity) is R-30, and a 4" styro-foam board at the slab edge (R-18) is used. All the glass is thermopane. Roofing is corrugated metal. 5C

Winter Heating Day

N ← → S

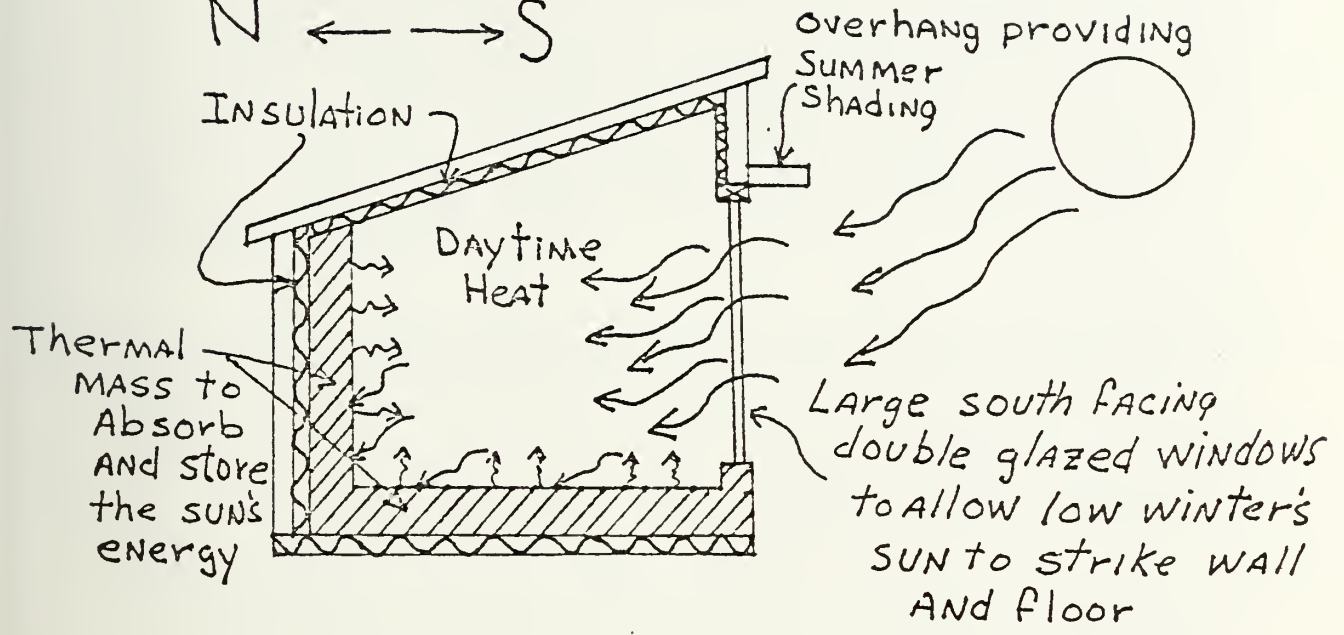

Winter Heating Night

N ← → S

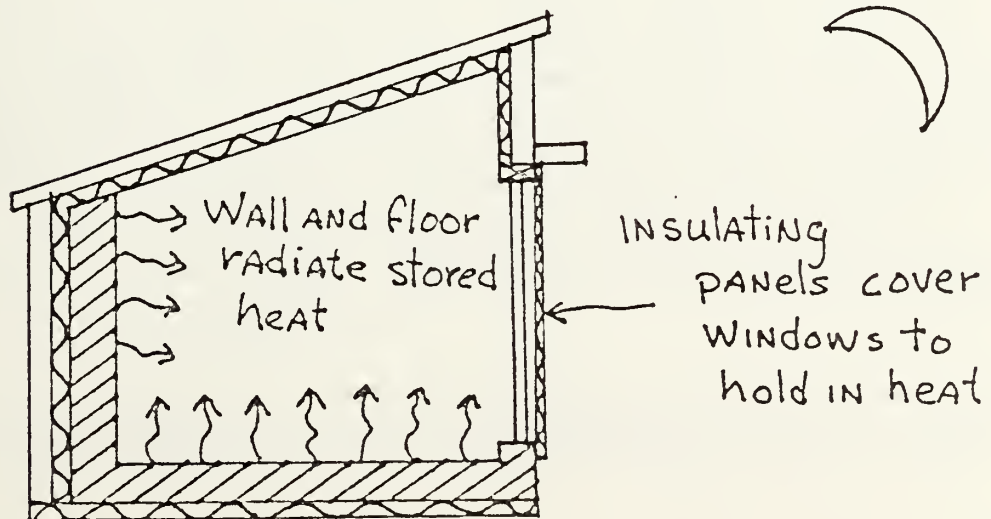

The collection of solar energy is by the clerestories which had to be sized to insure sufficient energy could be collected. The glass area calculations were based on a minimum exposure to a 15 degree angle of incidence (December 21 average, 45 degree north latitude). After heat loss calculations, the window calculations resulted in 100 square feet for each living area and 85 square feet for each bedroom. Total insolation was calculated to be 2,300 BTU per square foot per day, of which 2,000 BTU per square foot per day (December 21) is direct radiation, plus 15% for clear day reflected radiation, and also some diffuse radiation. Transmission of radiation through thermopane glass is 75%, which gives a total radiation entering the house of 1,725 BTU/ sq. ft./day. The windows were inset 12" to try and maintain a cushion of still air in front of the windows and thus minimize daytime heat loss. 5C

The storage of energy is in the walls and floor. Direct radiation strikes the plastered block walls (sand finish to help insure diffuse reflection) and reflects the radiation to the floors. 25 to 30% of the direct radiation will be absorbed by the walls as determined by the thermal admittance and acceptance of the masonry masses. The acceptance and admittance formulas are by Mazria: Solar Energy Workshop Workbook, December 5, 1975. The masonry wall can admit, or store, 45-50 BTU/sq.ft./hr. of the approximate total heat exposure of 200 BTU/sq. ft./hr. before overheating at the surface. Which is why the light color for the wall surface was selected to allow only 25 to 30% of the radiation striking to be absorbed. The black slate finished floor accepts 90 to 95% of the radiation striking it. This process of calculating and balancing color allows the maximum storage of energy, by minimizing surface overheating. This helps to insure energy for nighttime heating. The mass in the building is calculated to store one days heat within a 10 degree fahrenheit temperature swing (65 - 75°F). The amount of mass was determined from the thermal capacity of the walls and floor. All calculation assumed R-8 Technifoam shutters over the south clerestories at night. 5C

The actual performance data was collected without the shutters. During clear days the temperature fluctuated about 15 degrees (60 - 75) with outside temperature ranging from 10 to 25°F daytime and -10, -0°F at night. There was a need for approximately 2 hours of nighttime heating with a "Franklin" woodstove. The house used one half cord of white pine from August to the end of November. There was only a maximum 5 degree temperature difference between the floor and the peak of interior spaces, because the mass radiates very slowly and gradually, causing the heat to migrate slowly. The house was monitored for a four day period of continuous snow. During this time outside temperatures ranges from -10°F to -35°F, while the house never fell below 50°F without any auxiliary heating. The reason this temperature can be maintained is there is enough diffuse radiation reflected into the house to maintain this temperature. This also shows what can be accomplished with a well insulated house. 5C

When the walls and floor are warmer than the air space, as it is with a direct gain house, the house is comfortable at 65°F as compared to 75°F in a conventional house. Also around sundown when the house

changes from direct solar radiation heat to thermal energy (from the walls) the house will experience a chilly period of about 30 minutes. Once the walls begin to radiate, the house feels warm again. 5C

HOUSE IN CENTRAL CALIFORNIA (MILD CLIMATE)

A passive solar house that is located in a mild climate (central California) has been designed to give essentially 100% passive solar heating and cooling. Only the heating will be addressed in this project. The location has 589 degree F days of heating with a relatively dependable sunshine and large diurnal swings (28 degrees in winter and 32 degrees in summer). The house was built with materials and construction techniques standard to the area, and has 1,500 square feet of living area. This requires only 400 square feet of south facing glass and 2,000 square feet of thermal mass (mostly 2" thick), which will allow the system to operate 24 hours a day. The temperature swing predicted for this house is 22 degrees F (64°F to 84°F). This does not take into account movable insulation on all south facing windows, which would improve the performance. 5G

The thermal storage is based on diurnal storage, which is optimal at about 2". The floor is a 4" slab on grade, on concrete block wall capping, laid on a wood decking, filled with grout and sealed with wax, to give a light colored semi-reflected finished, so that the insolation will be spread over all the high mass surfaces. The thermal mass on the walls are 2" plaster where the sun strikes the walls from one side and 4" plaster where the sun strikes the surface from both sides. 5G

Collection of solar energy is accomplished as shown in exhibit 4. This design shows that with the proper climate conditions a house can be heated and cooled almost 100% by passive solar energy, and be built using materials and construction techniques standard to the area, keeping costs down. An example of how costs compared to a conventional house, is the cost of the high mass wall which was 70¢ per square foot, as compared to 63¢ per square foot for a typical 1/2" gypsum wall with 2" X 4" studs. There is no actual performance data available. 5G

RETROFIT NEW MEXICO ADOBE

The retrofitting of a direct gain system to a house will usually take considerable remodeling if the system is going to be effective in using solar energy. The house will also have to have a large amount of south facing wall. To install the needed south facing windows and storage mass in the house will probably require structural changes, which would be very expensive. Where retrofitting can be effective is if the house already needs extensive remodeling, and is situated such that there will be sufficient south facing wall area. An example of this type of remodeling is an adobe house in Alcalde, New Mexico. This house needed extensive repairs. The owner decided to convert to solar energy (direct gain) with the remodeling. The house was ideally suited in that it was made of adobe, giving it mass, and had sufficient south facing wall. The solar retrofitting with remodeling cost \$15,000, as compared to \$14,000 that a contractor estimated for just the needed repairs. The estimated total heat loss, with a 15 degree F

House Located in Central California
Moderate Climate
Dependable Sunshine

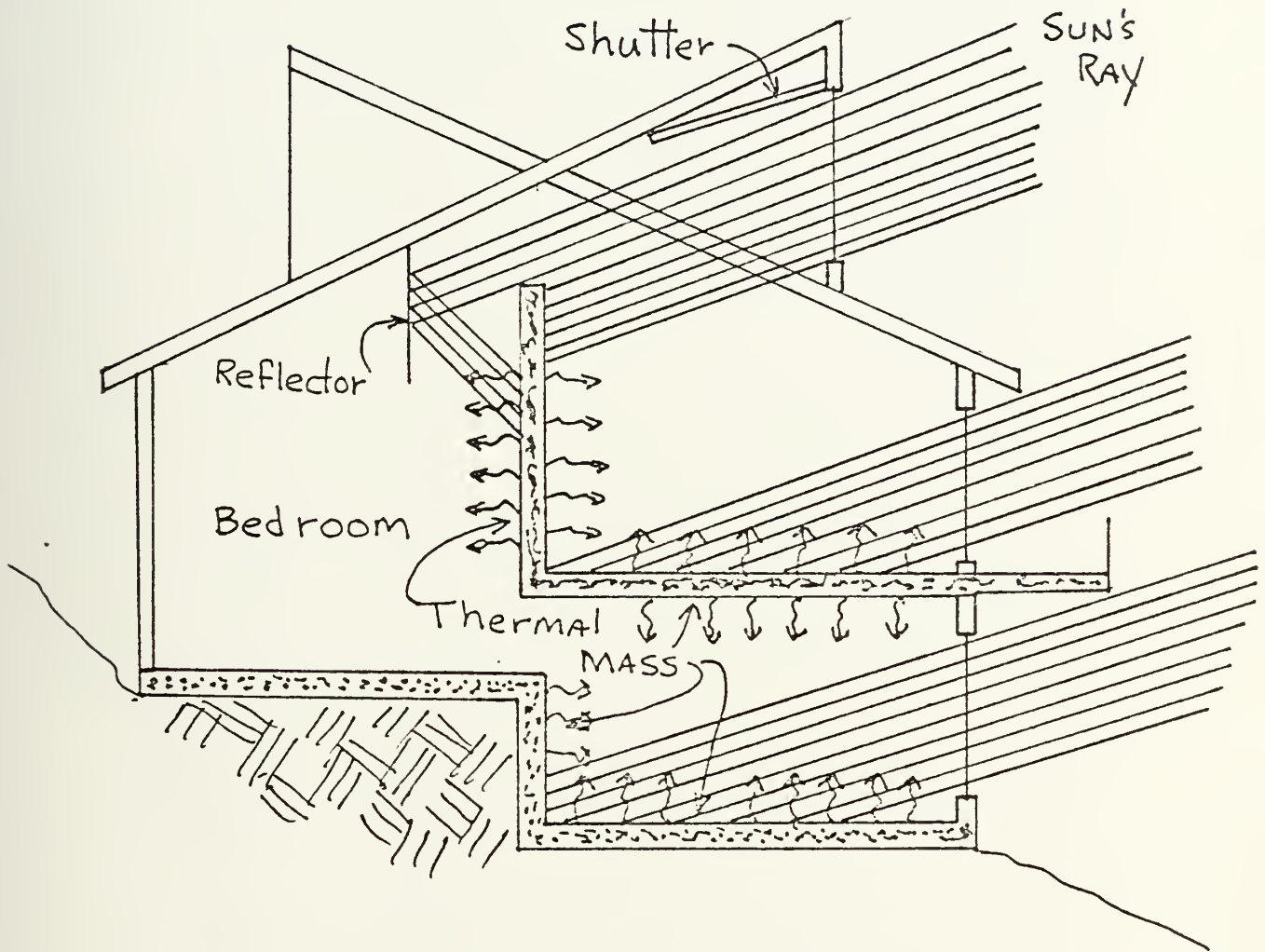

EXHIBIT 4

average 24 hour temperature, is 185,000 BTU/day. The estimated solar gain through the 180 square feet of window is 180,000 BTU/day. The 180,000/day is based on 1,000 BTU/sq. ft./day, which is a clear day value. The south windows have reflectors which will increase the energy gained (30% by Steve Baer's rule of thumb), and should make the house very close to 100% passive solar heated, considering the area of New Mexico. 5K

THERMAL STORAGE IN A WALL OR ROOF

TROMBE WALL

The Trombe Wall, named for Dr. Felix Trombe one of it's developers, is a passive system that uses thermal storage on the south wall of the house. The exterior of the wall is painted a dark heat absorbing color, to insure as much energy is absorbed as possible. There will be either one or two layers of glazing mounted several inches from the wall. If it is desired to have both daytime and nighttime heating the wall will have to have vents at both the top and the bottom of the wall. These vents will have to have dampers to prevent the reverse flow of heat through the vent and out the windows at night. Exhibit 5 shows basically what a Trombe Wall is and how it works.

As exhibit 5 indicates solar radiation (short wave) passes through the glass and is absorbed in the wall. The thermal energy, in the wall being at a low temperature, producing long wave radiation, will not pass easily through the glass, thus capturing the solar energy in the house. Exhibits 5 and 6 also show that the daytime heating is done by a natural convective loop, and nighttime heating is done by radiation from the thermal storage wall. 5B

In the Trombe Wall, the selection of how much and what kind, of material to use for the wall is critical. Normally masonry is used for the material, but with the development of phase change materials (to be covered later) there may be a switch to this less space consuming material. Temperature swings, as experienced with direct gain systems, can be reduced, due to the smoothing achieved as the temperature wave diffuses through the wall. There is also a time delay between when the solar energy is absorbed and when the energy enters the house. Usually this time delay is from 6 to 12 hours, which gives the maximum heating when most needed, at nighttime. Exhibits 7 and 8 show the smoothing effect and the time delay of th Trombe Wall. 5B

The results in exhibit 7 are more extreme than would be observed in a house, since test rooms have a large ratio of collector area to load (4.3 sq. ft. of collector per BTU/hr. °F), and consequently the inside temperature averages about 50 degrees F above the outside temperature on sunny midwinter days. 5B

The thickness of the wall can be some what flexible because of the time delay. The thickness that gives the maximum annual energy yield to the building is 12 inches. With a 12" wall there will be too much of a temperature swing, which results in uncomfortable periods when there is an extended cloudy period. The usual design uses a 16" wall, which will give more storage and less of a temperature swing. The exhibit 7 lists the characteristics of a solid concrete wall during sunny days with double glazing. 5B

The Trombe Wall can be used a number of ways as a passive solar system. The Trombe Wall can be used by itself, but will need the vents for daytime heating. The Trombe Wall can be combined with an attached greenhouse, still using the vents. The Trombe Wall can also be used

Winter's Heating Daytime

N ← → S

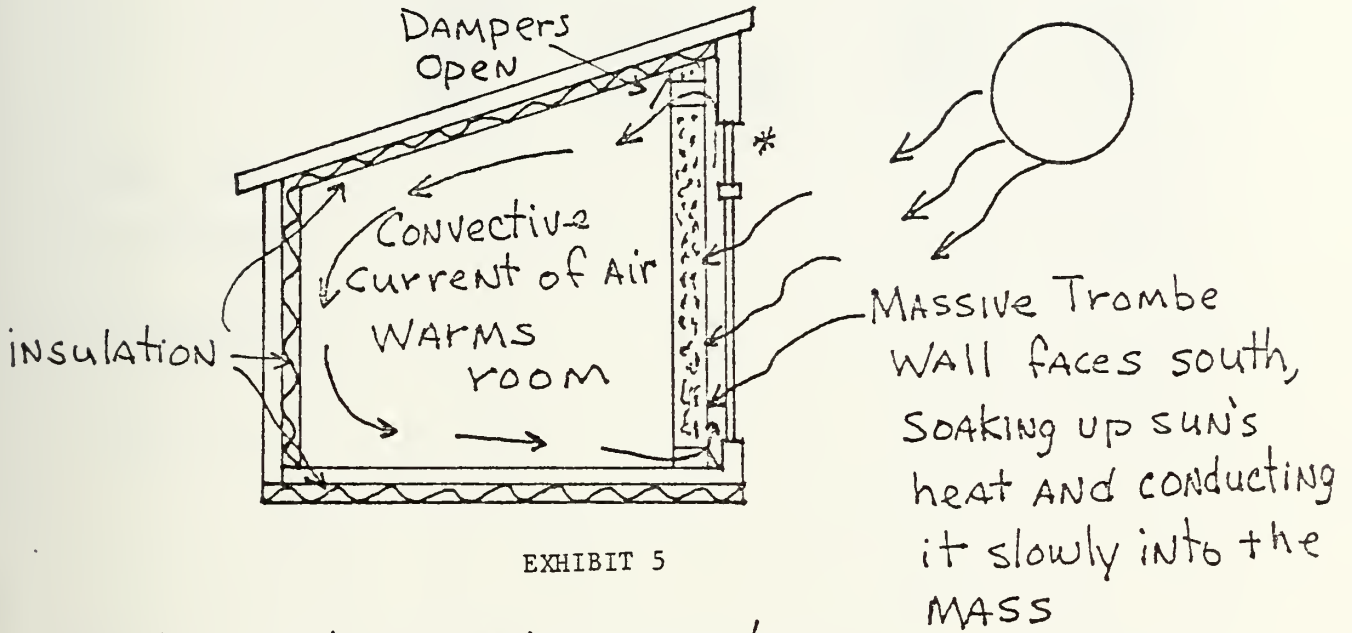

EXHIBIT 5

* This section can be opened so that during summer the heat CAN go outside instead of over-heating the inside of the house

Winter's Heating Nighttime

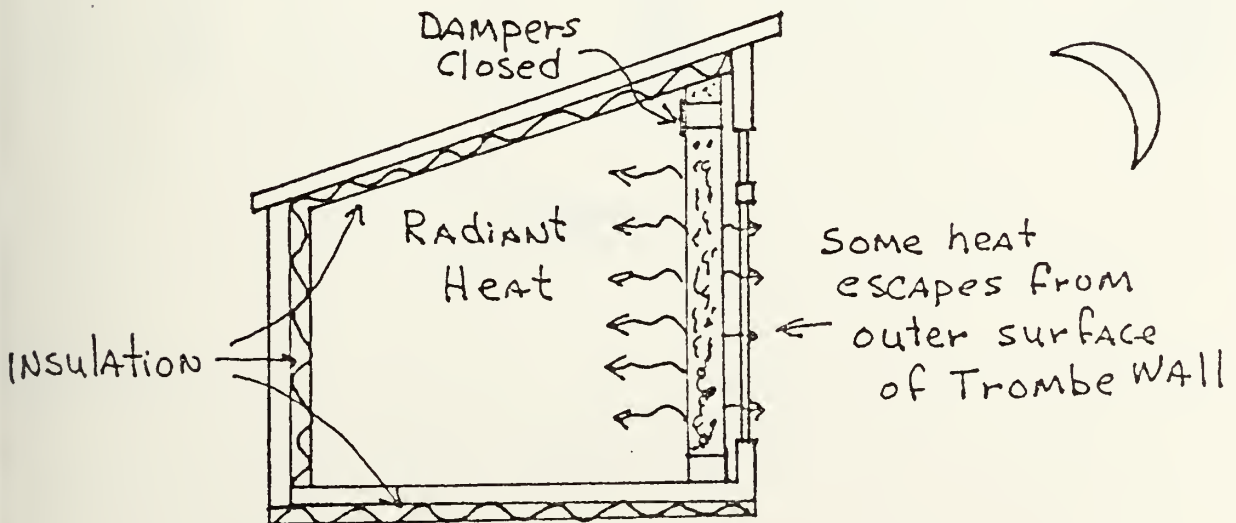

EXHIBIT 6

	<u>THERMAL STORAGE MASS BTU/°F</u>	<u>THERMAL STORAGE SURFACE AREA/ GLAZING AREA</u>	<u>INSIDE DAILY TEMP. °F SWING</u>	<u>TIME OF INSIDE TEMP. PEAK</u>
DIRECT GAIN	37	2.8	38	3:00 P.M.
16" TROMBE WALL (WITH VENTS)	32	0.84	26	4:00 P.M.
16" TROMBE WALL (NO VENTS)	32	0.84	9	10:00 P.M.
WATER WALL	35	1.01	25	4:00 P.M.

<u>THICKNESS INCHES</u>	<u>INSIDE SURFACE TEMPERATURE SWING</u>	<u>TIME DELAY OF PEAK ON THE INSIDE</u>
8	40°F	6.8 hrs.
12	20°F	9.3 hrs.
16	10°F	11.9 hrs.
20	5°F	14.5 hrs.
24	2°F	17.1 hrs.

EXHIBIT 7

Bruce HUNN Trombe Wall

Profile at the 15' Level

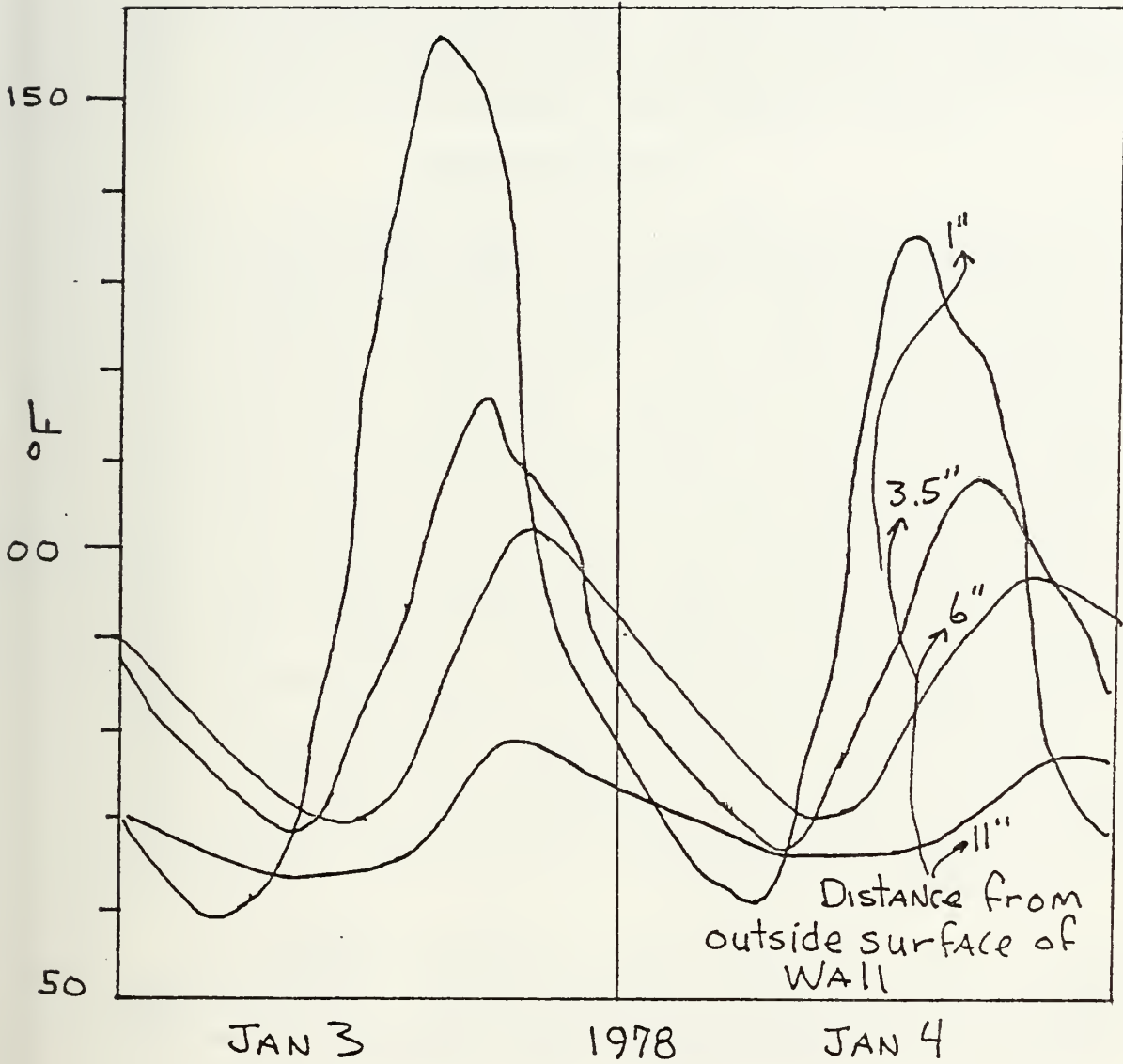

EXHIBIT 8

TEMPERATURES MEASURED IN A TWO-STORY THERMAL STORAGE WALL. THE WALL IS MADE OF 12" HOLLOW CONCRETE BLOCK FILLED WITH MORTAR. THE WALL IS DOUBLE-GLAZED AND HAS NO VENTS

just as a nighttime heating device, no vents, and some other form of heating during the day. How the Trombe Wall is used will be up to the designer.

The problems with the Trombe Wall is the high cost of construction, it takes up valuable space within the house, and it may not have a pleasing appearance to some people. The problem of loss of heat at night, through the windows, can be reduced by using movable insulation between the wall and the glazing. Any overheating that takes place, can be resolved, but with proper design shouldn't happen.

DOUG KELBAUGH HOUSE

The Doug Kelbaugh house uses the Trombe Wall with vents as its passive solar heating system. The Trombe Wall is constructed of 15 inches of concrete, which has been painted with 3M Nexel (special black coating) over masonry conditioner. There is double glazing in front of the wall, giving a total of 600 square feet of collection area, plus the attached greenhouse. The vents are located at the top and bottom of each floor level. After the first winter's occupancy it was discovered that dampers were needed to stop the reverse thermosiphoning. The dampers were made so that they would operate passively, and are made from a light cloth over a screen that would only allow flow in one direction. The house also has an attached greenhouse, which will be discussed at a later time. Since the house is two stories there was a problem with the upper story always being hotter than the lower story. This was resolved by closing off the lower from the upper level. Exhibit 9 is a schematic of the house's heating system. The house has 2,100 square feet of floor area and a volume of 19,000 cubic feet. The heat loss for the house is about 65,000 BTU/hour at 0°F. The backup heating is a gas fired hot air furnace that can deliver 58,000 BTU/hour. There are also three 250 watt heaters in the bathroom to provide instantaneous heat. The additional cost estimated to be attributable to the solar heating and cooling system is \$8,000.00 to \$10,000.00. This cost for a solar system may seem high, but the following exhibit 10, shows why it is worth the extra money. 5DD

The house had a temperature swing of 5 to 10°F over a 24 hour period. Daytime temperature setting was between 60 and 64°F and the nighttime setting was 58°F. These settings were acceptable because the radiant heat from the wall allows lower room temperatures to be comfortable. The estimated downstairs average was about 63°F while for upstairs it was 67°F. 5DD

Since this system obtains a high percentage of total heating from solar it makes the high cost acceptable. When maintenance costs, reliability and convenience are also considered the system is even more and more appealing.

The Trombe Wall concept can be used with no vents directly into the living space, but with a rock bed storage system in which the air between the Trombe Wall and glazing is passed through. The Bruce Hunn house is an example of this kind of system, but since it is considered a hybrid system it will be covered later.

Doug Kelbaugh House

N ← → S

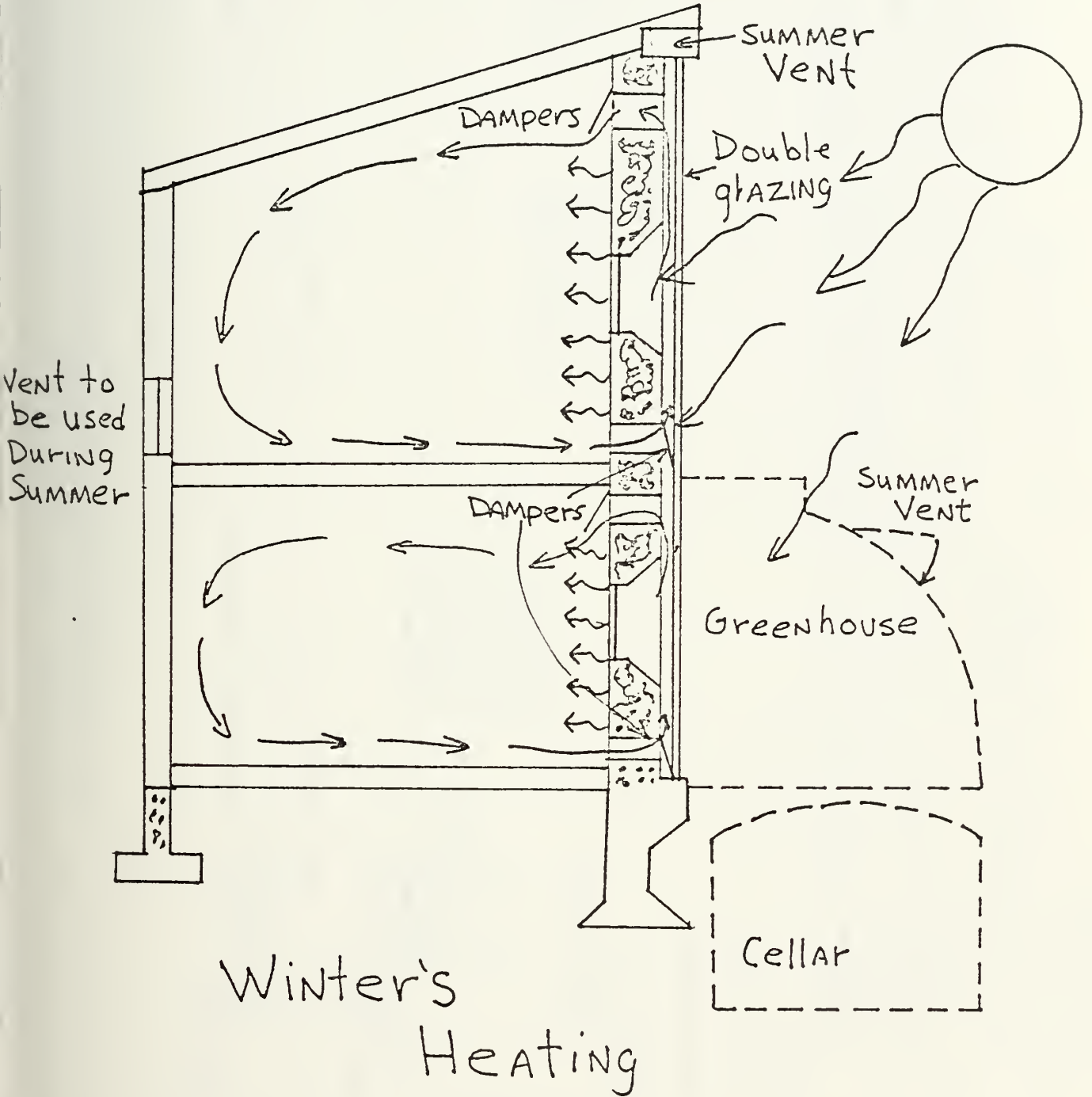

RETROFITS

WICKEL HOUSE

Retrofitting a Trombe Wall on an existing house is not too costly if the house already has a south facing masonry wall. The system will probably not be as effective as a new construction system, but it should reduce the heating bill. Two houses that were retrofitted with Trombe Walls are the Wickel House in New Jersey, and the Upper Black Eddy House in Pennsylvania. The Wickel House is a converted vacation lodge with over 7,000 square feet of living space, with three stories. One gable end is exposed to 5 degrees west of true south. Since the house was originally designed as a lodge, it was possible to limit the heating load for the solar system to 2,200 square feet of living space in five separate zones. The total heating load for this portion of the house was estimated to be 205 million BTU per heating season. The south end of the basement and first floor (432 sq. ft.) was constructed of hollow core cement blocks, which was ideal for retrofitting a Trombe Wall. 5D

The first step in constructing a Trombe Wall was the preparation of the surface of the wall. The surface already had a rough coat plaster job, which was nice for solar absorbance and creation of air turbulence for efficient heat transfer. The wall was blackened with a thin slurry of mortar mix, with black masonry pigment added. The air space for the Trombe Wall was formed with 2 X 4's, giving a three inch air space. The perimeter was then caulked inside and out with caulking, and lined with one inch fiberglass drop-ceiling insulation. Lead anchor shields were placed in the masonry at 30 inch centers across the wall. The glazing was attached as indicated in exhibit 11.

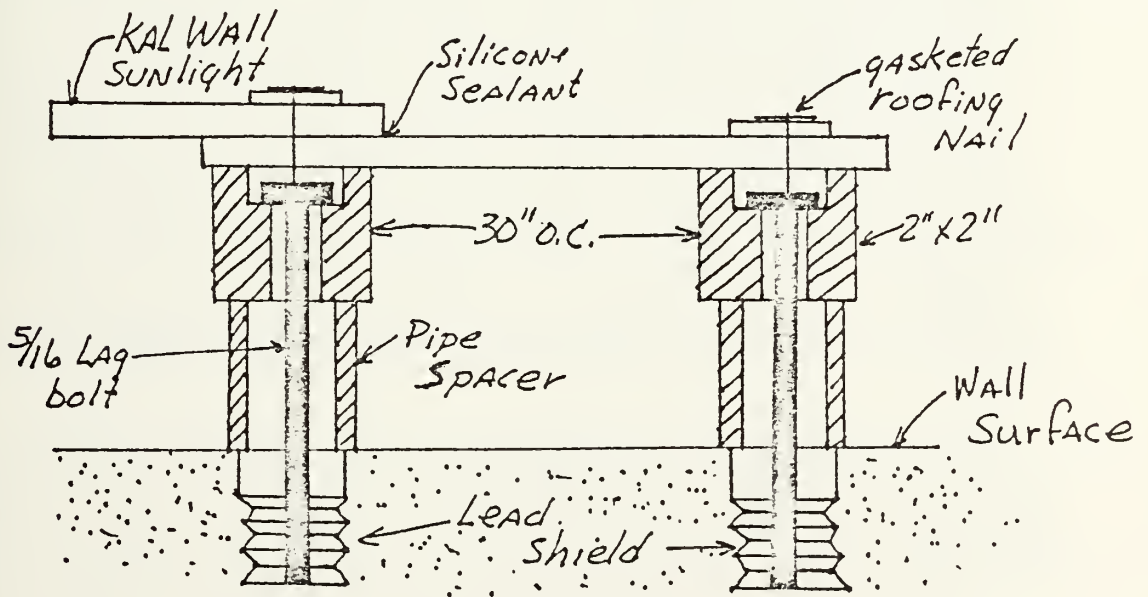

This type of construction provides a clear span for effective air

distribution. It can also compensate for irregularities in the wall by varying the pipe spaces length. All the forming members were painted white to reduce the amount of heat they absorbed. Three 6" X 12" vent holes were cut at the top of the collector to allow air flow into the third and fourth floor areas. 5D

The system operates by convective air being fed through the basement windows, then by opening or closing selective windows and vents, the heat can be directed to any of five living areas as desired. Dampers are used to prevent reverse thermosiphoning. The 8" hollow block doesn't provide very much thermal mass, which is why the insulation and sheet rock were left on the south wall. By leaving the south wall the way it was helped reduce the overheating problems. 5D

The air entering the Trombe Wall via basement windows was 38 degrees, with the exhausted air ranging from 100°F to 122°F. Since no air flow measurements were taken, these temperatures have very little meaning. During winter days, use of the wood stove has been virtually eliminated. The limited thermal mass gives very little storage, which means when the sun goes down the system is of very little use. The fact that the area has nearly perpetual snow cover and clear skies improves the systems performance. The Wickel family has been pleased with its performance. The best feature of the retrofit is the low cost. The total expenditure for materials was \$378.55, resulting in 88¢ per square foot of collector area. 5D

UPPER BLACK EDDY HOUSE

The Upper Black Eddy House is a two story stone farmhouse with 1,000 square feet of living space. The heating load is 110 million BTU per heating season. The primary source of heat is a small log-burner wood stove. The house has one side that is 5 degrees east to true south. After deletion of obstructions there was 28' by 5' of stone wall exposed to the sun, of which one third is window space. To make full use of the limited space available for Trombe Wall it was decided to use double glazing. The construction of the Trombe Wall was similar to the Wickel House but had to be modified to accept double glazing, in lieu of single Kal Wall. The builder, taking advantage of good deals, got the materials for the project for \$113.00, or 81¢ per square foot of collector. The materials used caused the labor time to increase considerable over the Wickel House. The house has a 15 degree pent roof sloping away, for 10 feet, from the base of the collector, which will improve its efficiency. 5D

The system operates by air being fed into the collector via the lower sash of the three windows and exhausted through vents cut into the eaves, where it ties into an existing unused insulated hot air duct system. The hot air is then fed into the second floor near the ceiling. The second floor will quickly reach 60 to 65°F with moderate insolation, but as inlet air temperature increases the heat transfer becomes inefficient, thus slowing down the thermosiphoning. There are plans to install a circulating fan to help direct the air through out the house for a more even heat distribution, and to help maintain the thermosiphoning loop. This system will not meet a major percentage of the overall

heating needs, but it will be significant enough to make the investment worthwhile. No actual performance data was available. 5D

Retrofitting a Trombe Wall to an existing house will not give the same kind of performance as a new construction system, but as shown with the Wickel House and the Upper Black Eddy House satisfactory performance can be obtained at a minimum of cost. This is important because it allows homeowners in the lower income strata to take advantage of solar energy. It should be pointed out that the above only applies to houses that have a masonry wall that faces very close to the south.

WATER WALL

The water wall system works on the same principals as the Trombe Wall, except water is used as the storage medium instead of masonry. The main advantage of water is its efficiency in picking up heat, storing it, and releasing it, resulting in less storage space. The surface of the water will also remain cooler than the masonry. The cooler surface will result in less heat losses and will have less tendency of overheat during sunshine hours. The lower surface temperature will also be more responsive to solar gain. 5Y The water wall can be directly exposed to the living space or it can be enclosed. If the water wall is enclosed the air can be circulated naturally or forced. Tests conducted by the Energy Center of the University of California, San Diego indicate that the water wall bin with forced convection gives the best solar load fraction, which is dependent on a person's subjective assessment of the comfort enhancement by direct radiation. The water wall bin with forced convection does provide the best room temperature control. During the daytime temperatures rarely exceed the thermostat setting by more than 2°F. The placement of an insulating wall (even with vents) between the living space and the water, with natural convection, will give poorer performance than the exposed wall. There was a significant loss of energy through the windows by conduction, even with R-8 night insulation. This heat loss can be reduced from 50% to 100% by the use of night insulation on the exterior of the glazing. Exhibit 12 is a schematic of a water wall bin. 5Z

The primary problem with the water wall is getting the water in the vertical configuration. Initial attempts had continuous water from the top to the bottom of the wall, such as vinyl bladders inside of walls and various types of tubes made of steel and fiberglass. These methods put too much head pressure on the system, making leaks a major problem. Corrosion is also a problem when metal containers are used. Drums are usually used, in that the water pressure can be kept down and still form a wall by stacking the drums. If metal drums are used to contain the water the corrosion can be minimized by using anticorrosive stabilizers in the water, or by lining the containers with something that is not corrosive in water. If the system is an exposed water wall there will have to be something to shade the wall

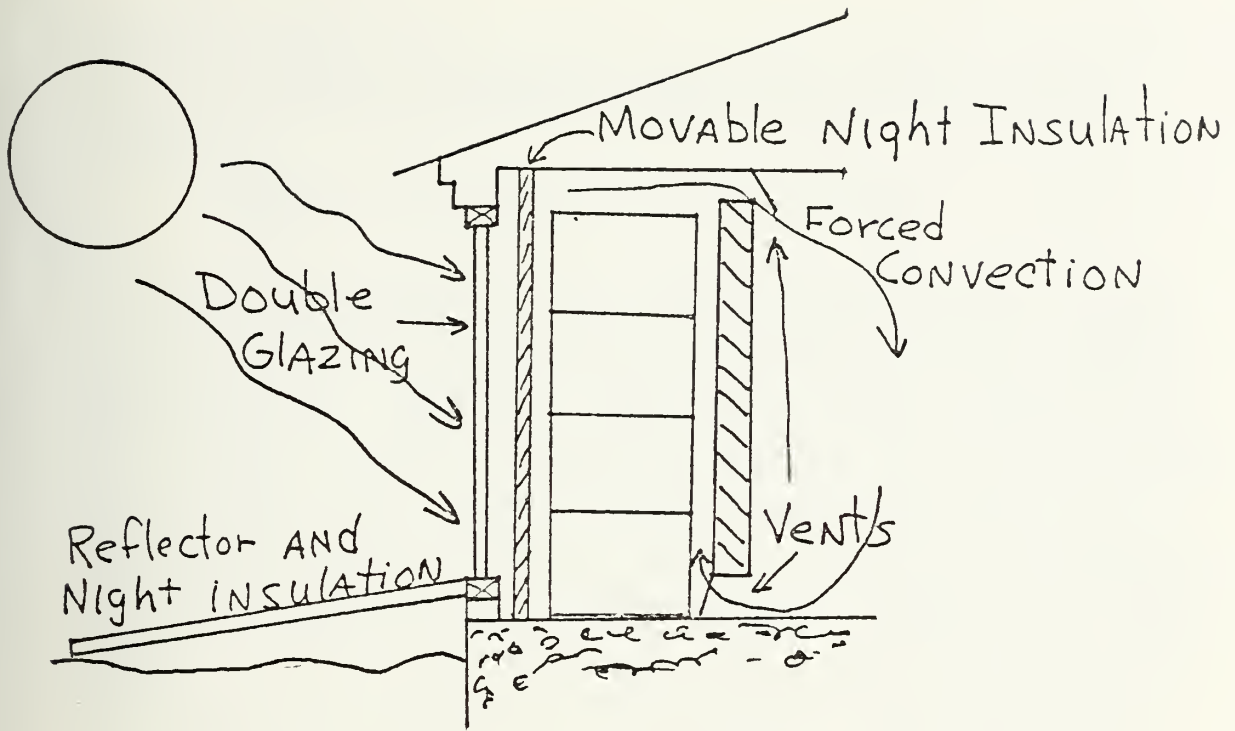

EXHIBIT 12

- ①
- ② Reflectors
- ③

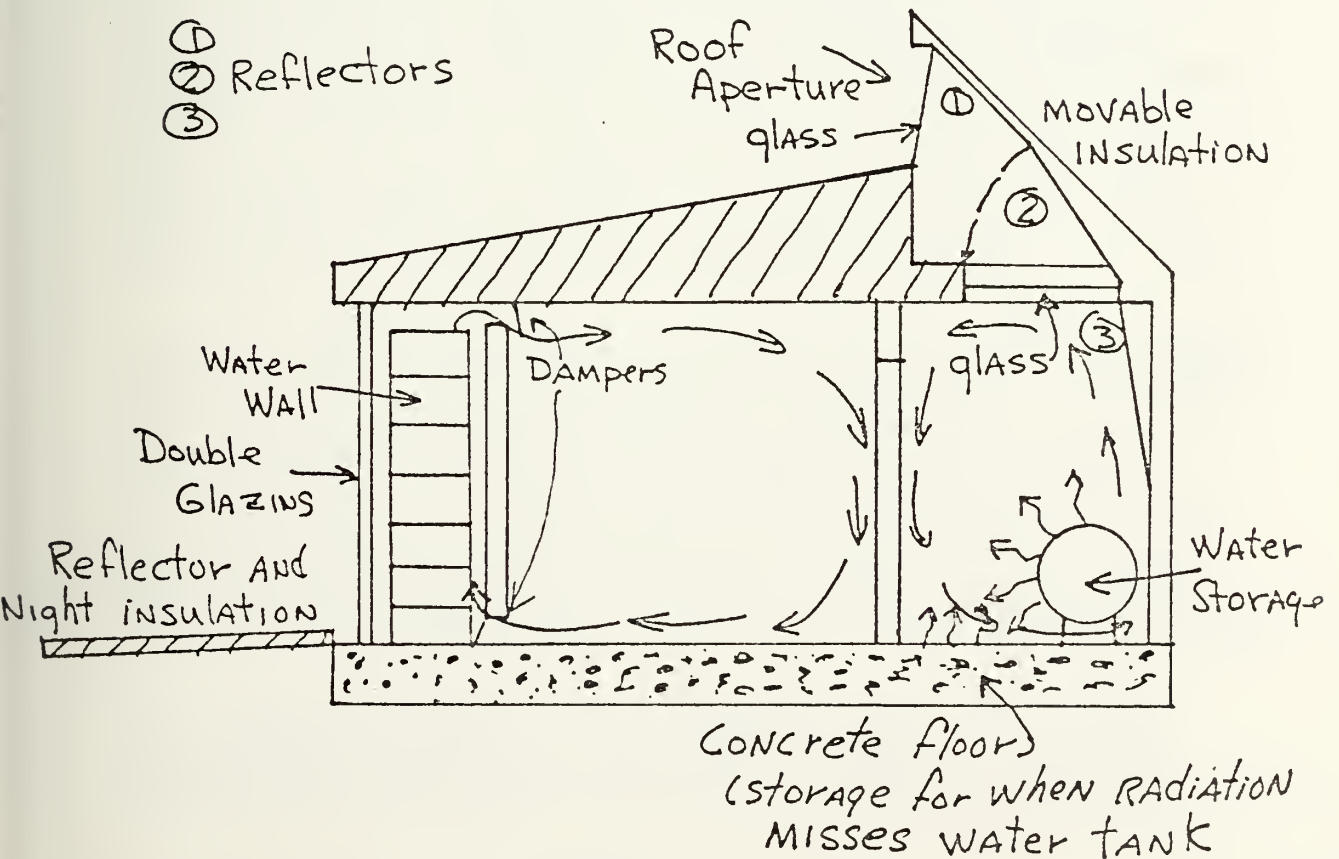

EXHIBIT 13

during the summer when no heating is desired. With the water wall bin the system can be designed so that the solar heat is vented outside, it would still be a good idea to provide some kind of shading. 5Z

FOCUSING ROOF APPERATURE/HOUSE IN NEW JERSEY

A technique used to minimize the thermal storage area is the focusing foof aperture. The roof aperture will allow the storage on the north wall. The designing of the aperture to give optimun distribution of solar energy is very complex, and will not be covered by this project. There is on going study, by others, in this area. The aperture will not focus the solar radiation on to the water storage at all times, therefore, a concrete floor should be used to insure all the focused energy is absorbed. The technique of focusing can minimize the storage area by a factor of up to two to one. This will save money as storage costs about \$2.00 per square foot. The focused radiation will require a high capacity material like contained water or phase change material to avoid overheating. A masonry wall however thick, (8" to 16") will not provide enough storage to prevent over-heating. The contained water should be situated on the north wall such that it will receive the most radiation. An advantage of the focused aperture is that during the summer months when the sun is higher, solar radiation will not be collected. 5I

A house located in New Jersey has a passive system that uses both a water wall and a focused roof aperture. The location has 4,980^oF days per year with 57% yearly sunshine. The house has 1,400 sq. ft. of living space and a heat loss of 8.3 BTU/DDF/sq. ft. which is a well insulated house. Exhibit 13 is a schematic of the house's heating system. The water wall operates by absorbing the solar energy through the glazing, and then radiating it from the water storage through the inner wall. The system also uses natural convection, from the water tube space, through the vents into the living space. The vents have dampers to prevent reverse thermosiphoning. There are exterior reflectors to increase the solar energy collected, which can be pulled up at night to give nightttime insulation.

The focusing roof aperture operates by passing the solar radiation through the outer glazing material and reflecting it, by one or more of three reflectors, to the water storage or concrete floor. The three reflectors are indicated in exhibit 13 as ①, ②, and ③. There is internal glazing at the ceiling to prevent convective coupling of the skylight with the occupied space. Reflector two is movable so that it can also act as insulation. The water storage and concrete, transfers the heat to the house by natural convection and radiation. This system has a good heat distribution because there is a heat source at both the south and north walls. The above system has a ratio of collector area to building load of about 1.7 sq. ft./BTU/hr.^oF. 5I

The simulation used for this house had many simplifications. The validity and effect of these assputions are as of yet unknown. Future simulations are going to be done by computer, which should give more accurate results. The results of the simplified simulation

are as follows:

YEARS TOTALS

HEATING DEGREE DAYS	HEATING LOAD (BTUX10 ⁶)	PERCENT SUNSHINE	SOLAR LOAD FRACTION
4,980	58.42	57	90%

Total cost of combined water wall and roof aperture system was \$7,858.00 which includes materials and labor. Considering costs, the solar load fraction, possible tax incentive and the low maintenance requirements makes this system very attractive. The above solar load fraction does not include the energy needed for hot water. The hot water required 3.04×10^6 BTU per year, which is 25% of the total annual requirements. The system could be modified to use the water storage as a pre heat tank for the hot water, which would decrease the conventional energy required for hot water. How this would effect the overall performance would have to be simulated. 5I

RETROFITS

Retrofitting a water wall or water storage system should be effective. The construction of the water wall or water storage should cost about the same as a new construction system. With a water wall it may take some structural work to get a wall with a lot of glass area, but it shouldn't be too much of a problem. The house will have to have a suitable wall facing south. If the system is properly designed it should be as effective as a new construction system, unlike a retrofitted Trombe Wall. The house will have to be well insulated, but a house should be well insulated no matter what kind of energy is used for heating.

WATER ROOF

The water roof system is a concept used in areas where flat roofs are acceptable. Most of the work on this system has been in the southwestern part of the United States. The system uses a water storage pond on the roof of the house. The solar energy is absorbed during sunlight hours, and a movable insulation is used to keep from losing energy to the air at night. There are movable insulation systems that can be moved with nonrenewable energy, and others that can be moved with manpower. Exhibit 14 is a schematic of the water roof system. As can be seen from exhibit 14, the heating is done by radiation only. The system radiates heat into each room, making the heat distribution no problem. With the heat source in the ceiling it may cause a problem of the floor being uncomfortable, in the systems built to date this has not been a problem. The water roof system should be able to handle 100% of the heating load in areas where it is practicable, and also 100% of the cooling load, if the weather conditions are right. The construction of a house capable of carrying the load of a water pond on the roof has not been a problem, but have had trouble keeping the system from leaking. There is ongoing work to try and improve the systems water tight integrity. A family

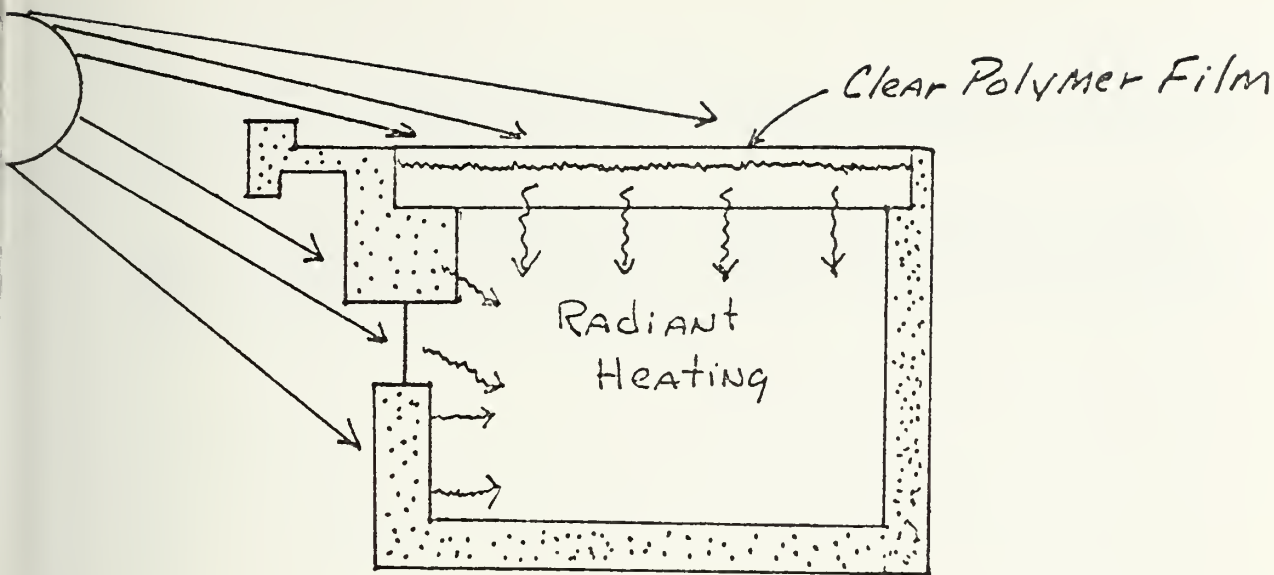

Winters Heating DAY

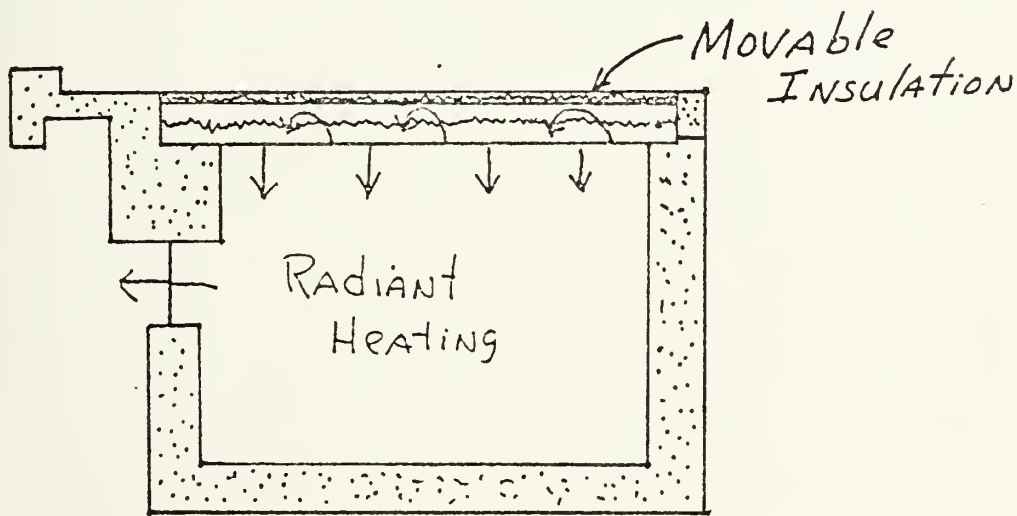

Winters Heating Night

Water Roof

that lived in a completed house felt that the system was superior to conventional heating and cooling. Of particular note was the lack of blowing air and noise. 4

The water roof wystem doesn't lend itself to retrofits, since there would have to be extensive structural work done to be able to take the added load of the water. The cost of the structural changes would make the retrofit prohibitive.

SOLAR GREENHOUSE

The solar greenhouse is a room that has extensive glass area that faces south. It is really a direct gain space that is thermally separated from the living space. This allows the greenhouse to have large temperature swings, while the living space, being buffered, will have smaller temperature swings. There will be a thermal storage wall separating the greenhouse from the living space. The wall can either be insulated on the living space side or left uninsulated. If the wall is left uninsulated it will operate on the same principals as a Trombe Wall. If the wall is insulated, to prevent heat loss when the greenhouse is cooler than the living space, the heating is done by convection through vents, windows or doors adjoining the greenhouse. The perimeter of the greenhouse will be insulated along with the floor if the climate is severe enough. Additional thermal storage, such as water filled drums, may be used in the greenhouse to improve its performance. Exhibit 15 shows the basics of greenhouse heating. 5B

The greenhouse with its extensive glass area is a good collector of solar energy, but the glass is not a very good insulator to thermal conduction. Shutters can be used to increase the greenhouse resistance to conduction. There has been recent development of transparent insulation, to be covered latter, that could make the greenhouse a better thermal storage medium. The greenhouse also can be used as a plant growing area, which could be used to grow vegetables year around. If the greenhouse is open to the living space there could be a problem with insects, if proper care is not taken.

DOUBLE BOX

A unique greenhouse system that is being developed is the double box. The double box is a greenhouse that completely surrounds the living space. Exhibits 16 and 17 are schematics of the double box. The structure will have to be well insulated. The air is heated on the south side through the glass raising to the top. The air is then forced down the north side through an air plenum space into a mass storage area at the base of the greenhouse. The air will then proceed into the greenhouse and up through a vent to be heated again. The air will circulated at about twice that of a normal central conditioning system, which will give air exchanges in the greenhouse of about one per minute. The reason for these high air speeds are; 5AA

1. Lower delta temperatures of operation, reducing heat loss back through the glass.
2. Rapid Air FLOW
 - a. Rapidly looping air prevents heat from building up in the greenhouse
3. Increased storage mass
 - a. Storage at low temperatures increase operation time of heat supply.

The double box gives two modes of operation; the air loop and the

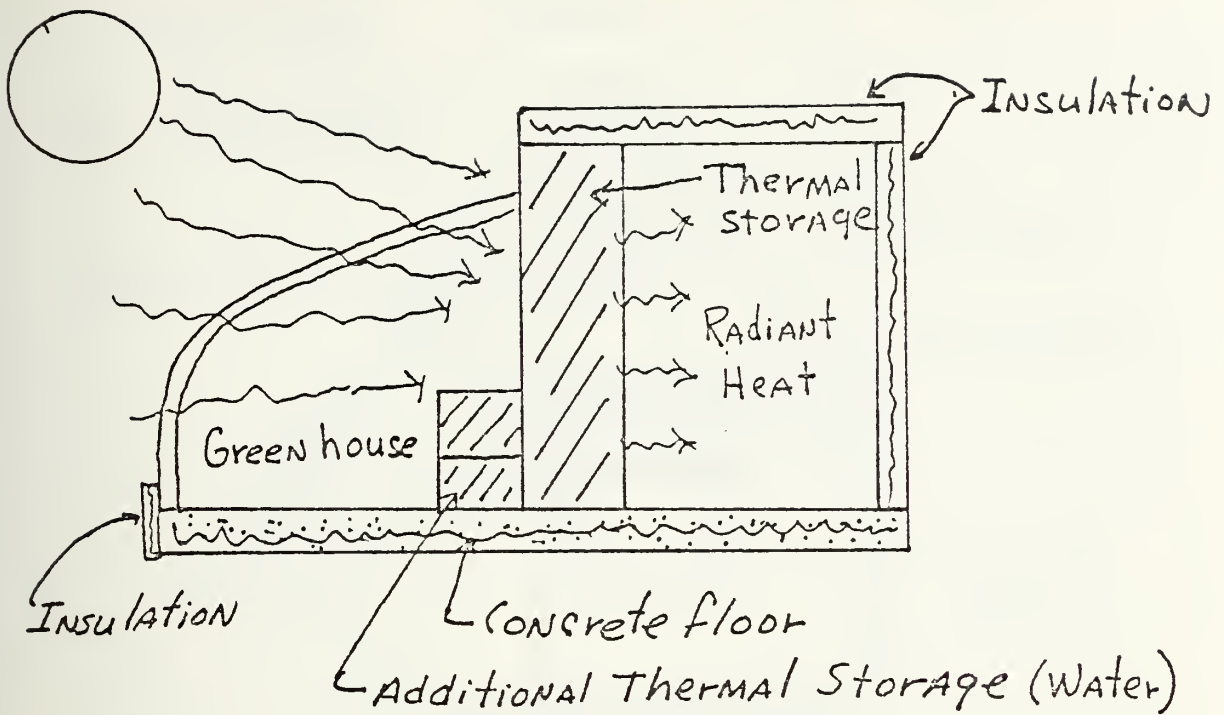

Greenhouse with Trombe Wall

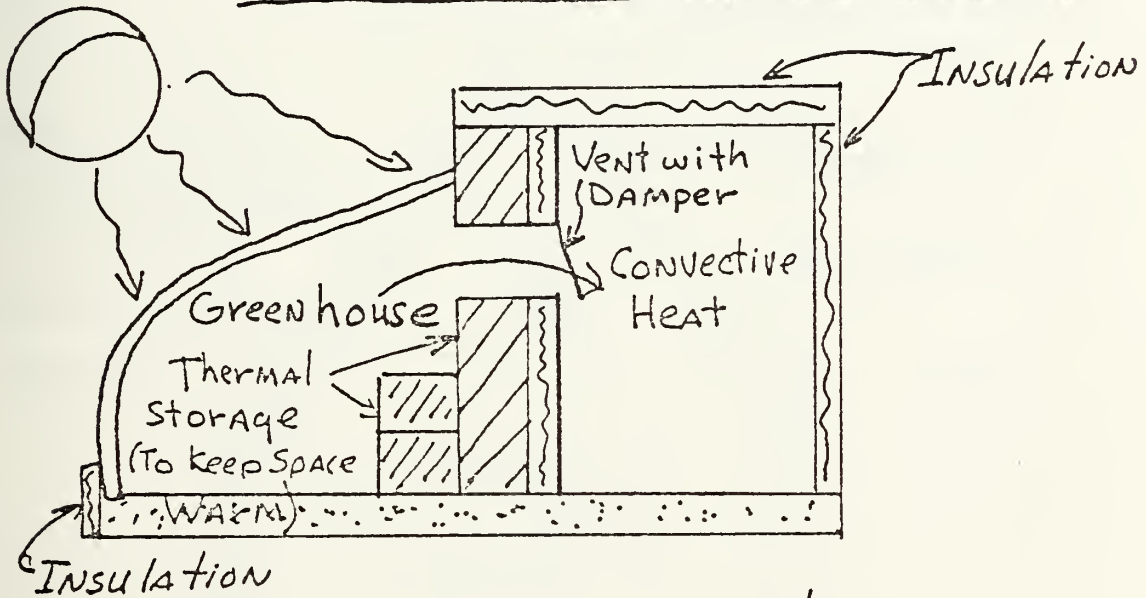

Greenhouse with Vents
(Uses Convective Heat)

SUNNY DAYS
Air Loop Cycle

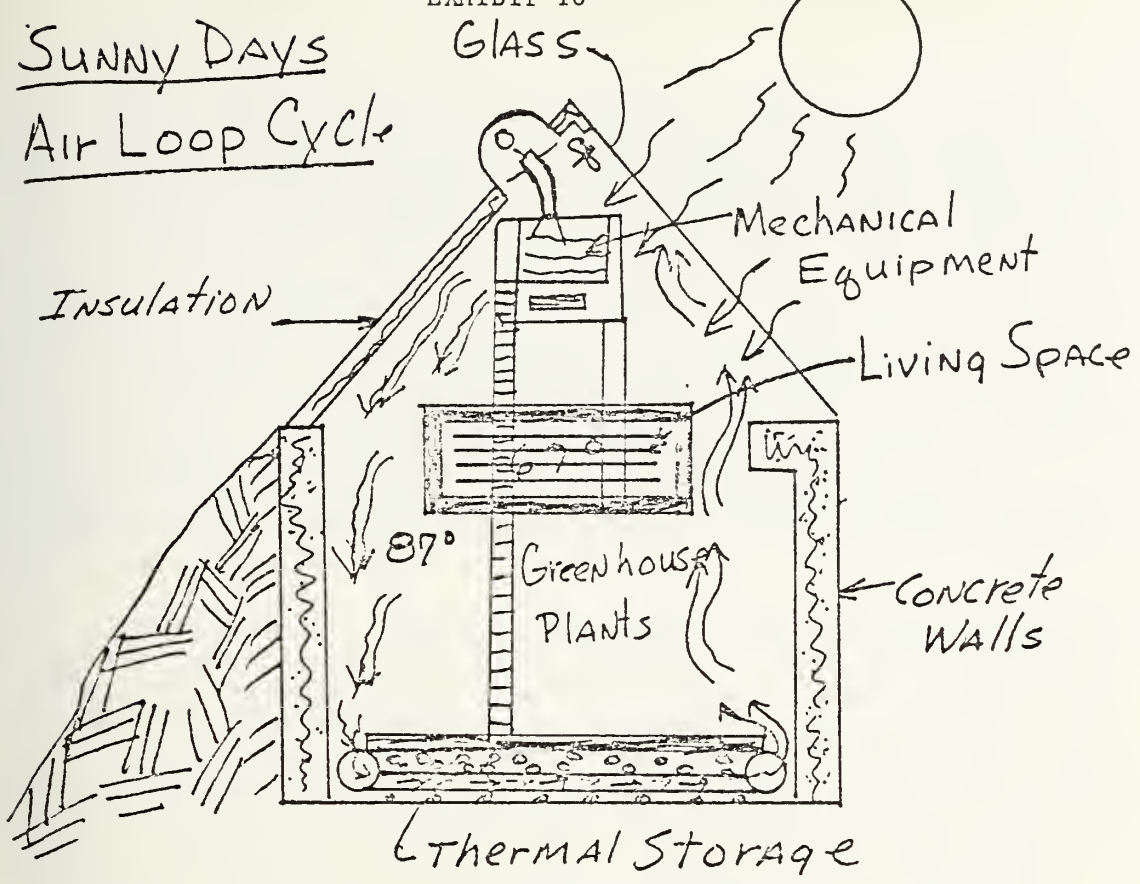

Winter's Nights
AND CLOUDY DAYS

Air Movement
(Buffer Space
Cycle)

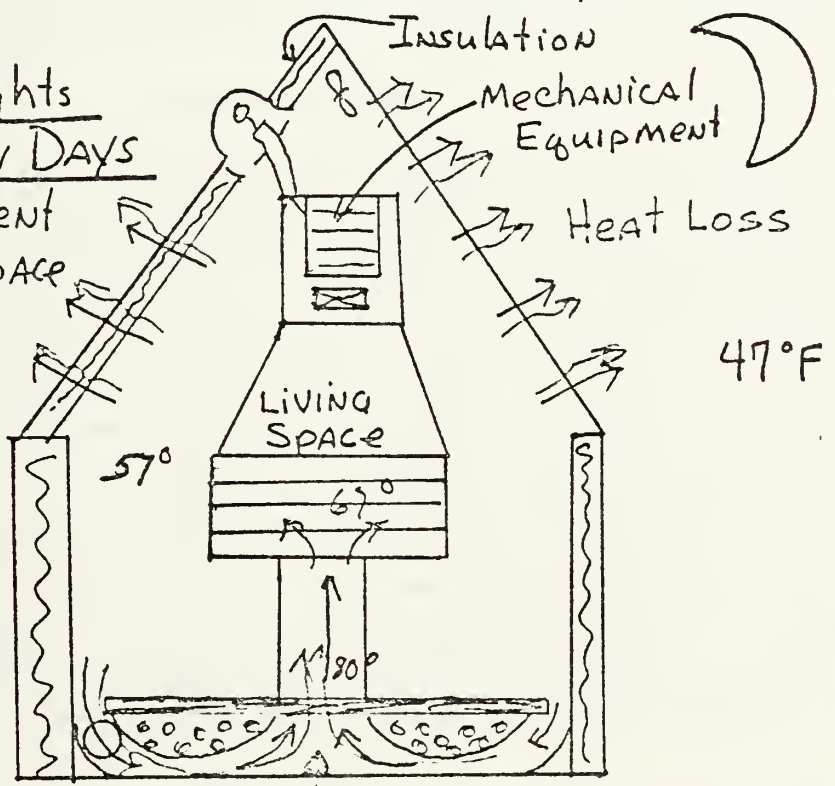

Thermal Energy from Storage

EXHIBIT 17

air buffer, which provide 3 main temperature zones; the inner box, the outer box and the outside air. The outer box's temperature will have big temperature swings, while the inner box will be maintained at a fairly constant temperature. During the heating season when the sun is shining the outer box will be warmer than the inner box, thus the inner box will retain its heat. When the sun is not shining the outer box will be warmer than the outside air, due to thermal storage, and will function as a warm air blanket thus reducing the heat loss of the inner box. The energy used to move the air in the outer box can be achieved by either an electric fan, 10 to 15 KWH per month, or by setting up a natural convective loop. The natural convective loop can be obtained by leaving a portion of the north air plenum uninsulated. The warm air will escape out the north wall and be replaced by the warmer air moving down from the attic, thus forming the convective loop. SAA

A demonstration project is being built, that uses the double box concept. The project, when fully operational, is expected to have a potential gain that is more than twice the heat losses. There will be an excess heat storage medium (low delta T) that should have the capacity (2 million BTU) to last through the cloudy days. The double box configuration can also provide summer cooling. Since this project is not completed there is no actual data available. There is also no figures for the cost of construction. This system appears to have potential, but how much will have to be assessed when actual data becomes available.

DOUG KELBOUGH HOUSE

The usual application of greenhouses is in combination with other systems. The Doug Kelbaugh House is primarily a Trombe Wall System, but has an attached greenhouse for additional heating and growing ornamental and edible plants. Initially, the greenhouse was single glazed and opened directly into the living space. After the first winter's operation it was found that the greenhouse was losing an excessive amount of heat, about 40% of the total heat loss of the house. To help remedy the heat loss problem a second layer of glass was added, which was estimated to cut the heat loss from the greenhouse in half. The greenhouse also had an excessive temperature swing, up to 25°F. Eight 55 gallon drums painted black were added to try and reduce the temperature swing and to store energy. The Doug Kelbaugh House showed that if a greenhouse is going to be open to the living spaces it should have some means of uncoupling the greenhouse at night. Shutters can also be used to reduce heat losses and give privacy. Therefore, if a greenhouse is going to be used in combination with another system and is going to be open to the living space it should only be considered as a daytime heating source. 4

HYBRID SYSTEM

Another interesting combination is to use the greenhouse attached to a Trombe Wall and use the heated air in the greenhouse to charge a rock bed storage system. This system will have the wall and the

floor giving off radiant heat, which will allow the room air temperature to be lower and still be comfortable. Exhibit 18 is a schematic of the above system. The concrete floor will provide a time delay for the heat flow. The warm floor will also offset the tendency of the room to stratify in temperature.

RETROFITS

Perhaps the best use of the greenhouse is in retrofitting it to existing houses. The greenhouse can be an effective solar system if the house it is retrofitted to is well insulated and has sufficient south facing wall area. It will not take care of the major heating needs, but will reduce it. The cost of construction will be similar to a new construction system.

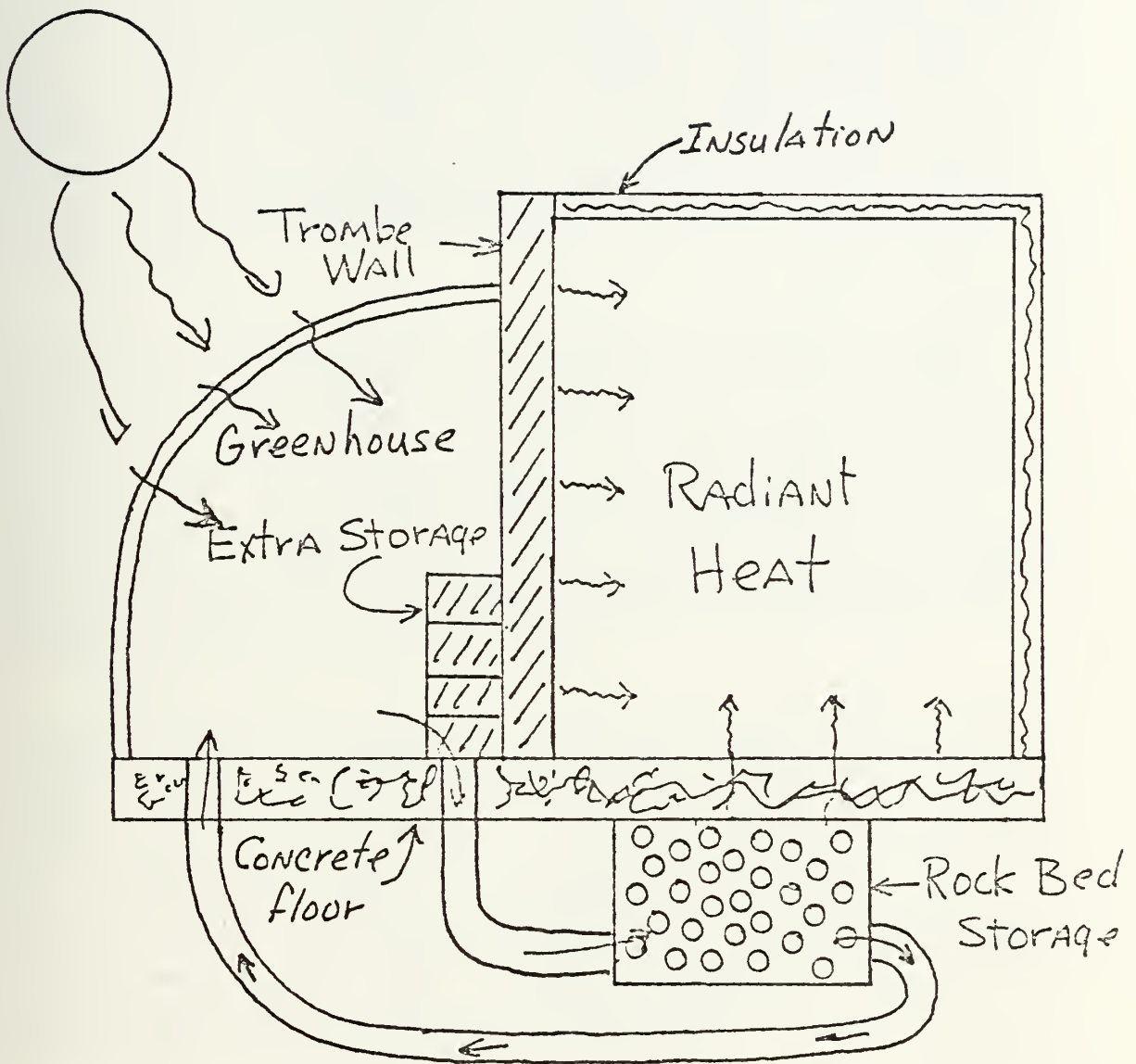

Greenhouse with Rock Bed Storage

CONVECTIVE LOOP (THERMOSIPHON LOOP)

The natural convective loop operates similar to active air systems, except no conventional energy is needed. The collector will be similar to the active system. The collector has one or two layers of glazing, a heat absorbing plate and a method for the heat transfer fluid to flow across the plate. As the fluid passes across the plate it will absorb the thermal energy in the plate and transfer that energy to the storage medium. As the fluid is heated up it will raise and go into the storage bin at the top of the collector. The storage medium will absorb the thermal energy, cooling the fluid, causing it to flow down and into the bottom of the collector. This system can be used with either water or air as the heat transfer fluid. 5B The usual use for the above system is for passive hot water heaters.

The natural convective loop air system can be used as shown in exhibit 19 . The house will have to be well insulated as usual. The collector will heat up the air causing it to raise into the storage bin. The rock bed storage will give up its heat by allowing air to raise through vents into the living space. Once the air is in the living space it will raise, heating the second floor spaces. As the air cools, it will return through the cold air return ducts. The hot water can also be heated in this system by installing water pipes in the collector. The system has dampers on the vents to control the heating and prevent any reverse thermosiphoning throughout the system. A house has been built using the above concept, but no performance or cost data was available. 3

For the natural convective loop system to be justified it will have to have better performance than an active system, and be comparable to other passive systems. The reason for this is that the system requires a collector that has no other function than to collect energy, as in the active system. The other passive systems have good performance and serve more than one function. There is a use for the convective loop system in retrofitting existing houses. The retrofits can be small convective air heaters for use during sunlight hours only, or a simple window box heater if it can be designed not to lose heat at night. Work is on going in this area of small convective air heaters, which can play an important role in using solar energy, espically in existing houses. 5B

Convective Loop Heating (NATURAL!)

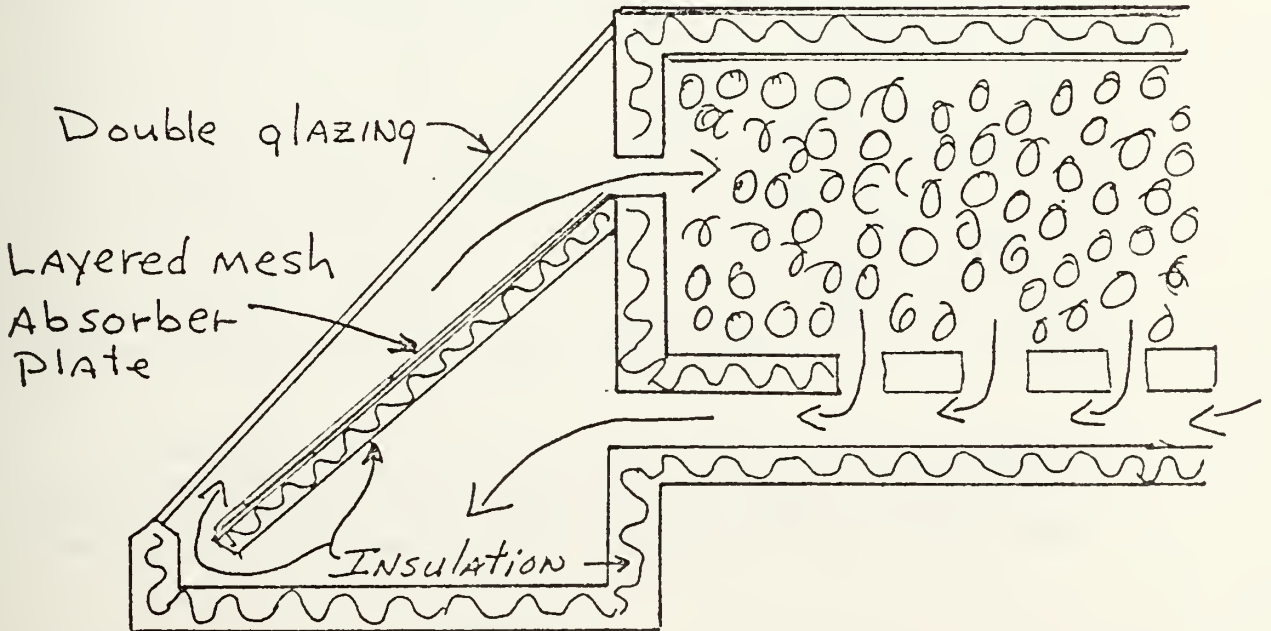
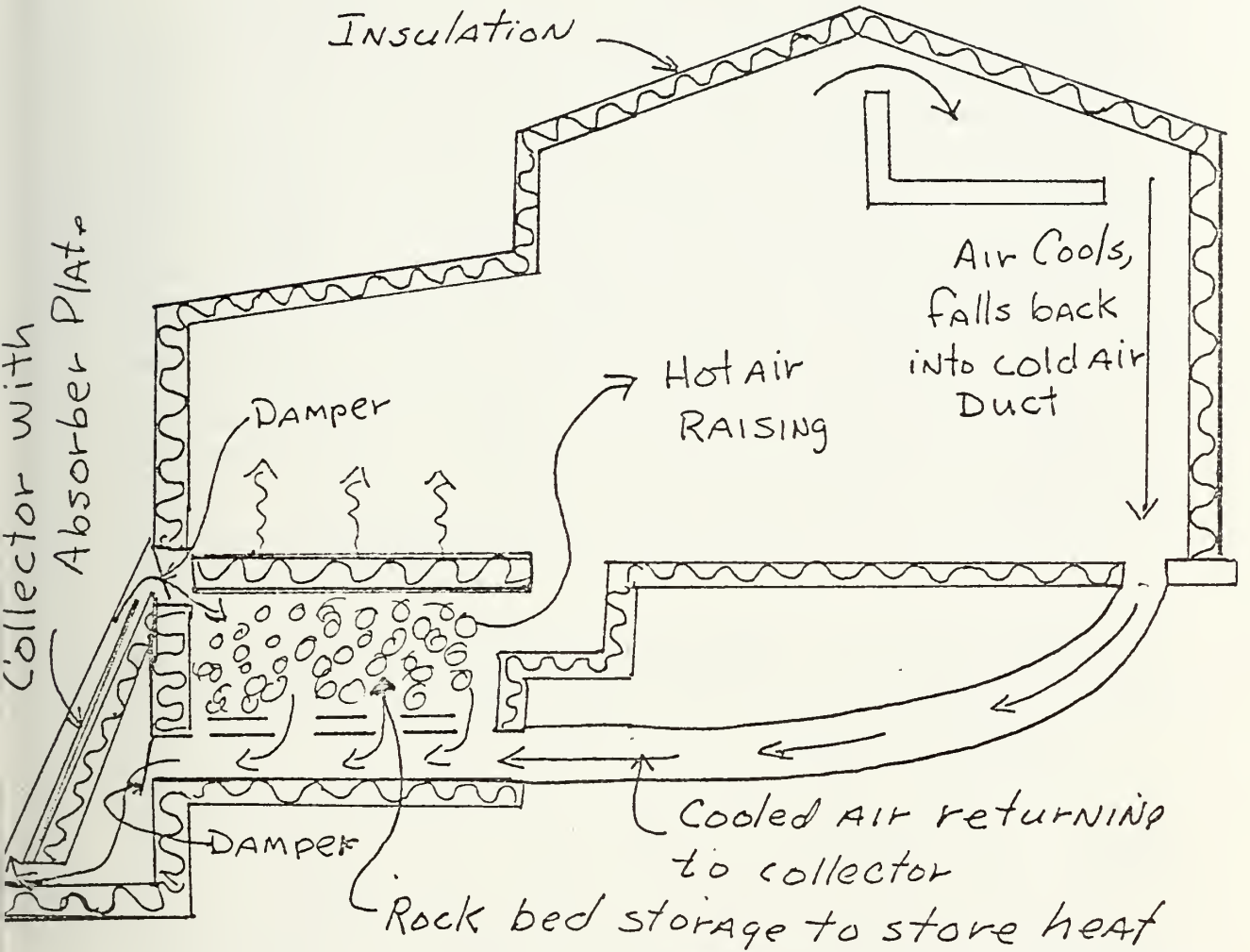

MODIFICATIONS

VERTICAL SOLAR LOUVERS

Modifications can be made to the basic passive solar concepts to make better use of collected energy. An interesting modification is the vertical solar louvers, which combines the concepts of direct gain and thermal storage wall. Vertical solar louvers are a set of rectangular columns situated directly behind south facing glazing and oriented in the SE-NW direction. By orienting the columns in this fashion the morning sun is allowed to enter and warm the house, and the afternoon sun will store energy in the columns. Exhibit 20 is a schematic of the vertical solar louver system. The vertical solar louvers has most of the advantages of the direct gain and the Trombe Wall systems, while eliminating most of the disadvantages. The Trombe Wall will give even temperatures, but does not allow the use of alot of possible storage in the interior floor and walls. The Trombe Wall, that circulates room air, also has no convient means to clean the interior glazing, which can deteriorate the system preformance. The vertical solar louvers allow the use of thermal storage in the walls, and still have easy access to the glazing for cleaning. The primary disadvantage of the direct gain system is the wide range of temperature fluctuations, which the vertical solar louvers system will not have. 5J

The vertical solar louvers are designed to function so that in the morning when the house is at its coolest the maximum amount of solar energy is directly admitted into the house, and then around noon switch to a Trombe Wall for storage of solar energy and to prevent the house from overheating. The louvers will admit over 80% of the morning sun directly into the interior. As the day progresses less and less of the sun's direct energy will be allowed into the house. At noon from 40 to 70% (depending on column spacing) of the sun energy will be intercepted by the louvers. In the afternoon all the sun's energy will be intercepted by the louvers for storage, after the house's interior has been heated up. The vertical solar louver system should reach maximum comfortable temperature at about 11:00 A.M. and last until 5:00 P.M., as compared to 1:00 P.M. to 5:00 P.M. for other hybrid passive systems. The maximum surface temperature for the louvers will be reached between 4:00 P.M. and 5:00 P.M., as compared to shortly after noon for the Trombe Wall. With the maximum surface temperature being obtained around 4:00 P.M., it will give a heat pulse at the back of the louver between 2:00 A.M. and 5:00 A.M. (depending on the column material and thickness) when it is most needed. The vertical solar louver, therefore allows the house structure to absorb and store heat for a longer time at the maximum comfortable temperature. The vertical solar louvers should improve the storage effectiveness of the internal structural elements from 50 to 100% in December and January. 5J

An advantage of the vertical solar louvers over the Trombe Wall is the front surface temperature of the vertical solar louver is lower. The vertical solar louver's maximum surface temperature is close to 75 F as opposed to 125 F for the Trombe Wall. The lower

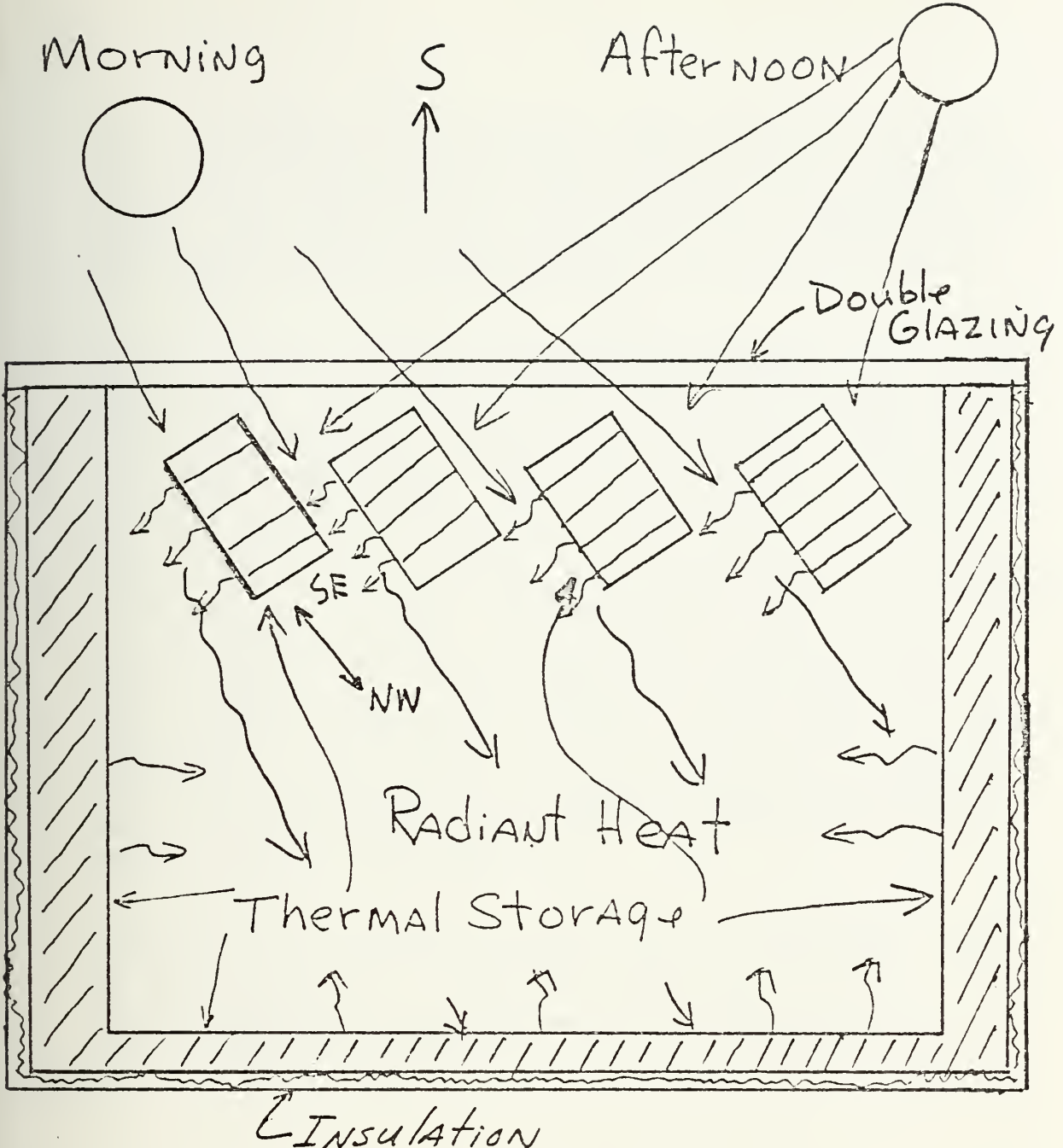

Vertical Solar Louvers

EXHIBIT 20

surface temperature will give a lower temperature potential for heat loss to the exterior, thus resulting in less heat loss (up to 50%). This means that less expensive night insulation can be used and still maintain good performance. The actual storage mass temperature of the vertical solar louvers should be about the same as the Trombe Wall. The problem of excessive floor temperature, that can occur with a direct gain system, is also avoided. 5J

Jim Bier, the designer of the vertical solar louvers, has built a house using his concept. The house has 1,300 square feet of living space, has two stories, and is made of 8 inch concrete blocks tamped full of sand. The floor is 4 inches of reinforced concrete on a 4 inch open gravel base. The house is well insulated, even to using triple glazed storm windows, but no overall heat loss coefficient was provided. The house has 300 square feet of south wall, 50 square feet of clerestory and 70 square feet total in east and west walls, which are used to collect the sun's radiation. There are 100 tons of insulated masonry and sand in the house to provide storage for overnight and on partially cloudy days. The five vertical solar louvers are 12" X 32" sandfilled blocks, the full height of the south wall angled 45 degrees east of south. The south wall is double-glazed. Insulating drapes, stored on the NE interior side of each louver, are used to prevent nighttime heat loss and to control unwanted insolation. The system was designed to give from 50 to 85% of the houses needs by passive solar energy. There is no actual performance data available. The cost of constructing a house, using the vertical solar louvers, should be about the same as a conventional block house, but no comparative cost data was provided. 5J

Combining and modifying the basic concepts of passive solar energy is often done in efforts to maximize the use of solar energy. The greenhouse is often combined with water walls of Trombe Walls, or in the Doug Kelbaugh House. Jim Bier's vertical solar louver is a creative modification that makes use of the advantages of the direct gain and Trombe Wall systems, and eliminates the disadvantages.

HYBRIDS

Perhaps the biggest source of disagreement with the people involved in solar energy is the definition of when a system is passive or active. There are some people who contend that if any source of conventional energy is used the system must be classified as active, and others who try to use a coefficient of performance figure to distinguish between the two types of systems. For this paper there is a category of passive systems, hybrids, that use conventional energy with one of the basic passive solar concepts. The conventional energy will usually be a fan to force warmed air through a storage medium. The reason hybrid systems are used is to overcome the overheating and underheating problems of passive systems. Examples of hybrid systems will be given to show how the concepts of passive solar heating can be combined with conventional energy to produce an effective solar heated house.

UNIT 1 FIRST VILLAGE

Unit #1 First Village, in the Santa Fe, New Mexico area, is a 2,300 sq. ft., two story house that uses the greenhouse concept, with a rock bed storage to do the space heating. All rooms face into a triangular-shaped, 20 foot high greenhouse, on the south side of the house. The side of the greenhouse facing south is made of glass, while the remaining two sides are made of adobe, for thermal storage and to separate the heat collecting greenhouse from the living spaces behind them. There is about 400 sq. ft. of south facing thermopane glazing mounted at a 60 degree angle. The adobe is 14" thick at ground level and 10" at the upper level, to provide the passive thermal storage. The remainder of the house is well insulated. The rear wall is rounded to provide less resistance to harsh winter winds. 4

Exhibit 21 is a schematic of the house's hybrid passive solar system. As can be seen from the schematic, the system is made up of a passive part and an active part. The passive part uses the greenhouse principal to store energy in the adobe walls. The heat stored in the adobe walls will work its way through the adobe and be available at night when needed. The unshuttered greenhouse in this system also acts as a buffer zone for the living space, in that it is allowed to fluctuate, usually between 110°F to 45°F. The thermal wall will average about 73°F. The active part is made up of two horizontal rock beds located under the living room and dining room. The beds are two feet deep and 10 feet wide, with one being 19 feet long and the other one is 15 feet long. The rock bed has sufficient storage capacity to carry the house through a couple of sunless days. The hot air is pulled from the top of the greenhouse, by two 1/3 hp. fans, and forced through the two rock beds. The air is then returned to the greenhouse. The heat in the rock beds will radiate through the 6 inch concrete floor and into the living spaces. The temperature of the floor along with the rock beds will range from 85°F to about 78°F. The rock bed will go down to 70°F after a sunless day. Backup heating is provided by baseboard electric heaters. The domestic hot water heating is provided by a two panel flat plate collector array. 4

Daytime Winter's Heating

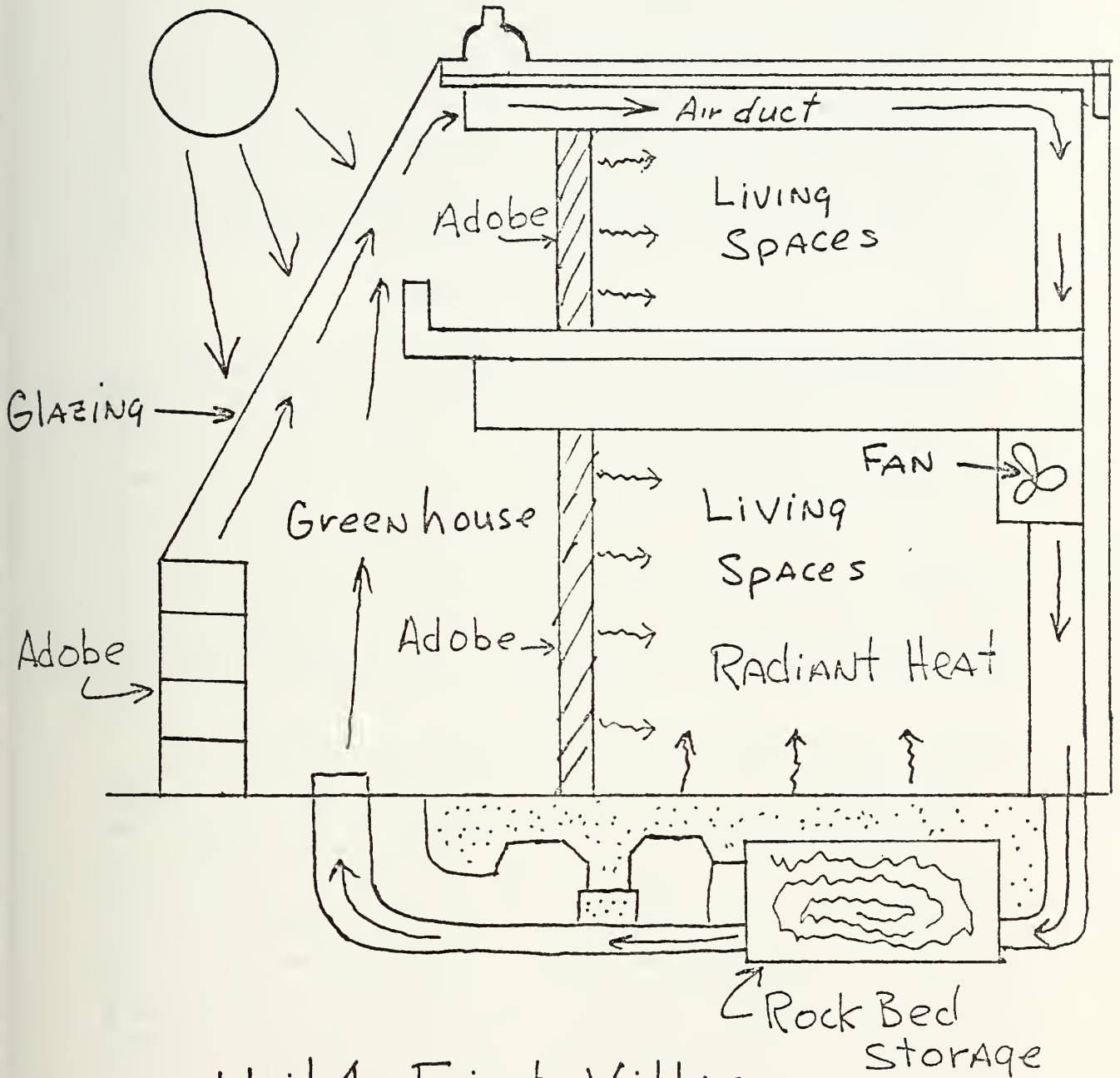

Unit 1-First Village
New Mexico

Temperature data collected over a four day period, lowest outside temperatures normally experienced in the Santa Fe area, illustrated the thermal stability of the house. The temperatures ranged from about 57°F to 63°F for this period. During most of the winter the internal living spaces were able to maintain temperatures in the upper 60's. There has been no monitoring of conventional energy usage to try and determine what percentage of the heating load was supplied by solar energy; but utility bills have consistently been less than \$10.00 per month, usually being the minimum service charges. This was true even under the most adverse conditions. There was initially an apprehension that the sloping greenhouse would cause excessive heating in the summer, this has not been experienced. The owners have been very pleased with the house's performance. 4

BRUCE HUNN HOUSE

The Bruce Hunn house has 1,955 square feet of living space and is located in Los Alamos, New Mexico, which has 7,000 F days with plentiful sunshine. The house has a two story Trombe Wall with 300 square feet of effective area. The system does not use a natural convection loop to circulate the air into the living space, but a blower to circulate the air between the glazing and the wall into a rock bed storage. A three-zone, forced-air distribution system, with a natural gas auxiliary furnace is also connected to the rock bed. There is also 140 square feet of windows for direct gain solar collection. The house has a heat loss coefficient of 8.5 BTU/°F/day/sq. ft. which is a well insulated house. There are plans to install interior insulating shutters on most windows, which will reduce the heat loss coefficient to 7.5 BTU/°F/sq.ft. The window shutters should improve the systems overall performance.'

The Trombe Wall is constructed of 12" open slump block completely filled with cement. This is considered the optimal thickness for concrete. The outside surface was painted a dark brown stain that has a measured solar absorptivity of 0.91. The wall was covered with double glazing mounted 2 inches from the Trombe Wall. Since the wall has no vents for a natural convection loop, the only space heating is by radiation. In the active mode the hot air in the space between the Trombe Wall and the glazing is forced through the rock beds. The blower initially circulated the air at a rate of 500 cubic feet per second, which as will be discussed later, is too great. A differential controller, which operates on the temperature difference between the top of the wall and the cold end of the rock bed, controls the charging process. The rock bed has a 3 foot by 12 foot face, with 6 feet in the direction of flow, and is 12 tons of gravel. The rock bed is insulated with extruded styrofoam, 2 inches on the side and 3 inches on the top, and rests on a concrete footing. The three zone forced air distribution system, with a natural gas auxiliary furnace, is connected to the rock bed. When a zone needs heat, returned air is ducted to the cold side of the rock bed too the warm end, and finally through the furnace. The furnace is set so that when the inlet air temperature is below 80 to 85°F it will come on. 4

For first winter's operation the system was in the passive mode only. The passive system under most conditions was capable of maintaining the inside temperature at 60°F or above. As long as the Trombe Wall was charged this temperature was satisfactory to occupants. It was found that when the wall was not charged, during cloudy periods, the house was uncomfortable unless the room temperature was 65°F or greater. Temperature readings within the Trombe Wall indicated the outer surface would reach a maximum of 152°F around noon. This peak temperature would then move through the wall, reaching the inner surface from 6 to 8 hours later and be about 90°F. Temperature data taken over a years period shows that the Trombe Wall gives a very stable inside temperature. The wall performance, being only 12 inches thick, will suffer when there is prolonged cloudy periods, which temperature data taken has verified. 4

The active mode was turned on November and December, of the test year, to try and activate the rock bed. It was found that the inlet air temperatures to the rock bed were too low to charge the bed adequately. The active mode was therefore turned off. The reasons suspected for the poor performance of the active system are as follows;

1. cold air leakage into the system
2. direct losses
3. too high an air flow rate

Steps will be taken to remedy these problems. The blower was slowed down to 200 - 250 cfm, because the design value of 2 cfm per square foot of collector area was based on the optimum value for an active collector, and is too high for a passive collector. Since the wall will absorb only one-half to two thirds of the incident solar energy, a value of 1 cfm per square foot of collector was considered more appropriate. As many of the air leaks as possible will be sealed. The air flow across the Trombe Wall will be reversed to shorten the length of warm air ducts. 5K

The system's first year performance was monitored to determine the percentage of the total heating load supplied by solar energy. The system was capable of providing 60% of the total load, without the active system operating properly. When the shutters are put on the windows, and the active mode is working, the system should be able to handle a good percentage more of the total heating load. The cost of material and labor attributable to the hybrid passive solar system is about \$5,500.00, which is less than 10% of the total construction cost. 5K

MARKEL RESIDENCE

The Markle House in Vermont has 1,100 square feet of living area with a heat loss of 17,500 BTU/hr. Particular attention was paid to reducing the infiltration rate during design and construction. The windows on the east, west and north sides are triple glazed. Since the

owners wanted a south view, the Trombe Wall concept was not feasible. The main living area is an open double height area with glazing placed at conventional height, and up near the top to direct the light to the back of the room. This was done to try and alleviate the glare problems associated with direct gain systems. The hybrid system is a direct gain system with a forced air rock bed storage. The auxiliary heat is supplied by a wood fueled stove. 5M

Exhibit 22 is a schematic of the houses' heating system. The house faces south 17.5 degrees east. Solar energy comes through two banks of night shuttered glass, glass doors main level and clerestory glazing at the top. The solar radiation is absorbed by a dark slate-type floor, and by a full height south facing wall of dark green marble rubble. These areas act as the direct gain portion of the system, and to heat up the air in the living room. The hot air will rise to the top, and when hot enough will be forced into the rock storage by a blower. The rock storage is behind the marble wall, and is 16' long by 6' wide by 12' high filled with three inch round stone. If the room requires heat from storage, and a differential thermostat indicates that the storage is warmer than the room, three dampers activate and the cool air pooling in the living room is drawn up through the storage and circulated throughout the house via conventional warm air ducts and registers. This type of system allows the solar energy collected to be distributed through the house, even to areas that are not in close proximity to the radiating panels. 5M

How the wood burner stove is used in this system is very unique. The primary problem with the way conventional wood burner stoves are used is that they are essentially air tight, so that they can burn for a long time without being reloaded. When the stove is operated in this manner it burns at a lower temperature. This type of operation will cause creosote to form in the stove pipe, because the cool chimney will condense the steam from the wood and combine with the volatiles, which is a problem. To overcome this problem the wood burner stove was placed in an opening in the marble wall, backed right up against the rock storage bin. The wood burner stove is then fired so that high enough temperatures are maintained in the stove pipe to eliminate the creosote problem. Some of the heat from the stove will go into the living space, but most of it will radiate into the rock bin storage and the marble wall. The stovepipes, with heat exchangers, also will radiate to these spaces. The hot air created by the stove will rise and be put into storage. 5M

The performance of this house has been difficult to determine because it was not used full time, it is being used more like a vacation house. With the house being used in this manner the shutters are not operated properly, when not occupied, resulting in the rock storage system not being fully charged. The small amount of data gathered does indicate that the system is operating as designed. The stove was designed to carry up to 46% of the January load. There was no data available on the systems cost. The designer of the house indicated that a transparent insulation, to be covered latter, could be used in place of the mechanical shutters if the house was not going to be occupied full time. The designer also has plans to retrofit the house

Markle House (Vermont)

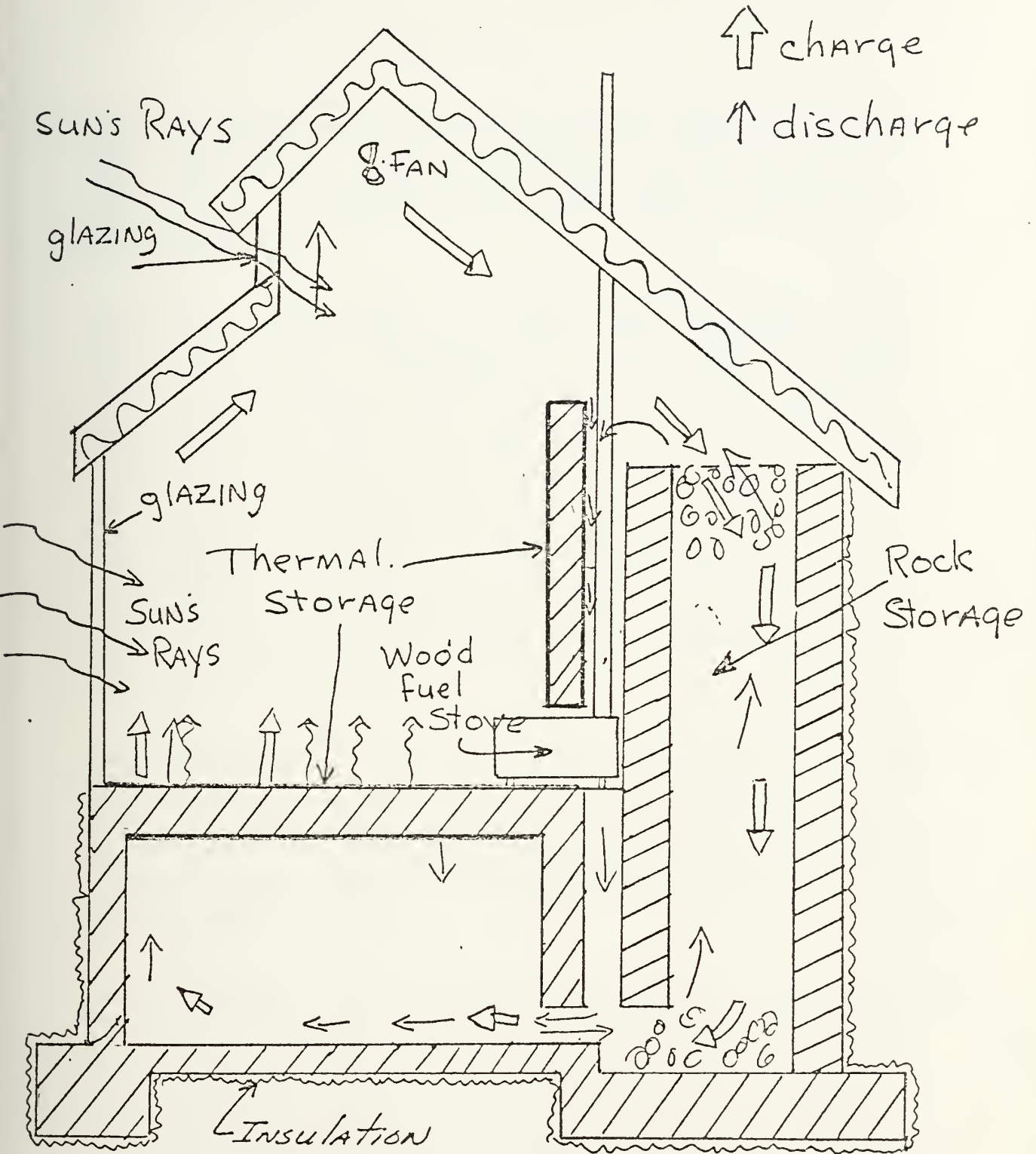

EXHIBIT 22

with an automated signal to indicate when to start the wood burner stove. 5M

SOLAR ATRIUM

The solar atrium is a room which is surrounded on the north, east and west by other rooms of the house. The cost effectiveness of the solar atrium concept is the primary concern of its developers. A test model residence, using the solar atrium concept, is going to be built. The house will have two stories with 1,800 square feet, and will be a well insulated wood frame house with a peak heating load of 37,800 BTU/hr. 5N

Exhibit 23 is a schematic of the solar atrium concept. The south facing wall has 600 square feet of glass in the wall and roof. The glass is 1" insulation glass, with inside louvers which have a total heat loss coefficient of 0.085BTU/sq.ft. °F. The atrium is situated in the house so as to be adjoining as many rooms as possible and to permit free air movement. The atrium is constructed of material which will give it significant thermal mass. The floor is five inches of concrete with a dark ceramic tile finish. The chimney is made from concrete block and finished with dark ceramic tile. There is also an ornamental pool of 300 gallons, which also provides thermal mass. All this thermal mass will be exposed to the sun's energy. This type of system will allow the benefits of a Trombe Wall, without its visual barrier. There is a rock storage unit under the atrium to store any excess collected energy. The rock storage is 200 cubic feet with a thermal capacity of 4,000 BTU/°F. The back up heat is to be supplied by an air to air heat pump. The atrium can also be used as a living space. 5N

The sun's energy will enter the atrium, charge the thermal mass and heat up the air. The hot air will raise to the top of the atrium where it will be circulated to heat the rest of the house. When the houses temperature reaches 68°F the air will be drawn to the rock storage. At night the shutters will close, and the thermal energy in the atrium or the rock storage, will be used for heating. When necessary the heat pump can be used. These different modes of operation provide a great deal of flexibility in maintaining comfortable interior temperatures. 5N

Since the house has not been built, as of yet, no actual performance data is available. Design calculations show that there should be a yearly savings of \$183.00. (Fy 1977 dollars.) The investment to be amortized is \$2,453.00. Calculations over the life of the system gives a pay-back period of about eleven years. This is considered the maximum amount of time to recoup the initial investment. As time progresses this payback period should get even shorter. The solar atrium gives cost effectiveness in heating and cooling that are equal to or superior to existing conventional systems. It has been designed to be convenient to operate by building occupants. 5N

Solar Atrium

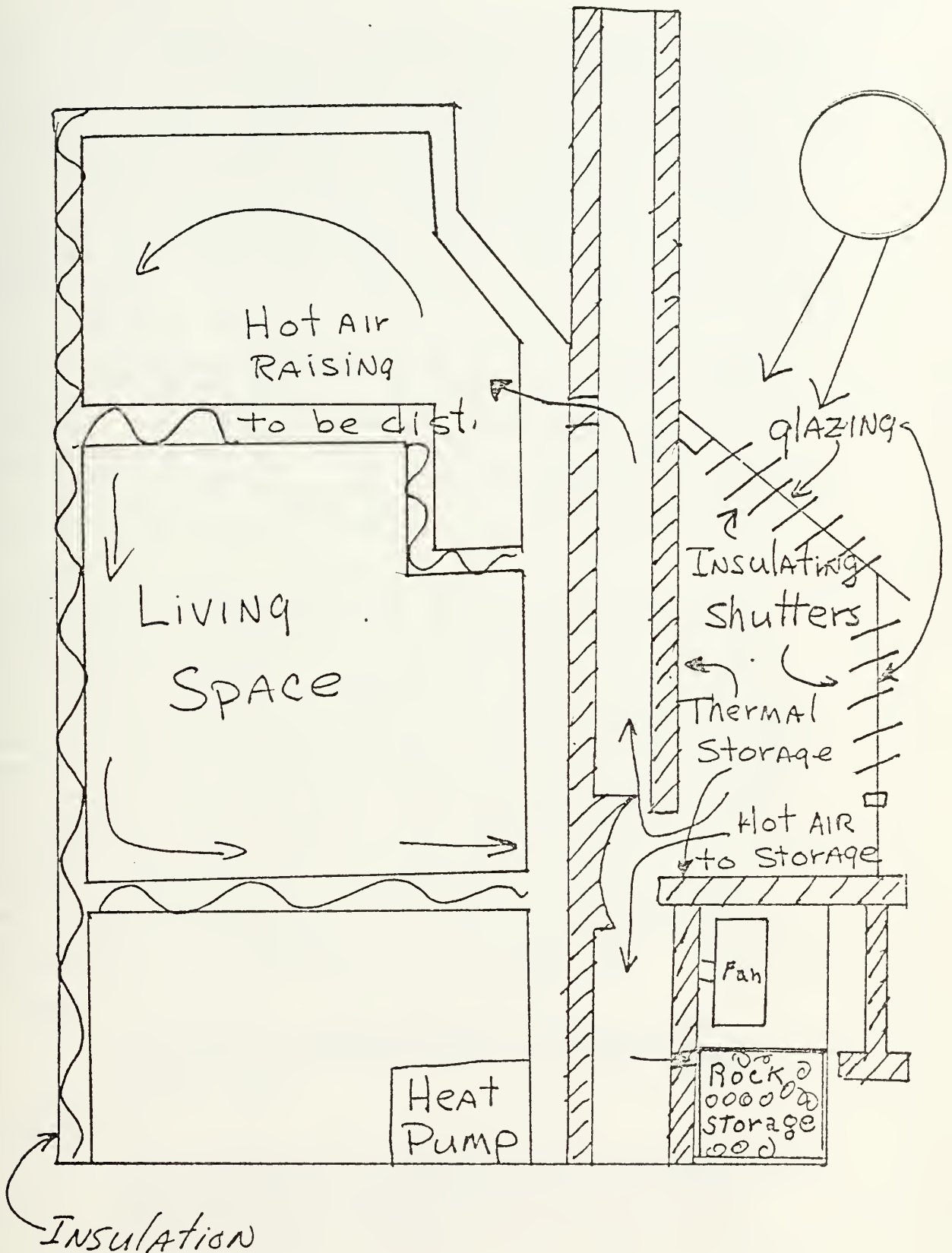

LINDBERG RESIDENCE

The Lindberg House will have 2,100 square feet, with a heating load of 4.15 BTU/DD/sq. ft., in Minnesota, which has 8,400 degree days of heating. A hybrid passive solar system is situated so that it will be protected from winter winds and have large summer shade trees to help summer cooling. The house will have three levels, the garage and basement, the main living area and the bedrooms. The second and third levels are designed to give the maximum natural circulation of warm air through the house and the thermal storage area. The windows on the north, east and west sides have triple glazing, with double glazing and movable insulation on the south windows. There is also a skylight in the roof to give added collector area, which has a movable insulation system. 5F Exhibit 24 is a schematic of the houses heating systems.

The hybrid passive system uses the direct gain concept to collect the solar energy, and a rock storage system to store excess energy. The south face has 275 square feet of double glazing, with movable insulation and 75 square feet of south facing skylight, with movable insulation. The floor has 63,600 pounds of precast concrete for absorbing solar radiation. There is a metal absorber plate located above the rock storage bin and positioned to accept the solar radiation from the skylight. The rock storage bin will have 40,000 pounds of rock, with the air circulated through it by the furnace fan. 5F

One of the problems with passive systems is the limited range it can operate over and stay within interior comfort conditions. The bedrooms will be put on the third level so that during the day this level will be allowed to go in excess of 80°F, thus allowing higher storage temperatures. Temperatures in excess of 80°F on the third level should not put the second level beyond the comfort range. The metal plate collector will be used to further increase the storage temperature by the warmed air from living spaces being forced by fan between the collector panel and the wall and into storage. The furnace fan will draw the air through the rock storage bin and either return it to the space through the concrete air floor, or recirculated via the collector loop. The precast concrete floor is an air floor, which allows flow both parallel to and perpendicular to the direction of the plank. Turbulence is created by supplying air to the center location of an area and forcing the air to flow perpendicular to the length of the plank, to floor grills located at the edges. The heating system operates by the following modes of operation: 5F

MODE #1 Circulate air. This mode operates when an uneven temperature distribution exists to circulate air from the high interior spaces to the lower spaces and north exposed rooms.

MODE #2 Solar Storage. When comfortable interior temperatures have been achieved and solar energy is continuing to warm the spaces beyond their needs the excess heat will be drawn through the interior solar collector, and into the rock storage, returning via the concrete air floor.

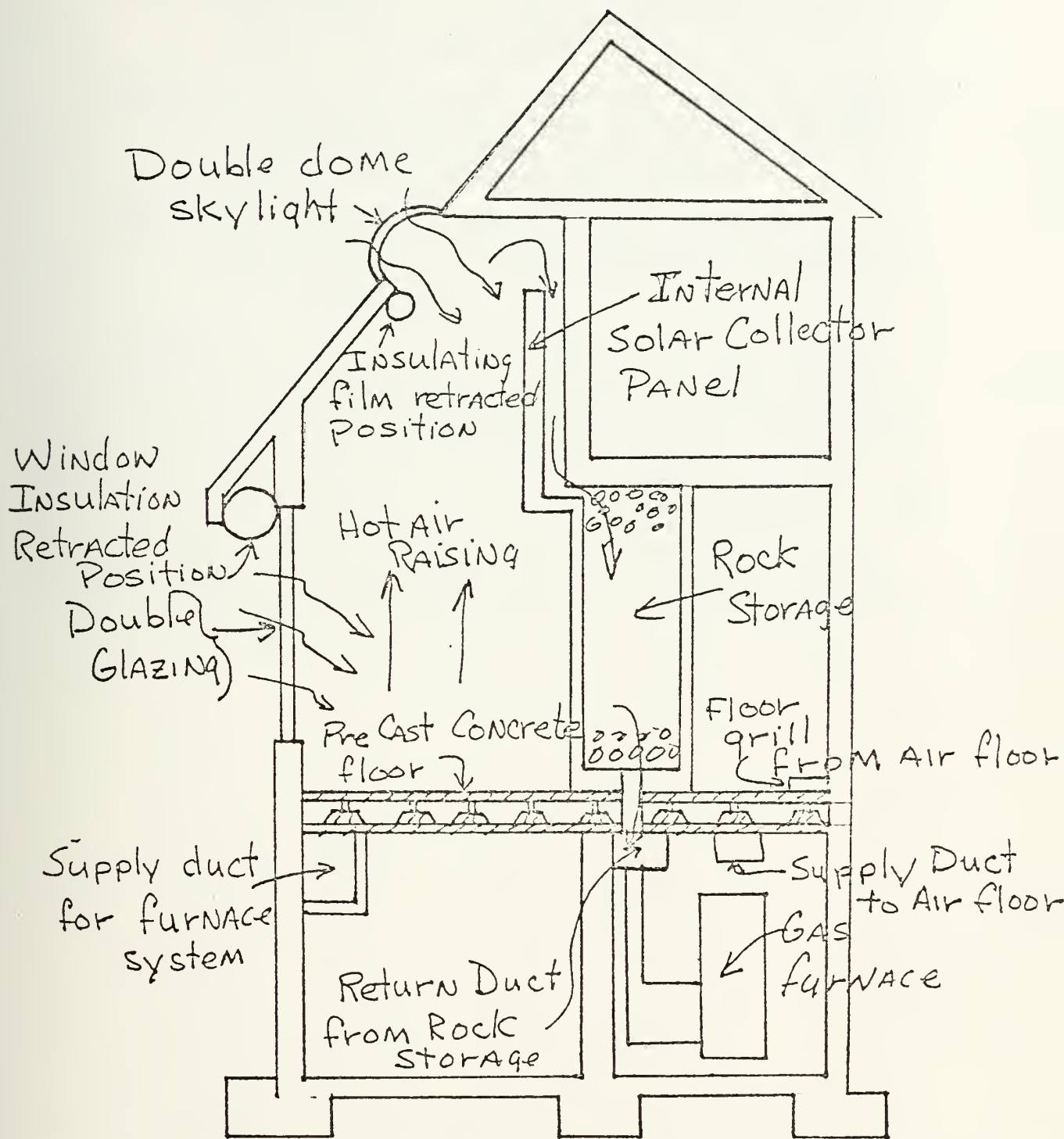

Lindeberg Residence
(Minnesota)

- MODE #3 Heat Charging only. This mode operates only when the interior spaces are at maximum comfort levels, When this occurs the air will circulate through the solar collector rock storage loop.
- MODE #4 Heat from Solar Storage. When there is no solar radiation and the radiation from storage is insufficient to meet heating needs, the furnace fan will withdraw the heat from storage by the same circulation as Mode #2.
- MODE #5 Auxiliary Heating. When the hybrid passive solar components can not meet the heating needs the auxiliary heating system can be used. A gas furnace is to be used as the back up system.

The gas furnace uses its own supply ducts. This is a partial duplication of the distribution, but it was needed to prevent charging the solar storage with the furnace heat, making the solar storage ineffective to the lower temperature solar heat. A bin method analysis, estimated that the passive system could supply about 65% of the annual heating needs, which is pretty good with the available collector area. This design shows that a hybrid passive solar system can provide the major portion of the heating needs of a large well insulated house in a cold (8,200 DD) climate, and give relatively conventional comfort standards. There are plans to monitor temperatures, stratification of temperatures and heat flows for this house when complete. 5F





TECHNICAL ADVANCES TO AID PASSIVE SOLAR HEATING

TRANSPARENT INSULATION

The passive solar concepts collect energy through glazing to be absorbed in a thermal storage mass at low temperatures. With conventional building materials these concepts have draw backs, the glass will lose heat by radiation, the thermal storage will have to be massive because of the low temperature, and the system will have temperature swings through out the days operations. Some technical advances that have been developed to help eliminate these disadvantages are the transparent insulation, the optical shutters, the movable insulation and the phase change material. The heat mirror will allow short wave solar radiation through, but be an insulation to thermal radiation. It is a thin transparent optical film which can be applied to glass or plastic glazing material. Depending on the application, the thermal losses can be reduced by 25 to 75%. Normally multiple glazings are used to reduce thermal losses, which will also result in a reduction of solar radiation transmitted through windows. As glazings are added the transmission will continue to decrease. The ideal heat mirror for use in passive solar applications, should be as shown in exhibit 25.

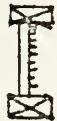
HEAT MIRROR

The heat mirror coating will transmit solar radiation, .3 microns to 2.5 microns, and be highly reflective to long wave radiation. Some examples of characteristics that can be achieved by the use of a heat mirror with windows are given in exhibit below.

		BTU/sq.ft./hr/ F		Trans
		<u>E=.2</u>	<u>E=.05</u>	_____
	Single Glazed Inner Surface	.72	.63	.78
	Plastic Film + Air Gap Retrofit	.31	.26	.75
	Double Glazed Air Gap	.32	.27	.77
	Double Glazed Mid-Gap Plastic Film	.21	.17	.66

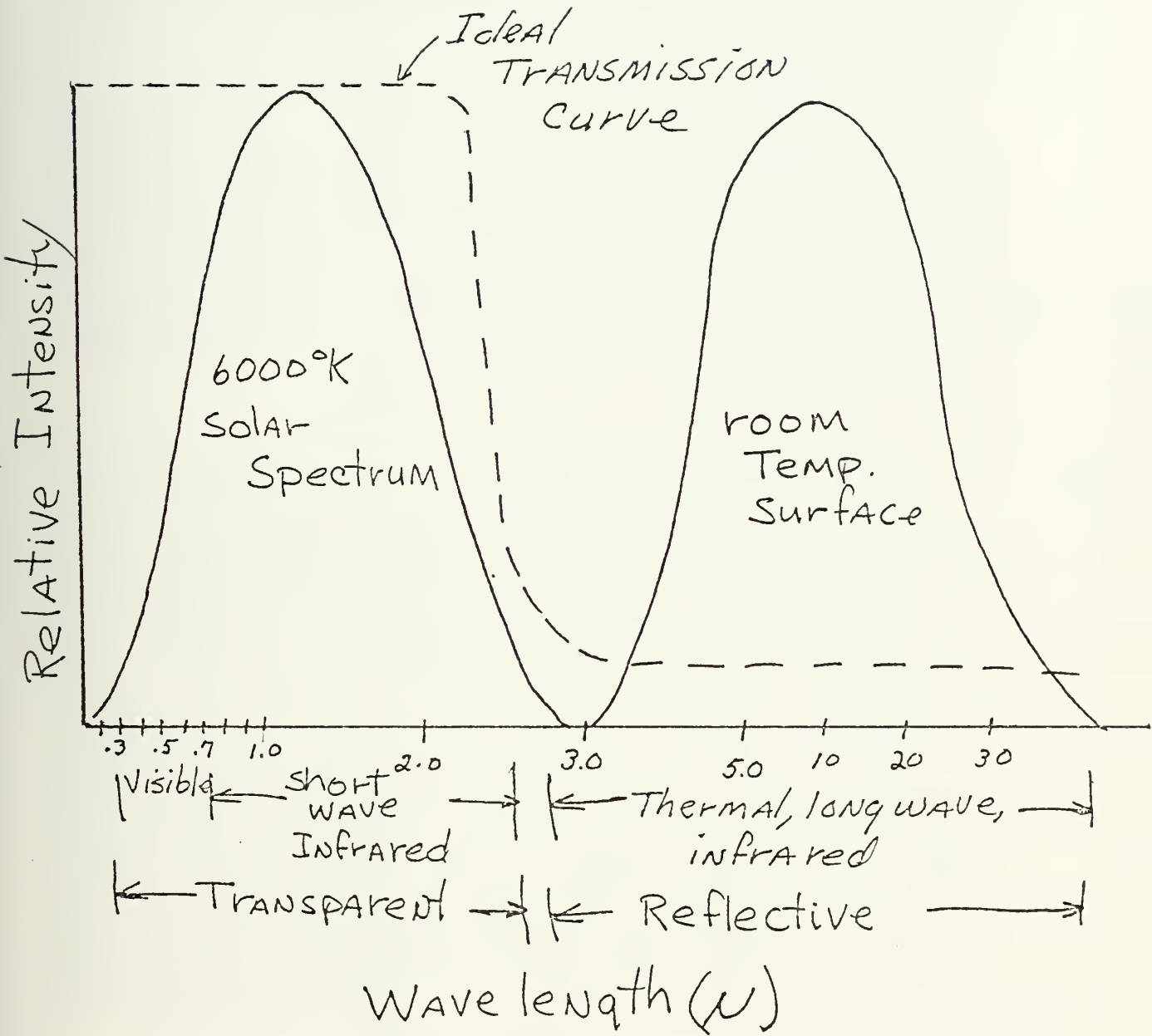

Ideal Heat Mirror

Curve ---

In comparing the performance of windows with heat mirrors to multiple glazed windows, it was found that the heat mirror was about equivalent thermally to adding a glazing plus air space. Condensation and frost on a heat mirror surface has the effect, thermally, of eliminating the heat mirror. In cold climates heat mirror on single glazing would not be advisable over double glazing due to the frequent condensation and frosting that would occur. 5S

The cost of the heat mirror to the consumer is very important to how much gets put into use. The demand will affect how much is made and at what cost per square foot. Some estimates of cost to retrofit existing windows to consumers, assuming high production rates, are \$.75 to \$1.50 per square foot, if homeowners installed, and \$1.50 to \$2.50 per square foot if professionally applied. Heat mirror on new windows should add from \$1.50 to \$3.00 per square foot to the retail cost. With the cost of adding additional glazing in the range of \$2.00 to \$4.00, it is apparent that heat mirror coatings can be potential competitors. The primary factor in decreasing cost is whether there will be sufficient demand to cut production costs. 5S

SOLAR MEMBRANE

The solar membrane is another type of transparent insulation. The solar membrane is made from a plastic film that has a unique combination of properties possessed by neither glass nor other plastics. The solar membrane has a transmission of solar radiation of 95%, which means less reflection losses than glass or other plastics. The transmission also falls off less rapidly with increasing angle of incidence, than it does in other materials. The solar membrane has a transmission of thermal radiation of only 13%, which is lower than all other plastics. Solar membrane characteristics allow many layers to be used and still be effective for use in solar energy. If four layers separated by a 3/4" air gap are used, the heat loss coefficient will be 0.21 BTU/sq. ft./hr. F for upward heat flow, the worse case, and still transmit 82% of solar radiation. This combination of solar membrane can give a flat plate collector saturation temperature of 400 F without concentrators, vacuums or selective blacks. The solar membrane has characteristics that can make it very useful in the field of solar energy. The solar membrane is available at 35¢ per square foot in larger than 1,000 square feet quantities. This is the same as single strength glass, but because of ease of installation would be cheaper in overall cost. If the solar membrane is purchased in 200 square feet or larger quantities the price per square foot is \$3.00. 5U

OPTICAL SHUTTER

CLOUD GEL

The optical shutter is a material that will vary its transmission of solar radiation as a function of temperature. A plastic has been developed which will function in this manner, Cloud Gel. Cloud Gel will allow solar radiation to pass as long as the material stays below the set point. At the set point the plastic will turn opaque white, thus reflecting all the solar radiation. When the material cools down

it will turn transparent again. The purpose of this type of material is to help prevent overheating that can occur in passive systems. The switch from transparent to white and back again will occur instantaneously over a three degree celisus temperature change. The set point can be tuned to any value between 0 degrees and 100°C, by adjusting the proportions of its constituents. Cloud Gel is inexpensive to manufacture, making its use in passive solar energy desirable. 5D

PHASE CHANGE HEAT STORAGE

THERMOCRETE

Another material that can be effectively used in passive solar concepts is the use of phase change materials for thermal storage. The unique characteristics of phase change materials is that a large amount of energy can be stored at one temperature. The temperature will be that at which the material is going through a phase change. A problem with most material is that it will remain a liquid when cooled a bit below its freezing temperature, because of the lack of a seed for the crystal to grow from. Another problem with most materials, in the liquid state, will be a container to keep things from getting messy. The problems can be overcome by incorporating the heat storage material into the very pores of a foamed concrete. The concrete will function as the seed to initiate crystal growth, and also serve as the container for the heat storage material. A concrete has been developed with phase change properties, Thermocrete, Calcium chloride is the phase change material for melting at room temperature. Other salts can be used to produce melting temperatures between 0°C and 100°C. Thermocrete can store twenty times the energy as ordinary concrete. The compressive strenght of Thermocrete is one thousand pounds per square inch, approaching ordinary concrete. 50

PARAFFIN BASE

Another type of phase change material is the paraffin base material. There has been tests conducted to determine if a paraffin base material could be used effectively in a passive system. Results of test to date have indicated that the paraffin based material could be used to collect and store solar energy. The materials developed can store up to 250 BTU/sq. ft. Another benefit of using a paraffin based material is that when it is liquid it is transparent, giving it the ability to function as a window. There is on going work in this area, to try and produce an even better material. The paraffin based material will be inexpensive. 5X

POLYHEDRAL WALL

The Trombe Wall, with phase change material used for thermal storage, can use a polyhedral (honeycombs) plastic cover instead of glass. The polyhedral plastic will transmit more than 60% of the solar radiation and act the same as an inch of thick foamed plastic (R-4 or higher). The polyhedral plastic will have to be made from a plastic that will not be attacked by solar radiation. The polyhedral

plastic will be inexpensive, and when combined with a phase change material gives an effective passive solar system. There is further experimental work going on in this area. 5

HEAT MIRROR, CLOUD GEL, AND THERMOCRETE USED TOGETHER

The heat mirror, Cloud Gel and phase change materials can be stacked, as in exhibit 26 , to produce an effective passive solar collector.

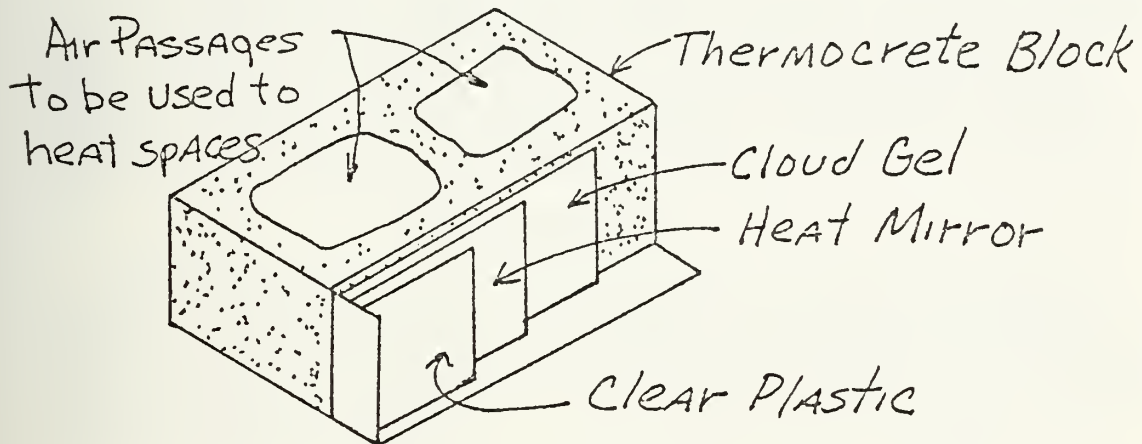

EXHIBIT 26

On a sunny day the solar radiation will pass through the heat mirror and Cloud Gel and be absorbed in the Thermocrete. The Thermocrete will start to melt, when all the material has melted the temperature will raise causing the Cloud Gel to turn white, if set temperatures are correct. At this time the Thermocrete is completely charged, and prevented from overheating. The Cloud Gel will not be affected by outside temperatures because it is shielded by the heat mirror. The Thermocrete will thus slowly freeze, but stay at one temperature. If the Thermocrete melts at 70°F and it averages 30°F outside, and there are two layers of heat mirror, in a 24 hour period only one third of an inch will freeze. Calculations show that on an average January day in Boston, there will be sufficient solar radiation to melt two thirds of an inch of Thermocrete. Thus with this type of system it can be seen that even in the terrible New England winters it can maintain a comfortable 70°F.50

MOVABLE INSULATION

NIGHTWALL PANEL

Movable insulation is often used in passive solar systems to prevent the loss of heat when the sun is not shining. There are many kinds of movable insulation, ranging from very simple to complex. Four different types will be described to give an indication of what has been developed in this area. The night wall panel is simply a lightweight rigid insulator that is attached directly to the window, when there is no solar radiation. The panel can be held in place with magnets or some other convient method. The night wall panel allows single glazing to be used, in a passive system, which will

allow greater solar energy into the house for use in heating. The night wall panel can also be used to keep solar radiation from overheating the house. Tests conducted with night wall panels, including edge effects, showed that an effective thermal resistance of 3.12 can be obtained from a one inch beadboard, including the value for the glass. 5cc

BEADWALL

The beadwall uses tiny styrene beads that are moved from storage to fill a gap between window glazings when needed. A vacuum cleaner motor is used to transport the beads. The motor is automatically controlled so that when the sun is shining the beads will be in storage. Exhibit 27 shows a beadwall system. There was no thermal resistance value given for the beadwall. 5CC

EXTERIOR SHUTTERS

Exterior shutters can be used many ways, and is an effective and often required insulation for passive solar systems to operate properly. The thermal resistance obtained will depend of the material used and how all the edges are sealed. An added benefit of increasing the solar radiation collected, can be obtained if the shutters are designed and used correctly.

SELF-INFLATING CURTAIN

The self-inflating curtain is an automated device capable of providing an efficient movable insulation for glazing areas, especially for Trombe Walls. The curtain is automatically put in place when there is no solar radiation. The curtain will then inflate from the hot air raising. The hot air will be intercepted by vents in the curtain, creating an increase in pressure and inflating it. How thick the curtain will inflate will depend on the mechanical stiffness of the material and the gravitational forces acting on it. The curtain will be stored in a roller above the wall. As the curtain is rolled up the air is evacuated through the side channels and the slots at the bottom of the curtain. The curtain consist of a number of layers of thin flexible material of high reflectivity and low emissivity. When the system is inflated it will reduce the heat loss through the windows. An important consideration is the area of glass to be covered. If a large area of glass can be covered by a single curtain it will give the minimum infiltration rate, by keeping the linear feet of crackage to a minimum. A small curtain tested had a thermal resistance of 9. This was considered low because it was a small curtain, which will give too high of a infiltration rate. It was conservatively assumed that a curtain that would be used on an actual system would have a thermal resistance of 12. The cost of a curtain 20 feet by 17 feet is \$4.28 per square foot installed. To determine the payback period a curtain was used on a Trombe Wall with double glazing in a 9,000^oF day climate. The curtain was assumed to have a thermal resistance of 9, which is low. The payback period for Aspen, Colorado, with an electricity rate of three and a half cents per kilowatt hour and an increase in cost of power of 15% per year for the

Bead Wall

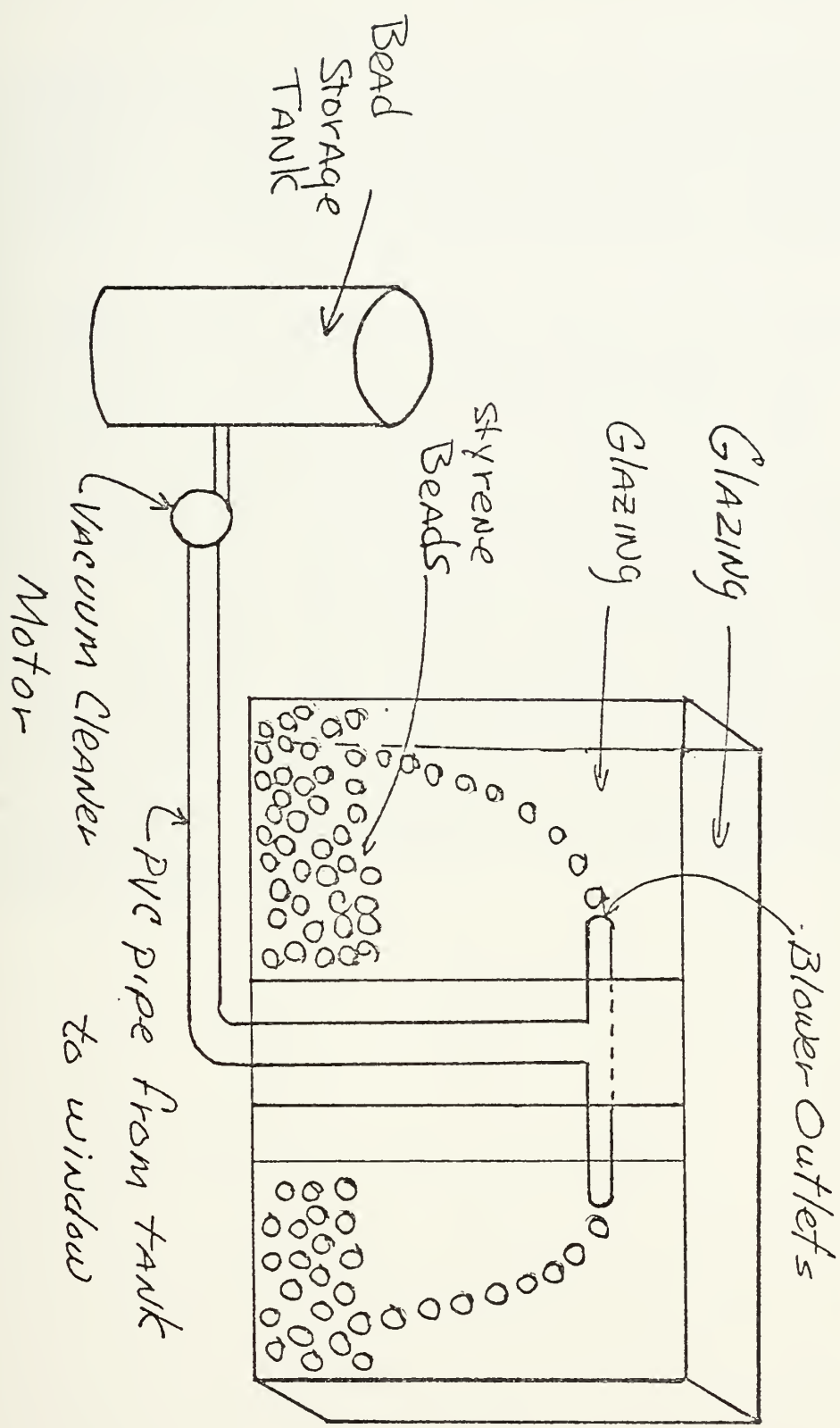

next five years, is 4.2 years. Considering the improved performance and the cost of the curtain, this is an effective movable insulation.

HEAT PIPE

A technique that is being tested is the use of heat pipes in combination with a water wall, concrete wall and paraffin wax wall. The characteristic of heat pipes that is useful in passive solar system is its thermal diode effect, allowing the flow of thermal energy in one direction only. The heat pipe will take heat from one end and give off heat on the other end only, with the reverse flow prohibited. The heat pipe used in a passive system is shown in exhibit 28. 5

The absorber plate, with heat pipes attached, will collect solar energy. The heat pipes pointing up through the insulation into the thermal mass will transfer the collected solar energy to the thermal mass, when the absorber plate is warmer than the storage. At night or when cloudy the absorber plate will cool down, but because of the thermal diode effect will not drain the storage. This system will not need movable night insulation, because there is a permanent insulation material between glazing and storage. Another advantage of this system is that whenever exterior conditions allow the absorber plate to cool there will be insulation in place, unlike other systems. In test conducted the water wall gave the best performance, but the paraffin wax wall and concrete wall performance were close. When a water wall with a heat pipe was compared to a water wall without a heat pipe, it was found that up to more than twice the useful heating output could be obtained. The single glazed water wall with heat pipes had an output that was nearly twice the output of a simple, no night insulation, double glazed water wall. The use of a heat pipe in passive solar systems will need further work to determine the optimum configuration and number to use. The heat pipe appears to be a very reasonable device to use in combination with thermal storage walls.5

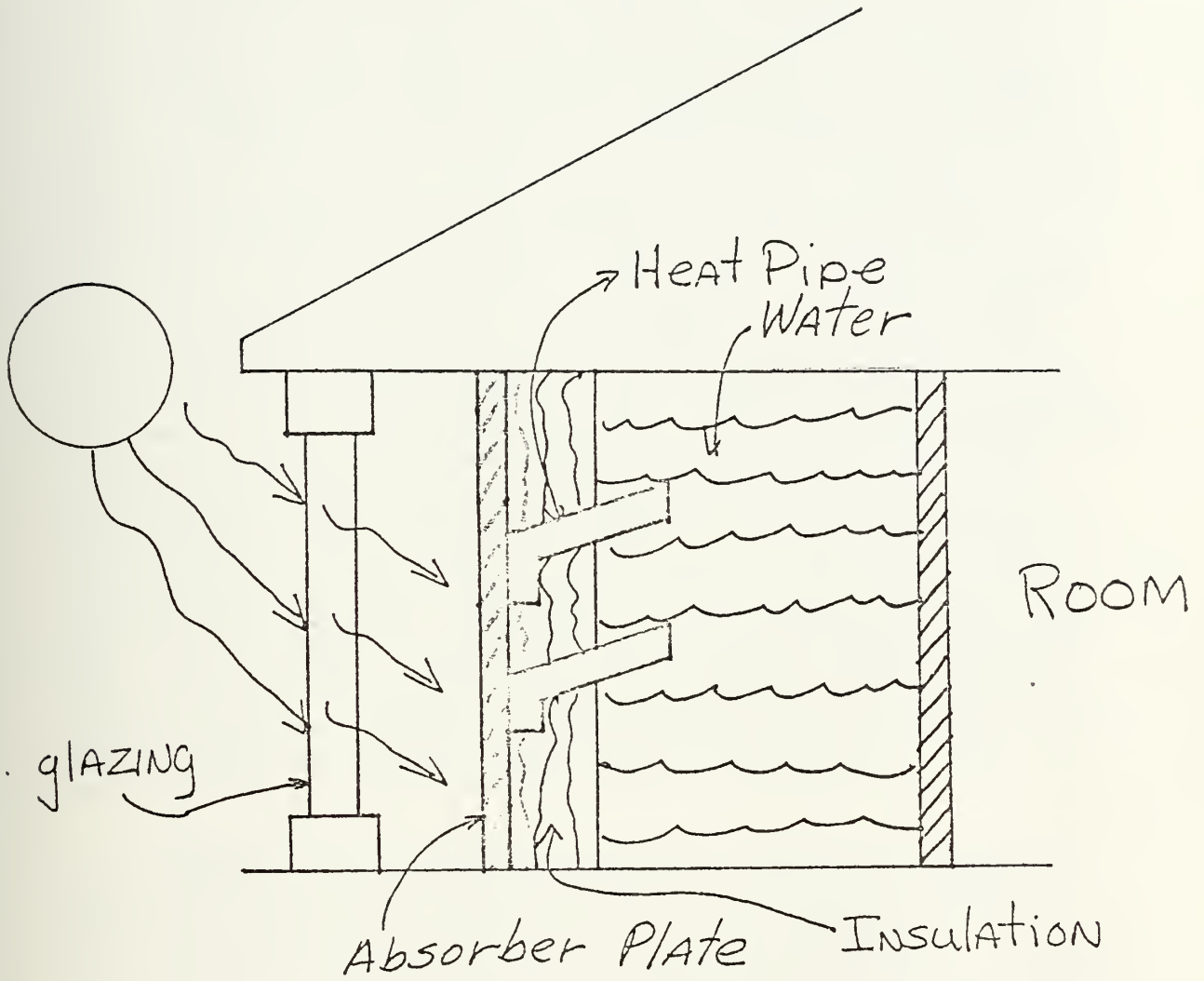

Water Wall with
Heat Pipes

EXHIBIT 28

WINDOW

WINDOW DESIGN

Windows in passive solar design is very important. To get an idea of how important windows are in the useage of energy, there is about one third of the nations energy consumed in buildings (residential and commercial). Of this energy consumed two thirds can be affected by windows. Therefore, the proper performance of window is very important in the field of energy used in buildings. The six energy control functions of windows are passive solar heating, daylighting, shading, insulation, air tightness and natural ventilation. Recognizing these six functions, one can begin evaluating how a window's performance can be improved. The following stratagies, in window design, will be discussed concerning improvement of window performance; site design, exterior appendages, window frames, glazing, interior accessories and building interior. Site design is important because by altering local solar, wind or air temperature the thermal performance of a house can be improved. An example of a site design that will improve a windows performance is the windbreak upwind of a house. This stategy functions because wind direction in an area is usually the same during seasons. With the winter winds coming from essentially one direction, a windbreak can reduce the infiltration rate and convective heat losses. The infiltration rate is reduced because the windbreak will decrease the wind pressure on the joints and crakcs of the windows. The convective heat loss will be less because with less air movement across the window the boundary layer will be more effective in its thermal resistance. If a planted windbreak is going to be used, it should be located downwind a distance no further than one to one and a half times the building's height. A fence windbreak should be located closer, and allow part of the wind through. By allowing some wind through the fence, the turbulence of a solid fence will be evened out. If the wind's direction changes for summer, the cooling affect will be maintained. 5BB

The use of exterior appendages is very valuable in window design. The appendages can give daylighting, natural ventilation, increased insulation, and shading, depending on how they are used and what effect is needed. During winter when the sun is shining the appendage can be opened allowing light and solar energy into the house. At night, or times of no sunshine, the appendage is closed creating an air space and along with appendage itself will be about equivalent thermally to adding another glazing. During summer the appendage can be used to shade the sun's energy and allow natural ventilation. Reflected ground light will be admitted to give some daylighting. The exact type of exterior appendage will determine how effective each of the factors are in improving the windows performance. 5BB

The frame design is important to window performance for several reasons. How much lineal feet of framing there is will affect how much infiltration is allowed into the house. The larger windows will let in more solar energy in comparision to the infiltration rate than a smaller window, but the amount of conductive losses will be greater in the larger window, unless night insulation is used. It is for these reasons that the sizing of the window area, along with window perimeter, should be carefully designed to give optium energy gain. The direction a window opens will be important in

allowing air to either enter or leave the house. Also of importance to window performance is the tilt of the frame. By tilting the window frame towards the ground the summer load can be reduced and the winters solar gain largely unaffected. The summer load is reduced for two reasons, the amount of direct solar energy allowed to strike the window, and the amount of solar energy allowed through the window. With glass the solar transmissivity is greatly reduced for angles of incidences greater than 57 degrees. In summer, with the sun higher in the sky, a greater than 57 degree angle of incidence can be obtained with the correct tilt. Also to be considered in the tilt is to insure that less than a 57 degree angle of incidence is maintained during the winter. If the above tilt can be obtained the amount of solar energy allowed through the glazing will be essentially unaffected during winter, because the sun is lower in the sky, and greatly reduced during the summer. 5BB

The glazing is the last chance to stop adverse climatic forces. Single glazing has been greatly used throughout the United States and is the least effective in controlling climatic forces. What can be done with multiple glazing will be discussed later. An often overlooked glazing material is the glass block. The glass block has some unusual properties that can be effectively used in energy conservation. The U value of glass block can be as low as 0.44, if a double air cavity is used. The larger the face area is the better the performance will be, because of infiltration. The glass block also has substantial mass, which can be used to store some heat, which then can be radiated into the house at a later time. How much light is transmitted can be controlled, along with the direction the light comes out of the block. Therefore, the solar energy could be allowed to penetrate further into the room and onto more mass. What kind of glazing is used will effect the amount of solar energy admitted, the amount of daylighting obtained, and the amount of insulation provided for heat loss. 5BB

Interior accessories are numerous, and varies greatly in how they effect the performance of windows. One advantage to interior accessories is their accessibility. An interesting accessory that can be used on any south facing window is the Ark-tic-seal. The system consists of a guide frame with three film shades; one heat absorbing, one reflective, and one clear. During winter days the heat absorbing and clear shade are lowered. The solar energy will heat up the heat absorbing film. When the air is warmer between the shade than the room temperature a vent opens, allowing the air into the living space. When the air cools down lower than room temperature the vent will close. At night all three shades are lowered providing an effective insulator. The window can also be used during the summer for cooling. This accessory, by collecting and distributing solar heat at the window vice the living space, alleviates the problem of fabric fading and glare from direct sunlight. At night, this device, by providing a good insulator, greatly decreases the windows losses. 5BB

The building interior will greatly determine of what use the admitted solar energy is to the house's heating load. How the window is used in the basic concepts have already been covered. An idea

that can be used in just about any house, is to place some thermal mass by the window to store what solar energy is admitted into the house. Water can be used for this very effectively. The above strategies give some idea of what should go into the design of a window for a house, for them to be effective in energy control. 5BB

THREE GENERATIONS OF WINDOW DEVELOPMENT

The glass used in windows have gone through essentially three generations to date. The "first generation" is the flat clear glass used in most houses. If this glass is used as a single glazing it is not very effective for use with solar energy. It will allow the most energy through, but also has the lowest U value. Multiple glazing can be used to increase the U value, but the amount of solar radiation allowed through will be decreased. The "second generation" is the use of heat absorbing and glare reducing tinted glass. Their function is to reduce excessive solar brightness, like putting sunglasses on a building. They can also have low U values. There is also some special low absorbance glass to give high solar energy transmission. This kind of glass is usually used in solar collectors. The "third generation" glass, are those with reflective characteristics. A thin reflective film is applied to the glass. This type of glass can have a range of reflectance, absorbance and transmission properties. The successive generations of windows show the increased consideration of the solar energy in glass advancement, which should result in better performing windows. 5T

ENERGY TRANSPORT CONTROL IN WINDOWS

A new concept in window systems designs, uses a larger than normal interpane separation, with venetian blind-like convection inhibiting and radiation-controlling arrays. Exhibit 29 is a schematic of a between-the-glass convection-radiation control system.

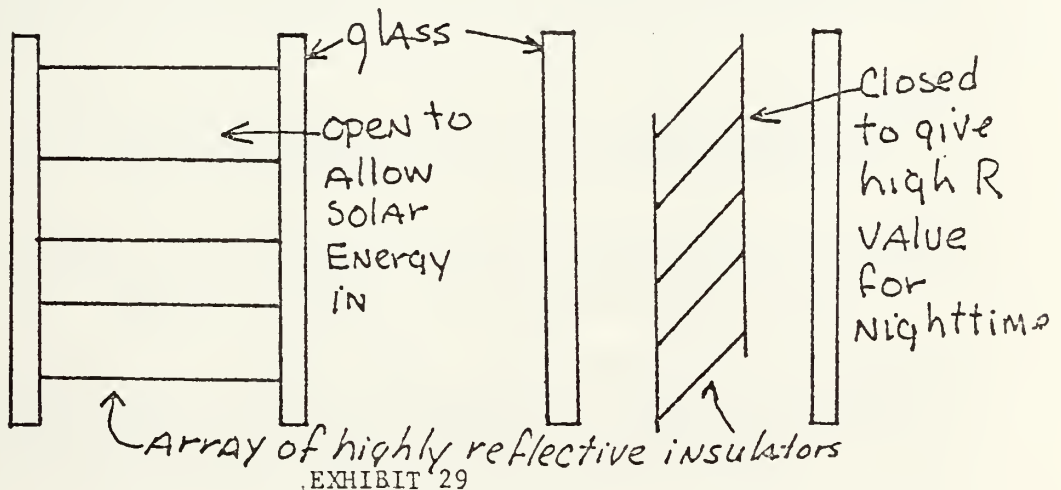

More than one array can be used in a window. When more than one array is used, a higher R value is obtained and greater operational flexibility is achieved. The arrays can be arranged so that the maximum amount of solar energy is admitted into the house, and so that the solar energy is directed to the thermal storage within the house. In tests conducted with this type of window system, U values

of 0.1 BTU/hr/sq. ft./°F in the nighttime mode, and 0.2 BTU/m/sq. ft./°F in the solar acceptance mode have been obtained. Even smaller U values appear to be achievable. This type of window system can make the window, usually an overall deficit to the house's heating load, an asset. This window system is a good example of what can be done to improve the performance of windows, a very important part of passive solar heating systems. 5R

At present multiple glazing is the usual method used to improve the U value of windows. The primary disadvantage to using multiple glazing is that as the U value decreases, with added glazings, the present solar radiation transmitted decreases. Exhibit 30 shows how the present solar radiation transmitted and U value varies for different number of panes. Exhibit 30^o indicates that multiple glazings can be effective in controlling heat loss on the windows not used for collecting solar energy. As previously covered, there is work going on to try and improve the characteristics of windows for use in a passive solar system. When the disadvantages of glass are overcome, with the advantages maintained, the performance of passive solar systems will be improved. 5

WINDOW QUILT

Window coverings can greatly improve a windows thermal performance. As mentioned earlier, there are many different kinds of window covers. Most coverings are designed to work with windows associated with a passive solar system. A concept that can be used on any window is the window quilt insulating shade. The window quilt has five layers, consisting of two layers of polyester batting separated by a vapor barrier of metalized polyester film with a decorative covering. The mounting hardware is designed so the the shade can be moved up and down and have the edges sealed. When the shade is all the way down the perimeter of the sahed is sealed. The shade performance is as follows;

1. Window Quilt applied to double hung single glazed window
 - a. U value 3.15 BTU/sq. ft./hr/°F without window quilt
 - b. U value 2.30 BTU/sq.ft./hr/°F with window quilt
2. Window Quilt applied to air tight fixed single glazed window
 - a. U value 1.03 BTU/sq. ft./ hr/°F without window quilt
 - b. U value 0.23 BTU/sq. ft./hr/°F with window quilt

The payback period will depend on how conscientious the user is, but should be from 2 to 8 years depending on weather conditions. A nice feature with this insulating shade is that conventional shades can also be used with it to make an attractive window. 5Q

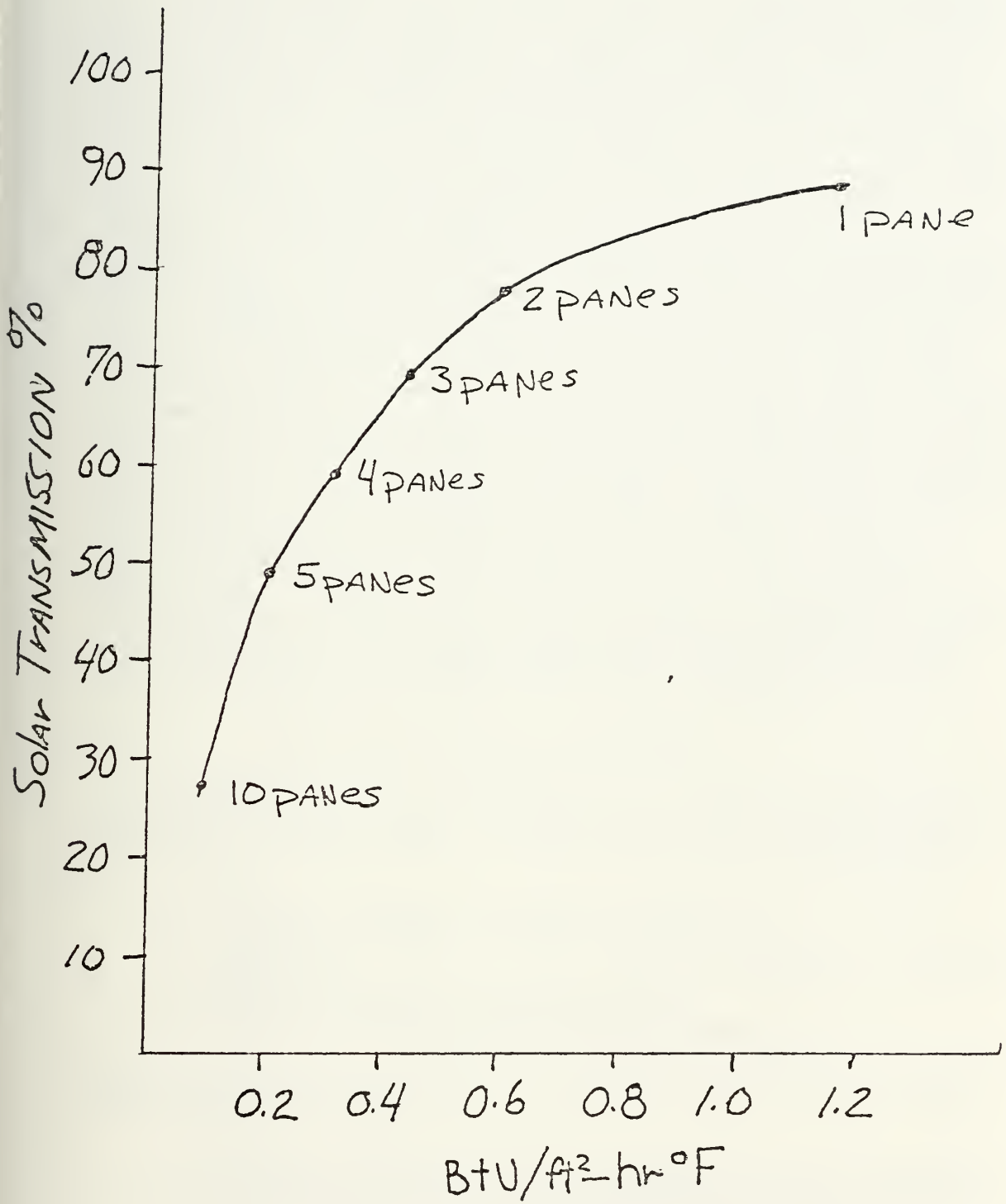

EXHIBIT 30

THERMAL DATA REQUIREMENT AND PERFORMANCE EVALUATION

Perhaps the weakest area in passive solar heating technology is in predicting a systems performance. There are simplified techniques and computer programs which are designed for specific passive solar concepts, but when combinations or hybrid systems are used the techniques have to be modified, which usually requires a working knowledge of both computer programming and heat transfer. To further complicate the problem, when passive solar concepts are combined their performance is not always the sum of the individual concepts. This lack of workable methods to simulate the performance of passive solar systems has resulted in passive solar heating getting a bad name, because of inadequately designed building being uncomfortable. The situation is improving because of experience gain from houses with passive solar systems. Therefore, a standardized method of evaluating passive solar systems should be developed, so that systems designed will give at least adequate performance and preferably the maximum performance. The procedure may require a computer, but it should be a canned program that can evaluate any of the passive solar concepts, combination of, and or hybrids by simply changing parameters. Another problem with simulating passive solar systems is the need for hourly weather data, which is very time consuming. There has been a procedure proposed by D. W. Low to greatly reduce the required weather data. The procedure reduces the years hourly weather data to three "weeks" of hourly data. This procedure has been tested and can produce results that are 99.6% accurate at about 6% of the cost of 100% accuracy. A description of the procedure is presented in reference 1. Conceivable if a canned computer program as described above, could be developed along with reduced weather data, the optimum passive solar system could be determined for a particular area.

STANDARIZED EVALUATION PROCEDURES

The National Bureau of Standards, at the request of the Department of Energy, is putting together a document that will standardize the evaluation of passive solar systems. The scope of the documents is as follows;

1. Establish pertinent performance factors.
2. Determine the type, accuracy, range and frequency of required measurement.
3. Identify appropriate instrumentation.
4. Recommend data analysis and reporting techniques

From the results of the project the evaluation of the passive solar system should be able to;

1. Determine energy savings of fossil fuel and electrical power.
2. Determine the fraction of the building's hot water, heating and/or cooling load contributed by a passive system.
3. Evaluate passive components thermal characteristics
4. Determine the building's comfort level
5. Determine the extent of occupan interaction required for functional performance or other operational requirements.

6. Determine the system degradation for the measurement period,
7. Obtain insolation and other ambient environmental data for designing and evaluation purposes.

For further details on the project refer to reference 5V. This kind of work is the kind needed to get passive solar systems more fully accepted, and should result in easier designed systems that provide acceptable comfort conditions to homeowners. 5V

SIMULATIONS

SIMPLIFIED TECHNIQUE/CROSLLEY HOME

A non computer method of predicting the annual performance of a passive solar system with minimal heat storage has been performed on the Crosley Home, by Andrew M. Shapiro. The method uses average monthly sun and temperature conditions from available weather data. The month is then broken down to full sun days and non full sun days. It is considered that on full sun days there will be an excess of solar energy available. The average monthly and daily heat loss is calculated using standard procedures. For a full sun day one starts at a given hour, and calculates the heat loss and gained during that hour. If there is any extra energy available the surplus is carried to the next hour as heat stored. All heat storage in the house is treated as an isothermal mass at the temperature of the interior of the house. When there begins to be a surplus of energy the house will begin to raise in temperature. The greater temperature will cause a greater heat loss, because of the greater difference in temperature. The increase in heat loss is tabulated separately from the heat loss if the house stayed at 20°C. For the next hour the heat loss due to increasing the interior temperature is subtracted from any surplus energy available, whatever energy remains is added to the next hour. This process continues until the heat storage reaches full capacity. At full capacity any additional solar energy is not allowed into storage (dumping). Losses due to any increased interior temperatures (overheating) or dumping are totalled separately. At this point the only sun heat being used is that which is keeping the house at 20°C. If a person did not want to dump as much solar energy, additional thermal mass could be added to the house. After the sun goes down the heat stored in storage will be released until room temperature is reached. The heat from storage will be equal to the heat loss for that hour, which is the heat loss at 20°C and any heat loss due to the interior being at a higher temperature. One full sun day is done for each month using average maximum, minimum and mean temperature, and average clear-day radiation. The average monthly gains and losses over the heating season are tabulated as follows:

1. Average heat loss in absence of sun and average gain from sun are figured from the average daily figures, for loss and gain, multiplied by the number of days per month.
2. Full sun day totals for overheating and dumping are multiplied by the numbers of clear days in the month.
3. The results of 2 subtracted from the monthly average gain from the sun will give the useable sun heat.

4. The useable sun heat subtracted from the heat loss in absence of the sun will give the needed supplementary heat needed.

Exhibit 31 is a graph of the above procedure used on the Crosley home for a full sun day in December. Although this is a simplified method to simulate a passive system, it is obvious that it will be time consuming to perform. Considering the cost for the time to work this method makes the computer simulations more attractive. The problem with computer simulation is that they are as of yet not flexible enough to be used on any system but what they were designed for. The computer programs can handle some modifications but it will usually involve modifying the basic program. This kind of modification will require computer programming and heat transfer knowledge. A computer program that can give results for many different passive solar systems by modifying input parameters is very much needed.

COMPUTER SIMULATION/PASOLE

PASOLE is a computer program to predict the performance of a Trombe Wall or a water wall. This program was select to work with to gain the experience of working with a canned computer program, and to see what kind of performance could be obtained from a Trombe Wall in Corvallis, Oregon. Weather data for the program was collected for the month of December only, for the year 1978. The winter of 1978 in Corvallis was a severe winter. Therefore, the percent solar load from the computer run will be close to the minimum that could be expected. A copy of the weather data used is in appendix 1. Tom Wilson, from Oregon Department of Energy, was consulted to find out how to use PASOLE. Tom Wilson has used and modified PASOLE to its present state.

A copy of PASOLE is in appendix 2. The program can be run from cards or a terminal . The terminal was selected for two reasons; to learn how to use the terminal and because the terminal uses less time between runs. PASOLE has been constructed as the source program with PASOLGO as the object program. Before PASOLE can be used two files have to be created. A weather file and a command file. The weather file was created from cards in the following format:

<u>COLUMN</u>	<u>DESCRIPTION</u>	<u>UNITS</u>
8 - 9	Year (19)	- -
11 - 12	Months (1 - 12)	- -
14 - 15	Day (1 - 31)	- -
17 - 18	1 Hour (0 - 23)	- -
20 - 23	Total solar radiation on a horizontal surface	- - W/M 2
28 - 29	Wind Speed	M/sec
31 - 35	Dry buld temperature	deg. C

Hourly weather data was collected and put into a file named weather. The weather file has to have data for 24 hours a day. The first hour of the day has to be zero hour with hour twenty three as the last

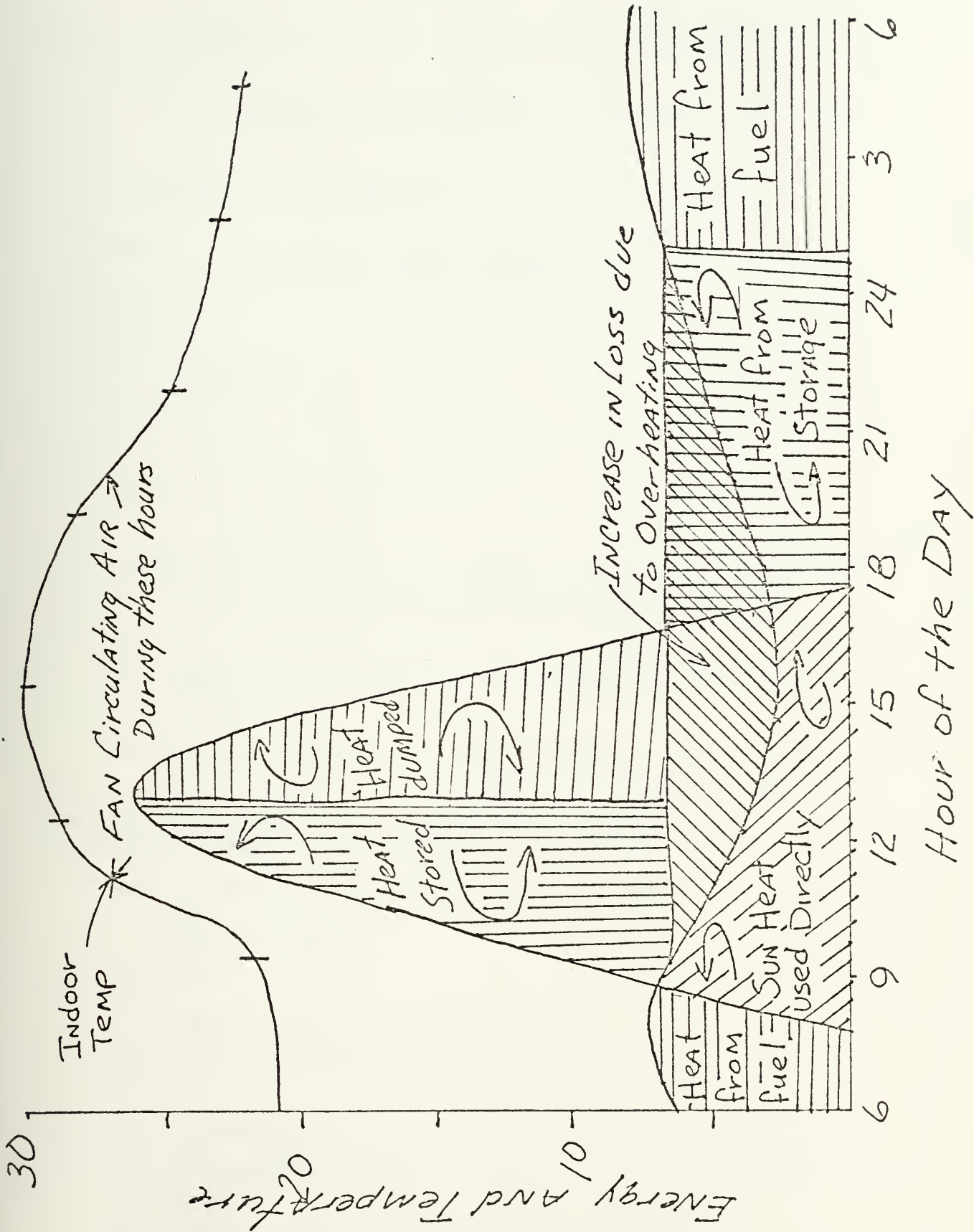

EXHIBIT 31

hour or the program will not run properly. The command file can be easily created from the terminal, and has the following command inputs:

- CONTROLTMP (next line gives minimum and maximum control code temperature for night and day) T-Min_nite, T-max-nite, T-min-day, T-max-day
- D LONGITUDE (next line gives difference in time longitude and actual longitude)
- HOURLY 10 (next line specified starting and ending days for hourly output) MMDDY, MMDDYY
- LATITUDE (Next line gives latitude in degrees)
- MONTHS (Next line gives the number of months the simulation is to be run.)
- RESNIGHT (Next line specifies R-value of night covering insulation for wall. Units are 1/BTU/°F/sq. ft.)
- STARDATE (Next line specifies the starting date of simulation, MMDDYY format)
- U LOAD (Next line gives the load value of house normalized by the collector area, house load/collector area (BTU/hr/°F/sq. ft. of wall).) This value is usually about one.
- VENTS (Next line gives vent status, 0 = no vents, 1 = vents always open, 2 = no reverse flow, 4 = Thermostatic vent control. Default = 0
- AUX COOLING (specifies whether auxiliary cooling will be used

On the terminal a number of command files can be created so that runs with different parameters can be easily run. An example of a command file created on the terminal is as follows;

Note; Underlined material to be entered at terminal

1. Log onto terminal

Control A

2. /EDIT, COM (Com is command file name)
3. Begin text editing
4. ? A
5. Enter text
6. ? / CONTROL TMP
7. ? 60. 75. 65. 75.
8. ? D LONGITUDE
9. ? 3.4
10. ? HOURLY I 0
11. ? 120178, 123178

12. ? LATITUDE
13. ? 44.55
14. ? MONTHS
15. ? 1
16. ? RESNIGHT
17. ? 3
18. ? STARTDATE
19. ? 120178
20. ? ULOAD
21. ? 1
22. ? VENTS
23. ? 2/
24. Ready
25. ? END
26. End text editing
27. \$ EDIT, COM.
28. / SAVE, COM

Now the command file COM is created and can be used in PASOLE. The data for the commands can be located anywhere on the next line for that command.

With the weather and command files created PASOLE can now be run. The following steps are used to run PASOLE and have the results printed on the computer printer.

Note: Underlined material to be entered at terminal.

1. Lot onto terminal
2. / SETTL, 100 (sufficient for one months data)
3. \$ SETTL, 100
4. / GET, WEATHER, COM
5. / GET, PASOLE/UN = (file # where PASOLE stored)
6. / FTN, I = PASOLE, L = 0, B = PASOLGO , OPT =2
7. / SAVE, PASOLGO
8. / ATTACH, IMSL/UN = LIBRARY
9. / X, LIBRARY = IMSL
10. Library = IMSL
11. / TITLE (PFIL) Put in title desired for output
12. / PASOLGO, PFIL
13. X CP seconds execution time
14. / ROUTE, PFIL, DC = PR
15. Route, Complete
16. / BYE

At this stage PASOLE will be run and the results printed on the printer, with the input of the weather and command file used to give the output. One month of data will take about 43 CP seconds. The ULOAD and RESNIGHT commands were considered the most important as far as system performance was considered. The following values for ULOAD and RESNIGHT were used to obtain the present solar load from PASOLE.

<u>ULOAD</u>	<u>RESNIGHT</u>	<u>PERCENT SOLAR</u>
1	1	3.82
1.5	3	7.89
1	3	11.53
.5	3	20.55
1	9	18.61

The actual printouts for these runs are in appendix 3. The above results show that the percent solar can be changed greatly by changing the values for ULOAD and RESNIGHT. The lower value of ULOAD is an indicator of a tighter house as far as infiltration is concerned. The higher value of RESNIGHT means there is less loss of heat at night. To maximize the performance of a Trombe wall, ULOAD should be a minimum and RESNIGHT a maximum.

The PASOLE program can simulate a Trombe wall or a water wall, but to change from Trombe wall to water wall requires modifying the base program. There is an on going attempt to create, from PASOLE, a program similar to F-chart. This program will be of greater use for designing passive solar systems. A description of PASOLE is in Appendix 4, it is essentially a thermal network solution.

EVALUATION OF PASSIVE SOLAR HEATING SYSTEM PERFORMANCE

Once a passive solar system has been built, how does the user know how well the system is performing. Bristol L. Stickney has devised a simple method to evaluate a passive solar system's performance. The method requires only a pair of maximum minimum recording thermometers. At present the method is applicable to winter heating only. The following are definitions of symbols used in the evaluation process.

ITMAX-Indoor air temperature maximum

ITMIN - Indoor air temperature minimum

OTMAX - Outdoor air temperature maximum

OTMIN - Outdoor air temperature minimum

ITR - Indoor temperature range

$$ITMAX - ITMIN = ITR \text{ (equ. 1)}$$

OTR - Outdoor temperature range

$$OTMAX - OTMIN = OTR \text{ (equ. 2)}$$

RR - RANGE RATIO

$$ITR/OTR = RR \text{ (eq. 3)}$$

OTDY (Delta Tee Daytime) The indoor-outdoor temperature difference during day

$$ITMAX - OTMAX = OTDY \text{ (equ. 4)}$$

OTNT (Delta Tee night) The indoor-outdoor temperature difference during the night

$$ITMIN - OTMIN = OTNT \text{ (equ. 5)}$$

OTAV Delta Tee average

$$(OTDY + OTNT) / 2 = OTAV \text{ (equ. 6)}$$

ITAV - Indoor temperature average

$$(ITMAX + ITMIN) / 2 = ITAV \text{ (equ 7)}$$

OTAV - Outdoor temperature average

$$(OTMAX + OTMIN) / 2 = OTAV \text{ (equ 8)}$$

The thermometers should be placed in a shaded area, inside and outside, and reset so that no previous measurement will be recorded. They should be set up in the morning between 7:00 A.M. and 9:00 A.M. and left for 24 hours. At that time ITMAX, ITMIN OTMAX and OTMIN should be recorded. The data can be taken for any day, but a cold sunny day will tend to give the most meaningful results. A cold sunny day will tend to drive up the indoor temperatures and tax the limits of the storage mass. 5W

Once the four initial temperatures are obtained, the remaining eight parameters can be derived from equations 1 through 8. ITR and OTR establish the limits of the indoor and outdoor temperature fluctuations. RR establishes a reference number that indicates the quality of the buildings response to these fluctuations. OTDY, OTNT and OTAV indicate the building response to raises, drops and fluctuations in outdoor temperature respectively. ITAV is an indicator of the average comfort level indoors and OTAV indicates the average severity of the outdoor. The absolute accuracy of these parameters are not necessary. Once the eight parameters are obtained interpreting them is difficult. Bristol L. Stickney has devised a chart to easily interpret the meaning of the parameters. Exhibit 32 is the chart devised by Stickney. 5W

The RR and OTAV values are used to determine how the system is performing. The OTAV value is plotted on two parallel lines offset to give the limits of fluctuation on the OTAV scale. The OTR scale is used to set the upper limit of the RR values. The OTAV scales and OTR scale will line off a comfort zone, zone A, zone B, zone C, zone D, zone E and zone F. By plotting the point where the RR value and OTAV value cross, the performance of the system can be determined. The best performance would be the center of the comfort zone, but as long as the point is within the comfort zone the interior temperature stayed within comfort standards (60 to 75°F) What is indicated if the point is within one of the other zones is as follows:

ZONE A - RR too high, OTAV is too low

Bristol L. Stickney Performance Chart

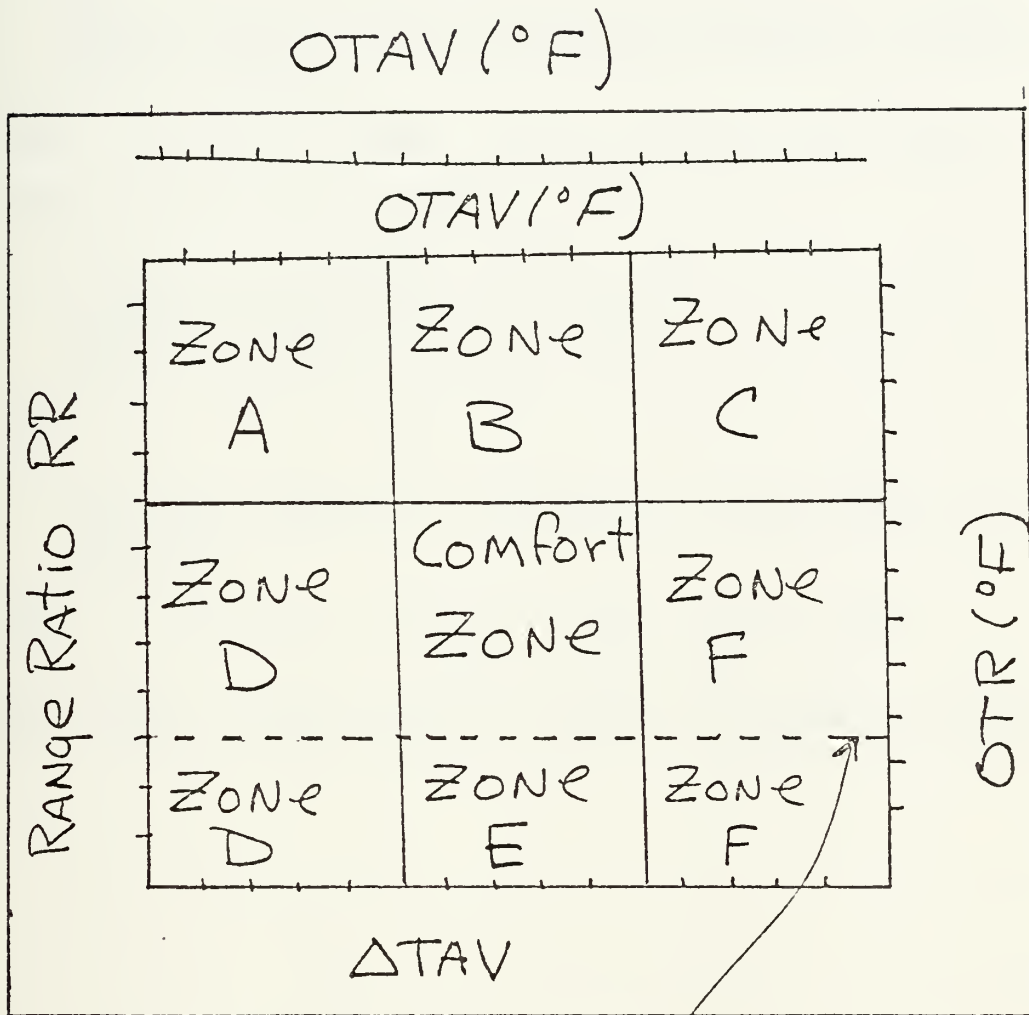

Lower Range Limit.
The RR value below
which it is ASSUMED
that the thermal
gradient is too small
to allow heat flow

EXHIBIT 32

The thermal contact between the storage mass and the collector is inadequate

Add more storage mass and/or more sunlit storage surface area
Add more insulation to improve the inadequate thermal envelope of the building. (i.e. night shutters, roof and wall insulation)

ZONE B - RR is too high OTAV is O.K.

More storage mass and/or sunlit mass surface area is needed.
Venting overheated air and/or shading the south of the building may be necessary.

ZONE C - The RR is too high. OTAV is too high. Same as ZONE B

ZONE D - The RR is O.K. OTAV is too low.

The building needs more collector area.
A better thermal envelope is needed.
Add insulating shutters and/or more in the walls and roof.
Remove any southern shading devices.

ZONE E - The RR is low OTAV is O.K.

There is no solar gain. Either the building is being heated by storage discharge, or a thermostatic space heater is in operation.

ZONE F - The RR is O.K. OTAV is too high. Same as ZONE B

This system can be used on any type of passive solar system in any location, and is very easy to use. This type of evaluative procedure is needed if passive solar systems are going to be generally accepted. 5W

The thermal contact between the storage mass and the collector is inadequate

Add more storage mass and/or more sunlit storage surface area
Add more insulation to improve the inadequate thermal envelope of the building. (i.e. night shutters, roof and wall insulation)

ZONE B - RR is too high OTAV is O.K.

More storage mass and/or sunlit mass surface area is needed.
Venting overheated air and/or shading the south of the building may be necessary.

ZONE C - The RR is too high. OTAV is too high. Same as ZONE B

ZONE D - The RR is O.K. OTAV is too low.

The building needs more collector area.
A better thermal envelope is needed.
Add insulating shutters and/or more in the walls and roof.
Remove any southern shading devices.

ZONE E - The RR is low OTAV is O.K.

There is no solar gain. Either the building is being heated by storage discharge, or a thermostatic space heater is in operation.

ZONE F - The RR is O.K. OTAV is too high. Same as ZONE B

This system can be used on any type of passive solar system in any location, and is very easy to use. This type of evaluative procedure is needed if passive solar systems are going to be generally accepted. 5W

CONCLUSION

At this point it would normally be appropriate to present why passive solar heating is the desirable way to go. To do this would mean trying to point out how passive systems are better than active ones. This type of thinking has created two sides, when there should only be one. Initially separating the solar concepts into passive and active was probably good, in that a concentrated effort could be put into each side. As stated by Richard S. Levine, it is time to start using an integrated approach to solar designing, one that would take the best from both passive and active systems to come up with a 100% solar heated house, except for pumping power and controls. Our present state of design is like the first powered vehicle, the horseless carriage. The horseless carriage had an internal combustion engine on a vehicle that use to be pulled by a horse, which was an awkward arrangement. With time an integrated approach was taken and the Model T came out, which is what is going to have to happen to solar design. An example of how a non integrated approach can lead to not the best design is the F chart program. The F chart program is very popular and accurate within the range it was designed for, but it is only designed for active systems and gives accurate results only for solar systems that will provide up to 70% of the heating load. These assumptions are obsolete, because it is possible to design a cost effective house that receives all it's heating, cooling and hot water needs from solar energy. It is therefore time for solar design to get out of its infancy and start advancing towards an integrated approach. Once this design becomes accepted the two sides can work together, and start to quickly advance solar design. The Raven Run Solar House has been designed from an integrated approach to supply 100% of the heating from solar. This house has active and passive collectors side by side on the south wall to optimize the solar collection. The integrative design concept goes beyond maximizing solar collection and storage to what the house is made of, how it is constructed and site conditions. At present the biggest problem with integrative design is the design itself. There will have to be simplified design procedures developed before solar energy systems become generally accepted. A possible hindrance to integrated design being accepted is that passive systems have been thought as for architects, and active solar systems for engineers. This kind of thinking will have to be rejected, with both engineers and architects working together. Together is the key word, everyone working towards a common goal. 5A

There has been some advancement of materials that can improve the performance of solar systems. These materials can be very useful, but unless solar design becomes generally accepted there will be no market for them. At this stage then, it will be important to take the steps that will begin to make solar design accepted. The more accepted solar design becomes, the more incentive there will be for improving materials for solar systems. A weak incentive, by the governments, is the tax incentives. The problem with tax incentives are they encourage systems that supply the minimum percentage of the heating load by solar energy. When just the opposite should be encouraged, the use of larger solar percentage units.

The one area where an integrative design would not be applicable is in retrofitting existing houses. The active systems are probably best suited for use on houses already constructed. Passive systems can be retrofitted, but their performance will not be equivalent to new construction, as it can easily be with active systems.

Solar energy can supply a major portion of household heating needs. How much of the nations household heating needs will be supplied by solar energy will depend greatly on the direction taken by solar designers. Exhibit 33 shows how available energy is used in the United States. 2 The flow of available energy shows that the household and commercial area is a very bad user of available energy. If solar energy systems could become generally accepted it could considerably improve our nations use of available energy. This should be a considerable incentive for both government and the private sector to push hard for solar energy use in households and commercial buildings. At present there is a good start, but solar design is now at an important crossroad, if the integrative approach is not taken, solar energy systems will not be very successful.

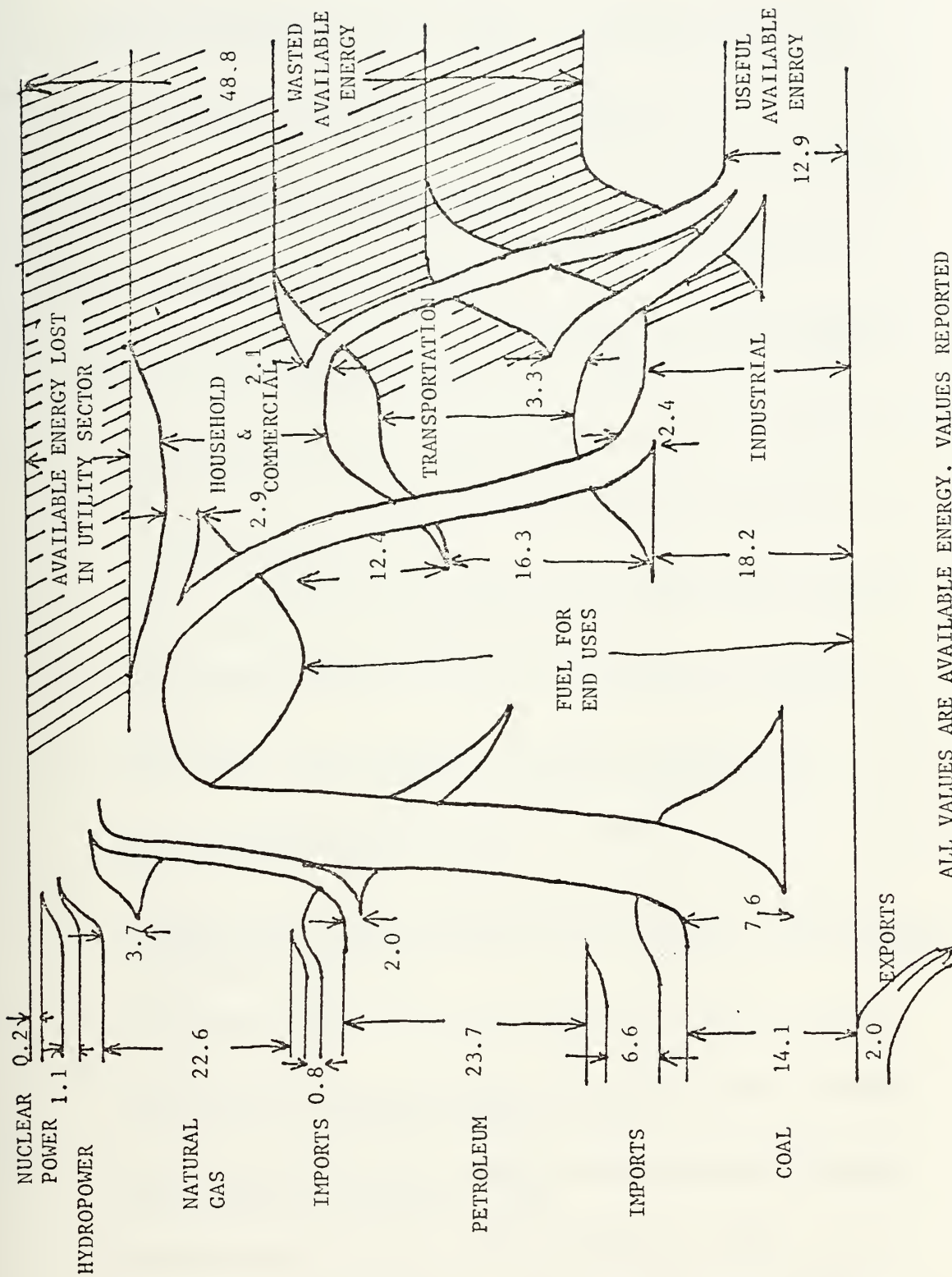

ALL VALUES ARE AVAILABLE ENERGY. VALUES REPORTED ARE 10¹⁵ BTU. EXHIBIT FROM PAPER "AVAILABLE ENERGY CONVERSION AND UTILIZATION IN THE UNITED STATES" by G.M. REISTAD

EXHIBIT 33

References

1. A Directed Weather Data Filter, by D. W. Low, IBM Journal of Research and Development, V. 22 No. 5, September 1979, p. 487
2. Available Energy Conversion and Utilization in the United States, G. M. Reistad, Journal of Engineering for Power
3. Homeowners Guide to Solar Heating, by the Editors of Sunset Books and Sunset Magazine, Lane Publishing Co.
4. Passive Solar Building A Compilation of Data and Results, by R. P. Stromberh and S. O. Woodall
5. Passive Solar State of the Art, Proceedings of the 2nd National Passive Solar Conference, March 16 - 18, 1978, Vol. I, p.269, Vol. II, p. 270 - 690, Vol. III, p. 691 - 951
 - A. Passive Systems for Solar Heating and Cooling - Historical Perspective, by John I. Yellot, p.1
 - B. State of the Art in Passive Solar Heating and Cooling, by J. Douglas Balcomb, p.5
 - C. House at Crooked Creek, by Marc Schiff, Direct Gain Passive Solar Design in an Extreme Climate, p. 38
 - D. Two Recently Completed Trombe Wall Retrofits, by Thomas C. Wilson, p.76
 - E. Prediction of Performance of a Minimal Storage Passive Solar House, The Crosley Home, by Andrew M. Shapiro, p.86
 - F. The Linderberh Residence; A D.O.E. Funded Hybrid Solar House, by Peter John Pfister, p.122
 - G. A Passive Solar House Based on Balanced Direct Gain Heating and Night Ventilation Cooling, by Polly Cooper, Kenneth Haggerd and Philys Niles, p.133
 - H. Intergrative Design: The Raven Run Solar House, by Richard S. Levine, p. 141
 - I. Focusing Roof Aperture and Water Wall Passive Solar Heating Combination, by Harrison Fraker, p. 150
 - J. Vertical Solar Louvers; A System for Tempering and Storing Solar Energy, by Jim Bier, p.209
 - K. Passive Solar Retrofit, Geoffrey Gerford, p. 228
 - L. A Hybrid/Active Solar House; First Year Performance of the Hunn Residence, by B. D. Hunn, p.237

- M. Markle/Vermont Hybrid Solar Residence, by Sheldon Klapper, p. 252
- N. Solar Atrium; A Hybrid Solar Heating and Cooling System, by Mark Ireland A.I.A., D.C. Larson, p.256
- O. Building as an Organism, by Day Chalroudi, p.276
- P. A Self Inflating Movable Insulation System, by Ronald Shore, p. 305
- Q. The Window Quilt Insulation Shade, by John Schnebby, Thomas Lowell and Michael Mross, p. 314
- R. Energy Transport in Window Systems, by A. L. Berlad, R. Jaung, Y. J. Yeh and N. Tutu, p.326
- S. Transparent Heat Mirrors for Passive Solar Heating Applications, by Stephen Selkowits, p. 329
- T. Single and Multiple Glass Glazing Midia in Passive Solar Energy Construction, by C. W. Clarkson and M. L. Lilly, p.340
- U. Variable Transmission Solar Membrane, by Day Chakroudi, p. 343
- V. Thermal Data Requirement and Performance Evaluation Procedures for Passive Buildings, by William Lucas, John Holton, Elmer Streed and Willian Angel, p. 411
- W. A Low Cost Method of Evaluation and Performance Standards for Passive Solar Buildings, by Bristol L. Stickney, p. 440
- X. Passive Solar Collector Wall Incorporation Phase Change, p. 485
- Y. Four Generations of Water Wall Design, by Tim Maloney, p.489
- Z. Effects of Controls on Water Wall Performance, by J. R. Clinton, A. V. Sebald, F. Langenbacher and E. Hendricks, p. 555
- AA. The Double Box, by Michael Garrison
- BB. A Comprehensive Approach to Window Design for Energy Conservation, by S. Robert Hastings
- CC. Movable Insulation, New Development at Zomeworks, by Robert Hymen
- DD. Kelbaugh House; Recent Performance, by Doug Kelbaugh, A.I.A.

```

PROGRAM PASOLE(OUTPUT,INPUT,TAPE1,TAPE2)
01.17.79 CHANGE DECLINATION FORMULA TO U. AND. 3. INSTEAD
      OF LASC FORMULA
01.08.79 ADD SEVERAL PARAMETER COMMANDS, REARRANGE
      ASSIGNMENT OF STANDARD PARAMETERS
12.29.78 MODIFY TO USE WIND SPEED IN M/S - CHANGES IN
      FIXED MODEL AND IN HAIR CALCULATIONS (5.+ INSTEAD OF 15)
COMMON/BLAD1/NV, NF, NT, NMAX, KF(50), LC, LV(50), LF(50), LT(50),
1 KICNG, KIC, ITMAX, HEAR, UNITS, KAUXCL, KCALC, KJELT, KCOIU
COMMON/BLAD2/NTIME, NTIME, ITIME, DATE, DAY, DAY1, DAY2, NDAY(12),
1 MO, MO1, YR, NMO, NDAY1, INDATE
COMMON/BLAD3/T(50), TO(50), CPM(50), S(50), SP(50), CONO(50,50),
1 SCUN(50), QFAC(50), ERRT(50), FN(50,50,2), FO(50,50,2)
COMMON/BLAD4/RA(50,50), B(50), SQRSC1(50), SQRSC2(50), FSQCON1(50),
1 SQCON2(50), QVHI, QVCL, QAHT, QACL, QHZ, QINC, QTRAM
COMMON/BLAD5/SUMKT, QCIN, QCINU, FAC, FRAC,
1 PI, TIMEA, DEGRAD, TBASE, UD, TMAX, TMIN, TBAR, FACI, REMAIN
COMMON/BLAD6/QSRC(50), QCON(50), IC12(100), SQC121(100),
1 SQC122(100), TCMIN, TCMAX, TCMIN, TCMINO, TCMAXN, TCMAX, TCOOL
COMMON/BLAD7/TPEKDAY, SBCON, TAMB, QCINT
COMMON/BLAD8/IDAY, IDPEYR, INDAY, KUATH, QHCUNV, ALAT, D_CNG,
1 RINDEX, TOLT, DEC, COSDEC, SINDEC, SINLAT, COSLAT, QSP
2 , HCRRI1, QICUI, KSHUT, KCOOL, MOSH1, MOSH2
COMMON/BLAD9/TAJ(50), VELD(50), QHD(50), RHD(50), NJS, ISOL(15),
1 TILT(15), WAZIM(15), ASLZ(15), NGLZ(15), HJA, IAMB(10),
2 ALFA(15), UHANG(15), OSEPR(15), TGLZ(15), JABS(15), ISOLX(24)
COMMON/BLAD10/QDNMAX, ROIFF(5), EX, RHO, TZERJ,
1 NCCNN, I1CON(100), I2CON(100), U(100), ACON(100), UD(100), UN(100)
COMMON/BLAD11/TILTC, AZIMC, RHOC, COSTC, SINTC, FSSC, FSGC, RESNI,
1 JCP, KND
COMMON/TROMBE/VOLF, RCCN(50), KVENT, IAIR, JAIR, RLENGTH, RHOSR,
1 ASPRAT, FCSR, JWA, TROCAT, JCH, KWALL
COMMON/2OFLGS/ISRCPR, I01, I02, IPRINTH, IPRINTM, IPRSH, KHEDPR
COMMON/SIMEQ/HKAREA(100), IAKAREA(100)
COMMON/TIMES/TNIGHT, TNORN, TEVEN, DELT1, DELT, TIME

```

```

DIMENSION LDAY(2), QSUM4(12,20), MOY(12), SUMTOT(20)

```

```

INTEGER DAY, DAY1, DAY2, YR, DATE, UNITS

```

```

DATA(NDAY(M), M=1, 12)/31, 28, 31, 30, 31, 30, 31, 31, 30, 31, 30, 31/
DATA NMAX, PI, DEGRAD/50, 3.141592654, .017453293/

```

```

-- PRINT REAL TIME
CALL DATE1(ARG1) $ CALL CLOCK(ARG2)
PRINT 2999, ARG2, ARG1

```

```

---- OBTAIN INPUT DATA
CALL INDATA
---- INITIAL CALCULATIONS
CALL PRIME
KERR=0

```

```

REWIND THE WEATHER DATA FILE
REWIND 1

```

```

QVHI=QVCL=QAHT=QACL=QB=QBH=0.
QHSUM=QISUM=0.
DO 220 I=1, NMAX
SQRSC1(I)=SQRSC2(I)=SQCON1(I)=SQCON2(I)=0.
220 CONTINUE

```

```

DO 225 J=1, NCCNN
SQC121(J)=SQC122(J)=0.
-- FOR NDAY1 DAYS ONLY (NDAY1 LESS THAN 32)
IFLG1=0 $ IF(NDAY1.GE.32) GO TO 228
IFLG1=1 $ NMO=1 $ LDAY(1)=INDAY+NDAY1-1
IF(LDAY(1).LE.NDAY(MO1)) GO TO 229
LDAY(2)=LDAY(1)-NDAY(MO1) $ LDAY(1)=NDAY(MO1) $ NMO=2
228 CONTINUE

```

```

MO=MO1-1 $ NTIME=0 $ NCALC=0 $ NSTEP=0
---- START TIME STEP LOOP
DO 1200 MONTH=1, NMO
MO=MO+1 $ IF(MO.EQ.13) MO=1
KCOOL=0 $ IF(RESNI.LT.0.01) GO TO 237
KCOOL=1 $ IF(MO.GE.MOSH1.AND.MO.LE.MOSH2) KCOOL=-1
237 CONTINUE
DAY1=1 $ IF(MONTH.EQ.1) DAY1=INDAY
DAY2=NDAY(MO) $ IF(IFLG1.EQ.1) DAY2=LDAY(MONTH)

```

```

---- DAY LOOP
DO 1100 DAY=DAY1, DAY2
TIME=-DELT1 $ NTIME1=NTIME

```



```

IDAY=IDAY+1 & IF(IDAY.GT.IDPERYR) IDAY=1
CALL DAYLY
UTHR=0.
IF(DATE.EQ.101) IPRINTH=1 & IF(ATE.EQ.102) IPRINTH=0
IF((IPRINTH.EQ.1).OR.(IPRINTO.EQ.1)) PRINT 4003,DATE
IF(IPRINTH.EQ.0) GO TO 245
PRINT HEADERS FOR HOURLY PRINTING
IF(KWALL.EQ.0) PRINT 4004
IF(KWALL.EQ.1) PRINT 4004
IF(KWALL.EQ.2) PRINT 4002

```

245 CONTINUE

--- TIME INCREMENT LOOP

```

DO 1000 ITIME=1,NTIME1
LTIME=ITIME-1 & IF(LTIME.EQ.0) LTIME=NTIME
MTIME=MTIME+1
DELT=DELT1 & TIME=TIME+DELT & TIMEA=TIME*24./TPERDAY
KICONG=0
QHSUM=QHSUM+DELT*QHZ & QISUM=QISUM+DELT*QING
KND=1 & IF(TIMEA.GT.TMORN.AND.TIMEA.LT.TEVEN) KND=2
KSHUT=-1 & IF(KND.EQ.1.AND.RESNI.GT.0.01) KSHUT=1
KSHUT=KSHUT*KCOOL

```

```

SET MAX AND MIN TEMPERATURES FOR THIS TIME PERIOD
IF((TIMEA.GT.TMORN).AND.(TIMEA.LT.TNIGHT)) GOTO 255
250 TCMIN=TCMINN & TCMAA=TCMAAN & GO TO 260
255 TCMIN=TCMIND & TCMAA=TCMAXD
260 CONTINUE
TCOOL=TCMAA & TCMAA1=TCMAA

```

CALL SUNSRC

```

IF(KAUX3L.EQ.0.AND.TAMB.GT.TCMAA) TCMAA=TAMB
IF(KIC.EQ.-1) T(IC)=TCMIN
IF(KIC.EQ.+1) T(IC)=TCMAA
IF(KIC.EQ.2) T(IC)=TCMIN
I280=0

```

280 CONTINUE

```

I280=I280+1
IF(I280.GT.5) GO TO 1675
NSTEP=NSTEP+1

```

--- ITERATION LOOP FOR TEMPERATURE DEPENDENCE

```

DO 500 ITER=1,ITMAX
NOCALC=NOCALC+1

```

--- GET CPM, SP, COND, T(FIXED), SCON - COULD BE F(T)

```

CALL PROP
IF(MTIME.EQ.1) GO TO 800

```

CALCULATE COEFFICIENTS A(I,J), B(J) FOR NODE EQUATIONS

```

DO 400 IV=1,NV
I=LV(IV) & SUMKT=0.
DO 300 JF=1,NF
J=LF(JF)
SUMKT=SUMKT+COND(I,J)*T(J)
B(IV)=CPM(I)*TO(I)/DELT+FAC*(S(I)+SUMKT)+(1.-FAC)*CPM(I)*QFACO(I)
IF(KCALC.EQ.2) GO TO 400
DO 320 JV=1,NV

```

300

```

J=LV(JV)
A(IV,JV)=-FAC*COND(I,J)
IF(L.EQ.J) A(IV,JV)=CPM(I)/DELT+FAC*(SCON(I)-SP(I))

```

320

400

```

CONTINUE
CONTINUE
IF(KCALC.EQ.2) GO TO 450

```

SOLVE EQUATIONS% SUM(A(I,J)*T(J))=B(I) ; I=1,NV

FOR T(J) - ANSWERS IN 3 ARRAY
THE MATRIX A IS MODIFIED BY THE IMSL SUBROUTINES.
IF THE MATRIX A IS NOT SYMMETRIC, THE FOLLOWING CODE MUST BE USED-
CALL LEQTF(A,1,NV,NMAX,8,0,WKAREA,IER)
CURRENTLY, SYMMETRY IS GIVEN WHEN COND(I,J) IS SYMMETRIC, AND THE
FOLLOWING IS APPLICABLE

```

CALL VCVTFS(A,NV,NMAX,A)
CALL LE1S(A,NV,8,1,NMAX,0,IWKAREA,WKAREA,IER)
CHECK TO SEE IF THE ANSWERS HAVE CONVERGED YET
NERR=0

```

```

DO 440 IV=1,NV
I=LV(IV) & TGUSS=T(I) & T(I)=B(IV) & ERRT(I)=TGUSS-T(I)
IF(MB3(ERRT(I)).GT.TOLT) NERR=NERR+1

```

440 CONTINUE

```

IF(NERR.EQ.0) GO TO 520
GO TO 530

```

--- SIMPLIFIED CALCULATION (SEE PRIME)

530 CONTINUE

```

IA=KF(IJ)
DO 480 IV=1,NV
I=L(V(IV)) & T(1)=0.
JJ=480 JV=1,NV
I=(KSHUT) 484,484,482
462 T(1)=T(1)+FR(IV,JV,IA)*3(JV) & GO TO 480
464 T(2)=T(1)+FD(IV,JV,IA)*3(JV)
480 CONTINUE
GO TO 520

500 CONTINUE
END OF ITERATION LOOP. IF WE GET HERE, WE DID
THE FULL NUMBER OF ITERATIONS WITHOUT CONVERGENCE.
IF(ITMAX.GT.1) KERR=KERR+1
520 CONTINUE

---HEATING OR COOLING OF CONTROL NODE
QCIN=0. & IF(KIC.EQ.0) GO TO 560
DO 540 IT=1,NT
I=L(IT)
540 QCIN=QCIN+COND(IC,I)*(T(IC)-T(I))
QCIN=QCIN-SP(IC)*T(IC)-S(IC)
IF(KIC.EQ.2) GO TO 800
560 CONTINUE
IF(KDELT.EQ.0.AND.I280.EQ.2) GO TO 800
CALL CONTROL & DELT=FRAC*DELT1
IF(KDELT.NE.0) GO TO 800
DELT=DELT1 & IF(KICHNG.EQ.0) GO TO 800
GO TO 280

---CALCULATIONS FOR OUTPUT, NEXT TIME STEP LOOP
800 CONTINUE

CALCULATE FORWARD AND REVERSE FLOWS ALONG EACH CONNECTION
DO 800 J=1,NCONN
QC120=QC12(J) & I1=I1CON(J) & I2=I2CON(J)
QC12(J)=COND(I1,I2)*(T(I1)-T(I2))
IF(MTIME.EQ.1) GO TO 808
CALL SGNINT(QC120,QC12(J),FAC1,DELT,DSQC121,DSQC122)
SQC121(J)=SQC121(J)+DSQC121
SQC122(J)=SQC122(J)+DSQC122
800 CONTINUE

COMPUTE COOLING DEGREE-TIME
IF(KAJACL.NE.0) GO TO 806
DUOH=DELT*(.5*(T(IC)+T(O(IC))-TOMAX1) & IF(DOQH.LT.0.) DOQH=0.
JH=DOH+DUOH
806 CONTINUE

COMPUTE HEAT FLOW IN,OUT OF EACH NODE, QFAC0(I),QCON(I)
DO 820 IT=1,NT
I=L(IT)
QSRC0=QSRC(I) & QCON0=QCON(I)
QSRC(I)=S(I)+SP(I)*T(I)
QCON(I)=0.
DO 820 JT=1,NT
J=L(JT)
820 QCON(I)=QCON(I)+COND(I,J)*(T(J)-T(I))
DEN=1.0 & IF(CPM(I).GT.0.) DEN=CPM(I)
QFAC0(I)=(QSRC(I)+QCON(I))/DEN
T(I)=T(I)

IF(MTIME.EQ.1) GOTO 900
INTEGRATE TOTAL HEAT IN/OUT FROM SOURCE EQUATION
CALL SGNINT(QSRC0,QSRC(I),FAC1,DELT,DSQSRC1,DSQSRC2)
SQSRC1(I)=SQSRC1(I)+DSQSRC1
SQSRC2(I)=SQSRC2(I)+DSQSRC2
INTEGRATE HEAT IN/OUT DUE TO FLOW ACROSS CONNECTIONS
CALL SGNINT(QCON0,QCON(I),FAC1,DELT,DSQCON1,DSQCON2)
SQCON1(I)=SQCON1(I)+DSQCON1
SQCON2(I)=SQCON2(I)+DSQCON2
900 CONTINUE

IF(MTIME.EQ.1) GO TO 910
---HEATING, COOLING -- QV BY VENTILATION, QA BY AUXILIARY SYSTEM
QCINT=JELT*(FAC1+QCIN+(1.-FAC1)*QCINO)
IF(KICHNG.EQ.0.OR.KDELT.NE.0) GO TO 902
QFRAC=KEMAIN & IF(KIC.EQ.0) QFRAC=FRAC & QCINT=QCINT*QFRAC
KICHNG=0
902 CONTINUE
IF(QCINT.GT.0.0.AND.TAMB.GT.TOMIN) QVHT=QVHT+QCINT
IF(QCINT.LT.0.0.AND.TAMB.LE.TCOOL) QVCL=QVCL+QCINT
IF(QCINT.GT.0.0.AND.TAMB.LE.TMIN) QAHT=QAHT+QCINT

```



```

C PRINT HOURLY FLOW VALUES
IF (LPRINTH.EQ.0) GO TO 910
IF (KHALL.EQ.2) GO TO 905
PRINT 3000, TIME, S(1), S(JWA), S(JWA+1), (QC12(J), J=1, 3),
1 (T(I), I=1, 6)
GO TO 910
905 PRINT 4001, TIME, S(1), S(JWA), S(JWA+1), QC12(1), QC12(2),
1 (QC12(J), J=7, 13), (T(I), I=1, 11)
910 QCINO=QCIN
IF (KICING.EQ.0) GOTO 920
DELTEREMAIN*DELT1 & GOTO 280
920 CONTINUE
OTWU=OTWU+T(1)-TAMB
END OF TIME STEP LOOP- GO NEXT TIME INCREMENT NOW.
1000 CONTINUE
OTWU=OTWU/NTIME1
PRINT TOTALS FOR THIS DAY
IF (LPRINTD.EQ.0) GO TO 1100
PRINT 3005, DATE, DAY, MO, QVHT, QVCL, QAHT, QACL, CO, QSP, DEC, OTWU
IF (I<XCPK.EQ.0) GOTO 1100
PRINT 3006
DO 1020 IT=1, NT
I=L+1(I)
1020 PRINT 3007, I, SQRSC1(I), SQRSC2(I), SQCON1(I), SQCON2(I)
1100 CONTINUE
-- SUMS FOR SUMMARY PRINT
M=MONTH & MOY(M)=MO & JSUMM(M,1)=00 & QSUMM(M,2)=0.
QSUMM(M,2)=QSUMM(M,2)+SQC121(1)+SQC122(1)+SQC121(JWA+1)+
1 SQC122(JWA+1)
QSUMM(M,3)=QVHT+QAHT & QSUMM(M,4)=QVCL+QACL
QSUMM(M,5)=0.
DO 1130 J=1, NJS
I=ISL(J)
1130 QSUMM(M,5)=QSUMM(M,5)+SQRSC1(I)
QSUMM(M,6)=SQC121(JCP)
IF (JCA.GT.0) QSUMM(M,6)=QSUMM(M,6)+SQC121(JCW)
QSUMM(M,7)=QACL & IF (KAUXCL.EQ.0) QSUMM(M,7)=00H
QSUMM(M,8)=QISUM & QSUMM(M,9)=QHSUM
IF (LPRINTM.EQ.0) GO TO 1200
PRINT 3017, M, MO, QVHT, QVCL, QAHT, QACL, CO
PRINT 3006
DO 1160 IT=1, NT
I=L+1(I)
1160 PRINT 3007, I, SQRSC1(I), SQRSC2(I), SQCON1(I), SQCON2(I)
1200 CONTINUE
-- SUMMARY PRINT OF MONTHLY SUMS
NJS=8
DO 1210 K=1, NJS
SUMTOT(K)=QSUMM(MMO, K)
SUMM1=QSUMM(1, K)
DO 1210 M=2, NMO
SUMM2=QSUMM(M, K) & QSUMM(M, K)=SUMTOT-K-SUMM1 & SUMM1=SUMM2
IF (UNITS.EQ.2.AND.K.GT.1) QSUMM(M, K)=QSUMM(M, K)/1000.
1210 CONTINUE
IF (KAUXCL.EQ.0) PRINT 3020
PRINT 3019, MTIME, NSTEP, NCALE, KERR
DO 1220 M=1, NMO
MO=MOY(M)
IF (QSUMM(M, 6).LE.0.) QSUMM(M, 6)=1.
PCTSOL=100.*(1.-QSUMM(M, 3)/QSUMM(M, 6))
1220 PRINT 3021, MO, (QSUMM(M, L), L=1, NJS), PCTSOL
IF (SUMTOT(6).LE.0.) SUMTOT(6)=1.
PCTSOL=100.*(1.-SUMTOT(3)/SUMTOT(6))
PRINT 3027, (SUMTOT(K), K=1, NJS), PCTSOL
IF (IPXSM.EQ.0) GO TO 1300
-- PRINT OVERALL SUMS OF NODE AND CONNECTION HEAT FLOWS
PRINT 3023, QVHT, QVCL, QAHT, QACL, CO
PRINT 3006
DO 1230 IT=1, NT
I=L+1(I)
1230 PRINT 3007, I, SQRSC1(I), SQRSC2(I), SQCON1(I), SQCON2(I)
PRINT 3025, (J, I1CON(J), I2CON(J), SQC121(J), SQC122(J), J=1, NCONN)

```

=====
C CONTROL SUBROUTINE
=====
C

```
SUBROUTINE CONTROL  
COMMON/BLAD1/ NV, NF, NT, NMAX, KF(50), IC, LV(50), LF(50), LT(50),  
1 KICHNG, KIC, ITMAX, NERR, UNITS, KAJACL, KCALC, KDELTA, KCONU  
COMMON/BLAD2/ NTIME, MTIME, ITIME, JATE, JAY, JAY1, JAY2, NDAY(12),  
1 MO, MO1, YR, NMO, NDAY1, INDATE  
COMMON/BLAD3/ T(50), TO(50), CPM(50), S(50), SP(50), CONO(50,50),  
1 SQON(50), QFACU(50), ERRT(50), FN(50,50,2), FO(50,50,2)  
COMMON/BLAD4/ A(50,50), B(50), SQRXC1(50), SQRXC2(50), SQCON1(50),  
1 SQCON2(50), UVHT, QVCL, QAHT, QACE, QHZ, QING, QTRAN  
COMMON/BLAD5/ SUMKT, QCIN, QCINO, FRAC, FRAC,  
1 PI, TAMEX, DEGRAD, TBASE, OJ, TMAX, TMIN, TBAR, FACI, REMAIN  
COMMON/BLAD6/ QSRC(50), QCON(50), Q12(100), SQC12(100),  
1 SQC122(100), TCMAN, TCMAX, TCMIN, TCMINO, TCMAXN, TCMAXJ, TCCOL  
COMMON/BLAD7/ TPERDAY, SBCUN, TAMB, QUINT  
COMMON/BLAD8/ IJAY, IUPERYR, INUAY, KUATA, QHCONV, ALAT, JLONG,  
1 KINDEX, TOLT, DEC, COSDEC, SINDEC, SINLAT, COSLAT, QSP  
2, HRCKIT, QICUT, KHUT, KCOOL, MOSH1, MOSH2  
COMMON/BLAD9/ TAJ(50), VELU(50), QHD(50), RHO(50), WJS, ISOL(15),  
1 TILT(15), HAZI(15), AG LZ(15), NGLZ(15), NJA, IAMB(10),  
2 ALFA(15), OHANG(15), OSEPR(15), TGLZ(15), JABS(15), ISOLX(24)  
COMMON/BLAD10/ QNMAX, RDIFF(5), EX, RHO, TZERO,  
1 NGUN, I1CON(100), I2CON(100), U(100), ACUN(100), UD(100), UN(100)  
COMMON/BLAD11/ TLLTC, AZING, RHO, COSTC, SINTC, FSSC, FSGC, RESNI,  
1 JCP, KND  
COMMON/TROMBE/VOLF, RCON(50), KVENT, IAIR, JAIR, RLENGTH, RHOSR,  
1 ASPRAT, FCSR, JWA, TROAT, JCN, KWALL  
COMMON/10FLGS/ ISRCPR, I01, I02, IPRINTH, IPRINTD, IPRSM, KHEOPR  
COMMON/TIMES/ TNIGHT, TMOEN, TEVEN, DELT1, DELT, TIME
```

000

```
INTEGER DAY, DAY1, DAY2, YR, DATE, UNITS  
C-----TESTS FOR TEMPERATURE LIMITS ON CONTROL NODE  
C-----KIC -1 FOR T(IC) < TCMIN WITHOUT QCIN; QCIN > 0  
C-----KIC 0 FOR TCMIN < T(IC) < TCMAX WITHOUT QCIN; QCIN = 0  
C-----KIC 1 FOR T(IC) > TCMAX WITHOUT QCIN; QCIN < 0
```

```
IF (KICHNG.EQ.0) REMAIN=1.  
FRAC=REMAIN  
K=KIC+2  
GO TO (100,200,300),K  
100 IF (QCIN.GE.0.) GO TO 800  
IF (KVENT.EQ.4.AND.VOLF.GT.0.) GO TO 800  
FRAC=QCINO/(QCINO-QCIN) & QCIN=0. & KIC=0  
KF(IC)=1 & NF=NF-1 & NV=NV+1 & GO TO 500  
200 IF (T(IC).LT.TCMIN) GO TO 220  
IF (T(IC).GT.TCMAX) GO TO 240  
GO TO 600  
220 FRAC=(TCMIN-T(IC))/(T(IC)-TO(IC)) & T(IC)=TCMIN  
KIC=-1 & GO TO 260  
240 FRAC=(TCMAX-T(IC))/(T(IC)-TO(IC)) & T(IC)=TCMAX & KIC=1  
260 KF(IC)=2 & NF=NF+1 & NV=NV-1 & GO TO 500  
300 IF (QCIN.LE.0.) GO TO 800  
FRAC=QCINO/(QCINO-QCIN) & QCIN=0. & KIC=0  
KF(IC)=1 & NF=NF-1 & NV=NV+1  
500 CONTINUE  
IF (FRAC.LE.0.0.OR.FRAC.GT.1.0) FRAC=.01  
FRAC=FRAC*REMAIN & REMAIN=REMAIN-FRAC  
KICHNG=1 & IF (KDELTA.EQ.0) RETURN  
GO TO 600 IT=1,NT  
I=LT(IT) & IF (I.EQ.IC) GO TO 600  
T(I)=TO(I)+FRAC*(T(I)-TO(I))  
600 CONTINUE  
RETURN  
800 CONTINUE  
KICHNG=0 & RETURN  
END
```

=====
C SUBROUTINE INDATA
=====

C*BASE=100.
C*NOCOL=ECT
C*EACPT
C*INDENT=3.
C*NOLIST
C*STAT=10.
C=====

```
COMMON/BLAD1/ NV, NF, NT, NMAX, KF(50), IC, LV(50), LF(50), LT(50), KICHNG  
1, KIC, ITMAX, NERR, UNITS, KAJACL, KCALC, KDELTA, KCONU  
COMMON/BLAD2/ NTIME, MTIME, ITIME, JATE, JAY, JAY1, JAY2, NDAY(12),
```



```

1 MO,MO1,YR,NMO,NDAY1,INDATE
COMMON/BLAD3/ T(50),TG(50),JPM(50),S(50),SP(50),CONJ(50,50),SCON
1(50),AFACU(50),EXRT(50),FN(50,50,2),FO(50,50,2)
COMMON/BLAD4/ A(50,50),B(50),SUSRC1(50),SUSRC2(50),SCON1(50),
1SQCON2(50),QVHT,QVCL,QVHT,QACL,QHZ,QINC,QFRAN
COMMON/BLAD5/ SUMRT,QCIN,QCINO,FRAC,FRAC,PI,TIMEX,
1DEGRAD,TBASE,UJ,TMAX,TMIN,TBAR,FACI,REMAIN
COMMON/BLAD6/ QSRC(50),QCON(50),QO12(100),SQO121(100),SQO122(100)
1,TCHIN,TCMAX,TCHIN,TCHIN,TCHIN,TCHIN,TCHIN,TCHIN,TCHIN,TCHIN
COMMON/BLAD7/ TPERDAY,SBCON,IA43,QCINT
COMMON/BLAD8/ IDAY,IUPERYR,INDAY,KDATA,QHCONV,ALAT,DLONG,RINDEX,
1TOLT,SEC,COSDEC,SINDEC,SINLAT,COSLAT,QSP,HRCRIT,QICUT,
2KXSHUT,KCOOL,MUSH1,MUSH2
COMMON/BLAD9/ TAC(50),VELD(50),RHO(50),NJS,ISOL(15),TILT
1(15),AZIM(15),AGLZ(15),NGLZ(15),NJA,IA43(10),ALFA(15),OHANG(15),
2USEPR(15),TGLZ(15),DASS(15),ISOLX(24)
COMMON/BLAD10/ QUNMAX,RDIFF(5),EX,KHO,TZER0,NCONN,IICON(100),
1IICON(100),U(100),ACON(100),UU(100),UN(100)
COMMON/BLAD11/ TILTC,AZINC,RHOC,COSTC,SINTC,FSSG,FSGC,RESNI,JCP,
1KND
COMMON/TROMBE/VOLF,RCON(50),KVENT,IAIR,JAIR,RLNGTH,RHOSR,ASPRAT,
1FCSR,JH,TRCOAT,JCH,KWALL
COMMON/IOFLGS/ISRCPR,I01,I02,PRINTH,IPRINT0,IPRINTH,IPRSH,KHEDPR
COMMON/TIMES/TMORN,TEVEN,DELTI,DELTTIME

```

```

DIMENSION EPSG1(10),EPSG0(10)
INTEGER NAMARAY(30)
INTEGER DAY,DAY1,JAY2,YR,CATE,UNITS

```

DATA SECTION

```

DATA (NAMARAY(I),I=1,2) /#CONTROLIMP#, #HOURLYIO#/
DATA (NAMARAY(I),I=3,4) /#STARTDATE#, #LATITUDE#/
DATA (NAMARAY(I),I=5,6) /#LONGITUDE#, #RESNIGHT#/
DATA (NAMARAY(I),I=7,8) /#ULDAU#, #AUXCOOLING#/
DATA (NAMARAY(I),I=9,10) /#EVENTS#, #MONTHS#/
DATA NUMNAMS /10/

```

DEFAULT VALUES OF PROGRAM VARIABLES

```

DATA ALAT/35.1/
DATA INDATE/061378/
DATA IO1,IO2/0,0/
DATA IPRINT0/1/
DATA IPRINTH/0/
DATA IPRINTM/1/
DATA IPRSH/1/
DATA ISRCPR/0/
DATA KXCOOL/0/
DATA KHEDFR/1/
DATA KVENT/0/
DATA KWALL/2/
DATA NDAY1/10/
DATA NMO/1/
DATA RESNI/J./
DATA TCHIN,TCHIN,TCHIN,TCHIN/65.,75.,65.,75./
DATA TEVEN/17./
DATA TMORN/7./
DATA TNIGHT/23./
DATA ULDAU/1./
UNITS=1 & NTIME=24 & IYMAX=5
IUPERYR=365 & KDATA=0 & RINDEX=1.526 & EX=0.5+12.
ALFO=0.3 & FAC=0.5 & FACI=0.5 & TOLT=1.0
TILTC=0. & AZINC=0. & RHOC=0.3
KCALC=1 & KDELTA=1 & KCONU=0
QICUT=-1.E6 & MUSH1=13 & MUSH2=0
RHOCX=RLNGTH=FCSR=0.
DATA (RDIFF(N),N=1,5) / .16, .24, .29, .33, .35/
DATA ISOLX/24+0/
DO 110 I=1,NMAX
DO 110 J=1,NMAX
COND(I,J)=0.

```

110 CONTINUE

READ IN VALUES FROM FILE FOR PROGRAM CONTROL

```

120 REWIND=2
CONTINUE
READ (2,130) NAME
IF (EOF(2).NE.0) GO TO 130
130 FORMAT (A10)
DO 140 LOOP=1,NUMNAMS
IF (NAME(I).EQ.'CONTROL') GO TO 150

```



```

140 CONTINUE
PRINT *,#INPUT COMMAND NOT RECOGNIZED#,NAME
STOP
150 GOTO (150,170,173,173,179,161,162,163,164,165),LOOP
-----
160 READ CONTROL MODE TEMPERATURE LIMITS
READ (2,*) TCHLN,TCHMXN,TCHMND,TCHMXD
GO TO 120
-----
161 READ R VALUE OF INSULATION ON THERMAL WALL
READ (2,*) RESNI
GOTO 120
-----
162 READ VALUE FOR LOAD/AREA
READ (2,*) ULOAD
GOTO 120
-----
163 AUXILIARY COOLING SPECIFIED. SET FLAG TO 1
KAUACL=1
GOTO 120
-----
164 READ VENT CONTROL FLAG
READ (2,*) KVENT
GOTO 120
-----
165 READ NUMBER OF MONTHS FOR SIMULATION
READ (2,*) NMO
NDAY1=300
GOTO 120
-----
170 READ DATES TO START AND STOP HOURLY PRINTOUT
READ (2,*) IO1,IO2
GO TO 120
-----
173 READ STARTING DATE OF SIMULATION
READ (2,*) INDATE
GOTO 120
-----
176 READ LATITUDE OF SIMULATION
READ (2,*) ALAT
GOTO 120
-----
179 READ THE RELATIVE LONGITUDE
READ (2,*) DLONG
GOTO 120
-----
DO REST OF SET-UP FOR THIS ROUTINE
180 CONTINUE
-----
190 GO TO (190,200), UNITS
CONTINUE
C-----UNITS 1% BTU,HR,FT,DEG-F
SBCON=1.7132E-9 & TPERDAY=24. & TBASE=65. & QHCONV=.3172
TZERO=450. & QDNMAX=317.2
GOTO 210
200 CONTINUE
C-----UNITS 2% S.I. UNITS (J,S,M,DEG-C)
SBCON=5.670E-8 & TPERDAY=66+00. & TBASE=13. & QHCONV=1.
TZERO=273. & QDNMAX=1000.
210 CONTINUE
-----
-- START SPECIFIC MODEL -- SOUTH MASS WALL
-----
-- TROMBE WALL (K WALL 2) OR WATER WALL (K WALL 1) - PER UNIT AREA OF GL
-- NSGW NON-ZERO FOR MASSIVE EXTERIOR WALLS
-- SET MODEL PARAMETERS
NGL-- NUMBER OF PRIMARY SOLAR SOURCE (MASS WALL) GLAZINGS
HGT-- SMW HEIGHT FOR THERMO-CIRCULATION CALC. (FT)
ULOAD-- STATIC ROOM HEATING LOAD COEFFICIENT PER UNIT SMW GLAZING
AREA (BTU/HR/DEG.F/SQ.FT). THIS DOES NOT INCLUDE HEAT LOSS THRU
SMW OR MASSIVE WALLS.
RESNI-- RESISTANCE OF SMW NIGHT INSULATION (DEG.F/(BTU/HR/SQ.FT))
KVENT-- THERMO-CIRCULATION VENT CONTROL FLAG (SEE PROP)
USTRM-- SMW TO ROOM U (BTU/HR/DEG.F/SQ.FT)
CAIR-- AIR VOLUMETRIC HEAT CAPACITY (BTU/DEG.F/CU.FT)
GRAV-- ACCELERATION DUE TO GRAVITY (FT/S/S)
THCAIR-- AIR THERMAL CONDUCTIVITY (BTU/HR/DEG.F/FT)
TILIG-- TILT OF SMW GLAZING OR OF SMW IF BARE (DEG.)
AZW-- WALL AZIMUTH (DEG.)
ALF-- WALL ABSORBTIVITY
TGL-- GLAZING THICKNESS PER LAYER (FT)
THGL-- GLAZING THERMAL CONDUCTIVITY (BTU/HR/SQ.FT/FT)

```



```

AIRGAP-- SPACING BETWEEN GLAZINGS (FT)
EPSH,EPSA,EPSG-- I.F. EMISSIVITY OF WALL, SKY, AND GLAZING
TRCOAT-- TRANSMISSIVITY OF COATING ON INNER SURFACE OF INNER GLAZ
FOR HORIZONTAL SPECTRAL REFLECTOR, VERTICAL WALL (SEE SUNSRC)
RLNGTH-- REFL. LENGTH/ GLAZ. HEIGHT
RHOSR-- REFLECTIVITY
ASPRAT-- LENGTH/WIDTH
FCOR-- WALL/REFLECTOR VIEW FACTOR
COIS-- VENT DISCHARGE COEFF.
AVOAG-- AREA OF ONE ROW (TOP OR BOTTOM) OF VENTS PER UNIT SMW
GLAZING AREA
ASSOAG-- WALL/GLAZING AIR SPACE FLOW AREA PER UNIT SHW GL. AREA

```

```

NGL=2 $ HGT=8.
NSGW=0
USTRM=1.5 $ CAIR=0.018 $ GRAV=32.2 $ THCAIR=0.015
TLT=90. $ AZW=0. $ ALF=1.00 $ TGL=0.125/12.
THCG=0.5
AIRGAP=0.25/12. $ IF(INGL.EQ.1)AIRGAP=0.
EPSH=0.9 $ EPSG=0.9 $ EPSA=0.9 $ TRCOAT=1.0
RLNGTH=1.0 $ RHOSR=0.3 $ ASPRAT=5.0
FCOR=0.5*(RLNGTH+1.-SQRT(RLNGTH**2+1.))
COIS=0.6 $ AVOAG=0.03 $ ASSOAG=0.02
DO 220 IG=1,NGL

```

```

EPSSG(IG)=EPSSG(IG)=EPSG

```

```

IF (KDATA.EQ.0) GO TO 230
-- FOR CLEAR-DAY WEATHER DATA CALCULATIONS (SEE DAYLY)
DLONG=0.

```

```

230 CONTINUE

```

```

KJELT=1 $ KCONU=0 $ KCALC=1
IF (KCA=C.EQ.2) KCONU=1
-- CALCULATE THERMAL NETWORK PARAMETERS
GO TO (240,250), Kwall

```

```

240 CONTINUE

```

```

-- WATER WALL
-- ASSUMED TO BE SAME AREA AS GLAZING
-- SINGLE NODE (NODE 1) FOR SMW -- GLAZINGS START AT NODE 5
-- NODE 2 IS ROOM AIR -- NODE 3 IS OUTSIDE AMBIENT
-- NODE 4 IS WALL/GLAZING AIR SPACE
CPMR-- SMW HEAT CAPACITANCE (BTU/DEG.F PER UNIT SMW GLAZ. AREA)
IAIR-- WALL/GLAZ. AIR SPACE NODE
JAIR-- THERMOCIRCULATION CONNECTION (IAIR TO IC)
IC-- ROOM AIR NODE (CONTROL NODE)
JCP-- CONNECTION OF ULOAD
JWA-- CONNECTION BETWEEN SMW SURFACE NODE AND IAIR - STARTS
SEQUENCE OF CONNECTIONS THRU GLAZINGS.
NSEG-- NUMBER OF SERIES WALL SEGMENTS (SEE MASONRY WALL)

```

```

CPMR=45 $ CPM(1)=CPMR
NCONN=NGL+0 $ IF(INGL.LE.0)NCONN=3 $ JO=NCONN
NNODE=NGL+4 $ IF(INGL.LE.0)NNODE=3 $ IO=NNODE
IAIR=JAIR+4 $ IC=2 $ JCP=3 $ JWA=5 $ NSEG=1
GO TO 250

```

```

250 CONTINUE

```

```

-- MASONRY WALL
-- ASSUMED TO BE SAME AREA AS GLAZING
-- NSEG+2 WALL NODES IN SERIES STARTING AT NODE 1. NODES 1 AND
NSEG+2 ARE MASSLESS SURFACE NODES. NSEG+3 IS ROOM AIR (CONTROL)
NSEG+4 IS OUTSIDE AMBIENT, NSEG+5 IS WALL/GLAZ. AIR SPACE.
GLAZINGS START AT NSEG+6
THCON-- MASONRY THERMAL CONDUCTIVITY (BTU/HR/DEG.F/FT)
THICK-- WALL THICKNESS (FT)
VOLSP-- MASONRY VOLUMETRIC HEAT CAPACITY (BTU/DEG.F/CU.FT)

```

```

THCON=1.0 $ THICK=18./12. $ VOLSP=38. $ NSEG=4
CON1=NSEG+(THCON/THICK) $ CON2=2.+CON1
CPMR=VOLSP*THICK $ CPMRI=CPMR/NSEG

```

```

NCONN=NSEG+NGL+7 $ IF(INGL.LE.0)NCONN=NSEG+4 $ JO=NCONN
NNODE=NSEG+NGL+5 $ IF(INGL.LE.0)NNODE=NSEG+4 $ IO=NNODE
IAIR=NSEG+5 $ JAIR=NSEG+5 $ IC=NSEG+3 $ JCP=NSEG+4

```

```

260 CONTINUE

```

```

-- FOR BOTH TYPES OF WALL
JWA=NSEG+6 $ JCW=0
NJA=1 $ IAMB(1)=JCP
NJS=1 $ ISOL(1)=1

```

```

-- CONNECTION PARAMETERS

```

```

I1CON(1)=1 $ I2CON(1)=IAIR+1 $ ACON(1)=1.0
IF (INGL.LE.0) I2CON(1)=IAMB(1)
J2=NSEG+2
DO 270 J=2,JCP

```



```

CONV=CUN1 $ IF(J.EQ.2.OR.J.EQ.J2) CON1=CON2
UN(J)=UD(J)=CON1
270 CONTINUE
UN(JCP-1)=UD(JCP-1)=JSTRM
UN(JCP)=UD(JCP)=ULOAD
IF (NGL.LE.J) GO TO 299
I1CON(JAIR)=IAIR $ I2CON(JAIR)=IC $ ACON(JAIR)=1.0
I1CON(JAIR+1)=1 $ I2CON(JAIR+1)=IAIR $ ACON(JAIR+1)=1.0
I1CON(JAIR+2)=IAIR $ I2CON(JAIR+2)=IAIR+1 $ ACON(JAIR+2)=1.0
J1=NSEG+6 $ J2=J1+NGL-1
DO 280 J=J1,J2
  I1CON(J)=J-2 $ I2CON(J)=J-1 $ ACON(J)=1.0
280 CONTINUE
I2CON(J2)=IAMB(1)
290 CONTINUE

-- NODE PARAMETERS
DO 300 I=1,NNODE
  T(I)=70. $ KF(I)=1
300 CONTINUE
I=IAMB(1) $ KF(I)=2
IF (KHALL.EQ.1) GO TO 320
I2=NSEG+1
DO 310 I=2,I2
310 CPM(I)=CPMRI
320 CONTINUE

-- CALCULATE CONSTANTS FOR TEMPERATURE DEPENDENT U'S IN PROP
RCON(1)=COIS*AVOAG*SQRT(GRAV*HGT)*3600.
RCON(2)=2.*CAIR $ RCON(3)=1./(3600.*ASOAG)
RCON(4)=1./(AIRGAP/THCAIR+TGL/THGGL)
-- CONSTANTS FOR RADIATION U'S
RCON(10)=SBCON/(1./EPSW+1./EPSA-1.) $ IF(NGL.LE.0) GO TO 370
RCON(10)=SBCON/(1./EPSW+1./EPSGI(1)-1.)
IF (NGL.EQ.1) GO TO 340
NG=NGL-1
DO 330 IG=1,NG
330 RCON(IG+10)=SBCON/(1./EPSGO(IG)+1./EPSGI(IG+1)-1.)
340 RCON(NG+10)=SBCON/(1./EPSGO(NGL)+1./EPSA-1.)

-- SOLAR SOURCE INFORMATION
TILT(1)=TILTG $ WAZIM(1)=AZW $ ALFA(1)=ALF
AZLZ(1)=1.0 $ NGLZ(1)=NGLZ $ TGLZ(1)=TGL
JABS(1)=1.-EXP(-1.215*EX*TG_Z(1))
DHARG(1)=OSEPR(1)=0.

IF (NSGW.LE.0) GO TO 370
-- OPTIONAL EXTRA FOR MASSIVE EXTERIOR WALLS
NSGW-- NUMBER OF WALL SEGMENTS
HAIR-- OUTSIDE AIR FILM COEFF.
URMW-- ROOM TO WALL U (INCLUDES ANY INTERIOR INSULATION)
RWINS-- RESISTANCE OF ANY EXTERIOR WALL INSULATION
THCW-- THERMAL CONDUCTIVITY OF WALL MATERIAL
THKW-- WALL THICKNESS
VSPW-- WALL MAT. VOLUMETRIC HEAT CAPACITY
AW-- WALL AREA/ SMV GLAZING AREA
JCW-- WALL TO OUTSIDE CONNECTION. HEAT FLOW THRU JCW IS ADDED
TO THAT THRU JCP TO GET TOTAL QLOAD.

NCON=JO+NSGW+3 $ NNODE=IO+NSGW+2
HAIR=1.0
URMW=1.5 $ RWINS=0. $ JWOUT=1./(RWINS+1./HAIR)
THCW=0.8 $ THKW=1.0 $ VSPW=30. $ AW=2.47
CPMW=AW*THKW*VSPW $ CPMWI=CPMH/NSGW
CC1=NSGW*THCW/THKW $ CC2=2.*CC1

J=J0+1 $ I1CON(J)=IC $ I2CON(J)=IO+1 $ ACON(J)=AW
UJ(J)=UN(J)=URMW
JJ2=NSGW+1
DO 350 JJ=1,JJ2
  J=J0+JJ+1 $ I=IO+JJ
  I1CON(J)=1 $ I2CON(J)=I+1 $ ACON(J)=AW
  CC1=CC1 $ IF(JJ.EQ.1.OR.JJ.EQ.JJ2) CC1=CC2
  UD(J)=UN(J)=CC1
350 CONTINUE
J=J0+NSGW+3 $ I=IO+NSGW+2
I1CON(J)=I $ I2CON(J)=IAMB(1) $ ACON(J)=AW
UN(J)=UD(J)=UWOUT $ JCW=J

I1=IO+1 $ I2=IO+NSGW+2
DO 360 I=1,I2

```

T(1)=70.5 KF(I)=1
IF (I.EQ.11.OR.I.EQ.12) GO TO 360
CPM(I)=CPHWI

360 CONTINUE
-- END EXTERIOR WALL CALC.
370 CONTINUE

IF (K WALL.EQ.0) GO TO +10
IF (K CONU.NE.1) GO TO +10
FOR CONSTANT COEFFICIENTS UN, UD
TREF=70.5 TFUNC=RAUFN(TREF,TREF,TZERO)
JAIR=1.5 UCIRC=0.5 HAIR=+.0
IF (NGL.GT.0) GO TO 390
UN(1)=UD(1)=HAIR+RCON(10)*TFUNC
IF (RESNI.GT.0.01) UN(1)=1./(1./UN(1)+RESNI)
GO TO 410

390 CONTINUE
UN(JAIR)=UD(JAIR)=UCIRC
UN(JWA)=UD(JWA)=UN(JWA+1)=UD(JWA+1)=UAIR
UN(1)=UD(1)=RCON(10)*TFUNC
J1=JWA+2 5 J2=JWA+NGL 5 KX=10
IF (NGL.EQ.1) GO TO 400
DO 390 J=J1,J2

-- ASSUME SPACE BETWEEN GLAZINGS TOO SMALL FOR CONVECTION
KX=KX+1 5 I1=I1CON(J) 5 I2=I2CON(J)
UN(J)=UD(J)=RCON(KX)*TFUNC+RCON(4)

390 CONTINUE
400 CONTINUE
KX=10+NGL 5 J=J2+1 5 I1=I1CON(J) 5 I2=I2CON(J)
UN(J)=UD(J)=RCON(KX)*TFUNC+HAIR
IF (RESNI.GT.0.01) UN(J1)=1./RESNI
410 CONTINUE

-- OPAQUE INSULATION ON OUTSIDE OF SOUTH MASS WALL (RSMWI)
IF (RSMWI.LE.0.01) GO TO 420
NCONN=NCONN+1 5 NNODE=NNODE+1
I1CON(JWA)=I1CON(1)=NNODE
J=NCONN 5 I1CON(J)=1 5 I2CON(J)=NNODE 5 ACON(J)=1.0
UN(J)=UD(J)=1./RSMWI
KF(NNODE)=1 5 T(NNODE)=70.
ISOL(1)=NNODE
420 CONTINUE

-- END PROBLEM DATA

-- PRINT DATA

IF (K WALL.EQ.1.OR.K WALL.EQ.0) PRINT 440, INDATE,ULOAD
IF (K WALL.EQ.2) PRINT 450, INDATE,ULOAD
PRINT *,IC,CPM(IC)
IF (KHEDPR.EQ.J) GO TO 430
PRINT 460, (J,I1CON(J),I2CON(J),UD(J),UH(J),ACON(J),J=1,NCONN)
PRINT 470, (IAMB(J),J=1,NJA)
PRINT 480, (J,ISOL(J),NGLZ(J),TILT(J),WAZIM(J),ALFA(J),AGLZ(J),
1)HANG(J),USEPR(J),TGLZ(J),DABS(J),J=1,NJS)
PRINT 490, HMAX,IC,HTIME,NSEG,NMO,NDAY1,ITMAX,UNITS,KDATA,KWALL,
1)KCALC,KDELTA,KCONU,NSGW,KAUXCL,KVENT,JCP,JCH,JWA,JAIR,
2)JAIR
PRINT 500, QHCONV,ALAT,OLONG,RINDEX,TMORN,TEVEN,TZERO,QDNMAX,RHO,
1)EX,FAC,TOLT,TCMINN,TCMIND,TILT,ALZIMO,RHOB,FAC1,TCMAXD,THCON,THICK
2)JLSP,JLOAD,RESNI,RLNGTH,RHOB,ASPRAT,FCOSK,CPMR,RSMWI
IF (NSGW.LE.0) GO TO 430
PRINT 510, RWINS,UWOUT,THGW,THKW,VSPW,AW
430 CONTINUE

440 FORMAT (/41HWATER WALL - PER UNIT WALL AREA - INDATE=16,5X,
16)ULOAD=F6.3)

450 FORMAT (/42HTROMBE WALL - PER UNIT WALL AREA - INDATE=16,5X,
16)ULOAD=F6.3)

460 FORMAT (/24H CONDUCTANCE CONNECTIONS/4X,1HU,3X,2HI1,3X,2HI2,5X,
12)HUC,10X,2HUN,10X,+HACON/(3I5,3E12.4))

470 FORMAT (/26H AMBIENT TEMPERATURE NODES/4X,2HI=(,14I5)

480 FORMAT (/19H SOLAR HEAT SOURCES/4X,7HU ISOL,1X,+HGLZ,2X,4HTILT,2X
1,+HWAZIM,3X,+HALFA,3X,+HAGLZ,2X,+HHANG,2X,+HUSEPR,3X,+HTGLZ,3X,
2,+HDABS/(3I5,2F7.2,F7.4,F7.2,4F7.4))

490 FORMAT (/4X,+HMAX,6X,2HIC,3X,5HTIME,4X,+HNSEG,5X,3HMO,3X,
1,+HNDAY1,3X,5HTMAX,3X,5HUNITS,3X,5HKDATA

+ /9I5
+ /3X,+HKWALL,3X,5HKCALC,3X,5HKDELTA,3X,5HKCONU,4X,4HNSGW,2X,
+ 6HKHAUXCL,3X,5HKVENT

+ /7I5

+ /5X,3HJCP,5X,3HJCH,5X,3HJWA,4X,4HJAIR,4X,4HJAIR

+ /5I5)

```

17A, 5HTEVEN/6E12.4/5X, 5HTZERO, 7A, 5HUNHAA, 5A, 3HRCO, 9A, 2HEA, 10A,
23HFAC, 9A, 4HTOLT/6E12.4/5X, 5HTC1, 11A, 6A, 5HTC1IND, 5A, 5HTILT, 7A,
35HAZINC, 7A, 4HRCO, 3A, 4HFACT/6E12.4/5X, 5HTC1IND, 5A, 5HTCOH, 7A,
45HTHICK, 7A, 5HVOL, 5P, 7X, 5HJL, 5A, 7A, 5HRES, 11/6E12.4/5X, 5HRLNGTH, 6A,
55HRHCSR, 7A, 5HASP, 3A, 4HFC, 5A, 4HCP, 3A, 5HRS, 4H/6E12.4)
510 FORMAT (/5A, 5HRVINS, 7X, 5HUNHOUT, 7A, 4HTHCH, 3A, 4HFKH, 3X, 4HVSPW, 3X,
12HAN/6E12.4)

```

```

RETURN
END

```

```

=====
SUBROUTINE FRIM
=====
COMMON/BLAD1/NV, NF, NT, NMAX, XPT(50), IC, IV(50), LEFT(50), IT(50),
1 KICNG, KIC, ITMAX, NERR, UNITS, KAJAC, KALC, KDEL, KCONU
COMMON/BLAD2/NTIME, MTIME, TIME, DATE, DAY, DAY1, DAY2, NDAY(12),
1 MO, MO1, YR, INCO, INDAY1, INDATE
COMMON/BLAD3/T(50), TO(50), JPH(50), S(50), SP(50), COND(50,50),
1 SCUN(50), QFAC(50), ERR(50), FN(50,50,2), FC(50,50,2)
COMMON/BLAD4/A(50,50), B(50), SUSC(150), SQSRC(50), SQCON(50),
1 SQCON2(50), QVHT, QVCL, QAHT, QACL, QHZ, QINC, QTRAN
COMMON/BLAD5/SUMKT, QCIN, QCING, FAC, FRAC,
1 PI, TIMEA, DEGRA, TBASE, DO, TMAX, TMIN, TBAR, FACI, REMAIN
COMMON/BLAD6/QRAC(50), ICON(50), IC12(100), SQC121(100),
1 SQC122(100), TCMIN, TCMAX, TCMINN, TCMINU, TCMAXN, TCOOL
COMMON/BLAD7/TPERDAY, SBCON, TAMB, QCINT
COMMON/BLAD8/IDAY, IDPERYR, INDAY, KDATA, QCONV, ALAT, DLNG,
1 RINDEX, TOLT, JEC, COSDEC, SINDEC, SINLAT, COSLAT, JSP
2 , HRCRIT, QICUT, KSHUT, KCOOL, MOSH1, MOSH2
COMMON/BLAD9/TAU(50), VELU(50), QHD(50), RHU(50), NJS, ISOL(15),
1 TILT(15), WAZIM(15), AGLZ(15), NGLZ(15), NJA, IAMB(10),
2 ALFA(15), OHANG(15), OSEPR(15), TGLZ(15), JABS(15), ISOLX(24)
COMMON/BLAD10/QUNMAX, MOIFF(5), EX, RHU, TZERO,
1 NCON, I1CON(100), I2CON(100), U(100), ACON(100), UO(100), UN(100)
COMMON/BLAD11/TILTC, AZINC, RHUG, COSTC, SINTC, FSSC, FSGC, RESNI,
1 JCP, KND
COMMON/TROMBE/VOLF, RCON(50), KVENT, IAIR, JAIR, RLENGTH, RHOSR,
1 ASPRAT, FCSR, JWA, TRCOAT, JCW, KWALL
COMMON/LOFLGS/ISRCPR, IO1, IO2, IPRINTH, IPRINTM, IPRSM, KHEDPR
COMMON/TIMEQ/WKAREA(100), INKAREA(100)
COMMON/TIMES/TNIGHT, TMORN, TEVEN, DELT1, DELT, TIME
DIMENSION NVO(2)

```

```

INTEGER DAY, DAY1, DAY2, YR, DATE, UNITS

```

```

TCMIN=TCMINN & TCMAX=TCMAXN
MO1=INDATE/10000 & INDAY=INDATE/100-MO1*100
IF(IDPERYR.EQ.366) NDAY(2)=29
JELT1=TPERDAY/FLOAT(NTIME)
IF(FAC.EQ.0) IFMAX=1

```

```

DO 100 J=1, NCON
I1=I1CON(J) & I2=I2CON(J)
CONC(I1, I2)=CONC(I2, I1)=JN(J)*ACON(J)
100 CONTINUE
DO 200 I=1, NMAX
SCON(I)=0.
DO 200 J=1, NMAX
SCON(I)=SCON(I)+CONC(I, J)
200

```

```

IDAY=INDAY-1
IF(MO1.LE.1) GO TO 500 & M2=MO1-1
DO 400 M=1, 12
450 IDAY=IDAY+NDAY(M)
500 CONTINUE

```

```

SINLAT=SIN(DEGRAD*ALAT) & COSLAT=COS(DEGRAD*ALAT)

```

```

IF(TILTC.LE.0.) GO TO 500
COSTC=COS(TILTC*DEGRAD) & SINTC=SIN(DEGRAD*TILTC)
FSSC=.5*(1.+COSTC) & FSGC=.5*(1.-COSTC)
500 CONTINUE

```

```

-- IF TEMP LIMITS ARE WITHIN 0.1 DEG., T(IC) IS FIXED AT TCMIN
-- FOR ALL TIME AND KIC IS SET TO 2 AS A FLAG
BANU=ABS(TCMAX-TCMIN) & BANON=ABS(TCMAXN-TCMINN)
IF(BANU.GT.0.1.OR.BANON.GT.0.1) GO TO 605
KIC=2 & KF(IC)=2 & T(IC)=TCMIN
605 CONTINUE

```

```

---COLLECT AND IDENTIFY NODES
NV=NF=NI=0
DO 640 I=1, NMAX

```



```

K=KF(I) & IF(K.NE.1.AND.K.NE.2) GO TO 640
IF(1.EQ.IC) GO TO 640
GO TO (610,620),K
C-----VARIABLE TEMP NODES
610 NV=NV+1 & LV(NV)=I & GO TO 630
C-----FIXED TEMP NODES
620 NF=NF+1 & LF(NF)=I
630 NT=NT+1 & LT(NT)=I
640 CONTINUE
C-----CONTROL NODE PUT AT END
LF(NF+1)=LV(NV+1)=LT(NT+1)=IC & NT=NT+1
IF(KF(IC).EQ.1) NV=NV+1 & IF(KF(IC).EQ.2) NF=NF+1

-- KCALC IS 2 FOR SIMPLE CALCULATION IN WHICH ALL COND(I,J), CPM(I),
-- SP(I), AND DELT ARE CONSTANT FOR ALL TIME RESULTING IN CONSTANT
-- A(I,J) ARRAYS FOR NIGHT AND DAY FOR CONTROL TEMP FIXED AND
-- CONTROL TEMP VARIABLE (FOUR SETS OF COEFFICIENTS) --
-- CALCULATE CONSTANT COEFFICIENTS F(I,J) (FN(I,J,K) OR FD(I,J,K))
-- IN - I(I)=SUM(F(I,J)*B(J)); I=1,NV
-- KDELT IS ZERO FOR NO PARTITIONING OF TIME INCREMENT WHEN OPERATING
-- MODE OF CONTROL NODE CHANGES - KDELT MUST BE ZERO FOR KCALC OF 2.
-- KCONU IS ONE FOR UN AND UU CONSTANT FOR ALL CONNECTIONS
-- KCONU MUST BE 1 FOR KCALC OF 2

IF(KCALC.NE.2) GO TO 1000
KDELT=0 & KCONU=1
DO 900 KND=1,2
DO 700 J=1,NCON
I1=I1CON(J) & I2=I2CON(J)
GO TO (650,655),KND
650 U(J)=UN(J) & GO TO 660
655 U(J)=UD(J)
660 CONJ(I1,I2)=COND(I2,I1)=J(J)*ACON(J)
700 CONTINUE
DO 720 IT=1,NT
I1=LT(IT) & SCON(I1)=0.
DO 720 JT=1,NT
I2=LT(JT) & SCON(I1)=SCON(I1)+COND(I1,I2)
720 CONTINUE
IF(KF(IC).EQ.1) NVO(1)=NV & IF(KF(IC).EQ.2) NVO(1)=NV+1
NVO(2)=NVO(1)-1
DO 900 IX=1,2
NVOA=NVO(IX)
DO 800 IV=1,NVOA
B(IV)=0.
I=LV(IV) & FAK=FAC & IF(CPM(I).LE.0.) FAK=1.
DO 750 JV=1,NVOA
J=LV(JV) & A(IV,JV)=-FAK*COND(I,J)
IF(1.EQ.J) A(IV,JV)=CPM(I)/DELT1+FAK*(SCON(I)-SP(I))
750 CONTINUE
B(K)=1.
CALL LEQT1F(A,1,NVOA,NMAX,3,0,HKAREA,IER)
DO 800 J=1,NVOA
GO TO(772,774),KND
772 FN(J,K,IX)=B(J) & GO TO 800
774 FD(J,K,IX)=B(J)
800 CONTINUE

IF(NHEDPR.EQ.0) GO TO 900
PRINT 3711,KND,IX,NVOA
DO 3701 I=1,NVOA
GO TO(3691,3692),KND
3691 PRINT 3703,(FN(I,J,IX),J=1,NVOA) & GO TO 3701
3692 PRINT 3703,(FD(I,J,IX),J=1,NVOA)
3701 CONTINUE
3703 FORMAT(10E12.4)
3711 FORMAT(* KND=*15,5X*IX=*15,5X*NVOA=*15//* I F(I,J),J=1,NV*)
3714 FORMAT(I3,10E12.4)

900 CONTINUE
1000 CONTINUE
RETURN
END

=====
SUBROUTINE PROP
=====
COMMON/3LAD1/NV,NF,NT,NMAX,KF(50),IC,LV(50),CF(50),LT(50),
1 KICHO,KIC,ITMAX,NERA,UNITS,KAJAC,KCALC,KDELT,KCONU
COMMON/3LAD2/NTIME,NTIME,LTIME,DATE,DAY,DAY1,DAY2,NDAY(12),
1 NO,MO1,YR,NMO,NJAY1,INDATE
COMMON/3LAD3/T(50),TO(50),CPM(50),S(50),SP(50),COND(50,50),
1 SCON(50),UFACO(50),ERRT(50),FN(50,50,2),FD(50,50,2)
=====

```



```
UN(J)=UJ(J)=KCON(KX)*RADFN(T(I1),T(I2),TZERO)+HAIR
IF(KSHUT.NE.1)GO TO 75
UJ(J1)=UN(J1)=1./RESNI
75 CONTINUE
```

```
-- CALCULATE U(J),CONO(I1,I2),SCON(I)
-- THIS PART SHOULD BE KEPT FOR ANY MODELS
I=IAMB(1) & T(I)=TAMB
DO 100 J=1,NCON
I1=I1CON(J) & I2=I2CON(J)
GO TO (91,93),KND
91 U(J)=UN(J) & GO TO 95
93 U(J)=UG(J)
95 CONO(I1,I2)=CONO(I2,I1)=U(J)*ACON(J)
100 CONTINUE
```

```
IF(KICNG.NE.2) GO TO 200
DO 120 J=1,NJA
I=IAMS(J) & IF(KF(I).EQ.2) T(I)=TAMB
120 CONTINUE
200 CONTINUE
```

```
DO 600 IT=1,NT
I1=LT(IT) & SCON(I1)=0.
DO 600 JT=1,NT
I2=LT(JT) & SCON(I1)=SCON(I1)+CONO(I1,I2)
800 CONTINUE
RETURN
END
```

```
=====
FUNCTION RADFN(T1,T2,T0)
=====
TT1=T1+T0 & TT2=T2+T0
RADFN=(TT1**2+TT2**2)*(TT1+TT2)
RETURN
END
```

```
=====
SUBROUTINE JAYLY
=====
COMMON/BLAD1/NV,NF,NT,YMAX,KF(50),IC,LV(50),LF(50),LT(50),
1 KICNG,KIC,ITMAX,NERR,UNITS,KAUACL,KCALC,KDELT,KCONU
COMMON/BLAD2/NTIME,MTIME,ITIME,DATE,DAY,JAY1,JAY2,NDAY(12),
1 MO,MC1,YR,NMC,NDAY1,INDATE
COMMON/BLAD3/T(50),TO(50),CPH(50),S(50),SP(50),CONO(50,50),
1 SCON(50),QFAC(50),ERRT(50),FN(50,50,2),FD(50,50,2)
COMMON/BLAD4/VA(50,50),B(50),SQSRC1(50),SQSRC2(50),SQCON1(50),
1 SQCON2(50),QVHI,QVCL,QAHT,QACL,QHZ,QINC,QTRAN
COMMON/BLAD5/SUMKT,OCIN,OCINO,FAC,FRAC,
1 PI,TIMEA,DEGRAD,TBASE,UJ,TMAX,TMIN,TBAR,FACI,REMAIN
COMMON/BLAD6/CSRC(50),QCON(50),QC12(100),SQC121(100),
1 SQC122(100),TCHIN,TCHAX,TCHINN,TCHIND,TCHAXN,TCHAXD,TCHOLD
COMMON/BLAD7/TPEROJAY,SBCON,TAMB,QCINT
COMMON/BLAD8/IJAY,IPPERYR,INDAY,KDATA,QHCUNV,ALAT,DEONG,
1 RINDEX,TOLT,DEC,COSDEC,SINDEC,SINLAT,COSLAT,QSP
2 ,HRCRIT,HCICU,KSHUT,KCOOL,MOSH1,MOSH2
COMMON/BLAD9/TAD(50),VELU(50),QHU(50),RHO(50),HJS,ISCL(15),
1 TILT(15),HAZIM(15),AGLZ(15),HGLZ(15),NJA,IAMB(10),
2 ALFA(15),OMANG(15),OSEPR(15),TGLZ(15),JABS(15),ISOLA(24)
COMMON/BLAD10/QONMAX,RDIFF(5),EX,KHU,TZERO,
1 KCON, I1CON(100), I2CON(100), U(100), ACON(100), UO(100), UN(100)
COMMON/BLAD11/TILTC,AZIMC,RHOC,COSTC,SINTC,FSSC,FSGC,RESNI,
1 JCP,KND
COMMON/TROMBE/VOLF,RCON(50),KVENT,IAIR,JAIR,RLNGTH,RHOSR,
1 ASPRAT,FUSK,UWA,TRCOAT,JCH,KHALL
COMMON/IOFLGS/ISRCPR,I01,I02,IPRINTH,IPRINTM,IPRSH,KHEUPR
COMMON/TIMES/TMORN,TEVEN,DELT1,DELT,TIME
DIMENSION QMDA(24)
```

```
INTEGER DAY,DAY1,DAY2,YR,DATE,UNITS
IF (KDATA.NE.0) GOTO 1000
READ DATA FOR EACH OF 24 HOURS FROM TAPE1
TAD IS AMBIENT TEMPERATURE (DEG.C)
VELU IS WIND VELOCITY (M/S)
QHU IS SOLAR RADIATION INTENSITY--(W/SQ.M)
IF (MTIME.GT.0) GOTO 100
TAKE CARE OF FIRING VALUES FOR FIRST TIME THROUGH
IYRT=MOJ(INDATE,100)
INDAT=IYRT*10000+40*100+INDAY
READ(1,3050) YR,KMO,KDAY,KHOUR,QHO(1),VELU(1),TAD(1)
ITEMP=YR*10000+KMO*100+KDAY
```



```

IF (ITEMP-INDATE) 50,110,60
PRINT *,*STARTING DATE TOO EARLY FOR FILEA,INDATE
STOP
READ DATA. DATE MUST MATCH, OR ERROR
READ (1,3050) YR,KMO,KDAY,KHOUR,QHD(1),VELD(1),TAD(1)
IF ((KMO.EQ.MO).AND.(KDAY.EQ.DAY).AND.(KHOUR.EQ.0)) GOTO 110
PRINT *,*DAY MISMATCH IN WEATHER FILEA,YR,KMO,KDAY,KHOUR
STOP
READ IN 25 VALUES FOR THIS DAY
DO 130 L=2,24
READ (1,3050) YR,KMO,KDAY,KHOUR,QHD(L),VELD(L),TAD(L)
DATE=KMO*10000+KDAY*100+YR

DO CONVERSION OF WEATHER DATA IF USING ASHRAE UNITS
IF (UNITS .EQ.2) GOTO 220
DO 150 IH=1,24
CONVERT TEMPERATURE TO DEG-F
TAD(IH)=TAD(IH)*1.8+32.
CONTINUE
CONTINUE

COMPUTE MAX,MIN,AVG TEMPERATURE AND DEGREE DAYS
TMAX=-1.E6 & TMIN=1.E6 & TBAR=0.
DO 240 IH=1,24
IF (TAD(IH).GT.TMAX) TMAX=TAD(IH)
IF (TAD(IH).LT.TMIN) TMIN=TAD(IH)
TBAR=TBAR+TAD(IH)
CONTINUE
DUEG=TBAR-.5*(TMAX+TMIN) & DD=DD+AMAX1(DUEG,0.)
TBAR=TBAR/24.

COMPUTE DECLINATION (DEC FORMULA FROM D. AND B.)
DEC=23.45*SIN(DEGRAD*360./365.+(FLOAT(IDAY)+234.))
SINDEC=SIN(DEGRAD*DEC) & COSDEC=COS(DEGRAD*DEC)
HRCR=90. & IF(DEC.LE.0.) GO TO 280
HRCR=-90.
CHRCR=TAN(DEGRAD*DEC)/TAN(DEGRAD*ALAT) & IF(CHRCR.GT.1.) GO TO 280
HRCR=1/COS(CHRCR)/DEGRAD

CONTINUE
-- SOLAR CONSTANT
GO TO (310,320),UNITS
310 QSP=428.96-13.50*SIN(DEGRAD*360.+(272.1+FLOAT(IDAY))/365.)
GO TO 330
320 QSP=1346.1-42.56*SIN(DEGRAD*360.+(272.1+FLOAT(IDAY))/365.)
330 CONTINUE
RETURN

DUMMY DATA FOR CONSTANT SUMMY-DAY CASE
1000 CONTINUE
DATA TAMAX,TAMIN,HRTMAX,HRTMIN/70.,50.,13.,7./
SLP1=(TAMAX-TAMIN)/(HRTMAX-HRTMIN)
SLP2=(TAMIN-TAMAX)/(HRTMIN+24.-HRTMAX)
DUMMY SOLAR DATA FOR SUNNY DAY CALCULATIONS.-W/SQ-M
DATA QHDX/5*0.,3.152,157.1,+63.1,753.1,1005.5,
+ 1242.2,1319.6,1397.6,1319.6,1202.2,1005.5,753.1,463.1,
+ 167.1,3.152,4*0./
IF (HTIME.EQ.0) DATE=INDATE & IF(MTIME.GT.0) DATE=DATE+100
DO 1020 L=1,24
HX=L-1
TAMB=TAMIN+SLP1*(HR-HRTMIN)
IF(HR.LT.HRTMIN) TAMB=TAMAX+SLP2*(HR+24.-HRTMAX)
IF(HR.GT.HRTMAX) TAMB=TAMAX+SLP2*(HR-HRTMAX)
TAD(L)=TAMB & VELD(L)=2.2352 & QHD(L)=QHDX(L)
1020 CONTINUE

GO TO 220

3050 FORMAT(7X,I2,1X,I2,1X,I2,1X,I2,1X,I2,1X,F4.0,4X,F2.0,1X,F5.1)
=====
SUBROUTINE SUNS2C
=====
COMMON/3LAD1/NV,NF,NT,4MAX,KF(50),IC,LV(50),LF(50),LT(50),
1 K1CHPG,K1C,ITMAX,NERR,UNITS,KAUAGL,KCALC,KOELT,KCONU
COMMON/3LAD2/NTIME,HTIME,TIME,DATE,DAY,DAY1,DAY2,NDAY(12),
1 MO,MO1,YR,NMO,NDAY1,INDATE
COMMON/3LAD3/T(50),TO(50),CPH(50),S(50),SP(50),COND(50,50),
1 SCUR(50),QFACO(50),ERRT(50),FN(50,50,2),FD(50,50,2)
COMMON/3LAD4/A(50,50),B(50),SQSRC1(50),SQSRC2(50),SQCON1(50),
1 SJUCN2(50),QVAT,QVCL,QVHT,QACL,QHZ,QINC,QTRAN
COMMON/3LAD5/SUMKT,QCIN,QCINO,FAC,FKAC,
1 PI,TIMEA,DEGRAJ,TBASE,DD,TMAX,TMIN,TBAR,FACI,REMAIN
COMMON/3LAD6/DSRC(50),QCON(50),QC12(100),SQC121(100),

```



```

1 SQC122(100),TCMIN,TCMAX,TCMINN,TCMINO,TCMAXN,TCMAXO,TCOOL
COMMON/BLADJ/TPERDAY,SICON,TAMB,QCINT
COMMON/BLAUB/IOAY,IOPEAY,INOAY,NOATA,QHCONV,ALAT,OLONG,
1 RINDEX,TOIT,UEC,COSDEC,SINDEC,SINLAT,COSLAT,QSP
2 ,HRCRIT,QICUT,KCHUT,KCOOL,KUSH1,MOSH2
COMMON/BLA97/TAB(50),VEL(50),QHC(50),RHO(50),NJS,ISCL(15),
1 TILT(15),HAZL(15),AGLZ(15),NGLZ(15),NJA,IAMS(10),
2 ALPHA(15),JHANG(15),USEPR(15),TGLZ(15),JABS(15),ISOLX(24)
COMMON/BLA10/QONMAX,KDIFF(5),EA,RHO,TZERO,
1 NCON,ICON(100),I2CON(100),U(100),ACON(100),UD(100),UN(100)
COMMON/BLA11/TILT0,AZIM0,R400,COST0,SINT0,FSGC,FSGO,RESNI,
1 JOP,KNO
COMMON/TRUMBE/VOLF,RCON(50),KVENT,IAIR,JAIR,RLNGTH,RHOSR,
1 ASPRAT,FCOSR,JWA,TRCOAT,JCH,KWALE
COMMON/IOFLGS/ISKPK,I01,I02,IPRINTH,IPRINTO,IPRINTM,IPRSM,KHEOPR
COMMON/TIMES/TRIGHT,THORN,TEVEN,DEL11,DEL2,TIME
DIMENSION EOT(12)

```

INTEGER DAY, DAY1, DAY2, YR, DATE, UNITS

DATA EOT/-11.2,-13.9,-7.5,1.1,3.3,-1.4,-6.2,-2.4,7.5,
1 15.4,13.8,1.6/

```

QH=QHC(ITIME)*QHCONV & TAMB=TAD(ITIME)
IA=IAMS(1) & T(IA)=TAMB
-- SOLAR HEAT SOURCE
IF(NJS.LE.9) RETURN
DO 140 I=1,NMAX
140 S(I)=SP(I)=0.
QHZ=QINC=0. & QIRAN=0.
IF(QH.LE.5.) RETURN
QHZ=QH
-- SOLAR TIME AND HOUR ANGLE
SUNTIME=TIMEX+FLOAT(ISOLX(ITIME))+EOT(MC)/60.-OLONG/15.--5
HR=15.+(12.-SUNTIME)
COSHR=COS(DEGRAD*HR) & SINHR=SIN(DEGRAD*HR)
-- SUN ALTITUDE
SINALT=COSLAT*COSDEC*COSHR+SINLAT*SINDEC
IF(SINALT.LE.0.) RETURN
ALT=ASIN(SINALT) & COSALT=COS(ALT)
-- SUN AZIMUTH
SINAZI=COSDEC*SINHR/COSALT & AZIM=ASIN(SINAZI)
IF(ABS(HR).GT.HRCRIT) AZIM=(PI-ABS(AZIM))*AZIM/ABS(AZIM)
-- COLLECTOR INPUT
IF(TILT0.LE.1.0) GO TO 160
CALL COLLECT(QH,AZIM,SINALT,COSALT,PP) & GO TO 170
160 QEXT=CSP*SINALT & PP=QH/QEXT
170 FQDN=1.79*PP-0.55
IF(FQDN.LT.0.) FQDN=0. & IF(FQDN.GT.1.) FQDN=1.
QDN=FQDN*QONMAX
QDER=QDN*SINALT & QDIF=QH-QDER
-- SOLAR HEAT SOURCE NODES
DO 200 J=1,NJS
IF=ISOL(J)
HAZL=HAZIM(J) & NGL=NGLZ(J)
SINTILT=SIN(DEGRAD*TILT(J)) & COSTILT=COS(DEGRAD*TILT(J))
-- HALL-SOLAR AZIMUTH
GAM=AZIM-DEGRAD*HAZI & COSGAM=COS(GAM)
-- HALL-SOLAR ANGLE OF INCIDENCE
COSINC=COSALT*SINTILT*COSGAM+SINALT*COSTILT
IF(COSINC.LE.0.) COSINC=.0001
AINC=ACOS(COSINC) & SININC=SIN(AINC)
-- FRESNEL RELATION FOR REFLECTION
TRANS=1. & AREF=0. & IF(NGL.EQ.0) GO TO 230
NGF=2*NGL-1
IF(AINC.EQ.0.) GO TO 200
AREF=ASIN(SININC/RINDEX) & X=AINC-AREF & Y=AINC+AREF
R1=(SIN(X)/SIN(Y))*2 & R2=(TAN(X)/TAN(Y))*2
T1=(1.-R1)/(1.+R1+NGF) & T2=(1.-R2)/(1.+R2+NGF)
TRANS=0.5*(T1+T2) & GO TO 230
200 X=(RINDEX-1.)/(RINDEX+1.)*2 & TRANS=(1.-R)/(1.+R*NGF)
230 CONTINUE
-- ABSORPTION IN GLAZING
GLASS=EXP(-EX*TGLZ(J)/COS(AREF))
-- SHADING FROM 1-0 OVERHANG
AFACT=1.0 & IF(CHANG(J).LE.0.) GO TO 340
TANEFF=SINALT/COSALT/COSGAM
IF(TANEFF.LT.USEPR(J)/CHANG(J)) GO TO 340
AFACT=1.-(CHANG(J)+TANEFF-USEPR(J))/(SINTILT+COSTILT+TANEFF)
IF(AFACT.GT.1.0) AFACT=1.0 & IF(AFACT.LT.0.) AFACT=0.
340 QDNA=QDN*AFACT
-- SPECULAR REFLECTOR (HORIZONTAL WITH VERTICAL COLLECTOR)

```



```

QINSR=0.5 IF(RLNGTH.EQ.0.0.OR.RHOSR.EQ.0.) GO TO 330
IF(J.NE.1) GO TO 330
IF(ABS(GAM).GE.PI/2.) GO TO 330 & TANGAM=ABS(TAN(GAM))
RLEFF=COSGAM+COSALT/SINALT & IF(RLEFF.GT.RLNGTH) RLEFF=RLNGTH
QJNA=QJNA+RLEFF*TANGAM/ASPRAT & ISR=RLEFF*(1.-.5*JWJW)
IF(QJNA.GT.1.) ASR=.5*ASPRAT/TANGAM
QINSR=QJNA*ASR+RHOSR*SINALT

```

380 CONTINUE

-- INCIDENT SOLAR RADIATION

```

QINUN=QJNA*COSINC & QINDF=QJIF*.5*(1.+COSTILT)
QINRF=QH*KHO*(.5*(1.-COSTILT)-FCOSR)+QJIF*FCOSR+RHOSR
QBEAM=QINUN+QINSR & QDIFF=QINDF+QINRF & QINC=QBEAM+QDIFF

```

```

IF(QINC.LT.QICUT.AND.RESNI.GT.0.01) KSHUT=KCOOL
IF(KSHUT.EQ.1) RETURN
QTRAN=QINC & IF(NGL.LE.0) GO TO 490

```

-- TRANSMITTED SOLAR RADIATION

```

QQ1=QBEAM & QQ2=QDIFF & XYZ=1./FLOAT(NGL)
TAUCK=TRANS*XYZ & TAUDF=(1.-ROIFF(NGL))*XYZ
LLL=NGL+JWA+2
DO 450 IX=1,NGL
QIN1=QQ1+TAUCK & QIN2=QQ2+TAUDF
QQ1=QIN1*GLABS & QQ2=QIN2*(1.-DABS(J))
IF(J.NE.1) GO TO 490

```

-- ABSORBED RADIATION HEAT SOURCES

```

LL=LLL-IX & IG=IICON(LL)
QABS=QIN1*(1.-GLABS)+QIN2*DABS(J)
IF(IX.EQ.NGL) QABS=QABS+(QQ1+QQ2)*(1.-TRCOAT)
S(IG)=S(IG)+QABS*AGLZ(J)

```

450 CONTINUE

490 QTRAN=(QQ1+QQ2)*TRCOAT

CONTINUE

S(I)=S(I)+QTRAN*AGLZ(J)*ALFA(J)

600 CONTINUE

RETURN

END

```

=====
SUBROUTINE COEFFACT(QH,AZIM,SINALT,COSALT,PP)
=====
COMMON/BLAD1/IV,NF,NT,4MAX,KF(50),IC,JV(50),LF(50),LT(50),
1 KICNG,KIC,ITMAX,NEAR,UNITS,KAUAC,KCALC,KDELT,KCONU
COMMON/BLAD2/NTIME,HTIME,ITIME,DATE,DAY,DAY1,DAY2,NDAY(12),
1 MO,M01,YR,NMC,NDAY1,INDATE
COMMON/BLAD3/T(50),TO(50),CPM(50),S(50),SP(50),COND(50,50),
1 SCUN(50),QFAC(50),ERRT(50),FN(50,50,2),FD(50,50,2)
COMMON/BLAD4/A(50,50),B(50),SQSRC1(50),SQSRC2(50),SQCOM1(50),
1 SQCOV2(50),QVHT,QVOL,QAHT,QACL,QHZ,QINC,QTRAN
COMMON/BLAD5/SUMKT,QOIN,QCINO,FAC,FAC,
1 PI,TIMEX,DEGRAS,TBASE,JD,TMAX,TMIN,TBAR,FACI,REMAIN
COMMON/BLAD6/QSRC(50),QCON(50),QC12(100),SQC121(100),
1 SQC122(100),TOMIN,TOMAX,TOMINN,TOMINO,TOMARN,TOMAXD,TCOOL
COMMON/BLAD7/TPERDAY,SBCON,TAMB,QCINT
COMMON/BLAD8/IDAY,IDPERYR,INDAY,KDATA,QHCONV,ALAT,DLONG,
1 KINDEX,TOLT,DEC,COSDEC,SINDEC,SINLAT,COSLAT,QSP
2 ,KGRIT,QICUT,KSHUT,KCOOL,MOSH1,MOSH2
COMMON/BLAD9/TAD(50),VELD(50),QHD(50),RHO(50),WJS,ISCL(15),
1 TILT(15),WAZIM(15),AGLZ(15),HGLZ(15),NJA,IAMB(10),
2 ALFA(15),OHANG(15),OSEPR(15),TOLZ(15),DABS(15),ISOLX(24)
COMMON/BLAD10/QDNMAX,ROIFF(5),EX,KHO,TZERO,
1 NCONN,IICON(100),I2CON(100),U(100),ACON(100),UN(100)
COMMON/BLAD11/TILTC,AZIC,KHO,COSTC,SINTC,FSSC,FSGC,RESNI,
1 JCF,KND
COMMON/TRUMBE/VOLF,RCUN(50),KVENT,IAIR,JAIR,RLNGTH,RHOSR,
1 ASPRAT,FCOSR,JWA,TRCOAT,JCW,KWALL
COMMON/IGFLGS/ISKOPR,I01,I02,IPRINTH,IPRINTO,IPRINTM,IPRSM,KHEOPR
COMMON/TIMES/TNIGHT,TMORNY,TEVEN,DELTA1,DELTA,TIME

```

```

A1=1.79 & B1=0.55 & XMIN=B1/A1 & XMAX=(1.+B1)/A1
GAMC=AZ+MC+DEGRAD-AZIM
COSIC=COSALT*SINTC+COS(GAMC)*SINALT+COSTC
IF(COSIC.LE.0.) COSIC=.0001 & RATIO=SINALT/COSIC
CAPA=QDNMAX/QSP*(1.-FSSC*RATIO) & CAPB=RATIO*(FSSC+RHO*FSGC)
Y=IH/QSP/COSIC
PP=(Y+B1*CAPA)/(A1*CAPA+CAPB)
IF(PP.LT.XMIN) PP=Y/CAPB & IF(PP.GT.XMAX) PP=(Y-CAPB)/CAPB
QH=PP*QSP*SINALT
RETURN
END

```

23175 31 12 .2301E+01 -.1159E+00 .1712E+05 0. .6704E+03
 QSP QEC QFNU
 .4705E+03 -.2309E+02 .4740E+02

MONTH INDEX= 1 MONTH OF YEAR= 12
 QVHT QVCL QAMT QACL QJ
 .2301E+01 -.1159E+00 .1712E+05 0. .6704E+03

I	QSR01	QSR02	QCO01	QCO02
1	.9350E+04	0.	.5710E+01	-.9410E+04
2	0.	0.	.3370E+04	-.3440E+04
3	0.	0.	.1370E+04	-.1442E+04
4	0.	0.	.8130E+03	-.8705E+03
5	0.	0.	.7391E+03	-.8003E+03
6	0.	0.	.2200E+00	-.1752E+01
8	0.	0.	.2353E+00	-.1581E+03
9	0.	0.	.2541E+02	-.5701E+01
10	.5779E+03	0.	.1197E+02	-.5787E+03
11	.5079E+03	0.	.1094E+01	-.8053E+03
7	0.	0.	.1114E+02	-.1710E+05

NO AUXILIARY COOLING - QACL IS INT(T(IG)-TMAX)DT

SUMMARY -- TIME= 744 NSTEP= 707 NCALC= 1236 KERR= 0

40	DES DAY	QOUI	QHEAT	QCOOL	QSOLAR	QLOAD	QACL	QSING	PCTSOL
12	676.	5832.	17122.	-0.	9358.	21030.	67.	14733.	18.61
SUMS	676.	5832.	17122.	-0.	9358.	21030.	67.	14733.	18.61

TOTALS QVHT QVCL QAMT QACL QJ
 .2301E+01 -.1159E+00 .1712E+05 0. .6704E+03

I	QSR01	QSR02	QCO01	QCO02
1	.9350E+04	0.	.5710E+01	-.9410E+04
2	0.	0.	.3370E+04	-.3440E+04
3	0.	0.	.1370E+04	-.1442E+04
4	0.	0.	.8130E+03	-.8705E+03
5	0.	0.	.7391E+03	-.8003E+03
6	0.	0.	.2200E+00	-.1752E+01
8	0.	0.	.2353E+00	-.1581E+03
9	0.	0.	.2541E+02	-.5701E+01
10	.5779E+03	0.	.1197E+02	-.5787E+03
11	.5079E+03	0.	.1094E+01	-.8053E+03
7	0.	0.	.1114E+02	-.1710E+05

J	I1	I2	QO1121	QO1122
1	1	10	.4202E+04	-.3854E+02
2	1	2	.4730E+04	-.3884E+04
3	2	3	.2297E+04	-.1372E+04
4	3	4	.1435E+04	-.4423E+03
5	4	5	.1370E+04	-.3238E+03
6	5	5	.1704E+04	-.8714E+03
7	5	7	.1735E+04	-.5714E+03
8	7	5	.2104E+03	-.1100E+03
9	9	7	.2074E+04	-.1201E+02
10	1	9	.4300E+04	-.1709E+02
11	9	10	.1779E+04	-.1200E+03
12	10	11	.6007E+04	-.5823E+02
13	11	5	.7491E+04	-.5512E+02

11.	J.0	0.0	0.0	18.5-22.5	3.1	23.5	0.0	9.1	9.1	22.5	22.5	59.	07.	09.	09.	00.	07.	09.	13.	59.	41.
11.	0.0	0.0	0.0	12.4-20.7	3.0	22.0	0.0	3.3	3.3	20.7	20.7	59.	03.	07.	08.	03.	07.	05.	21.	51.	42.
12.	0.0	0.0	0.0	11.3-10.9	2.3	20.0	0.0	7.0	7.5	10.9	10.9	58.	02.	06.	03.	07.	00.	24.	51.	43.	
13.	117.3	0.1	9.0	10.5-04.1	2.0	20.7	3.0	10.0	7.3	32.5	42.0	31.	05.	00.	07.	07.	07.	05.	24.	63.	62.
14.	7+0	5.3	0.2	17.2-2.3	2.4	21.3	4.1	14.0	10.5	32.9	39.2	79.	71.	67.	67.	67.	67.	00.	23.	07.	53.
15.	45.6	3.5	4.0	10.4-17.0	2.2	23.7	5.1	11.4	10.9	30.6	34.0	70.	72.	60.	57.	67.	00.	65.	24.	65.	56.
16.	2.4	.2	.2	17.1-20.3	2.1	20.0	0.0	9.1	9.1	23.4	23.6	57.	71.	08.	07.	07.	06.	05.	24.	53.	49.
17.	0.0	0.0	0.0	0.5-10.6	2.3	20.7	0.0	4.1	4.1	10.6	10.6	67.	09.	09.	07.	07.	06.	05.	24.	03.	59.
18.	0.0	0.0	0.0	0.5-10.6	2.0	21.0	0.0	4.1	4.1	10.6	10.6	60.	03.	08.	07.	07.	05.	05.	23.	62.	53.
19.	0.0	0.0	0.0	0.5-10.7	2.0	21.3	0.0	4.1	4.1	10.7	10.7	60.	00.	00.	07.	07.	00.	05.	22.	61.	57.
20.	0.0	0.0	0.0	0.5-10.6	2.3	21.5	0.0	4.1	4.1	10.6	10.6	65.	07.	06.	07.	07.	03.	05.	22.	61.	57.
21.	0.0	0.0	0.0	0.6-10.3	2.0	22.3	0.0	4.2	4.2	10.6	10.3	64.	00.	07.	07.	07.	00.	05.	20.	60.	56.
22.	0.0	0.0	0.0	6.3-11.1	1.3	23.0	0.0	4.3	4.3	11.1	11.1	63.	00.	07.	07.	07.	00.	05.	19.	59.	55.
23.	0.0	0.0	0.0	5.7-11.9	7.5	23.5	0.0	4.3	4.3	11.0	11.0	63.	05.	07.	07.	06.	05.	00.	19.	59.	54.

DATE JAY MO QVHT QVCL QAHT QAQL QD
 23078 30 12 .9915E+00 -.2767E+02 .7912E+04 0. .8324E+03
 QSP DEC JTD
 .4405E+03 -.2315E+02 .4745E+02

DATE= 123173

DATE JAY MO QVHT QVCL QAHT QAQL QD
 23173 31 12 .9915E+00 -.2767E+02 .8448E+04 0. .8764E+03
 QSP DEC JTD
 .4405E+03 -.2309E+02 .4425E+02

MONTH INDEX= 1 MONTH OF YEAR= 12
 QVHT QVCL QAHT QAQL QD
 .9915E+00 -.2767E+02 .8448E+04 0. .8764E+03

I	5QSR01	5QSR02	5QSQ01	5QSQ02
1	.9343E+04	0.	.1043E+01	-.9410E+04
2	0.	0.	.3003E+04	-.3035E+04
3	0.	0.	.1494E+04	-.1538E+04
4	0.	0.	.8861E+03	-.9076E+03
5	0.	0.	.7927E+03	-.8000E+03
6	0.	0.	.1011E+02	-.7170E+01
8	0.	0.	.1989E+05	-.1533E+03
9	0.	0.	.3040E+02	-.1776E+02
10	.6772E+03	0.	.4701E+01	-.7192E+03
11	.3073E+03	0.	.3942E+02	-.8775E+03
7	0.	0.	.4340E+02	-.3303E+04

NO AUXILIARY COOLING - QAQL IS INT(T(IG)-TMAX)DT

SUMMARY -- MTIME= 744 NSTEP= 789 NCALC= 1269 KERR= 0

MO	DEG	JAY	QOUT	QHEAT	QCool	QSOLAR	QLOAD	QAQL	QSING	PCTSCL
12	076.		7618.	8449.	-28.	9343.	10034.	33.	14733.	20.55
5045	376.		7618.	8449.	-28.	9343.	10034.	33.	14733.	20.55

TOTALS QVHT QVCL QAHT QAQL QD
 .9915E+00 -.2767E+02 .8448E+04 0. .8764E+03

I	5QSR01	5QSR02	5QSQ01	5QSQ02
1	.9343E+04	0.	.1043E+01	-.9410E+04
2	0.	0.	.3003E+04	-.3035E+04
3	0.	0.	.1494E+04	-.1538E+04
4	0.	0.	.8861E+03	-.9076E+03
5	0.	0.	.7927E+03	-.8000E+03
6	0.	0.	.1011E+02	-.7170E+01
8	0.	0.	.1989E+05	-.1533E+03
9	0.	0.	.3040E+02	-.1776E+02
10	.6772E+03	0.	.4701E+01	-.7192E+03
11	.3073E+03	0.	.3942E+02	-.8775E+03
7	0.	0.	.4340E+02	-.3303E+04

J	I1	I2	5QSI21	5QSI22
1	1	10	.5034E+04	-.5033E+02
2	1	2	.5002E+04	-.4013E+04
3	2	3	.2232E+04	-.2003E+04
4	3	4	.1233E+04	-.3702E+03
5	4	5	.1034E+04	-.5347E+03
6	5	6	.1540E+04	-.1023E+04
7	0	7	.1544E+04	-.1033E+04
8	7	3	.1003E+05	-.7235E+02
9	9	7	.1011E+04	-.1042E+02
10	1	9	.4275E+04	-.2041E+02
11	9	10	.2007E+04	-.3333E+02
12	10	11	.0413E+04	-.0152E+02
13	11	8	.9250E+04	-.0123E+02

20.5345 UCPL, A422, 1.670K LNS.

23178 31 12 .3752E+01 J. .2019E+05 0. .8764E+03

QSP DEC DTWD
.4+05E+03 -.2309E+02 .3775E+02

MONTH INDEX= 1 MONTH OF YEAR= 12
QVHT QVCL QAHT QAQL QO
.3752E+01 0. .2019E+05 0. .8764E+03

I	SQSRC1	SQSRC2	SQCON1	SQCON2
1	.9+02E+04	0.	.1030E+00	-.9+13E+0+
2	0.	0.	.3942E+04	-.4116E+0+
3	0.	0.	.1052E+04	-.1798E+0+
4	0.	0.	.9325E+03	-.1052E+0+
5	0.	0.	.8042E+03	-.3969E+03
6	0.	0.	.1308E+03	-.3342E-11
8	0.	0.	.3195E+03	-.2314E+03
9	0.	0.	.4577E+02	-.3267E+01
10	.6013E+03	0.	.2391E+01	-.6323E+03
11	.8121E+03	0.	.8894E+00	-.5320E+03
7	0.	0.	.2870E+01	-.2025E+05

NO AUXILIARY COOLING - QAQL IS INT(T(IG)-TUMAX) DT

SUMMARY -- MTIME= 7++ NSTEP= 765 HCALC= 1241 KERR= 1

NO	DEG DAY	QOUT	QHEAT	QCOOL	QSOLAR	QLOAD	QAQL	QSING	PCISCL
12	376.	9270.	20195.	0.	9402.	20998.	65.	14733.	3.8-
SUMS	376.	9270.	20195.	0.	9402.	20998.	65.	14733.	3.8-

TOTALS QVHT QVCL QAHT QAQL QO
.3752E+01 0. .2019E+05 0. .8764E+03

I	SQSRC1	SQSRC2	SQCON1	SQCON2
1	.9+02E+04	0.	.1030E+00	-.9+13E+0+
2	0.	0.	.3942E+04	-.4116E+0+
3	0.	0.	.1052E+04	-.1798E+0+
4	0.	0.	.9325E+03	-.1052E+0+
5	0.	0.	.8042E+03	-.3969E+03
6	0.	0.	.1308E+03	-.3342E-11
8	0.	0.	.3195E+03	-.2314E+03
9	0.	0.	.4577E+02	-.3267E+01
10	.6013E+03	0.	.2391E+01	-.6323E+03
11	.8121E+03	0.	.8894E+00	-.5320E+03
7	0.	0.	.2870E+01	-.2025E+05

J	I1	I2	SQC121	SQC122
1	1	10	.5951E+04	-.7329E+02
2	1	2	.5237E+04	-.6355E+0+
3	2	3	.2201E+04	-.3145E+0+
4	3	+	.1020E+04	-.1521E+04
5	4	5	.6502E+03	-.1337E+04
6	5	6	.1008E+04	-.1594E+04
7	6	7	.1008E+04	-.1594E+04
8	7	8	.2100E+03	-.1127E+03
9	9	7	.1251E+04	-.3065E+02
10	1	9	.4700E+04	-.3652E+02
11	9	10	.3441E+04	-.4440E+02
12	10	11	.1007E+05	-.1192E+03
13	11	6	.1095E+05	-.1190E+03

2317J 31 12 .5555E+01 0. .2896E+05 0. .8764E+03
 QSP DEC DTWD
 .4405E+03 -.2309E+02 .4383E+02

MONTH INDEX= 1 MONTH OF YEAR= 12
 QVHT QVCL QAHT QAEL JJ
 .5555E+01 0. .2896E+05 0. .8764E+03

	SQSRC1	SQSRC2	SQCON1	SQCON2
1	.9351E+04	0.	.1216E-01	-.9+15E+04
2	0.	0.	.3528E+04	-.3027E+04
3	0.	0.	.1452E+04	-.1543E+04
4	0.	0.	.8411E+03	-.9243E+03
5	0.	0.	.7992E+03	-.3658E+03
6	0.	0.	.2015E-09	-.1158E-10
8	0.	0.	.4034E+05	-.2140E+03
9	0.	0.	.3152E+02	-.1024E+01
10	.6779E+03	0.	.3075E+00	-.6331E+03
11	.8080E+03	0.	.9033E+00	-.9000E+03
7	0.	0.	.9080E+00	-.2901E+05

NO AUXILIARY COOLING -- QAEL IS INT(TTIC)-TOMAX)OT

SUMMARY -- NTIME= 7+4 NSTEP= 757 NCALC= 1217 KERR= 0

	DEG DAY	QOUT	QHEAT	QCOOL	QSOLAR	QLOAD	QAEL	QSINO	POISCL
40	876.	7435.	28963.	0.	9351.	31++2.	38.	14733.	7.89
12	876.	7435.	28963.	0.	9351.	31++2.	38.	14733.	7.89
SUMS	876.	7435.	28963.	0.	9351.	31++2.	38.	14733.	7.89

TOTALS QVHT QVCL QAHT QAEL JJ
 .5555E+01 0. .2896E+05 0. .8764E+03

	SQSRC1	SQSRC2	SQCON1	SQCON2
1	.9351E+04	0.	.1216E-01	-.9+15E+04
2	0.	0.	.3528E+04	-.3027E+04
3	0.	0.	.1452E+04	-.1543E+04
4	0.	0.	.8411E+03	-.9243E+03
5	0.	0.	.7992E+03	-.3658E+03
6	0.	0.	.2015E-09	-.1158E-10
8	0.	0.	.4034E+05	-.2140E+03
9	0.	0.	.3152E+02	-.1024E+01
10	.6779E+03	0.	.3075E+00	-.6331E+03
11	.8080E+03	0.	.9033E+00	-.9000E+03
7	0.	0.	.9080E+00	-.2901E+05

J	I	I2	SQC121	SQC122
1	1	10	.4932E+04	-.5228E+02
2	1	2	.4070E+04	-.4741E+04
3	2	3	.2230E+04	-.1992E+04
4	3	4	.1235E+04	-.9026E+03
5	4	5	.1045E+04	-.6277E+03
6	5	6	.1448E+04	-.4853E+03
7	6	7	.1448E+04	-.9653E+03
8	7	8	.3144E+05	-.1339E+03
9	9	7	.1033E+04	-.2030E+02
10	1	9	.4373E+04	-.2445E+02
11	9	10	.2550E+04	-.4430E+02
12	10	11	.8198E+04	-.6044E+02
13	11	8	.9097E+04	-.6027E+02

23173 31 12 .3110E+01 -.6689E-01 .1359E+05 0. .8764E+03

QSP UEC DTWD
.4+05E+03 -.2309E+02 .4397E+02

MONTH INDEX= 1 MONTH OF YEAR= 12

QVHT QVCL QAHT QAQL DD
.3110E+01 -.6689E-01 .1359E+05 0. .3764E+03

	SQSRC1	SQSRC2	SQCON1	SQCON2
1	.9374E+04	0.	.1564E+00	-.9416E+04
2	0.	0.	.3555E+04	-.3669E+04
3	0.	0.	.1467E+04	-.1564E+04
4	0.	0.	.8248E+03	-.9379E+03
5	0.	0.	.7335E+03	-.8623E+03
6	0.	0.	.2162E+03	-.7251E+00
8	0.	0.	.3013E+05	-.1907E+03
9	0.	0.	.3537E+02	-.6372E+01
10	.6791E+03	0.	.6320E+01	-.6310E+03
11	.3094E+03	0.	.9432E+00	-.3804E+03
7	0.	0.	.6336E+01	-.1864E+05

NO AUXILIARY COOLING - QAQL IS INT(T(10)-TGMX)DT

SUMMARY -- MTIME= 744 NSTEP= 765 NCALC= 1234 KERR= 0

MO	DEG DAY	QOUT	QHEAT	QCOOL	QSOLAR	QLOAD	QAQL	QSING	PCTSGE
12	376.	7479.	18595.	-0.	9374.	21018.	66.	14733.	11.50
SUMS	376.	7479.	18595.	-0.	9374.	21018.	66.	14733.	11.50

TOTALS QVHT QVCL QAHT QAQL DD
.3110E+01 -.6689E-01 .1359E+05 0. .8764E+03

	SQSRC1	SQSRC2	SQCON1	SQCON2
1	.9374E+04	0.	.1564E+00	-.9416E+04
2	0.	0.	.3555E+04	-.3669E+04
3	0.	0.	.1467E+04	-.1564E+04
4	0.	0.	.8248E+03	-.9379E+03
5	0.	0.	.7335E+03	-.8623E+03
6	0.	0.	.2162E+03	-.7251E+00
8	0.	0.	.3013E+05	-.1907E+03
9	0.	0.	.3537E+02	-.6372E+01
10	.6791E+03	0.	.6320E+01	-.6310E+03
11	.3094E+03	0.	.9432E+00	-.3804E+03
7	0.	0.	.6336E+01	-.1864E+05

J	I1	I2	SQC121	SQC122
1	1	10	.4997E+04	-.5240E+02
2	1	2	.4919E+04	-.4730E+04
3	2	3	.2251E+04	-.1999E+04
4	3	4	.1243E+04	-.8933E+03
5	4	5	.1046E+04	-.6143E+03
6	5	6	.1483E+04	-.9517E+03
7	6	7	.1463E+04	-.9617E+03
8	7	6	.2102E+05	-.1110E+03
9	7	7	.1790E+04	-.2134E+02
10	1	9	.4337E+04	-.2486E+02
11	9	10	.2566E+04	-.3206E+02
12	10	11	.8233E+04	-.5002E+02
13	11	0	.9112E+04	-.7982E+02

APPENDIX

3.

REMOVED INTENTIONALLY. CANNOT BE
RECONSTRUCTED.

APPENDIX 4.

PASOLE: A GENERAL SIMULATION PROGRAM FOR PASSIVE SOLAR ENERGY

by

Robert D. McFarland

ABSTRACT

The PASOLE computer program was developed to do simulations of passive solar heated buildings. Modeling is done using a general thermal network method that allows for heat sources and thermal storage. Sun position equations are used with a global-to-direct solar radiation correlation to develop solar heat sources from measured insolation data. Models of a particular class of south-mass-wall passive buildings have been developed and are described in this report.

INTRODUCTION

PASOLE (PAssive SOLar Energy) is a computer program that incorporates a general, thermal network solution of an interconnected system of uniform temperature regions with time-varying boundary conditions and heat sources. PASOLE was designed specifically for detailed analyses of passive solar heated structures and includes algorithms for calculating solar sources in a general way. Because of its generality, PASOLE can be used to simulate hybrid or active solar heating systems. The PASOLE format allows the user to describe the thermal network model by specifying nodes that represent finite regions, connections between these nodes, and parameters associated with the nodes and connections. These specifications are made in FORTRAN sub-routines in the program. PASOLE is not a standard "user oriented" program; that is, to use the program for other than the specific models for which it is programmed, the user must have some knowledge of heat transfer principles and FORTRAN programming.

In describing the program, we will refer to a particular class of south-mass-wall (SMW) passive solar heating systems—the network models for which this version of PASOLE is programmed. Although PASOLE was not written specifically for these particular models, they have been used for extensive parametric analyses and serve as an example of how simulation models can be created. For these models, hour-by-hour simulations for one full year, using real weather data, take about 1 min of central processor (CP) time on the CDC 7600.

Most of the variables in the program are given in Appendixes A-C. The FORTRAN listing in Appendix D includes numerous comments. A sample output is given in Appendix E.

THERMAL NETWORK MODEL OF PHYSICAL SYSTEM

The system's physical and environmental structure is represented by a network of N nodes, each representing a region of uniform temperature. Each node may be connected to any other node by a thermal conductance K , such that the rate of heat flow from node i to node j is linear, $Q_{ij} = K_{ij} (T_i - T_j)$. Each node may have a heat capacitance M and a heat source rate E . The source rate E may be a linear function of the node temperature $E = S + B \cdot T$.

The heat balance at any given node i at time t is

$$\sum_{j=1}^N K_{ij} (T_i - T_j) + M_i (dT/dt)_i = S_i + B_i T_i, \quad (1)$$

where j denotes each of the other nodes in the network system. Many of the K_{ij} 's usually are zero, but K_{ii} is always zero for $j = i$. Many nodes have no heat source term ($S_i = B_i = 0$) and many have essentially no heat capacity ($M_i = 0$). When the node is massless its temperature is not directly dependent on its temperature history, so it requires a slightly different mathematical treatment, as shown below.

By rearranging Eq. (1) to obtain the time rate of node temperature change $(dT/dt)_i$, and by separating variables and integrating over the time interval from t^0 to t , we obtain the node temperature change over time increment Δt by

$$T_i - T_i^0 = \int_{t^0}^t \frac{S_i + B_i T_i}{M_i} dt + \sum_{j=1}^N \int_{t^0}^t \frac{K_{ij}}{M_i} (T_j - T_i) dt, \quad (2)$$

where the superscript zero denotes conditions at the "old" time, $t^0 = t - \Delta t$.

The average values of the integrands are assumed to be a linear function of their values at times t^0 and t . Letting I be a general integrand

$$\int_{t^0}^t I dt = \bar{I} \Delta t, \quad (2a)$$

where $\bar{I} = f I + (1 - f) I^0$. Although f may be varied in the program and may take any value from zero to unity, a value of 0.5 usually is used because it is the most accurate and results in stable solutions.

Some nodes, such as outside air temperature, have "fixed" or known temperatures at a given time, whereas other nodes have "variable" or unknown temperatures that must be determined. Let NV be the number of variable-temperature nodes, NF the number of fixed-temperature nodes, and N the total number of nodes. By inserting the integrand approximation into Eq. (2) and collecting terms that contain the unknown T_i , the variable T_j 's, and the constant terms for each of the NV variable-temperature nodes, we obtain a set of NV linear equations with NV unknowns.

$$\sum_{j=1}^{NV} a_{ij} T_j = b_i \quad ; \quad i = 1, NV, \quad (3)$$

where

$$a_{ij} = -f K_{ij} \text{ for } j \neq i,$$

$$a_{ij} = M_i/\Delta t + f \left(\sum_{j=1}^N K_{ij} - \beta_i \right) \text{ for } j = i,$$

and

$$b_i = M_i T_i^{\circ}/\Delta t + f \left(S_i + \sum_{j=1}^{NF} K_{ij} T_j \right) + (1 - f) \left(M_i/M_i^{\circ} \right) \left[S_i^{\circ} + B_i^{\circ} T_i^{\circ} + \sum_{j=1}^N K_{ij}^{\circ} (T_j^{\circ} - T_i^{\circ}) \right].$$

For $M_i = M_i^{\circ} = 0$, b_i reduces to

$$f \left(S_i + \sum_{j=1}^N K_{ij} T_j \right)$$

from Eq. (1), and f cancels out of the equation.

SOLUTION

Temperatures are determined using Eq. (3) and a standard linear-equation solving technique. In this case the Los Alamos Scientific Laboratory's (LASL) library routine LSS was used to solve the variable temperatures, after the values of the a and b arrays had been determined. Because many of the variables used to determine the a and b arrays can be functions of temperature, thus making the problem nonlinear, an iteration loop is provided at each time step to obtain temperature dependencies where the temperature determined from the previous time step is not satisfactory. This problem arises particularly for natural convection (thermocirculation or thermosiphon) connections and thermal radiation connections.

If the coefficients a_{ij} in Eq. (3) are constant—meaning the conductances are constant—the set of linear equations can be solved at the beginning of the program run. This results in a set of coefficients F_{ij} , such that the node temperatures can then be determined by

$$T_i = \sum_{j=1}^{NV} F_{ij} b_j; \quad i = 1, NV, \quad (4)$$

where the b arrays are as described in Eq. (3).

Use of this option can reduce computation time considerably for models with numerous nodes. In PASOLE, four sets of F_{ij} 's are calculated — for daytime or nighttime operation with a fixed or floating "control node" temperature.

CONTROL TEMPERATURE

A particular temperature, such as room temperature, is monitored by a control node to maintain it within prescribed bounds. At present, only one control node is allowed. When this temperature is within the prescribed bounds, the control node is a variable-temperature node and no auxiliary heat source is required. When the control node temperature goes beyond a temperature bound during a time increment, the control temperature is fixed at the bound and an auxiliary heat source is calculated to maintain that temperature.

$$E_{aux} = \sum_{j=1}^N K_{ij} (T_i - T_j) - S_i - B_i T_i, \quad (5)$$

where T_i is the fixed bound temperature of the control node. In some models, the thermal conductance value of a connection to the control node can be varied within certain bounds (such as for proportional control dampers). This variability reduces or eliminates the need for an auxiliary heat source to maintain a control node temperature bound.

When the operating mode of the control node changes during the time step, the time step is subdivided and two or more calculations are made. Running sums of positive (source) and negative (sink) auxiliary heat sources are made. The sink (cooling) calculation is divided further into "ventilation" and "auxiliary" cooling, depending on whether the cooling occurs when the outside air temperature is below or above the control node upper bound temperature.

Running sums also are kept of the total heat into and out of individual nodes, the total node heat source and sink other than auxiliary, and total connection heat flows. For bookkeeping purposes the auxiliary heating or cooling of the control node is not combined with any other sources for that node.

THERMAL CONNECTIONS

The most common thermal connection is the "UA" type

$$K_{ij} = U_k A_k, \quad (6)$$

where U_k is the overall heat transfer coefficient for connection k between nodes i and j , and A_k is the heat transfer area of connection k . Many models have an advection connection that results from thermocirculation. The algebraic form of this connection conductance depends on the assumed temperature distributions in the legs of the circulation path and the relation between the temperature distributions and the temperature of the nodes that represent these legs. A common example is a Trombe wall collector that has an advection connection between the room and the heated air space between the wall and glazing. If it is assumed that the temperature distribution in the air space is linear, such that the air space node is at the arithmetic average of the inlet

and outlet temperatures, and that the room air is fully mixed, the thermal conductance is given by $K_{ij} = 2\rho C_p \dot{v}$, where C_p is the air specific heat, ρ is the air density, and \dot{v} is the volumetric air flow rate. Because the value of \dot{v} depends on the average air column temperatures, the thermal conductance is highly temperature dependent and iterations are required.

In the example model for a Trombe wall, the thermocirculation flow is calculated by

$$\dot{v} = C_d A_v \sqrt{gH \Delta T / \bar{T}}, \quad (7)$$

where

C_d is the vent discharge coefficient—taken to be 0.8,

A_v is the area of one row of thermocirculation vents—top or bottom (assumed to be the same),

g is the acceleration due to gravity,

H is the air column height,

ΔT is the difference between the average temperatures of the wall/glazing air space and the room behind the wall, and

\bar{T} is the average absolute temperature of the air space.

Equation (7) was derived by considering a driving force caused by the density difference between the two air columns and a flow resistance from two rows of vents in series, assuming the vents are the dominant resistance to air flow. The equation must be modified if there is another significant flow resistance, such as that to flow in the wall/glazing air space.

For problems involving one-dimensional transient conduction, such as in thick masonry mass walls, an adequate model can be made using several internal nodes in series, in which each node has a part of the total mass associated with it, and massless nodes on each surface. The nodes are connected by appropriate conduction UA values in the direction of heat flow. Other schemes in which each node has some mass associated with it may also give good results.

INSOLATION

Any node may have several solar heat sources with various insolation areas, glazing tilts and azimuths, number and thickness of glazings, and solar absorptivities. In some cases, the applicable external insolation is read directly from the weather data file; in other cases, the weather data insolation is for a horizontal surface and a correction to the insulator orientation is required. Also required are estimates of reflected insolation and glazing transmission. The equations used to determine the insolation on an internal solar collector surface are given in Appendix A (most of the equations are from Ref. 1). The solar sources are added to other heat sources that have been specified for that node. The solar source for node i is calculated by

$$S_i = Q_{\text{TRAN}} \cdot A_{\text{GLZ}} \cdot \text{ALFA}, \quad (8)$$

where Q_{TRAN} is the solar flux transmitted through the glazing, A_{GLZ} is the area of absorbing surface associated with node i , and ALFA is the solar absorptivity of the surface. Solar radiation not absorbed by the surface is assumed to be lost; that is, internal reflections are not accounted for.

In the present PASOLE model, glazings of the primary solar source are represented by nodes. These nodes are given heat sources equal to the solar radiation absorbed by the glazing. The model could be expanded to allow for heat source nodes in the glazings of all solar sources.

PHASE-CHANGE MATERIALS

Because temperature is the primary dependent variable, it is not convenient to handle heat-of-fusion as an isothermal enthalpy change. Problems involving phase-change materials have been solved by representing the heat-of-fusion as an increase in heat capacity over a given temperature range of about 10 to 20°C. For these problems the heat capacitance becomes a temperature-dependent parameter.

PROGRAM STRUCTURE

PASOLE consists of a main program, seven subroutines, and one function (Fig. 1). All but one (COLLECT) of the subroutines are called directly by the main program. In addition to the PASOLE subroutines, several routines in the LASL computer library also are called by the main program.

Three time step loops are set up in the main program. The outer loop advances the month, the next loop advances the day of the month, and the inner loop advances the basic time step—usually 1 h. Another loop inside the inner time step loop is used for iterations, if required, for temperature dependence of the coefficients. Coefficients a_{ij} and b_i of Eq. (3) are computed inside the iteration loop. Equation (3) is solved using the LASL library routine LSS, or the temperatures are determined directly by solving Eq. (4). If any of the calculated node temperatures deviate from their previous iteration value (or from the previous time step, if the first iteration) by more than the specified value of TOLT, another iteration is made using the calculated temperatures as the new values. The iteration process continues until convergence is reached or until ITMAX iterations have been made. If convergence is not reached the run is not stopped, but the output counter KERR is advanced by one.

If the control node changes operating mode (from fixed to variable temperature, or vice versa) during a time step, the basic time step is divided into two or more smaller time steps, but no new solar/weather data are obtained.

At the end of each time step, heat flow sums are updated, variables are set for the next time step, and film file variables are set if graphic output is to be obtained. After all the time step loops are completed, the summary output is made. For parametric studies the entire program is put in a "problem" loop, in which specific parameters are varied.

SUBROUTINES

The data required to run the problem and the parameters (Appendix B) that describe the model structure are set in subroutine INDATA. We also could use INDATA to read data from cards or from another file. All data written into INDATA are given in FORTRAN. Except for a block of default values at the beginning, INDATA probably would be changed completely for each different model.

Preliminary calculations are done in subroutine PRIME, using the data supplied in INDATA. Included in these calculations are the setting up of arrays of fixed- and floating-temperature nodes and the determination of the coefficients F_{ij} of Eq. (4), if applicable.

Subroutine DAYLY is called once each time through the day loop. Here, the daily weather data are read from a data file or are calculated. In addition, the solar declination and extraterrestrial normal solar flux are computed for the current day. Weather data required are the

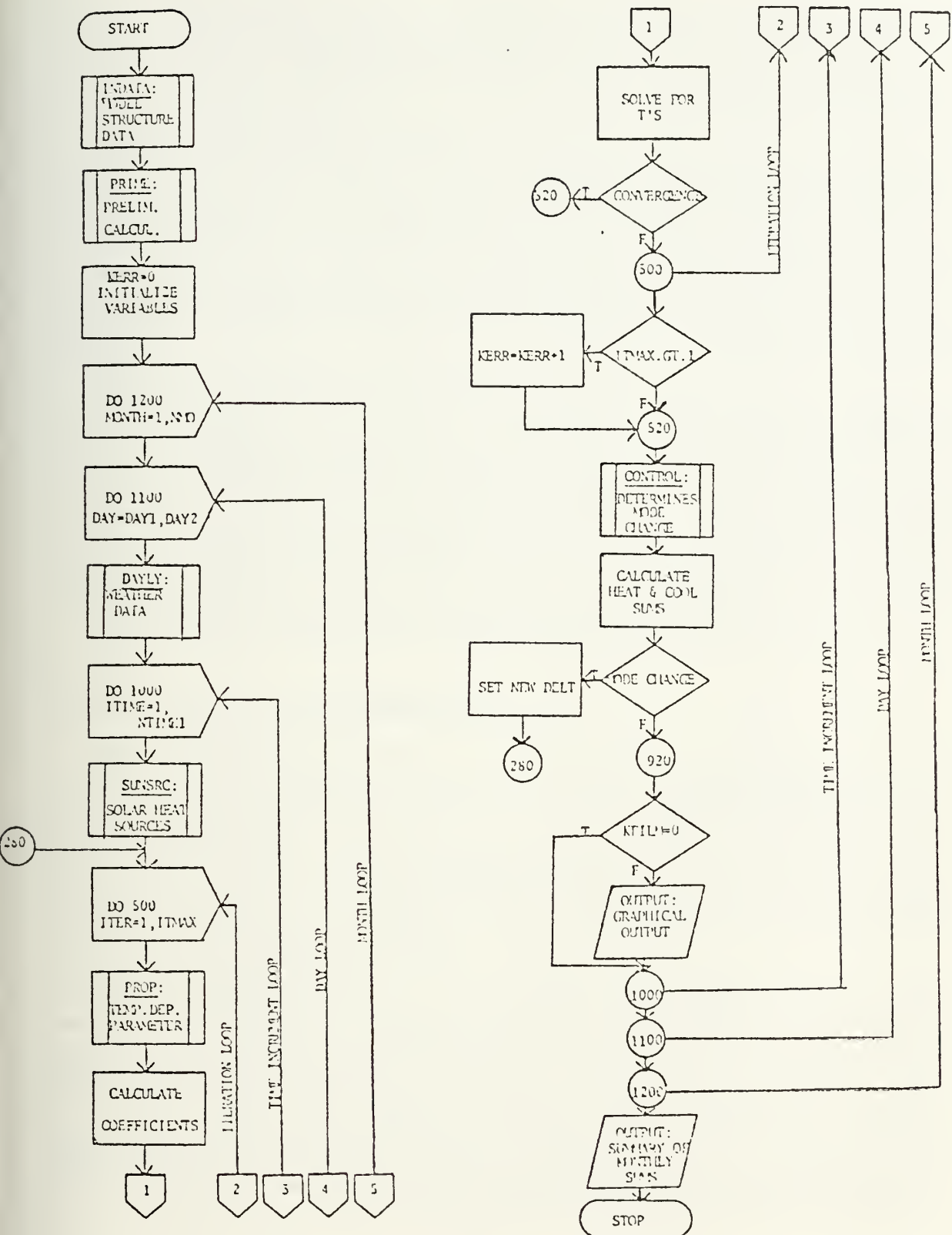

Fig. 1. PASOLE main program.

total solar radiation flux on a known tilt (QHD) and the ambient air temperature (TAD). Also useful is the wind velocity (VELD). If there are fixed-temperature nodes other than the outside ambient, DAYLY is a convenient place to enter the temperature data for these nodes. Because weather data formats are different, this subroutine probably will have to be adapted to the particular data set being used.

SUNSRC calculates the heat sources from solar radiation absorption. Most of the equations in Appendix A are solved by SUNSRC. If the solar radiation measurements read in DAYLY are not taken on the horizontal plane, the subroutine COLLECT is called. COLLECT solves the Boes' correlation backwards; that is, it obtains the equivalent total horizontal radiation from the given measured radiation, the tilt (TILTC), and azimuth (AZIMC) of the measuring surface and the assumed diffuse ground reflectance (RHOC) pertaining to the measurement. The computed total horizontal radiation is then used to proceed with the calculations. Different optical systems than those assumed here (for example, one with internal reflections) would require changes in SUNSRC.

Model structure parameters that should be furnished by INDATA, but that are temperature and/or time dependent, are calculated in subroutine PROP, which is inside the temperature iteration loop. PROP is called just before the solution of Eq. (3) for node temperatures is obtained. This subroutine, like INDATA, probably will require changes for each different model.

Subroutine CONTROL determines whether a change has taken place in the operating mode of the control node. If a change has taken place the flags KICHNG and KIC are set, the fixed and variable node number arrays are adjusted, the time at which the node change occurs is determined, and temperatures at this time are calculated by linear interpolation. A new time increment is then determined for the remainder of the original time increment.

Descriptions of the variables found in the common blocks are given in Appendix C.

COMPUTER SYSTEM REQUIREMENTS

Most of the LASL library routines, such as DATE1, CLOCK1, LSS, SPLOT, PLOT, and DLCH, will have to be replaced by local equivalents. DATE1 and CLOCK1, which merely return real date and time values for output, could be eliminated. SPLOT, PLOT, and DLCH are used to make SC-4020 CRT files for graphic output. If no equivalent routines exist or if graphic output is not required, that section of the program may also be eliminated. The routine LSS, called from the main program and from the subroutine PRIME, is used to solve the set of linear equations, Eq. (3), for the T_j 's given the coefficients a_{ij} and b_i . Any computer facility of reasonable size should have software equivalent to LSS.

PASOLE requires a field length of 57 000 octal words for compilation and 122 000 octal words at execution including all library routines. No attempt has been made to minimize the core memory. The problems shown in Appendix E and in Figs. 2 and 3 require 4 to 5 min of CP time on a CDC 6600, or about 1 min on a CDC 7600, for a yearly calculation. Using the linearized method of Eq. (4), the execution time is reduced to about 1.5 min on a CDC 6600.

The loaders used at LASL automatically clear the registers, a feature used in PASOLE programming. Not all computer systems are set up this way, so it may be necessary to make special provisions to clear the registers. There are other differences between the CDC FORTRAN and other computer systems, such as multiple replacement statements and packed FORTRAN.

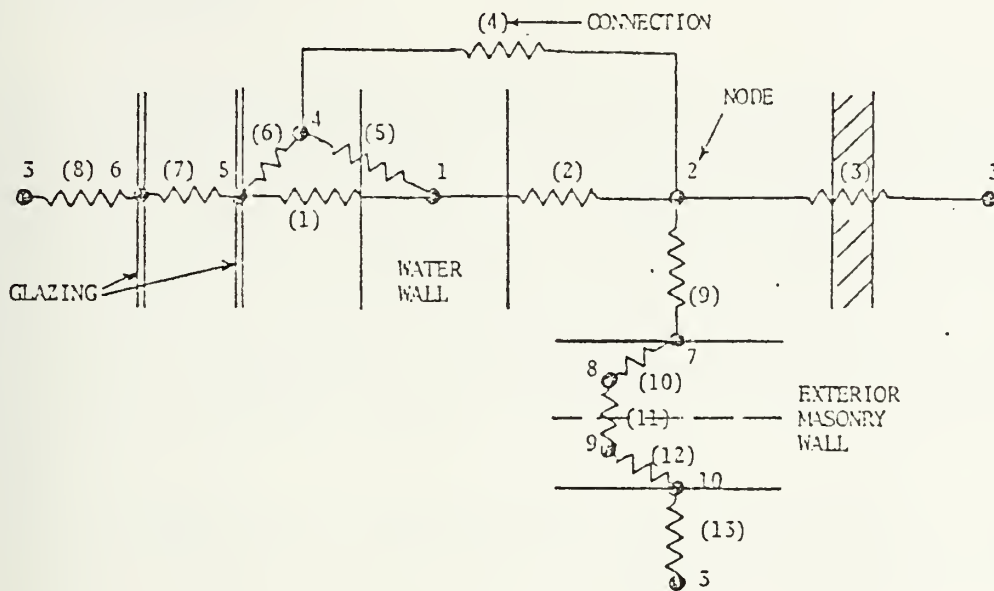

Fig. 2.

Water wall model with massive exterior wall ($KWALL = 1$, $NSGW = 2$).

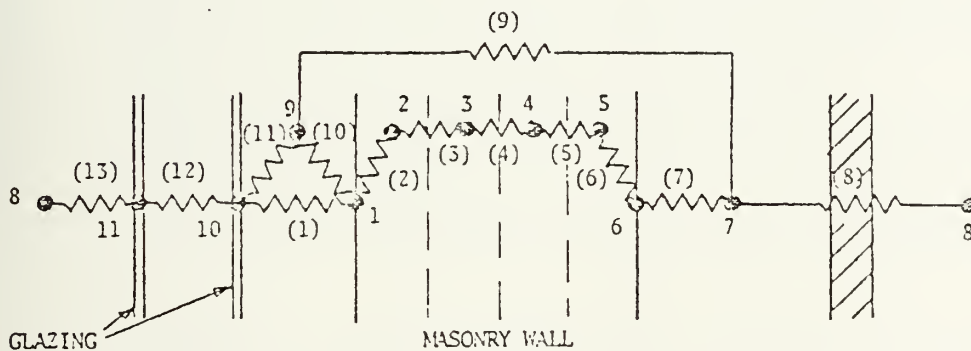

Fig. 3.

Masonry wall model ($KWALL = 2$, $NSGW = 0$).

MODELING RESTRICTIONS

For simulations in the southern hemisphere, changes to the solar angle and time equations are required. There are no restrictions on initial temperature conditions, but a small heat balance error will be observed if the initial temperatures are not in equilibrium. The initial value of the ambient temperature(s) is set to the first weather data values in SUNSRC.

The number of nodes is now limited to 50 because of dimensions. If more detail is required, a different type of simulation program probably would be better suited. The computer time required is approximately proportional to the square of the number of nodes. A model with 30 nodes takes about 40 min of CP time on the CDC 6600 for a yearly hour-by-hour calculation. This time could be reduced considerably, however, if the linearized calculational procedure, Eq. (4), could be used.

EXAMPLE MODELS

Built into subroutines INDATA and PROP of the present PASOLE version are two types of south-mass-wall (SMW) passive solar heating systems: (1) Water wall, in which the thermal storage and absorber wall are assumed to be isothermal and, therefore, representable by a single node, and (2) Trombe wall, in which the transient conduction through the SMW is modeled by several nodes in series assuming the heat flow is one dimensional. Figures 2 and 3 show the thermal network representation of these two types of SMW systems. Wall type is selected by setting the flag KWALL to 1 for a water wall and to 2 for a Trombe wall. Thermocirculation of warm air from the wall/glazing air space into the interior space is controlled by the flag KVENT, which is set to 0 for no thermocirculation, 1 for unlimited thermocirculation, 2 for backdraft prevention, and 4 for thermostatic control of the air flow. The number of glazings may be varied by changing the NGL value. The number of segments in the Trombe wall may be varied by changing the NSEG value.

The basic models have heat capacitance associated only with the SMWs. However, if the parameter NSGW is nonzero, an additional heat flow path is modeled through NSGW segments of a massive external wall, as shown in Fig. 2. This one-dimensional heat flow path, like that through the Trombe wall in Fig. 3, consists of several internal nodes that have the wall mass associated with them and massless nodes on the surfaces.

Parameters peculiar to these models and used only in INDATA and PROP are explained in the Appendix D program listing. The INDATA listing in Appendix D shows the first block of data is the set of default values for various "Program Variables." Here, program variables are defined as those set in INDATA and PROP that are needed to run the program—largely those listed in Appendix A. "Model Parameters" are defined as those used strictly in INDATA and PROP to set up the specific model, that is, to calculate values of the program variables.

After default values are set, the specific model programming begins with the setting of values for the model parameters. These values are most often changed when making parametric studies with the model. More model parameters are set further down for each wall type. Program connection parameters and node parameters then are evaluated using a methodology developed for these models. Next, constants used in PROP to evaluate temperature-dependent conductances are calculated.

The optional massive exterior wall is modeled for $NSGW > 0$ by adding nodes and connections to those set above. Next is a section for linearizing the model completely, if so desired, by calculating effective constant conductances for all connections. This linearization must be done if the simplified calculation ($KCALC = 2$) method is to be used, as explained in PRIME.

A provision for an outside insulation node on the SMW is used mostly for unglazed south wall calculations. Finally, an output listing is made for many of the model parameters and resulting program variables.

In subroutine PROP the volumetric thermocirculation flow rate is calculated for KVENT non-zero using the previously calculated temperatures, after which conductances based on this flow rate are computed. Radiation and convection conductances between glazings, wall, air space, and outside air are calculated, again using the temperatures obtained from the previous iteration. The final section of PROP, which calculates values of program variables U, COND, and SCON, should be retained regardless of the model chosen. Even when all conductances are constant, these last calculations are made in PROP. Only the night (UN) and day (UD) values of conductance are set before these last calculations are made.

SAMPLE OUTPUT

Appendix E shows output listings obtained from running the Appendix D program with the specific model parameters of Figs. 2 and 3 and using Los Alamos weather data beginning September 1, 1972. The first line of each listing in Appendix E gives real time and date, and the second line gives the model starting date. Parameter values given for "conductance connections" are connection number J; node numbers I1 and I2 (I1CON and I2CON) connected by connection J; and UD (day) and UN (night) values of conductance in $\text{Btu/h}\cdot^\circ\text{F}\cdot\text{ft}^2$ consistent with ACON, which is the connection heat transfer area per unit SMW glazing area. Positive heat flow in connection J is from node I1 to node I2. Some of the conductances are shown as zero in the listings. The zero value usually means that the conductances are temperature-dependent and have not been calculated in INDATA.

Ambient temperature node and solar heat source information is given next. Following that is a block of integers and a block of real variables, which are a combination of program variables and model parameters whose names correspond to those defined in Appendixes B, C, and D. Except for the first line in the listings, the information is generated in INDATA when the flag KHEDPR is nonzero.

The summary table, always generated at the end of the problem in the main program, gives monthly totals.

DEGDAY - heating degree days
QOUT - heat loss back through SMW glazing
QHEAT - auxiliary heat required by the control node
QCOOL - total cooling required by the control node
QSOLAR - solar radiation absorbed in primary solar source
QLOAD - building heat load for other than SMW
QACL - auxiliary cooling required
QSINC - solar radiation incident on glazing of SMW
PCTSOL - percentage of solar heating defined by $\text{PCTSOL} = 100 (1 - \text{QHEAT}/\text{QLOAD})$.

Headings given in the summary table are MTIME: total number of basic time increments (hours in this case); NSTEP: total number of time steps calculated; NCALC: total number of temperature solutions (including iterations); and KERR: number of convergence failures.

If IPRSM is nonzero, tables of the individual node and connection heat flow sums are printed. These sums are defined in Appendix C. Heat flows are given in Btu/ft^2 of SMW glazing.

In addition to the printed output, graphic output can be obtained using LASL library routines. Graphic output is generated starting when DATE is equal to IO1 through the day before IO2. Examples of plots for the model of Fig. 3 are shown in Appendix E (Figs. E-1 and E-2) for the same Los Alamos weather data as above, December 31, 1972, through January 6, 1973: (IO1 = 123172, IO2 = 10773). Figure E-1 shows the time variation of the temperatures of nodes 1, 6, 8, and 7. Figure E-2 shows the rate of solar radiation absorption in node 1 (the primary solar heat source), the rate of heat flow through connection 8 (the heat load), the total heat flow into the room through connections 7 and 9, and the total heat loss from the south side through connections 1 and 11.

Further results obtained using PASOLE may be found in Refs. 3 and 4.

ACKNOWLEDGMENTS

The idea for a simulation program of this type was J. D. Balcomb's. J. C. Hedstrom wrote a preliminary one-mass-node simulation program. Robert Sutton of the Tasmanian College of Advanced Education, Robert Jones of the University of South Dakota, and William Wray of LASL made helpful suggestions arising from their development of PASOLE models for particular applications.

REFERENCES

1. ASHRAE Handbook, 1974 Applications Volume, Chap. 59.
2. E. Roes, "Estimating the Direct Component of Solar Radiation," Sandia Laboratories report SAND-75-0565 (November 1975).
3. R. P. Stromberg and S. O. Woodall, "Passive Solar Buildings: A Compilation of Data and Results," Sandia Laboratories report SAND-77-1204 (August 1977).
4. J. D. Balcomb and R. D. McFarland, "A Simple Empirical Method for Estimating the Performance of a Passive Solar Heated Building of the Thermal Storage Wall Type," Proc. 2nd Nat. Passive Solar Conf., Philadelphia, PA, March 16-18, 1978.

APPENDIX A EQUATIONS FOR SOLAR RADIATION

1. Solar declination (deg)[†]
 $DEC = 23.279 \cdot \cos [30 \cdot (MO - 1 + DAY/32 - 5.7)]$,
where MO = month of year (MO = 6 for June, etc.) and
DAY = day of month.
2. Extraterrestrial normal solar radiation[†]
 $QSP = A1 - A2 \cdot \sin [360 \cdot (272.1 + IDAY)/365]$,
where A1 = 426.98, A2 = 13.50 for QSP in Btu/h-ft²,
A1 = 1346.1, A2 = 42.56 for QSP in W/m², and
IDAY = day of year.
3. Equation of time (EOT) is given in tabular form, one value per month (min)

MO	1	2	3	4	5	6
EOT	-11.2	-13.9	-7.5	1.1	3.3	-1.4
MO	7	8	9	10	11	12
EOT	-6.2	-2.4	7.5	15.4	13.8	1.6

[†]Curve fit of data in Ref. 2 by J. C. Hedstrom.

4. Solar time (h)
 $SUNTIME = TIME + EOT/60 - DLONG/15 - 0.5$,
 where TIME = local standard time, and
 DLONG = difference between local longitude and standard time meridian (deg).
 (0.5 is subtracted when insolation data are averaged over the preceding hour.)
5. Hour angle (deg)
 $HR = 15 \cdot (12 - SUNTIME)$
6. Critical hour angle (hour angle for which solar azimuth is 90°)
 $COS(HRCRIT) = TAN(DEC)/TAN(LAT)$
 with constraint that $0 \leq COS(HRCRIT) \leq 1$.
7. Sun altitude (deg)
 $SIN(ALT) = COS(LAT) \cdot COS(DEC) \cdot COS(HR) + SIN(LAT) \cdot SIN(DEC)$,
 where LAT = latitude (deg).
8. Sun azimuth (deg)
 $SIN(AZI') = COS(DEC) \cdot SIN(HR)/COS(ALT)$
 AZI' will always be between -90° and $+90^\circ$.
 To find the true value of the azimuth, AZIM
 If $|HR| \leq HRCRIT$, $AZIM = AZI'$, and
 if $|HR| > HRCRIT$, $AZIM = (180 - |AZI'|) \cdot AZI'/|AZI'|$.
9. Boes correlation² for direct normal and diffuse radiation measurements
 - (a) $PP = QH/[QSP \cdot SIN(ALT)]$,
 where QH is total horizontal radiation.
 - (b) $FQDN = 1.79 \cdot PP - 0.55$ with constraint
 that $0 \leq FQDN \leq 1.0$.
 - (c) $QDN = FQDN \cdot QDNMAX$,
 where QDN = direct normal radiation and
 $QDNMAX = 1000 \text{ W/m}^2 = 317.2 \text{ Btu/h-ft}^2$.
 - (d) $QDIF = QH - QDN \cdot SIN(ALT)$,
 where QDIF = sky diffuse radiation.
10. Wall/solar azimuth (deg)
 $GAM = AZIM - WAZI$,
 where WAZI is the wall azimuth; 0 when facing south and positive when facing east of south.
11. Wall/solar angle of incidence (deg)
 $COS(INC) = COS(ALT) \cdot SIN(TILT) \cdot COS(GAM) + SIN(ALT) \cdot COS(TILT)$, where TILT
 is wall tilt from horizontal—positive toward south, and $0 \leq INC \leq 90^\circ$.
12. Radiation incident on wall from specular reflector. The equations are only for a horizontal
 reflector adjacent to a vertical wall. East-west dimensions of wall and reflector assumed
 equal. See also item 14.
 - (a) $RLEFF = COS(GAM)/TAN(ALT)$.
 If $RLEFF > RLNGTH$, RLEFF is set equal to RLNGTH, where RLNGTH is the ratio of
 the reflector length (N-S) to the wall height.

- (b) $DWOW = RLEFF \cdot \tan(GAM) / ASPRAT$, where $ASPRAT$ is the ratio of the reflector width (E-W) to its length (N-S).
- (c) $ASR = RLEFF \cdot (1 - DWOW/2)$ if $DWOW \leq 1$,
 $ASR = 0.5 \cdot ASPRAT / \tan(GAM)$ if $DWOW > 1$.
- (d) $QINSR = QDN \cdot ASR \cdot RHOSR \cdot \sin(ALT)$, where $QINSR$ = reflected radiation incident on wall, $RHOSR$ = reflectivity of reflector.

13. Shading from overhang†

$AFACT$ is the ratio of direct normal radiation incident on wall with overhang to that without overhang (Fig. A-1).

$$AFACT = 1 - [OHANG \cdot \tan(BEFF) - OSEPR] / [\sin(TILT) + \cos(TILT) \cdot \tan(BEFF)]$$

Constrained: $0 \leq AFACT \leq 1$, where $\tan(BEFF) = \tan(ALT) / \cos(GAM)$.

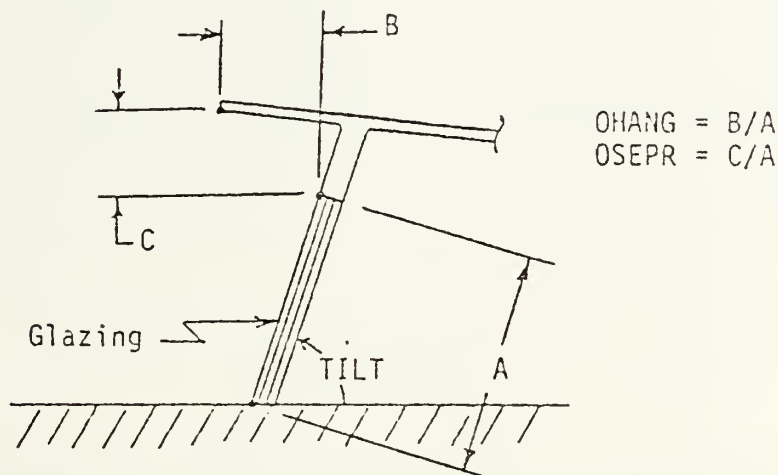

Fig. A-1.
Overhang geometry.

14. Total radiation incident on wall (collector)

$$QINC = QINDN + QINSR + QINDF + QINRF.$$

(a) $QINDN$ is incident direct radiation

$$QINDN = QDN \cdot AFACT \cdot \cos(INC).$$

(b) $QINSR$ is incident reflected direct radiation (see item 12.d).

(c) $QINDF$ is incident sky diffuse radiation

$$QINDF = QDIF \cdot [1 + \cos(TILT)] / 2$$

(assuming infinite horizon).

(d) $QINRF$ is incident reflected diffuse—includes diffuse ground reflection with infinite horizon and specular reflection of sky diffuse radiation.

$$QINRF = QH \cdot RHO \cdot (0.5 \cdot [1 - \cos(TILT)] \cdot FCSR) + QDIF \cdot FCSR \cdot RHOSR,$$

where RHO = diffuse ground reflectivity, $FCSR$ = view factor between wall and specular reflector.

For this reflector model (see item 13)

$$FCSR = 0.5 (RLNGTH + 1 - \sqrt{RLNGTH^2 + 1}) \text{ approximately.}$$

†Assumed to be infinite in E-W dimension (no end effects).

15. Transmission through glazings

$$QTRAN = [(QINDN + QINSR) \cdot TRANS \cdot GLABS + (QINDF + QINRF) \cdot DTRANS \cdot DGLABS] \cdot TRCOAT$$

(a) TRANS = transmission resulting from surface reflection losses only

$$TRANS = 0.5 \cdot (T1 + T2),$$

$$\text{where } T1 = (1 - R1) / [1 + R1 \cdot (2 \cdot NGL - 1)],$$

$$T2 = (1 - R2) / [1 + R2 \cdot (2 \cdot NGL - 1)],$$

$$R1 = \{ \text{SIN}(INC - AREF) / \text{SIN}(INC + AREF) \}^2,$$

$$R2 = \{ \text{TAN}(INC - AREF) / \text{TAN}(INC + AREF) \}^2,$$

$$\text{SIN}(AREF) = \text{SIN}(INC) / \text{RINDEX},$$

NGL = number of glazings in series, and

RINDEX = refractive index of glazing surfaces.

(b) GLABS = transmission resulting from absorption in the glazings only[†]

$$GLABS = \text{EXP} [-EX \cdot TGLZ \cdot NGL / \text{COS}(AREF)],$$

where EX = glazing material extinction coefficient, and

TGLZ = thickness of one glazing layer.

(c) TRCOAT = transmission of one glazing coating.

(d) TRANS and GLABS are for direct or beam radiation. An approximation to the transmission for diffuse radiation (DTRANS and DGLABS) is found by setting the angle of incidence (INC) to 60° in (a) and (b) above.

[†]The variable GLABS in Appendix D is transmission for a single glazing layer.

APPENDIX B BASIC INPUT DATA ,

The basic input data must be entered into the program by the INDATA and PROP sub-routines. Some parameters have internally set "default" values (shown in brackets). Use of the units must be consistent; either ASHRAE units (Btu, ft, h, °F) or S.I. units (W, m, s, °C) may be used with no significant changes. Frequently, many of the data are calculated from other input data in the subroutine INDATA, which is executed at the beginning of the problem. Some of the data (such as U values) may vary during the problem. In this case the data are recalculated in the subroutine PROP, which is within the time and iteration loops.

(A) Nodes (I)—I values not necessarily contiguous, but max I must be ≤ NMAX, which is currently 50.

KF(I): 0 for no node

1 for variable-temperature node

[0]

2 for fixed-temperature node

T(I): Node temperature—initial values must be specified for all nodes. For fixed-temperature nodes, T(I) must be specified for all time steps.

CPM(I): Mass-heat capacity [heat capacitance, M in Eq. (1)]

S(I) Heat source = S(I) + SP (I) · T(I)

[0]

SP(I) See Eq. (1)

(B) Connections (J)—J values should be contiguous starting with 1.

NCONN: Number of connections (Js)

I1CON(J) } Nodes connected by thermal connection J
 I2CON(J) }
 UD(J) } Day and night specific conductance
 UN(J) } values of connection
 ACON(J): Heat flow area of connection
 U(J) is set to UD(J), if TMORN < TIME < TEVEN; UN(J) otherwise.
 Then the conductance is COND (I1,I2) = U(J)*ACON(J),
 where I1=I1CON(J), I2 = I2CON(J).

(C) Solar heat sources

NJS: Number of solar heat sources
 ISOL(J): Node number of solar heat source J
 TILT(J): Collector tilt angle from horizontal for solar heat source J (deg)
 WAZIM(J): Collector wall azimuth of source J (deg)
 ALFA(J): Receiver solar absorptivity for source J
 AGLZ(J): Glazing area for source J
 NGLZ(J): Number of glazings in series for source J
 OHANG(J): Overhang divided by glazing height (see Fig. A-1)
 OSEPR(J): Overhang vertical separation divided by glazing height (see Fig. A-1)
 TGLZ(J): Glazing thickness (feet or meter per layer)
 DABS(J): Glazing diffuse absorptivity per layer

(D) Ambient temperature nodes

NJA: Number of ambient temperature nodes
 IAMB(J): Node number of Jth ambient temperature node

(E) Integers

IC: Node number of control node
 IDPERYR: Number of days per year [365]
 INDATE: Initial date for which calculations start—of form MMDDYY,
 where MM is month, DD is day of month, YY is year
 IO1 } Beginning and ending dates of hourly print and
 IO2 } film plots (IO2 is day after last day) [0]
 IPRSM: Nonzero for print of all heat flow sums [0]
 ITMAX: Maximum number of iterations per time step [1]
 KAUXCL: = 0 for no auxiliary cooling (that is, no cooling
 when TAMB > TCMAX) [1]
 ≠ 0 for auxiliary cooling
 KCALC: 1 for standard solution [Eq. (3)]
 2 for simplified solution [Eq. (4)] [1]
 see comments in PRIME
 KCONU: 0 for variable conductances
 1 for constant conductances [0]
 see comments in PRIME
 KCTY: Flag for weather data format (see subroutine DAYLY)
 KDATA: = 0 for daily data (ambient temperature, wind velocity,
 solar radiation) read from tape (TAPE1)
 ≠ 0 for data from other source [0]

KDELTA:	= 0 for no subdividing of basic time increment ≠ 0 standard subdividing	[1]
	see comments in PRIME	
KFILM:	= 0 for no film plots ≠ 0 film plots	[0]
KHEDPR:	= 0 for no printout of INDATA information ≠ 0 print	[1]
MOSH1 } MOSH2 }	Beginning and ending months of summer period when night insulation operation is reversed †	[13, 0]
NDAY1:	Number of sequential daily calculations if < NDAY (MO)	[32]
NDAY(MO):	Number of days in month MO [set in data statement—if IDPERYR = 366, NDAY(2) is reset to 29]	
NHOUR:	Number of time increments on each film plot frame	[168]
NMAX:	Max number of nodes, that is, dimension	[50]
NMO:	Number of successive monthly calculations	
NTIME:	Number of time increments per day: $\Delta t = t/NTIME$, where Δt is time increment length and t is total number of time units per day (DELTA1 and TPERDAY)	[24]
PRINTD:	= 0 no daily print ≠ 0 daily print	[0]
PRINTH:	= 0 no hourly print ≠ 0 hourly print	[0]
PRINTM:	= 0 no monthly print ≠ 0 monthly print	[0]
UNITS:	= 1: Btu, h, ft, °F (ASHRAE units) = 2: J, s, m, °C (S.I. units)	[1]

(F) Real variables

ALAT:	Latitude of locality (deg)	
ASPRAT:	Specular reflector aspect ratio (E-W to N-S)	
AZIMC:	Pyranometer ^{††} "wall azimuth" (deg)	[0]
DLONG:	Local longitude minus standard time meridian (deg)	
EX:	Extinction coefficient of glazing material (ft^{-1})	[6.0]
FAC:	f in Eq. (2a)	[0.5]
FACI:	Same as FAC for heat flow integrals	[0.5]
FCSR:	View factor between collector and specular reflector	[0]
QDNMAX:	Maximum direct normal insolation in direct/diffuse correlation for measured data (Btu/h-ft^2 or W/m^2)[317.2 for UNITS = 1, 1000 for UNITS = 2]	
QHCONV:	Conversion factor from weather data insolation	
QICUT:	Value of incident solar radiation below which night insulation is applied	$[-1 \times 10^6]$
RDIF(NGL):	Reflectance of glazings for NGL glazings in series for <i>diffuse</i> radiation (0.16, 0.24, 0.29, 0.33, 0.35)	
RESNI:	Resistance of night insulation on collector $^{\circ}\text{F}/(\text{Btu/h-ft}^2)$ or $^{\circ}\text{C}/(\text{W/m}^2)$	
RHO:	Diffuse reflectivity of ground or other external reflector	[0.3]
RHOC:	Same for pyranometer ^{††}	[0.3]

†Night insulation is applied when $\text{TIME} \geq \text{TEVEN}$ and $\text{TIME} \leq \text{TMORN}$ for winter period.

††Pyranometer for which weather data insolation is given

RHOSR:	Reflectivity of specular reflector	[0]
RINDEX:	Refractive index of glazings	[1.526]
RLNGTH:	Specular reflector length (N-S) divided by glazing height	[0]
SBCON:	Stefan-Boltzmann constant (1.7132×10^{-9} Btu/h-ft ² -°F ⁴ or 5.67×10^{-8} W/m ² -°C ⁴)	
TBASE:	Base temperature for heating degree-days (65°F or 18°C)	
TCMAXD:	Max allowable control node temperature for day	
TCMAXN:	Max allowable control node temperature for night	
TCMIND:	Min allowable control node temperature for day (°F or °C)	
TCMINN:	Min allowable control node temperature for night (°F or °C)	
TEVEN:	Time at which "night" starts	[17 h]
TILTC:	Tilt of pyranometer [†] (degree from horizontal)	[0]
TMORN:	Time at which "daytime" starts	[7 h]
TOLT:	Tolerance on temperature iteration (°F or °C)	[1.0]
TPERDAY:	Number of time units per day	[24 h/day or 86 400 s/day]
TRCOAT:	Transmission of coating on inner surface of inner collector glazing	[1.0]
TZERO:	Difference between zero and absolute zero on temperature scales	[460°F or 273°C]

[†]Pyranometer for which weather data insolation is given.

APPENDIX C PARAMETERS IN COMMON

All parameters in Appendix B are also in COMMON. Starred parameters must be generated in DAYLY (weather data). Routines in brackets are where parameter is calculated.

A(I,J)	Temperature coefficients in Eq. (3)	[MAIN]
B(I)	Source terms in Eq. (3)	[MAIN]
COND(I,J)	Conductance of connection between nodes I and J K_{ij} in Eq. (1)	[PROP]
COSDEC	COS(DEC)	[DAYLY]
COSLAT	COS(ALAT)	[PRIME]
COSTC	COS(TILTC)	[PRIME]
DATE	Integer date of same form as INDATE (see Appendix B)	[DAYLY]
DAY	Index of day loop in main program (integer day of month)	[MAIN]
DAY1	First day in day loop (integer)	[MAIN]
DAY2	Last day in day loop (integer)	[MAIN]
DD	Heating degree days	[DAYLY]
DEC	Solar declination (deg)	[DAYLY]
DEGRAD	$\pi/180$ —conversion from degrees to radians	[MAIN]
DELT	Current time increment	[MAIN]
DELT1	Basic time increment	[PRIME]

ERRT(I)	Deviation of node temperature between successive iterations	[MAIN]
FD(I,J,K) } FN(I,J,K) }	Coefficients F_{ij} in Eq. (4) for "day" and "night" K = 1 for IC a variable-temperature node; K = 2 for IC a fixed-temperature node	[PRIME]
FRAC	Fraction of DELT since beginning of time increment or last control mode change	[CONTROL]
FSGC	View factor between pyranometer and ground	[PRIME]
FSSC	View factor between pyranometer and sky	[PRIME]
HRCRIT	Hour angle at which azimuth is 90°	[DAYLY]
IAIR†	(For SMW models) node number of air in glazing/wall space	[INDATA]
IDAY	Day of year	[PRIME,MAIN]
INDAY	Initial day of month (from INDATE)	[PRIME]
ISOLX(IH)*	Weather data time offset (see equation for SUNTIME in Appendix D, subroutine SUNSRC)	[DAYLY]
ITIME	Index of time increment loop	[MAIN]
IXFILM	Index of film plot arrays	[MAIN]
JAIR†	Number of connection between IAIR and IC	[INDATA]
JCP†	Connection number of nonmass-associated load	[INDATA]
JCW†	Connection number of mass-associated load	[INDATA]
JWA†	Connection number between mass-wall surface node and IAIR. This is the first in a sequence of connections from the wall through the glazings to which glazing conductance calculations are keyed	[INDATA]
KCOOL	= 0 for no night insulation = 1 for winter operation = -1 for summer operation (see MOSH1, MOSH2 in Appendix B)	[MAIN]
KIC	Control node mode indicator -1 for T(IC) at TCMIN limit, QCIN > 0 0 for TCMIN < T(IC) < TCMAX, QCIN = 0 + 1 for T(IC) at TCMAX limit, QCIN < 0 + 2 for T(IC) fixed for all time (TCMIND = TCMAXD, TCMINN = TCMAXN)	[CONTROL] [PRIME]
KICHNG	= 0 for no mode change = for mode change	[CONTROL]
KND	= 1 for night = 2 for day (TMORN < TIMEX < TEVEN)	[MAIN]
KSHUT	= KCOOL for night = -KCOOL for day	[MAIN]
KVENT†	Night insulation is used if KSHUT = + 1 = 0 for no thermocirculation 1 for unlimited thermocirculation 2 for thermocirculation with backdraft dampers 4 for thermocirculation with thermostatic control	[INDATA]

†For SMW models.

KWALL [†]	= 1 for water wall model = 2 for Trombe wall model	[INDATA]
LF(IF)	Array of fixed-temperature nodes	[PRIME]
LT(IT)	Array of all nodes	[PRIME]
LV(IV)	Array of variable-temperature nodes	[PRIME]
MO	Current month number (MO = 1 for January, etc.) The month loop index is MONTH, which always goes from 1 to NMO	[MAIN]
MO1	Initial value of MO, from INDATE	[PRIME]
MTIME	Number of basic time increments from beginning of problem	[MAIN]
NERR	Number of nodes not converging	[MAIN]
NF	Number of fixed-temperature nodes	
NPR1,NPR2	First and last problem numbers	[MAIN]
NPROB	Index of problem loop	[MAIN]
NT	Number of nodes, total	
NV	Number of variable temperature nodes	
PI	π	[MAIN]
QACL	Integral auxiliary cooling of control node	[MAIN]
QAHT	Integral auxiliary heating of control node	[MAIN]
QC12(J)	Net heat rate through connection J [positive from node I1CON(J) to node I2CON(J)]	[MAIN]
QCIN	Heat source or sink applied to control node to maintain temperature limits	[MAIN]
QCINO	QCIN from previous time step	[MAIN]
QCINT	Integral of QCIN over one time step	[MAIN]
QCON(I)	Net heat rate conducted into node I	[MAIN]
QFACO(I)	Time rate of temperature change of node I, previous time step	[MAIN]
QHD(IH)*	Weather data insolation (pyranometer data)	[DAYLY]
QHZ	QHD(IH) converted to correct units	[SUNSRC]
QINC	Solar heat flux incident on collector (primary solar heat source)	[SUNSRC]
QSP	Normal, extraterrestrial solar radiation	[DAYLY]
QSRC(I)	Net heat source rate in node I	[MAIN]
QTRAN	Solar heat flux transmitted through collector glazing(s)	[SUNSRC]
QVCL	Integral vent cooling of control node	[MAIN]
QVHT	Integral vent heating of control node	[MAIN]
RCON(I) [†]	Array of constants generated in INDATA for use in PROP, or just for general use	[INDATA]
REMAIN	Remaining fraction of basic time increment	[CONTROL]
RHD(IH)*	A fourth weather data parameter (relative humidity in some cases)	[DAYLY]
SCON(I)	Sum of conductances (COND) of connections to node I	[PRIME, PROP]
SINDEC	SIN(DEC)	[DAYLY]
SINLAT	SIN(ALAT)	[PRIME]

[†]For SMW models.

SINTC	SIN(TILTC)	[PRIME]
SQCON1(I), SQCON2(I)	Integrals of positive and negative values of QCON(I) over time	[MAIN]
SQC121(I), SQC122(I)	Integrals of positive and negative values of QC12(I) over time.	[MAIN]
SQSRC1(I), SQSRC2(I)	Integrals of positive and negative values of QSRC(I) over time.	[MAIN]
TAD(IH)*	Weather data—ambient temperature	[DAYLY]
TAMB	Ambient temperature	[SUNSRC]
TBAR	Daily average ambient temperature	[DAYLY]
TCMAX	Maximum allowable control node temperature	[MAIN]
TCMIN	Minimum allowable control node temperature	[MAIN]
TCOOL	Threshold ambient temperature above which any cooling of control node cannot be done by venting. Now set equal to TCMAX	[MAIN]
TIME	Time of day in consistent units	[MAIN]
TIMEX	Time of day in hours	[MAIN]
TMAX	Daily maximum ambient temperature	[DAYLY]
TMIN	Daily minimum ambient temperature	[DAYLY]
TO(I)	Node temperature from previous time step	[MAIN]
U(J)	Conductance per unit area of connection J	[PROP]
VELD(IH)*	Weather data—wind velocity	[DAYLY]
VOLF†	Thermocirculation volumetric flow rate	[PROP]
YR	Two-digit year number	[DAYLY]

†For SMW models.

APPENDIX E
SAMPLE OUTPUT

PADLE - PASSIVE SOLAR ENERGY 20.28.34 78-08-04

WATER WALL - PER UNIT WALL AREA - INDATE= 90172 ULOAD= 1.000

CONDUCTANCE CONNECTIONS

J	I1	I2	UD	UN	ACDN
1	1	5	0.	0.	1.0000E+00
2	1	2	1.5000E+00	1.5000E+00	1.0000E+00
3	2	3	7.0492E-01	7.0492E-01	1.0000E+00
4	4	2	0.	0.	1.0000E+00
5	1	4	0.	0.	1.0000E+00
6	4	5	0.	0.	1.0000E+00
7	5	6	0.	0.	1.0000E+00
8	6	3	0.	0.	1.0000E+00
9	2	7	1.5000E+00	1.5000E+00	3.0000E+00
10	7	8	3.2000E+00	3.2000E+00	3.0000E+00
11	8	9	1.8000E+00	1.8000E+00	3.0000E+00
12	9	10	3.2000E+00	3.2000E+00	3.0000E+00
13	10	3	1.2121E-01	1.2121E-01	3.0000E+00

AMBIENT TEMPERATURE NODES

I= 3

SOLAR HEAT SOURCES

J	ISOL	NSLC	TILT	MAZIM	ALFA	AGLZ	DHANG	DEFP	TGLC	DARS
1	1	2	90.00	0.00	1.0000	1.00	0.0000	0.0000	.0104	.0731

NMAX	IC	NTIME	NSGS	NMD	NDAY1	ITMAX	UNITS	KDATA
50	2	24	-1	12	32	30	1	0
KWALL	KCALC	KDEL	KCONU	KCTY	KSGM	KFILM	KRACL	KVENT
1	1	1	0	1	2	0	1	0
JCP	JCM	JMA	JRIP	JRIP				
3	13	5	4	4				

OHCONV	ALAT	DLONG	PINDEX	TMOFN	TEVEN
2.2120E+02	3.5800E+01	1.3000E+00	1.5260E+00	7.0000E+00	1.7000E+01
TZERO	ODHAY	PHO	EX	FAC	TOLT
4.8000E+02	3.1720E+02	3.0000E-01	6.0000E+00	5.0000E-01	1.0000E+00
TCMINN	TCMINO	TILTC	ACINC	PHOC	FACI
6.5000E+01	6.5000E+01	0.	0.	3.0000E-01	5.0000E-01
TCMAXD	THCON	THICK	VOLSP	ULOAD	PECHI
7.5000E+01	0.	0.	0.	1.0000E+00	0.
PLNGTH	PHOIP	ASPRAT	FCSP	CPMP	P3MMI
0.	0.	0.	0.	4.5000E+01	0.
PMINS	UMOUT	THOM	THFM	VSPM	AM
8.0000E+00	1.2121E-01	8.0000E-01	1.0000E+00	3.0000E+01	3.0000E+00

SUMMARY -- RTIME= 8760 NITER= 9176 NCALL=15791 FEPP= 0

NO	DOB	DRY	QOUT	QHEAT	QCOOL	QDOLAP	QLOAD	QACL	QSHC	PCTCOL
9	209	9386	0	-1378	32523	10837	-25	36013	100.00	
10	506	11014	5296	-824	19893	15625	0	29903	66.10	
11	1032	15417	14668	0	26615	25068	0	38318	41.49	
12	1144	17547	16210	0	28942	38071	0	41073	42.25	
1	1202	18568	15788	0	32656	29524	0	46646	46.53	
2	982	14857	13892	0	25244	24076	0	37263	42.30	
3	980	14260	16511	0	21153	23878	0	33184	30.85	
4	759	11818	11447	0	19141	18458	0	32612	37.96	
5	366	7550	3263	0	14714	10416	0	25549	68.63	
6	123	5530	353	-2572	14674	6906	-1808	25737	94.97	
7	28	5322	0	-3120	13041	6231	-1831	22662	100.00	
8	16	5979	0	-4931	16517	6249	-2647	26555	100.00	
SUMS	7350	137248	97428	-12723	255112	204941	-6311	397515	52.46	

TOTALS QVHT QVCL QHHT QACL DD
 0. -6.4120E+03 9.7428E+04 -6.3109E+03 7.3505E+03

I	SOSSPC1	SOSSPC2	SQCDN1	SQCDN2
1	2.5511E+05	0.	0.	-2.5460E+05
3	0.	0.	3.8404E+05	-8.5103E+02
4	0.	0.	1.2782E-09	-6.5009E-10
5	1.9614E+04	0.	7.9994E-01	-1.9636E+04
6	2.4423E+04	0.	6.6182E+01	-2.4610E+04
7	0.	0.	3.9100E-04	0.
8	0.	0.	8.5781E+03	-8.5055E+03
9	0.	0.	9.2963E+03	-9.2595E+03
10	0.	0.	1.5366E-10	-2.7273E+00
2	0.	0.	1.2723E+04	-9.7494E+04

J	I1	I2	SQC121	SQC122
1	1	5	8.5892E+04	-3.5300E+02
2	1	2	1.1320E+05	-1.3455E+03
3	2	3	1.4403E+05	-1.6576E+03
4	4	2	0.	0.
5	1	4	5.1905E+04	-1.9536E+02
6	4	5	5.1905E+04	-1.9536E+02
7	5	6	1.5689E+05	-8.9034E+00
8	6	3	1.8143E+05	0.
9	2	7	6.1419E+04	-1.7864E+03
10	7	8	6.1419E+04	-1.7864E+03
11	3	9	5.9717E+04	-9.7895E+01
12	9	10	6.0909E+04	-1.3248E+03
13	10	3	6.0910E+04	-1.3248E+03

END OF FILE

TROMBE WALL - PER UNIT WALL AREA - INCLATE= 90172 ULOAD= 1.000

CONDUCTANCE CONNECTION

J	I1	I2	UD	UN	ACON
1	1	10	0.	0.	1.0000E+00
2	1	2	5.3333E+00	5.3333E+00	1.0000E+00
3	2	3	2.6667E+00	2.6667E+00	1.0000E+00
4	3	4	2.6667E+00	2.6667E+00	1.0000E+00
5	4	5	2.6667E+00	2.6667E+00	1.0000E+00
6	5	6	5.3333E+00	5.3333E+00	1.0000E+00
7	6	7	1.5000E+00	1.5000E+00	1.0000E+00
8	7	8	1.0000E+00	1.0000E+00	1.0000E+00
9	9	7	0.	0.	1.0000E+00
10	1	9	0.	0.	1.0000E+00
11	9	10	0.	0.	1.0000E+00
12	10	11	0.	0.	1.0000E+00
13	11	8	0.	0.	1.0000E+00

AMBIENT TEMPERATURE NODES

I= 8

SOLAR HEAT SOURCES

J	ISOL	NGLC	TILT	MAZIM	ALFA	AGLC	ORANG	DEPRP	TGLC	DABS
1	1	2	90.00	0.00	1.0000	1.00	0.0000	0.0000	.0104	.0731

NMAX	IC	HTINE	NSEG	NMO	NDAY1	ITMAX	UNITS	KDATA
50	7	24	4	12	32	30	1	0
KMALL	KCALC	KDELTA	KCONU	KCTY	KSGM	KFILM	KRUXCL	KVENT
2	1	1	0	1	0	0	1	2
JCF	JCM	JMA	JRIP	JRIP				
8	0	10	9	9				

QHCONV	ALAT	DLONG	PINDEX	TMOFN	TEVEN
2.2120E+02	3.5800E+01	1.3000E+00	1.5260E+00	7.0000E+00	1.7000E+01
TZERO	QDNMAX	FHD	EK	FAC	TOLT
4.8000E+02	3.1720E+02	3.0000E-01	6.0000E+00	5.0000E-01	1.0000E+00
TOMIN	TOMINP	TILT0	AZINC	FHOC	FACI
6.5000E+01	6.5000E+01	0.	0.	3.0000E-01	5.0000E-01
TOMAX	THCON	THICK	VOLIP	ULOAD	FESNI
7.5000E+01	1.0000E+00	1.5000E+00	3.0000E+01	1.0000E+00	0.
PLNGTH	FHOCF	RCPAT	FCIF	CPMP	PSNMI
0.	0.	0.	0.	4.5000E+01	0.

SUMMARY -- NTIME= 8760 NSTEP= 9808 NCALC=18478 KERR= 0

NO	DEG DRY	QOUT	QHEAT	QCDOL	QSLAP	QLOAD	QACL	Q3INC	PCTIOL
9	209	8151	482	-4914	38837	9414	-117	36013	94.88
10	506	10139	7290	-3964	30047	15096	0	29903	51.71
11	1032	15538	15841	-329	26671	25496	0	39318	39.06
12	1144	17405	17953	-878	26771	29005	0	41073	38.10
1	1202	18460	17688	-1046	32410	30603	0	46646	42.20
2	982	14850	15187	-621	25121	24914	0	37263	39.04
3	980	14229	17413	-268	21062	24426	0	33184	28.71
4	759	12109	12516	-100	19121	19320	0	32612	35.01
5	366	7945	4866	-222	14735	10882	-109	25549	55.10
6	123	4916	973	-5057	14716	6057	-3880	25737	83.93
7	38	4253	65	-4936	13062	4962	-3367	22662	98.89
8	16	4518	48	-7625	16613	5021	-5512	28555	39.04
SUMS	7350	132409	110342	-29560	255166	205635	-12985	397515	46.34

TOTALS QVHT QVCL QHAT QACL ID
 0. -1.6575E+04 1.1034E+05 -1.2985E+04 7.3505E+03

I	SOSPC1	SOSPC2	SOC0N1	SOC0N2
1	2.5517E+05	0.	8.3652E+00	-2.5538E+05
2	0.	0.	8.3428E+04	-8.3180E+04
3	0.	0.	3.7151E+04	-3.7056E+04
4	0.	0.	1.9622E+04	-1.9587E+04
5	0.	0.	1.1982E+04	-1.1958E+04
6	0.	0.	3.3353E-06	-1.5566E-06
8	0.	0.	3.8105E+05	-7.8626E+02
9	0.	0.	3.1177E+02	-1.9676E+02
10	1.9614E+04	0.	2.3788E-01	-1.9636E+04
11	2.4419E+04	0.	8.2229E+01	-2.4865E+04
7	0.	0.	2.9718E+04	-1.1098E+05

J	I1	I2	SOC121	SOC122
1	1	10	1.0108E+05	0.
2	1	2	1.3242E+05	-9.1973E+04
3	2	3	6.8922E+04	-2.8724E+04
4	3	4	4.5503E+04	-5.3708E+03
5	4	5	4.1443E+04	-1.3451E+03
6	5	6	4.3531E+04	-3.4472E+03
7	6	7	4.3521E+04	-3.4472E+03
8	7	8	2.0584E+05	-2.1930E+03
9	9	7	8.2407E+04	-1.3447E+00
10	1	9	1.1385E+05	0.
11	9	10	3.7808E+04	-6.4782E+03
12	10	11	1.5213E+05	-8.2615E+01
13	11	8	1.7684E+05	-1.4941E+01

END OF FILE

LAST DAY = 10573

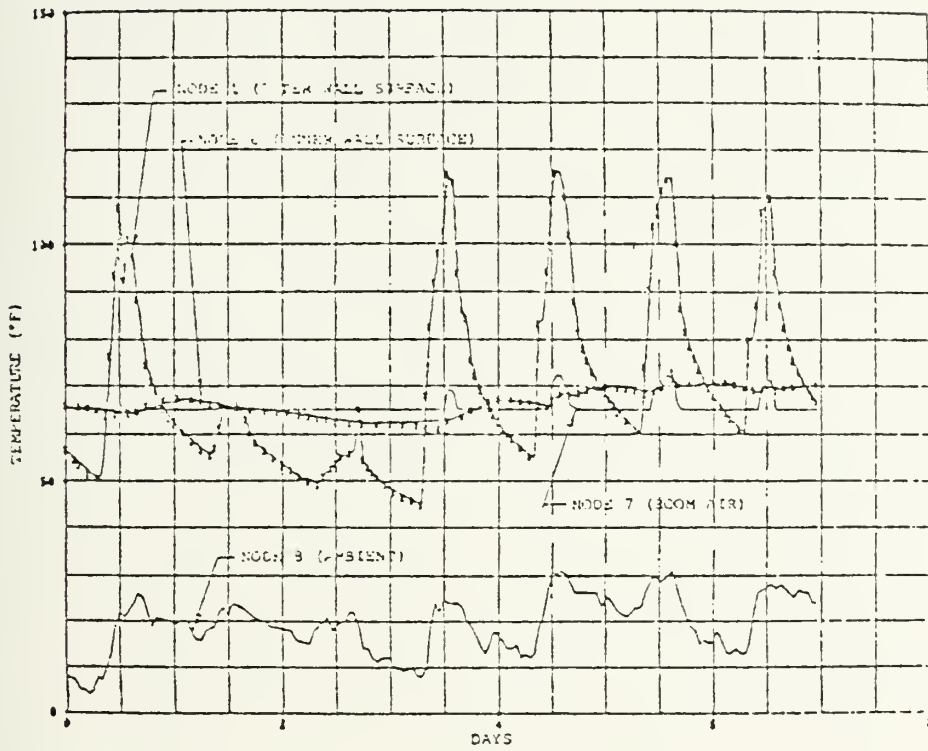
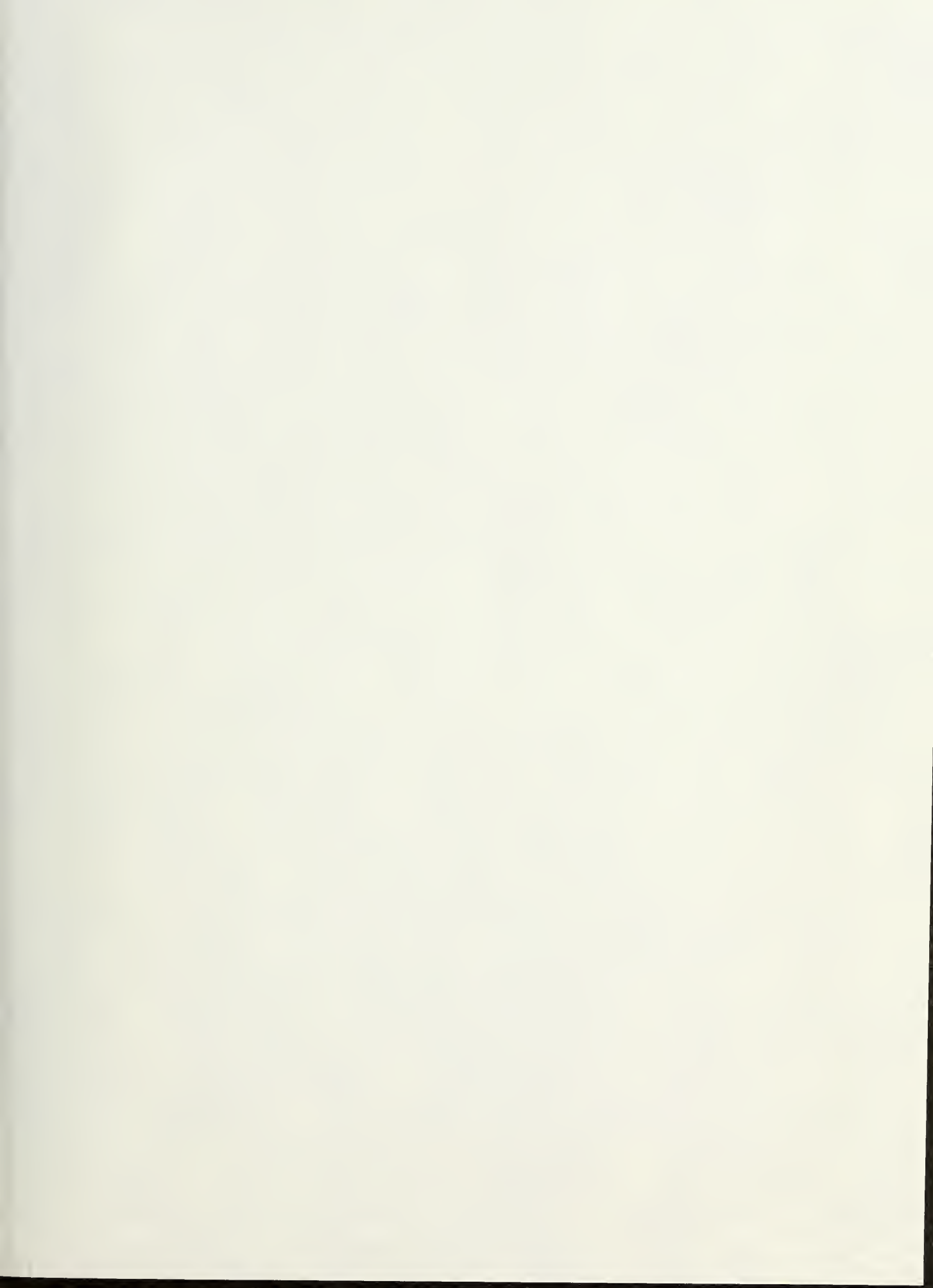

Fig. E-1.

Node temperatures for December 31, 1972, through January 6, 1973 (see Fig. 3).





Thesis

05445

c.1

Olson

Passive solar heating
residences.

190663

26 JUL 97

57167

Thesis

05445

c.1

Olson

Passive solar heating
residences.

190663



3 2768 001 97327 4
DUDLEY KNOX LIBRARY