

James P. Welsh

109 S. 4

10 Aug 14

THE SPINNING AND TWISTING
OF
LONG VEGETABLE FIBRES

(FLAX, HEMP, JUTE, TOW, & RAMIE)

NET BOOK.—This book is supplied to the
Trade on terms which will not allow of Discount
to the Public.

CHARLES GRIFFIN & CO., LTD.

STANDARD WORKS ON THE TEXTILE INDUSTRIES.

SECOND EDITION. Large 8vo. Handsome Cloth. In preparation.

A MANUAL OF DYEING:

FOR THE USE OF PRACTICAL DYERS, MANUFACTURERS, STUDENTS, AND ALL
INTERESTED IN THE ART OF DYEING.

By E. KNECHT, Ph.D., F.I.C., CHR. RAWSON, F.I.C., F.C.S., and RICHARD LOEWENTHAL, Ph.D.

"The MOST VALUABLE and USEFUL work on Dyeing that has yet appeared in the English language
. . . likely to be the STANDARD WORK of REFERENCE for years to come."—*Textile Mercury*.

"The MOST EXHAUSTIVE and COMPLETE work on the subject extant."—*Textile Recorder*.

Companion Volume to the above. In Large 8vo. Handsome Cloth. 16s. net.

A DICTIONARY OF DYES, MORDANTS, AND OTHER COMPOUNDS

USED IN DYEING AND CALICO PRINTING.

With Formulæ, Properties, and Applications of the various substances described, and
concise directions for their Commercial Valuation, and for the Detection of Adulterants.

By CHRISTOPHER RAWSON, F.I.C., F.C.S., WALTER M. GARDNER, F.C.S., and
W. F. LAYCOCK, Ph.D., F.C.S.

"Turn to the book as one may on any subject, or any substance in connection with the trade, and
a reference is sure to be found. The authors have apparently left nothing out. Considering the
immense amount of information, the book is a cheap one, and we trust it will be widely appre-
ciated."—*Textile Mercury*.

In Large 8vo. Handsome Cloth. With numerous Illustrations. 9s. net.

TEXTILE FIBRES OF COMMERCE.

A Handbook of the Occurrence, Distribution, Preparation, and Industrial Uses of the
Animal, Vegetable, and Mineral Products used in Spinning and Weaving.

By WILLIAM I. HANNAN,

Lecturer on Botany at the Ashton Municipal Technical School, Lecturer on Cotton Spinning at the
Chorley Science and Art School, etc.

"USEFUL INFORMATION. . . . ADMIRABLE ILLUSTRATIONS. . . . The information is not easily
attainable, and in its present convenient form will be valuable."—*Textile Recorder*.

In Large 8vo. With Illustrations and Printed Patterns. 21s.

TEXTILE PRINTING.

A PRACTICAL MANUAL. Including the Processes Used in the Printing of
Cotton, Woollen, Silk, and Half-Silk Fabrics.

By C. F. SEYMOUR ROTHWELL, F.C.S.

"BY FAR THE BEST and MOST PRACTICAL BOOK on TEXTILE PRINTING which has yet been brought
out, and will long remain the standard work on the subject. It is essentially practical in character."
—*Textile Mercury*.

Large 8vo. Handsome cloth. 12s. 6d.

BLEACHING AND CALICO PRINTING.

A SHORT MANUAL FOR STUDENTS AND PRACTICAL MEN.

By GEORGE DUERR,

Director of the Bleaching, Dyeing, and Printing Department at the Accrington and Bacup Technical
Schools; Chemist and Colourist at the Irwell Print Works.

ASSISTED BY WILLIAM TURNBULL.

With Illustrations and upwards of One Hundred Dyed and Printed Patterns designed specially to
show various Stages of the Processes described.

"When a READY WAY out of a difficulty is wanted, it is IN BOOKS LIKE THIS that it is found."—
Textile Recorder.

"MR DUERR'S WORK will be found MOST USEFUL. . . . The information given is of GREAT
VALUE. . . . The Recipes are THOROUGHLY PRACTICAL."—*Textile Manufacturer*.

SECOND EDITION. Revised and Enlarged. With numerous Illustrations. 4s. 6d.

GARMENT DYEING AND CLEANING.

A PRACTICAL BOOK FOR PRACTICAL MEN.

By GEORGE H. HURST, F.C.S.,

Member of the Society of Chemical Industry.

"AN UP-TO-DATE handbook has long been wanted, and Mr Hurst has done nothing more complete
than this. An important work, the more so that several of the branches of the craft here treated
upon are almost entirely without English manuals for the guidance of workers. The price brings it
within the reach of all."—*Dyer and Calico-Printer*.

LONDON: CHARLES GRIFFIN & CO., LTD., EXETER STREET, STRAND.

THE
SPINNING AND TWISTING
OF
LONG VEGETABLE FIBRES

(FLAX, HEMP, JUTE, TOW, & RAMIE)

A Practical Manual

*Of the most Modern Methods as applied to the
HACKLING, CARDING, PREPARING, SPINNING, AND TWISTING,
of the
LONG VEGETABLE FIBRES OF COMMERCE.*

BY

HERBERT R. CARTER,

BELFAST AND LILLE.

WITH 161 ILLUSTRATIONS (INCLUDING 10 PLATES).



LONDON:
CHARLES GRIFFIN AND COMPANY, LIMITED,
EXETER STREET, STRAND.

1904.

[All Rights Reserved.]

BLA
75
480
C3
1904
C12

PREFACE.

IN undertaking this work, the author's aim is to provide a practical guide to the spinning of the long vegetable fibres. He hopes that he has succeeded in writing in such a way that the book will be useful, not only to the technical student, but also to practical men like himself. When it is borne in mind that the same general principles underlie the preparing and spinning of all the long vegetable fibres, and that it is merely in details that the processes differ somewhat by reason of the coarseness or special nature of the fibres, it will not be considered that the author has undertaken too much or that it is impossible to furnish in one volume a practical handbook describing the treatment of so many fibres.

It is hoped that even experts will find something new and interesting in the perusal of these pages, which the author has tried to make as up-to-date as possible.

THE AUTHOR.

October 1904.

615690

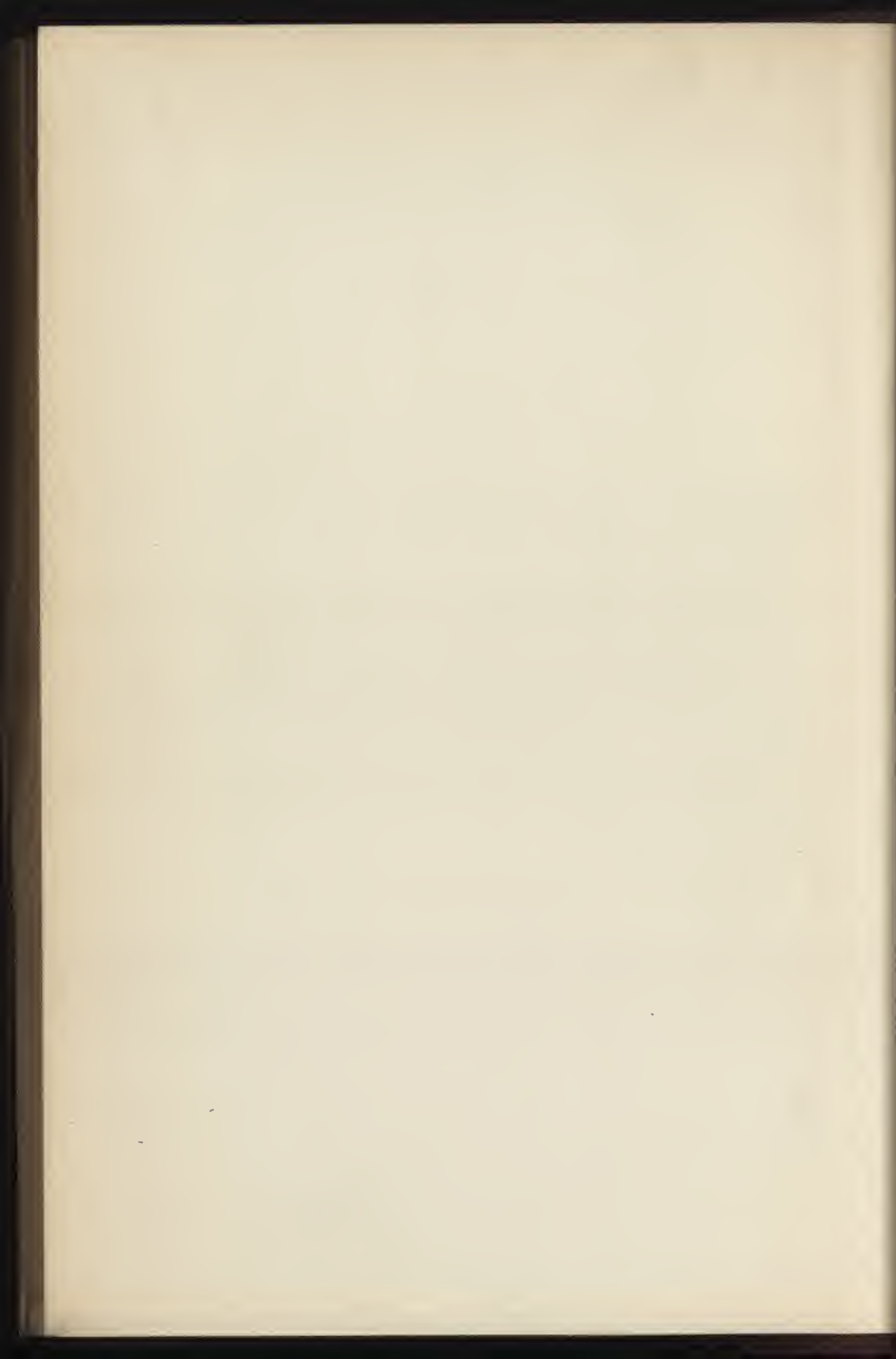

CONTENTS.

CHAPTER I.

THE LONG VEGETABLE FIBRES OF COMMERCE.

	PAGES
Origin—Flax Plant—European Hemp—Manila Hemp—Sisal Hemp—Mauritius Hemp—New Zealand Hemp—Jute—Ramie, Rhea or China-grass—Decortication—Retting—Cleaning—Decortication and Degumming—“Prepare” for Ramie Fibre	1-8

CHAPTER II.

THE RISE AND GROWTH OF THE SPINNING INDUSTRY.

Primitive Methods—Invention of the Wet Spinning of Flax—First Mills—Early Use of Hemp—Rise of the Manila, Jute, and Ramie Spinning Industries	9-10
---	------

CHAPTER III.

THE RAW FIBRE MARKETS AND THE PURCHASE OF THE RAW MATERIAL.

Flax and Hemp Trade Centres—Russia—Ireland—Belgium—Holland—France—Hemp-growing Areas—Hemp Prices—Jute Marks—China-grass—Fibre-selling Conditions—Duty on Fibre—Fibre Exports	11-19
--	-------

CHAPTER IV.

STORING THE RAW MATERIALS, AND THE PRELIMINARY OPERATIONS OF BATCHING, SOFTENING, KNIFFING, ROUGHING, BREAKING, AND CUTTING.

Stocking and Sorting—Book-keeping—Soft Fibres—Hard Fibres—Knifing—Batching Jute—Hemp Softening—Cutting—Stacking—Piecing Out—Flax Roughing—Filling Engine for Ramie	20-29
--	-------

CHAPTER V.

HACKLING BY HAND AND MACHINE.

Hand-dressing—Horner's Hackling Machine—Other Hackling Machines—Cotton's Brush and Doffer Machine—Combe's Brush and Doffer Machine—Horner's Stripping Rod Machine—Cotton's Stripping Rod Machine—Combe's Stripping Bar Machine—Fairbairn's Brush and Doffer Machine—Dossche's French Machine—Horner's Improved Lifting Motion—“Cast	
---	--

	PAGES
ing" or "Throwing out" Motions—Running a Hackling Machine— Tippling—Eve's Anti-friction Washers and Nuts—Maximum Yield from the Hackling Machine—Cost and Speed of Machining—The Ending Machine—Flat Dressing Frame for Ramie	80-53
CHAPTER VI.	
SORTING, AND THE MANAGEMENT OF THE HACKLING DEPARTMENT.	
Sorting—Sorter's Tools—Sorting Operations—Average Sort or Lea—Cost of Average Sort—Running Numbers for Spinning—Stocktaking and Mixing .	54-61
CHAPTER VII.	
THE PREPARING DEPARTMENT—SLIVER FORMATION.	
Spread-boards—To find the "Lead of Faller"—Bell Motion—Back and Front Conductors—Draft Calculation—Throw-off Motion—Breaker or Devil Card—Carding	62-79
CHAPTER VIII.	
TOW CARDING AND MIXING.	
Fine Carding—Finisher Card—Balling or Lap Machine—Full Circle Down- striker Roller Card—One-doffer Card—Card-doffing Knives—Covering in of Cards—Card Fires—The Gearing and Driving of the Card—Fineness of the Card Clothing—The Rotary Head—Gamble's Push-bar Drawing Head —Drawing Head—Gearing—Safety Devices—Mixing	80-94
CHAPTER IX.	
PREPARING, DRAWING AND DOUBLING, AND TOW COMBING.	
Drawing and Doubling—Preparing—The Spiral Drawing Frame—Boss Roller Traverse Motion—The "Apron" Head—Setting the Fallers and Screws— Chain Gill-bar Drawing Frame—The "Ring" Push-bar Drawing Frame —Gamble's Push-bar Drawing Head—Retaining and Jockey Roller —Preparing Systems—Doublings—Short Drafts and Single Slivers— Weight of the Slivers on the Doubling Plate—Capacity, etc., of Gills— Tow Combing—The Heavy-spreading System—Speeding a System—To Change the Weight of the Rove—Licking Up—Use of Table of Constant Numbers—To avoid Mixes—Worker's Charges—Ramie Preparing Machinery	95-120
CHAPTER X.	
GILL SPINNING—ROPE YARN—BINDER TWINE—TRAWL TWINE AND SHOE THREADS.	
Automatic Spinner—Binder Twine or Reaper Yarn—Lawson's Gill Spinning Machine—Fine Gill Spinning Frame—Basis of Rope Yarn Numbering .	121-134

CHAPTER XI.

THE FLAX, HEMP, JUTE, AND RAMIE ROVING FRAME.

PAGES

- Spiral Roving Framing—Turns per Inch of Twist Required—Bobbin Winding—Combe's Expansion Pulley and Quick Change Motion—Fairbairn's Disc and Scroll Mechanism—Fraser's Patent Spiral Roving Frame—Power of the Crown Wheel—Practical Changing—Starting the Frame—Rove Stock 135-152

CHAPTER XII.

DRY AND DEMI-SEC SPINNING OF FLAX, HEMP, JUTE AND RAMIE.

- The Dry Spinning Frame—Swing Rail Dry Spinning Frame—Particulars of Dry Spinning Frames for Jute—Carter's Automatic Bobbin Dragging Motion—Draft Required—Twisting on the Ring Frame 153-164

CHAPTER XIII.

THE WET SPINNING OF FLAX, HEMP, AND RAMIE YARNS.

- The Wet Spinning Frame—Starting and Working a Frame—Wet Spinning of Ramie—Cold Water Spinning—Size in the Spinning Trough—Turn-off and Speed of Spindles—Spinning Room Belting—Arrangement of the Spinning Room—Band Tying—Tapes for Spindle Driving—Oiling in the Spinning Room—How Black Threads are Produced—Cuts per Spindle—Degree of Saturation of Atmosphere of the Wet Spinning Room—Removing Yarn to the Reeling Room 165-187

CHAPTER XIV.

FLAX, HEMP, JUTE AND RAMIE WASTE SPINNING.

- Waste Spinning—American Machinery for Spinning Hard Fibre Waste—Opening Flax "Bands" and Rope—Noil Spinning—Treatment of Wet Spinning Waste—The Garnett Machine—Opener and Knot Breaker—Batching—The Scribbler—Card Clothing or "Cards"—The Drury Spinning Apparatus—Porrirt's Spinning Frame for Short Waste Fibre—The Celestin-Martin Twist Tube Frame—The Waste Mule—Ramie Waste Spinning 188-204

CHAPTER XV.

YARN REELING, WINDING, DRYING, COOLING, AND BUNDLING.

- Wet Warp Winding from Spinning Bobbin—Cop Winding—Yarn Drying—Yarn Cooling—Yarn Proofs—Bundling and Bunching Yarn—Weight of Bundles—Baleing—Prices of Yarns 205-225

CHAPTER XVI.

THE MANUFACTURE OF THREADS, TWINES AND CORDS FROM FLAX, HEMP,
JUTE AND RAMIE YARNS.

	PAGES
Twisting and Cabling—Flax for Threads—Cable Thread—Theory of Yarn and Thread Construction—Fancy Yarns—Range of Twines—Twine Laying or Cabling—Sizing and Polishing Threads and Twine—Starch or Dressing—Softening Threads—Thread Glazing—Balling Yarns, Threads, and Twines—Skeining Threads—Leeson's Universal Winder—"Randing" Twines—Spooling of Sewing Threads—Hand-measuring Reel and Re-winding Head—Prices of Flax and Hemp Cords, Lines and Threads	226-260

CHAPTER XVII.

ROPE MAKING.

Construction of Ropes—Rope Manufacture and Machinery—Register or Stranding Machine—Horizontal Laying or Closing Machines—Compound Rope Machines—Rules for Rope Makers—Weight of Ropes—Balling Small Rope—Coiling Ropes	261-284
--	---------

CHAPTER XVIII.

THE MECHANICAL DEPARTMENT: REPAIRS—FLUTING—HACKLE-SETTING—
WOOD TURNING—OILS AND OILING.

The Mechanic Shop—The Fluting Shop—Scoring Rollers—Maintenance of Machinery—Lubrication	285-296
---	---------

CHAPTER XIX.

MODERN MILL CONSTRUCTION: HEATING, LIGHTING, VENTILATION AND
HUMIDIFICATION.

Site for Mills—Mill Buildings—Heating and Ventilation—Roofs—Chimneys—Heating and Lighting—Air Supply—Humidity—Systems of Ventilation:—Wilson-Clyma's System—Huglo's System—Carter's System—Ventilation of Hackling Machines—Protection against Fire	297-315
---	---------

CHAPTER XX.

BOILERS AND ENGINES, STEAM AND WATER POWER.

Motive Power—Boilers—Water Testing and Purifying—Feeding Boilers—Pressure Gauges—Firing the Boiler—Steam Pipe—Steam Engine—Indicators	316-341
---	---------

CONTENTS.

xi

CHAPTER XXI.

POWER TRANSMISSION:—BELTS, ROPES, AND GEARING—ELECTRICAL POWER
TRANSMISSION.

	PAGES
Power Transmission—Gearing—Rope Driving—Belt Driving—Rules in Con- nection with Rope and Belt Driving—Pulleys and Bearings	342-353
INDEX	354



LIST OF ILLUSTRATIONS.

FIG.	PAGE
1. Hand-scutching blade,	4
2. Flax straw breaker,	5
3. Flax scutcher's stock and handles,	6
4. Knifing machine,	21
5. Horizontal hemp softener,	22
6. Circular hemp softening machine, with reciprocating motion,	23
7. Hemp softener,	24
8. Flax cutter,	25
9. Touch pin,	27
10. Filling engine for ramie,	28
11. Horner's brush and doffer hackling machine,	33
12. Ordinary tipping for hackler,	38
13. Tipping and tying for stores or spread-boards,	39
14. Tipping and tying for stores or spread-boards,	39
15. Anti-friction washer for hackling machine holder,	40
16. Eve's anti-friction nut for machine holders,	41
17. Reade, Crawford and M'Kibbin's patent automatic screwing for hackling machines (filling end),	42
18. Reade, Crawford and M'Kibbin's patent automatic screwing for hackling machines (changing end),	43
19. Erskine's ender,	51
20. Cotton's end comb,	51
21. Flat dressing frame for ramie,	52
22. Book frame and books for flat dressing frame for ramie,	52
23. Spread-board for flax and hemp,	63
24. Long line spread-board,	63
25. Lawson's drawing head,	68
26. Rubbers for drawing frames (Plate I.)	<i>to face</i> 68
27. "Good's" combined hackler and spreader for manila hemp,	72
28. "Good's" combined hackler, and intermediate drawings, for manila, sisal, etc.,	73
29. "Good's" combined hackler and spreader for manila fibre,	74
30. Breaker card for jute,	77
31. Breaker card,	78
32. Finisher card with hopper feed,	81
33. Tow card,	82
34. Finisher card for jute,	83
35. Push-bar drawing head,	91
36. Spiral drawing frame (back view),	96
37. Spiral drawing frame for flax or hemp tow (front view),	97
38. Spiral drawing frame for long hemp,	98
39. Diagram of gearing rollers and shafts for drawing frames, with single or double back shafts,	99

FIG.	PAGE
40. Traverse motion for drawing frame front roller,	190
41. Patent conductor on under side of sliver plate,	190
42. Apron head chain-bar drawing frame for manila,	191
43. Chain-bar drawing frame for jute,	192
44. Chain-bar drawing frame for jute,	193
45. Section through bars of Fraser's patent "ring" drawing frame for jute (Plate II.),	<i>to face</i> 195
46. Automatic spinner for rope yarn and binder twine,	122
47. Horizontal automatic rope yarn and binder twine spinner,	123
48. Automatic spinner for rope yarn and binder twine,	124
49. Lawson's inclined spindle gill spinning frame,	128
50. Gill spinning frame for rope yarns,	131
51. Fraser's patent spiral roving frame (Plate III.),	<i>to face</i> 135
52. Houldsworth's differential motion for the roving frame,	139
53. Differential motion as applied to Mackie's roving frame,	140
54. Rat-trap or strike motion for cone roving frame,	144
55. Combe's expansion pulley and gearing,	145
56. Combe's quick change builder motion,	146
57. Fairbairn's disc and scroll mechanism for the flax, hemp and jute roving frame,	147
58. Double dry spinning frame for shoe threads of flax or hemp (Plate IV.),	<i>to face</i> 153
59. Boyd's patent swing rail dry spinning frame for hemp and jute,	154
60. Carter's automatic bobbing motion (Plate V.),	<i>to face</i> 157
61. Sections of wet spinning frame for flax, hemp or tow,	166
62. Wet spinning frame for flax, hemp or tow (Plate VI.),	<i>to face</i> 166
63. Part of ramie wet spinning frame,	178
64. M'Meekin's slubbing motion,	179
65. Hygrometer,	185
66. Duster and cleaner,	189
67. Picker for hard fibre waste and tow,	190
68. Card for hard fibre waste and tow,	191
69. Tow spinner for hard fibre waste or tow,	192
70. Issitt's patent waste shaker,	193
71. Eve's patent untwister and opener,	194
72. Tenter-hook willy for opening hard waste,	195
73. Scribbler with hopper feeder for flax waste spinning,	197
74. Scotch feed,	197
75. Carder and condenser for preparing slubbing from short waste,	198
76. Porrit's dry spinning frame to spin slubbing of flax noils or waste from the condenser bobbin,	202
77. Double cop-winding machine,	212
78. Yarn and twine testing machine,	218
79. Balling machine,	223
80. Upright spindle winding frame, with creeper motion for taking away empty bobbins,	227
81. Improved single drum winding frame (latch and catch) (Plate VII.),	<i>to face</i> 226
82. Winding or swifting frame (Jennings'),	228
83. Winding or swifting frame (Bywater's),	229
84. Twisting frame (Bywater's),	230
85. Twine twisting frame (Jenning's),	231
86. Boyd's patent stop-motion flyer twisters (Plate VIII.),	<i>to face</i> 232
87. Cabling machine for cords,	237
88. Cabling or laying machine,	238
89. A two-spindle machine to lay 2, 3 or 4-ply cord,	239

FIG.	PAGE
90. Horizontal laying machine for box and sash cords, clothes lines, etc.,	240
91. Horizontal laying machine for cords, etc.,	241
92. Twine washing and carding machine,	242
93. Twine polishing machine,	243
94. Twine polishing machine,	244
95. Improved large twine polishing machine (Plate IX.),	<i>to face</i> 244
96. Double-sided hank polishing machine,	245
97. Bobbin-to-bobbin cord polishing machine,	246
98. Hank twisting machine for linen or cotton threads,	247
99. Improved yarn preparing machine,	248
100. Hand balling machine,	249
101. Balling machine for large balls,	250
102. Balling machine (four sizes),	251
103. Balling machine (for large sizes),	252
104. Balling machine (for large balls),	253
105. Roll winding machine,	254
106. Randing machine,	255
107. Hand spooling machine,	256
108. Improved semi self-acting spooling machine,	257
109. Improved 8, 10 or 12-spindle semi self-acting spooling machine,	258
110. Improved self-acting spooling machine,	259
111. New automatic thread spooling machine (Plate X.),	<i>to face</i> 259
112. Hand measuring reel and re-winding head,	260
113. Yarn tarring machine,	263
114. Spindle yarn winding machine,	264
115. Traveller,	265
116. Steam chest, register plates and tubes,	266
117. Foreturn machine and traveller,	267
118. Horizontal stranding machine,	268
119. Horizontal strand forming machine,	269
120. Horizontal strand closing or laying machine,	270
121. A 3- or 4-strand closing machine,	271
122. Horizontal 3- and 4-strand closing machine,	272
123. Vertical closing machine for 3- and 4-strand ropes,	273
124. Foreturn machine,	274
125. Laying top,	275
126. Horizontal compound hemp rope laying machine,	276
127. Six-thread horizontal rope machine for forming and laying rope,	276
128. Twenty-four thread compound rope machine,	277
129. Sixty-thread vertical compound rope machine,	278
130. Coarse balling machine,	280
131. Coiling machine,	281
132. Geared rope reel,	283
133. Sturtevant system of ventilation,	299
134. Improved anemometer,	304
135. Improved "Drosophore" humidifier,	306
136. "Drosophore" humidifier; section of the nozzle,	307
137. Wilson-Clyma system of ventilation of carding rooms,	308
138. Section showing cards, conical pits, ducts, fan, cyclone and dust chamber for ventilation of carding rooms, Wilson-Clyma system,	309
139. Ventilation of carding rooms, Wilson-Clyma system,	309
140. Fan wheel,	310
141. Sturtevant steel plate pulley fan,	311

FIG.	PAGE
142. Plan of carding room fitted with Carter's ventilating and waste removal system,	312
143. Longitudinal section of row of cards with air duct, travelling lattice, dust chambers, and cyclone separator,	312
144. Transverse section through card, and air duct placed underneath, Carter's system,	313
145. Longitudinal section through cards, showing air duct, endless lattice and rollers, Carter's system,	314
146. Upright Samson turbine,	317
147. Horizontal Samson turbine,	317
148. Horizontal Samson cased turbine,	318
149. Double horizontal cased Samson turbine,	319
150. Section through a French generateur à bouilleurs,	320
151. Lancashire boiler,	321
152. Davidson's Sirocco fan,	330
153. Induced draught produced by a Sirocco fan,	331
154. The Willans steam engine,	333
155. Sulzer's horizontal compound mill engine,	336
156. Westinghouse polyphase motor, operating twisting frames,	343
157. Method of setting out groove in pulleys, for rope driving,	345
158. Method of splicing driving ropes,	346
159. Half-crossed vertical driving,	347
160. Driving with shafts at right angles,	348
161. Application of rope driving to machinery by patent fast and loose pulleys,	349

SPINNING OF LONG VEGETABLE FIBRES.

CHAPTER I.

THE LONG VEGETABLE FIBRES OF COMMERCE.

Origin.—With the exception of aloe, agave or sisal, New Zealand, Mauritius and Manila hemsps, which are produced from the leaves of the plants of these names, the long vegetable fibres of commerce are obtained from the stalk of the plant. When the fibre is found in the leaf of the plant it is usually imbedded in pulpy or woody substances. When it is found in the stem of the plant it surrounds the woody matter, lies near the surface, and is only covered by a coating of gummy matter which binds the fibres together. The separation of the fibre from the stem or leaves of the plant is effected either by hand or by machine, both methods being usually aided by natural or hastened fermentation, or by chemical treatment.

Flax Plant.—Flax, French *Lin*, German *Flachs*, is the fibre obtained from the stems of a plant the botanical name of which is *Linum usitatissimum*. This plant will grow in any temperate climate, and is cultivated to some extent in almost every country of Europe. Russia produces a very large proportion of the world's supply, and then, in order, come Belgium, Holland, Ireland, France, Germany and Italy. Little or none of the flax grown in Ireland, France, Germany or Italy is exported, but is used up by local spinners. Belgium and Holland, on the other hand, export almost all, and spin but little of the flax which they themselves produce, the reason being that the Belgian spinner spins a coarse yarn into the composition of which the cheaper Russian flax largely enters.

A deep sandy loam is the soil which best suits the flax plant. After a fine and level seed-bed has been prepared by ploughing and harrowing, a reliable brand of seed should be sown rather thickly broadcast over the field and covered in by a passage of the harrow.

The fibre produced is of better quality when the seed is thickly sown, since the stems then grow up straight and do not branch until quite high

up. Branching spoils the quality of the flax for spinning purposes, and is to be avoided. Two and a half bushels per acre is a suitable quantity of seed to give good results. When a "braird" appears, and is a few inches long, the field should be carefully weeded, as the value of the fibre will be much reduced if it be afterwards found that weeds are mixed with it.

Towards the middle or end of August the plant should be ready for pulling. The best spinning fibre is obtained if the flax be pulled before it has quite reached maturity, or at the moment when the stems begin to get yellow at the base, and the seed balls become firm. When the hands are obtainable the stems should be pulled up by the roots, as the fibre obtained in them is more suitable for spinning than if the stems be cut down, as they sometimes are in America, where labour is scarce and dear. In pulling, it is of the utmost importance that the long and short stems be kept separate as much as possible, and also that the root ends be kept perfectly even, as the yield of fibre will be thereby improved, both in the subsequent scutching and hackling processes. The stems are next tied up in bundles, and the seed removed by pulling the top ends through a sort of coarse comb called a "ripple."

European Hemp.—European hemp is a taller and coarser plant than flax, but is sown and treated in a similar manner. It is grown almost everywhere that flax is grown, except in Ireland. Russian, Italian and French are the best known varieties, and almost the only ones which are exported.

Manila Hemp.—Manila hemp is grown in large quantities in the Philippine Islands, Borneo and Java. It is obtained from the leaves of a plant belonging to the banana family. The plant grows to a height of about twenty feet, the stem being enveloped in the long leaves which contain the fibre. The leaves are cut down periodically, the inner ones producing a rather finer fibre of a lighter colour than that obtained from the older and outside leaves.

Sisal Hemp.—Sisal hemp or Agave fibre is indigenous to Yucatan, and is largely cultivated in the Bahamas and in Florida. The leaves of the plant which contain the fibre average five to six feet in length, and are cut down every year after the plant is about four years old. The best quality of fibre is grown on gravelly soil of medium quality.

Mauritius Hemp.—Mauritius hemp is a plant very similar to the former, and requires the same treatment. The leaves and fibre are rather longer.

New Zealand Hemp.—New Zealand hemp, or *Phormium tenax*, resembles Manila somewhat, but is of inferior quality and strength. It is also produced from the leaves of a plant, the yield of fibre being about 16 cwts. per acre.

Jute.—Jute is the bast fibre obtained from the stem of a plant which is principally grown in the north and east districts of Bengal. The finest jute is grown in the high ground, and the middle qualities on the river banks, deltas, etc., known as "Salilands." A hot, damp climate without too much rain is most suitable for the proper development of the plant.

Ramie, Rhea, or China-grass.—There are two sorts of plants which produce ramie or fibre of similar appearance. One, called the *Boehmeria tenacissima*, has leaves of which the backs are green; the other, the *Boehmeria nivea*, has leaves with white backs, and is the ramie plant proper, the former plant being often called rhea. Ramie fibre is generally of a brighter colour than rhea, and is finer, but rather weaker. The fibre called China-grass is produced from either of these two plants. Rhea is grown in Sumatra, Borneo, Java, Malacca, India and Mexico; ramie principally in China and Formosa. The attempts which have been made to cultivate the plant in European countries have ended in failure, as the winter is too cold.

A suitable soil is one which is moist, but not sodden; a friable loam with a porous subsoil. A hot and rainy climate is the most suitable, for dry heat kills the plant. It is perennial, and gives from two to five crops of fibre per annum, for many years in succession. When it is produced from seed, it is only possible to get one crop of fibre the first year; but if root cuttings be planted, two crops are usually gathered. An acre will produce about 16 tons of green stems per annum, if four crops be taken, and from these stems about 130 stone of fibre may be extracted. If the plant be produced from seed, the latter should be germinated in open boxes placed under cover. The most approved way is to first fill the boxes with earth, and then spread over the surface a thin layer of fine loam in which the seeds are mixed. No watering should be done for fully a week, when the seed leaves begin to appear. The plants may then be watered with a fine watering can. When the young plants are about two or three inches high, they should be carefully transplanted into specially prepared beds, care being taken that the roots are kept surrounded with a ball of earth. They should be set at a distance of about three feet from each other, as in this way too much branching is prevented, branching producing short fibre. When the stalks are long enough they are cut down.

Decortication.—When, as in the case of Manila hemp and Agave fibre, the filaments are covered by a succulent pulp, the latter is removed by scraping, leaving the fibre bare.

Retting.—When, on the other hand, the fibre surrounds the woody matter, as in the flax and European hemp plant, retting or rotting is resorted to, to dissolve and decompose by fermentation the gummy matter which binds the fibre to the stem. The retting process may be done in

two ways; the quicker method being known as water-retting, and the other as dew-retting. Water-retting is done in either still or running water. Flax and hemp steeped in rivers is usually of a nice yellow colour, and much appreciated by spinners. Flax and hemp steeped in still water is of a darker colour, but of good spinning quality if the water be soft and stagnant and free from mineral salts in solution. The best results are obtained when the flax straw is protected from contact with the earthy sides of the dam or from floating scum, by straw, and placed in openwork crates or baskets. Ten to fifteen days, according to the temperature, is required by the steeping process. In the Courtrai district of Belgium, where the finest flax which the world produces is steeped in the sluggish waters of the river Lys, the factors prefer to steep their flax for a comparatively short period the first year, and then to dry and store it until the following year, when they complete the retting process.

In India, jute is steeped in the like manner, either in running water or in retting dams.

The greatest care must be taken that the retting process does not go on too long, as the fibre is thereby weakened. When it is found that the fibre separates easily from the woody matter, the stems are removed from the water and spread out to dry upon the ground.

Dew-retting consists in spreading the freshly-pulled flax or hemp straw lightly over the field and allowing it to remain there until the action of the sun, rain, and dew has accomplished the partial dissolution of the gummy matter which binds the fibre to the wood.

The one objection that weavers have to using yarns spun from dew-retted fibre lies in the fact that dew-retted yarns turn a darker colour when boiled. When fully bleached, however, linen made from dew-retted fibre has a more brilliant whiteness than that made from water-retted fibre.



FIG. 1.—Hand-scutching blade.

Breaking and Scutching.—In order that the fibre may be easily separated from the wood, the flax or hemp straw must be perfectly dry and thoroughly retted. It is then quite easy to break up the “boon” by beating the straw upon a flat surface with a mallet, or by the use of a primitive wooden press of intersecting bars, called a “break,” and then to thoroughly clean the fibre by repeated blows of a wooden scutching blade (fig. 1). This primitive method is still practised in many a cottage home in Ireland, Belgium, Holland, Russia, Germany, and

Italy, upon flax and hemp straw. The fibre produced, however, is now nearly always sold either directly or indirectly to the mills, as the use of the old spinning-wheel has almost entirely ceased.

Farmers now generally bring their flax straw to a scutch-mill, where it is cleaned in large quantities by steam or water power. The machinery consists first of all of a "breaker" (fig. 2), which has a series of pairs of fluted rollers which crush the straw and break up the boon into small pieces, which, if the stems have been sufficiently retted, are easily separated from the fibre by the strokes of a beater. The best flax breakers have six or seven pairs of comparatively small rollers, fluted rather finely to different pitches, so that they may break the boon into as small pieces as possible. The efficiency of the machine is further increased by turning the

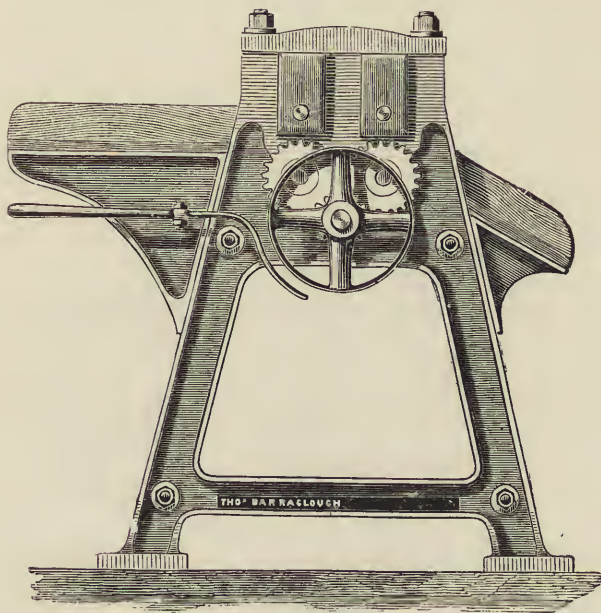

FIG. 2.—Flax straw breaker.

rollers backwards and forwards alternately by means of cranks, connecting rods, ratchet wheels, and detents. The crank producing the forward motion has the longer stroke, so that the straw passes through the machine. According to the most common method of flax scutching, the broken straw is held in a notch in an upright plank or "stock," while revolving beaters or "handles" of wood or light iron, shown in fig. 3, strike it repeatedly and knock out the shive.

Cleaning.—The long flat leaves of the New Zealand hemp plant are cut down and subjected to the action of a stripper similar to the flax scutcher's handles, which detaches much of the bark. The partially cleaned fibre is then put into a trough through which water circulates, and is washed and scraped with a flat piece of wood. The fibre is then "grassed" and

partially bleached by the action of the sun and air, after which it undergoes a further scutching process, which softens, cleans, and renders it a saleable article. Hitherto the New Zealand hemp put upon the market has been of a very coarse description, and only suitable for spinning into rope yarns or binder twine. Quite recently, however, a German chemist professes to have discovered a means of preparing the fibre in such a way that it may be spun much finer. He selects the leaves of the younger plants only; and removing the brown edges, boils the leaves in a solution of the alkaline salts, borax, soda, or sodium bicarbonate. The moist and warm leaves are then beaten with wooden hammers until the woody tissue has

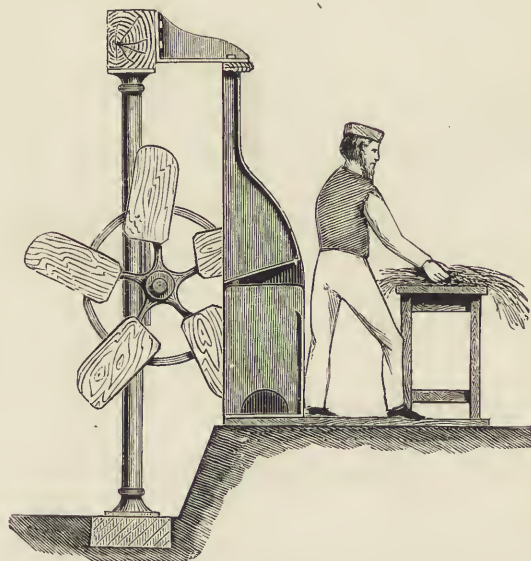

FIG. 3.—Flax scutcher's stock and handles.

been loosened and opened up. The fibre is then completely cleaned by washing in warm soap and water and subsequent hackling.

Manila hemp is cleaned by the natives, who scrape the pulp from the newly-cut leaf-stalks, leaving the fibre, which they hang out to bleach and dry. There is not, as far as the author is aware, any machine which can show such satisfactory results as does hand labour.

Decortication and Degumming.—Decortication should be practised upon the stems of the ramie plant when in a green state, because when they become dry the outside skin becomes hard and brown and most difficult to remove. Up to the present time no machine has been found to give such good results, as regards yield and clean fibre, as the manual process practised by the women and children in China, who produce from the ramie or rhea plant the fibre known as China-grass. Hand decortica-

tion is a long and costly process, because a woman can produce only a few pounds of fibre per day. This she does by placing a few green stems on a flat board and scraping them with a piece of wood, in order to remove the woody matter, with as much of the gum as possible. A good decorticating machine should do the work as well as it can be done by hand without breaking or "slaving" the fibre. Many decorticating machines have been patented, but most of them have been found defective. The best-cleaned fibre still contains from 20 to 30 per cent. of gum, which must be removed before it can be spun into fine yarns. The degumming may be conveniently effected by employing the process and the apparatus invented by Boyle. This process consists in passing the material through tanks of chemical solutions—bleaching it, in fact.

Vegetable fibres are almost without exception of cellular structure. In the case of flax and hemp the so-called fibres are composed of ultimate or shorter fibres joined together by the gummy matter or pectose before referred to. Bleaching dissolves out and oxidises the colouring and gummy matter, and leaves disjointed the ultimate fibres of pure white cellulose. It is only with such fibres as ramie, the ultimate length of which is very long, that such treatment may be resorted to before spinning, as, were flax or hemp bleached before spinning, the yarn produced would have comparatively little strength.

Boyle's degumming process for ramie consists in passing the material through a trough containing weak soda lye, and then through a feeble solution of hydrochloric acid, which acts upon the soda remaining in the fibre and sets up fermentation. The material is then passed on to a third tank similar to the first, and then to a fourth containing a solution of permanganate of potash. The fifth tank contains a mixed solution of hyposulphite of soda and hydrochloric acid, the sixth hyposulphite of soda, and the seventh a solution of hydrochloric acid alone. On leaving the latter bath the fibre is washed in pure water, and then steeped in a weak solution of soap and water, in order to give it back a little of the oleaginous matter extracted by the action of the soda. The material should be passed through these successive baths between endless openwork travelling aprons, in thin layers, in order that the fibre may preserve its parallelism and not become too much matted. Between each bath it passes between wringing rollers to remove superfluous moisture.

True China-grass, from which much of the gum has already been removed by hand-scraping, does not require such severe chemical treatment as that just described. It is sufficient to boil it in soda lye, to steep it in chloride of lime solution and then in an acid bath, repeating these two latter processes, with a washing in pure water between each, until the gum has completely disappeared and a pure white filasse is produced. The fibre should be placed in the kier or boiling-pot, between trays of wire

network one above the other, to prevent the matting of the fibre. The trays of fibre are placed in the pot with the lye at 3° Tw., and allowed to boil for about seven hours. The fibre is then taken out, rinsed in pure water to remove all traces of soda, and then steeped for ten or twelve hours in chloride of lime solution at $\frac{1}{2}^{\circ}$ Tw., contained in a stone trough. When taken out of this steep it is again rinsed in pure water and placed in a solution of sulphuric acid or vitriol at 1° Tw., where it is left for some hours, and then again thoroughly washed. If all traces of gum have not completely disappeared, the two latter processes are repeated as frequently as required.

“Prepare” for Ramie Fibre.—After the fibre has been submitted to all this chemical treatment it will be found to be rather harsh and dry. In order that it may lend itself easily to the following operations, it will be found advantageous to give it back its suppleness by treating it with oily matter or “prepare,” to replace that which has been removed by the action of the soda and the acid. A good result will be attained by steeping the fibre, before finally drying it, in an oily solution prepared as follows:—To every 15 quarts of boiling water add 200 grms. of glycerine, 200 grms. of Castile soap, 100 grms. of white wax, and 50 grms. of tallow.

CHAPTER II.

THE RISE AND GROWTH OF THE SPINNING INDUSTRY.

Primitive Methods. — It may truly be said that the flax and hemp spinning industry had its birth with the nineteenth century, for when that period opened the spinning of these fibres was in practically the same primitive state as it was in the early days of the Christian era, as revealed to us by Egyptologists and others. It is even questionable if, in the remote ages of the past, the inhabitants of certain countries had not even greater skill in such arts than had our great-grandfathers.

Invention of the Wet Spinning of Flax.—Flax and linen are repeatedly mentioned in Old Testament history. In Biblical times yarn was no doubt spun with the aid of the spindle and distaff, and later on, with the hand spinning-wheel. The invention of Arkwright, at the end of the eighteenth century, of the principle of roller drawing, was the true starting-point of the development which all branches of the spinning industry have since attained. It was not until forty years later, however, that the fundamental principles of modern long vegetable fibre spinning were first discovered. The principle which applies to all these fibres without distinction is the use of gills in the preparing process; the other is the use of hot water as a softening and macerating agent in the spinning of fine numbers from flax and hemp. Both these principles were discovered by a certain Philippe de Girard, who set himself to win a prize offered by Napoleon Bonaparte for the best machine for spinning flax. In the course of his experiments he tried steeping the fibres in hot water and then drawing them the one over the other, and twisting them between his fingers. Having heard of Arkwright's principle of roller drawing, Girard had no difficulty in constructing a machine to carry out his ideas, and started the first mechanical flax wet-spinning mill. One of Girard's employés soon afterwards joined Mr Marshall and founded the once well-known mill in Leeds—the first English wet-spinning mill.

First Mills.—In the year 1828 the first Irish flax spinning mills were started—one in Belfast by Messrs Mulholland, and the other in Castlewelland by the Messrs Murland. The English had meanwhile so improved the original models of Girard that they wished to keep the trade to themselves, and threatened any machinist who should give away any patterns

or drawings with a heavy fine. In spite of all, the French succeeded in procuring English frames, and in 1835 a flax spinning mill was started in Lille and another at Essonnes. Further information was gained as to English methods of construction by a French engineer named De Coster, who, going to England, got employment as an ordinary labourer in the works of one of the leading flax machinists, and returning to France some years afterwards, started a workshop for the building of flax machinery, fitting up about forty small mills within the next three years.

Previous to the discovery of the advantages of employing hot water to soften the gummy matter binding the fibres together, and thus enabling them to be drawn out and spun fine, the few hundred mill spindles which had been running could only produce the coarser dry-spun numbers. Fine numbers could only be spun by hand upon the old spinning-wheel, and it is probable that, had the principle of hot-water spinning not been discovered, the linen trade would never have attained its present dimensions.

Early Use of Hemp.—Hemp has probably been grown almost, if not quite, as long as flax. Herodotus tells that the Scythians used the narcotic properties of the plant to produce a sirop which they called Haschisch, from which comes our word assassin, either because it was used as a poison or because people under its influence frequently committed murder. The Scandinavians, Germans, and Scythians have cultivated hemp for many centuries. Catherine de Medicis is said to have worn underclothing of considerable fineness made from hemp, which at that time was considered to be quite a novelty.

Rise of the Manila, Jute, and Ramie Spinning Industries.—The development of the Manila hemp, jute and ramie spinning industries is of comparatively recent date.

In days gone by these fibres were only used, by the natives who grew them, in the roughest possible fashion.

Ramie was indeed woven into a cloth, but the yarn was not spun nor twisted, being in fact merely the fibre split into lengths which were attached together at the smaller ends.

The jute spinning industry, which at first made slow progress, has within the last half century attained enormous proportions.

Ramie spinning, owing to the difficulties experienced in decorticating and degumming the fibre, is still but a struggling industry, and yet in its infancy.

At the present time the number of spindles spinning flax may be reckoned as follows :—

Ireland,	860,000 spindles.	Belgium,	300,000 spindles.
England and Wales,	90,000 ,,	Russia,	300,000 ,,
Scotland,	180,000 ,,	Germany, Austria and	
France,	456,000 ,,	Silesia,	573,000 ,,

CHAPTER III.

THE RAW FIBRE MARKETS AND THE PURCHASE OF THE RAW MATERIAL.

Flax and Hemp Trade Centres.—As far as the manufacturer is concerned, the market in which he purchases his raw material is either a centre of production or, if the latter is in some distant land, the port at which the fibre arrives. Foreign hems, for instance, arrive at and are bought and sold in Liverpool or London, Russian flax in Belfast and Dundee, jute in Dundee and Dunkerque, etc. The fibre is shipped by exporting houses, and sold by their agents at market price on its arrival. Important spinners, of flax for instance, often find it to their advantage to employ their own buyers to visit or reside in the districts in which the fibre is grown, and to buy direct from the farmers or scutchers. Most of the large Irish flax spinning mills have their buyer stationed, at least during the buying season, at Courtrai, Ghent, or Brussels, from which centres they may reach the surrounding markets. There is, nevertheless, room for a considerable number of merchants and commission houses, who in like manner have their agents and buyers engaged at home and abroad.

Needless to say, a competent buyer must be an expert judge of the raw material, and experienced in the manners and customs of the markets in which he buys. Few men are good judges of the raw fibre who have not themselves worked it in the mills. It requires experience of this sort to know how the fibre will work out, the yield it may be expected to give, the length to which it may be spun, and its consequent value.

Russia, Belgium, Holland, Ireland, France, and Germany are the principal flax-producing countries.

Russia.—The chief Russian markets are Riga, Pernau, St Petersburg, Kostroma, Bejetsky, Kashin, Pskoff, Witebsk, Jaropol, Mologin, Seretz, Ostroff, Werro, Opotochka, Dorpat, Wiasma, Moehenez, Longa, Vologda, Jaroslav, Rjeff, Sytcheffka, Ouglitch, Otbornoy, Iwashkower, Viatka, Novgorod, and Archangel. Riga, Pernau, Reval and St Petersburg are the chief ports of export. The Gulf of Riga is closed by ice during several months of the year, during which period the port of Reval, being open on account of its position, is most used. A good deal of tow as well as flax comes from the fine dew-retted districts of Kashin, Kama, etc.

Other districts in which the fibre is principally dew-retted are those of Vologda, Kostroma, St Petersburg, Slanetz, and Bejetsky. The water-retted fibre is grown principally in the Livonian, Crown and Hoff's districts.

The finer sorts of Russian hemp are grown in the neighbourhood of Smolensk, Rosslaw, Juchnow, and Mossalsk, while the coarser sorts come from Orel, Karatschew, Pensa, Kuřsk, and Briansk. Riga and St Petersburg are the ports of shipment. Cronstadt, which is the port of St Petersburg, is closed by ice from November until April.

Russia exports about 230,000 tons of flax and tow every year, and about 50,000 tons of hemp and tow in the same time.

The Russian flax trade is largely carried on by Jews. Dishonest dealing in the way of mixing foreign substances with the flax, watering it and stuffing the heads with tow, became so notorious, that in 1899 the Russian government made it law that—

- (1) Flax must contain no admixture of refuse, and must not be damped to increase its weight.
- (2) The bundles of flax must not weigh more than 20 lbs., and must consist of fibre of like quality and scutching.
- (3) They must be tied with one band only at a distance of one-third from the top, so that the ends of the fibre will hang down freely, and so that the fibre may be examined without loosening the bundles.
- (4) The bands with which the bundles are tied must be of flax.

These rules have had a good effect, and it is now not so common as it was to find stones, sand, and pieces of metal in the heads of Russian flax.

The Russian peasants bring their flax to market in the winter time, when the roads are covered with snow and in good order for the sledges. It is bought up by the buyers connected with exporting houses, and by them "bracqued" or sorted into its various qualities. It is then baled up in bass matting or tied up in "bobbins," and shipped to Scotland, Ireland, France, or Belgium.

Among the sorts of flax shipped from Riga are the Crown flaxes, the Hoff's, the Wracks, the Drieband, the Zins, and the Ristens. The marks of the Crown flaxes are K, PK, SPK, HK, HPK, HSPK, GK, GPK, GSPK, WK, WPK, WSPK, ZK, HZK, GZK, R, HR, GR, and WR, the letters meaning respectively, K=kron or crown, P=puik or picked, S=sanft or sweet, superior, H=heel or yellow, G=grau or blay, Z=zins, W=weiss or white, R=risten.

The marks of the Hoff's flaxes are HD, PHD, FPHD, SPHD, SFPHD, WSD, WPHD, WFPHD, and WSFPHD. Here H stands for Hoff's, D for drieband (tied with three bands), F=fein or fine, and the other letters as in the Crown. The marks of the Wrack flaxes are W, PW, HPW, GPW, and WPW. W means Wrack and white, the other letters as in the Crown.

The Drieband marks are D, PD, SD, PSD, LD, PLD, and DW. S here means Slanetz, and L = Livonian. Pernau "District" flax is grown in the neighbourhood of Pernau, and shipped in the state in which it leaves the peasants, with a good deal of shove left in the top end. Pernau flax is this "district" flax opened out in Pernau and partially re-scutched, making it worth £2 per ton more. Flax shipped at Pernau comes from either of two districts, Livonia or Fellin, the latter being of a finer quality and fetching £2 per ton more. The Pernau marks are LOD, OD, D, HD, R, and G. For Dunabourg and Kowns flaxes the Riga marks are usually employed. For Ostrow the marks of both Riga and Pskoff are used, and sometimes figures also. Pskoff flax is usually classed as OD, PW, W, OW, O, OO, OOO, PI, PII, PIII. Flax from Reval and Dorpat is exported in bobbins, and has usually been re-scutched. The following are the ordinary marks : G, R, HD, D, OD, and OOD.

The principal districts from which the flax known as Archangel comes are Vologda, Ustjuga, Jaroslav, Kama, Totma, and Viatka. Its marks are 1st Cr., 2nd Cr., 3rd Cr., 4th Cr., Zebrack No. 1, and Zebrack No. 2. Archangel flax is dew-retted, and is usually of a silver blay or reddish foxy colour. It is exported in bales weighing each about 500 lbs. The tare at Archangel varies according to the weight of the mats. The weight of the cords is not deducted. Navigation on the White Sea is only open from June to October. The Bracque, official and compulsory, exists in Archangel. Flax which has not been bracqued cannot be exported from this port.

The flax exported from St Petersburg is either Slanetz (dew-retted) or Motchenetz (water-retted).

Slanetz flax, which is exported in mats, is usually classed into 1st Cr., 2nd Cr., 3rd Cr., 4th Cr., Zebrack No. 1, and Zebrack No. 2.

Motchenetz flax is classed into Obernoy 12, 9, and 6 head. It is exported in bobbins.

At Königsberg, part of the flax is classed on the present Riga method, and part by the old classment, which is—

FWPCM = fine white picked Crown Marienburg.

FGPCM = fine grey picked Crown Marienburg.

WPCM = white picked Crown Marienburg.

LPCM = light picked Crown Marienburg.

FPCM = fine picked Crown Marienburg.

PCM = picked Crown Marienburg.

P1 = picked No. 1.

P2 = picked No. 2.

The "rise" in price for the various marks varies with different years. Take Riga, for instance, with K as base at £18 per ton. The "rise" in

lbs. per ton for the several marks are :—H = 1, P = 3, S = 4, G = 3, W = 4, and Z = 10.

The Russian weights used in the flax trade are the Berkowitz = 10 puds = 400 Russian lbs. = $356\frac{1}{2}$ English lbs. ; the pud = 40 Russian lbs. = $35\frac{1}{2}$ English lbs. The money used is the rouble, which at par is equal to 3s. 2d.

Ireland.—Almost every flax-growing district of Ireland has its special characteristic. Cookstown district is one of the best, producing a strong warpy flax. Magherafelt, Randalstown, Lisnaskea, Armagh and Newry all produce good flax. Monaghan, Cootehill and Ballybay are, as a rule, of medium strength. Strabane and Letterkenny are generally very wefty and badly handled. County Down flax is very often of a light colour, and a large-fibred thread flax. Strabane, Letterkenny and Ballymoney flax is generally made up in large bundles containing about three stones, and sold at so many shillings per cwt. In the other Irish markets flax is sold per stone of 14 lbs.

Irish hand-scutched flax is getting rarer and rarer. Hand-scutching used to be a favourite winter occupation for the farmer's family, but old times are changed, and the flax is now almost invariably sent to the scutch mill. To facilitate the hand-scutching process the peasants dried the straw in the smoke of the chimney, which gave the flax a smoky smell and an appearance not unlike Riga flax.

Belgium.—The flax-growing districts of Belgium have likewise their characteristics, and the expert flax buyer can distinguish their products by their smell and appearance.

Flax from Lokeren and St Nicholas is generally of medium strength. The Bruges and Wetteren districts produce a very strong flax. Ghent and Waereghem flax is usually badly scutched. Malines flax is not so strong as Bruges, but is fine, and a superior weft flax. The Ypres district produces a good strong flax which has a good deal of spinning quality and yields well. The above-mentioned Flemish flaxes are what are termed the "blue flaxes," being steeped in still-water dams or "holes," in distinction to Courtrai flax, which is of a yellow or golden colour on account of its having been steeped in the waters of the river Lys. The steeping of flax is a very important industry in the neighbourhood of Courtrai. Not only is the straw grown in the immediate neighbourhood employed, but the factors go out and buy up the best Dutch, Flemish and French flax straw, and bring it home to be steeped or retted in their river, which gives a particularly good result. The value of Courtrai flax is in some measure due to the skilful manner in which the flax is handled and scutched—a result brought about by the system of treating the flax on such a large scale. It is a pity that a co-operative system of steeping and scutching by experts has not been introduced in other districts and lands, for it is

impossible for the farmer to have the same skill at this particular work as the specialist.

The price of Courtrai flax is reckoned in crowns per sack. A Flemish crown = 5 francs 80 centimes or 4s. 7d. A Courtrai sack of flax = 41 bottles = $127\frac{1}{2}$ lbs. avoirdupois. There are therefore 72 bottles in a 2-cwt. bale, or 720 per ton. Bruges flax is priced in stuivers per stone of 8 lbs. $4\frac{3}{4}$ ozs. A stuiver = 9.07 centimes, or nearly one penny. There are 27 stones in a 2-cwt. bale of Bruges flax, or 270 stones per ton. In the Waereghem market a stone of flax weighs only 6 lbs. 11 ozs., so that there are 335 stones of this flax per ton. A Ghent, Wetteren or Welle stone is still lighter, there being 340 stones per ton. There are 360 stones per ton of St Nicholas, Malines and Lokeren flax. The confusion caused by the local differences in these old weights has led to the almost universal adoption of payment in francs per 100 kilogrammes. The Belgian towns and villages which we have just mentioned have their weekly flax markets in the winter months, which are visited by the buyers. Courtrai has an exceptionally small market, as most of the flax is bought up by the buyers at the scutch-mills.

The chief centres for Flemish dew-retted or Walloon flax are Tournai, Namur, Ath, Leuse, Liège and Gembloux. Flax from the Liège market is usually fine and well handled. It is sold per botte of 3 lbs. 3 ozs. There are consequently 700 bottles per ton.

Namur flax is often "stuffed" in the head and made up. Tournai is a strong and well-worked flax. Flax from Ath is also usually of good quality. In the Walloon districts the flax is sold at so many sous per botte. A sou is equal to one halfpenny.

Holland.—Dutch flax, which is sold in stuivers per stone of 6 lbs. $3\frac{1}{2}$ ozs., is usually of a dark colour, having been steeped in holes in peaty land. The Dutch stuiver is worth about three-halfpence. There are 36 stones per 2-cwt. bale, or 360 stones per ton. The flax is almost all sent into Rotterdam, where the market is held every Monday. Dutch flax being grown in large farmer's lots, is much more regular than Flemish. Friesland flax is also shipped from Holland. It is a long, hard flax, usually used for coarse thread yarns. It is rather hygroscopic, having been steeped in brackish water. The flax is classed according to quality by letters, and the qualities subdivided into sorts by crosses, thus:—F, Fx, Fxx, G, Gx, Gxx, etc.

France.—In France, both the dew- and water-retted systems are in vogue, and, in the case of the Bergues district, both systems are employed upon the same flax, which is first partly dew-retted on the grass and then finished in the dam.

The river Lys, which has its origin in France, is again used for steeping purposes, but without the results obtained on the Belgian side. The chief

centres of steeping on the French side are Deulemont, Comines, Wervicq, Bousbecque, and Halluin. Flax from Valenciennes and Hasnon is fairly fine, and is paid for in francs per botte, of which there are 720 per ton. The flaxes of Flines and Douai are of good quality and light colour. Bergues flax is strong and yields well, but is of a bad colour. The French flax known as "Lin du pays" is dew-retted, and comes chiefly from the districts of Prêmesques and Beaucamps.

Flax grown in the Picardie district is generally dew-retted. It is badly handled, fire-dried, hard and poor. It is chiefly used for coarse dry spun yarns.

Flax from the Moy district is water-retted and sold per botte, of which there are 730 per ton.

Bernay flax is paid for in francs per 110 French pounds, of which there are 2040 per ton.

Hemp-growing Areas.—Russian hemp comes chiefly from the governments of Orel, Poltava, Kalouga, Simbirsk, Thernigow, Mohilew, Koursk, Tambow and Smolensk.

St Petersburg hemp is usually divided into three qualities called "clean," "outshot," and "half-clean."

The different qualities of Riga hems are distinguished by such letters as MR, BPH, POH, etc.

Koenigsburg hems include "clean," "cut," and "schiking," and are of a greenish shade.

Among the French hems are those of Picardie, which is white or grey, and of good and fine quality. Anjou hemp is light coloured, and has a strong and regular fibre. Hemp from the Bourgogne country is very coarse and brown, and only suitable for rope yarns.

The principal sorts of Italian hemp are Piemont and Bologne, which are often over twenty feet in length. Bologne hemp is smoked in the ordinary chimney or over the ammoniacal smoke of burning feathers, horn, etc., and has a silky and regular fibre. The base of Italian hemp prices is that of the mark PC.

In the United States of America hemp is grown in Missouri, Michigan, Illinois, Kansas, Tennessee, Minnesota and Kentucky.

In the Manila hems the whiteness of the fibre designates its grade. The ordinary qualities, such as are used for binder twine, include "current," "fair current," and "brown." Mauritius hemp is classed as "fair," "fully fair," and "good"; and New Zealand hemp as "good fair Wellington," "fair Wellington," etc.

Among the Indian hems are Bombay, Jubbalpore, Allahabad and Sunn hemp.

Hemp Prices.—The following list will give some idea as to the relative values of the various hems:—

	£	s.	
Italian base PC,	36	0	per ton.
Russian Riga F.S.P.R.H.,	35	0	”
„ Riga summer dried F.S.P.H.R.,	32	0	”
„ Königsberg navy,	28	0	”
„ St Petersburg,	24	0	”
Manila “good current,”	36	0	”
„ “superior second,”	28	0	”
„ “good brown,”	26	0	”
„ fair current,	30	0	”
„ fair brown,	23	0	”
„ Sorsogon current,	30	0	”
„ fine marks,	45	0	”
Naples I. Paesano,	32	0	”
„ II. Paesano,	28	10	”
„ I. Marcianise,	28	0	”
„ II. Marcianise,	26	10	”
„ I. and II. Canapone,	28	0	”
Indian sun hemp,	15	0	”
„ sisal hemp,	29	0	”
New Zealand “fair Wellington,”	22	0	”

Jute Marks.—Jute fibre is classed as “first,” etc., and the various qualities denoted by such marks as Heart JC, Lightning D, Circle SSS—D, Triangle RB—2, Red Diamond SS—2, etc.

China-grass.—China-grass is chiefly shipped from Hong-Kong, the price being from £50 to £60 per ton.

Fibre-selling Conditions.—The usual conditions of sale and expedition of fibre are as follows :—

F.O.B. The seller must put the fibre on board the ship at the port of export. The buyer must furnish the ship for the time of delivery arranged.

C. and F. Cost and freight. The selling price includes the cost of the fibre and the freight. The buyer must insure it.

C.I.F. The selling price covers all cost, insurance and freight. The insurance is usually made according to the conditions of the picking clause when the insurance company agrees. It is made at the risk and peril of the buyer, on whom falls the responsibility of the solvability of the insurance company. He has the right to demand a policy of insurance. In the C. and F. and C.I.F. arrangements the freight is deducted from the invoice and paid to the captain by the buyer, on the arrival of the bales. In the F.O.B., C. and F., and C.I.F. arrangements, the fibre travels at the risk and peril of the buyer. The mats for stowing the fibre in the ship, the harbour dues at the port of arrival, the duty, if any, and statistics, are at the cost of the buyer. The invoice is made out at the place of shipment, and the quantities allow a latitude of 5 per cent. more or less. Delivered on the quay :—The cost of discharge, weighing and putting on the quay, are paid by the seller. Delivered at station :—

All cost and risk are at the expense of the seller until the bales arrive at the station. Delivered on waggon:—The cost and risk are borne by the seller until the bales are put upon the waggon.

In the three latter cases the invoice is made out according to the weight found by a sworn weight-master at the port of arrival. The weighing is done in draughts of not less than 3 cwts.

The cost of lading by a railway company is included in the cost of transport.

In the case of shipwreck or fire the seller is not bound to replace the fibre lost or destroyed.

When fibre to be sent by railway is sold "free on rails" or "on waggon" at the place of expedition, the seller must put the bales on the waggon and furnish a receipt for same. The cost of lading is, of course, included in the cost of transport.

When the sale price includes the cost of the fibre and its transport, the seller deducts the cost of transport in conformity with the terms of the International Tariff from the invoice, the buyer having to pay it on the arrival of the bales. In this case the fibre travels at the risk of the buyer.

When the bales are to be delivered at the station at the place of destination, the risks of the road are run by the seller, who must pay the cost of transport, duty, and statistics.

The sending of the bales in a fixed time only involves the obligation to put the fibre on board the ship or train before the expiration of the appointed time.

The tare usually allowed on Russian flax and tow is as follows:—At Archangel the tare given corresponds with the weight of the mats surrounding the flax, tow, or codilla.

At St Petersburg the tare is the actual weight of the mats and thick ropes. For flaxes without mats, such as Pskoff, Pava, Louga, and Soletsky, which are sent from St Petersburg, the actual weight of the large ropes is allowed.

At Riga and at the stores of Riga houses in the interior a tare of $3\frac{1}{2}$ Russian lbs., or nearly 3 lbs. avoirdupois, is allowed per mat.

For Reval, Narva, Pernau, and Ostrow in bobbins or mats, no tare is allowed for cords.

For sales F.O.B. payment is made by bills at three months from the putting on board, or at three months from the time arranged for delivery, if the ship does not arrive at the proper time for loading.

The most usual conditions of sale concerning the quality of Russian flaxes are:—

At St Petersburg, the average quality of the deliveries of the dealer as indicated in the contract of sale. The average quality of a growth, Vologda, Yaroslaw, Ouglich, Rjeff, etc.

At Archangel, the average quality of the Bracque at this place.

At Riga, Pernau, Reval, Pskoff, Ostrow, Narva, etc., the average quality of the Bracque of the seller.

Duty on Fibre.—The raw fibre may enter free of duty into almost every country. The few exceptions are :—

(1) The United States of America, which imposes a duty of $\frac{1}{2}$ d. per lb. on raw flax, and 20 dollars per ton on flax and hemp tow ;

(2) Russia, where the duty on raw jute is 1·08 roubles per pud ; and

(3) Switzerland, where flax, hemp, jute, and ramie alike pay the small duty of 3d. per cwt. to enter.

Fibre Exports.—

EXPORTS.

	Jute.	Flax.	Tow.	Hemp.
	tons.	tons.	tons.	tons.
Belgium exports annually	33,000	9 400	4,800
Holland " " " " " "	...	4,700	1,400	13,000
Russia " " " " "	...	203,000	39,000	39,000
Italy " " " " "	3,000	50,000
France " " " " "	...	13,000	400	300
India " " " " "	560,000	11,000

CHAPTER IV.

STORING THE RAW MATERIAL, AND THE PRELIMINARY OPERATIONS OF BATCHING, SOFTENING, KNIFING, ROUGHING, BREAKING AND CUTTING.

Stocking and Sorting.— It is usual for spinning concerns to hold at least a few months' stock of raw fibre, bought, if possible, at a favourable moment, when the price is comparatively low. The holding of a stock of fibre is essential, if orders are to be accepted in advance without risk of losing money. The fibre is delivered in bales, mats, or "bobbins," according to its nature and origin. It should be placed in a dry, but cool, store, sheltered from the sun, as the beams of the latter often cause annoying changes of colour and evaporate the natural oil or spinning quality of the fibre. It is advisable to have good light available to examine and sort the fibre if desired, to roughly classify it into warp and weft, light and dark coloured, etc. Light-coloured Manila, for instance, is much more valuable than the common brown, and may sometimes be found in small quantities among the commoner colour. Specially light and specially dark flax yarns are sometimes in request for special purposes, rendering it profitable to sort out these colours even in small quantities. In flax spinning mills the most valuable fibre is sorted piece by piece by the hacklers, and to assist them it is advisable to "weigh off" the fibre bale by bale, and in farmer's lots when possible—that is to say, to keep together the flax which has been grown in the same field and watered in the same water. The less valuable fibre, in order to produce a cheap yarn, is often only roughly sorted and sent to the spread boards in "tipples." In this case, in order that the yarn produced may be regular in quality, the more thoroughly the raw material, which has been roughly selected, is mixed, the better. The larger the quantity that is mixed, so much the longer will the material run without abrupt changes in colour; and if a system of mixing on a large scale be adopted, much trouble will be avoided with striped yarn, and qualities will be much steadier. Fibre, to be used in this way, after being roughly sorted, may be sent to its mix and spread in an even layer over the whole extent of that mix, the thickness of the layer depending upon the extent of the mix and the quantity to be

added. Other small parcels are added in layers until the mix contains the desired quantity of material, when the completed lot may be closed and worked off as required.

In taking fibre from the mix it should be taken out "of the face," or downwards, taking a proportional part of each layer, so that the quantity taken may contain parts of the original parcels proportionate to the original weights of the latter. In this way the lot may be worked off to the end without any change in the colours or quality of the yarn produced being experienced.

Book-keeping.—An invoice book should be kept, in which are entered the invoices as they arrive, with remarks on the quality of the fibre, the lots to which it is put, and the shortage or surplus in weight received. A "Lot Book" should also be kept, in which an exact account is kept of the quantity of fibre put to each lot, with notes as to its quality. In this way fibre of various qualities may be stocked in suitable quantities, and the same may easily be found and "weighed off" as required.

A "weigh-off" book should also be kept, in which a note is made of the quantity of each sort weighed off each day. When a lot runs out, the weight weighed off should of course total up to the weight of the lot as recorded in the lot book.

Soft Fibres.—Soft fibres, that is to say, flax and the true hems, if to be spun into yarns finer than say 1000 yards per lb., must be hackled or split up into fine filaments, the most advantageous degree of hackling depending upon the quality of the fibre and the fineness of the yarn into which it is to be spun.

Hard Fibres.—Hard fibre, comprising Manila and New Zealand hems, cannot be split up fine, and is spun into coarse yarns in its natural state. In some American ropeworks, where large quantities of Manila are run through daily, a machine called a "scutcher" is sometimes employed to open out the ends of the fibre before passing it on to the first breaker or combined spreader and hackler (figs. 27, 28, and 29).

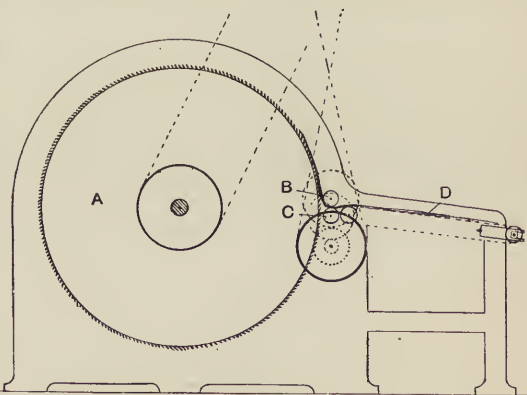

FIG. 4.—Knifing machine.

Knifing.—Some classes of Indian hemp, intended for spinning without being hackled, may have their flat or flaggy ends treated in the "knifing" machine (fig. 4). It will be seen that it consists of a toothed cylinder A,

running at a speed of about 200 revolutions per minute. In the rear of the cylinder, and horizontal with its centre, are a pair of fluted rollers B and C, driven independently from the toothed cylinder by a separate belt, as shown. By a suitable arrangement of three pulleys—one of them being a loose one—and a long handle for shifting the belt from one to the other, the feed rollers may be stopped or driven at will in either direction. In this way the operative is enabled to spread a "strick" of fibre upon the

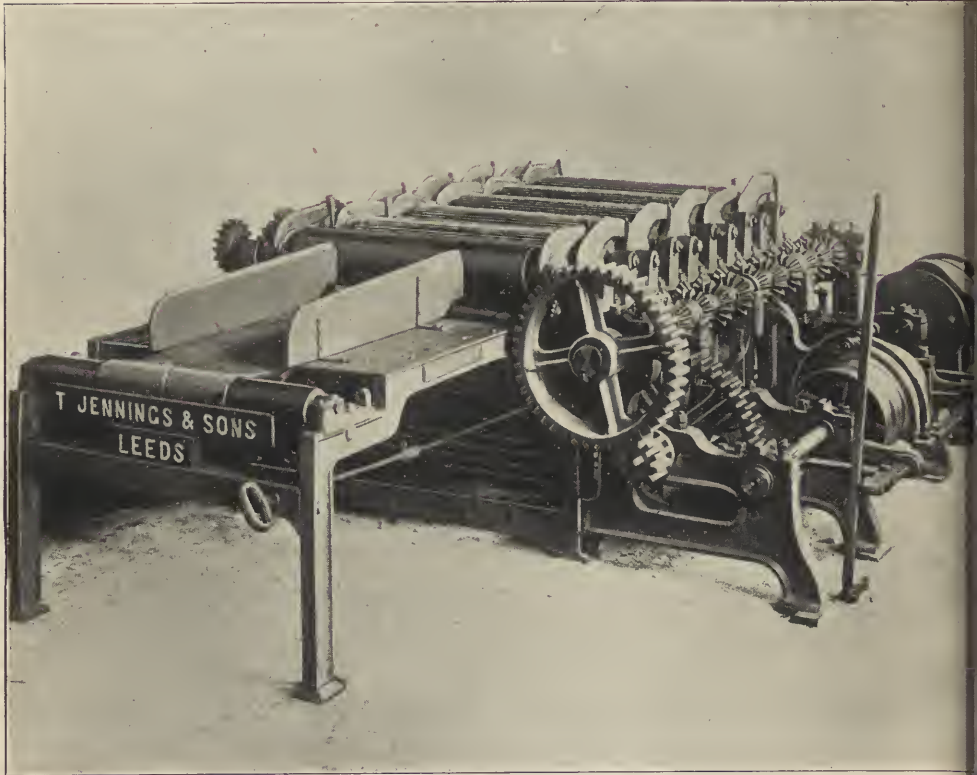

FIG. 5.—Horizontal hemp softener.

endless feed sheet D, introduce the bad end between the feed rollers as far as required, retain it there until the toothed cylinder has acted upon it sufficiently long, and then withdraw it again without danger to herself. The flat ends and fibre cut away are thrown down below the cylinder, and may be prepared for spinning inferior yarns in a way to be described later on.

Batching Jute.—Jute has the property of being softened and improved in its spinning qualities by the application of a mixture of oil, soap, and

water. The process known as "batching" consists in spreading the fibre in layers, the oil being applied to each layer with a watering-can. The pile should be allowed to remain from twenty-four to forty-eight hours, in order that the lubricative may be absorbed by the fibre. The quantity of oil and water to be applied varies from 25 to 30 per cent. of the weight

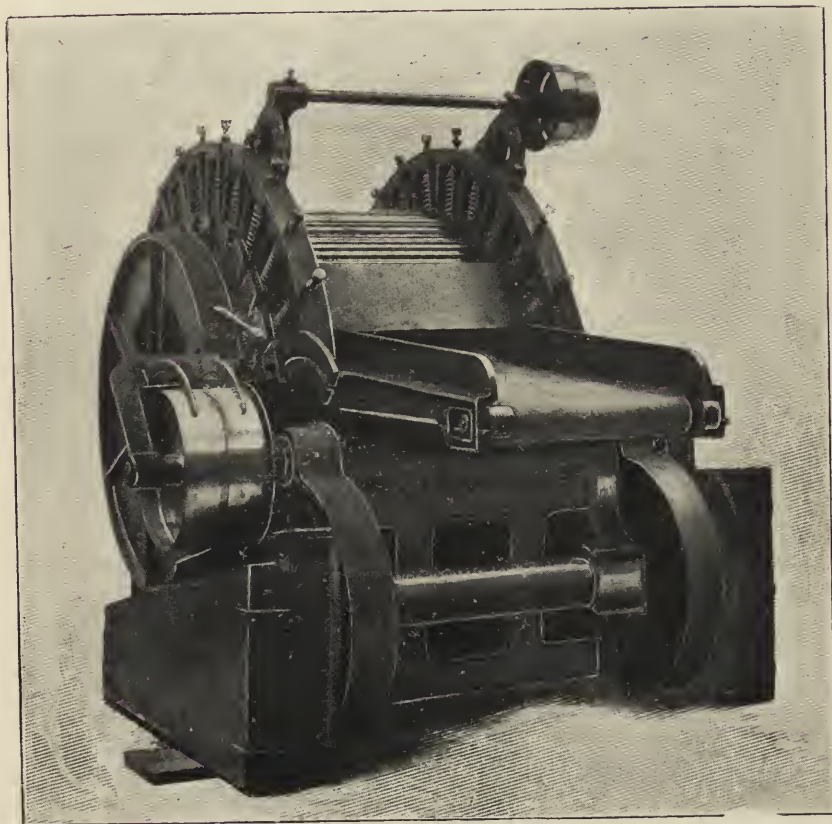

FIG. 6.—Circular hemp softening machine, with reciprocating motion.
(Made by James Reynolds & Co., Belfast.)

of fibre treated. Jute will absorb more oil in summer than in winter. Almost 1 gallon per bale, or from $5\frac{1}{2}$ to 7 gallons per ton, is the quantity usually applied. The following oil mixtures are used:—

No. 1. Mineral oil, 2 gallons; whale oil, $2\frac{1}{2}$ gallons; seal oil, $2\frac{1}{2}$ gallons; water, 40 gallons.

No. 2. 1 part seal oil, 5 parts sperm oil, 1 part soap, 40 parts water.

No. 3. $1\frac{1}{2}$ parts mineral oil, 2 parts sperm oil, 2 parts seal oil, $\frac{1}{4}$ part soap in 30 parts water.

Hemp Softening.—The spinning quality of the finer hems is much improved by rolling under pressure. “Stricks” of hemp are sometimes formed into an endless band by splicing the root and top ends together, and run as long as necessary between the rollers of a machine similar to the yarn softener and polisher, fig. 99. Another old-fashioned softener which is still used, and which many spinners consider to give superior results to modern machines, is almost identical in principle with an ordinary mortar mill.

Two forms of modern softeners are shown in figs. 5 and 6, the one being a horizontal and the other a circular machine. For the same number of rollers the former, of course, occupies more floor space than the latter.

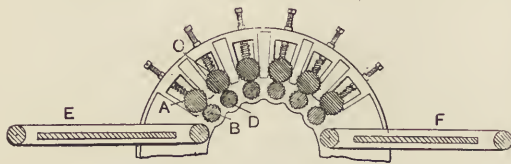

FIG. 7.—Hemp softener.

Fig. 7 gives some idea as to the arrangement of the circular machine. It will be seen that the fluted

rollers A B and C D are pressed together by strong springs, and have a reciprocating rolling motion given to them by gearing combined with cranks and ratchet wheels. The throw of the cranks is so arranged that the forward movement of the rolling rollers is greater than the retrograde, and the hemp being spread upon the table E, after being well rolled, is delivered upon the apron F.

Cutting.—Hemp is nearly always too long to be prepared and spun over comparatively fine machinery without being first cut into lengths of about 24 inches. A cutter, as represented in fig. 8, is generally employed for this purpose. A is a circular knife or cutter, about 21 inches in diameter, and driven from a counter-shaft by a belt as shown, at a speed of about 900 revolutions per minute. B B B B are four pairs of holding rollers, each two pairs being acted upon and pressed together by the weight W, acting through compound levers and links as shown, and exerting a pressure of more than one ton, distributed between two pairs of holding rollers. The cutter blade A consists of three steel rings, each about $\frac{1}{4}$ inch thick, placed side by side and keyed upon a shaft supported by the gables of the machine, and carrying the driving pulley keyed upon one end. From the other end of this shaft a retarded train of gearing drives the bottom holding rollers, which are of east iron, 14 inches in diameter and 2 inches in face, with vertical or circumferential grooves or flutes of 1-inch pitch. The bottom roller has two flutes and the top roller only one, with two grooves. Each pair of bottom rollers is keyed upon a shaft at any required distance from the cutter blade, the ends of the shaft being supported and turning in blocks or brasses set in the standards. The top or pressing rollers are free to move up and down in slides in the gables,

and are driven by friction. The nip of the holding rollers should be horizontal with the centre of the cutter and in the same vertical plane as the periphery of the blade. The rollers are set one on each side of the cutter with a space of about $\frac{3}{4}$ inch between. Upon the rim of each of the rings composing the cutter blade are projecting teeth of diamond-shaped construction, placed at distances of about 3 inches apart. It is most important that these teeth should be of the proper shape and bluntness to cut through the fibre without shearing the ends quite square, which would seriously affect the combining and spinning properties of the fibre. The holding rollers make two to three revolutions per minute.

The machine being started and having attained full speed, the cutter.

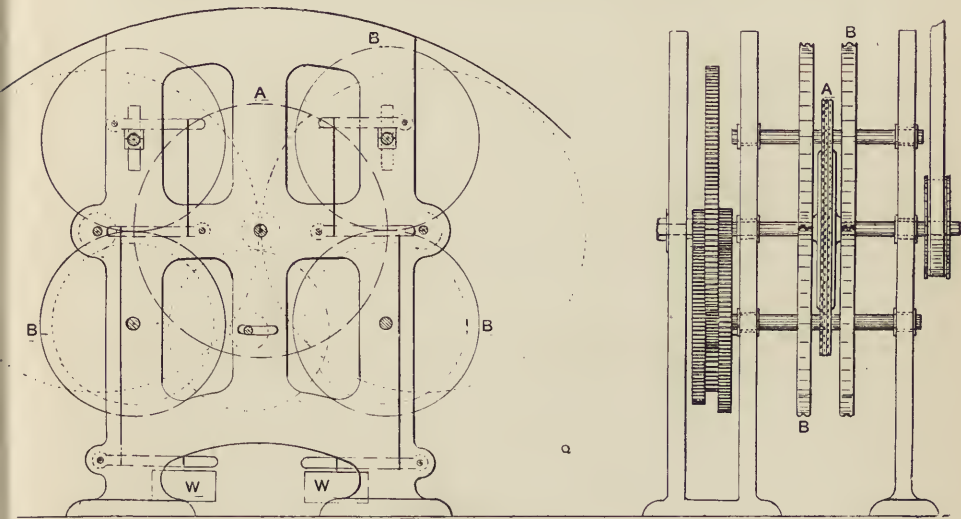

FIG. 8.—Flax cutter.

boy takes a large handful of fibre, and standing in front of the machine, holds the fibre firmly with both hands, and allows it to pass in between the holding rollers with the part to be cut opposite to the cutting blade. He holds the piece firmly and bears down upon the bottom rollers, his hands passing outside them, until the cutting is complete, when he withdraws the cut pieces. A boy can thus cut about 4 cwts. of hemp per day.

Flax, although seldom too long to work without cutting, is sometimes cut upon this same machine with a different object. It is almost impossible to procure flax long line capable of being spun into the finest and best quality yarns. The reason is that the ends of the fibre are more or less imperfect. The root end, which ripens first, is often coarse, dry, and flat-fibred. The top end, which bore any branches the plant had, is fine and "nappy," both root and top being inferior to the middle portion.

It is to obtain this middle portion that the use of the cutter is resorted to.

Stacking.—To prepare flax for the cutter, the heads are opened and the fibre pieced out into large handfuls, which are lightly drawn over the rougher's hackle, in order to comb out and replace any straggling fibres which might otherwise go into the tow. This process is technically known as "stacking." It is then cut as we have described, the resulting "middles" being usually 14, 16, or 18 inches in length. The root ends often go as tow, but the top ends and sometimes the roots are separated into smaller pieces for the hackling machine, as, of course, are also the middles.

Piecing Out.—The "piecing out" of flax, hemp, or jute is the division of the heads into small handfuls or pieces, six or eight to the pound, which is a convenient size to enable the fibre to be properly hackled either by hand or machine.

Flax Roughing.—The roughing process consists in roughly straightening and parallelising the fibres, squaring the root end or otherwise replacing in position any fibres which may have been allowed through careless handling to slip from their proper positions. Its object is to save these straggling fibres from escaping into the tow, which loss would inevitably occur were they not properly held by the hand of the hand-dresser or the holder of the hackling machine. A result of the operation is the separation of the very coarsest tow or broken fibres which have been produced in the scutching process. Its separation at this stage is an advantage, since the machine tow is thus rendered purer and more valuable. It is only within recent years that "roughing" has been practised at all in Continental mills which spin much cheap Russian flax. The cost of the process is not always repaid when dealing with flax of low quality, the value of whose tow is almost equal to that of the flax itself. Roughing does not pay unless the product of the gain in yield in pounds and the value of the dressed line per pound exceeds the value of the extra tow which would have resulted through non-roughing.

Irish flax is usually so badly handled by farmers and scutchers that it practically *must* be roughed, while Courtrai, and in fact almost every description of Flemish and Dutch flax as well as fibre which has been cut, does not really require to be roughed but may merely be pieced out.

The rougher's tools consist of a coarse hackle or comb and a "touch pin," for squaring the end.

The rougher's hackle consists of a wooden "stock," usually of beech, $16\frac{1}{4}$ inches long by 5 inches broad and $1\frac{5}{8}$ inch thick. An area of $9\frac{1}{4}$ inches by 4 inches in the centre of this stock is studded with steel pins 6 inches to $7\frac{1}{4}$ inches long and of 5 or 6 B.W.G. There are generally eleven pins per row in length and five rows in breadth. The cost of a new hackle is about 15s.

The "touch pin" is a steel pin of square or triangular section set in a wooden or metal stock which is bolted to the beam to the left hand side of the hackle. The pin is usually of about $\frac{1}{4}$ inch side and projects 2 inches above the stock or block into which, in the case of a wooden block, it is tightly driven. When a metal block is used the pin is held by a bolt as shown in fig. 9.

Good touch pins can be made out of old files. The edges should be smooth, but not sharp.

The roughing process, briefly described, is as follows:—Piecing out.—Cutting open the head of flax, etc., the rougher separates the "stricks," "fingers," or large handfuls of which it is composed, and catching one near the top end, by a dexterous backward flick or throw he untwists and opens it. Holding the root end foremost he then proceeds, while holding the bulk in his left hand, to separate off, with the right, pieces which he can easily grasp between the forefinger and thumb. These pieces will weigh from 6 to 8 per pound according to the nature and length of the fibre. Before starting to rough, he prepares a quantity of these pieces, piling them

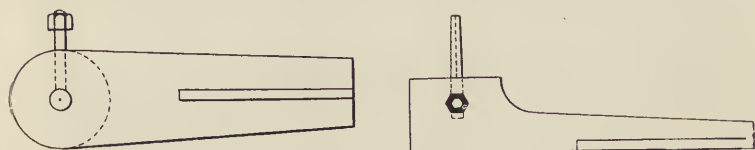

FIG. 9.—Touch pin.

in a particular manner, so that each piece keeps quite separate from the others and may be easily lifted.

He then proceeds to rough. Taking a piece in his right hand, top end foremost and spreading it well out the while, he pulls that end through the hackle, leaving in the latter the deranged fibres which are not held by his hand. He then draws out any which remain upon the corner pins of the hackle, retaining them there with the aid of the first finger and thumb of his left hand. Turning the piece he proceeds in like manner, and then catching the longest of the fibres which remain in the hackle along with the piece, he draws them out in such a way that they are replaced in the piece and level with the root end. He then laps the piece once round his right hand, and spreading the root end well out between his forefinger and thumb, he pulls it through the hackle in order to straighten and render parallel any matted and displaced fibres. Two "blows" upon the hackle usually suffice before breaking off or pulling out any irregular fibres from the end by a sharp tug, after having first lapped them loosely round the touch pin and held them there with the finger and thumb of the left hand. He then turns the piece and proceeds in like manner with the top end. When finished, he lays the pieces down upon

his bench, side by side, in layers, withdrawing his hand in such a way that the lap or twist remains, thus effectually keeping the pieces separate and enabling them to be easily lifted by the machine boy without tossing. Forming layer upon layer, he produces a "bunch" weighing about 40 lbs., which he ties round with three cords. When the rougher's hackle becomes filled with tow and fibre too short to be replaced in the piece, he grasps the longest of the fibres which project, and lapping them round the fingers of his right hand he lifts the whole from the hackle, and by a succession of blows upon the latter leaves in it the shortest fibres, separating the longer, which he lays to one side. Again grasping the longest fibres which *now* project from the hackle, he works off the tow upon the top of the pins.

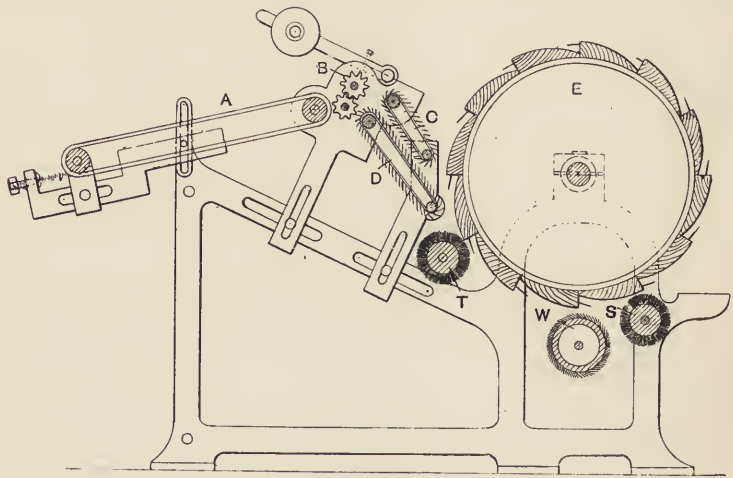

FIG. 10.—Filling engine for ramie.

The short fibres which he has thus saved are called "shorts," and are made into a separate bunch and worked apart upon the machine. When flax, hemp or jute is merely "picced out," the pieces are crossed one over the other in such a way that they do not intermingle, but are easily lifted without tossing.

Filling Engine for Ramie.—The way in which ramie or China-grass which has been degummed as described on page 7, is prepared by combing or hackling in the largest ramie spinning mill, seems rather a wasteful one. It is that employed for waste silk, and is accomplished as follows.

The fibre, which, after the boiling, steeping and washing treatment it has undergone, is considerably felted and matted together, is spread upon the endless sheet A of the machine, fig. 10, delivered through a pair of fluted feed rollers B to the toothed feed sheets C and D which

hold and parallelise the fibres, while the teeth of the cylinder E carry them gradually away. The fibres are still further straightened upon the surface of the cylinder by the action of the worker W. This worker and the feed sheet are kept clean by strippers S and T, which are in turn stripped by the cylinder. The cylinder has no stripping mechanism, so that the fibre accumulates upon it, enveloping it completely, when it is stopped for stripping by hand. The cylinder is clothed with heavy wooden lags bevelled off in the manner shown, leaving recesses, in the edges of which strong teeth are set. When the operative wishes to strip the cylinder he takes a large pair of shears and cuts right across the face of the cylinder at each recess dividing the fibrous envelope into sheets of fibre about 10 inches long, ready to be placed in the "books" of the ramie or silk waste dressing frame, which we will describe in our next chapter.

CHAPTER V.

HACKLING BY HAND AND MACHINE.

Hand-dressing.—Hand-dressing, or hackling by hand, is still continued to a considerable extent. Under certain circumstances, fibre carefully hand-dressed will yield more line than if it were passed over the hackling machine. This is especially the case with very soft and weak flax, which, if properly supported by the left hand of the hand-dresser, as will be presently explained, is less strained and broken than it would be by the hackles of the machine acting at a considerable distance from the nip of the holder. Hand-dressers are now chiefly found in small country mills spinning flax or hemp, and in the farmhouses in the outlying districts of Russia and Italy, whence come the supplies of such tows as Kama and Strappatura.

The hand-dresser's tools are usually three in number, viz:—(1) A rougher's hackle, as already described; (2) a finer hackle or "ten"; and (3) a still finer hackle or switch, all three being screwed to a wooden block which is bolted to the beam which runs along the top of the berth or tow-box. The hackles should be slightly inclined, as, on account of the height of the hackler, his pull is slightly upwards. A very convenient adjustable cast iron and slotted "block" is in use in some mills to replace the old wooden block which is more difficult to adjust to suit hacklers of different heights. The first hand-tool or ten consists of a beech stock $9\frac{1}{4}$ inches long, $3\frac{3}{8}$ inches broad, and $\frac{7}{8}$ inch thick. An area of $7\frac{1}{4}$ by $2\frac{3}{8}$ inches in the centre of it is set with steel pins $4\frac{1}{4}$ inches long over all, and usually of 13 B.W.G. There are often twenty-six pins in the length of the row (the term "ten" being a misnomer), and seventeen or eighteen rows in breadth. The pins are grouped as in a rougher's hackle, the pins in one row being opposite the spaces in the neighbouring rows.

The stock of the switch is usually covered with sheet brass. The stock is $\frac{5}{8}$ inch thick, $8\frac{3}{4}$ inches long, and $2\frac{3}{4}$ inches broad. The pins occupy an area of $7\frac{1}{4}$ by $2\frac{3}{8}$ inches in the centre, and may be $1\frac{1}{2}$ inches long over all. The fineness of the tool is gauged by the number of pins in a row of $7\frac{1}{4}$ inches, 180 being a suitable number for coarse flax and Italian hemp. The switch has usually about twenty-two rows of pins in breadth, the pins

being grouped as before. A guard is sometimes applied to support and strengthen the front outer rows of pins. It consists of two bands of steel about $\frac{1}{2}$ inch broad, and rather longer than the tool. They are applied one in front of the first row of pins and the other behind the second or third row, and are then tightened together by means of screws inserted outside the tool. Sometimes about ten pins of strong wire are put into the rows at both ends of the tool in order to bear the "nipping," which, as will be presently explained, is very severe on the pins.

Flax and hemp and jute (cut to a convenient length) may be hand-dressed as follows. The fibre having been divided out into pieces, weighing six or eight to the pound, the latter are thoroughly roughed and cleaned out "up to the hand" upon the coarse rougher's hackle in a similar manner, but even more thoroughly than that in which the rougher does his work. When the fibres have been thoroughly cleaned out and rendered parallel upon the coarse hackle, the hand-dresser either proceeds directly to work them over the "ten," or, if he prefers it, he makes the roughed-out pieces into a bunch, and does not begin the second operation until he has prepared a considerable quantity in advance. Upon the "ten" the piece is again worked well up to the hand, being supported by and passed through the left hand held close up against the front row of pins of the hackle. The proper use of the left hand as a support is, as previously remarked, a very important point in obtaining yield through preventing the breaking of the long fibres.

The finishing tool or switch is employed in a similar manner. In the use of hand hackles it must be remembered that it is only the points of the pins which cut and split up the fibre into finer filaments, hence the piece should be kept well on the surface of the hackle, the proper and equal cutting of both faces of the piece being insured by turning it in the hand and giving a like number of "blows" to either side. In hand-dressing, the end is seldom broken upon the touch-pin, the loose fibres of the end being merely pulled out, and the end crimped and squared by lapping the extremity of the piece around the strong corner pins of the switch, when finishing the dressing operation and "nipping" or withdrawing the piece while pressing against and supporting the pins with the forefinger of the left hand. The piece is now held between the finger and thumb of the left hand, back uppermost, and some of the fibres of the root end lapped around it with the right hand, forming a "lap" which keeps the pieces separate when they are built into a bunch, and enables each to be lifted without tossing the others. A firm bunch about 20 lbs. in weight is built by placing the pieces in layers, one piece overlapping the other. The bunch is tied with three bands, and the ends "tipped up," after which it is ready for the line store or the spread board. "Tippling up" is the bringing together of the ragged ends of the pieces composing

the bunch and the lapping around them in the form of a top-knot of some loose fibres drawn out for that purpose.

Horner's Hackling Machine.—A modern form of hackling machine is shown in fig. 11. It is a vertical sheet brush and doffer machine, which is the type in most general use, especially for flax. In fig. 11 the fibre to be operated upon, which has been pieced out and perhaps "roughed" and cut as described, is tightened between two flat plates made of tempered steel plate bolted together by means of a screw and nut as shown in figs. 12 and 15. The screw is attached to the back plate by a screw and lock nut. The projecting portion of the screw is about $\frac{3}{4}$ inch in diameter, and is threaded about five per inch. The square nut is tapped out to correspond, both being case-hardened to resist wear. Each holder plate is slightly bent, both as regards length and breadth, so as to form a spring. The lower lips are bevelled off so that they may be brought nearer to the hackles without being struck. The holder, for the make of machine illustrated (Horner's), has two pins C, about 3 inches long and $\frac{5}{8}$ inch in diameter, fitted firmly into the upper corners of the lower plate and projecting 1 inch on the lower side. The lid is plain, with three holes bored in it—one in the centre to receive the screw, and one in each of the upper corners to receive the pins. These holders are placed between the two angular bars B, forming the sides of the "channel" or "head" in which the holders slide along upon the projection CC. The sides of the channel are supported and held together by bridge brackets, and thus form a long slot through which the holders hang, and along which they move at regular intervals. The channel extends the full length of the machine, which is now frequently over 20 feet long. It is suspended vertically over and between the hackling sheets D by leather straps attached at one end to the bridge brackets of the channel by means of a loop and pin, and at the other end to the lever E, to which is also suspended a balance weight W, by means of a strap passing over the guide pulley F. This weight should be sufficient to balance the "channel" with the holders which it usually contains. The head or channel is given a regular up and down motion by means of various mechanical arrangements, the one illustrated being a cam wheel G, which by means of an eccentric channel upon its reverse side, raises and depresses the lever H, which in turn communicates an up and down motion to the head through the connecting rod I. The height of the lift, or the distance required to raise the head to lift the fibre from the hackles, may be altered by changing the effective length of the lever H, or the point of its connection with the rod I. The holders are shifted along the channel, when the latter is at the top of its lift, by means of a catch-bar arrangement actuated by another eccentric groove J upon the cam wheel G. K shows one of the catches or "dogs" which shift the holders. A slot is provided to adjust the catch-bar in such a way that it shall finish

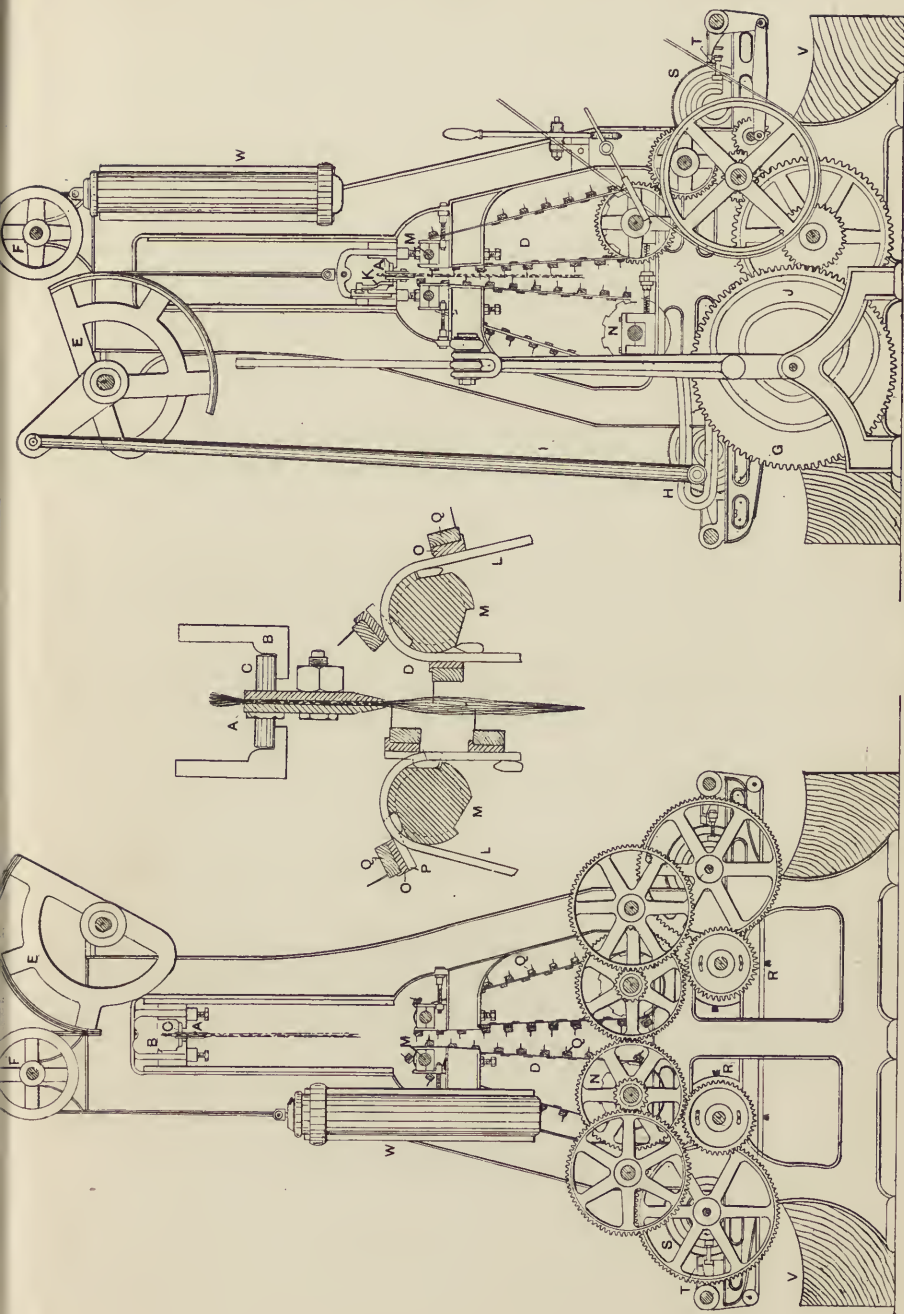

FIG. 11.—Horner's brush and doffer hackling machine.

its traverse in the correct position to bring each holder exactly opposite a tool or section of the sheet.

The channel has almost always a period of rest given to it while in its lowest position and whilst the hackles are operating upon the fibre. The amount of rest or dwell allowed is an important point, as too long a dwell, while the full length of fibre from the holder downwards is under the action of the hackles, causes the fibre to be broken, and reduces the yield, while a rest of too short duration gives insufficient hackling. In the machine illustrated, this period of rest is constant for any given lifts of the head per minute, but in the machines of some other makers it may be varied to suit the requirements of the fibre being worked.

In the cam-wheel head lift shown, a short rest is generally given to the head when raised and during the shifting of the holders, but in some makes of machines there is no rest at all at this point.

The hackling sheets D are formed upon a foundation of endless straps or "leathers," L, running round the top and bottom sheet rollers M and N, which keep them fairly tight, the latter being the driver. Upon these leathers, bars O are attached by screws to wing pieces P, the bodies of which are fastened to the leathers. In the machine illustrated the hackles are attached directly to the bars, so that in this way as the hackles are passing round the top roller the wings stand out at a tangent to the latter, which is also recessed to receive the body plate of the wings, thus decreasing its effective diameter and enabling the hackle to strike close up to the holder without the wings being unnecessarily long and consequently weak. The striking of the hackle close up to the nip of the holder, combined with direct penetration, is a most important point in machine hackling, as it affects the yield in a marked degree, since it determines the length of "shift" required in changing the fibre in the holder. The bosses N upon the bottom sheet rollers are notched, as shown, to receive the body pieces of the wings, and a means is thus afforded for carrying the sheets round without slipping. The pitch of the bars is from $2\frac{1}{8}$ to $2\frac{3}{4}$ inches according to the coarseness of the machine, and there are from twenty-four to thirty-two bars and rows of hackles in the round of the sheet. The length of the leathers or their outside circumference equals the numbers of bars multiplied by their pitch or distance apart—say for twenty-four bars $2\frac{1}{2}$ inches pitch, $24 \times 2\frac{1}{2} = 60$ inches. Both the top and bottom sheet rollers are adjustable horizontally, so that the working side of the sheets can be set more or less parallel.

The hackles Q consist of stocks of wood from 10 to 12 inches long, about 1 inch broad, and $\frac{3}{8}$ inch thick, studded with steel pins usually 1 inch long over all, and set in either one or two rows. The closeness of the pins in the row to each other is from $\frac{1}{4}$ pin per inch, or one pin in 4 inches to sixty pins per inch in the finer hackles used for the finest flax. Hackles

with only one row of pins are fast coming into general use, since they are more easily kept clean and free from gum by the brush. The hackle stocks of the finer hackles are covered with thin brass sheet to strengthen them. The brush R, which clears the hackles from tow after they have passed through the fibre, consists of an iron shaft the whole length of the machine, having bosses about 9 inches in diameter keyed upon it at regular intervals. To these bosses are screwed staves of wood, shaped so as to form segments of a circle. In these staves, or in laths attached to them, are set the brushes, formed of bunches of hog's bristles set in holes in the wood. The speed of the brush is made to conform with the number of rows of hair, the speed of the sheet, and the number of bars, so that each row of hair strikes a row of hackles as it comes round and strips off the tow. The position of the brush is below the bottom sheet roller, as shown, and it can be moved in and out to a position corresponding with the length of the hair, and such that the brush strikes the pin at its root and gives it a clear wipe without touching the stock.

The doffer S is a wooden roller rather longer than the brush, and covered with leather filleting set with pins. It revolves at a slower speed and in a direction opposite to that of the brush. The latter beats the tow into the teeth of the doffer, which carries it round until it is struck off by the doffing knife T, which is set quite close to the face of the doffer and has an oscillating motion given to it by an eccentric or crank and connecting rod. The tow falls into the tow-box V, which may be divided into compartments to classify the tows, which increase in fineness and quality towards the fine end of the machine.

Other Hackling Machines.—Other hackling machines in general use are Cotton's brush and doffer, Combe's brush and doffer, Horner's stripping rod, Cotton's stripping rod, Combe's stripping bar machine, Fairbairn's brush and doffer, and Dossche's French brush and doffer machine.

Cotton's Brush and Doffer Machine.—The chief points of difference in Cotton's machine from that just described are the head lifting motion and the method by which the bars and hackles are attached to the sheet leathers.

Cotton's head-lifting motion consists of a crank pin set in a radial slot in the head wheel. The crank pin works freely in another slot in the end of a link which communicates motion to the lifting shaft through the medium of a chain working upon a scroll. As the head wheel revolves, the fixed crank pin comes in contact with the bottom of the slot in the connecting link, and causes the head to rise until the crank pin reaches its bottom dead centre, when the head begins to fall again without rest or delay. It continues to fall until it reaches the end of its course and rests upon the adjustable stops provided. The length of time it remains there depends upon the adjustable length of the link. If the link be shortened,

the crank pin comes in contact with the end of its slot and commences to lift the head very soon after passing its top dead centre; while if the link be lengthened the reverse takes place and the head has a long rest at the bottom. In this way the length of rest and height of lift are regulated by the length of the connecting link and the position of the crank pin in its radial slot. If the action of this head wheel be carefully studied it will be seen that the vertical up and down motion of the crank pin varies, reaching its maximum as its path intersects a horizontal line drawn through the centre of the wheel. It is to remedy this defect that the aforementioned scroll is used to equalise the motion of the lifting shaft, and consequently the speed of the head. In consequence of the lack of rest, when the channel is at the top of its lift, the latter must be lifted rather high, if the dragging of the ends of the fibre through the hackles while the holders are being shifted is to be avoided.

In Cotton's machine the bars are fixed directly to the sheet leathers by means of brass eyelets, which receive projections upon the bosses of the bottom sheet rollers, and thus afford a means of driving the sheets without slipping. The hackles are attached to wings riveted to the inside of the bars, so that almost the whole sheet is closed. In passing over the top sheet roller, which is as small as possible consistent with rigidity, the wings to which the hackles are attached stand out tangentially and cause the pin points to penetrate the fibre directly and close to the nip of the holder.

Combe's Brush and Doffer Machine.—Combe's brush and doffer machine differs from those already described, chiefly in the head-lifting motion. Like Cotton's, this head motion has a head wheel with a fixed crank pin or stud upon which is a loose runner to diminish friction. This runner bears alternately on either side of a wide and specially shaped slot in a lever arm fulcrumed at one extremity, and connected at the other by an adjustable link with the lifting shaft. In this arrangement the special shape and construction of the lever arm gives a uniform lift and the desired rests without the employment of a scroll.

Horner's Stripping Rod Machine.—In Horner's stripping rod machine the same head and shifting motion is employed as in the machine illustrated in fig. 11. For good work a brush and doffer machine is to be preferred, the sole advantage of the stripping rod machine lying in the fact that it may be made double, the duplex pattern occupying much less floor space than a pair of brush and doffer machines. The stripper rods are wooden laths, 3 to 4 feet long, about 2 inches broad, and $\frac{1}{4}$ inch thick. The wood is shod with metal ends or "stripper cocks," which work in radial slots in the bottom sheet rollers. As these rollers revolve, the stripping rods shoot out by gravity, to the lower extremity of their slots, as they are carried round towards the under side of the roller, falling back again towards the centre as they approach the top. When falling from the

centre the rod passes close to the pins of the hackle, loosening the tow from them, the tow being then received upon a "tow-catcher," which deposits it in the tow-box every time the head rises.

Cotton's Stripping Rod Machine.—The stripping rod arrangement employed by Cotton necessitates the use of more rods—their number corresponding with that of the bars in the sheet. They are carried round with the sheet, and act, as do Horner's, on the principle of gravity.

Combe's Stripping Bar Machine.—Combe's stripping bar machine, used chiefly for coarse work, has a sheet of metal bars of the same pitch as the hackle bars, but exceeding them in number. This stripping sheet runs round the outside of the hackle sheet, its bars occupying the spaces between the hackles, its extra length enabling it to be drawn outwards from them at a given point by means of a tension roller, thus clearing away the tow.

Fairbairn's Brush and Doffer Machine.—Fairbairn's brush and doffer machine differs from those of other makers chiefly in the head-raising motion, which consists of a cam and a lever. The former takes the place of the head wheel, and makes one revolution for each rise and fall of the head. The lever is a long arm oscillating on a fulcrum at one end and having a long slot in the other end. In this slot a stud may be fixed in the desired position, a link connecting this stud with the lifting shaft. The lever presses against the surface of the cam and is thus caused to oscillate, and to raise and lower the head at speeds and with rests determined by the shape of the cam. The height of the lift is regulated by the distance of the point of connection of the link from the fulcrum of the lever. Since the slot in which this connection takes place forms an arc of a circle, the centre of which is the upper connection of the link, no change in the position of the rest is produced when the lift is lengthened or shortened.

Dossche's French Machine.—In Dossche's French machine the position of the brush is rather different from that preferred by English makers, and some spinners consider that it produces better tow. Dossche's brushes are placed higher up and considerably more on the outside of the bottom sheet rollers than are Cotton's, for instance, the object being that the brush shall wipe the hackle when the pins are almost horizontal, and that the tow shall be, in consequence, more easily removed and less liable to be beaten into the hackle.

Horner's Improved Lifting Motion.—Horner's improved lifting motion may be briefly described as follows:—Low down at the gearing end of the machine are two spur wheels geared into each other, and having runners working upon studs near the periphery of each. As these wheels revolve, the friction rollers alternately come in contact with either side of one arm of a T-shaped lever arrangement working upon a central stud. The other

arms of the lever are slotted to adjust the height of the lift, and connected by rods with a segment upon the top shaft of the machine. The dwell or rest of the channel when at its lowest point can be altered by means of adjustable hinges, through which the revolving wheels communicate motion to the lever, the amount of rest depending upon the point in the path of the stud in the aforesaid wheels where contact takes place with the hinges on the lever arm. The shifting of the holders along the channel is effected by means of a slide bar, upon which "dogs," or detents, are pivoted, which catch upon the bearing pins of the holder when moving towards the fine end of the machine, and slip over them when receding prior to making a fresh shift. These catch bars are actuated either by a cam wheel and connecting levers, as in fig. 11, or by means of mitre wheels transmitting the reciprocating circular motion of the top shaft to a short cross shaft, upon which is keyed a circular slotted disc with adjustable studs actuating the "catch bar" by a lever and connecting rod.

"Casting" or "Throwing-out" Motions.—Machines are often fitted with what is termed a casting or throwing-out motion, by means of which the holder may be ejected without subjecting its contents to the last or

two finishing hackles, thus in a measure enabling a fine machine to take the place of a coarser one. Motions to effect this purpose are numerous, one of the simplest consisting in a lever, one extremity of which works upon a stud fixed in the channel, while the other is connected to a long arm which slides in the channel and pushes out the holders. A point nearly midway up the lever is connected by a rod with the catch bar, the traverse of the throwing-out arm bearing the same ratio to that of the catch bar as does the length of the lever to the distance between its fulcrum and the point of connection with the catch bar.



FIG. 12.—Ordinary tipping for hackler.
(Apparatus supplied by W. Carter,
28 Waring Street, Belfast.)

Running a Hackling Machine.—The way in which the hackling machine is employed is as follows:—The "parcels" of fibre are removed from the

roughing shop to the machine room as required. The bunches are loosened from their bands and put upon tables at the coarse or filling end of the machine, the root ends being turned from the boys, who take two pieces at a time, and leaving the root ends projecting about 12 inches, place them level and flat, one piece on either side of the central screw, and spreading them well out upon the bottom of the holder, tighten the lid firmly down upon them. The holders are placed one at a time in the channel of the machine when it is approaching its highest point, and are then shifted automatically forward step by step, every time the head rises, over the

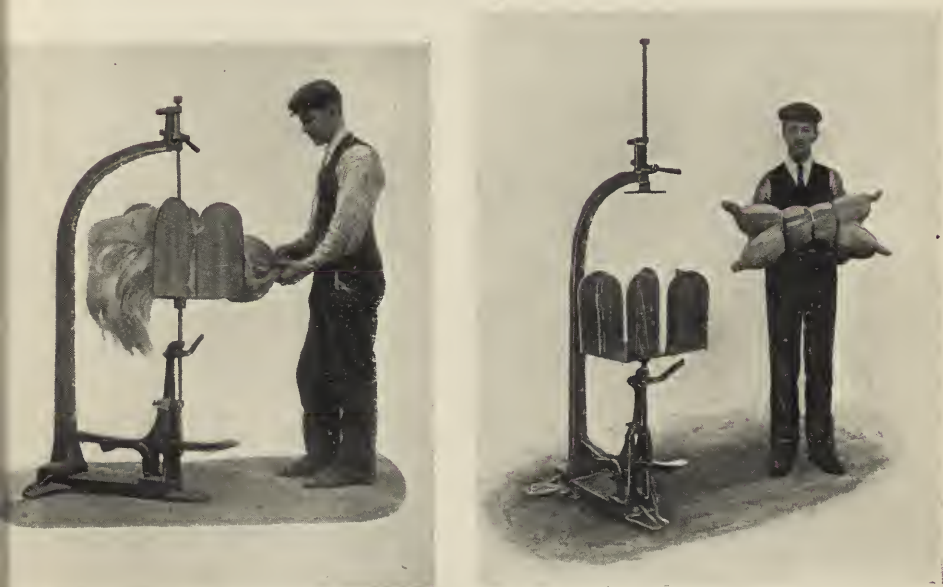

FIGS. 13, 14.—Tippling and tying for stores or spread-boards.
(Apparatus supplied by W. Carter, 28 Waring Street, Belfast.)

hackles, gradually increasing in fineness, until they are delivered at the fine end, where the holder is placed in a stand, another holder being placed in a corresponding position about $2\frac{1}{2}$ inches distant. The hackled end of the fibre is tightened into this empty holder, and the other being removed, the new holder, with the top end of the fibre now projecting downwards, is placed in the channel of the other machine, where it undergoes the same process and is delivered finished at the fine end. The boys remove the finished pieces from the holders, and crossing each piece in a "tipple box," such as is shown in fig. 12, form a compact bundle or tipple, the ends of which are tied or "tippled up" and the bundles removed to the sorter or direct to the spread-boards as the case may be.

Tippling.—One of the greatest inconveniences of spreading from the

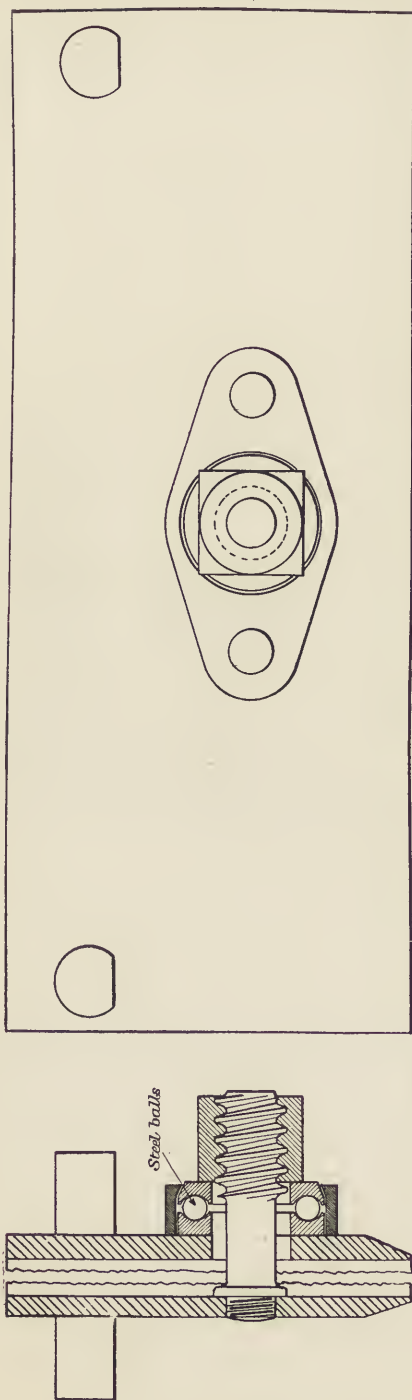

FIG. 15.—Anti-friction washer for hackling machine holder. (Supplied by W. Carter, 28 Waring Street, Belfast.)

“tipple” has hitherto been the difficulty of storing and avoiding the tossing of the fibre. This difficulty may be overcome to a large extent by the tipple press, as shown in figs. 12, 13, and 14. It affords a cheap, handy, and expeditious means of compressing the tipples as they are taken from the table of the hackling machine in the ordinary stools or boxes. Tipples intended to go direct to the spread-boards or into store are tied under pressure applied by the foot, the bunches thus made taking up little room.

In the ordinary way four machine boys are required per pair of machine. Two of them, called the “fillers,” place the pieces of raw material in the holders and insert the latter in the channel of the machine. At the same time they remove the handfuls of finished fibre from the holders issuing from the fine end of the finishing machine, and place them in the tipple box. The two boys at the other end of the machines are called “changers,” their duty being to change the holders from one machine to the other and to change the pieces end about. The machine boy’s work is heavy, and boys consequently scarce in many places. Their work may be considerably lightened, and the yield from the machine improved at the same time, by

the use of either anti-friction washers or anti-friction nuts for the holders.

Eves' Anti-friction Washers and Nuts.—The former is shown in fig. 15. It consists in a pair of circular steel washers, grooved as shown, to hold a ring of steel balls. The uppermost washer is slightly taper, and is held in place by a cover which is riveted to the holder plate as shown.

Fig. 16 shows the anti-friction nut referred to, which is the invention

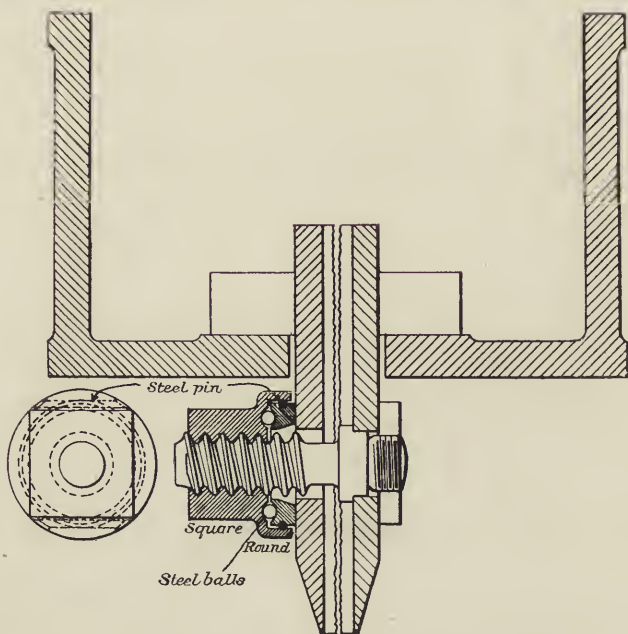

FIG. 16.—Eves' anti-friction nut for machine holders.

of the same gentleman, Mr Joshua Eves of Belfast, to whose inventive genius the flax spinning trade owes a great deal.

It is constructed on the same principle as the washer, the grooved steel washers and ring of steel balls being, however, in this case contained in the nut itself, rendering any work upon the holder unnecessary.

By the use of this washer or nut, the usual friction between nut and holder is so much reduced that with the same effort the holder may be tightened more than three times as tight, leaving no excuse at all for badly tightened or slack holders, which let the fibre slip and diminish the yield of dressed line very materially.

Reade, Crawford, & M'Kibbin's Automatic Screwing for Hackling Machines.—An important improvement in connection with machine hackling



FIG. 17.—Reade, Crawford, & M'Kibbin's patent automatic screwing for hocking machines. (Filling end.)



FIG. 18.—Reade, Crawford, & M'Kibbin's patent automatic screwing for hackling machines. (Changing end.)

has recently been patented and introduced by Messrs Reade, Crawford & McKibbin of Belfast, with the object of *automatically* serewing and turning the fibre in the holders of the hackling machine.

A slight modification of the holder is the starting-point of the automatic machine. The holder serew, instead of being rather nearer to the lower edge of the holder plates, as in fig. 16, is placed exactly in the centre, so that the holder may be used with either of its longitudinal edges downwards. The holder nut also is attached to the cover in such a way that, when the nut is unserewed, the cover is raised or separated from the bottom plate of the holder.

The machines are placed parallel to each other and are coupled together, one belt driving the pair.

The holder from the finishing end of the second machine is automatically delivered on to a cross channel and unserewed, permitting the hackled pieces to be removed. The holder is then passed on, and the cover is automatically raised in order that the boy may fill the holder with fresh pieces. When this has been done, the holder passes on under the serewing spindle, and after being tightened up, is automatically raised and placed in the channel of the first machine.

The changing end is completely automatic, and is somewhat similar to the filling end, the chief difference being that the holders are unserewed and serewed by the same spindle. While the holder is unserewed, the pieces are drawn through the holder a short distance, corresponding to the shift under the old system.

The pressure under which the holders are serewed is easily regulated, and, once adjusted, all the holders are equally tightened.

Figs. 17 and 18 give general views of the apparatus, the former from the filling and the latter from the changing end.

The chief advantages arising from the use of the machine are saving in wages, since *one* boy can now attend to one pair of machines. The machine boy difficulty ceases to exist, for a single boy or girl can do with ease what was heavy work for four boys. Better yield is obtained owing to the absence of slack holders. The fibre is less tossed, giving less tow in the sorting, or a straighter piece if spread from the tipple. The boy has more time to spread the pieces in the holder, which is of the utmost importance to secure well-ent fibre. The arrangement can be applied to existing machines (except Horner's duplex) without any structural alterations.

How to get the Maximum Yield from the Hackling Machine.—In most mills where the fibre employed is hackled, the yield in long fibre or line is not so large as it might be were more attention paid to the following points. To obtain a good yield, the handfuls of fibre should be no longer than the length of the longest individual fibre—in other words, if the

fibre is uncut or unbroken, or in its natural length, the root end should be level and square. Sometimes, in consequence of unskilful pulling, the stalks are allowed to slip, rendering the handful irregular.

In the scutching also the fibre may be spoiled in this respect, and it is the object of the roughing process to rectify these faults. If at least one end is not level and square there is a danger that, when screwed in the holder, some of the fibres will not be held at all, and even if they be held, an unnecessary length will be subjected unsupported to the hackle. The ideal to be arrived at is to have all the fibres square and level at one end at least, and to screw the piece in the holder, for the purpose of hackling the heaviest end in such a way that all, even the shortest fibres, may be perfectly held. In hackling flax, for instance, it will usually be found advantageous to leave about 40 per cent. of the length of the piece protruding from the holder for the purpose of hackling the root end.

The hackling machine should be constructed and set in such a way that the pins enter the piece directly and as near to the nip of the holder as possible, minimising to the greatest extent the length of "shift" required in changing the pieces in the holder for the purpose of hackling the top end.

With the best existing machines, the minimum shift possible is about $(n \times 2) + \frac{1}{2}$ inch, n being the distance from the nip of the holder at which the pin strikes the fibre.

If all the fibres are firmly held in the holder, only those which are cut away and broken will go into the tow. The fibres, unless excessively weak, will not be broken if presented to a sufficiently coarse hackle in a perfectly straight condition. The space between the pins must, of course, be greater or equal to the diameter of the fibre in order that it may pass without being broken. Excessively weak fibre will break owing to the strain put upon it by the splitting and cutting action of the hackle when applied at a distance from the nip of the holder. It is for this reason that in Scotland and in Ireland the spinner gets a better yield from some sorts of Russian flax by hand-dressing it, for the expert hand-dresser, as should also the sorter, so supports the piece with his left hand in drawing it through the hackle that much of the strain is taken off it.

Some flaxes will cut away owing to lack of quality and resistance to splitting produced by the presence of woody matter, branches, "black tick," etc., on the fibre.

If the shove be a loose one, it may be removed without carrying any fibre with it, but if firmly attached to the fibre and too large to pass between the pins, it will be cut away and carry some fibre with it. Black tick, being really engrafted with the fibre, and having a weakening effect upon it, will almost invariably cause it to break at that point in passing through a fine hackle.

The gradation of the hackles is a point of the greatest importance in machine hackling. Beginning with a coarse hackle, the fibre must be gradually operated upon by finer and finer hackles. The greater the length of the machine and the larger the number of rounds of hackles, the easier may be the gradation. A thirty-tooled machine is not unknown. In arranging the gradation it must be borne in mind that an increase of six or eight pins per inch in a fine hackle may be less in proportion and not so severe on the fibre as a rise of half pin per inch in a coarse hackle. In using fine hackles, the fibre is sometimes cut away through not having sufficient space between the pins nor enough accommodation in the hackle to receive the handful of fibre presented to it, for which reason it is impossible to pull the piece through such a hackle without breaking away some fibre. In order that the free spaces and capacity of a hackle may be calculated, we give the diameter in decimal parts of an inch, at their thickest part, of the pins in general use.

B.W.G.	Diameter in Inches.	B.W.G.	Diameter in Inches.	B.W.G.	Diameter in Inches.
No. 5	0·212	No. 14	0·079	No. 23	0·028
„ 6	0·192	„ 15	0·071	„ 24	0·025
„ 7	0·176	„ 16	0·064	„ 25	0·021
„ 8	0·160	„ 17	0·056	„ 26	0·019
„ 9	0·146	„ 18	0·048	„ 27	0·017
„ 10	0·130	„ 19	0·041	„ 28	0·015
„ 11	0·116	„ 20	0·037	„ 29	0·014
„ 12	0·103	„ 21	0·034	„ 30	0·013
„ 13	0·092	„ 22	0·031		

In hackling some sorts of flax, especially Courtrai, the pins of the finer hackles become clogged with a species of gum, which contracts or closes the spaces between the pins, prevents the hackle from doing its work, and breaks away the fibres which cannot be accommodated between the pins. For hackles above 20 per inch it is consequently better to use a single row of pins only, since a double row cannot be properly cleared from gum by the brush. Even with a single row it is an advantage that the machine should be provided with a motion by means of which the brush, while working at the same surface speed as the hackles, and striking and wiping each hackle in turn, may at regular intervals slow down and allow the hackle to pass through it, wiping the other side of the pins. The holders of the hackling machine must grip the fibre firmly, and in order that no fibre may escape from the holder, the latter must be kept in perfect order, lined with corrugated indiarubber and flannel to give a good gripping surface, and be free from burrs on the edges, so that their parts may come into perfect contact with the fibre. The handfuls of fibre must be spread

in a level manner over the surface of the holder in order that it may be gripped uniformly. Sometimes the boys neglect to tighten the holders and the fibre is pulled out by the hackles. It is here that one of the advantages of the automatic screwing arrangement, to which we referred, comes in. A better yield may be obtained by running the hackling machine slowly, say at half speed, with two boys instead of four. This result is due to the more gradual and easy lift of the head. The head should lift sufficiently high to clear the fibre completely from the hackle before the shift commences, in order that the ends may not be dragged through the hackle and cut away.

In the hackling machine the sheets are generally set more open at the coarse end, and point to point, or slightly intersected at the fine end. In setting them open at the coarse end the points act more gradually on the fibre, first only touching the outside, and then advancing deeper and deeper as the holder advances towards the fine end. The author does not believe in this method of setting, in which the outside of the piece gets more hackling than the inside, resulting in an uneven cut, while the finer hackles often act in the centre of the piece upon coarse fibres, which, until that moment, have been untouched, and which are often broken away by that fine hackle, producing a loss in yield and a mixture of coarse fibres in what should be the finer tows. Certainly, the gradation of the hackles should be so arranged that they may cut through and through the piece from start to finish, producing tow in regular quantities, and thus show that each is doing an equal share in the work. To carry this out, the flax must be well roughed and the first round of hackles rather coarser than they often are, while the pins should be set point to point at the coarse end, and $\frac{1}{16}$ inch intersected at the fine end. The final result will be a better yield, a more regular cut, and better tow. Below, we give a suitable gradation for various lengths of hackling machines with which our ideas may be carried out.

9-tooled machine for very coarse Russian flax, jute or hemp :—

Pins per inch,	$\frac{1}{8}$	$\frac{1}{4}$	$\frac{1}{2}$	$\frac{3}{4}$	1	$1\frac{1}{2}$	2	4	6
No. of wire B.W.G.,	8	10	12	14	15	15	16	17	18

11-tooled machine for coarse Russian flax, hemp and jute long line :—

Pins per inch,	$\frac{1}{4}$	$\frac{1}{2}$	$\frac{3}{4}$	1	$1\frac{1}{2}$	2	3	4	7	10	14
No. of wire B.W.G.,	10	12	14	15	15	16	16	17	18	20	22

11-tooled machine for medium Russian and Italian hemp :—

Pins per inch,	$\frac{1}{4}$	$\frac{3}{4}$	1	2	3	4	6	9	14	20	28
No. of wire B.W.G.,	10	14	15	16	16	17	18	19	22	23	25

11-tooled machine for medium Irish, Flemish, Dutch and Courtrai, and fine Russian flax, and fine Italian hemp :—

Pins per inch,	$\frac{1}{2}$	1	2	3	4	7	12	16	22	28	36
No. of wire B.W.G.,	12	15	16	16	17	18	21	22	24	25	26

16-tooled machine for fine Flemish, Dutch, Irish and Courtrai flaxes :—

Pins per inch,	$\frac{1}{2}$	$\frac{5}{8}$	$\frac{3}{4}$	1	$1\frac{1}{2}$	2	3	4	6	8	11	14	22	30	38	48
No. of wire B.W.G.,	12	13	14	15	15	16	16	17	18	19	20	22	24	25	27	28

20-tooled machine for very fine Courtrai flax, etc :—

Pins per inch.,	$\frac{1}{2}$	$\frac{5}{8}$	$\frac{3}{4}$	1	$1\frac{1}{2}$	2	3	4	6	8	11	14	18	22	27	32	38	44	50	56
No. of wire B.W.G.,	12	13	14	15	15	16	16	17	18	19	20	22	23	24	25	26	27	28	29	30

The "grouping" of the machine hackles is an important point not generally understood. Grouping is the dividing of the hackles, composing a round, into one or more groups, in each of which the pins are inserted in such a way that each strikes the fibre in a different place. It is evident that if each consecutive hackle is identical, the pins will always strike in the same place and accomplish comparatively little work, while if the hackles be grouped in the following manner, each pin will strike in a different place, and the maximum cutting be obtained. The rounds of coarser hackles on a 24-barred machine may be divided into two groups of twelve each or three groups of eight each, while the finer hackles have usually fewer tools in the group, say four or six, giving six or four groups to the round respectively, in a 24-barred machine. To form the group, mark off the line of the row on a number of hackle stocks, and place 4, 6, 8 or 12, as the ease may be, squarely together.

Mark off a good position, as regards strength, for the first pin to the left of the first hackle, and similarly, of the last pin to the right of the last hackle. Join these two points by a line which will cut the line of the row on each hackle in a point where a pin should be placed, and the other pins spaced off from this base. If, now, these groups be serewed upon the bars with the hackles in their proper order, and the first tool of the group on one sheet be caused to follow the middle tool of the group on the other sheet, the maximum result as regards cutting will be obtained.

To obtain the maximum yield the fibre should be neither damp nor dry as tinder. If the fibre be damp, it will offer more resistance to the passage of the hackles, more tow will result, and a nappy line and tow be produced, for when the material is damp, the fine fibres will run up between the pins, and form themselves into balls or naps. If the fibre be too dry, it will not split from end to end so well, but will tend to be cut away in the process. As a rule, the blue and yellow Flemish flaxes are quite damp enough, and may often be advantageously dried a little prior to hackling, while some stove-dried Russian flaxes may sometimes be advantageously cooled or worked in a moist atmosphere, obtained by a suitable humidifying system.

In setting the sheets of the hackling machine, it must be remembered that it is of the utmost importance that the pins of either sheet penetrate the piece to the same depth, or, in other words, that their points be

equidistant from a vertical line dropped through the centre of the bundle of fibres contained in the holder. If this be not the case, the piece will not be worked to the same degree on both sides. The construction of the holder and channel of the Horner type is rather different from those of the Cotton machine. In the former the position of the vertical line through the centre of the piece depends upon the thickness of the piece, while in the latter, with springs on both sides of the channel, its position is constant and corresponds with the centre of an empty holder. In setting the intersection of a Horner's machine, then, clamp a plumb-line in the centre of a holder packed with wood or cardboard representing the average thickness of the bundle of fibres to be hackled. In Cotton's machine it is not necessary to pack the holder, for the reason stated above. Place the holder in the resting channel at either end of the machine, with the plumb-bob hanging down, and set the sheets to their correct position.

In fixing the hackles upon the bars, No. 1 hackle in each group should be on the same bar and the others follow round in consecutive order, so that if, say, the No. 1 hackles on each sheet be placed point to point and the sheets geared and turned round, the numbers upon each sheet may correspond each to each. In working, the hackles must be "turned into group" so that the No. 1 hackle on the one sheet follows the middle number of the group on the other sheet. Thus with ten in the group, No. 1 hackle on one sheet follows No. 5 on the other, the hackles striking the fibre alternately, so that when intersecting they cannot strike one another. It may be seen at once if the hackles be correctly set by looking down from above between the two sheets. The pins in one sheet must appear to divide the spaces between the pins in the other. When viewed from the same point they will also appear in parallel rows, both extending from right to left, or *vice versa*.

The sheets are usually run at from nine to fifteen revolutions per minute, putting the pins through the fibre at the rate of 120 to 18,000 per inch per minute, according to the number of bars in the sheet and the fineness of the hackles. From five to six lifts of the head per minute, delivering the same number of the holders, is the usual speed working with four boys. At this speed a machine should put through 6 to 10 cwts. per day according to the size of the pieces and the length of the fibre. With the automatic screwing apparatus described on p. 44, a long line machine may be safely driven up to seven lifts per minute. The total lifts divided by the number of pieces to the pound will give the total pounds machined.

Cost and Speed of Machining.—The actual cost of machine hackling may be taken at about 9d. per cwt. In hackling flax the yield from the machine usually runs from 60 lbs. to 80 lbs. per cwt., or from 53 to 71 per cent.; the remainder, with the exception of 1 or 2 per cent., being tow, which is divided into four or more qualities (1, 2, 3, 4, etc.), according to

the position on the machines where it is taken off. The tow may be spoiled by having the parts of the doffing mechanism improperly set or in bad working order. If the fibre be badly roughed, very long or not sufficiently tightened in the holder, "ropey" tow is often the result. It is produced by the long fibres encircling the brush and keeping it from doing its work properly, they themselves failing to be stripped off by the doffer. Then, again, the doffer may be driven too fast or the knife too slow. The "eard" or doffer should make about one revolution for every ten of the sheet, and the knife about a hundred oscillations per minute. In order that the brush may strike every haekle, the number of teeth in the bottom sheet roller wheel must bear the same relation to the number of teeth in the brush wheel as the number of times the pitch of bars is contained in the circumference of the bottom roller does to the rows of hair in the brush. Thus in a 27-barred machine, $2\frac{1}{2}$ -inch pitch, circumference of bosses on bottom roller 25 inches, roller wheel 65 teeth, eight rows of hair on brush, the number of teeth which the brush wheel must have in order that the hair may strike every haekle, will be 52, or as—

$$\frac{25}{2\frac{1}{2}} = 10 : 8 :: 65 : 52.$$

The speed of the doffer, taking the same particulars in conjunction with roller pinion 24 teeth, stud wheel 110, stud pinion 27, doffer wheel 144 teeth, and speed of sheets ten revolutions per minute, is

$$\frac{10 \times 27 \times 24 \times 27}{10 \times 110 \times 144} = 1.1.$$

The speed of the knife taking the speed of the driving pulley at 72 revolutions per minute, the wheel on the boss of the driving pulley 50 teeth, and the eccentric or crank pinion 35 teeth, is $\frac{72 \times 50}{35} = 103$ oscillations per minute.

The lifts of the heads per minute, taking the speed of the line shaft at 120 revolutions, diameter of drum 16 inches, diameter of pulleys 16 inches, head pinion 30 teeth, stud wheel 108 teeth, stud pinion 16 teeth, and head wheel 120 teeth, will be

$$\frac{120 \times 16 \times 30 \times 16}{16 \times 108 \times 120} = 4.4 \text{ lifts per minute.}$$

The revolutions of the sheet per minute, taking the sheet pinion as having 20 teeth, brush shaft pinion 56 teeth, brush shaft wheel 54 teeth, roller wheel 84 teeth, catches in roller $\{(3+4) \times 2\} = 14$ and bars in sheet as 30, will be

$$\frac{120 \times 16 \times 20 \times 54 \times 14}{16 \times 56 \times 84 \times 30} = 12.8.$$

The Ending Machine.—When flax is to be sent to the spread-boards direct from the machine room, without being subjected to the hand hackling and sorting process, which we will treat of in our next chapter, another small machine is often employed to remove bad ends and loose fibres from the ends of the pieces. It is called an ending machine, two types being shown in figs. 19 and 20.

These machines work on two different principles, the object of the former being to cut off the bad end, and of the latter to improve it by additional hackling with a fine and quick hackle. A in both figures represents the extended end of the "channel" of the hackling machine, while B is the holder. In Erskine's tender, fig. 19, a pair of clamps E are

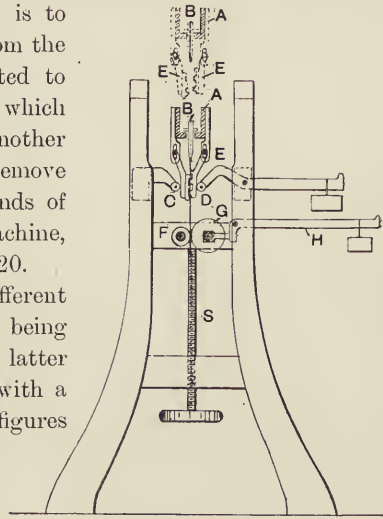

FIG. 19.—Erskine's tender.

hung from brackets attached to the channel A. While the head is raised these clamps hang clear of the bundle of fibres, but as it descends they are brought together by the friction rollers C and D, the latter upon the end of a lever as shown. The object of the clamps E is to hold the piece firmly in close proximity to the place where the revolving ending rollers F and G grip it, draw away any loose fibres, and cut away the remainder. To act properly, the ending rollers must be accurately ground to secure a perfectly parallel face. In order that they may bite the better, one or both of them is often scored spirally. The smaller roller F works in fixed brasses, while the bearings of the larger roller G move in a slide, the two rollers

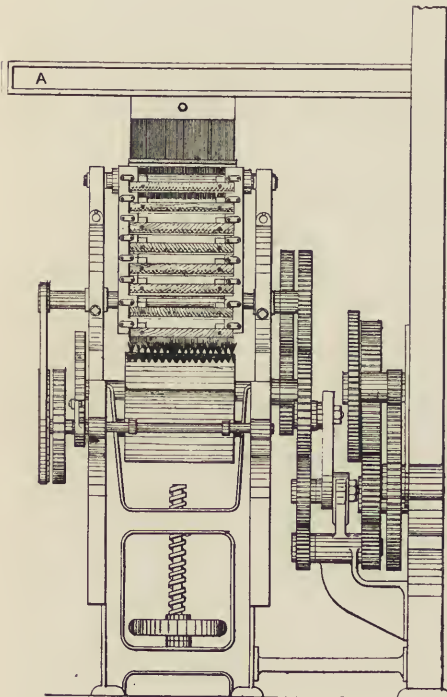

FIG. 20.—Cotton's end comb.

being pressed together by the thrust of the tail end of the weighted lever H, as shown. The rollers are driven by a chain from a sprocket wheel upon the extremity of the brush shaft, and may be raised or lowered bodily by means of the screw S, to suit various lengths of fibre, or to remove more or less of the end.

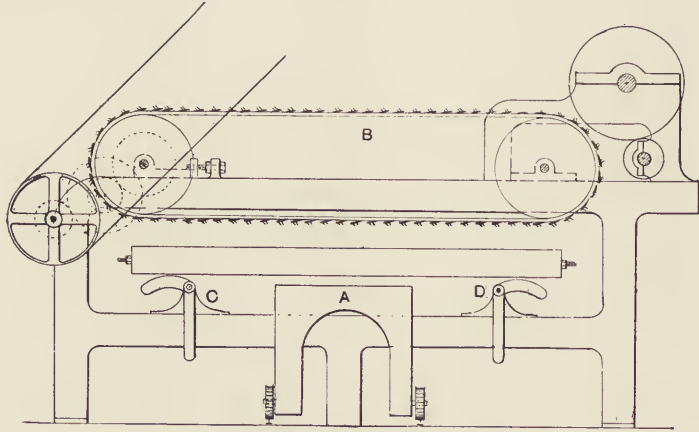

FIG. 21.—Flat dressing frame for ramie.

The ending machine or comb, fig. 20, is a brush and doffer hackling machine in miniature. Like fig. 19, it is applied to the fine end of the hackling machine, and is often particularly useful in removing “naps”

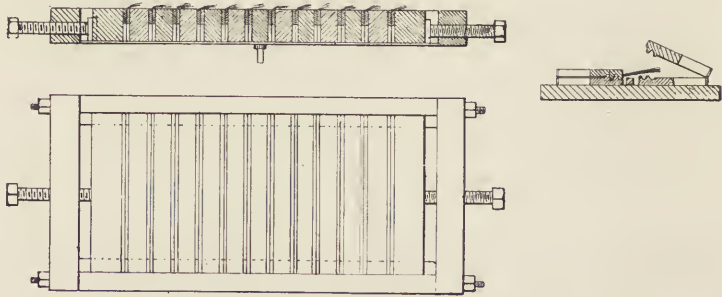

FIG. 22.—Book frame and books for flat dressing frame for ramie.

from the end of fine fibre. The height of the sheet may be adjusted, as in the Erskine machine, so that any required part of the end may be operated upon.

Flat Dressing Frame for Ramie.—The flat dressing frame used by the most successful ramie spinners is shown in figs. 21 and 22. The narrow sheets of fibre, obtained by cutting across the lap formed upon the cylinder of the filling engine, fig. 10, page 28, are placed in wooden holders or

“books,” as shown in fig. 22, a number of these “books” being then tightened together in an oblong frame as shown, with the ends of the fibre projecting. The book frames are then placed upon a carriage A, fig. 21, and run under the dressing or combing sheet B, which is stretched between and runs round two pulleys at either extremity of the machine, as shown.

The book frame is then raised from its carriage and into close proximity to the dressing sheet by means of cams C and D. When one end of the fibre has been combed it is turned in the “books,” and the other end subjected to the dressing sheet in a similar manner. The dressing sheet may be stripped and kept clean by a brush and doffer arrangement, or merely by a toothed doffer stripped by a pair of fluted drawing-off rollers which deliver the noil in a sheet.

CHAPTER VI.

SORTING, AND THE MANAGEMENT OF THE HACKLING DEPARTMENT.

Sorting.—A thorough sorting of hackled fibre only pays when really valuable material intended for fine yarns is being dealt with. For coarse yarns the rough classification of the raw fibre is all that will be required. For medium and coarse flax yarns the line from the machine and ender may be roughly classed by the machine boys, who can put to one side any dirty pieces, etc. For fine and superior flax yarns the machine-room tipples must be passed on to the hackler or sorter, who, besides giving the pieces an additional combing over hand tools, usually breaks and squares the ends on a touch pin, puts a lap upon the pieces, and builds them into bunches, according to the quality and cleanliness of the fibre.

Sorter's Tools.—The sorter's touch pin and hackles are similar to those of the hand-dresser which we described on pages 26 and 27. Of course he requires no rougher's hackle, his coarsest being the "ten" or "eighteen." For fine work his switch has often 300 pins in the row, $7\frac{1}{4}$ inches long. In addition, he often requires a nap extractor to remove the naps from the ends of fine flaxes. A "nap extractor" is a single row of flat pins set edgewise and very close together, in order that they may retain the naps when the fibre is pulled through them. A nap extractor may have as many as fifty pins per inch in length. Were these pins set in holes in a stock in the ordinary way their foundation would have no strength, consequently it is usual to solder them together at the base and upon a brass strip. They may be further secured by another strip of brass placed at the back and dovetailed into the first. The nap extractor used to be placed apart, to the extreme right of the sorter, who gave the ends an additional blow or two upon this tool before putting on the lap. Now, in order to avoid paying the sorters more for this extra work, the nap extractor is usually fixed in front of the first row of pins of the switch. We do not like to see it there, however, for if the hackler works up to the hand, as he should do, the middle of the flax receives an unnecessary amount of work and too much tow is produced. A satisfactory result will be obtained with much less tow if the nap extractor be used separately and merely upon the extreme ends of the piece

Sorting Operations.—The finishing, hackling, and sorting operation, briefly described, is as follows. The sorter takes a piece of flax from the tittle, which he has previously loosened and placed in front of him to the left, and spreads it as flat as possible, root end foremost, upon his “ten.” He grasps it as tightly as possible with his right hand close to the holder mark, keeping the root end well spread out between his first finger and thumb, and after one pull through his coarsest hackle, laps the piece around the fingers of his right hand and the extremity around the touch pin, with the first finger and thumb of his left hand, taking care to keep the fibres straight and untwisted. Now, with a quick jerk of his right hand he breaks off the extremity of the piece containing loose fibres and flat and coarse ends, and places it beside his touch pin; while unwrapping the piece from around the fingers of his right hand, he again spreads out the root end, and, giving it several blows upon the ten, right up to the hand, he finishes both sides of the piece upon the switch, nipping the end or leaving the loose fibres of the end in the corner pins of the tool in the way we described in speaking of hand-dressing. If the end is much worse than the middle of the piece it must be heavily broken, the ease of the operation depending upon the skill of the hackler in lapping the end loose and straight around the touch pin. The root end being finished, the hackler turns the piece on his knee, and, spreading the top end flat upon the hackle, proceeds to break and hackle it in a similar manner, giving, however, the extremity of the top end even more work upon the switch and even one or two blows through the nap extractor, if necessary. In turning the piece he must allow sufficient shift to ensure that the piece is thoroughly hackled from end to end, when, if allowed, it would drop asunder, the fibres being perfectly free and parallel. He then puts a lap upon the piece in the way described in our last chapter, and builds it into a bunch according to the quality which he has found in it during its manipulation. When a bundle of ends has accumulated, he forms them into pieces, combs out the tow, and builds them into a separate bunch of “breakings” which may be mixed in for a low weft number.

There are two usual bases of dressed line numbering. The one, sometimes used in coarse mills, has its origin in the Scotch trade in which the lbs. per spynkle of 14,400 yards indicates the number of the yarn. The line is then classed as Nos. 1, 2, 3, 4, 5, etc., according as it is supposed to be equal to spinning 1 lb., 2 lb., 3 lb., 4 lb., 5 lb. yarn, etc.

The other usual way of dressed line numbering, and that usually adopted in fine mills, is generally known as “warp numbers,” because the line thus classed is supposed to be capable of spinning a fair warp yarn of the lea indicated by the number. Thus we have the numbers 25 to 80, ranging from a coarse dirty flax to the finest Courtrai line.

The sorter’s bunches usually weigh 20 lbs., and are carefully tied up

and covered, if of valuable quality, with paper or linen to keep out the dust and light, the latter of which affects the colour.

They should be stored away in a dry but cool line store kept in semi-darkness, and communicating, if possible, with both the hackling department and the preparing room.

A good large line stock should be kept, as it enables flaxes, of the same number and quality, but hackled at different times and belonging to different lots, to be well mixed together, avoiding annoying changes in colour or striping of the yarn.

The line is furthermore improved by being allowed to "come to" after the hackling process. The same remark applies to the scutching and preparing processes as well, for the friction of the scutching blades and of the gill pins, as the line is drawn through them on the preparing frames, dries or sets up frictional electricity which renders the fibres stiff and intractable.

The Society rate of wages for hacklers in Ireland is 25s. per week. The men are usually paid so much per 100 lbs., say 10s., 9s. 3d., 6s. 11d., 5s. 5d., 5s. 3d. or 4s. 11d., which, taking 25s. per week as a basis, amounts to their working 45, 50, 65, 80, 85 or 90 lbs. per day respectively. It is usual to say that the dressing of a certain class of flax is paid for at the rate of 80 lbs. per day, not 5s. 5d. per 100 lbs. In weighing the sorter's parcel into the line store, it is usual to deduct 1 lb. or so for the weight of the bands and paper, if any, with which the bunches are secured. The resulting shorts and tow are entered upon the parcel ticket, the contents of which are afterwards transferred by the hacklers' clerk to the "lot book." The finished flax or "dressed line," as it is now called, should be placed in separate bins in the line store. The bins may be numbered and the number entered in a book kept for the purpose. Any quality of flax is thus easily found when required for the preparing department.

The "lot book" referred to is a complete record of the results of the working of each individual parcel. These results are entered from the parcel tickets under their respective lots and upon the line corresponding with the parcel number. When all the parcels belonging to any lot have been got in, the lot must be "made up." First, all the columns must be added up and the totals checked. Thus the sum of the rougher's "longs," "shorts," tow and waste must equal the flax weighed off. The sum of the machine tows, tipples, and waste must equal the rougher's longs and shorts. The sum of the hackler's "sorts," tow, and waste must equal the tipples, and the sum of the hackler's sorts, total tows and wastes—the flax weighed off. Thus the additions must be checked and the errors located. The average yield of dressed line per cwt. is next to be found by dividing the total line by the cwts. in the lot. The yield per cwt. of sorted flax seldom exceeds 70 lbs., while for unsorted fibre it may be as high as 80 lbs.

Average Sort or Lea.—The average sort or lea is found by dividing the sum of the products of the lbs. of each sort and that sort, by the total line. Thus if 70 lbs. of dressed line were made up of 6 lbs., 35's; 10 lbs., 45's; 24 lbs., 50's; 30 lbs., 55's, the average sort or lea is— $[(6 \times 35) + (10 \times 45) + (24 \times 50) + (30 \times 55)] \div 70 = (210 + 450 + 1200 + 1650) \div 70 = 3510 \div 70 = 50.14$.

This result may be checked by the following method:—Divide the sum of the products of the lbs. of each sort and that sort minus the base sort (in this case 35's), by the total line, and add the base sort to the result, thus— $\{[6 \times (35 - 35)] + [10 \times (45 - 35)] + [24 \times (50 - 35)] + [30 \times (55 - 35)]\} \div 70 = (0 + 100 + 360 + 600) \div 70 = 1060 \div 70 = 15.14$. Add 35, and the average lea = 50.14, is found as before. This may be further shortened by multiplying by 1, $1\frac{1}{2}$, and 2, instead of 10, 15 and 20 as above, and then multiplying the result, 1.514, by 10, or shifting the decimal point one place to the right, making it 15.14 as before.

The average tow per cwt. of each sort and of the total, and the average waste per cwt., are found in the same way as the average yield, and the results checked by the knowledge that, allowing for the loss of, say, .02 in neglected decimals, the sum of the average yield of line, tow, and waste must equal 112, and the sum of the average tows of the various sorts must equal the average total tow. In some places these results are made up on the flax weighed off, and elsewhere on the flax paid for. In the latter case the waste shows more or less according to whether good or bad weight was received, whether the flax was damp and had "dried in" or not, and, in the case of Russian flaxes, according to the weight of ropes and the difference between the actual weight of mats, if any, and the tare which is allowed. The latter item need not be included in the waste, but may be brought out separately.

The result of a lot may be obtained approximately in a short time by working a parcel of each farmer's lot, and dividing the sum of the products of the result of each parcel and the cwts. in each buying, by the total cwts. in the lot.

The object of these calculations is to obtain the cost of the dressed line per lb., and, for the sake of comparison, to find from it the cost of a given sort. It is thus easy to see if the lot be dear or cheap, and the figures obtained serve as the basis of the yarn costing.

Cost of Average Sort.—In order to make out the cost of the dressed line per lb., the market values of the various tows must be ascertained. Say that the market values per cwt. of Irish mill-scuted or milled tow are:—Roughing, 32s.; No. 1, 35s.; No. 2, 38s.; Nos. 3 and 4, 41s.; and sorting, 46s.; or an average value of 4.14 pence per lb. The cost of hackling must also be known. For ordinary long line sorted flax in Ireland it may be made up as follows:—Roughing, 1s. 7d. to 1s. 9d. per cwt., depending

upon the size of the pieces, lifts per minute, etc. ; sorting, 2s. 6d. to 4s., depending upon the yield and the length of flax ; overlookers, clerks, and odd hands, 1s. 4d. per cwt. ; total, 6s. 2½d. to 7s. 9d. per cwt., or say an average of 7s. per cwt. Coarse undressed flax may be hackled for 3s. 3d. per cwt. ; while the finest Courtrai may cost as much as 8s. per cwt. To find the average cost of the dressed line per lb., take the average cost of the lot per cwt. from the flax invoice book, and to that add the average cost of dressing per cwt. Deduct the value of the tow per cwt., and divide the result, reduced to pence, by the average yield of dressed line. The result is the cost of the average sort. Taking our previous figures for example : average yield 70 lbs. per cwt., and average lea 50·14. Suppose the total tow per cwt. to have been 40 lbs., with an average value of 4·14 pence per lb., the average cost of the lot 72s. per cwt., and the cost of dressing 7s. per cwt. The average cost of the line per lb. is $[(72 + 7) \times 12] - (40 \times 4\cdot14) \div 70 = 948 - 165\cdot6 \div 70 = 782\cdot4 \div 70 = 11\cdot17$ pence per lb. This cost is for the average lea. For the sake of comparison, all the results of lots may be reduced to the value of a common base, say 40's. The ways of doing this are various, and more or less arbitrary, since the actual value of 40's depends upon what would have to be paid for flax which would give that average number. This, of course, depends upon the season, and whether the crop runs coarse or fine. One way is to deduct the value of 40's by simple proportion, and another, by adding to or subtracting from the cost of the average "lea" or number, an amount (based on the average of former years or on a number of previous lots) for each number which that average lea is below or above 40's. Thus, taking our former figures, viz., 50·14 lea, costing 11·17 pence per lb., we find by proportion that 40's are worth $\frac{11\cdot17 \times 40}{50} = 8\cdot93$ pence per lb. Suppose

we find by experience that the average cost of numbers above or below the base, say 40's, is the cost of the base $\pm \frac{1}{5}$ penny per number. The cost of our 40's reckoned in this way is now $11\cdot17 - \frac{50\cdot14 - 40}{5} = 9\cdot14$ pence per

lb. The methods of calculation in the flax department of a Continental mill are the same in principle, in France and Belgium the average cost per cwt. being replaced by the cost in centimes per kilo, the cost of the dressed line brought out in francs or centimes per kilo, and the average yield being per cent. or per 100 kilos. Roughers and hacklers are paid in centimes per hour, but have to keep their share of machines going. Roughing is not general, the flax being merely pieced out in many mills. In Germany, home-grown flax, which resembles Irish hand-scuted, is frequently re-scuted prior to roughing. This, if carefully done, is well worth the cost and trouble. Fine and first grade warp yarns are nearly all spun in Ireland, where the hackling and dressing of the flax has reached a high

state of perfection. With the exception of a few fine mills in the north of France, the numbers spun upon the Continent are chiefly of heavy and medium counts, for which Russian flaxes are much used. Some French and Belgian spinners produce a nice yarn from Slanetz flaxes, as they take much more care in the hackling and sorting of the fibre than we do under like circumstances. Cheap labour, protective duties, and long hours of labour give them a decided advantage which, however, is fast disappearing under progressive legislation and socialistic movements. The hours of labour per week in the chief flax-spinning countries are now—Ireland, 56; Belgium, 69; France, 60; Germany, 65; and Russia, 67.

Running Numbers for Spinning.—It is a very good practice to spin yarns in lots of so many tons, bundles, spyndles, or paquets as the case may be, either to order or merely for stock and sorting-up purposes. In giving these lots a running number, mixes may be avoided, and when the lot is finished a calculation made to show the waste made and the actual cost in material used per lb. or bundle, etc., of yarn. It is convenient to calculate the waste per cent. on the yarn spun, and not on the raw fibre weighed out. For flax line yarn, starting with the fibre in the form of dressed line, an average waste of 20 per cent. on the yarn spun may be taken in calculating the quantity of material required to spin a bundle of yarn, for instance. Since, under the Irish system of numbering flax yarn, the number indicates the number of cuts or leas per lb., and there being 200 cuts per bundle, the probable weight of dressed line required to spin 300 bundles of 60, for instance, will be

$$\frac{(200 + 20 \text{ per cent.}) \times 300}{60} = \frac{240 \times 300}{60} = 1200 \text{ lbs.}$$

Under the Scotch system of yarn numbering, which is universal in the jute trade, the number indicates the weight in lbs. of a spyndle or four hanks. Thus on the same basis the weight of line required to spin 10,000 spyndles or 2400 bundles of 4 lb. or 12 lea yarn, will be $(10,000 \times 4) + 20$ per cent. = 48,000 lbs. The weight of *lin peignée* required to spin 100 French paquets of No. 40 flax yarn, which weighs 14 kilos per paquet of six Irish bundles, will, on the same waste basis, be $(14 \times 100) + 20$ per cent. = 1680 kilos. Since there are only three Irish bundles in the Belgian paquet, which, furthermore, weighs rather less than half the weight of a French paquet, the weight of dressed line required to spin a like number of Belgian paquets will be only $(6.8 \times 100) + 20$ per cent. = 816 kilos.

In the case of tow yarns, the quantity of card waste is so variable that anything between 30 and 50 per cent. may be taken as the probable waste on the yarn spun. Rope yarns may, of course, be run through with comparatively little waste. Thus, on the basis of 5 per cent. waste, 105 tons of Manila will be required to spin 100 tons of binder twine.

Stocktaking and Mixing.—The hackler's clerk or storeman should supply the manager with a stock sheet every week, showing the quantities weighed out and in the present stock, so that he may see at a glance if the material is being used and mixed in the proper proportions, and also arrange for the supply of fibre for present and future requirements, or, that being impossible, to adapt his spinnings to the material in hand. It is generally found advisable to mix flaxes, except in the case of the better qualities of Courtrai, which are of a nice clear colour, and when spun pure, produce a valuable light-coloured yarn. Specially dark-coloured yarns, produced from Dutch or Flemish flax, are also occasionally in demand for lines. Mixing is convenient when it is impossible to get a sufficient quantity of flax of uniform quality and colour, or of a value which may be spun into yarn at a given price, leaving a fair margin of profit. A judicious blend may in some cases give a better spin than even the best of its component parts spun alone. Weak and strong, or small and big "boned" flax, however, should never be mixed together, as they tend to draw unevenly in the spinning, and produce "shiry" if not "beaded" yarn. Suppose that it is desired to spin a quantity of 100's weft, the market price being at the time 3s. 3d. per bundle, less 9 per cent. Suppose the result of a series of trials of waste made in the preparing and spinning to be 20 per cent. on the yarn spun, the weight of material required per bundle will be 2 lbs. + 20 per cent. = 2.4 lbs. Suppose the margin of profit to be made per bundle be 3d., then the bundle must be produced for (3s. 3d. - 9 per cent.) - 3d. = 2s. 11½d. - 3d. = 2s. 8½d. Suppose the average cost of preparing and spinning per bundle, taken from a lengthened period of working and including wages, cost of coal, gas, furnishings, etc., to be 1s. 3½d., that leaves us 2s. 8½d. - 1s. 3½d. = 1s. 5d. for the 2.4 lbs. of material, or an average price of $\frac{17}{2.4} = 7.1$ pence per lb., for the line. We have taken the price of 100's weft at almost its lowest price. Even during a depression in trade the better spinnings can command 1½d. more, and producers have often to spin without profit or at a loss to keep up their quality. We have previously mentioned the way of sending the flax to the spread-boards in the machine-room tipple, dispensing with dressing, and thus reducing the cost of the line by the cost of sorting, say, ½d. or more per lb. If the flax is fairly level in quality, and if the machine boys have picked out and machined again the dirty pieces, and also pulled off the loose ends, or if ending machines have been used, fairly good results will be obtained from unsorted flax. We have now to arrange the blend or mix, to average 7.1d. per lb. in price. Irish flax is, as a rule, too good and expensive to use alone in this class of yarn. We will use some, however, to give strength to the mixture. Dutch flax is almost invariably a weft flax, and must be used in yarns of this sort. It macerates easily in

the hot water of the spinning trough, and gives the yarn a good "skin" and appearance. Riga flax also is more suited to weft than to warp yarns. It comes in cheap, and the better marks will spin to 100's. Under the warp number classification, it will require 40's Irish and Dutch to spin 100's. We will suppose the cost of 40's Irish in the tipple to be 9d. per lb., 40's Dutch 8½d. per lb., and the Riga 5½d. per lb. If we then arrange the mix to be ½ Riga, ¼ Irish and ¼ Dutch, the average price of the line will be

$$\frac{(2 \times 5\frac{1}{2}) + (1 \times 9) + (1 \times 8\frac{1}{2})}{4} = 7\cdot1d. \text{ per lb.}$$

The best way to find the necessary proportions to average 7·1d., if we determine upon using Irish at 9d., Dutch at 8½d., and Riga at 5½d., is to place the respective values of the simple parts under each other, and the desired average price to the left of them, thus :—

$$7\cdot1d. \left\{ \begin{array}{l} \text{Irish} \quad . \quad . \quad 9d. \quad \left. \begin{array}{l} 1\cdot6 \\ 1\cdot6 \end{array} \right\} \begin{array}{l} 1 \\ 1 \end{array} \frac{1}{4} \\ \text{Dutch} \quad . \quad . \quad 8\frac{1}{2}d. \quad \left. \begin{array}{l} 1\cdot6 \\ 1\cdot9 + 1\cdot4 = 3\cdot3 \end{array} \right\} \begin{array}{l} 1 \\ 2 \end{array} \text{ or } \frac{1}{4} \\ \text{Riga} \quad . \quad . \quad 5\frac{1}{2}d. \quad \left. \begin{array}{l} 1\cdot6 \\ 1\cdot9 + 1\cdot4 = 3\cdot3 \end{array} \right\} \begin{array}{l} 1 \\ 2 \end{array} \frac{1}{2} \end{array} \right.$$

Then link a greater and a less value than the desired average together. Find the difference between each value and the desired average, and place it opposite the value *to which it is linked*.

Thus in the present example, there are *two* greater and only *one* less value than the desired average, so link *each* of the greater to the less; $9 - 7\cdot1 = 1\cdot9$, which place opposite Riga, $8\cdot5 - 7\cdot1 = 1\cdot4$, which also place opposite Riga, and add to 1·9, making 3·3. $7\cdot1 - 5\frac{1}{2} = 1\cdot6$, which place opposite Irish and Dutch. Thus the flaxes must be mixed in the proportions of Irish 1·6, Dutch 1·6 and Riga 3·3, or 1, 1 and 2, or ¼, ¼ and ½. We will therefore put in ¼ Irish, ¼ Dutch and ½ Riga. In practice the proportions in which flaxes can be conveniently mixed depend upon the number of leathers on the spread-board, since it is by spreading a certain number of leathers of each that the mixture is accomplished. Thus there may be two four- or two six-leather boards, or one eight-leather board to the system, so that the only possible divisions are $\frac{1}{12}, \frac{1}{8}, \frac{1}{6}, \frac{1}{4}, \frac{1}{3}, \frac{1}{2}$ and their complements, unless the fibre be mixed on the same leather, which is unsatisfactory.

CHAPTER VII.

THE PREPARING DEPARTMENT—SLIVER FORMATION.

Spread-boards.—The first step towards the production of a continuous thread from the disjointed fibres is the formation of a fibrous ribbon, technically known as a “sliver.” This, in the case of long and valuable fibre, is done upon spread-boards, such as are shown in figs. 23, 24, 27, 28, and 29. The first two show the type used for flax, soft hemp, and jute long line. The latter three are descriptive of Good’s combined hackler and spreader for Manila and New Zealand fibre.

The spread-board, figs. 23 and 24, consists of a table 2 to 4 feet broad, and, say, 6 feet long, over the surface of which four, six, or eight endless leathers A, are carried by means of rollers at either end. The leathers deliver the fibre through conductors to the feed rollers BB, and thence into the gill box C, which is rectangular in form and contains fallers upon which gills are fixed. The fallers are thin but deep bars extending parallel with the feed rollers, and resting at the ends upon top and bottom slides, the ends themselves being formed to work in the square threads of revolving screws, by means of which those upon the top slide are moved forward from the feed rollers and those upon the bottom slide in the opposite direction. The bottom screws are coarser, since they are only employed to conduct the fallers back again to the feed rollers, where they are raised by a tappet into the top screw and on to the top slide, where they conduct the fibre forward to the boss roller D, and are then knocked down by another tappet into the bottom screw and on to the bottom slide, there to repeat the motion. Spring or weighted guides are provided at each end of the slides to regulate the rise and fall of the bars front and back. The back end of the top slide is shaped to work in a groove in the faller end to assist in keeping them in correct position. The guard or guide at the front works in the same groove with the same object. In consequence of the wear and tear in the fallers and slides, entailed by the fall of the former, the spread-board is usually provided with levers actuated from the screw, which receive the faller as it leaves the top slide and deposit it upon the lower. In a spread-board the slides are usually inclined from back to front, to give the necessary height for a can at the front and a convenient

height of table at the back. In the older machines the front end of the screws work in steel plates which are subject to wear, the working surfaces

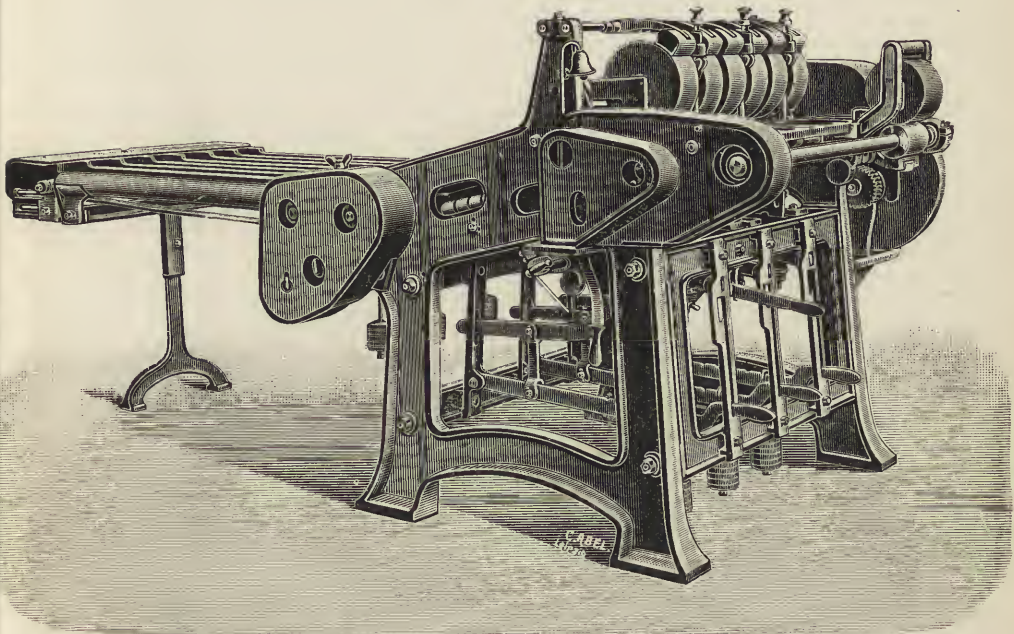

FIG. 23.—Spread-board for flax and hemp. (Made by Oscar Schimmel & Co., Chemnitz, Saxony.)

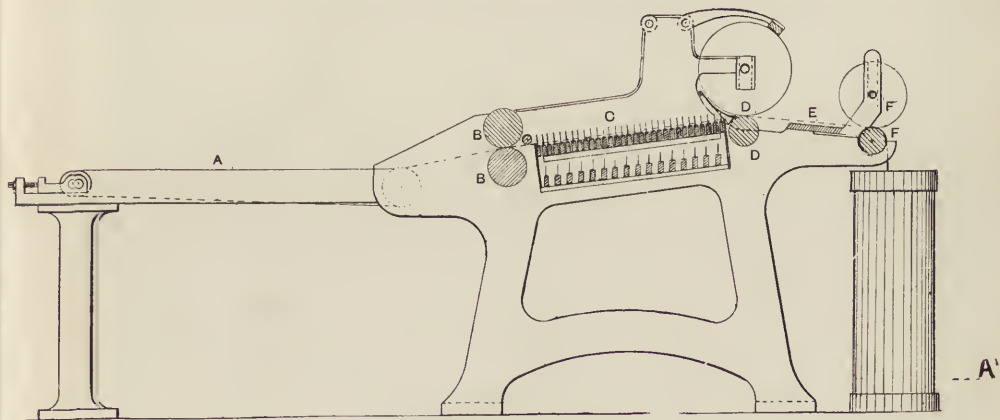

FIG. 24.—Long line spread-board.

being difficult to lubricate. The newer plan of partially surrounding the body of the screw with a cast iron block is much more satisfactory and

durable. The fallers are of wrought iron with steel ends, the brass stocks of the gills being riveted on. The liability of the brass gill stock to become detached, and the weakening effect of the rivet through the faller, so often leading to jams and broken fallers, has led to various attempts to dispense with gill stocks by inserting longer pins directly in the faller bar itself. This method, no doubt, gives a firm gill, but it is difficult of construction and repair, since the faller bar is often more than 1 inch in depth, rendering the drilling of fine holes difficult in the extreme. Repairs can also be effected with the minimum loss of time when the gills are detachable, since they may be prepared beforehand and only require riveting on.

When the fallers rise close to the feed rollers B, the pins of the gills penetrate the fibre, which is conducted forward by them to the boss or drawing roller D. This roller has a surface speed ten to thirty times that of the feed or retaining rollers B. The fibre is consequently drawn through the gills, leading to a still further subdivision of the fibres. The gills govern the delivery of the fibre to the drawing rollers D, and prevent it from being "gulped" or drawn away irregularly, forming thick and thin places in the sliver. In order that the gills may do their work effectively they must "pin" the sliver properly—that is to say, the fibre must not ride over the top of the pins, but must be completely below the surface. When the fibre is rather stiff and hard or the gill rather fine, a small iron rod inserted between the delivery point of the feed rollers and the fallers, as shown in fig. 24, will be found to be a great aid towards good pinning. Usually it is merely necessary to keep the sliver tight in order that the gill may penetrate it. To keep the sliver tight the faller is given a small "lead" or greater surface speed than that of the feed roller. The "lead of the faller" is usually from 2 to 5 per cent.

To find the "Lead of Faller."—Suppose, for instance, that a wheel of 76 teeth, on the feed roller, gears into a stud pinion of 27 teeth, compounded with a stud wheel of 75 teeth, driving the back shaft by means of a pinion of 20 teeth. Upon the back shaft a bevel pinion, of 32 teeth, drives another of 20 teeth on the top screw. The pitch of the screw being $\frac{1}{2}$ inch, the faller moves forward $\frac{76 \times 75 \times 32 \times 1}{27 \times 20 \times 20 \times 2} = 8.44$ inches for each revolution of the feed roller. The feed roller being $2\frac{3}{8}$ inches in diameter, it delivers to the fallers $2.6 \times 3.1416 = 8.17$ inches in the same time. The faller, therefore, has a lead of $8.44 - 8.17 = .27$ inch for each revolution of the feed roller, or a gain of $3\frac{1}{3}$ per cent.

To assist in obtaining the thorough pinning of the sliver, the position of the feed roller may be so arranged that its delivery surface is slightly below the top of the gill stock and the root of the pin. In front, however, the nip of the drawing rollers D must be above the top of the gill stock,

lest the latter be cut by the fibre being drawn over it. The fibres being drawn through the gill and a conductor slightly narrower than the gill, they are rendered quite parallel and formed into a sliver of uniform width. Each of the four, six or eight slivers issuing from the rollers D, is passed through a separate slot in a doubling plate E, such as is shown in fig. 41 or at V in fig. 38, and all out again through another slot, the tension being maintained by means of a pair of delivery rollers F, having a slight lead, which, drawing the sliver through a conductor, deposit it in a can A'. If the doubling plate be properly slotted, *i.e.* with slots at an angle of 45° to the boss roller, and the correct tension maintained, each of the layers composing the compound sliver will ride evenly one on the top of the other, and a perfect sliver be produced. If the doubling plate be defective, or the tension of one or all of the slivers be unequal, a bad result will be obtained. It will generally be found that it is the second sliver from the delivery roller which runs slackest on the doubling plate, the reason being that it is this sliver which, when all are brought together, lies against the surface of the delivery roller and has its proper surface speed. The others lie further from the centre of the roller and consequently have a higher surface speed, the effective diameter of the delivery roller being, as far as the outside sliver is concerned, its own diameter *plus* twice the thickness of the combined sliver.

“*Bell Motion.*”—A bell mechanism, such as is shown in fig. 38, is generally used in connection with this class of spread-board. Its object is to measure off a certain length of sliver, say 400, 600, 800 or 1000 yards, into the can.

The “length of bell” is calculated as follows:—Suppose that the single threaded worm F on the end of the delivery roller drives a worm wheel A' of 37 teeth, upon the pap of which is another worm C', driving the bell wheel B', which has 103 teeth. For one revolution of the bell wheel B', the delivery roller makes $103 \times 37 = 3811$ revolutions. If its diameter be 3 inches and its circumference consequently $3 \times 3.1416 = 9.4248$ inches, $\frac{3811 \times 9.4248}{36} = 1000$ yards will be delivered for each revolution of the

bell wheel. If that wheel have but one ringing peg in it, the bell will ring for every 1000 yards. If the bell wheel have two pegs in it, as it sometimes has, only 500 yards will be delivered between the times of the ringing of the bell.

The screws, fallers, gills, slides, screw blocks, cams and guides are shown in detail in fig. 38. L L are the screws, M and D are faller bars, N is the knocking-down tappet of the top screw, O is the lifting tappet on the bottom screw, P is a faller guide, Q is one of the levers for depositing the faller on the bottom slide, and R are the screw blocks.

Back and Front Conductors.—The conductors behind the feed and delivery rollers are in two pieces and fixed at the required distance apart by

means of screws. The boss roller conductors are either fixed or, preferably, loose. The fixed conductors are attached by set screws and steady pins to a bar running behind the roller. The loose conductor has often a projecting hook behind, which hangs on a rod corresponding to the conductor bar, or the conductor may merely lie against the bar. The front portion of the conductor is circled to half-surround the boss roller, the toe projecting right into the nip of the rollers. The top face of the conductor is hollowed out to correspond with the curve of the largest pressing roller to be worked. The maximum and minimum size of pressing roller is limited by the height of the U^s or supports which receive the ends of the axle upon which each pair of rollers is rigidly fixed. Brass or cast iron washers are provided to prevent the ends of the revolving axle from wearing the U^s. The conductors and rollers are placed exactly opposite the rows of gills from which the sliver is to be drawn. The loose conductors have lugs between which the bosses of the pressing rollers work, the conductors being thus kept in their proper position. This is the point in which, in the author's opinion, the loose conductor is superior to the fast. With a fast conductor, if the pressing roller be not quite accurate in pitch or truth, the mouth of the conductor may not be quite covered during a part or the whole of a revolution. The fibre issuing from the uncovered portion is not drawn away regularly but comes away periodically in slubs or lumps which the subsequent processes cannot eliminate.

Sometimes a lump may cause the wooden roller to stick. When this occurs the sliver, which is being brought forward by the gill, is not drawn away but accumulates behind the conductor, often twisting a fast conductor and smashing the gills before it is noticed. The wood roller must be taken out, when the conductor can be slackened and the accumulation and obstruction removed. A loose conductor can be lifted out and replaced with greater ease, in addition to which the damage done when an accident of this kind occurs is much reduced, since the conductor, not being rigidly secured, gives way before the growth of the accumulation, thus saving the fallers and gills from being broken or crushed.

A considerable amount of pressure is required between the drawing rollers to draw the fibres at a fair speed from the gills. The pressure is applied by means of simple or compound levers placed underneath and fulcrumed in the framing of the machine. The levers draw the pressing rollers downwards by means of a rod known as the "spring-wire," with a hanger on the upper end, which enircles that portion of the arbour between the bosses of each respective pair of rollers. The pressure upon each pair of bosses may be from 250 lbs. to 1500 lbs., depending upon the breadth of the conductor. Given a sufficiently long reach, *i.e.* longer than the longest fibre, the pressure per inch in breadth of the conductor depends upon the loading of the gill, the closeness of the pins, the length of the

fibre, and consequently the number of gills through which it has to be drawn. It is better to have a margin to draw upon when extra power is required, as it would be were the sliver twisted in the gill, since, if the drawing rollers are unable to draw the fibre from the gills, lumps are produced which the following equalising operations cannot completely eliminate.

The way to calculate the leverage or pressure exerted upon the rollers is as follows:—Supposing that a simple lever be employed, the weight used being 30 lbs., and placed at a distance of 40 inches from the fulcrum or working centre of the lever. The “spring-wire” is attached at a point 2 inches from the fulcrum. The pressure upon the bosses, as usually calculated, and neglecting the weight of the lever itself and the angle of the “spring-wire,” is then $\frac{30 \times 40}{2} = 600$ lbs.

With two levers, one with a weight of 12 lbs. attached to a point 24 inches from its fulcrum, and compounded with another by means of a link pivoted at a point 3 inches from the fulcrum of the first and 24 inches from the fulcrum of the second, the “spring-wire” being attached at a point 2 inches from the fulcrum of the latter, the total pressure upon the roller, calculated as before, is now $\frac{12 \times 24 \times 24}{3 \times 2} = 1152$ lbs.

With the same two levers, combined with a swinging jib fulcrumed upon a shaft 9 inches behind the centre of the roller arbour, the spring-wire being attached at a point 12 inches from the same fulcrum, the pressure is now $\frac{12 \times 24 \times 24 \times 12}{3 \times 2 \times 9} = 1536$ lbs.

In practice, the weight of the levers themselves is usually neglected, but it should not be so, since their weight increases the actual pressure considerably. With two levers the effect would be the same as another weight equal to that of the levers, acting upon the upper lever at a point corresponding to the centre of gravity of the system, or the point from which the levers, if detached, might be suspended in equilibrium. The spring-wire is always inclined at an angle of, say, 30° to the vertical, since its point of attachment with the levers is not directly under the rollers, nor is the point of contact of the rollers exactly on the top, but a few degrees forward from the centre. The effect of this is to increase the pressure by an amount which may be obtained from the equation $b = \frac{a}{\cos \theta}$, where b = the actual pressure, a = the calculated pressure, and θ the angle at which the spring-wire is inclined to the vertical. The effect of these combined factors, *i.e.* the weight of the levers and the inclination of the spring-wire, may be ascertained by inserting a Salter's spring balance in the place of the spring-wire, tightening up until the levers are in suspension, and reading off the tension shown on the scale.

The feed and drawing rollers are of steel. The former is always plain. The latter is sometimes scored to increase its drawing capacity. The feed pressing rollers often press upon the roller underneath merely by their own weight, although the pressure is sometimes increased by means of levers and weights. The drawing pressing rollers, to which great pressure is applied as we have described, are of wood when flax is being dealt with. For jute a leather apron usually envelops the boss to increase its grip, while for the long and hard fibre of Manila, the front pressing rollers are better if made of pieces of leather, on edge, bolted between two steel flanges. For wooden rollers, alder, mahogany, satinwood and boxwood are most used. The two former woods are those usually employed when the

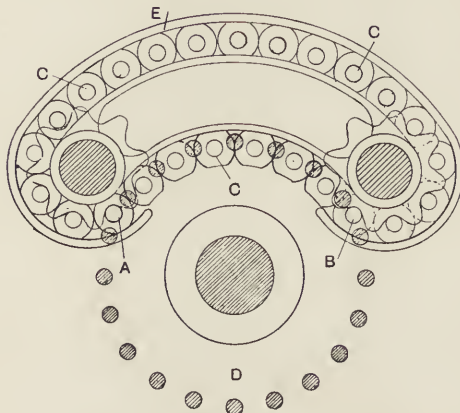

FIG. 25.—Lawson's drawing head.

boss is fairly wide, and the latter or harder woods for narrow-facèd rollers. For coarse hemp, the ordinary boss roller with its pressing roller are sometimes replaced by Lawson's drawing head, as shown in fig. 25.

Here an extended and interlocking holding surface A to B is formed by means of a series of loose-driven holding bars C, interlocking with the bars of a lantern wheel D, such loose bars being guided in their course by an end-

less race E. The material lies between the loose bars and those of the lantern wheel, where it is so tightly interlocked that the mechanism forms a very efficient drawing arrangement, and one which will wear for a long time if due care be exercised to prevent the bars being bent by lumps, etc.

The delivering roller is likewise of steel, with one or more enlarged bosses upon it. Upon these bosses, and supported by U's, lie the delivery pressing bosses, of metal, of large diameter and heavy. The surface speed of the delivery boss should be slightly superior to that of the drawing roller, in order that the slivers may be kept tight upon the doubling plate. If it have too great a lead the sliver will have a drawn and wavy appearance, while if the tension of the slivers be insufficient the resulting sliver is equally unsatisfactory.

Rubbers are used to prevent loose fibres from lapping round any of the revolving rollers between which they pass. They are either of the "dead"

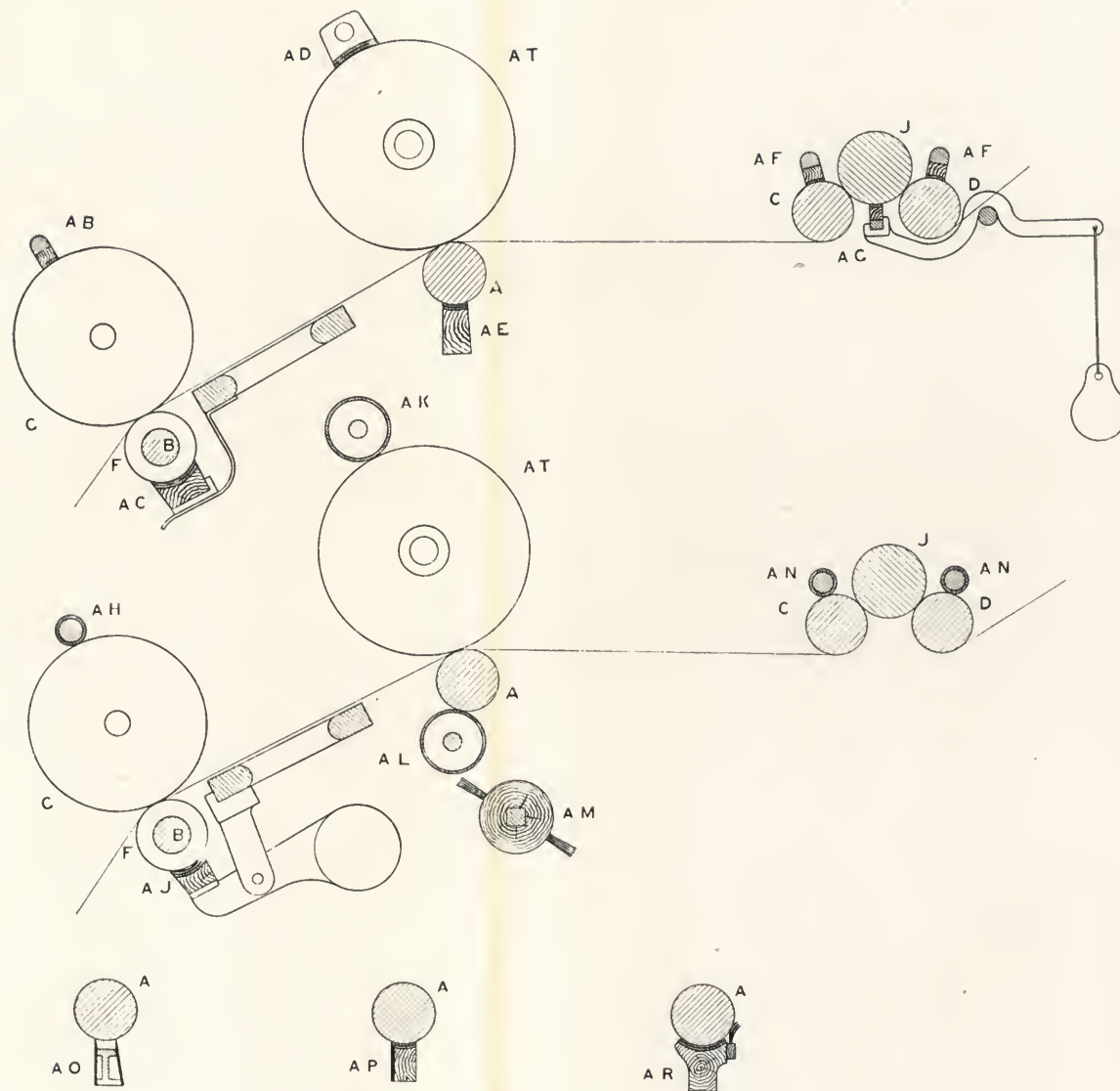

FIG. 26.—Rubbers for drawing frames.

Back of
Foldout
Not Imaged

or of the revolving type. Some examples of both, as applied to a drawing frame, are shown in fig. 26.

In this figure, A represents the boss or drawing roller, and AT its wooden pressing roller. B is the delivery shaft, with the boss F "sweated" upon it, and G is the calender or pressing roller which lies upon the boss F. A B, A D, and A F are different forms of pressing rubbers, dead, or pressing upon the rollers by reason of their own weight only. A C, A E, A O, A B, and A R are types of dead rubbers placed underneath rollers and pressed upwards by means of springs. A G and A J are similar rubbers pressed upwards by means of weighted levers, and A H, A K, A L, and A N are revolving rubbers driven by means of spur gearing *in the same direction* as, and consequently rubbing against, the bosses on which they press. The body of the rubber is of wood or metal, or both. The rubbing surface is covered with one or two layers of felt or thick flannel, which in the case of dead rubbers is glued on, and in the case of revolving rubbers, sewn on. Revolving rubbers obtain their motion from a spur pinion which is fixed upon the end of the roller against which they lie. When there is more than one revolving rubber boss upon the same rubber shaft, as is the case with the rubber A L, care must be taken that the flannel is all of the same thickness, or that the bosses are all of exactly the same diameter, otherwise some of the bosses will not enter into sufficiently close contact with the roller, and consequently will not act effectively in preventing laps. Dead rubber and the revolving ones A H, A K, and A N, which can be lifted out or raised, are cleaned periodically by hand. The rubbers A L, which are difficult to remove, are kept clean by means of the revolving brush A M, as shown in the figure. Care must be taken that rubbers acting upon pressing rollers are not too heavy, as when this is the case the proper revolution of those rollers may be impeded.

Draft Calculation.—As in most classes of spinning machinery in which the material is drawn out or elongated, the draft of the spread-board is produced by the greater surface speed of the drawing roller as compared with that of the feed roller. An example will suffice to show the method by which the theoretical draft may be calculated. A certain spread-board has a back or feed roller $2\frac{1}{4}$ inches in diameter. A wheel of 56 teeth is keyed upon the end of this roller and is called the feed roller wheel. This wheel drives a stud pinion of 20 teeth, compounded with a stud wheel of 130 teeth. The latter drives the back shaft through a pinion of 19 teeth, called the back shaft pinion. Upon the other end of the back shaft is fixed the draft "change" wheel, which we will say has 60 teeth. This draft change wheel drives the boss roller pinion of 38 teeth through a series of simple spur carriers or intermediates. The boss roller has the same diameter as the feed roller, namely, $2\frac{1}{4}$ inches. The circumference of these two rollers, bearing the same fixed ratio to their diameters, and

taking the surface speed of the back roller as 1, we find that the surface speed of the boss or drawing roller is $\frac{1 \times 56 \times 130 \times 60}{20 \times 19 \times 38} = 30$, which is also

the theoretical draft. The actual draft is rather less than this, being influenced by the thickness of the material between the rollers. The undrafted sliver held between the back rollers is, of course, thicker than the attenuated sliver held by the boss roller, hence the actual draft is shorter than the theoretical; to allow for this factor when calculating the draft, the diameter of the roller should, properly speaking, be considered to be augmented by half the thickness of the sliver passing over it. Had the diameters of back and drawing rollers not been the same, we should, in addition, have had to multiply by the diameter of the boss roller and divide by that of the back roller to obtain the draft.

Spreading.—The operation of spreading consists in spreading handfuls of fibre lengthwise upon the travelling leather A, or feed sheet of the spread-board, one piece overlapping the end of another in such a way that a continuous ribbon is formed, which, being delivered by the feed rollers B to the gills, is by them conveyed to the boss roller and drawn out or drafted and the fibres parallelised in their passage through the gills. Good spreading consists not only in the production of cans of sliver of very similar weight, but also of sliver regular in grist and weight from yard to yard.

For fine work the production of a uniform length of sliver from a given weight of fibre is usually left to the skill of the spreader, who, with constant practice, can hit off the weight very correctly. A method of obtaining, from the spread-board, cans of uniform length and weight, and which is often employed in medium and coarse mills, is known as the "clock system." Under this system the spreader can be compelled to put a given weight of material into a given length of sliver, the regularity with which she does so, however, depending upon her application and diligence.

The necessary mechanism consists of a Salter's spring balance with a dial graduated up to, say, 20 lbs., and a dish to hold a like weight of fibre, both being placed convenient to the hand of the spreader. Upon the delivery roller F (fig. 24) is a worm gearing with a changeable worm pinion upon a short shaft which lies underneath the sliver plate E. Upon the other end of this short shaft is a bevel pinion driving another upon a vertical spindle, which, by means of more bevel gearing, gives motion to the hand of a dial graduated in a similar manner to that upon the Salter's balance. If 20 lbs. of fibre are placed in the tray when the hand of the geared dial points to 20, both dials will be alike. The "board" being started, the aim of the spreader must be to keep them alike by spreading the fibre regularly, taking it from the scale and reducing the indicated weight as fast as the geared hand moves round backwards

from 20 to 1. The 20 lbs. of fibre may thus be formed into any length of sliver, as the weight of yarn may require, by changing the pinion governing the speed of the geared dial hand, the delivery remaining constant.

The production of a sliver, uniform in weight and grist from yard to yard, depends entirely upon the method of spreading, as we will now explain. The degree of uniformity attained is inversely as the size of the pieces into which the fibre is divided for spreading, and directly as the amount by which these pieces overlap each other.

In spreading flax, for instance, the pieces from the sorter's bunch or from the machine room tipple, and weighing from 10 to 16 per lb., may be divided into four or more portions, which are spread in line overlapping each other to the extent that there is only from 1 to 6 inches distance from point to point of the pieces according to the length of the fibre and the size of those pieces. The shorter the fibre, the more closely together should the pieces be spread; and the closer together they are, the smaller must be the pieces to produce a sliver of given weight. Thin places, if not actual gaps, in the sliver will always be present if the draft of the board be too long or if the pieces be not sufficiently closely spread. Short fibre *requires* a short draft, while longer fibre will stand a longer one. Suppose we observe a board upon which 14-inch cut line is being spread. Being cut line, the fibres composing the pieces are more uniform in length than uncut fibre, and for this reason, and for the purpose of demonstration, we may consider the small pieces, into which the spreader divides the larger ones, as single fibres. As previously described, the spreader overlaps the pieces, leaving, say, 1 inch from point to point of each. The pieces composing this hand-formed sliver are presented to the drawing rollers in the same relative position as spread. Suppose the point of one piece is just caught in the nip of the drawing rollers—the draft being 18, or the surface speed of the drawing rollers approximately 18 times that of the fallers. While the succeeding piece is moving forward the 1 inch which it has to travel before being caught in the nip of the drawing rollers, the preceding piece has been drawn forward 18 times that distance, or 18 inches, thus forming a gap in the sliver. Had the fibre been longer or the draft shorter, the second piece would have been caught before the first had entirely disappeared, and consequently a continuous and more uniform sliver would have been produced. This shows, on an exaggerated scale, what really takes place in practice. Even in cut line the fibres are not really of the same length, consequently they are each caught in the nip at a different instant, and drawn forward to correspondingly advanced positions, thus forming an elongated and consequently attenuated sliver.

In spreading the pieces upon the leathers, the spreader should keep the top end of the piece, which goes first into the feed rollers, well pointed, so

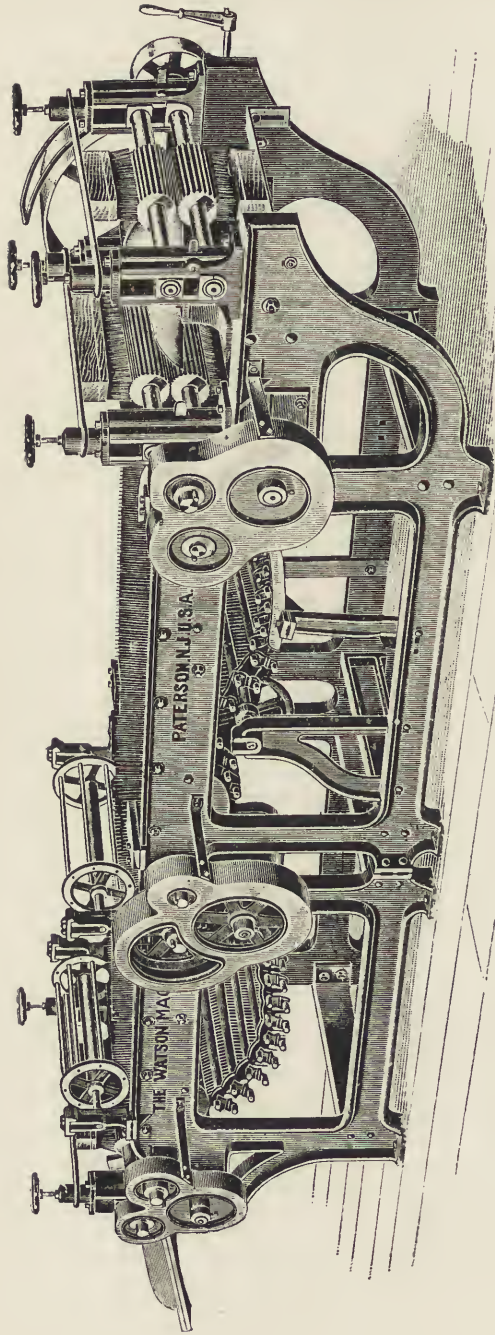

FIG. 27. — "Good's" combined hackler and spreader for Manila hemp.

that it may not catch upon and be turned over by the conductor as it enters, since, from what we have just said, it will be seen that turned ends may cause a gap in the sliver. The root end should be widened out and the piece flattened in order that the fibres may be drawn through the gill without being broken.

Throw-off Motion.

—As it is essential to successful preparing, if working on the set system from the spread-board, that there should be exactly the same length of sliver in each can, it is advisable to insure that result, in spite of inattention on the part of the front minder, by the provision of a throw-off motion to cause the automatic stoppage of the spread-board when the bell rings. A very good one, by Lawson, acts in the following manner. When the frame is working, the throwing-off handle, which has a straight up-and-down motion, rests in

a notch in a bar which is free to slide vertically in a guiding channel. When working, this bar is held at the top by a notched spring. A bell-crank lever, set free by the pin in the bell-wheel, pushes the spring off when the bell rings, and the sliding bar thus liberated falls, aided by a weight at its lower extremity, carrying with it the handle which actuates the belt fork. The force which the bell-crank lever referred to exerts upon its liberation is due to the recoil of a spiral spring attached to the lever at one end and to a fixed point at the other. When it is required to stop the board at any time, it is only necessary to spring the handle out of its notch in the sliding bar, and thus disconnect it from the rest of the motion.

Figs. 27 and 29 show the form of spread-board used to turn the raw fibres of Manila and New Zealand hemp into sliver.

Referring to figs. 28 and 29, it will be seen that the machine has two chain sheets, B and C, of gill bars, the

former of which is carried round at a speed slightly greater than the surface speed of the feed rollers D, which are fluted and pressed together by means of springs. The sheet C, however, has 5 to 11 times the surface speed of the sheet B, so that while the fibre is held by the rollers D

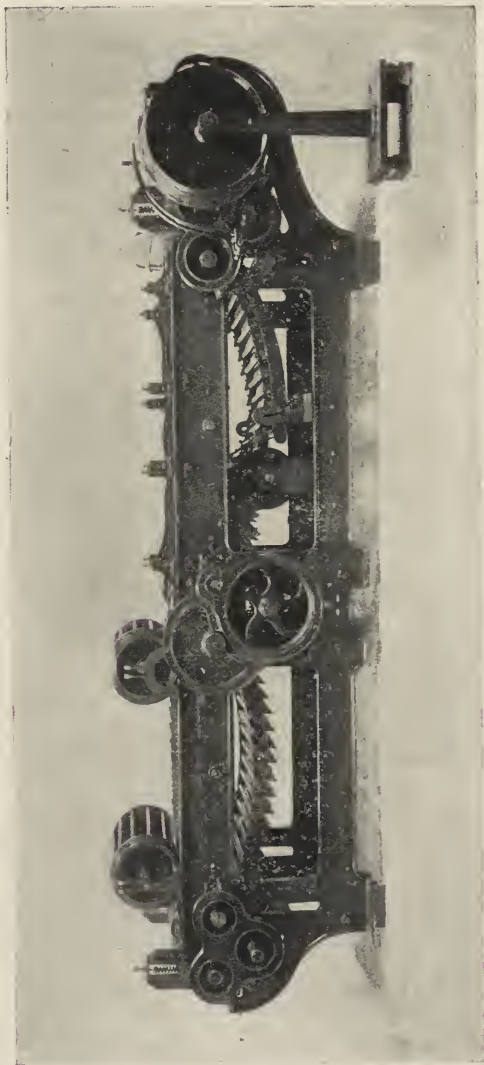

FIG. 28.—“Good’s” combined hackler, and intermediate drawings, for Manila, sisal, etc.
(Made by Messrs James Reynolds & Co., Belfast.)

and the teeth of the sheet B, it is combed or hackled, and the fibres rendered straighter and more parallel by the teeth of the sheet C. The fibre is then caught by the heavily weighted rollers E, which have a greater surface speed than the quick sheet, so that the material is consequently drawn through the teeth of the quick sheet and still further parallelised, being at the same time condensed into a sliver which is deposited in a large can, or coiled by hand into a large heap upon the floor. Hard fibre, such as that of Manila and New Zealand hemp, becomes much softer and more pliable, and works better through the gills if it is slightly lubricated. Colour being of no consequence when working hard *brown* fibre, it is usual to use a cheap mineral oil of fair body which may be applied to the material with a rose-headed can before spreading, or by the use of the apparatus shown in fig. 29, which is much superior to hand application, in that it is perfectly regular and may be varied in

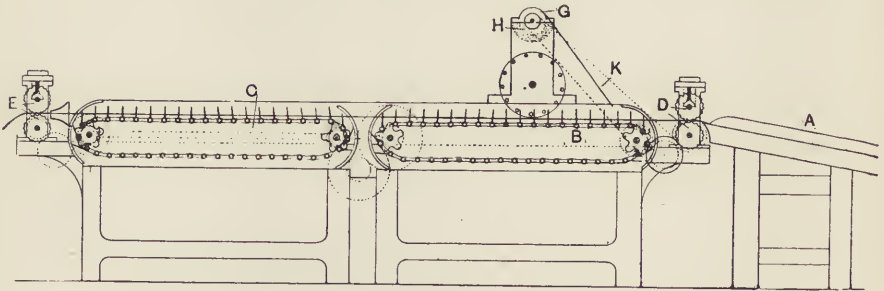

FIG. 29.—“Good’s” combined hackler and spreader for Manila fibre.

quantity as desired. G is a plain oil roller, say 24 inches wide, or rather wider than the row of gills, which is often 23 inches in breadth. The roller is partly submerged in a trough of oil H, which should be kept filled up to as near as possible the same level. Upon the end of the oil roller is a rope pulley, driven from another pulley compounded with the intermediate wheel between the feed roller and the slow sheet back roller. The oil roller, being thus turned, carries round with it a thin film of oil which is scraped off by an edge pressed against the surface of the roller, and runs down an inclined and channelled sheet K, dropping upon the fibre in the teeth of the slow sheet as shown. The feed of oil is thus regularly distributed, and stops and starts with the machine. We should mention that the oil is much more effective as a softening agent if it be heated. If it be not hot it will not sink into the fibre in the same way, and will very likely ooze out of the goods when finished. The quantity of oil used may be varied by changing the pulley on the oil roller.

The gill bars have “dogs” on their ends, which, running on guides on the sides of the framing, hold the teeth perpendicular, or give them a

slight backward rake as required. The dogs consist of elbow cranks, from one arm of which a stud projects outwards. On the outer face of the arm is a transverse groove which works upon a rib forming part of the guide. The "dogs" are alternately upon opposite ends of the bars. In this way, by increasing the thickness of the guides above or below, the foremost bars of the slow sheet may be turned so as to give their teeth a backward rake, while in the same way the rear bars and teeth of the quick sheet are given a forward rake, so that, the fibre not being able to slip over their points, they comb the material more effectually. As the bars of the quick sheet approach the drawing rollers, their teeth should be inclined backwards for the same reason. The machine should have a stop motion to cause the stoppage of the frame should the material lap round the sheet, as it sometimes does. An arrangement of this sort has a lever underneath the sheet, which lever, when depressed by such an accumulation, releases the belt fork and shifts the belt on to the slack pulley. The following are the chief particulars of a combined hackler and spreader suitable for forming sliver to be prepared for binder twine or rope yarn:—Pitch of gill bars, $4\frac{1}{2}$ inches; width of gill (one row), 23 inches; teeth in the row, 28; length of the tooth out of the bar, 5 inches; suitable drafts, 10 to 20; speed of the slow sheet in feet per minute, 16 to 32; speed of the quick sheet in feet per minute, 175; rate of delivery in feet per minute, 200.

In this machine the chain sheets are often used to communicate motion from the boss roller to the feed rollers, and the gearing is arranged in the following way:—The boss roller has a wheel of 38 teeth keyed upon it, which drives a wheel of 50 teeth on the front carrying roller of the quick sheet as shown. The back roller of the quick sheet is then driven at the same speed by a side shaft through two pairs of mitre bevels of 26 teeth each. Upon the quick sheet back roller is a wheel of 20 teeth driving a stud wheel of 80 teeth as shown. Compounded with this wheel is a stud pinion of 30 teeth, driving the wheel of 80 teeth on the front roller of the slow sheet. There are chain sprockets of 5 teeth on this roller, and similar sprocket wheels on the back sheet roller, so that this latter moves at the same speed. The back sheet roller has a wheel of 40 teeth upon it, and drives, through an intermediate, another wheel of 40 teeth on the feed roller. The boss or drawing roller and the feed rollers are of the same size, namely, 6 inches in diameter, so that, starting with the feed rollers, the relative speed of the feed and delivery, or the draft, is equal to

$$\frac{40 \times 5 \times 80 \times 80 \times 26 \times 26 \times 50 \times 6}{40 \times 5 \times 30 \times 20 \times 26 \times 26 \times 28 \times 6} = 19.$$

Large handfuls of fibre are thrown endwise upon the feed table A, spread flat as far as possible and caused to overlap each other, forming one continuous sliver, which is drawn into the machine by the feed roller. The

fibre is forced into the pins of the sheet by means of the bars of the lantern roller or wheel shown, which revolves with it.

The type of spreader usually used, by ramie spinners, to form a ribbon from the pieces which come from the flat dressing frame (fig. 21) comprises a spreading table, feed rollers, screw fallers and gills, such as we have described. The drawing rollers are fluted, and the fleece of fibre issuing from them, instead of being condensed into a narrow sliver, is formed by the lap cylinder and its enveloping apron into a roll or lap, which is used to feed the following machine.

Breaker or Devil Card.—The formation of sliver from the short and tangled fibres or tow, which has been formed in the scutching and hackling processes, requires machinery of quite a different nature, the process being known as earding. Combining a splitting and cleaning action with sliver formation, this process affords a cheaper method of forming a ribbon than that already described, and for this reason is often employed for long fibre of low quality such as the common marks of Riga and Pernau flax and for jute. Long fibre thus treated is said to be "broken up" or made into tow.

Figs. 30 and 31 show the form of machine best adapted to that purpose. It is called a "breaker" or "devil" card. The fibre is spread upon the inclined feed sheet A (fig. 31), passes between the shell B and the feed roller C, and is broken over the edge of the shell and carried away by the cylinder D. Two pairs of workers and strippers, E and F, open the material still further before it reaches the doffer G, which is stripped by the rollers H, which catch the long "braird" standing up upon the doffer, draw it off, and either deposit it upon the floor or pass it down over a broad tin conductor, which gradually contracts into a bell mouth at the calender rollers, which compress the sliver thus formed and deposit it in a can.

In fig. 31 the feed sheet A is of canvas or of leather, the shell B is of cast iron, and its edge approaches parallel to, and close to, the face of the cylinder D, which is usually about 4 feet in diameter, and 4 feet in width or in face, and turns at a speed of about 180 revolutions per minute in the direction of the arrow. It is clothed with "lags" or staves of beechwood, X, set with needle-pointed steel pins at a distance of about 9 per square inch. The feed roller C, the strippers and workers E and F, and the doffer G, are clothed in a similar manner or with steel-covered leather fillet set with steel or iron wire teeth put in in the form of a staple. Their pins are much longer than those of the cylinder, since it is their function to hold the fibre, for which reason also, those of the workers especially, are given what is known as a knee bend. The angle or inclination of the pins on the cylinder and rollers is of great importance in increasing or diminishing the efficiency of the card, both as regards the quality of the work done and the quantity of waste made. The angles most usually employed

are—cylinder 75° with the surface, feed roller 60°, strippers 30°, workers 40°, and doffer 35°. Pins set in leather usually traverse their foundation

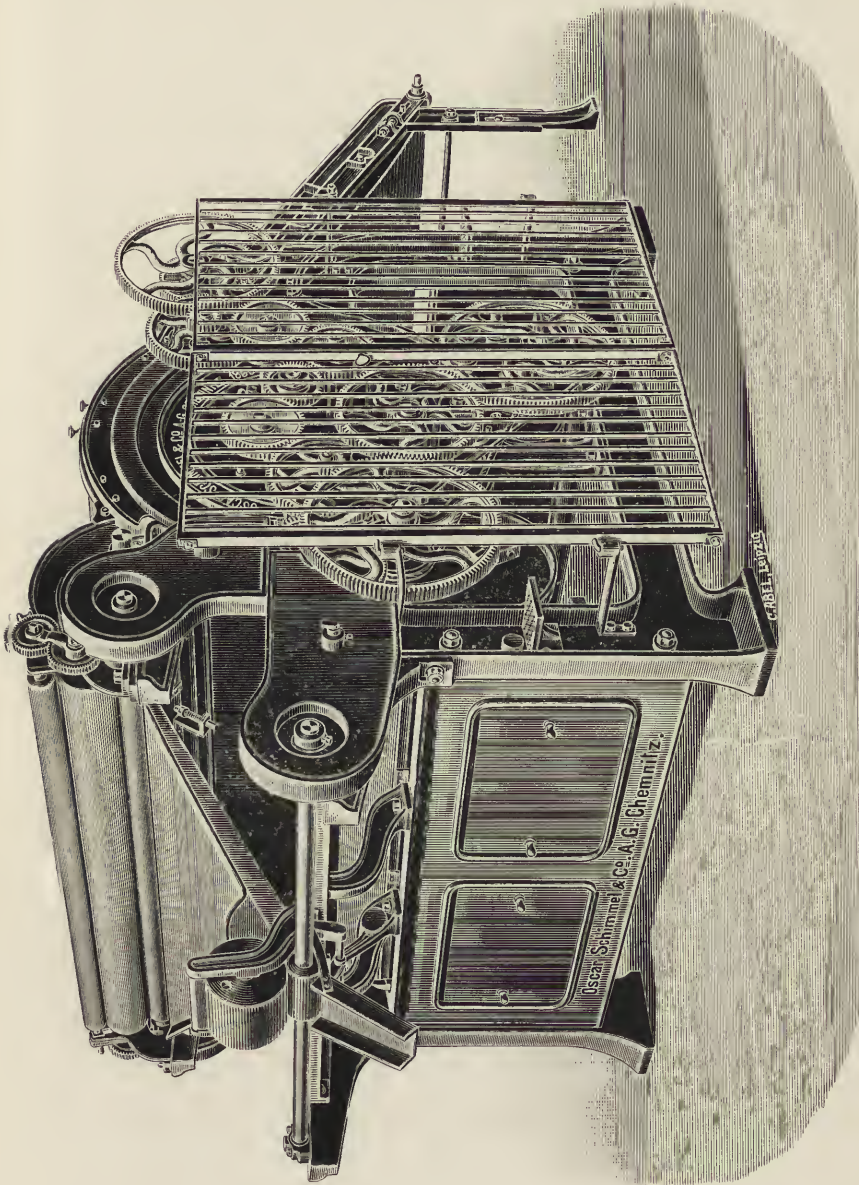

FIG. 30.—Breaker card for jute.

at right angles, and are then “knee bent” to the required angle. Pins set in wood cannot be “knee bent,” but must be sent through the lag in a

sloping direction. Each pair of rollers is set close to each other and to the cylinder, the stripper being in advance of the worker, relatively to the direction of motion of the cylinder. The pins of the cylinder are inclined towards the direction of motion in order to hold the material. The pins of the worker oppose those of the cylinder, and consequently comb, clean and render parallel the fibres which are held by the cylinder pins. In doing so, the worker retains much tangled fibre, lumps, etc., which it carries round until it is cleared by the stripper, which has a surface speed 50 to 100 times that of the worker. The angle of the stripper pins is in the direction of their rotation, so that they retain the material until they are themselves stripped by the cylinder revolving at seven or eight times their surface speed. The doffer acts in a similar manner to a worker, and is cleared by the pair of plain or scored rollers as described.

The following is a very usual setting for a breaker card:—Feed roller

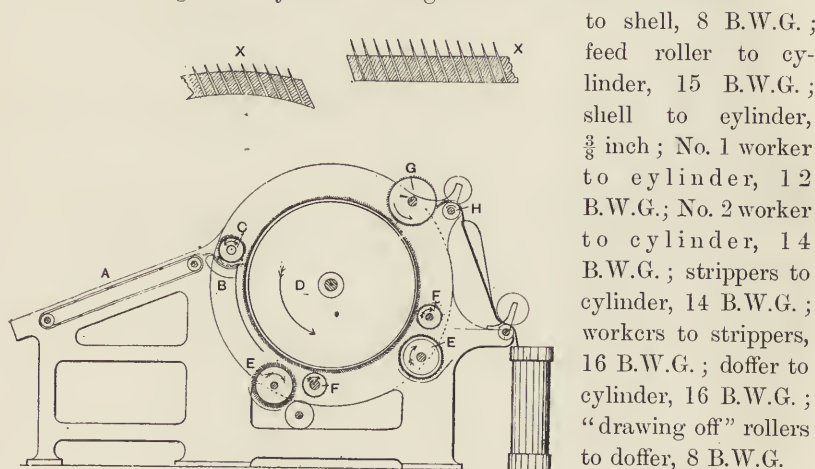

FIG. 31.—Breaker card.

to shell, 8 B.W.G. ;
 feed roller to cylinder, 15 B.W.G. ;
 shell to cylinder, $\frac{3}{8}$ inch ;
 No. 1 worker to cylinder, 12 B.W.G. ;
 No. 2 worker to cylinder, 14 B.W.G. ;
 strippers to cylinder, 14 B.W.G. ;
 workers to strippers, 16 B.W.G. ;
 doffer to cylinder, 16 B.W.G. ;
 "drawing off" rollers to doffer, 8 B.W.G.

Instead of the "shell feed" just described, where the feed roller C holds the fibre while the pins of the cylinder hackle and break it away as it hangs over the edge of the shell B, another form of breaker card has a pair of fluted feed rollers from which the fibre is taken by a revolving roller about 18 inches in diameter, clothed with coarse steel-covered leather fillet. This roller is usually driven by a wheel in which a safety pin is inserted so that it may run out of gear if a large lump, such as would injure the cylinder, is passed in by the feed rollers. By means of a handle the operator should also be able to reverse or stop the feed rollers at will. The large taking-in roller is stripped by the cylinder, which, striking downwards, carries the material past two or three pairs of workers and

strippers as before. Nearly all breaker cards have plain tin rollers, known as dummy rollers, set in the spaces between the pairs of rollers on the under side of the card. The function of these dummies is to prevent any long fibre from falling to waste, while permitting the shove, etc., to escape. They revolve at about the same speed as the workers.

Carding.—Card pins for working long vegetable fibres are round or needle-pointed, being ground prior to insertion in the beech or oak staves or leather fillet. The staves or “lags” are generally $\frac{3}{8}$ inch to $\frac{3}{4}$ inch thick according to the work and 24 inches long, which means two or three rows respectively for cards of 4 feet and 6 feet face. The “lags” should be hollowed in the inside and rounded on the face to the circle of the cylinder or roller upon which they are to be placed. Leather fillet is usually 2 inches broad and $\frac{3}{16}$ inch or $\frac{1}{4}$ inch thick. The ends of the pieces of which it is composed are planed off, as regards thickness, to a point, so that they may be cemented together without increase of thickness at the joint. One end of the fillet having been first bevelled off to a point in breadth from a distance equal to the circumference of the roller for which it is intended, it is attached by screws to the end of the roller, and then the length of the fillet tightly and closely lapped spirally round the roller until the other end is reached, when it is again screwed to the roller, and the end cut off level with the edge of the roller. It is advisable to put in additional screws at intervals across the face of the roller, lest, by some accident, one portion of the fillet should become detached or broken while the card is working, and the whole length be wrapped round the cylinder or some of the other rollers, doing damage which it will require days to repair.

The “clock system,” as described for the spread-board, page 70, is often used in connection with the breaker card, in order to obtain sliver of uniform weight for a given length.

Ramie tow or noil is usually carded and put into the form of sliver over an ordinary roller card, as used for cotton.

CHAPTER VIII.

TOW CARDING AND MIXING.

Fine Carding.—In the last chapter we treated of carding merely as a means of breaking up and forming into a sliver certain coarse long fibres which do not possess sufficient quality to render them worthy of the more expensive hackling and spreading treatment. Fine carding is a continuation of the same operation with the object of further cleaning and parallelising the fibres, which are again delivered in the form of sliver.

Finisher Card.—Figs. 32, 33 and 34 show the type of finisher card as used for flax, hemp and jute. Fibre coming from the breaker card, if in the form of sliver, is fed in by placing the requisite number of cans at the rear of the feed sheet, which draws the sliver from the can and delivers it to the feed rollers. If it be in a loose condition, it is, like flax, hemp and jute tows produced in the hackling process, spread upon the feed sheet C, fig. 32, by hand, or by means of the automatic feeder shown in the figure.

In order to obtain the delivery of a sliver of uniform weight per unit of length, the tow must be regularly spread upon the feed sheet. With the automatic feeder shown in fig. 32, laps of a given weight are automatically weighed in the balance 1, 2, and then deposited at regular intervals upon the travelling feed sheet C. The tow to be worked is placed in the hopper 3, and carried away by a spiked apron 4, which is driven by a friction clutch 5, and a belt from the feeder shaft 6, which receives motion from the card itself by the belt 7. The swinging knife 8 levels the tow upon the spiked apron and prevents too much from passing, while a similar knife, 9, strips it off and throws it into the bucket 2 of the weighing apparatus. By shifting the weight W on the arm of the beam, which is balanced on a knife edge 10, any weight of a lap may be formed; for when the bucket falls, owing to the weight of the tow in it, the tumbler 11, which has been holding the weighted dog or catch 13, out of contact with the notched disc of the friction clutch, is moved and the catch holds the spiked apron at rest, stopping the delivery of tow. When the proper moment for depositing the lap has arrived, or when a pin in the wheel 14 comes in contact with the tail end of a lever 15, fulcrumed in 16, the long sword arm 17 of the lever 15 is depressed, and coming in contact with a

pin opens the two swinging sides of the bucket 2, permitting its contents to fall upon the travelling lattice 18. A travelling board, 19, actuated by a crank on the same wheel, 14, follows up each lap and unites it with the previous one, while a beater, 20, cements the union and levels the tow upon the sheet. The rising of the empty bucket places the tumbler, 11, in a position to again hold the catch, which is now withdrawn by another lever actuated by a pin in the wheel 14, and a new cycle of operations commences. This feeder was introduced about twelve years ago from the woollen trade, and has never been a great success as regards quality of work, owing to the length of the fibre and the high speed of the feed sheet or the comparatively short draft of tow cards as compared with woollen cards. In spite of the action of the board 19 and the beater 20, the fibre

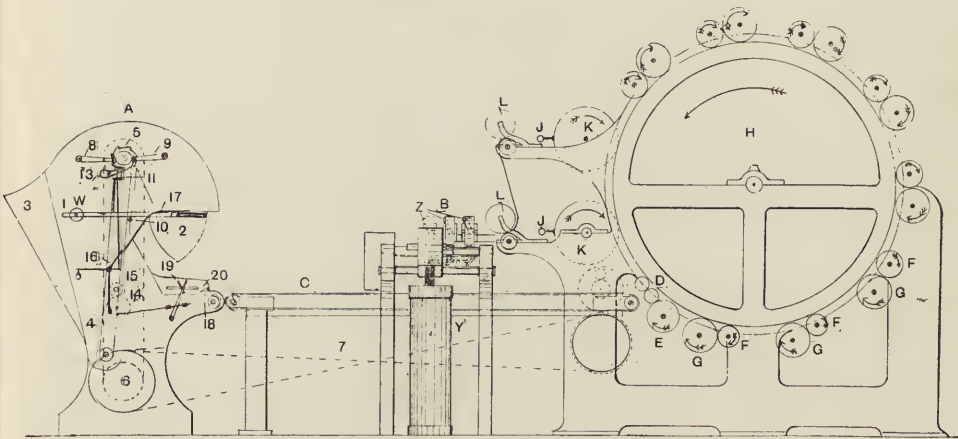

FIG. 32.—Finisher card with hopper feed.

is unevenly laid upon the feed sheet, the result being a regular succession of thick and thin places, the latter marking the junction of the laps. An improvement is effected by throwing down the laps diagonally, but hand feeding, if properly carried out, is really the best.

The care which is exercised in this respect on the Continent has a great deal to do with the superiority of many French, German, and Belgian tow yarns.

The best way to make really good work with the hand is to mark off the feed sheet into well-defined sections, which have usually an area of about 36×22 inches, or 792 square inches. The correct quantity of tow to spread upon these given areas may be found by experiment, or calculated, if the approximate quantity of card waste is known. Suppose that we wish to produce card sliver weighing $1\frac{1}{2}$ lbs. per 100 yards, and that the card waste of this class of material has been found to be equal to

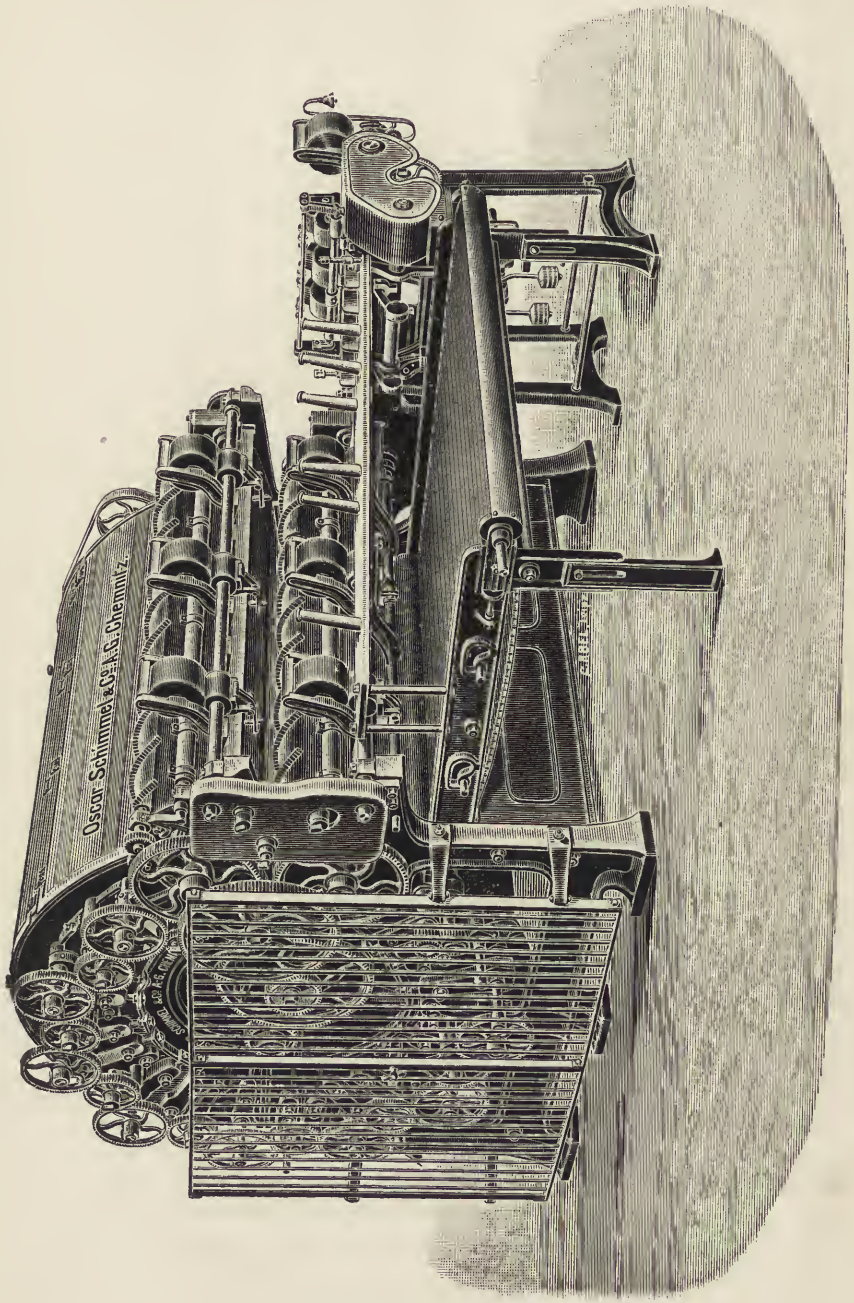

FIG. 33.—Tow card.

2.5 per cent. of raw material to the card. The draft of the card, or the relative surface speed of the drawing-off and feed rollers, we will suppose to be 20. If there be no drawing head, this is all we require. If there

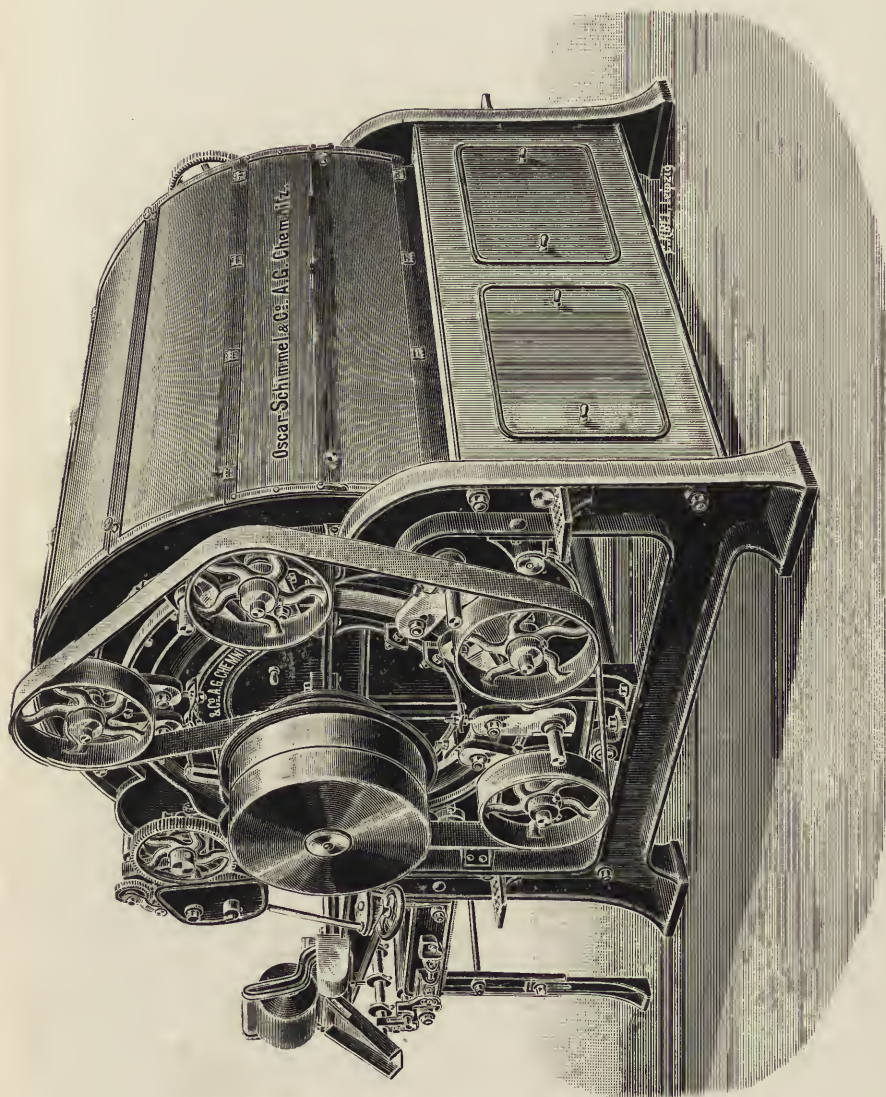

FIG. 34.—Finisher card for jute.

is a drawing head, say, with a draft of 2, the effective draft of the card and drawing head combined is the product of their drafts, or $20 \times 2 = 40$. In this case the weight of tow to be spread over each area of 792

square inches, there being three such areas in the width of the card, is $(1\frac{1}{2} + 33\frac{1}{3} \text{ per cent.}) \times 40 = \frac{2 \times 40}{3 \times 100} = \frac{4}{15} \text{ lb.} = 69 \text{ drs.}$ nearly. It will be seen that $33\frac{1}{3}$ per cent. on the weight of the sliver is the equivalent of 25 per cent. on the raw material. If the card be the same, but without a drawing head, the weight which must be put into the scale to weigh the laps of tow will only require to be $\frac{6.9}{2} = 34\frac{1}{2}$ drs.

Balling or Lap Machine.—In some mills a ball or lap-forming machine is used to form a number of slivers from the breaker card into a lap which is used to feed the fine or finishing card. Such a machine consists merely of a framing carrying a pair of calender rollers, a back sliver plate, and a surface drum upon which the lap is wound upon a rod or tube. Cans from the breaker card to the number of six to twelve are placed at the back, and the slivers evenly distributed over the required breadth. They thus form an even sheet, say 22 inches in width, which is compressed and wound into a lap. These laps are then placed in a stand at the end of the fine card feed sheet and gradually unrolled and fed into the feed rollers.

Full Circle Downstriker Roller Card.—The ordinary finisher card, as used for flax and fine hemp tows, and shown in figs. 32 and 33, is a full circle downstriker roller card. The cylinder H is usually either 4, 5 or 6 feet in diameter, and the face or breadth 6 feet. The feed sheet C is horizontal, and approaches the cylinder considerably below the level of its centre. The axle of the cylinder is supported on either side, in pedestals attached to the side framing, which also carries one, two, or three doffers K, and the adjustable brackets supporting the feed rollers D, the workers F, and the strippers G. In this card there are two feed rollers D set fairly close together and turning in such a way as to draw in the material between them and present it to the cylinder. The teeth of both rollers are set in brass shells about 3 inches in diameter, and are inclined in a direction opposite to that in which the rollers turn; so that the cylinder, striking downwards, at a distance equal to 12 to 18 B.W.G. from the top feed roller, clears it. The bottom feed roller, whose teeth oppose those of the cylinder, is set at a greater distance from it, say 7 to 13 B.W.G., so that the raw material, which is being subjected to the action of the cylinder for the first time, may not be too severely dealt with, but merely prepared for the first worker, which is set considerably closer to the cylinder. The bottom feed roller acts, in addition, in the same manner as a worker, and must be cleared by a stripper E, which in this case is placed on its rear side, instead of on the front side as with the workers, a clear proof that a stripper will act equally well on either side of a worker. The surface speed of the feed rollers, their diameter being reckoned as the diameter of the barrel plus the length of the pin on one side only, should be rather greater than that of the feed sheet, so that all tendency to choke may be avoided.

The number of pairs of workers and strippers surrounding the cylinder varies according to the diameter of the latter and the fineness of the card. There may be from four to ten. A card is usually described as having, say, $8\frac{1}{2}$ pairs of rollers, the half pair denoting the feed stripper E. The doffers K are cleared by vibrating knives or combs J, instead of by drawing-off rollers, as in the "devil" card, figs. 30 and 31. On a card which is 6 feet broad the web of tow from each doffer is usually divided into three parts, each of which is drawn through a trumpet-mouthed conductor by the condensing rollers L and passed down and doubled with the corresponding sliver from the doffer below. The combined slivers from the bottom doffer are passed round "horns" Z, inserted in a smooth sliver plate, upon which the three slivers are conducted to the side of the card and either at once doubled together and delivered into a can Y by calender rollers, or first passed over what is known as a "rotary" or "drawing-head," upon which they are given a short draft through gills, then doubled together upon a sliver plate and deposited in a can by delivery rollers.

The diameter of the workers of the finisher card is from 4 to 7 inches and the strippers 5 to 8 inches, according to their number and the fineness of the card. This diameter must bear some relation to the length of the fibre to be worked, as long fibres require large rollers, so that the material cannot completely encircle the roller and thus oppose easy stripping and produce laps. The doffers are from 18 to 24 inches in diameter. The cylinder is driven at a speed of from 160 to 210 revolutions per minute, while the workers make four to twelve and the strippers 260 to 400 revolutions respectively in the same time. The card receives its motion by a belt which drives the main cylinder from a drum on the line shaft. The strippers and doffing knives are driven by one long belt from a pulley on the axle of the main cylinder. The workers, feeds and doffers are driven by gearing from a pinion upon the other end of the main cylinder axle. As regards the direction of inclination of the pins, those on the workers and doffers oppose those on the cylinder, while as regards direction of rotation they recede before it. It will thus be seen that quick workers give less work, so that by providing change pinions the card may be adapted to obtain the best results from various classes of tow. A large cylinder pinion causes both feed workers and doffers to run quicker, while the speed of the cylinder remains the same; so that in addition to a reduction in cleaning capacity caused by the quick workers, the material is actually run quicker through the card, receiving in its transit less work from the cylinder in consequence. The strippers throw off impurities in proportion to their speed, for which reason they are often run rather fast when working nappy tow.

For reasons such as these as stated above, to work hard and clean tow, the workers and strippers should be run slow, while a large cylinder pinion

should be employed. To take out naps, run the workers and strippers fast and use a medium cylinder pinion with close setting all round the card. To make clean sliver from dirty tow regardless of waste, the strippers must be fast or the workers slow. Less cleaning and less waste is effected by passing the tow quickly through the card by putting on a large cylinder pinion. If the tow is full of a sticky shove, in order to clean it, the workers must be slow. If the shove be loose, fast workers will do. For soft and dirty tows, fast workers and strippers with a medium cylinder pinion is what is required. For hard, dirty tow, run the workers slow, the strippers at a moderate speed, and use a large cylinder pinion. For soft, clean tows, run the workers fast and the strippers slow, and use a medium cylinder pinion.

As regards the setting of the card, the distance apart of the surfaces of the rollers in relation to each other and to the cylinder is a most important point in tow carding. First, as regards the feed rollers, which receive between them the uncarded fibre and deliver it to the card, the distance between them must be such as to contain the comparative thick and heavy sheet of raw material without straining the rollers. They must, however, be sufficiently close to exert a controlling action over the delivery of the tow to the cylinder, and not permit it to be carried away in lumps. The distance from point to point of their pins, which are about $\frac{1}{2}$ inch out of the brass, ranges from 8 to 10 B.W.G. according to the weight of the feed. As the top feed roller is cleared of any tow which may tend to lap round it, by the revolving cylinder, it must be set sufficiently close to the latter to be brought under its influence, say a distance equal to from 12 to 18 B.W.G.

As in the hackling machine, where we use a very coarse hackle at first, the bottom feed roller, which acts as a worker with regard to the cylinder, must not be set too close to the latter, or the fibre will be too severely handled and broken up. The usual distance equals 7 to 13 B.W.G.

For a reason just mentioned, the rollers all round the card should be more distant from the cylinder the nearer they are to the feed roller and to the entry of the raw material, while their distance from the cylinder should diminish as the fibre becomes combed and level, as it does as it approaches the doffers. The first worker may be set to the cylinder with a 10 to 15 B.W.G., while the last worker is distant only 13 to 19 B.W.G., both according to the fineness of the card. In a similar way the strippers may be set to their workers and to the cylinder at a distance equal to 12 to 22 B.W.G.

The doffers, being in their order the furthest removed from the feeds, are set quite close, say 13 to 22 B.W.G. When there is more than one doffer, the second is set to the cylinder one number finer than the top; while if there be three doffers, the bottom one is set one number closer than

is the middle one. The calender or collecting rollers for the bottom doffer, or for the middle and bottom doffer, if there be three, are given a slight lead in surface speed over the rollers above them, in order to keep the slivers tight. For the same reason the feed rollers of the drawing head, if there be one, should also have a slightly greater surface speed than the collecting rollers of the bottom doffer.

The weight of the sliver in grains per yard for a 6 × 5 tow card should be nearly as follows:—10's to 12's lea = 182 grs., 14's to 16's lea = 154 grs., 18's to 22's lea = 119 grs., 25's to 30's lea = 102 grs., 35's to 60's lea = 84 grs.; and the weight put through each card per day of ten hours—10's to 12's lea, 500 lbs.; 14's to 16's lea, 440 lbs.; 18's to 22's lea, 380 lbs.; 25's to 30's lea, 330 lbs.; 35's to 60's lea, 260 lbs.

When three doffers are employed, the tow must be fed rather heavily or quickly to the card, in order that the nine slivers from the three doffers may have sufficient consistency to carry.

In order that the cylinder may carry a heavy load of fibre without dropping a large portion of it, the pins must be long and of considerable rake. Since the teeth of the cylinder and workers do not intersect each other, and are not even point to point, it is only those fibres which project above the surface which receive any work. When the cylinder is heavily loaded, most of the material is below the surface and hence receives no work. Considerations of this sort have led of late years to a tendency towards lighter loading of the card, a shorter cylinder pin, and consequent reduction of the number of doffers to two and even to one.

One-doffer Card.—A card recently in vogue has but one doffer, which, however, is considerably over the ordinary size, in order that a large number of gathering points may be exposed on the line of near approach of cylinder and doffer.

Light carding means light card sliver, which has led to the rejection, in some cases, of the rotary head.

This machine reduces the weight of the sliver by drafting, but does not increase its levelness, since no doublings are or can be introduced. Its one advantage is the increased parallelism it gives to the fibres, which, in turn, adds to the strength of the sliver. An old three-doffer card may easily be adapted for lighter carding by removing the top doffer and inserting in its place an additional pair of workers and strippers.

Card-doffing Knives.—Card-doffing knives are of two sorts, known as quick and slow speed. The latter is an old type still at work in some mills, the two or three knives being linked together and driven, or given a reciprocating up-and-down motion, by means of cranks on a shaft driven by the stripper belt.

In the new quick-speed knife, motion is given to each separately, by means of eccentrics driven at a high speed and revolving in oil-baths.

Whichever form be used, the working centre of each comb should be in the same plane as the centre of the doffer, and the length of the oscillation should be the same on either side of this line. The comb should be set as close as possible to the doffer without touching it. Circular revolving brushes are placed in contact with the doffers at a point above the combs or doffing knives. These brushes keep the doffer clean by gathering up any stray fibres which may have escaped the action of the knives. Bands of brass around the doffers will be found useful in producing a good division of the fleece among the three or more drawing-off or calender rollers.

Covering in of Cards.—The covering in of flax, hemp and jute cards is now rendered necessary by law, so that it is almost impossible for accidents to occur, except through the greatest carelessness. When they do occur, they are generally of a serious character, as the card is a most dangerous machine. The covers are generally of sheet iron surrounding the upper portion and sides down to the ground. In some mills, means are provided to draw away the dust generated inside the cover by means of suction pipes and a fan.

Card Fires.—As fires are of no unusual occurrence, especially with some sorts of tow, such an arrangement may assist the spread of the fire from one card to another. When a fire occurs, the chief aim of those in charge should be to keep it confined to the card in which it is burning, and to protect that card from injury. Water should be thrown upon the floor under and around the card, but on no account upon it, as the best way of preserving the clothing of the rollers and cylinder from injury is to keep them running. Whiting may be thrown upon fiercely burning portions or into corners, with good effect and without injury to the card.

The Gearing and Driving of the Card.—We will now deal with the gearing of the card, from which the speed of the various rollers may be obtained. The speed of the line shaft is the first consideration. This should be run at about the same speed as that at which it is desired to run the main cylinder of the card, since the card being a very heavy machine to drive, and especially so to start from a state of rest, it will be found advisable to have both driving drum and driven pulley about the same size, and about 26 inches in diameter, in order to get a good bearing surface for the belt on both drum and pulley. Suppose the line shaft to run at 200 revolutions per minute and to have upon it a 26-inch drum driving a pulley of the same diameter upon the end of the axle of the main card cylinder. The cylinder will thus also make 200 revolutions per minute. First take a case where the workers, doffers and feed rollers are driven from the cylinder by means of a cylinder pinion fixed upon the opposite end of the cylinder axle to that on which the driving pulley is keyed. With a medium cylinder pinion of, say, 30 teeth and the worker wheels having 72 teeth, the latter may be driven through a train of intermediates, comprising two

double reducing wheels of, say, 130 and 35, 136 and 50 teeth respectively, at a speed of $\frac{200 \times 30 \times 35 \times 50}{130 \times 136 \times 72} =$ nearly $8\frac{1}{2}$ revolutions per minute. By

changing one of these stud pinions, the speed of the workers may be changed at will. The so-called draft of the card being, as in all other machines, the relative surface speeds of feed and delivery, we will proceed to find the length delivered by the delivery rollers while the feed roller is making one revolution, and then divide by the circumference of the feed roller and thus obtain the draft of the card. The gearing between the feed and delivery rollers comprises the feed roller wheel of, say, 80 teeth, doffer pinion 36 teeth, doffer wheel 136 teeth, and delivery roller pinions of 26 teeth. The diameter of the delivery roller being 4 inches, $\frac{80 \times 136 \times 4 \times 3 \cdot 1416}{36 \times 26} = 146$ inches are delivered for each revolution of the

feeds, which, if $3\frac{1}{4}$ inches in diameter or 10·2 inches in circumference, means a draft of $\frac{146}{10 \cdot 2} = 14 \cdot 3$. Where the draft gearing is all on the same

side of the card it is generally driven by one of the delivery rollers which receives its motion from the drawing head, which is driven by a belt, as we will presently explain. The gearing arranged in this way may be as follows:—Diameter of the feed rollers $2\frac{3}{4}$ inches, feed roller wheel 130 teeth, stud pinion 46 teeth, stud wheel 92 teeth, delivery roller pinion 27 teeth, and the diameter of the delivery roller $4\frac{1}{4}$ inches, giving a draft of $\frac{130 \times 92 \times 4\frac{1}{4}}{46 \times 27 \times 2\frac{3}{4}} = 14 \cdot 8$.

The speed of the strippers on the same card may be found from that of the cylinder by multiplying the latter by the diameter of the fancy pulley and dividing by the diameter of the stripper pulley. Thus with a fancy pulley 20 inches in diameter and stripper pulleys 14 inches in diameter, the speed of the latter will be $\frac{200 \times 20}{14} =$ nearly 286 revolutions.

It is the surface speed of the rollers, however, which is the point to be considered. If the cylinder be 5 feet in diameter to the point of its pins, its surface speed will be $200 \times 5 \times 3 \cdot 1416 = 3141 \cdot 6$ feet per minute, while that of the workers and strippers, their diameters being 7 and 8 inches respectively, will be $\frac{8 \cdot 25 \times 7 \times 3 \cdot 1416}{12} = 15 \cdot 1$ feet, and $\frac{286 \times 8 \times 3 \cdot 1416}{12} = 599$ feet.

Their relative surface speeds, that of the cylinder being taken as 100, are then—cylinder 100, strippers 19, and workers ·5 nearly. These speeds will give good results with Baltic tows containing a considerable quantity of loose shove. Modifications may be made to suit any special work, such as clean soft tow, hard dirty tow, or fine nappy tow, etc., if the functions of the rollers as set forth be borne in mind.

Fineness of the Card Clothing.—The fineness of the clothing of the rollers of the card is generally in proportion to that of the cylinder, while the latter depends upon the work for which the card is intended, varying from 4 to 9 pins per square inch, in a coarse breaker card, to 64 pins per square inch in some of the latest fine cards.

On the Continent the fineness of the card is generally expressed as above, in pins per square inch; while elsewhere one finds the pins per inch in the row spoken of, the latter being quite as explicit as the former, it being understood that the pins per inch count the same both ways as regards the cylinder staves, so that, for instance, 6 per inch in the row equals $6 \times 6 = 36$ per square inch. The following tables show the usual grades of tow card clothing both in wood and leather.

CARD STAVES OR LAGS.

Staves for—	Pins per inch	2	2½	3	3½	4	4½	5	5½	6	6½	7	7½	8
Cylinder 24 in. × 3 in. .	Pins per square inch.	4	6	9	12	16	20	25	30	36	42	49	56	64
Strippers 24 in. × 2½ in. .	No. of wire B.W.G.	12	14	16	16	17	17	18	18	19	19	19	20	20
Doffers 24 in. × 2½ in. .	Length of pin out of wood for cylinder clothing	$\frac{3}{16}$	$\frac{3}{16}$	$\frac{1}{4}$	$\frac{1}{4}$	$\frac{1}{4}$	$\frac{1}{4}$	$\frac{1}{4}$	$\frac{1}{4}$	$\frac{1}{4}$	$\frac{1}{4}$	$\frac{1}{4}$	$\frac{1}{4}$	$\frac{1}{4}$

LEATHER CARD FILETING.

Pins per inch .	2×2	2×3	2×4	2×5	3×5	3×6	3×7	3×8	4×8	4×10	5×10	5×12	5×14	6×14	6×17	6×20
Pins per square inch	4	6	8	10	15	18	21	24	32	40	50	60	70	84	102	120
Length of pin out of leather	$\frac{1}{8}$ in.	$\frac{1}{8}$ in.	$\frac{1}{8}$ in.	$\frac{1}{8}$ in.	$\frac{1}{8}$ in.	$\frac{3}{16}$ in.	$\frac{3}{16}$ in.	$\frac{3}{16}$ in.	$\frac{1}{4}$ in.	$\frac{1}{4}$ in.	$\frac{1}{4}$ in.	$\frac{1}{4}$ in.	$\frac{1}{4}$ in.	$\frac{1}{4}$ in.	$\frac{1}{4}$ in.	$\frac{1}{4}$ in.
No. of wire B.W.G.	10	11	12	13	14	15	16	17	18	19	20	21	22	23	24	25

It will be noticed that in fileting for workers, strippers and doffers, the wire used is generally coarser than it is for the same number of pins per inch in wood, because the pins, besides being longer, are weaker, in that they are of iron and not of steel.

The Rotary Head.—The “Rotary” is a small drawing head, placed at the side of the card, which receives the three slivers, as delivered from the calender or collecting rollers, and drafts them out. It has a pair of back or retaining rollers, as shown in fig. 35, a set of gill bars, a brass roller with wooden pressing rollers, a doubling plate, and a pair of delivery or calender rollers. The gill bars have three rows of gills corresponding with the three slivers from the bottom doffer, which are led along the sliver plate and passed into the back rollers of the rotary. The rollers of the latter are thus at right angles to the cylinder of the card. The delivery into the can

may be in either direction, but it is convenient to have it at the front side of the rotary, so that it may be easily watched by the earder who is feeding at the front of the eard.

Owing to the high speed at which the machine runs, screw gills are never employed in drawing heads of this description.

The name "rotary head" itself is derived from an old way of driving the gill bars, which is still in considerable use.

In this arrangement there is, between the drawing and retaining rollers, a barrel with deep brass flanges or ends in which a number of slots are cut in an almost radial direction. Into these slots the ends of the gill bars pass freely, projecting on the other side into a cam-shaped groove, which, while the barrel revolves, determines and directs their movements as they are carried round. The shape of the groove is so arranged that the gills rise fairly perpendicularly and close to the feed rollers, and approach fairly close to the nip of the drawing rollers. Several inventors have tried, with success, to imitate more perfectly the direct penetration and fall of the screw gill without diminishing the velocity of the bars.

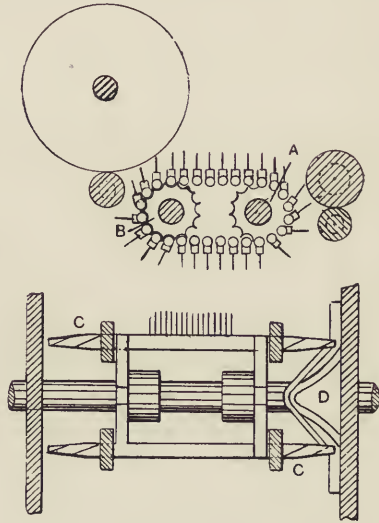

FIG. 35.—Push-bar drawing head.

One of the best and simplest of these motions is known as the "push-bar," since, after being raised in the teeth of a pinion, one bar pushes the others along a horizontal slide, until it enters the teeth of a similar pinion, which supports it until the bottom slide is reached. The opposite ends of alternate bars have crank-shaped lugs or pieces attached to them, which, while the round of the bar is in the teeth of the pinion, are guided in an outside groove, which controls and renders perpendicular the ascent and descent of the gills.

Short "nips," or near approach of the gill to the rollers, back and front, is an important point in gill drawing. If the gills rise too far from the back rollers, and at a considerable inclination to the vertical, they do not penetrate or "pin" the sliver properly; while, if they drop before approaching close to the drawing roller, the drafting of the sliver is uncontrolled and the material is "gulped" or drawn away irregularly, causing thick and thin places in the sliver produced.

Gamble's Push-bar Drawing Head.—In the arrangement shown in

fig. 35, which is known as Gamble's patent, and made by Messrs Combe, Barbour & Combe, Ltd., Belfast, in order that the gill bars and gills may be controlled during their ascent and descent into the required angle, the ends of the bars C are made flat or oval, and are more or less twisted as shown. Special guides D act progressively along the twisted surface, and coming in contact with different portions of it, turn the bar into the required position, and keep it there while the rise or fall takes place.

Drawing Head.—The calculation for the draft of the drawing head is similar to that of the spread-board, page 69, so that a single example is all that anyone will require. Take the actual case of a rotary which has a back roller wheel of 44 teeth, a stud pinion of 16 teeth compounded with a stud wheel of 28 teeth, which gears with the back shaft pinion of 22 teeth. On the other end of the back shaft is a draft change wheel which, we will say, has 25 teeth, and drives a boss roller wheel of 40 teeth through carriers.

The diameter of the back roller being $1\frac{3}{4}$ inches and that of the boss roller 2 inches, the calculated draft is then $\frac{44 \times 28 \times 25 \times 2}{16 \times 22 \times 40 \times 1.75} = 2.5$.

Drawing heads are driven in a variety of ways. The older way of driving through a cross shaft from the geared side of the card, employing a clutch to throw the rotary alone out of gear, is not so convenient as the newer way of driving the rotary, through a fast-and-loose pulley and a belt, from a pulley on the cylinder shaft, as the feed roller and doffer gearing may also be connected with this drive, so that if it be found necessary to stop the rotary for a moment the feed rollers and doffer are brought to rest at the same time, stopping delivery to and from the card and allowing all to start off again without trouble. When the card has been stopped in this way, it is advisable to run off a few yards of sliver after starting, as the tow which has remained in the card may have been rather weakened by the continued revolution of the cylinder.

Gearing.—The gearing usually occupies one side of the card and the pulleys and belts the other. The most usual way of giving motion to the workers, feeds and doffers is by means of the changeable cylinder pinion placed on the free end of the cylinder axle, but occasionally all the gearing of the card is independent of the cylinder and receives motion from the drawing head, which is itself driven by a belt from the cylinder axle. Sometimes only the feed and doffer gearing is independent, while the workers are driven by a cylinder pinion. In connection with the feed roller wheel it is advisable to have some sort of a safety device, so that if any foreign substance is introduced by accident with the tow between the feed rollers, they may be automatically stopped and thus save the cylinder and rollers from damage.

Safety Devices.—A very good arrangement is to have the intermediate

wheel, which gears with the feed roller wheel, working upon a stud set in the short arm of a bell crank lever, the long arm of which is weighted so as to keep the wheels in gear under ordinary circumstances, but which will allow the teeth to slip over each other when the free motion of the feed rollers is obstructed.

Mixing.—Except when yarns of specially light or dark colours are required, various sorts and colours of tow are usually mixed together to obtain a lot of the desired average shade and value. It is a very convenient arrangement to have the tow store situated under the hackling department, so that the tows produced may be thrown down various traps according to their quality, the roughing tow in one place, the machine tow in another, and the sorter's tow in a third.

There should be plenty of floor space in the tow store to sort the material, as well as numerous roomy bins in which to make and store the mixes. The best method of mixing is to lay the various sorts of material in layers one on top of the other, over an area proportionate to the size of the "mix" or blend. When a quantity of material is being taken from the mix to the card it should be pulled "out of the face," so that the quantities of the various sorts in that part may be in the same ratio as they are in the bulk. When all the material has first to be passed over the breaker card, the various sorts may be carded separately and then mixed together in the correct proportions by putting up the required number of cans of each at the back of the finisher card or at the back of the balling or lap-forming machine, if one be employed.

When only one card is used and there is a marked difference in any tow from the others with which it is to be spun, it is often best to card it separately in a manner suiting its requirements and then to mix it in at the back of the doubling frame, which we will treat of in our next chapter. For instance, if we are mixing a clean but soft Kama tow with Baltic machine tow, containing more or less shove, it will be found that less waste will be made if the Kama is worked upon a separate card, arranged in such a way that the workers are run rather fast and the strippers slow, in order to save the fibre, which requires very little cleaning, but merely to be straightened and put into sliver. The remainder of the material must receive more work, to accomplish which the workers must be run slow and the strippers rather fast. The following examples of tow mixes will give some idea as to what is required for coarse and fine numbers.

A 40's rope yarn may be composed of $\frac{1}{2}$ aloe fibre, $\frac{1}{4}$ jute and $\frac{1}{4}$ YC hemp tow.

A 1 lea yarn for twine may be made from pure Italian Strappatura tow.

8's lea dry spun weft may be produced from Irish rescutched tow.

14's lea wet spun warp may be composed of $\frac{1}{4}$ rescutched tow, $\frac{1}{4}$ Irish hand-scutched roughing tow, $\frac{1}{2}$ Irish 1 and 2 machine tow.

16's lea dew-retted tow : $\frac{1}{4}$ Kama II, $\frac{1}{2}$ Bejetsky roughing tow, $\frac{1}{4}$ 1 and 2 Bejetsky machine tow.

20's wet spun tow warp : $\frac{1}{4}$ Irish, $\frac{1}{4}$ Flemish, $\frac{1}{4}$ Dutch, $\frac{1}{4}$ Pernau No. 2 machine tows.

40's lea tow weft ; $\frac{1}{4}$ Irish, $\frac{1}{4}$ Flemish ; $\frac{1}{4}$ Dutch, No. 3 machine tow with $\frac{1}{4}$ No. 4 Pernau machine tow.

40's lea tow warp : $\frac{1}{3}$ Brittany No. 3 machine tow, $\frac{1}{3}$ Irish sorting tow, $\frac{1}{3}$ Brittany sorting tow.

50's lea tow weft : $\frac{1}{3}$ Flemish sorting tow, $\frac{1}{3}$ Irish sorting tow, $\frac{1}{3}$ Dutch No. 4 machine tow.

55's lea tow warp : all Courtrai long line sorting tow.

60's lea tow weft : $\frac{1}{3}$ Irish, $\frac{1}{3}$ Flemish, $\frac{1}{3}$ Dutch sorting tow.

65's lea tow warp : all Courtrai cut line sorting tow.

70's lea tow weft : all No. 4 Courtrai cut line machine tow.

Important experiments are now going on both at home and on the Continent in the use of the Hopper Feeder, of the constant feeding type, to the formation of a lap for card feeding. We believe that a good tack is being followed, and that presently we may see the suppression of the present method of card feeding as described at the beginning of the chapter.

CHAPTER IX.

PREPARING, DRAWING AND DOUBLING, AND TOW COMBING.

Drawing and Doubling.—We are now in possession of a number of continuous ribbons or slivers which have been prepared, in the case of long line, upon the spreader, and in the case of tow, upon the card, and composed of fibres lying parallel to and overlapping one another.

It now remains to elongate them so as to reduce them to the size of the yarn required. This is done upon a series of drawing frames which also afford an opportunity of doubling a number of slivers together in order to produce another, more regular in weight per unit of length. It is not astonishing that doubling has this effect, as it would be unreasonable to suppose that the thick places in one sliver should correspond with thick places in the others. It is more than likely that they should frequently coincide with corresponding *thin* places and combine to make a more regular sliver.

Preparing.—Preparing machinery is combined and worked in “Systems.” In the case of line, each system comprises one or two spread-boards, three or four drawing frames, and one roving frame.

In the case of tow-preparing machinery, a system comprises one or two cards, two, three or four drawing frames and a roving frame. The insertion and use of the combing machine in the tow system is optional.

With four to eight leathers on the spread-board, and a draft of 16 to 30, four to eight rows of gills per delivery on the drawing frames, with drafts of 10 to 16 and a draft of from 10 to 16 on the roving frame, the combined doubling obtained may range from 1500 to 80,000, and the combined drafts from 65,000 to 6,900,000.

For tow with two to six rows of gills per delivery on the drawing frames, and drafts of from six to nine on the drawing and roving frames, the total doubling may range from 24 to 144, and the total drafts from 377 to 4840.

The Spiral Drawing Frame.—Figs. 36, 37, 42 and 43 give general views of several types of drawing frames. Figs. 38, 39, 40, 41, 44 and 45, show similar frames more in detail. Fig. 36 is a back view of a spiral drawing

frame for flax, etc., as made by a German firm. Fig. 37 is a front view of a similar frame of English make suitable for flax or hemp tow.

Fig. 38 is a sectional view of a spiral drawing frame for long hemp.

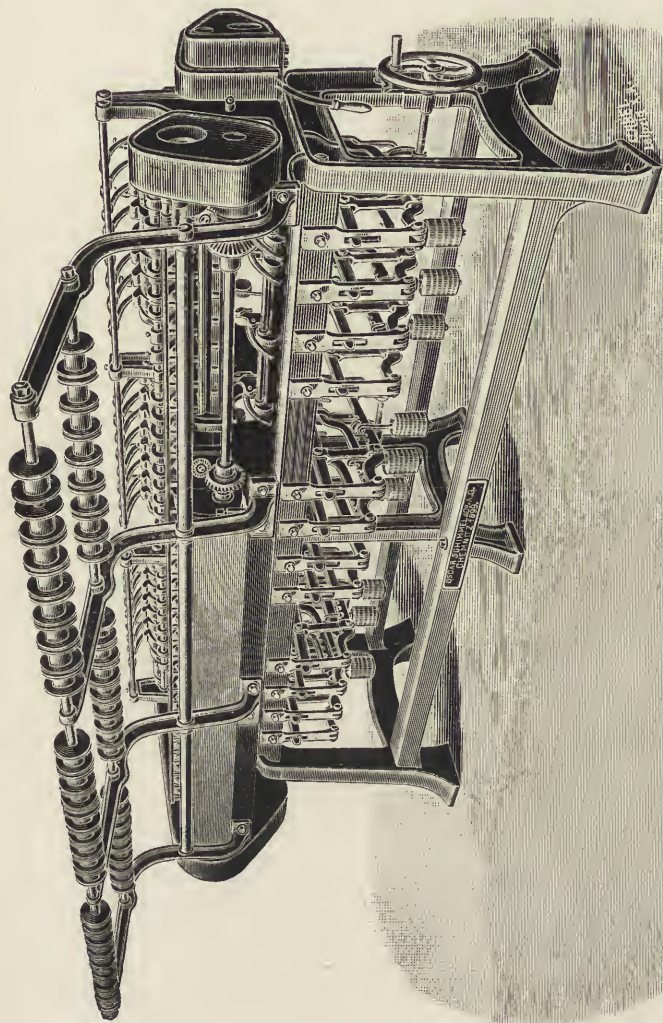

FIG. 36.—Spiral drawing frame (back view).

Fig. 39 shows the arrangement of the back shafts, rollers, screws and gearing for a spiral drawing frame, such as fig. 37.

Fig. 40 shows a traverse motion for the front roller, such as is supplied to modern spiral drawing and roving frames.

Fig. 41 shows a sliver or doubling plate for a drawing frame with

three deliveries per head, and four rows per delivery. Messrs Mackie's patent conductors are clearly to be seen upon the under side.



FIG. 37.—Spiral drawing frame for flax or hemp tow (front view).

Fig. 42 gives a general view of a chain-bar drawing frame with apron head as used for Manila to follow the combined hackler and spreader, figs. 27 and 29.

Figs. 43 and 44 show chain-bar drawing frames for jute, and fig. 45 a section through the bars of Fraser's ring drawing frame, also for jute.

Each drawing frame is made up of from one head, as in fig. 42, to

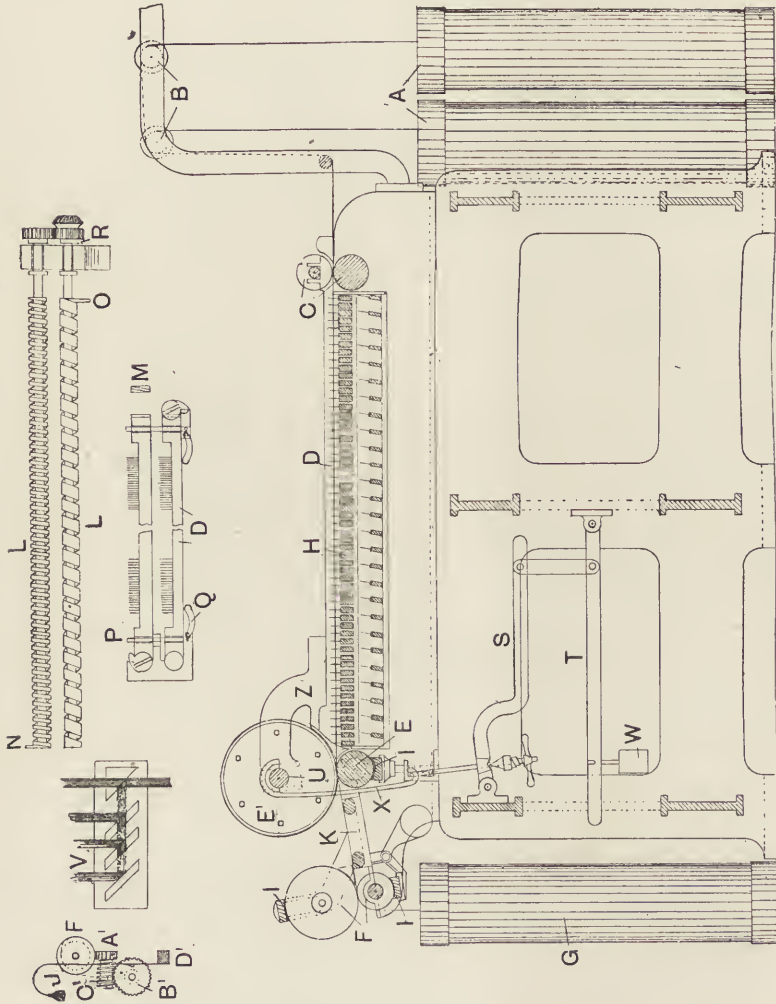

FIG. 38.—Spiral drawing frame for long hemp.

three or more heads, as in figs. 36 and 37. Each head has a separate set of faller or gill bars. Upon each faller or bar are from one row, as in fig. 42, to eight or more rows, as in fig. 36, of gills, constructed as described for the spread-board in Chapter VII. In fig. 36 a back cover is removed disclosing the back shaft E with its bevels W working into the screw bevels M, as seen more clearly in fig. 39. Fig. 36 also shows clearly the

sliver guide pulleys over which the slivers pass from the eans to the back or feed roller D, fig. 39.

In fig. 37 the boss or drawing roller A, delivery bosses F with their pressings G and the fast-and-loose belt pulleys L and K, fig. 39, are clearly to be seen, as is also the sliver doubling plate and wooden pressings for

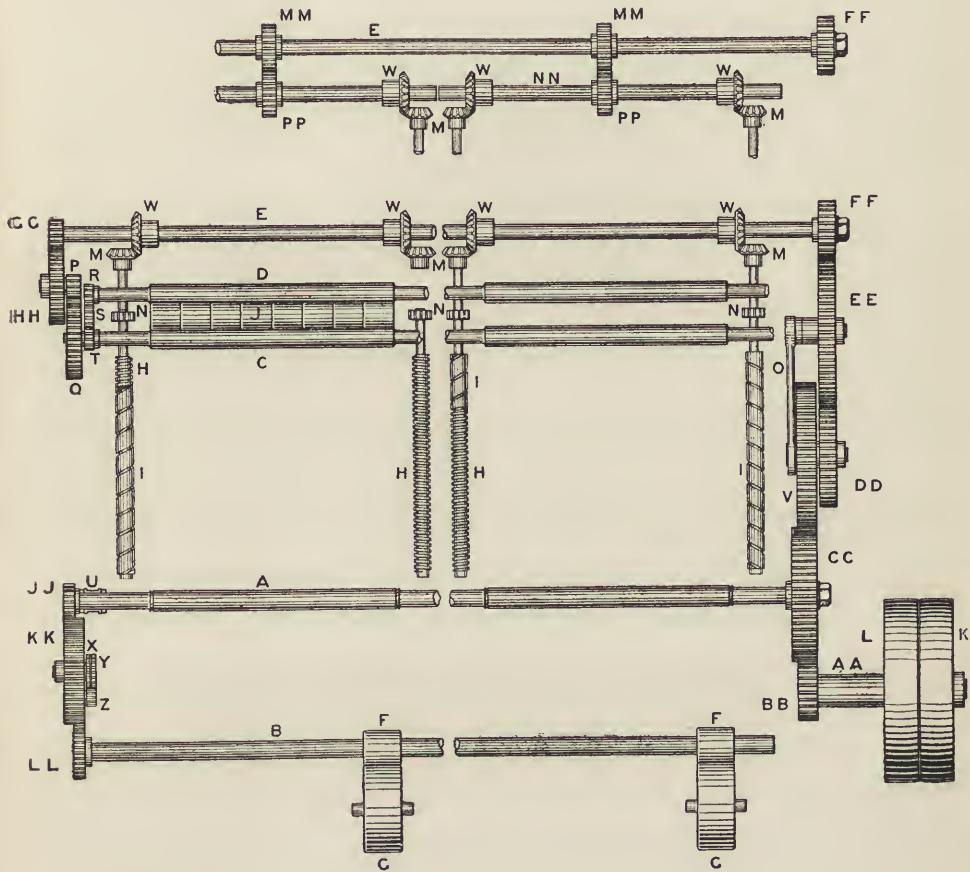

Fig. 39.—Diagram of gearing rollers and shafts for drawing frames, with single or double back shafts.

the drawing roller with dead rubbers lying upon them. There is a bell motion to be seen in connection with the delivery roller and revolving rubbers on the delivery pressings or calender rollers. The throwing-off handles and the levers and weights for applying pressure upon the wooden pressing rollers are to be seen underneath.

In fig. 38, A A are the eans from a spread-board, or from another drawing frame or preparing machine, such as fig. 42, B the sliver guide

pulleys, C the feed rollers, D the gill bars or fallers, E the drawing rollers, F the delivery rollers, and G the can which will be taken to the next drawing frame. The gill bars on the upper slide H have approximately the same surface speed as the feed rollers C. The rollers E have a surface speed 8 to 16 times as great, giving drafts of from 8 to 16 respectively. The delivery rollers F have a slight lead on the drawing rollers in order to keep the sliver tight on the doubling plate K. The faller bars are moved

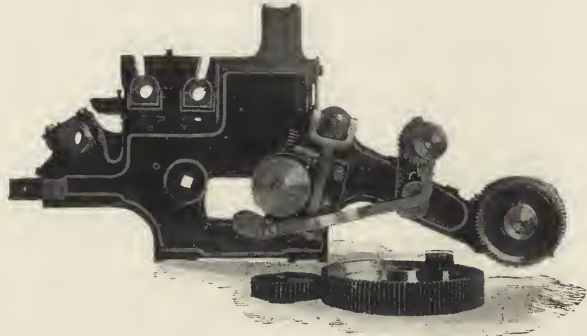

FIG. 40.—Traverse motion for drawing frame front roller.
(As made by Messrs James Mackie & Sons, Ltd., Belfast.)

by the screws shown in detail at L. The ends are cut as shown at M, to fit into the screw threads, while the gills remain vertical when on the top slide. The upper screw, of comparatively fine pitch, moves the fallers forward upon the top slide, until they fall or are knocked down into the threads of the lower screw by the tappet N. The bottom screw is of coarse



FIG. 41.—Patent conductor on under side of sliver plate.
(As supplied by Messrs James Mackie & Sons, Ltd., Belfast.)

pitch, so that fewer fallers are required. It turns at the same speed as the top screw, and the tappet O raises one faller every revolution into the threads of the upper screw and on to the top slide. There are pieces, P, back and front, at the ends of the slides, to guide the fallers in their up-and-down movement. The front guides fit into grooves in the faller ends as shown. In order that heavy fallers may not wear the bottom slide in consequence of their constant dropping, faller lowerers Q are provided, which being moved up and down at the right moment by an eccentric R on the rear end of the bottom screw, catch the faller and lower it gently on to the bottom slide. The lower drawing roller E is of steel and scored

to give it more gripping power. The pressing roller E' may be of wood, but it is much better if made of pieces of leather, on edge, bolted between two steel flanges. The pressure is applied by means of compound levers

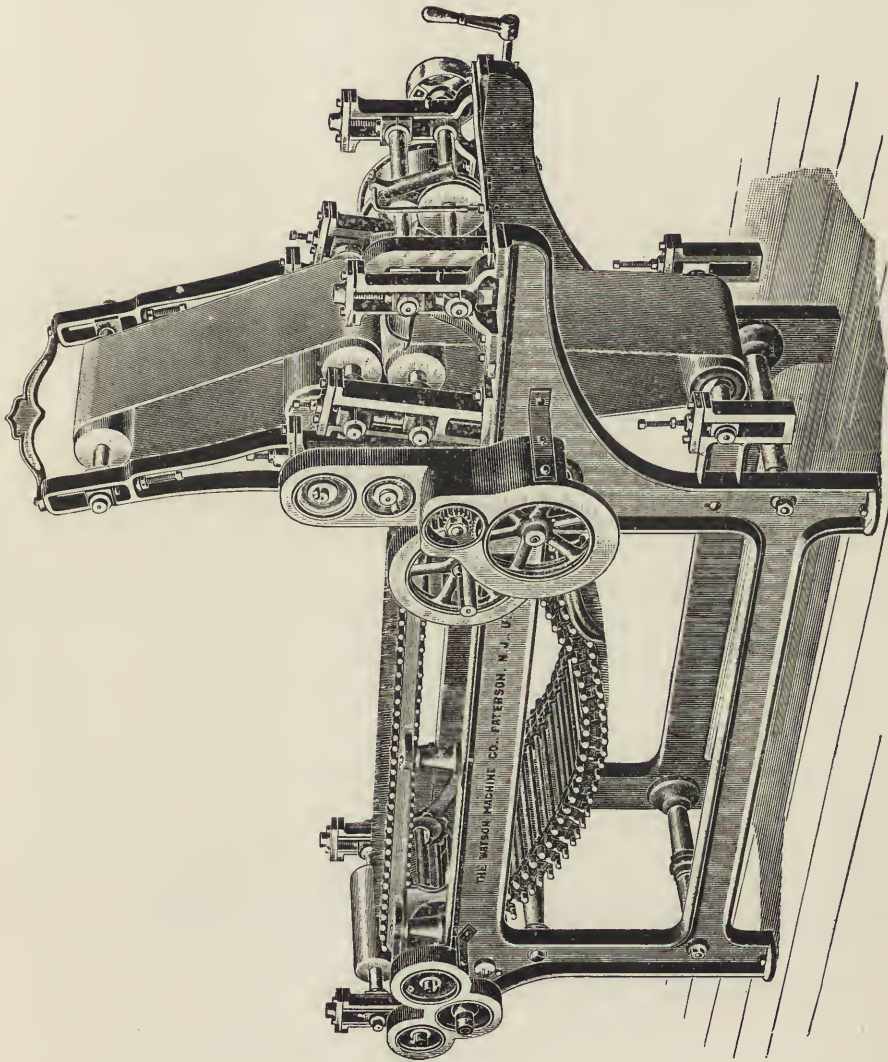

FIG. 42.—Apron head chain-bar drawing frame for Manilla.

S and T, the weight W, and the hanger X. The pull of the levers should be as nearly as possible in a straight line passing through the centre of the two rollers. The centre line of the groove in the bracket Z should also correspond, so that as little power as possible may be lost in friction against the groove.

The bell mechanism was explained on page 65 in connection with the spread-board. As a general rule, it is only used upon the first drawing or bell frame when not applied to the spread-board or card as the case may be, although a fine system, for instance, may advantageously have bells applied to all the drawing frames in order to insure equal lengths in the cans and render possible the passing together and the pulling to waste of all the unavoidable piecings and the production of a more perfectly level yarn.

In fig. 39, A is the front roller, B the delivery shaft, C the front back roller, D the back back roller, E the back shaft, F the delivery boss, G the delivery pressing roller, H the right and left-hand top screws, I the right

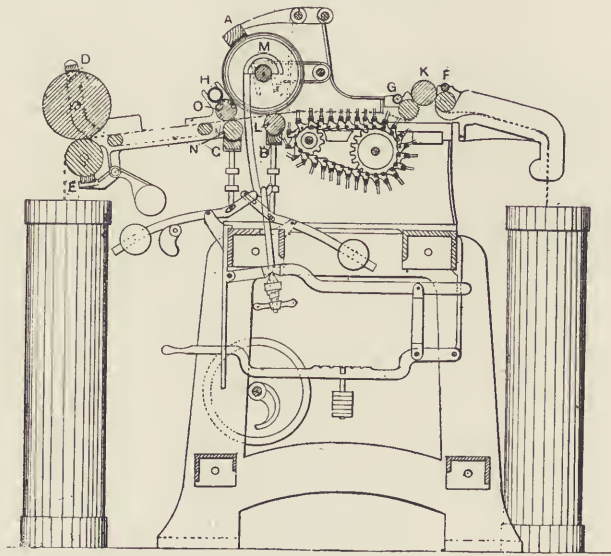

FIG. 43.—Chain-bar drawing frame for jute.

and left-hand bottom screws, J the "jockey" rollers, K the slack pulley, and L the fast driving pulley. U is the traverse motion bush, seen also in fig. 40. X is a dead wheel, Y the eccentric wheel, and Z a pinion, all for the traverse motion of the drawing roller. AA is the driving pulley socket, NN are double back shafts for each head, and MM and PP are the back shaft wheels.

The advantage of double back shafts for each head is, that when a faller jams and a safety pin breaks, only that head upon which the accident occurs is stopped, instead of having the whole frame stopped, as is the inevitable result when a single back shaft is used.

Proceeding to the gearing:—The general speed of the frame is altered by changing the pinion BB, which is called the speed change pinion and drives the front roller wheel CC.

The delivery roller is commanded by the front roller delivery pinion J J driving the delivery roller wheel L L through the delivery intermediate K K.

The draft gearing is as follows :—The front roller wheel C C drives the draft gearing stud wheel V, upon the pap of which is keyed the draft gearing stud pinion D D. This latter pinion drives the draft change pinion F F, and the back shaft E, through the draft gearing intermediate

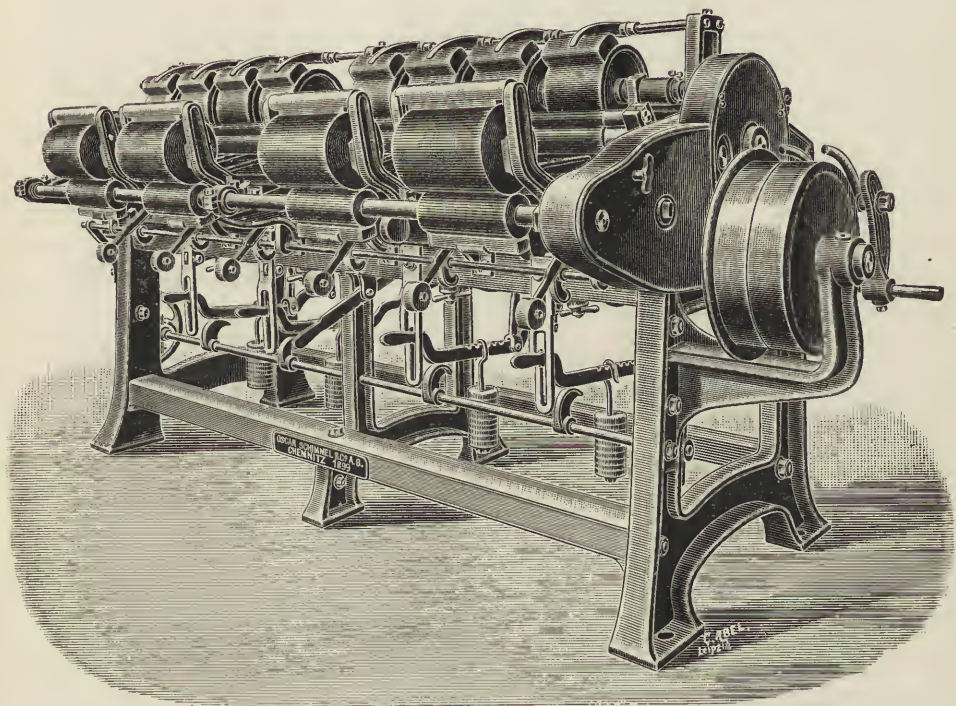

FIG. 44.—Chain-bar drawing frame for jute.

E E. Upon the other end of the back shaft, the back shaft pinion G G is keyed and drives the back roller stud wheel H H. Upon the same socket is the back roller gear stud pinion P, which in turn drives the front back roller through the back roller wheel Q. The back back roller is driven from the front back roller by the pinion T driving the pinion R through the intermediate S. W are the back shaft bevels driving the bevels M keyed upon the bottom screws. The top screws are driven from the bottom screws by means of similar spur pinions N.

The calculations for the lead of fallers and the draft of the drawing frame are similar to those given in Chapter VII.

Preparing machinery is usually fitted with some method of securing

the gills and fallers against damage when a faller sticks or a "crush" occurs. This usually takes the form of a safety pin through which motion is imparted to the back shaft which drives the screws and fallers. A pinion upon the back shaft, which is the draft change pinion FF, when a single back shaft is used, and either of the back shaft wheels MM or PP, when the double back shaft is employed, is loose upon a socket upon the shaft itself and faces close up to a face plate on the socket. About $1\frac{1}{2}$ or 2 inches from the centre of the face plate and pinion, a small hole is bored to receive a short piece of brass wire, which, when inserted and the wheel and face plate kept in close contact by means of a nut or loose collar on the shaft, affords a medium for driving the back shaft and screws. When the back shaft becomes too stiff to turn through a "squeeze," etc., the brass pin is sheared through, and the frame or head put out of gear. A spring clutch wheel is sometimes employed instead of the safety pins, with a like result.

Boss Roller Traverse Motion.—A traverse motion, such as is shown in fig. 40, should be applied to all drawing and roving frames. Its object is to give the drawing rollers a very slow reciprocating longitudinal motion in order to equalise the wear, and prevent cutting of the journal or bearing or wetting of that part of the wood roller immediately in contact with the sliver, and thus considerably increase the life of the wood roller.

The patent adjustable conductor on the under side of the sliver plate, as shown in fig. 41, tends to equalise the tension on the slivers and ensure perfect selvages, and thus render the drafting through the gills of the following frame more perfect.

The "Apron Head."—Fig. 42, which represents a type of machine much used in America to follow and reduce the sliver from the combined hackler and spreader, fig. 29, affords an example of the apron head, which is also used for jute.

It will be seen that in the apron head the drawing rollers are surrounded by endless aprons of leather kept tight by adjustable tension rollers. The leather affords a good gripping surface, while the long circumference of the leather aprons enables them to be used for a considerable time without renewal.

Setting the Fallers and Screws.—In screw gill drawing and roving frames consisting of more than one head, the screws should be so set in relation to each other that in no head do the fallers rise or fall at the same moment, thus equalising the load on the back shaft. In practice the ordinary screws and fallers cannot be run at a speed of more than 200 per minute, owing to the fallers jamming and sticking front or back, through wear of the slides, etc. Attempts have been made with some success to raise the speed of the fallers by using double-threaded screws, which raise or let



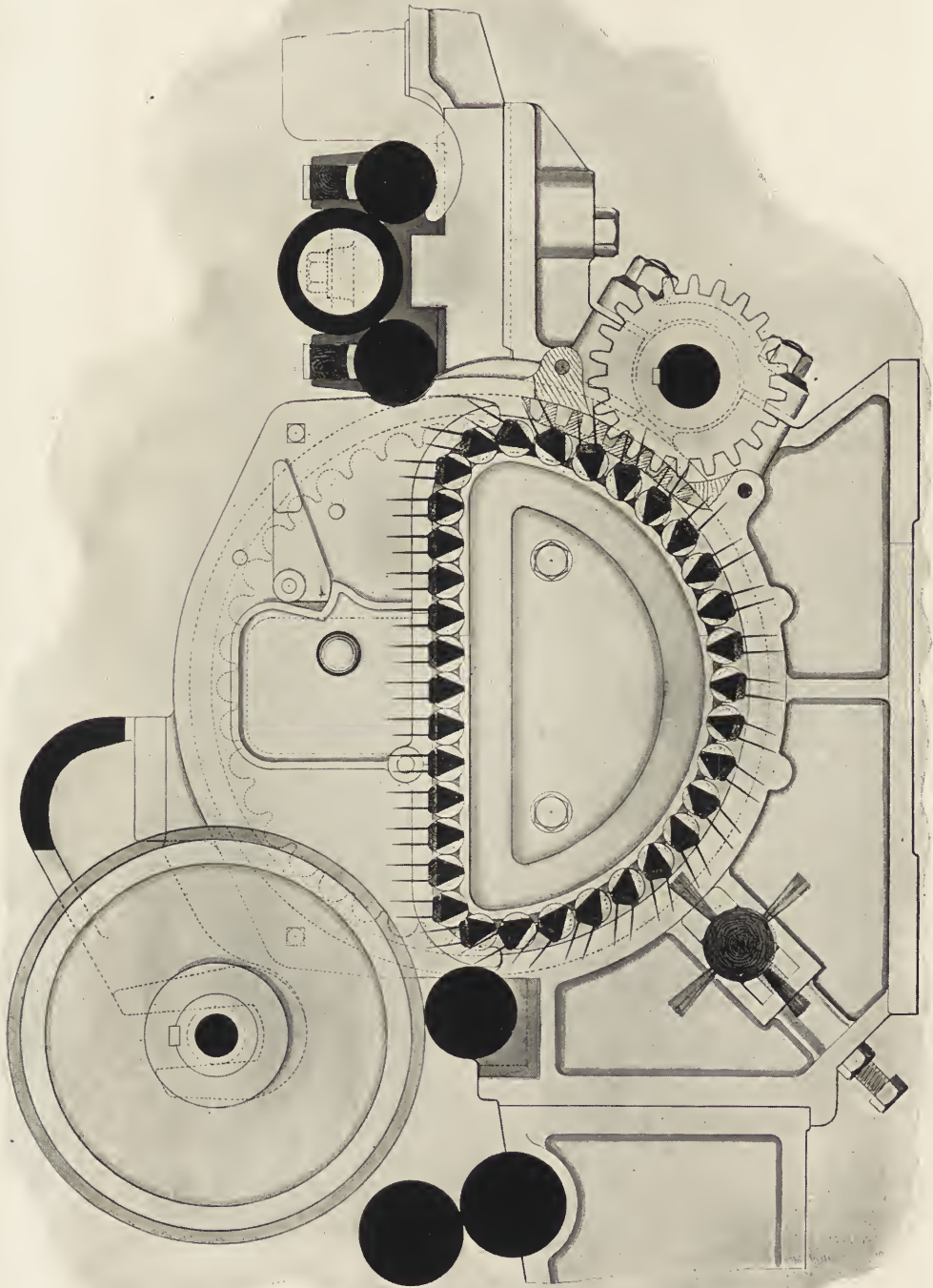

Fig. 45.—Section through bars of Fraser's patent "ring" drawing frame for jute.

fall two fallers each revolution; this can be successfully accomplished when combined with guards pivoted back and front, and locked together by a rod underneath, the tappets being set so that the rise and fall is alternate, and the guards adjusted so that, when the front is open, the back is closed, and *vice versa*. However, when, as in jute machinery, it is desired to run quickly and obtain a high turn-off on short drafts, the chain gill or push-bar drawing head is to be preferred to the screw gill as being simpler and less liable to accidents, although it is not so perfect as regards short nips and direct penetration and withdrawal of the pins from the sliver.

Chain Gill-bar Drawing Frame.—Fig. 42 shows the form of chain bars used in Manila machinery, in which the bars are guided and kept rigidly in position by means of blocks, on their ends, the arms of which engage with either side of the top slide.

The "Ring" Push-bar Drawing Frame.—Figs. 43 and 44 illustrate a form of chain gill-bar drawing frame much used for jute, while fig. 45 gives a sectional view of the new "ring" push-bar drawing frame for the same fibre as manufactured by Messrs Douglas Fraser & Sons of Arbroath.

Gamble's Push-bar Drawing Head.—Gamble's push-bar arrangement, as shown in fig. 35 and made by Messrs Combe, Barbour & Combe, Ltd., Belfast, is also much used for jute drawing. Instead of being carried, in the circular part of their course, in the teeth of spur carriers as in Gamble's patent, the bar in the "ring" drawing frame rests in the teeth of the annular wheel or ring shown. When they have risen to near the centre line of the ring at the retaining rollers, they are deflected by means of an upper race into a horizontal path. On reaching the drawing roller they slide smoothly over the comparatively sharp corner of the race, and are caught again into gear by the teeth of the rings. A slotted cam controls the canting of the bars by means of their cranked ends, and is so designed as to cause the pins to enter and leave the sliver in a vertical position, the result being good pinning and a short "nip" at the drawing roller. The driving shaft is outside the path of the gill bars, and is geared by pinions into shrouded teeth in the outer circumference of the rings, as shown. The bars are of triangular section at the gills, and can be readily lifted out after lifting a latch and opening a hinged door in the cover.

Retaining and Jockey Roller.—In figs. 39, 43 and 45 the form of double feed or retaining roller D C and G F, with intermediate jockey rollers J and K, generally used for flax, hemp, jute and tow drawing and roving frame, can be seen. The sliver is passed from the can through a conductor under the roller F or D, round the jockey roller K or J, and down and under the front feed roller G or C, where it is pinned by the gills. At A G in fig. 26 is shown the application of a dead rubber to the under side of the jockey

roller. Some spinners do not care for this rubber, as the tension of the spring which holds the rubber diminishes the effective pressure or weight of the jockey roller. Another arrangement in which some spinners believe is the application of a hollow shell, under the back feed roller F or D, which collects dust and shove and keeps the sliver out of contact with the roller. The position of an extra pair of drawing rollers generally used for jute drawings is shown at N O, fig. 43, and also in fig. 45.

Preparing Systems.—The following are particulars of preparing systems in everyday use. Firstly, for preparing Manila or New Zealand hemp for automatic gill spinning into binder twine, or reaper yarn, or rope yarn, or white Manila for trawl twine.

	Spreader and Hackler.	1st 2nd Finishers.		Bell Frame.	Sett Frame.	3rd Drawing.
		Chain Gills.				
Rows of gills for delivery,	1	1	1	4	6	6
Deliveries per frame,	1	1	1	4	6	6
Width of gill,	23 in.	22½ in.	19½ in.	7½ in.	4¾ in.	4 in.
Pitch of gill bars or screws,	4½ in.	3¾ in.	3¾ in.	1½ in.	1¼ in.	1 in.
Pins in the row of gill,	28	36	39	13	14	15
Length of the pin out of the bar,	5 in.	4 in.	3½ in.	2¾ in.	2½ in.	2¼ in.
Suitable drafts,	10-20	10-20	10-20	10	10	10
Speed of the quick sheet in feet per minute,	175	175	175
Rate of delivery in feet per minute,	200	200	200
Speed of the slow sheet in feet per minute,	16-32	16-32	16-32

Next, for preparing jute long line to be spun into yarn from 1200 to 1800 yards per lb.

Particulars.	Spreader.	Drawing.			Roving.
		1st.	2nd.	3rd.	
Heads per frame,	1	2	3	3	6
Rows of gills per head,	4	4	6	6	8
Length of reach,	40 in.	36 in.	32 in.	28 in.	24 in.
Breadth of gill,	7 "	5 "	4 "	3 "	2 "
Breadth of conductor,	6 "	4 "	3 "	2 "	¾ "
Length of pin in gill,	2½ "	2 "	1¾ "	1½ "	1¼ "
Pins per inch (two rows),	3	4	5	6	7
Pitch of screw,	1 in.	¾ in.	¾ in.	¾ in.	½ in.
Deliveries per head,	1	1	1	2	8

PREPARING—DRAWING AND DOUBLING—TOW COMBING. 107

For spinning flax, hemp, and jute long line into yarn from 1500 to 2700 yards per lb.

Particulars.	Spreader.	Drawings.			Roving.
		1st.	2nd.	3rd.	
Heads per frame,	1	2	3	3	6
Rows of gills per head,	4	4	6	8	10
Length of reach,	40 in.	36 in.	32 in.	28 in.	24 in.
Breadth of gill,	6½ ,,	4½ ,,	3½ ,,	2¾ ,,	2 ,,
Breadth of conductor,	5½ ,,	3½ ,,	2½ ,,	1¾ ,,	¾ ,,
Length of pins in the gill,	2½ ,,	2 ,,	1¾ ,,	1½ ,,	1¼ ,,
Pins per inch (two rows),	4	5	6	7	8
Pitch of screw,	⅞ in.	¾ in.	⅝ in.	½ in.	½ in.
Deliveries per head,	1	1	1	2	10

For spinning flax, hemp, and jute long line into yarn from 2400 to 3600 yards per lb.

Particulars.	Spreader.	Drawings.			Roving.
		1st.	2nd.	3rd.	
Heads per frame,	1	2	3	3	6
Rows of gills per head,	4	4	6	8	10
Length of reach,	38 in.	35 in.	32 in.	28 in.	24 in.
Breadth of gill,	5 ,,	4 ,,	3 ,,	2½ ,,	2 ,,
Breadth of conductor,	4 ,,	3 ,,	2 ,,	1¾ ,,	¾ ,,
Length of pin in gill,	2½ ,,	2 ,,	1¾ ,,	1½ ,,	1¼ ,,
Pins per inch (two rows),	4	5	6	7	8
Pitch of screw,	⅞ in.	¾ in.	⅝ in.	½ in.	½ in.
Deliveries per head,	1	1	1	2	10

For spinning flax and hemp tows into yarn from 3400 to 4800 yards per lb., forming the sliver upon a 5 × 6 feet card 16 pins per square inch on the cylinder, with 6½ pairs of rollers.

Particulars.	Drawings.				Roving Frame.
	Bell Frame.	Sett Frame.	3rd.	4th.	
Heads per frame,	2	2	3	4	7
Rows of gills per head,	6	6	6	8	10
Deliveries per head,	1	1	1	2	10
Doublings,	6	6	6	4	1
Length of reach,	12 in.	11 in.	10 in.	9 in.	8 in.
Pitch of screw,	⅝ ,,	⅞ ,,	½ ,,	⅞ ,,	⅝ ,,
Breadth of conductor,	2¼ ,,	2⅛ ,,	1⅞ ,,	1¾ ,,	1½ ,,
Breadth of gill,	3 ,,	3 ,,	2¾ ,,	2½ ,,	2 ,,
Length of pin out of the stock,	¾ ,,	¾ ,,	¾ ,,	¾ ,,	¾ ,,
Pins per inch (two rows),	8	10	12	14	16

For spinning flax, hemp, and jute long line yarn from 3000 to 4800 yards per lb.

Particulars.	Spreader.	Drawings.			Roving.
		1st.	2nd.	3rd.	
Heads per frame,	1	2	2	3	7
Rows of gills per head,	4	4	6	8	10
Length of reach,	38 in.	35 in.	32 in.	28 in.	24 in.
Breadth of gill,	4½ "	3½ "	2½ "	2½ "	1¾ "
Breadth of conductor,	3½ "	2½ "	2 "	1½ "	1½ "
Length of pins in gill,	2½ "	1¾ "	1½ "	1¼ "	1¼ "
Pins per inch (two rows),	6	7	8	9	10
Pitch of screw,	¾ in.	11⁄8 in.	5⁄8 in.	9⁄16 in.	½ in.
Deliveries per head,	1	1	1	2	10

For spinning flax and hemp long line into yarn from 4200 to 5400 yards per lb.

Particulars.	Spreader.	Drawings.			Roving Frame.
		1st.	2nd.	3rd.	
Heads per frame,	1	2	2	3	7
Rows of gills per head,	4	4	6	8	10
Length of reach in inches,	38	35	32	28	24
Breadth of gill in inches,	4¼	3¼	2¼	2	1¾
Breadth of conductor in inches,	3¼	2¼	1¾	1½	1½
Length of pin in gill in inches,	2	1½	1¼	1¼	1¼
Pins per inch (two rows),	7	8	9	10	12
Pitch of screw,	¾ in.	1¼ in.	5⁄8 in.	9⁄16 in.	½
Deliveries per head,	1	1	1	2	10

For spinning flax and hemp long line into yarn from 5400 to 6600 yards per lb.

Particulars.	Spreader.	Drawings.			Roving Frame.
		1st.	2nd.	3rd.	
Heads per frame,	1	2	2	3	7
Rows of gills per head,	4	6	6	8	10
Length of reach in inches,	38	35	32	28	24
Breadth of gill in inches,	4	3	2¼	2	1¾
Breadth of conductor in inches,	3	2¼	1¾	1½	1½
Length of pins in gill in inches,	2	1½	1¼	1¼	1¼
Pins per inch (two rows),	8	9	10	12	14
Pitch of screw,	¾ in.	11⁄8 in.	5⁄8 in.	9⁄16 in.	½ in.
Deliveries per inch,	1	1	1	2	10

For spinning flax long line into yarn from 6000 to 9000 yards per lb.

Particulars.	Spreader.	Drawings.			Roving Frame.
		1st.	2nd.	3rd.	
Heads per frame,	1	2	2	3	7
Rows of gills per head,	6	6	6	8	10
Deliveries per head,	1	1	1	2	10
Length of reach in inches,	36	30	28	26	24
Breadth of gill in inches,	4	3	2 $\frac{1}{2}$	2	1 $\frac{1}{2}$
Breadth of conductor in inches,	3	2 $\frac{1}{2}$	1 $\frac{3}{4}$	1 $\frac{1}{4}$	1 $\frac{1}{2}$
Length of pin in inches,	1 $\frac{3}{4}$	1 $\frac{3}{8}$	1 $\frac{1}{4}$	1 $\frac{1}{8}$	1
Pins per inch,	9	10	11	13	15
Pitch of screw,	$\frac{1}{16}$ in.	$\frac{5}{8}$ in.	$\frac{1}{2}$ in.	$\frac{7}{16}$ in.	$\frac{3}{8}$ in.

A system for spinning flax tow into yarn from 4800 to 7500 yards per lb., forming the sliver upon a 5 x 6 feet card 4 $\frac{1}{2}$ pins per inch.

Particulars.	Drawings.				Roving Frame.
	Bell Frame.	Sett Frame.	3rd.	4th.	
Heads per frame,	2	2	3	4	7
Rows of gills per head,	6	6	6	8	10
Deliveries per head,	1	1	1	2	10
Length of reach in inches,	14	13	12	11	10
Pitch of screw,	$\frac{1}{2}$ in.	$\frac{1}{2}$ in.	$\frac{7}{16}$ in.	$\frac{7}{16}$ in.	$\frac{3}{8}$ in.
Breadth of conductor in inches,	2 $\frac{1}{2}$	2 $\frac{1}{4}$	2	1 $\frac{3}{4}$	1 $\frac{1}{2}$
Breadth of gill in inches,	3	2 $\frac{3}{4}$	2 $\frac{1}{2}$	2 $\frac{1}{4}$	1 $\frac{1}{2}$
Length of pin in inches,	1	1	$\frac{7}{8}$	$\frac{7}{8}$	$\frac{3}{4}$
Pins per inch in gill,	10	12	14	16	18

A system for spinning flax long line into yarn from 9000 to 15,000 yards per lb.

Particulars.	Spreader.	Drawings.				Roving.
		1st.	2nd.	3rd.	4th.	
Heads per frame,	1	2	3	4	5	7
Rows of gills per head,	6	6	8	8	12	10
Deliveries per head,	1	1	1	1	2	10
Length of reach in inches,	30	26	22	18	15	14
Pitch of screw,	$\frac{1}{2}$ in.	$\frac{1}{2}$ in.	$\frac{1}{2}$ in.	$\frac{3}{8}$ in.	$\frac{3}{8}$ in.	$\frac{3}{8}$ in.
Breadth of conductor in inches,	2 $\frac{1}{2}$	2	1 $\frac{1}{2}$	1	$\frac{3}{4}$	1 $\frac{1}{2}$
Breadth of gill in inches,	3 $\frac{1}{4}$	2 $\frac{3}{4}$	2 $\frac{1}{4}$	1 $\frac{3}{4}$	1 $\frac{1}{2}$	1 $\frac{1}{4}$
Length of pin in inches,	1 $\frac{7}{8}$	1 $\frac{3}{4}$	1 $\frac{1}{2}$	1 $\frac{1}{4}$	1	$\frac{3}{4}$
Pins per inch in gill,	10	12	15	18	21	24

A system for spinning flax long line into yarn from 15,000 to 24,000 yards per lb.

Particulars.	Spreader.	Drawings.				Roving Frame.
		1st.	2nd.	3rd.	4th.	
Heads per frame,	1	3	3	4	5	7
Rows of gills per head,	6	8	8	8	12	10
Deliveries per head,	1	1	1	1	2	10
Length of reach in inches,	30	26	22	18	14	12
Pitch of screw,	$\frac{1}{2}$ in.	$\frac{1}{2}$ in.	$\frac{7}{16}$ in.	$\frac{3}{8}$ in.	$\frac{3}{8}$ in.	$\frac{3}{8}$ in.
Breadth of conductor in inches,	$2\frac{3}{4}$	2	$1\frac{1}{2}$	1	$1\frac{1}{4}$	$\frac{3}{4}$ in.
Breadth of gill in inches,	$3\frac{1}{4}$	$2\frac{3}{4}$	$2\frac{1}{4}$	$1\frac{3}{4}$	$1\frac{1}{4}$	$1\frac{1}{4}$
Length of pin in gill in inches,	$1\frac{7}{8}$	$1\frac{5}{8}$	$1\frac{3}{8}$	$1\frac{1}{8}$	$\frac{7}{8}$	$\frac{5}{8}$
Pins per inch in gill,	10	14	18	22	26	30

A system for spinning flax tow into yarn from 7500 to 12,000 yards per lb., forming the sliver upon a 5 x 6 feet card, 25 pins per square inch on the cylinder.

Particulars.	Drawings.				Roving Frame.
	Bell Frame.	Sett Frame.	3rd.	4th.	
Heads per frame,	2	2	2	3	7
Rows of gills per head,	6	6	8	8	10
Deliveries per head,	1	2	2	4	10
Length of reach in inches,	12	11	10	9	8
Pitch of screw,	$\frac{1}{2}$ in.	$\frac{1}{2}$ in.	$\frac{7}{16}$ in.	$\frac{7}{16}$ in.	$\frac{3}{8}$ in.
Breadth of conductor in inches,	$2\frac{1}{4}$	2	$1\frac{3}{4}$	$1\frac{1}{4}$	$\frac{1}{2}$
Breadth of gill in inches,	$2\frac{3}{4}$	$2\frac{1}{4}$	$2\frac{1}{4}$	2	$1\frac{1}{4}$
Length of pin in inches,	1	1	$\frac{7}{8}$	$\frac{7}{8}$	$\frac{3}{4}$
Pins per inch in row of gill,	12	15	18	21	24

A system for spinning flax tow into yarn from 12,000 to 24,000 yards per lb., forming the sliver on a 5 x 6 feet card, 36 pins per square inch on the cylinder, and combing it for the finer numbers.

Particulars.	Drawings.				Roving Frame.
	Bell Frame.	Sett Frame.	3rd.	4th.	
Heads per frame,	2	2	3	3	7
Rows of gills per head,	6	6	8	8	10
Deliveries per head,	1	1	2	2	10
Length of reach in inches,	11	$10\frac{1}{2}$	10	$9\frac{1}{2}$	9
Breadth of gill in inches,	$2\frac{1}{2}$	2	$1\frac{1}{2}$	$1\frac{1}{4}$	1
Breadth of conductor in inches,	$1\frac{3}{4}$	$1\frac{1}{4}$	$\frac{7}{8}$	$\frac{3}{4}$	$\frac{3}{8}$
Length of pin in gill in inches,	$1\frac{1}{2}$	$1\frac{1}{2}$	1	1	$\frac{3}{4}$
Pins per inch in row of gill,	12	14	16	18	21
Pitch of screw,	$\frac{1}{2}$ in.	$\frac{1}{2}$ in.	$\frac{7}{16}$ in.	$\frac{3}{8}$ in.	$\frac{5}{16}$ in.

PREPARING—DRAWING AND DOUBLING—TOW COMBING. 111

A system for spinning flax long line into yarn from 24,000 to 36,000 yards per lb.

Particulars.	Spreader.	Drawings.				Roving Frame.
		1st.	2nd.	3rd.	4th.	
Heads per frame,	1	2	2	3	3	8
Rows of gills per head,	6	8	8	8	8	10
Deliveries per head,	1	1	2	2	2	10
Length of reach in inches,	28	26	24	22	20	18
Pitch of screw,	$\frac{3}{8}$ in.	$\frac{3}{8}$ in.	$\frac{5}{16}$ in.	$\frac{5}{16}$ in.	$\frac{1}{4}$ in.	$\frac{1}{8}$ in.
Breadth of conductor in inches,	$1\frac{1}{4}$	$1\frac{1}{4}$	$1\frac{7}{8}$	$1\frac{3}{4}$	$1\frac{9}{16}$	$1\frac{3}{8}$
Breadth of gill in inches,	$2\frac{1}{4}$	$2\frac{1}{8}$	$1\frac{1}{2}$	$1\frac{1}{4}$	1	$1\frac{3}{8}$
Length of pin in inches over all,	$1\frac{1}{8}$	1	$1\frac{1}{2}$	$1\frac{3}{4}$	$1\frac{5}{8}$	$1\frac{9}{16}$
Pins per inch in row of gill,	20	24	28	32	35	38

A system for spinning flax line into yarn from 36,000 to 75,000 yards per lb.

Particulars.	Spreader.	Drawings.				Roving Frame.
		1st.	2nd.	3rd.	4th.	
Heads per frame,	1	3	3	3	4	8
Rows of gills per head,	4	8	8	8	8	12
Deliveries per head,	1	1	2	2	2	12
Length of reach in inches,	18	17	16	15	14	13
Pitch of screw,	$\frac{3}{8}$ in.	$\frac{3}{8}$ in.	$\frac{5}{16}$ in.	$\frac{5}{16}$ in.	$\frac{1}{4}$ in.	$\frac{3}{8}$ in.
Breadth of conductor in inches,	$1\frac{7}{8}$	$1\frac{3}{4}$	$1\frac{5}{8}$	$1\frac{3}{8}$	$1\frac{1}{4}$	$1\frac{1}{2}$
Breadth of gill in inches,	$1\frac{1}{2}$	$1\frac{1}{4}$	1	$1\frac{3}{8}$	$1\frac{1}{4}$	$1\frac{1}{2}$
Pins per inch in row of gill,	36	40	45	50	55	60
Length of pin in inches over all,	$1\frac{1}{16}$	$1\frac{5}{16}$	$1\frac{3}{16}$	$1\frac{1}{16}$	$1\frac{9}{16}$	$1\frac{1}{2}$

Doublings.—The number of doublings given upon a drawing frame depends upon the number of rows of gills and deliveries per head and whether one or two slivers are put up per row of gills. The number of rows of gills per head must be proportional to the breadth of the gill and to the pitch of the screw, for a number of broad rows of gills per head means long fallers, which are not so stiff and rigid as shorter ones of the same thickness. If there be but one sliver per row of gills, the number of doublings equals the number of rows per head divided by the number of deliveries per head. If there be two slivers per row of gills, the number of doublings is of course increased twofold.

Short Drafts and Single Slivers.—When making warps and superior yarns, spinners often work with shorter drafts and only one sliver per row of gills, thus giving the material plenty of room in the gill, and insuring good

pinning and freedom from overloading and overriding in the gill. It is also essential to perfect work to have a properly formed sliver delivered into the feed rollers and gill of the succeeding frame in a perfectly flat and straight condition—in fact, just as it leaves the delivery roller of the preceding frame. When there are a number of cans to be put up at the back of a frame, sliver guides are required. These are flanged pulleys of polished cast iron, supported and grouped upon rods, so that there is one pulley directly above each of the cans which stand behind the frame in rows to admit of easy access to the attendant to replace empty cans and piece up ends which are broken or running out. The shape of these guide pulleys is a matter of importance, since if not properly constructed they do not deliver the sliver straight into the gills. They have sometimes been made rounded on the face with the object of keeping the sliver in the centre, in the same way that a driving belt will run in the centre of a round-faced pulley. This effect is not obtained in the case of slivers, however, as their tension is not sufficiently great; in fact, a round-faced sliver pulley tends rather to throw the sliver to one side or the other, which is just what must be avoided. For weak tow slivers it is advisable to give the sliver guide pulleys the same surface speed as the feed rollers, by means of a belt, and thus lift the sliver from the can without strain.

The proper proportioning of the gills to suit the work to be done on the frames is of great importance. If the gills be too narrow they will be overloaded, part of the sliver, in all probability, not being pinned at all, but riding over the top of the pins and being consequently gulped and improperly drawn. The gill should be about one inch wider than the front conductor, and the back conductor be set so that it is about a quarter inch narrower than the gill, or the same width as the front conductor of the previous frame, so that the sliver may be flat and well spread in the gill, which it should nearly fill as regards width. The best results as regards perfect drawing will be obtained when the sliver is rather light in the gill.

Weight of the Slivers on the Doubling Plate.—A good axiom will be found to be that the separate slivers upon the sliver plate should weigh 32 yards per ounce per inch in breadth. If the following method of proportioning the gills be carried out, the results will be found to correspond with the best modern practice. First determine the heaviest rove combined with the longest drafts it is proposed to work over the system. The yards per ounce of the rove, divided by the draft of the roving frame, will give the yards per ounce of sliver in the roving frame gill. This result, multiplied by the rows of gills per delivery on the 4th drawing and divided by the draft of the 4th drawing, gives the yards per ounce of sliver in each gill of the 4th drawing. If, as is usual, there are two slivers per row of gills on the 1st, 2nd, 3rd, and 4th drawings, the yards per ounce of sliver in the 3rd drawing gill will be twice the yards per ounce in the 4th drawing gill,

multiplied by the rows per delivery on the 3rd drawing, and divided by the draft of the 3rd drawing. Then, again, the yards per ounce of sliver in the 2nd drawing gill will be twice the yards per ounce in the 3rd drawing gill, multiplied by the rows per delivery on the 2nd drawing and divided by the draft of the 2nd drawing. The yards per ounce of sliver in the 1st drawing gill will be twice the yards per ounce on the 2nd drawing gill, multiplied by the rows per delivery on the 1st drawing frame and divided by the draft of the 1st drawing. In a similar manner the yards per ounce of sliver in the gill of the spread-board is twice the yards per ounce of sliver in the 1st drawing gill, multiplied by the rows of gills per delivery on the spreader and divided by the draft of the spreader. If there be but three drawings per system, leave out the 1st drawing in the above and consider the 2nd, 3rd, and 4th as 1st, 2nd, and 3rd. Thus, if in making rove 100 yards per ounce we have the following drafts: Roving frame 12, 4th drawing frame 17, 3rd drawing frame 16, 2nd drawing frame 15, 1st drawing frame 18, and the spread-board 30, with 6 rows per delivery on the 4th drawing, 4 on the 3rd, 4 on the 2nd, 8 on the 1st, and 8 on the spreader, with two slivers per row on the 1st, 2nd, 3rd, and 4th drawings; the yards per ounce of sliver in the gills is: Roving 8·3, 4th drawing 2·9, 3rd drawing 1·45, 2nd drawing ·75, 1st drawing ·6, and spreader ·3.

Capacity, etc., of Gills.—From the following table suitable gills can be selected for each weight of sliver:—

Yards per oz. of sliver in gill,	·3	·4	6	·7
Capacity of gill in inches, .	$4\frac{1}{2} \times 1\frac{1}{4}$	$4 \times 1\frac{1}{4}$	4×1	$3\frac{1}{2} \times 1$
Yards per oz. of sliver in gill,	·8	1	1·2	1·5
Capacity of gill in inches, .	$3\frac{1}{4} \times 1$	3×1	$2\frac{3}{4} \times 1$	$2\frac{1}{2} \times 1$
Yards per oz. of sliver in gill,	1·7	2	2·5	2·7
Capacity of gill in inches, .	$2\frac{1}{4} \times 1$	2×1	$1\frac{3}{4} \times 1$	$1\frac{3}{4} \times \frac{7}{8}$
Yards per oz. of sliver in gill,	4	5	6·5	8
Capacity of gill in inches, . .	$1\frac{1}{2} \times 1$	$1\frac{1}{2} \times \frac{3}{4}$	$1\frac{3}{8} \times \frac{3}{4}$	$1\frac{1}{4} \times \frac{3}{4}$
Yards per oz. of sliver in gill,	10	15	20	over 20
Capacity of gill in inches, .	$1\frac{1}{2} \times \frac{3}{4}$	$1 \times \frac{3}{4}$	$\frac{3}{8} \times \frac{9}{16}$	$\frac{1}{2} \times \frac{1}{2}$

Thus, for the roving frame, a gill $1\frac{1}{4}$ inches broad with a $\frac{3}{4}$ -inch pin; for the 4th drawing frame, a gill $1\frac{3}{4}$ inches broad with a pin $\frac{7}{8}$ inch long; for the 3rd drawing frame, a gill $2\frac{1}{2}$ inches broad with a pin 1 inch long; for the 2nd drawing frame, a gill $3\frac{1}{2}$ inches broad with a 1-inch pin; for the 1st drawing frame, a 4-inch gill with a 1-inch pin; and for the spreader, a $4\frac{1}{2}$ -inch gill with $1\frac{1}{4}$ -inch pin, will be found to give satisfactory results. The length of pin mentioned here is the over all length. The thickness of the gill stock is usually from $\frac{1}{8}$ inch in the finer gills to $\frac{1}{4}$ inch in the coarser, leaving the effective length of the pin short of the over all length by this amount.

The pins per inch in the gill depend upon the fineness of the material to be prepared. Coarse material intended for heavy yarn is only smashed up and broken when worked through too fine a gill, but for fine material of good quality and intended for fine yarns, the more gilling which it receives the better, as the fibres are capable of further subdivision, and the yarn will be level and regular in thickness, in proportion to the number of individual fibres which it contains, and to the number of doublings which the sliver has undergone. The number of wire, or size of pin, to be used in order to obtain a sufficiently strong gill, must be directly as the pins per inch, and inversely as the length of the pin, for a closely set gill of fine pins may be as firm and strong as a coarser gill of stronger wire. A long pinned gill is not so firm as one with shorter pins, hence, if the pins be very long, they should be of heavy wire.

The following table of gills corresponds with modern practice:—

Breadth of gill in inches, . . .	more than 4	4	3 $\frac{1}{4}$	3 $\frac{1}{2}$
Pins per inch,	6 to 9	7 to 10	8 to 13	8 to 14
Number of wire B.W.G., . . .	13 to 16	14 to 17	14 to 18	14 to 19
Breadth of gill in inches, . . .	3 $\frac{1}{4}$	3	2 $\frac{3}{4}$	2 $\frac{1}{2}$
Pins per inch,	9 to 15	9 to 16	10 to 18	12 to 23
Number of wire B.W.G., . . .	15 to 20	15 to 21	15 to 22	16 to 23
Breadth of gill in inches, . . .	2 $\frac{3}{4}$	2	1 $\frac{3}{4}$	1 $\frac{1}{2}$
Pins per inch,	14 to 24	14 to 27	14 to 28	16 to 30
Number of wire B.W.G., . . .	18 to 24	18 to 24	18 to 25	21 to 25
Breadth of gill in inches, . . .	1 $\frac{1}{4}$	1	$\frac{3}{4}$	$\frac{1}{2}$
Pins per inch,	18 to 35	20 to 42	36 to 42	44 to 60
Number of wire B.W.G., . . .	22 to 26	24 to 27	27 to 28	28 to 30

Systems for preparing coarse tow, say 10's to 16's lea, should start with gills say 8 per inch on the rotary of card, and finish with gills say 16 per inch on the roving frame. For medium tows, start with pins 8 per inch in the rotary gill, and finish with 18 per inch in the roving gill. In preparing fine tows, start with 10 per inch in the rotary gill, and finish with 20 or more per inch in the roving gill. In preparing for 40's to 60's line, 12 per inch in the spreader gill and 24 per inch in the roving gill will give good results, as will 15 per inch in the spreader gill and 36 per inch in the roving gill when making 60's to 90's line. Systems for preparing 90's to 150's line would do well to start with gills 20 per inch on the spreader and finish with 40 per inch on the roving frame.

Twenty-five per inch in the spread-board gill and 50 per inch in the roving frame gill will be suitable for 150's to 200's lea line, as will 30 and 60 per inch for 200's to 400's lea line.

The length of reach, or the distance from the centre of the front back roller to the centre of the drawing roller, should be at least equal to the length of the longest fibres to be drawn.

The finer the serew the shorter the nip and the more level the sliver obtained, as, when the faller does not approach close enough to the drawing roller, the material is apt to be gulped, or drawn away quickly, when the bar falls, and thus produce thicks and thins in the sliver. The pitch of serew can scarcely be made less than $\frac{3}{16}$ inch to give a strong enough serew thread and a sufficiently thick faller bar to carry the gill stock. The following table of pitch of serews, proportional to the breadth of gill, will be found to work well in practice.

Breadth of gill in inches,	$4\frac{1}{2}$	4	$3\frac{3}{4}$	$3\frac{1}{2}$	$3\frac{1}{2} \times 3$
Pitch of serew, . . .	$\frac{3}{4}$ in.	$1\frac{1}{8}$ in.	$\frac{5}{8}$ in.	$1\frac{1}{8}$ in.	$\frac{1}{2}$ in.
Rows per head, . . .	6	6	6	6	6
Breadth of gill in inches,	$2\frac{3}{4}$	$2\frac{1}{2}$ to $1\frac{1}{4}$	1	$\frac{7}{8}$	$\frac{1}{2}$
Pitch of serew, . . .	$\frac{7}{16}$ in.	$\frac{3}{8}$ in.	$1\frac{5}{16}$ in.	$\frac{1}{8}$ in.	$1\frac{3}{16}$ in.
Rows per head, . . .	6	8	10	10	12

Tow Combing.—Tow slivers are combed when it is desired to remove the naps and short fibres which remain after carding, and to produce a yarn which resembles and is almost equal to line. It is usually practised upon fine nappy tows, such as that from the top end of fine Courtrai, for instance, or upon long, but rough, tow of good quality, such as Irish scutehing tow, and the Flemish Codillas. Since the percentage of noils produced is considerable, and their value very small compared with that of the combed sliver, combing only pays when the difference in value of noil and tow is comparatively small, that is to say, when tow is cheap. Combs for flax tow are constructed on the Heilmann principle. The best in use to-day is probably Slumberger's, a comb of German construction. The best comb is that which produces noil of minimum quantity and shortest staple. It is similar in principle to the cotton comb, but much stronger, heavier, and better adapted for long and inelastic fibre. Instead of being made into a lap, the slivers, usually to the number of twelve, are drawn from cans which are placed behind the machine—passed over brass conductors to a feeding and retaining arrangement, consisting of intersecting gills, then through and between the cushion plate and nipper, to the comb circle which, together with the top comb, extracts the noil. The combed fibre is drawn off and formed into a sliver by the detaching roller and drawing off segment working in combination. The roller is surrounded by a leather apron which serves to carry the fibre quickly forward, leaving it sufficiently slack to be drawn away, notwithstanding the intermittent motion of the machine, by a condensing and delivery roller revolving constantly. This roller delivers the compressed sliver into a can. The action of the machine, more minutely described, is as follows:—We will suppose that a set of twelve cans of sliver which has been doubled and drawn at least once, has been placed behind the machine and the ends brought over the brass conductors, through the retaining arrangement of intersecting gills, and into the feed rollers. These

rollers deliver the slivers between the nipper knife and cushion plate, which hold it firmly while a number of rows of combs fixed upon one segment of a revolving cylinder comb out the end. When the segment of the cylinder occupied by the combs is past, the nipper knife, which is actuated by levers and a cam, is raised from the cushion plate, the single row top comb comes down and penetrates the protruding fibres, and the detaching rollers are brought down into the path of the fluted segment of the comb cylinder. The fibres which are being slowly and intermittently let down through the feed rollers, will have been subjected to several strokes of the comb cylinder before they project sufficiently far to be caught between the drawing off roller and the fluted segment. When they are caught, their tail ends are drawn through the top comb, which prevents any shorter and not fully-combed fibres being drawn through after them, and they themselves pass up between the rollers, and form the foundation of the sliver. When the fluted segment follows the comb round the next time, there are some fresh fibres ready to be added to those already drawn through, which, for the purpose of being spliced, so to speak, with them, are brought back half the distance they were previously advanced. This is effected by a cam which turns the detaching rollers one-third of a revolution backwards and two-thirds of a revolution forwards. This cycle of operations being repeated, a continuous sliver is formed of long fibres, which have been combed repeatedly through their entire length by the revolving comb segment. The latter is cleared of short fibre by a circular brush which deposits the noil upon a toothed doffer, from which it is removed by a vibrating knife. After combing, drafting and doubling are continued as before.

The "Heavy Spreading" System.—A new method of working has lately been introduced into line preparing. It is termed the heavy spreading system, and, if properly carried out, gives as good, if not a better yarn, and effects a saving in the cost of preparing.

A coarse spread-board with wide conductors and gills, and often more than one delivery, replaces two or more finer ones. The pieces of flax, etc., are spread whole, if possible, thus avoiding the handling and tossing of the fibre which often occurs when the piece is subdivided. The heavy slivers obtained are reduced to the old weight by drafting and doubling upon an additional drawing head. It is the author's opinion that the chief benefit of the system lies in the additional doublings which are obtained without additional cost. The extra gilling obtained has a beneficial effect upon fibre of good quality, and will in some cases permit of the production of good yarn from less hackled flax, which comes in cheap in consequence of the high yield obtained from the machines. Many mills have put in coarse boards for heavy spreading and reduced the number of their spreaders by one-half or more. The old spread-boards have in most cases been turned into drawing heads by removing the spreading table

and substituting sliver guides and pulleys, as in an ordinary drawing frame.

Speeding a System.—The correct speeding of a system is an important point in preparing for spinning. The roving frame should be run as many hours as possible per week, consistent with keeping the working parts perfectly clean and in good order. To show the correct method of speeding a system, take as an example one in which the roving frame fallers are running at a speed of 75 inches per minute. The draft being 16, $75 \times 16 = 1200$ inches are delivered per minute by the boss roller, which, if $1\frac{1}{2}$ inches in diameter or 4.7 inches in circumference, makes $\frac{1200}{4.7} = 255$ revolutions per minute. The necessary speed of the boss rollers of the drawing frames and spreader may be found from the speed of the roving frame boss roller as follows:—

To find the speed at which the boss roller of the 3rd or 4th drawing should run, divide the continued product of the speed of the roving frame boss roller, its diameter and the number of spindles, by the product of the draft of the roving frame, number of deliveries on that drawing frame, and the diameter of its boss roller. Thus, suppose that in addition to the speed of the boss roller of the roving frame being 255 and its diameter $1\frac{1}{2}$ inches, the number of spindles is 60, its draft 16 and the number of deliveries on the 4th drawing 4, with a boss roller 2 inches in diameter, the speed of the latter should be $\frac{255 \times 1.5 \times 60}{16 \times 4 \times 2} = 179$ revolutions per minute. Some spinners prefer to run the finishing drawing frame about 10 per cent. slower than the speed found in this way, because the roving frame is frequently stopped for doffing. If this speed be maintained, however, the drawing frames may be stopped every week for a length of time sufficient for their proper cleaning. The speeds of the other drawings and spread-board may be found in a similar manner from the speed of the following frame, the number of slivers at the back of that frame being substituted for the number of spindles. It will be found right in practice to add 10 to 15 per cent. to the speed of the 1st drawing or set frame thus obtained, since this frame is frequently stopped when sets run out.

To Change the Weight of the Rove.—When the “clock” system is employed, the weight of rove is altered by changing the clock pinion so as to spread the given weight of fibre over a greater or less length of feed sheet, as before explained. If the sett system be the one which is used, the actual weight of a sett required to produce rove of a given weight may be approximately ascertained by calculation in the following manner:—Suppose that we require the rove to weigh 150 yards per ounce, and that the drafts of the system are: Roving frame 16, 3rd drawing 15, 2nd drawing 16 and 1st drawing 17, while the doublings are 8, 12 and 12

respectively for the 3rd, 2nd and 1st drawings, and the "bell," or length of sliver in each set can, 800 yards.

The rule is to multiply the yards in the "bell" by the drafts and the number of cans in the sett and to divide by the product of the yards per lb. of rove and the doublings. Thus in the example before us, the weight of the sett equals $\frac{800 \times 16 \times 15 \times 16 \times 17 \times 12}{(100 \times 16) \times 8 \times 12 \times 12} = 340$ lbs., and the average

weight of each of the twelve cans in the sett $\frac{340}{12} = 28$ lbs. 5 ozs.

The factors which modify this theoretical result are, loss in weight during the process, owing to dust and shove falling out, shortening of the drafts by "bulking," and contraction of the rove by twist. An explanation of the words "shortening of the drafts by bulking" is required. Owing to the passage of comparatively heavy slivers between the back rollers, their effective diameter and consequent feeding capacity is increased by an amount proportional to half the thickness of the sliver. Instead of the bare diameter of the roller, then, it is this diameter which determines the actual draft.

Slivers are frequently shortened or increased in thickness by being pressed tightly in short laps into the cans. The effects of this can be easily seen in heavy setts, when, if this be not allowed for, the rove will come out heavier than desired. Variations in the weight of the same rove may frequently be traced to the same cause, since, when sliver for the roving frame is scarce the cans are hurried forward half full, and when there is plenty of sliver they are filled to their utmost capacity. Especially with dirty material the loss in weight frequently counterbalances the gain by "bulking" and contraction by twist.

Licking up.—A frequent source of trouble in the preparing room, and of light and imperfect rove, is what is known as "licking up." "Licking up" is the adhesion of light slivers to the wooden pressing or drawing rollers, which is most noticed when the air is dry, as it often is in cold frosty weather or when easterly winds are prevalent, as they usually are in the month of March.

The cause may, in the author's opinion, be looked for in the electricity generated by the friction of the fibres as they are rapidly drawn through the gills. All are familiar with the electrical effects produced by the combing of long hair or the frictional electricity generated in amber when rubbed, also with the conductive properties of water and damp air. When the atmosphere is moist, "licking up" does not take place, since the frictional electricity referred to is absorbed.

In practice, the remedy, if not the cause, of this phenomenon is known. It consists merely in artificially supplying the lacking moisture by blowing off steam through the room, in the use of one of the humidifying arrange-

ments which will be described in Chapter XIX., and in moistening the faces of the wooden pressing rollers with water or with a specially prepared wash. This wash must also be frequently used to keep the faces of the wooden rollers free from the gummy matter which is deposited upon them by the passing fibre. A wash made up after the following recipe will act as a solvent upon all such matter, and, being highly volatile, dries up quickly:—Two parts of petroleum, one part of raw linseed oil, and one part of turpentine. Some prefer to substitute spirits of wine for the linseed oil and some to use linseed oil pure, believing that it nourishes the wood.

Use of Table of Constant Numbers.—It is a very good plan for the preparing master, in addition to having a book containing full particulars of all his frames with their drafts, etc., to make out a table of constant numbers for each system and frame. The constant number referred to is obtained by supposing rove of unit length per unit of weight, or one yard per ounce; one, divided by the draft of the roving frame, then represents the yards per ounce of sliver delivered from the finishing drawing frame; this, multiplied by the doublings and divided by the draft of that frame, represents the yards per ounce of sliver delivered from the 3rd drawing frame.

In a similar manner constants for the weights of sliver delivered from the 2nd and 1st drawing frames and spread-board may be obtained.

These constants, kept preferably in decimals, when multiplied by the yards per ounce of the rove being made, give the weight the slivers should be as delivered from each frame. If an intelligent overlooker suspects that any mistake has been made by his hands, he can weigh the slivers and see to what degree their weight has been affected, and remedy the mistake as far as possible. Take as an example a system with drafts and doubling as follows:—Roving frame draft 12; 4th drawing frame draft 12 with 8 doublings; 3rd drawing frame draft 12 with 8 doublings; 2nd drawing frame draft 16 with 12 doublings; 1st drawing or set frame draft 16 with 12 doublings. The constant for the 4th drawing frame is then $\frac{1}{12} = \cdot083$;

3rd drawing $\frac{\cdot083 \times 8}{12} = \cdot05$; 2nd drawing $\frac{\cdot05 \times 8}{12} = \cdot037$; 1st drawing

$\frac{\cdot037 \times 12}{16} = \cdot028$, and spreader $\frac{\cdot028 \times 12}{16} = \cdot021$. The actual yards per

ounce of sliver at each frame, that on the roving frame being, say, 100, is then roving frame 100, 4th drawing 8·3, 3rd drawing 5·5, 2nd drawing 3·7, 1st drawing 2·8, and spreader 2·1.

To avoid Mixes.—In order to avoid mistakes and the mixing of cans in the preparing room, it is a very good plan to distinguish by different colours the cans of the various systems and to distinguish by distinct markings, such as one, two, three, or four bands of colour, the 1st, 2nd, 3rd and 4th drawing frame cans.

Workers' Charges.—In a medium or fine room, Irish hands are quite capable of the charges and earn the wages as under: Spreaders can spread from 3 to 8 leathers according to the draft and speed of the board and the degree of care required. Their wages run from 8s. to 9s. 6d. per week. Spread-board front minders can attend to six 8-leather or ten 4-leather boards and earn 7s. 6d. per week. Back minders look after nine to sixteen heads, and earn 7s. to 7s. 6d. per week. The drawers or front minders can attend to six to eight heads of fronts and a similar number of backs, or, in the case of those behind the roving frame, $1\frac{1}{2}$ frames of roving backs or nine or ten heads. Their wages are from 8s. to 9s. 6d. per week.

Most Continental spinners prefer to put one drawer in complete charge of one or two drawing frames, both back and front, and to have the roving frames minded in the same way. The arrangement has some advantages.

Ramie Preparing Machinery.—The preparing machinery most in vogue for ramie is on the screw gill principle, and is worked as we have described.

The type of drawing head or gill box as used for worsted or silk waste is preferred, its chief feature being the double or intersecting gill.

CHAPTER X.

GILL SPINNING—ROPE YARN—BINDER TWINE—TRAWL TWINE AND SHOE THREADS.

Automatic Spinner.—Rope yarns are always spun directly from the sliver without any intermediate process, such as roving. Slivers of Manila, for instance, delivered in a narrow ribbon from the finishing drawings of the types shown in figs. 38 and 42, are most conveniently spun upon the automatic spinner, such as is shown in figs. 46, 47, and 48. A finer yarn from the same material may be spun on the frame shown in fig. 49.

The automatic spinner was first introduced in America by John Good. As shown in fig. 48, B is the can of sliver from the finishing drawing frame. It is placed behind the machine as shown, and the sliver drawn up and passed through the trumpet mouth C (which prevents the passage of knots), then through the feed rollers D, which are geared and given the same surface speed as the gill sheet E by means of a band and pulleys, as shown. The sliver passes through another trumpet mouth F before being pinned by the gills, which are placed on bars, and form a sheet, working in a similar manner as explained when speaking of the machine fig. 29. From the gills the fibres are drawn through the condenser apparatus F', then between the cheeks of the stop motion lever G, through the twist tube H (where it receives its twist), round the haul pulleys I and I', then round the guide pulleys J and J' (upon the leg of the flyer K), from whence it passes to the bobbin L upon the stationary spindle M, upon which bobbin the twisted yarn is wound. The condenser F' is the first point of interest in connection with the draft-regulating movement. It is in two pieces, the trumpet mouth F' and the grooved cam-shaped nipping plug N, centred in the throat of the former, and which is intended to automatically contract and enlarge the size of the opening according to the size of the yarn, and at the same time to maintain a nip on the passing fibres. The condenser is mounted upon a vibrating piece O centred at P, and maintained in a vertical position by the spring Q. The upright piece O is also connected by a link to the short arm of a bell crank lever S, the long arm of which forms the belt shifter which shifts the belt T which drives the gearing V, the latter giving motion to the endless chain of gills

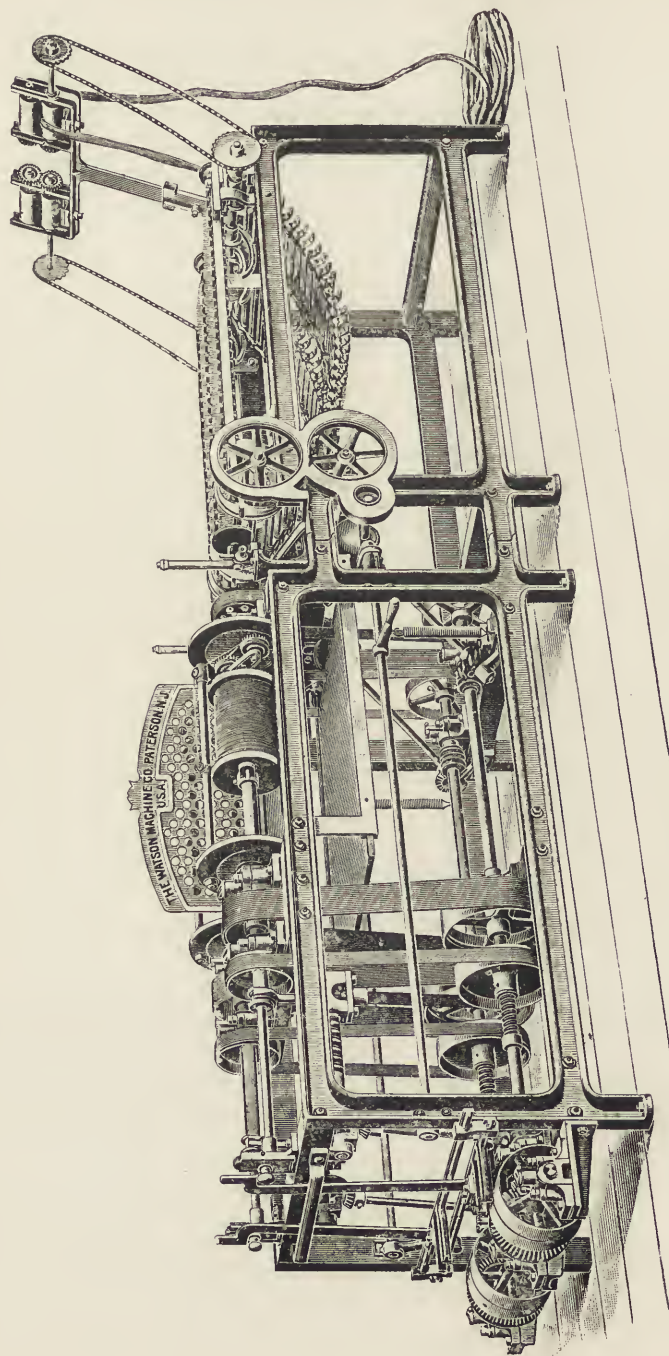

Fig. 46.—Automatic spinner for rope yarn and binder twine.

by means of the sheet belt W. The plug N is round, and fast upon an axle which passes through it. On one end of the axle is a handle to turn the plug and free the opening when required. In addition, on either end of the axle is a lever X by means of which the plug is automatically rocked. The plug is channelled on its periphery, the channel gradually deepening from its commencement until it terminates in a round shoulder formed in a steel block which is let into the plug. Condensation of the sliver takes place between the plug and a steel plate placed immediately above it, as shown. The nip is maintained by means of the balanced springs Y and Z attached to the arm X. The coiled spring Z is enclosed in a tube forming

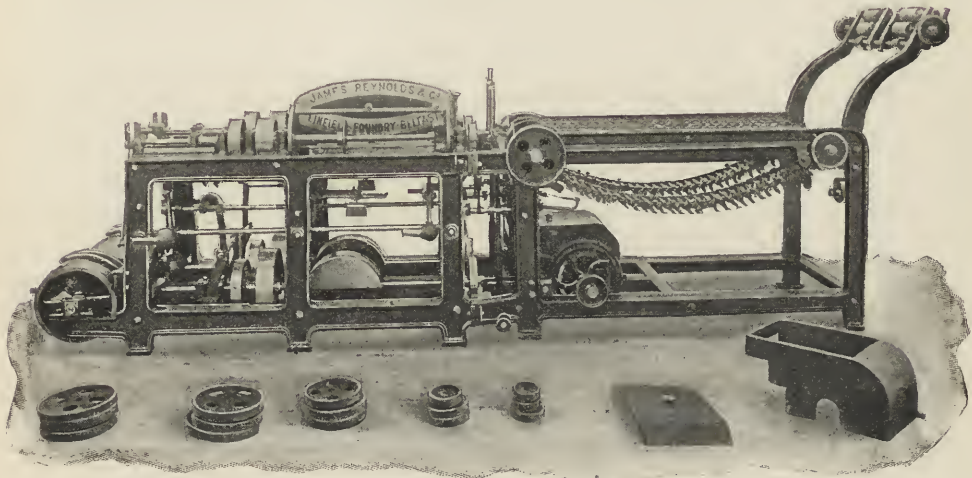

FIG. 47.—Horizontal automatic rope yarn and binder twine spinner.
(As made by James Reynolds & Co., Belfast.)

a continuation of the vertical arm O, and is connected with an adjustable screw Q pendant from the closed end of the tube. The belt T is a round leather one of small diameter working on a grooved pulley $8\frac{3}{4}$ inches in diameter, and upon one of three flat faced pulleys all of the same size, viz., 8 inches. One of these pulleys is a loose one; another gives the average or ordinary speed to the gill sheet; while the third pulley gives the sheet a quick speed. When the upright arm O is in its normal position, with a yarn of the average diameter passing through the condenser F, the belt T is upon the medium speed pulley. When the upright arm O is pulled forward, by a thick portion of the sliver trying to get through the condenser, the belt is shifted on to the slack pulley and the gill sheet momentarily stops while the thick part is drawn out and the yarn levelled, when the condenser recedes again and the gill sheet starts once more. When a thin portion of the sliver reaches the condenser it tends to pass

through the contracted opening more readily and the tension upon the upright arm O relaxes, permitting the spring Q to draw it backwards,

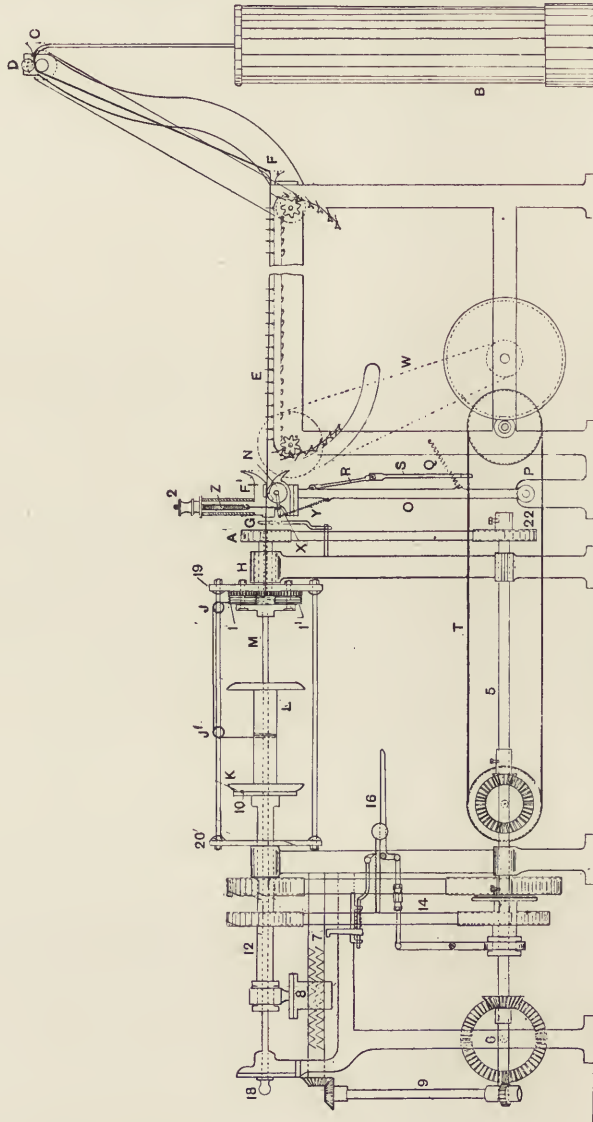

FIG. 48. — Automatic spinner for rope yarn and binder twine.

shifting the belt on to the quick speed pulley, and producing an increased supply of material to the condenser, and consequently uniformity in the yarn. The three driven pulleys, being of equal diameter, have naturally like velocities when the belt is upon them. The two different speeds are

given to the gill sheet as follows :—The quick-speed pulley is fast upon the spindle upon which all three work. This spindle carries the larger of the two pinions shown, which has 29 teeth and drives the smaller of the spur wheels V of 130 teeth, producing the quick speed sheet. The slow speed pulley is fast on a sleeve which runs loose upon the spindle and carries the smaller of two spur pinions of 18 teeth which gears with the larger of the spur wheels V of 144 teeth and produces the ordinary speed at which the gill sheet runs. The third pulley is loose upon the spindle and gives no motion to the gill sheet. Of the two spur wheels V, side by side, the larger is loose upon the sheet pulley shaft. It has a ratchet cast upon its inner face with which a spring pawl on the inner face of the small spur wheel engages when the latter stops and the larger wheel becomes the driver. When the smaller wheel is the driver, the pawl naturally slips over the teeth of the ratchet. The grooved band pulley, $8\frac{5}{8}$ inches in diameter, receives its motion from the countershaft 5 through a bevel wheel of 72 teeth and a pinion of 18 teeth, as shown. The pinion may be placed at one side or the other of the bevel wheel in order to preserve the forward motion of the gill sheet, whether the countershaft turns to the right or to the left, giving the yarn right or left hand twist. The countershaft 5 receives its motion from the short shaft 6 carrying the frame pulleys, 12 inches in diameter, through the bevel wheels of 48 and 20 teeth, as shown. In order that the yarn, as delivered from the fixed point J', may be built over the whole length of the bobbin, the latter is given a reciprocating motion by means of a traverse screw 7 and a screw block 8 fitting the screw. The screw 7 is driven by a bevel wheel on the end of the slanting spindle 9, which receives a slow motion from an endless worm on the end of the countershaft 5. The end of the bobbin has in it a small hole, protected by a metal ring, in which engages a pin 10 projecting from the disc of the long sleeve 12, both sleeve and bobbin being carried round by the pull of the yarn as the flyer revolves, and both having a reciprocating motion, on the stationary spindle, given to them by the screw block 8, as shown. The flyer K is driven at a constant speed of say 1600 revolutions per minute by means of pulleys $13\frac{1}{2}$ and $7\frac{1}{2}$ inches in diameter respectively, the former fast on the countershaft and the latter upon the flyer sleeve. The belt 14 encircling the bobbin drag pulley, is termed the "friction belt." The bobbin pulley is about the same size as the flyer pulley—namely, $7\frac{1}{2}$ inches. The drag pulley is smaller than the flyer driving pulley ($13\frac{1}{2}$ inches); consequently since it is the tension of the yarn which pulls the friction belt round, the drag pulley has a quicker speed than the flyer driving pulley. This loose drag pulley has a friction surface on one side which bears against a loose friction plate between the two pulleys. The drag pulley is pushed against the friction plate by means of cranks, actuated through links from the weighted lever 16, as shown.

The friction plate is prevented from running faster than the flyer by means of studs on its back surface engaging with a similar stud on the side of the flyer pulley. The friction between the two surfaces is automatically increased, as required by the augmenting diameter of the bobbin at each traverse, by means of the shifting of the weight along the lever, as shown. The full bobbin is removed and replaced by an empty one in drawing out the sliding and stationary spindle M by means of the knob 18 on its end. The flyer is composed of two discs 19 and 20, say 12 inches in diameter, joined by two stay rods as shown. Both these rods carry guide pulleys for the yarn, those on one arm serving for right and those on the other arm for left hand twist. The bottom of the groove of the pulley J is in the plane of the last groove of the haul pulley I. The usual size of flyer is about 12 inches by 26 inches, and that of the automatic bobbin 8 inches by 10 inches, with a barrel 2 inches in diameter and 1 inch bore. The pulley 22, on the extreme end of the countershaft 5, is termed the twist pulley. Its diameter depends upon the degree of twist required in the yarn. It drives a pulley A, 5 inches in diameter, forming part of the twist tube H, upon the other end of which is a small pinion of 21 teeth driving the haul pulley wheels on either side, each of 36 teeth. These are compounded with haul pulleys I and I', of three grooves each, whose effective diameter is $3\frac{1}{2}$ inches. These haul pulleys run loose upon studs fixed in the disc of the flyer on one side and in a bridge piece which supports the end of the spindle, as shown, upon the other. The haul pulley drive is a sort of epicyclic or differential gear. If the twist tube were stationary, the flyer would carry the haul pulleys round the stationary pinion on the twist tube and give them motion in the same direction as itself. When, however, the twist pinion is run in the same direction as the flyer, it tends to drive the haul pulleys in the opposite direction. The speed given by the flyer is the greater, consequently the haul pulleys turn in the same direction as the flyer at a speed equal to the difference of the two contrary motions given to them by their two drivers. It is the amount of this difference, which may be regulated by the speed of the twist tube, which gives the draft, and affects both draft and twist. It is thus essential to the regularity in size and twist of the yarn that the twist belt should not slip, and that the flyer revolve at a constant speed. An example of the draft and twist for Manila binder twine or reaper yarn, 200 yards per lb., spun from sliver 50 yards per lb., will suffice to show the principle of the draft and twist calculation. Suppose that the twist tube driving pulley 22 be 8 inches in diameter and that the countershaft 5 runs at a speed of 864 revolutions per minute. The speed of the flyer is then $\frac{864 \times 13\frac{1}{2}}{7\frac{1}{2}} = 1555.2$ revolutions per minute, and that of the twist tube $\frac{864 \times 8}{5} = 1382.4$ revolu-

tions per minute. One revolution of the twist tube gives the haul pulleys $\frac{2}{3}$ of a revolution in one direction, while one revolution of the flyer gives the haul pulleys the same motion in the other direction. The speed of the flyer is the greater, however, so that the effective motion of the haul pulleys is $\left(\frac{1555.2 \times 21}{36}\right) - \left(\frac{1382.4 \times 21}{36}\right) = 907.2 - 806.4 = 100.8$ revolutions per minute. Their effective diameter being $3\frac{1}{2}$ inches, they draw through $\frac{100.8 \times 3.5 \times 3.1416}{12} = 92.4$ feet per minute. Since the flyer makes 1555.2

revolutions per minute, $\frac{1555.2}{92.4} = 16.8$ turns per foot of twist are put into

the yarn. The rate at which the yarn is drawn away and wound upon the bobbin we have ascertained to be 92.4 feet per minute. To calculate the draft we require to know the speed at which the sliver is led forward or the surface speed of the gill sheet, both at quick and slow speed. From the particulars already given we find that the speed of the wheel V of 144 teeth is $\frac{864 \times 18 \times 8\frac{5}{8} \times 16}{72 \times 8 \times 144} = \frac{207}{8} = 25.9$ revolutions.

If the change pulley for the sheet which is fast upon this axle be 5 inches in diameter and the pulley which it drives on the chain gill sheet front roller 10 inches in diameter, with a sprocket wheel of 7 teeth driving the sheet whose bars have a pitch of $1\frac{2}{3}$ inches, the speed of this sheet in feet per minute will be $\frac{25.9 \times 5 \times 7 \times 1\frac{2}{3}}{10 \times 12} = 12.6$, so that the draft thus appears to be $\frac{92.4}{12.6} = 7.3$. When the belt is on the pulley giving the gill sheet its

quick speed, the draft is $\frac{7.3 \times 16 \times 130}{29 \times 144} = 3.6$, so that the actual draft varies

between these two figures according to the inequalities in the sliver. The changing of the twist tube driving pulley 22 changes both draft and twist. It must be borne in mind that the change effected is out of all proportion to the difference in size of the pulleys, even a quarter of an inch in the diameter of the pulley making a very great difference in both the size and twist of the yarn. The draft alone is changed by increasing or diminishing the rate of feed by changing the lower of the two sheet pulleys in the inverse proportion to the draft required. The stop motion lever C is balanced by the tension of the yarn passing between its cheeks. When the yarn runs light or fails to pass through the twist tube, the lever falls, releasing the belt forks, shifting the belt on to the slack pulley, and applying a brake to a friction pulley generally placed on the shaft 5. The flyer is thus brought quickly to rest. As may be seen in fig. 46, each automatic spinner has two spindles running independently side by side. The flyers, owing to the danger attached to them in consequence of their

speed and weight, are often protected by a circular iron cover with a sliding door in the top. In practice, the twist and flyer belts must be kept tight, while the tension of the drag or friction belt is rather less. The yarn must be wound around the haul pulleys in the direction of rotation of the flyer, otherwise the machine will not work at all. This machine works very well on yarns spun from hard fibre, the weight of the yarns varying from 80 to 2000 yards per lb.

Binder Twine or Reaper Yarn.—In the automatic spinner shown in fig. 46, which is of American construction, belts have been replaced by gearing wherever possible in order to insure uniformity of product. Owing to the enormous quantities of binder twine employed in America every harvest, the United States are the largest users of hard fibre in the world. There

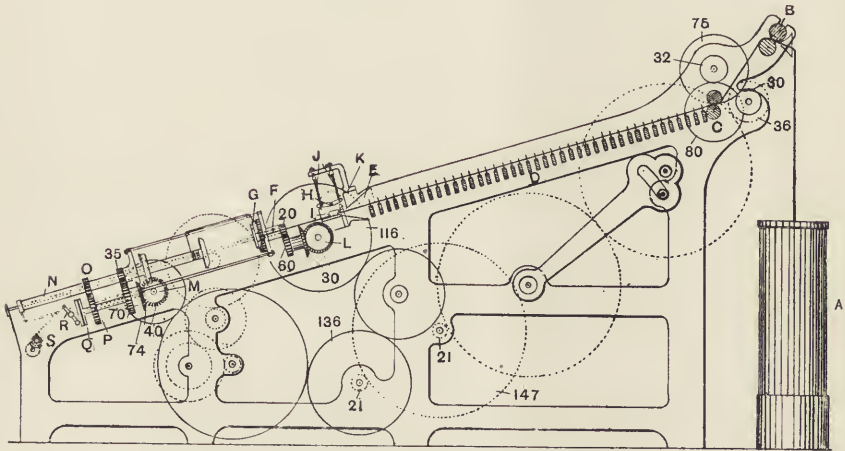

FIG. 49.—Lawson's inclined spindle gill spinning frame.

are many large rope works, one of the principal being the M'Cormick binder twine mill in Chicago, which has a capacity of 90 tons of binder twine per day.

Lawson's Gill Spinning Machine.—For lighter yarns from similar material, say yarn of 360 yards per lb. from the best white Manila, a machine rather differently constructed is required. Fig. 49 shows such a machine, which is known as Lawson's inclined spindle gill spinning machine. A is the can of sliver from the finishing drawing frame. As shown, the sliver is lifted from the can by a pair of rollers B, which deliver it to a pair of feed rollers C. As it issues from these latter it is "pinned" by the gills, on the faller bars D, which work in the ordinary way on the screw gill principle as described in Chapter VIII. From the gills the material is drafted through a trumpet mouth arrangement E and a twist tube F, by means of haul pulleys G, of similar construction, and working in the same

way as those of the automatic spinner which we have just described. Unlike the latter, however, this machine has no draft-controlling mechanism, its trumpet mouth merely serving to retain and draw out lumps, etc., and to maintain such a grip upon the fibres as will prevent them from being "gulped." The condensing trumpet mouth is formed by an eccentrically grooved roller H and a grooved block I, the grooves forming a tapering passage for the sliver. The roller H is held in position by springs J, acting upon arms projecting from the roller axle in opposite directions, as shown, and by the frictional drag of the sliver on the roller, by which means a light nip is maintained, the twist running up to this point. The bracket K, carrying the roller, is hinged to the block I, and held down by a spring hook. The bracket K is also constructed to form the upper half of the trumpet mouth, guiding the sliver to the nip. It will be noticed that in this machine the gills and spindles are both mounted at the same inclination, the object being to allow the sliver to pass in a direct line through the nip. The theory of the drafting, twisting and winding is similar to that of the automatic spinner, the method of driving the parts and the construction of the machine alone being different. This machine has usually six spindles side by side, and is adapted for an 8 x 4 inch bobbin. Gearing takes the place of belts in the flyer and twist tube drives and in dragging the bobbin, and has the advantage that, being a positive drive, the weight and twist of the yarn cannot be affected by slipping belts, as in some makes of automatic spinners. The twist tube is driven through an intermediate wheel, as shown, by a shaft L running across the frame, upon which shaft is the wheel of 116 teeth, which is driven from the driving shaft by change gearing. The flyer is driven through intermediates from another cross shaft M, also driven by gearing from the pulley shaft. The bobbin is, as before, pulled round by the tension of the yarn and connected by a pin with the sliding sleeve N, which has upon it a pinion O, upon a feather, which pinion gears with a wheel P compounded with the friction disc Q, upon which additional pressure is applied as the bobbin fills by the lever R, actuated through a chain by a shaft S, upon which the chain is wound, and which gets a semi-turn through a worm compounded with a ratchet wheel which is moved by a detent at each traverse of the bobbin in a manner which will be readily understood.

As the calculations for draft and twist upon this machine are rather difficult, we will give particulars of the wheels and speeds in detail. The draft is the ratio between the length of sliver taken in by the feed rollers in a given time and the length of yarn which in a like space of time passes over the haul pulleys and is wound upon the bobbin.

Taking one minute as the unit of time and the speed of the frame pulley as 450 revolutions per minute, we find the length of sliver taken in by the back roller as follows:—Upon the other end of the frame shaft from

that upon which the driving pulley is keyed, is a pinion of 21 teeth driving the large stud wheel of 147 teeth. Compounded with this stud wheel is another pinion of 21 teeth driving the back shaft or draft change wheel of 36 teeth, through the two large spur carriers shown. Upon the other end of the back shaft is a pinion of 30 teeth driving the stud wheel of 75 teeth, compounded with the stud pinion of 32 teeth driving the back or feed-roller wheel of 80 teeth at a speed of $\frac{450 \times 21 \times 21 \times 30 \times 32}{147 \times 36 \times 75 \times 80} = 6$ revolu-

tions per minute. The circumference of the back roller, which is 3 inches in diameter, is $3 \times 3.1416 = 9.4$ inches, so that it draws in $6 \times 9.4 = 56.4$ inches of sliver per minute.

To find the length of yarn delivered to the bobbin by the haul pulleys in the same time, we proceed, as in the automatic spinner, to find the difference between the power of the flyer and the twist tube drives. Motion is given to both flyer and twist tube from a speed wheel of 136 teeth upon the frame shaft. This wheel drives the wheel of 74 teeth upon the flyer shaft through the large intermediate shown. Upon the flyer shaft are bevels of 40 teeth, gearing with similar bevels upon studs.

Compounded with the latter are spur pinions of 70 teeth driving the flyers through pinions of 35 teeth at a speed of $\frac{450 \times 136 \times 40 \times 70}{74 \times 40 \times 35} = 1654$ revolutions per minute.

The twist tubes are driven in a similar manner to the flyers, through a wheel of 116 teeth upon the cross shaft, upon which are bevels of 30 teeth driving stud bevels of similar size, which latter are compounded with spur wheels of 60 teeth driving the twist tubes, through pinions of 20 teeth, at a speed of $\frac{450 \times 136 \times 30 \times 60}{116 \times 30 \times 20} = 1582$ revolutions per minute.

Upon the inside ends of the twist tubes are pinions of 20 teeth, gearing with similar pinions upon the haul pulleys. The velocity given to the haul pulleys by the twist tube drive is thus equal to 1582 revolutions per minute. The flyer revolves in the same direction as the twist tubes, and carrying round with it the haul pulleys, tends to give them a velocity of 1654 revolutions per minute in the direction opposite to that of the 1582 revolutions given by the twist tube. The effective speed of the haul pulleys is thus $1654 - 1582 = 72$ revolutions, and their diameter being $2\frac{3}{8}$ inches, the length of yarn drawn through per minute is $72 \times 2.375 \times 3.1416 = 537$ inches. Since the rate of feed is 56.4 inches and that of delivery 537 inches per minute, the draft of the frame is $\frac{537}{56.4} = 9.5$. The turns per foot of twist being put into the yarn, the speed of the flyer being 1654 revolutions and the rate of delivery $\frac{537}{12}$ feet per minute, are $\frac{165 \times 412}{537} = 37$.

To produce yarn about 400 yards per lb. from Manila hemp, Lawson's gill spinner should have—

Length of reach	80 inches
Breadth of gill	1½ "
Pins per inch (1 row)	8 "
Length of pin out of stock	$\frac{3}{4}$ inch
Pitch of screw	$1\frac{5}{16}$ "

Gill Spinning Frame for Rope Yarn.—Rope and twine yarns from tow

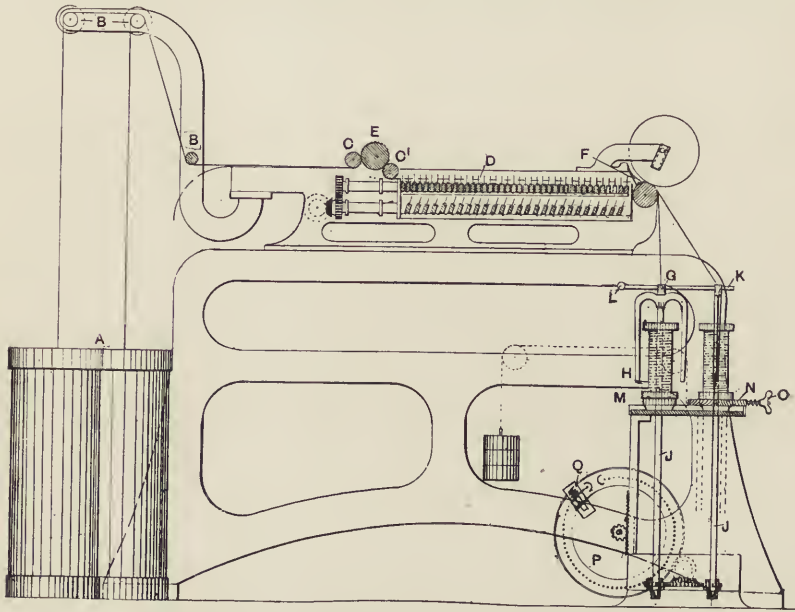

FIG. 50.—Gill spinning frame for rope yarns.

and soft hemp are most conveniently spun upon a gill spinning frame of the roving frame type shown in fig. 50.

As before, A are the cans of sliver from the finishing drawing frame and C the feed rollers. B are the sliver guides over which the sliver passes as it is drawn from the can, and D the faller bars and gills working in screws in the ordinary way. The arrangement of feed rollers, screw gills and drawing rollers, is in fact just the same as described in the previous chapter when speaking of the drawing frame. Leaving the drawing rollers, the sliver passes through a hole in the head of the flyer, down the leg and on to the bobbin. The flyer is of steel, and the hollow leg works equally well with or without a "curl," or eye, H, upon the extremity of its leg. The flyers are fast upon the top of the spindles J, which are driven at a constant speed by gearing, as shown, from the frame shaft. The long and heavy

spindles, usually driven at a rather high speed, are steadied by the plate K, which fits over the spindle tops and flyer heads, and which, being hinged at L, may be raised to remove the flyers and full bobbins. The bobbins are pulled round by the tension of the yarn. They rest upon the carriers M, with which they engage by means of pins, as shown, and which they pull round with them. A suitable drag is applied to the bobbin by means of wooden friction brakes, one of which is shown at N. These are composed of two wood blocks which surround the carrier, upon which they are pressed with more or less intensity, as the thumb screw O is turned and the blocks tightened together.

The yarn is built upon the bobbin in a regular manner in consequence of the up-and-down motion of the builder with the carriers upon which the bobbins rest. This up-and-down motion, which in this machine is constant and regular, both as regards speed and length of traverse, is given by means of a wheel P, known as the "mangle wheel," which is frequently met with in spinning machinery, and which, acting in conjunction with a rack and pinion, gives the required motion in a manner now to be described. The driver of the mangle wheel is a small pinion Q, keyed upon the end of a shaft, driven by gearing from the other side of the frame. This shaft is not rigidly carried, so that its extremity, with the pinion which it bears, can change its position, in the slotted bracket shown, when the mangle wheel is moved round to a position such that the last of its teeth is in gear with the small driving pinion. The teeth of the mangle wheel are brass pins ranged in an uncompleted circle. As the pinion reaches the last pin at either end it moves round it, being assisted to do so by the semicircular guides shown. It will be seen that the pinion, which constantly turns in the same direction, drives the mangle wheel alternately in opposite directions, giving the builder its up-and-down motion in a manner easily understood from the drawing.

Fine Gill Spinning Frame.—Finer gill spun yarns, which cannot stand an excessive strain in the winding on, are often spun upon a similar frame furnished with a differential motion, and which has all the characteristics of a roving frame, such as we will describe in our next chapter. The differential motion varies and governs the speed of the bobbin and builder as the former fills and maintains a uniform tension upon the thread.

Sometimes the gill spinning frame for fine yarns is fitted with a similar builder, tape-driven spindles and fish-tailed flyers as those used in the dry spinning frame, which will be described in Chapter XII. In this case the bobbins are dragged by drag bands which bear against the grooved base of the bobbin, the motion of which they retard sufficiently to permit of the flyer winding on the yarn as spun.

The degree of twist put in by all types of spinning and twisting frames depends upon the ratio between the speed of the flyer and the rate of

delivery. For very coarse yarn, such as rope yarn, for instance, the degree of twist is indicated in turns per foot run, while for finer yarns the number of turns per inch is spoken of.

For rope yarns the number of turns per foot twist required equals the product of 3.75 and the square root of the number of the yarn. For 25's spun yarn, for instance, the correct twist will be $\sqrt{25} \times 3.75 = 5 \times 3.75 = 18.75$ turns.

Basis of Rope Yarn Numbering.—The number of rope yarn indicates the number of threads of that yarn which will be required to make one of the three strands which will form a rope 3 inches in circumference. No. 40, for instance, indicates that three strands of 40 threads each, or 120 threads in all, make a rope 3 inches in circumference. The weight of 100 yards of No. 40 rope yarn may be calculated as follows:—The weight of 100 yards 3 inch circumference white rope averages about 84 lbs. The contraction by twist being about 25 per cent., each of the single yarns composing the rope must have a length of 125 yards, or the total length of the 120 strands will be 15,000 yards. Since this length weighs 84 lbs. or 1344 ozs., 100 yards weighs nearly 9 ozs. Similarly, No. 20 rope yarn equals 18 ozs. per 100 yards, No. 30 weighs 12 ozs., and No. 18, 20 ozs., etc.

Heavy jute yarns are likewise gill spun upon a frame of the roving frame type. The number of jute yarns, as also of heavy flax yarns under the Scotch system, is the weight in lbs. of four hanks, or 14,400 yards. The number of flax and hemp yarns under the English system of numbering, indicates the number of cuts or leas, of 300 yards each, contained in one pound weight. Consequently to reduce Scotch to English numbers, it is sufficient to divide 48, or the number of cuts per Scotch spyndle, by the number or weight in lbs. per spyndle. Thus, 3 lbs. Scotch yarn = $\frac{48}{3} = 16$'s lea English.

The average twist required per inch by flax, hemp, and jute yarns may be taken to be the product of 2 and the square root of the number of leas of 300 yards contained in one pound. Thus the number of turns per inch twist necessary for 16's lea equals $2 \times \sqrt{16} = 2 \times 4 = 8$ turns. 16's lea English equals $\frac{48}{16} = 3$ lbs. Scotch yarn, so that to find the twist for any given weight of Scotch yarn we may take as a basis the turns per inch required by 3 lbs. yarn. The number of turns per inch required by any other Scotch number is then obtained by multiplying the turns per inch for 3 lbs. yarn by the square root of 3 and dividing by the square root of the number of the yarn to be twisted. Thus the twist required for yarn 5 lbs. per spyndle at the rate of 8 turns per inch for 3 lbs. yarn is

$$\frac{8 \times \sqrt{3}}{\sqrt{5}} = \sqrt{\frac{64 \times 3}{5}} = 6.2 \text{ turns per inch.}$$

The reason that the square root of the number is introduced into the twist calculations is that the twist should vary inversely as the diameter of the thread, and that the diameter of the thread varies as the square root of the lbs. per spynkle, or inversely as the square root of the number of leas per lb.

Thus, to give No 40 rope yarn, for instance, its standard twist, or $\sqrt{40} \times 3.75 = 6.32 \times 3.75 = 23.6$ turns per foot, upon a gill spinning frame of the roving frame type, having a wheel of 102 teeth upon the delivery roller and driving the twist change pinion through intermediates, the number of teeth in the twist change pinion will be found to be 25, if the remainder of the gearing be as follows:—Stud carrier 64 teeth, spindle shaft wheel 44 teeth, spindle shaft bevels 28 teeth, and spindle pinions 19 teeth. For, the circumference of the boss roller being 4.4 inches, the spindles must make $\frac{23.6 \times 4.4}{12} = 8.65$ turns for one of the delivery roller, to accomplish

which the twist change wheel must have $\frac{102 \times 64 \times 28}{8.65 \times 44 \times 19} = 25$ teeth.

In order to lay outstanding fibres and to give the yarn a smoother appearance, gill spinning frames with delivery roller and vertical spindles are frequently furnished with a damping roller which is placed between the point of delivery and the spindles. It has as many bosses as there are spindles in the frame. Each boss is flannel covered, and all are partly submerged, and turn in a trough of water which keeps their surface constantly damp. The yarn, while being twisted, bears against this damp surface, and a smoother yarn is consequently produced.





FIG. 51.—Fraser's patent spiral roving frame.

CHAPTER XI.

THE FLAX, HEMP, JUTE, AND RAMIE ROVING FRAME.

Spiral Roving Frame.—The roving frame is the last machine of the series in the preparing room. When the sliver reaches this frame, it has been drawn out to such an extent that if it is to be drawn out still further it must be given a slight twist to strengthen it, and must be wound upon a bobbin or spool. For these purposes, the roving frame, which is in reality a drawing frame, must be provided with spindles and flyers which are placed vertically in front of the boss or delivery roller.

Fig. 51 gives a general view of a screw gill roving frame as made by Messrs Douglas Fraser & Sons, Arbroath, Scotland. The same firm are the makers of a push-bar roving frame for jute, which works on the same principle as their "Ring" drawing frame, fig. 45. Quick gill bars necessitate quick spindles, and those referred to have been run at 900 revolutions per minute for years without undue wear.

In general appearance the frame resembles the gill spinning frame shown in section in fig. 50, but it is provided with additional mechanism, as are some gill spinning frames for fine work, to prevent excessive strain being put upon the roving as it is being wound upon the bobbin.

The drafting arrangements of the roving frame are practically the same as in the drawing frame; the gills are, however, finer, and the front conductor proportionate in width to the weight of sliver produced, being frequently only $\frac{1}{8}$ inch in width. It has always been the custom to arrange the spindles, to the maximum number of about 80 or 90, in two rows of 30 to 45 spindles each. Experiments are now being made, however, upon fine frames, to increase the number of spindles twofold by using wider gills, with two slivers abreast per row, and arranging the spindles in four rows instead of two. Usually, no doubling takes place upon the roving frame, only one can from the third or fourth drawing being put up at the back for each spindle. The frame is consequently much longer than the drawing frame, having sometimes nine heads of ten spindles or 90 spindles in all. The spindles are of steel 2 to 3 feet long and $\frac{1}{2}$ to $\frac{3}{4}$ inch in diameter. The spindle "foot" rests in a brass step set in the step rail. The spindles are supported in a vertical position by brass collars fixed in the

builder. These collars should be long, projecting on the under side below and on the upper side level with, the top of the builder, thus forming a sleeve or socket upon which the wharves or carriers may run without wearing the spindles. The length of the spindle must be at least 3 inches longer than twice the traverse of the largest bobbin to be used, plus the depth of the builder and step rail from step to cover. The top of the spindles are fitted to receive the flyers, which are of wrought iron or steel. The mode by which the flyer is attached to the spindle top must be such that it can be easily removed and replaced when doffing, but at the same time remain firmly in position when working. Perhaps the best is the patent of Hattersley, the method employed being a spiral groove cut in the spindle top, the groove terminating in a round stop. This groove receives a small round button, fixed inside the socket of the flyer, the revolving spindle keeping the button pressed against the end of the groove.

Another method of attachment consists in one or more vertical grooves or keyways cut in the top of the spindle, the socket of the flyer having corresponding ribs or feathers. It should be impossible for the flyer to be pulled off by entangled rove, etc., while working. Were this to occur, damage to itself, the rove on the bobbin, or the other flyers would result. The neck and leg of the flyer are hollow, the latter being split to facilitate threading. The rove enters the neck, passes to the leg through one of two lateral holes, and is thence led through the flyer eye, which is of the ordinary curl pattern, on to the bobbin.

In Ireland the rove is usually passed direct from the hole in the neck to the leg of the flyer. Some Continental spinners pass the rove almost completely round the neck before leading it through the leg of the flyer, believing that in doing so they get a smoother rove and localise the tension and strain in the twisted portion of the slubbing. The spindles are driven from the frame shaft at a speed of 400 to 900 revolutions per minute. Take a frame, for instance, where a speed wheel of 84 teeth, upon the frame shaft, drives through a train of intermediate spur wheels a wheel of 44 teeth upon the spindle shaft. A number of bevels, of 28 teeth each, drive pinions of 19 teeth keyed upon the spindles. In this frame the spindles will make $\frac{84 \times 28}{44 \times 19} = 2.8$ revolutions for one of the frame shaft.

Suppose that the line shaft makes 177 revolutions per minute, and that a 20-inch drum upon it drives a pulley 24 inches in diameter upon the frame shaft. The latter thus makes $\frac{177 \times 20}{24} = 147.5$ revolutions per minute, and consequently the spindles make $147.5 \times 2.8 = 413$ revolutions per minute.

In frames of various makers the speed of the spindles usually bears a fixed ratio to that of the frame shaft.

In Lawson's it has been found to be as 2·8 : 1, in Combe's 2·4 : 1, and in Fairbairn's 3 : 1. The wharve, or bobbin carrier, consists in a round platform, upon which the base of the bobbin rests. The under portion of the carrier is a bevel or spur pinion, by means of which motion is given to it from the socket wheel running loose upon the frame shaft. The wharve runs upon the top portion of the brass neck which surrounds the spindle. Its flat face has one or more pins projecting from its surface, which engage in corresponding holes in the base of the bobbin.

The bobbins have generally a barrel of ash with sycamore or beech ends, but for very fine work it is advisable to employ a finer wood, extra well finished and polished. The bore of the barrel is chambered to reduce friction on the spindle. The sizes of bobbins range from $4\frac{1}{2}$ inches to 12 inches traverse, with $2\frac{1}{2}$ inch to 5 inch heads. The speed of the wharves, and, consequently, of the bobbins, usually bears the same ratio to that of the socket wheel as does the speed of the spindles to that of the frame shaft. Thus in the frame we have taken as an example, a socket wheel of 105 teeth drives, through a link motion of spur intermediates, a wheel of 55 teeth upon the bobbin shaft. A number of bevel wheels of 28 teeth upon this shaft drive the pinions, each of 19 teeth, which form part of the wharve. Thus for one revolution of the socket wheel the wharves make $\frac{105 \times 28}{55 \times 19} = 2\cdot8$ revolutions. If the differential wheel were fixed, the socket wheel would revolve at the same speed as the frame shaft, as will be explained later on, and therefore the bobbins would revolve at the same speed as the spindles. It is by running the bobbins at a different speed from the spindles, however, that the winding on of the rove upon the former is effected, and it is to govern and maintain this difference in speed that that beautiful piece of epicyclic gear known as the differential motion, or sun and planet wheels, was introduced, constituting as it does one of the most complex motions in textile mechanism.

The fine and light sliver delivered from the roving frame boss roller—one ounce often containing 500 yards—could not be wound upon and again unwound from the bobbin without giving it a small degree of twist to strengthen it. The amount of twist required varies from one-half to two turns per inch for any given material, being directly as the square root of yards per ounce, and inversely as the square root of the weight of unit length, or inversely as the diameter of the rove. The speed of the spindles being constant, the twist is altered by changing the speed of delivery or the velocity of the boss roller. This is done by increasing or decreasing the number of teeth in a wheel known as the twist change pinion, which lies in the train of gear which communicates motion from the frame shaft to the boss roller. In old frames it is often a driver, placed on the end of the frame shaft, and consequently must be *decreased* in size when changing

from coarse to fine rove. In modern frames it is also a driver, being compounded with a socket wheel on a stud. If this be the case it must also be *decreased* in size when changing from coarse to fine rove. Taking the same frame as before, and following the gearing from the boss roller to the spindles, we have a wheel of 102 teeth upon the boss roller, driving through intermediates a twist change wheel of say 34 teeth, compounded with a stud carrier of 64 teeth, driving through some more intermediates a wheel of 44 teeth upon the spindle shaft. A series of bevels of 28 teeth, upon this shaft, drive the spindles, upon which are pinions of 19 teeth. The spindles thus make $\frac{102 \times 64 \times 28}{34 \times 44 \times 19} = 6.43$ revolutions for one of the

boss rollers, which—the boss roller being 4.4 inches in circumference—means $\frac{6.43}{4.4} = 1.46$ turns per inch twist. Supposing that this twist has

been found suitable for rove 320 yards per ounce, and it is desired to change the frame on to rove 200 yards per ounce, the nature of the material being the same, the requisite twist pinion may be found by multiplying the existing twist pinion by itself and by the present yards per ounce of rove, dividing by the new yards per ounce of rove, and extracting the square root of the result. Thus we get $\sqrt{\frac{(34 \times 34) \times 320}{200}} = \sqrt{1849} = 43$ as the required

twist pinion. The reason for this is that the number of teeth in the twist pinion is inversely as the twist, which twist varies directly as the square root of the yards per oz.

Turns per inch of Twist Required.—The amount of twist which rove requires depends very much upon the nature, length and strength of the material of which it is composed, warp flax requiring less twist than weft flax, and weft flax less than tow for the same weight of rove.

In reality, all that is required is to give the yarn sufficient strength to be drawn off the bobbin by the feed roller of the spinning frame and through the hot water trough, when required, without drawing or breaking. The smaller the excess above this minimum strength, the more easily and regularly can it be drawn upon the minimum reach. A few examples from actual practice will give some idea as to the amount of twist required to give various weights of rove sufficient strength. (1) A tow rove 40 yards per ounce, destined to spin 14's lea from Russian dew-retted tow, required 0.84 turn per inch twist. (2) A tow rove 64 yards per ounce, destined to spin 25's lea from Russian dew-retted machine tow, required 1.05 turns per inch twist. (3) A tow rove 90 yards per ounce, destined to spin 40's tow warp from Irish machine and sorting tow, required 1.05 turns per inch twist. (4) A certain line rove 100 yards per ounce, intended to spin 40's lea light warp from Russian dew-retted flax, required 0.85 turn per inch twist. (5) A line rove 150 yards per ounce, destined to spin 70's lea light warp from

Courtrai long line flax, required 0.97 turn per inch twist. (6) A line rove 225 yards per ounce, intended to spin 50's lea prime warp from Irish long line flax, required 1 turn per inch twist. (7) A line rove 260 yards per ounce, fit to spin 100's lea light warp from Flemish long line flax, required 1.3 turns per inch twist. (8) A line rove 300 yards per ounce, intended to spin 120's lea light warp from Courtrai long line flax, required 1.41 turns per inch twist; and (9) a line rove 400 yards per ounce, fit to spin 140's lea light warp from Courtrai long line flax, required 1.56 turns per inch twist.

The writer has known rove to be correctly twisted on the same frame with the same twist pinion, although differing in weight by 100 yards per ounce. A constant number may be found for any frame, which, divided by the turns per inch twist required, gives the necessary twist pinion. Taking our previous figures, we first find the product of the number of teeth in the boss roller wheel, stud wheel and spindle shaft bevels, and then divide by the product of the teeth in the spur wheel on the spindle shaft, the pinion on the spindle, and the circumference of the boss roller in inches. We thus get a constant number of $\frac{102 \times 64 \times 28}{44 \times 19 \times 4.4} = 49.7$, which when divided by 1.46 turns per inch, gives 34 as the required twist pinion.

Bobbin Winding.—We will next consider the means by which this comparatively weak rove is built upon the bobbin in a regular manner without strain. This can only be done by giving the bobbin a positive motion by means of gearing. It is obvious that the winding may be done in two ways, either by running the flyer quicker than the bobbin or by running the bobbin quicker than the flyer. The former plan is almost universal in roving frames for flax, hemp, and jute. Advantages are claimed for both. The chief reason why the "bobbin lead" has not been adopted in

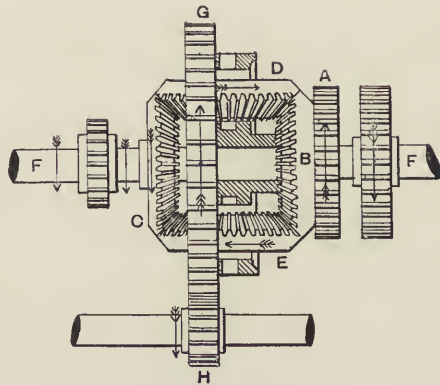

FIG. 52.—Houldsworth's differential motion for the roving frame.

this class of roving frame is, that with the ordinary "sun and planet" motion, fig. 52, which is almost universally employed, the crown wheel G must be driven in an opposite direction to the frame shaft, thus increasing friction, and also at a higher speed, which means power. The benefits claimed for it are, that when the roving frame starts, the spindles often commence to revolve before the bobbin; in this case, if the flyer leads, a stretch is given to the rove, but if the bobbin leads, the flyer merely winds a little

off. In the former case, too, if the end breaks, the bobbin, continuing to revolve, unwinds rove off itself. In the latter case, the end is lapped on and kept in position. Whichever method is adopted the bobbin varies in speed, in the former case running slower, and in the latter case quicker, when empty than when full.

We have shown that the speed of the bobbin bears a fixed ratio to that of the socket wheel which runs loose upon the frame shaft. It is the speed of this socket wheel, then, which is changed during the progress of the doff.

It is said that in the early days of flax spinning a cone drive alone was used to give the bobbin a varying speed. A friction drive, and especially that of a cone belt, could not be depended upon to drive the bobbin; besides, it is not fine enough to give the small changes of speed

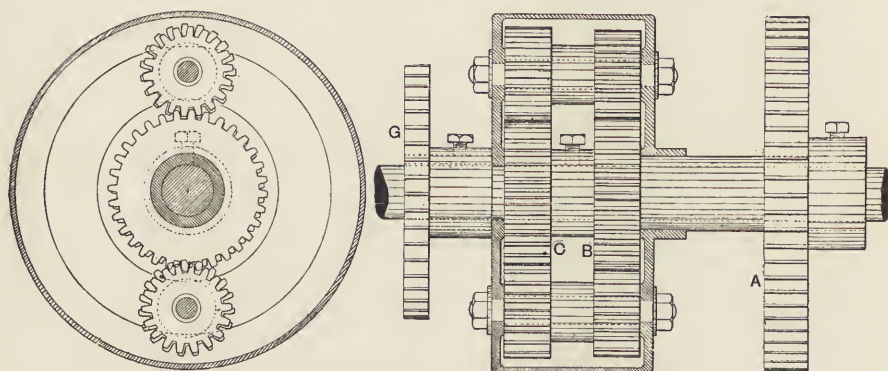

FIG. 53.—Differential motion as applied to Mackie's roving frame.

necessary. The differential motion is now employed, the original of which was invented by Joseph Raynor in 1813. This motion, as improved by Houldsworth (fig. 52), is still in use, although ingenious modifications are employed, such, for instance, as that shown in fig. 53. The improvements have as their objects the diminution of friction, and consequently the amount of work to be done by the unsatisfactory, but necessary, drive of the cone belt, expansion pulley, or disc and scroll.

The differential wheels as Houldsworth made them (see fig. 52), consist in a large wheel G, say 14 inches in diameter, having one or two bevel wheels, D and E, working on studs set at right angles to its axis and placed between the latter and the rim of the wheel. The second bevel wheel usually employed is really unnecessary, but acts as a balance to the wheel, and may be replaced by a weight. The large wheel G revolves loosely upon the frame shaft FF, carrying round with it the wheels which it contains. Upon either side of it, and upon the frame shaft, are two bevel wheels B and C, of equal diameter and pitch to those in the differential wheel. One

of these, C, is fast upon the shaft. The other, B, is loose and compounded with the socket wheel A, before referred to, which drives the bobbins.

If this combination be carefully studied, it will be seen that if the crown or differential wheel be held at rest, the bevel wheels which it contains will merely serve as carriers to transmit the motion unchanged, except as regards direction to the socket. The socket wheel A then always travels in an opposite direction to the frame shaft when at work. If the frame shaft be at rest and we turn the crown wheel G by hand in the same direction as that in which the former usually turns, we will find that, since the two bevels upon the shaft are the same size, the loose one will make two revolutions for each made by the crown wheel, one revolution being due to the motion imparted to the intermediate bevel by being carried round the fixed bevel, and the other to the crown wheel carrying round the loose bevel with it in consequence of the reaction of its teeth upon those of the intermediate bevel. The socket wheel A in this case revolves in the same direction as the crown wheel. If the crown wheel G be turned in the opposite direction, the socket wheel A will still make two revolutions for each one made by the former and in the same direction. The motion of the socket wheel A is then, when at work, the resultant of two velocities—one imparted to it by the frame shaft and the other by the crown wheel. The former is equal to that of the frame shaft, but in an opposite direction; the latter is equal to twice that of the crown wheel and in the same direction. We will call the direction of motion of the frame shaft positive, and designate it by the + sign, and the opposite direction negative, designating it by the - sign.

Let the velocity of the frame shaft be called a and the velocity of the crown wheel b . The resultant velocity of the socket A is then $a \pm 2b$, according to whether the crown wheel is run in an opposite direction or in a similar direction to the frame shaft. In the former case the socket runs at a higher speed than the frame shaft, and the bobbin leads the flyer; in the latter the socket revolves slower than the frame shaft and the flyer leads.

The object of the improved differential motion shown in fig. 53 is to reduce friction and the amount of work to be done by the cone belt or its substitute. In this piece of mechanism the crown wheel is replaced by a circular metal box, compounded with a socket wheel G, both revolving upon the frame shaft and driven by gearing from the lower cone. Inside the box, near its periphery and between and at right angles to its sides, two studs are fixed, which carry double pinions revolving freely upon them. One of each pair, those nearer the geared end of the box, work into a spur wheel B, fast upon the frame shaft and which corresponds with Houldsworth's "sun wheel." The other two pinions gear with a spur wheel C compounded with the socket wheel G running loose upon the shaft, which

socket wheel drives the bobbins. If the combination be studied, it will be seen that it is but a modification of the same old principle of epicyclic gear. If the box be at rest, motion, unchanged in direction, will be transmitted to the socket wheel from the wheel upon the frame shaft through the carrier pinions. If the number of teeth and pitch of the "sun" wheel, spur wheel on the socket and the stud carrier pinions composing the pair be the same, each to each, the socket wheel will have the same velocity as the frame shaft, the "box" being at rest. These wheels and pinions are made of different diameter and pitches, however, to produce a difference in speed.

If the box be moved round at the same time and in the same direction as the frame shaft, the driving "power" of the "sun" or fast wheel B will be diminished by an amount varying directly as the speed of the box, which thus serves the same purpose as the crown wheel in Houldsworth's motion. The "box" has a natural tendency to be carried round by the revolutions of the fast or "sun" wheel, so that when this motion is used the duty of the cone belt is not that of a driver, but rather of a drag or governor to retard and regulate the speed of the box. Another advantage of this combination is reduction in friction, as the socket wheel and sleeve revolve in the same direction as the frame shaft, which is not the case with the older motion. Minor advantages are the substitution of spur for bevel gear, and the fact that most of the gearing is enclosed in the practically dust-proof box.

It is by putting the crown wheel or "box" respectively in motion, then, that we are able to obtain a difference in speed between the bobbin and the flyer. This difference in speed, and consequently the speed of the crown wheel or of the "box," varies inversely as the diameter of the bobbin barrel as it fills. When the bobbin leads, the bobbins must revolve comparatively quickly when empty, gradually diminishing in speed as the bobbin fills. When the flyer leads, the inverse of this takes place. There are at least three different ways of driving the crown wheel or the "box" and changing the difference in speed of the bobbin and flyer proportionate to the diameter of the bobbin. The one in most general use is by means of hyperbolic cones. The larger diameter of the cones is usually about 6 inches and the smaller 3 inches, their length being about 36 inches. It will be noticed that in a properly constructed pair of cones the slope from the small to the large end is not a straight line, in one being slightly rounded and in the other correspondingly hollowed. This curve is what is known as a hyperbola, and is the only one with which the speed of one being constant, the speed of the other and, consequently, that of the crown wheel and lag or gain of bobbin may be increased or diminished by a given shift or belt, by amounts proportionate to the increasing diameter of the bobbin barrel. It will be noticed that the change in speed of the bobbins is much more rapid when it is comparatively empty than when full, as then

the constant increase bears a greater ratio to the diameter of the barrel than when the bobbin is larger.

The diameter of a properly shaped cone at any point may be found by multiplying the length of the cone in inches by the greater diameter, and dividing by the length of the cone in inches plus the distance of the given point from the large end of the cone. Thus the diameter of the cone just mentioned, at a point ten inches from its large end, is

$$\frac{36 \times 6}{36 + 10} = \frac{216}{46} = 4.7 \text{ inches.}$$

The diameter of the complementary cone at a similar distance from the small end is $(6 + 3 \text{ inches}) - 4.7 \text{ inches} = 4.3 \text{ inches}$. These cones are placed horizontally, one underneath the other, their centres being distant about 3 feet. The upper one has a wheel upon the extremity of its shaft, which is identical with one of those intermediates mentioned in our twist calculation as lying between the twist change wheel and the boss roller. The velocity of this cone is therefore constant for any given twist wheel. Motion is communicated to the lower cone by means of a belt, which can be shifted the entire length of the cones by means of a fork attached to a rack, actuated by the escapement of the index or ratchet wheel. When replacing the cone belt by a new one, the thickness should be as nearly as possible the same, since the thickness of the belt affects the relative speed of the cones to an appreciable extent. To be exact, the thickness of the belt should be added to the diameters of both cones. The small end of the lower cone can be raised by means of a rack and hand wheel, when it is required to shift the belt back to its starting-point to commence a new set of bobbins. When working, the weight of the lower cone is sustained by the belt, thus maintaining the tension of the latter. Upon the large and fixed end of the lower cone is a small pinion, which communicates the varying motion of the lower cone to the crown wheel through a small counter-shaft. The variable velocity of the lower cone is also utilised in the following manner to give to the builder the variable speed rendered necessary by the increasing diameter of the bobbin. A small pinion, on the end of the small counter or crown shaft above referred to, drives another shaft through a wheel keyed upon its end. The other extremity of this latter shaft has a small lateral movement controlled by a spring "rat-trap" motion, actuated by the upward and downward motion of the builder. This rat-trap or strike motion is shown in fig. 54. The small lateral movement which it imparts to the shaft C is sufficient to put the wheel, shown on the end of that shaft, alternately into gear with one or other of two spur pinions shown upon either side of it. These two pinions are compounded with stud wheels, which are themselves in gear, as shown, so that their direction of rotation depends upon which pinion is in gear with the driver.

In fig. 54, the catch A to the right is shown holding the tumbler

bracket B with the pinion on the end of the movable shaft C, in gear with the wheels to the left. When this catch is relieved by the descending builder, depressing the arm of the catch bracket D, the bracket B turns on its centre, bringing the wheel and shaft C into gear with the wheel to the right, and in this way changes the direction of rotation of the wheel C, and the motion of the builder when the latter reaches either extremity of its traverse. From either of the strike motion wheels, motion, in one direction or the other, is conveyed, through a changeable builder pinion and other intermediates, to a shaft running the whole length of the frame behind and below the builder. This shaft has pinions keyed upon it at frequent intervals. These pinions engage with vertical racks attached to the builder, which is thus given a reciprocating vertical motion, being guided by vertical slides and balanced by weights supported by chains.

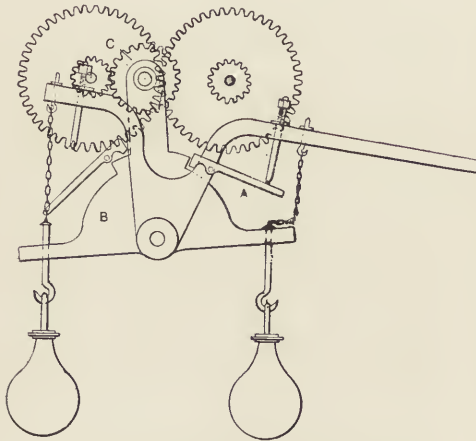

FIG. 54.—Rat-trap or strike motion for cone roving frame.

Each make of flax, hemp and jute machinery has its own special method of giving a variable motion to the bobbin and builder. Two use the cones just described, two the expansion pulley A, fig. 55, and one the disc and scroll mechanism, fig. 57. All of these have the same object—namely, to *increase* the speed of the bobbin as it fills by *diminishing* the speed of the differential or crown wheel B which turns in the same direction as the frame shaft C in a manner and in a proportion already discussed.

Combe's Expansion Pulley and Quick Change Motion.—The expansion pulley shown at A and A' in fig. 55 is in two halves. One, the half A, is fast upon its shaft, while the other is free to move inwards and intersect the other as it is constrained to do so by being gradually raised and at the same time pressed against a triangular slide. The raising of the expansion pulley around the shaft D as a centre compensates exactly for its increase in diameter, and keeps the driving band E at a constant tension. F is a grooved rim or rope pulley fast upon the boss or drawing roller of the frame. The expansion pulley is raised by means of a quadrant which supports the end A. The angle plate which controls the intersection of the two sides of the pulley is generally made with a bevel of one inch per inch perpendicular. The angle of the sides of the pulley is generally such

that, for every inch the pulley is pushed in, its diameter is increased by $1\frac{1}{4}$ inches. Each shift of the quadrant and of the pulley is effected, when the builder has reached the extremity of its travel at either end, by the escapement of a ratchet wheel, the catch retaining which is released by the motion of the builder. The speed of the bobbin and builder is thus regulated for the succeeding layer of rove. Fig. 55 also shows the most

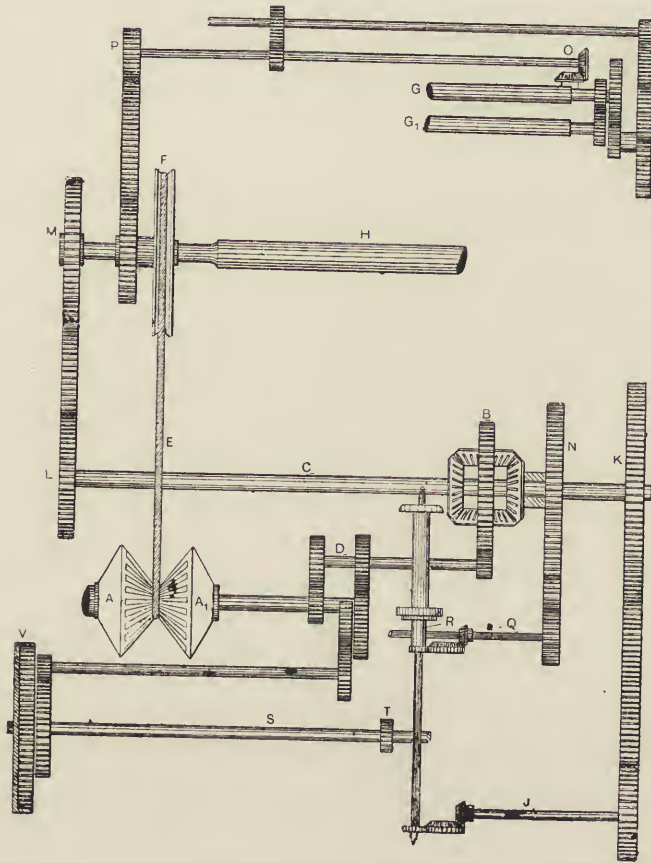

FIG. 55.—Combe's expansion pulley and gearing.

important parts of the roving frame. G and G₁ are the feed rollers, and H the boss or drawing roller. The space between these two sets of rollers is occupied by the fallers and gills, which are driven forward by screws actuated by bevel gearing similar to O. The draft gearing is also shown, P being the draft pinion, by increasing or diminishing the size of which the speed of the feed rollers is reduced or augmented, and the draft lengthened or shortened. The twist gearing is shown between the boss

roller and the spindle. The speed of the spindles is constant for any given speed wheel K. More or less twist is given to the rove by diminishing or increasing the speed of the boss roller H, by putting on a smaller or larger twist change wheel L. The gearing for driving the bobbin from the socket wheel N, through the bobbin shaft Q, bevels and carrier R, is also clearly shown. S is the builder shaft upon which pinions T drive the builder up and down by means of racks, the reciprocating motion being obtained in the case of Combe's frame by the use of the change motion shown in detail in fig. 56. In that figure A is a wheel which has a pinion keyed upon its pap and gearing internally, with the mangle wheel V, fig. 55. The wheel A is driven alternately by one or other of the two small pinions E and C, which gear into each other and alternately with the wheel A. The pinion E is upon the end of a movable shaft driven from the differential motion. The pinion C works loose upon a stud fixed in the arm D.

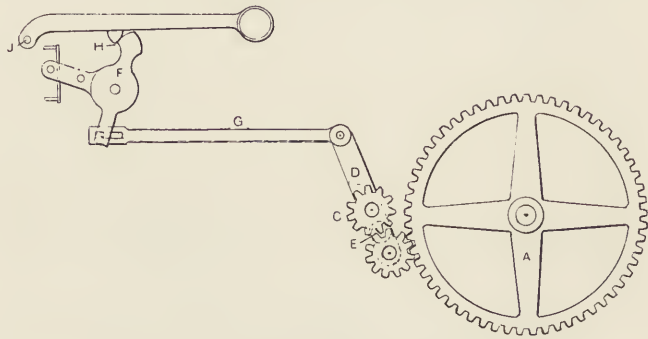

FIG. 56.—Combe's quick change builder motion.

This arm D is moved backwards and forwards, putting the pinions E and C in and out of gear by means of the connecting rod G, communicating motion from the piece F, which is turned upon its centre by the up-and-down motion of the builder. A quick and effective change is effected by means of the wedge-shaped pieces H, the upper one forming part of a weighted lever centred in J. The apex of the upper wedge should be vertically above the centre of F, so that the piece F, being symmetrically designed and turned in a negative sense by the falling builder, quickly escapes as the apices pass and the pinion C is forced into gear with the wheel A, while the pinion E is disengaged and the wheel A and the builder are driven in the opposite direction.

Fairbairn's Disc and Scroll Mechanism.—Fairbairn's disc and scroll mechanism is shown in fig. 57. A is a friction bowl sliding upon a feather upon a shaft which, through the gearing shown, regulates the speed of the differential wheel B. The bowl A and the shaft upon which it slides receive

motion by frictional contact with two horizontal discs D D upon a vertical shaft E.

The diameter of the discs is usually 20 inches. The lower one only is keyed upon the shaft E. The upper one works upon a long sleeve which carries a mitre wheel on its upper end. The vertical shaft or spindle E projects through the sleeve F and has another mitre wheel, G, keyed upon its upper extremity. The vertical shaft E and discs D D receive their motion, through intermediate gearing, from the twist wheel. This motion is a regular one, and the change in speed of the crown wheel is effected by shifting the friction bowl from the periphery towards the centre of the

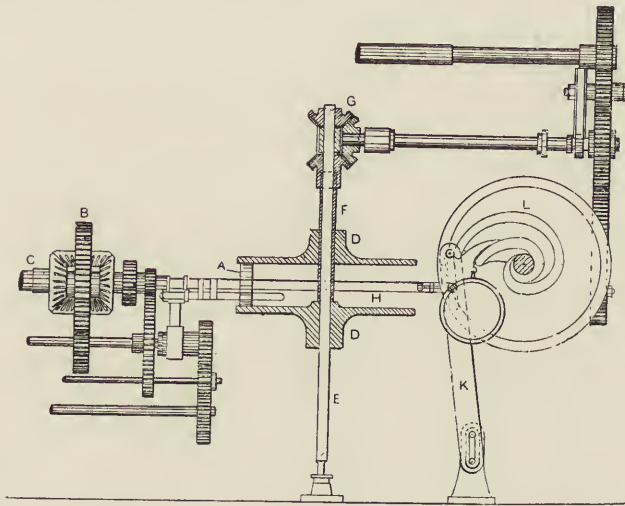

FIG. 57.—Fairbairn's disc and scroll mechanism for the flax, hemp and jute roving frame.

discs by means of the guide rods H, the lever K centred at its base, and the scroll L. The other parts of the mechanism are similar to those already described.

Fraser's Patent Spiral Roving Frame.—In Fraser's patent spiral roving frame, shown in fig. 51, expansion pulleys or cones and mangle wheel are employed. The Vee leather band, used to drive the expansion cones or pulleys, is arranged so that the slack is taken up automatically and the strain on the band maintained light and uniform throughout the filling of the bobbin. It will be noticed that in this frame, which is intended for heavy work, leather-covered metal pressing rollers are employed, and also that the spindle tops are supported and steadied by cap plates which are hinged and may be raised for doffing.

Power of the Crown Wheel.—Referring to pages 136 and 148, it will be seen how the speed of the spindles is obtained, also that of the bobbin,

depending upon the speed of the socket wheel forming part of the differential motion. In conjunction with the following figures and the explanation of the motion on pages 141 and 137, we have shown that the "power" of Houldsworth's crown or differential wheel, fig. 52, is two, or that when the flyer leads, the socket wheel loses two revolutions for each one made by the crown wheel, also that in the frame we have taken as an example, the bobbins make 2.8 revolutions for one of the socket. Hence it will be seen that the bobbin lags behind the spindle or loses $2.8 \times 2 = 5.6$ revolutions for each turn made by the crown wheel. Where a equals the speed of the frame shaft and b of the crown wheel, the speed of the bobbin at any moment is $2.8a - 5.6b$ or $2.8(a - 2b)$. If N represent the revolutions of the boss roller per minute, $1\frac{1}{2}$ inches its diameter, and d the diameter of the bobbin at any given moment, the requisite lagging of the bobbin at that moment equals $\frac{1\frac{1}{2} \text{ inch} \times 3.1416 \times N}{d \times 3.1416}$ or $\frac{1\frac{1}{2}N}{d}$, or, as above, $5.6b$.

$\frac{1\frac{1}{2}N}{d}$ then $= 5.6b$, or $b = \frac{1.5N}{5.6d}$; b thus varies inversely as d . If a pinion of 16 teeth upon the lower cone drives a crown shaft wheel of 66 teeth, and a crown driver of 26 teeth drives a crown or differential wheel of 105 teeth, the boss roller wheel having at the same time 102 teeth, and the upper cone wheel 40 teeth, the working diameter of the upper cone at that moment being x , h denoting the speed of the lower cone, and the sum of the diameters of the cones being 6 inches + 3 inches = 9 inches,

$$h = \frac{102 \times N \times x}{40 \times (9 - x)} = \frac{51 \times N \times x}{20 \times (9 - x)}, \text{ also } h = \frac{b \times 105 \times 66}{26 \times 16}.$$

Substituting the value of b , as found above, we get $h = \frac{1.5N}{5.6d} \times \frac{105 \times 33}{26 \times 8} = \frac{742.5N}{166.4d}$, which is the speed of the lower cone when the diameter of the bobbin barrel equals d . The constant velocity of the upper cone is $\frac{102 \times N}{40}$. Its surface speed at diameter x equals the surface speed of the lower cone at diameter $9 - x$, or $\frac{102 \times N \times x}{40} = \frac{742.5 \times N \times (9 - x)}{166.4d}$. Dividing across by N we get $\frac{102 \times x}{40} = \frac{742.5 \times (9 - x)}{166.4d}$. Then clearing of fractions, $16972.8 \, xd = 267300 - 29700 \, x$, and $x(16972.8 \, d + 29700) = 267300$ and $x = \frac{267300}{16972.8 \, d + 29700}$. Substituting the value of d , which at the start of the set equals the diameter of the bare barrel, or $1\frac{3}{16}$ inch, we get $x = 5.36$ inches, which is the working diameter of the upper cone at the start. The working diameter of the lower cone at the start equals $9 - x$, or $9 - 5.36 = 3.64$ inches. On the frame and with this gearing, the working diameter

of the cones at any stage of the doff may be found by substituting the actual diameter of the bobbin, at that moment, for d in the equation,

$$x = \frac{267300}{16972.8d + 29700}$$

Taking the rove we instanced previously, 320

yards per ounce, and built 26 rows per inch in length and 90 rows per inch in depth, when 90 rows have been put on, the bobbin will be 2 inches greater in diameter, or $3\frac{3}{8}$ inches.

If we substitute this for d in the above equation, we get 3.19 inches as the working diameter of the upper cone when 90 rows have been put on. The distance in inches y of any diameter D from the large end of these cones may be obtained from the equation as on page 143, $D = \frac{36 \times 6}{36 + y}$.

Substituting 5.36 and 3.19 separately for D in this equation, we find that the working diameter of the upper cone at the start of the doff is 4.3 inches from the large end of the cone, and that when 90 shifts have been made, it is 31.7 inches from the large end. In 90 shifts the cone belt has thus travelled $31.7 - 4.3 = 27.4$

inches, or $\frac{27.4}{90} = \frac{3}{10}$ inch per shift. The pitch of the teeth in the rack

being $\frac{1}{3}$ inch, and the rack wheel having 76 teeth, this wheel makes

$$\frac{.3}{76 \times .33} = \frac{1}{84}$$

of a revolution per shift. Therefore a 42 index wheel,

compounded with the rack wheel and shifting half a tooth every rise and fall of the builder, is required to build such a weight of rove in this manner.

We have shown that the difference in speed of the bobbin and flyer equals 5.6 times the speed of the crown wheel, therefore 5.6 rows in length of traverse are put on for each revolution of the crown wheel. As there are 26 rows per inch in the build we have selected, this means a rise or fall in the builder of $\frac{5.6}{26}$ inches for each revolution of the crown wheel.

The pitch of teeth in the builder rack being $\frac{1}{2}$ inch, and the rack pinions on the traverse shaft having each 22 teeth, the latter shaft makes $\frac{5.6 \times 2}{26 \times 22}$

of a revolution for each turn of the crown wheel. Upon the end of the traverse shaft is a wheel of 96 teeth working into a stud pinion of 14 teeth, compounded with a stud wheel of 86 teeth which gears with the builder

pinion. This stud wheel thus makes $\frac{5.6 \times 2 \times 96}{26 \times 22 \times 14} = \frac{19.2}{143}$ of a revolution

for each turn of the crown wheel. Beginning at the other end of the train now, the crown wheel has 105 teeth and is driven by a pinion of 26 teeth upon the crown shaft, upon the end of which another pinion of 12 teeth drives the movable shaft through a wheel of 36 teeth. Upon the other end of this latter shaft a wheel of 24 teeth drives a socket wheel of 40

teeth, compounded with which is the builder pinion. The builder pinion thus makes $\frac{1 \times 105 \times 12 \times 24}{26 \times 36 \times 40} = \frac{21}{26}$ of a revolution for one of the crown wheel. There being 86 teeth in the stud wheel which gears with the builder pinion, and which makes, as we have just shown, $\frac{19 \cdot 2}{143}$ of a revolution in the same time, the number of teeth in the builder pinion must be $\frac{86 \times 19 \cdot 2 \times 26}{143 \times 21} = 14$ teeth.

Thus, upon this frame a 42 index wheel and a 14 builder pinion are required to build this rove in the manner described.

The index and builder pinion for a frame other than the cone frame may be found in a somewhat similar manner, and the latter in every case directly from the crown wheel. In the disc and seroll frame, if the seroll and index wheel make a complete revolution to fill the bobbin, the number of teeth in the index wheel equals the number of rows in depth upon the bobbin when one tooth is slipped every change. When only one half tooth is slipped, the number of teeth equals one half the number of rows in depth upon the bobbin under the same conditions. When a smaller headed bobbin is used, and the full throw of the seroll not required, the number of teeth in the index wheel will be just the same as that required to fill the larger bobbin, since the wheel only makes a partial revolution.

In the expansion pulley frame, the diameter of the expansion pulley is directly as the diameter of the bobbin. Suppose we find that, when the bobbin is 2 inches in diameter, the expansion pulley has a diameter of $4\frac{3}{4}$ inches. If the rove be 40 rows per inch in depth, when 40 changes have been made, the diameter of the bobbin will be 4 inches and that of the expansion pulley $9\frac{1}{2}$ inches. If the construction of the bevel plate and pulley be such that 1 inch of rise in the pulley produces 1 inch of intersection, and 1 inch of intersection an increase of $1\frac{1}{4}$ inches in the diameter of the pulley, a rise of 3.8 inches is required to increase the diameter from $4\frac{3}{4}$ to $9\frac{1}{2}$ inches. This was done, we said, in 40 shifts, which means a rise of $\frac{3 \cdot 8}{40} = \cdot 095$ inch per shift. If the long and short arms of the quadrant lever which raises the pulley be respectively $14\frac{3}{4}$ inches and 6 inches, a point on the pitch circle of the rack will move through $\frac{\cdot 095 \times 14 \cdot 75}{6} = \cdot 23$ inch per shift, which, the pitch of the teeth of the wheel

being $\frac{3}{8}$ inch, equals $\frac{\cdot 23}{\cdot 375} = \cdot 61$ tooth. If the pinion on the index spindle working into the rack has 24 teeth, it must make $\frac{\cdot 61}{24} = \frac{1}{40}$ revolution per

shift. The index wheel, being upon the same spindle, also makes $\frac{1}{40}$ revolution per shift, and consequently must have 20 teeth if one half tooth is slipped at each "change."

In these calculations the author has neglected such factors as the contraction of the rove by twist, the thickness of the cone belt, and the length of one lap of rove. The latter is not, strictly speaking, the diameter of the bobbin at the moment multiplied at 3.1416, but the perimeter of an ellipse, the minor axis of which is the actual diameter of the bobbin, the major axis depending upon the pitch of the spirally wound laps or upon the rows per inch in the length of the traverse.

Practical Changing.—In practice the correct index wheel and builder pinion to start a new roving frame are usually arrived at by experience, and by comparison with a similar frame already working. When changing from one weight of rove to another, they are changed in proportion to the square root of the yards per ounce of rove, which is always inversely proportional to the weight of the sett and to the number of doublings, and directly proportional to the drafts.

If, for instance, we have a frame making rove 150 yards per ounce and building it correctly with a 35 index wheel, and we have made the sett lighter by an amount which should bring out rove 200 yards per ounce—to find the index wheel necessary to build this lighter rove in a similar manner, we must first square the number of teeth in the old index wheel, then multiply by the new weight of rove, then divide by the old, and finally extract the square root of the quotient thus:—

$$\sqrt{\frac{35^2 \times 200}{150}} = \sqrt{\frac{1225 \times 200}{150}} = \sqrt{1633} = 40. \quad \text{An easier method, and}$$

nearly accurate, is to work by proportion; add the old index to the result and halve the total thus obtained. As follows:— $150 : 200 :: 35 : 47$, $\frac{47 + 35}{2} = 41$. The twist required being *directly* proportional to the

square root of the number of yards per ounce of the rove, and the number of teeth in the twist pinion being inversely proportional to the twist it produces, the twist pinion may be found in a similar manner by squaring the number of teeth in the old twist pinion, multiplying by the number of yards per ounce in the old rove, dividing by the number of yards per ounce in the new rove, and extracting the square root of the result. Thus, if a 55 twist pinion is required for rove 150 yards per ounce, what twist pinion will be required for rove 200 yards per ounce? Evidently a smaller

$$\text{pinion or } \sqrt{\frac{55^2 \times 150}{200}} = \sqrt{\frac{3025 \times 150}{200}} = \sqrt{2269} = 48 \text{ nearly; or again,}$$

as before, work by proportion, add the old twist pinion to the result and halve the sum thus obtained, thus:— $200 : 150 :: 55 : 41$ and $\frac{41 + 55}{2} = 48$.

Starting the Frame.—To start a roving frame, the ends are brought out through the delivery roller, slightly twisted by hand, passed through the eye in the head of the flyer, down the hollow leg, through the twizzle at the end and wrapped in the proper direction around the barrel of the empty bobbin. The differential motion is run back to its starting-point; that is to say, if a cone frame, the bottom cone is raised by the hand wheel and rack provided for the purpose and the cone belt screwed back to its starting position on the cone by means of another hand wheel. If it be an expansion pulley frame, the pulley is screwed down to its small diameter, and if a disc and scroll frame, the friction bowl is pulled back near the edge of the discs, the correct starting-point being marked and fixed by means of an adjustable stop. The winding on should be as slack as possible at the start in order to avoid strained rove and to ensure the rove winding off to the very end. When an index wheel has been changed, care must be taken that while one pawl holds the index, the other is exactly in the centre of a tooth so that exactly a half tooth may be taken each time.

Rove Stock.—A rove stock of eight or ten bobbins of rove per spinning spindle should be kept and suitable bins provided in a cool and shady place near the preparing room for storing them prior to their removal to the spinning room. A principle very frequently lost sight of in practice is that all vegetable fibres are improved in spinning quality by being allowed to remain lying for a short time in a suitable place after every stage of their manufacture. Scarcity of rove necessitating its hurried removal from the roving frame to the spinning room should be avoided, and may be sometimes cured by providing every roving frame with a counter showing the number of revolutions of, say, the boss roller, and paying the rover a bonus upon results as regards production.



FIG. 58.—Double dry spinning frame for shoe threads of flax or hemp,
as made by Messrs J. Mackie & Sons, Ltd., Belfast.

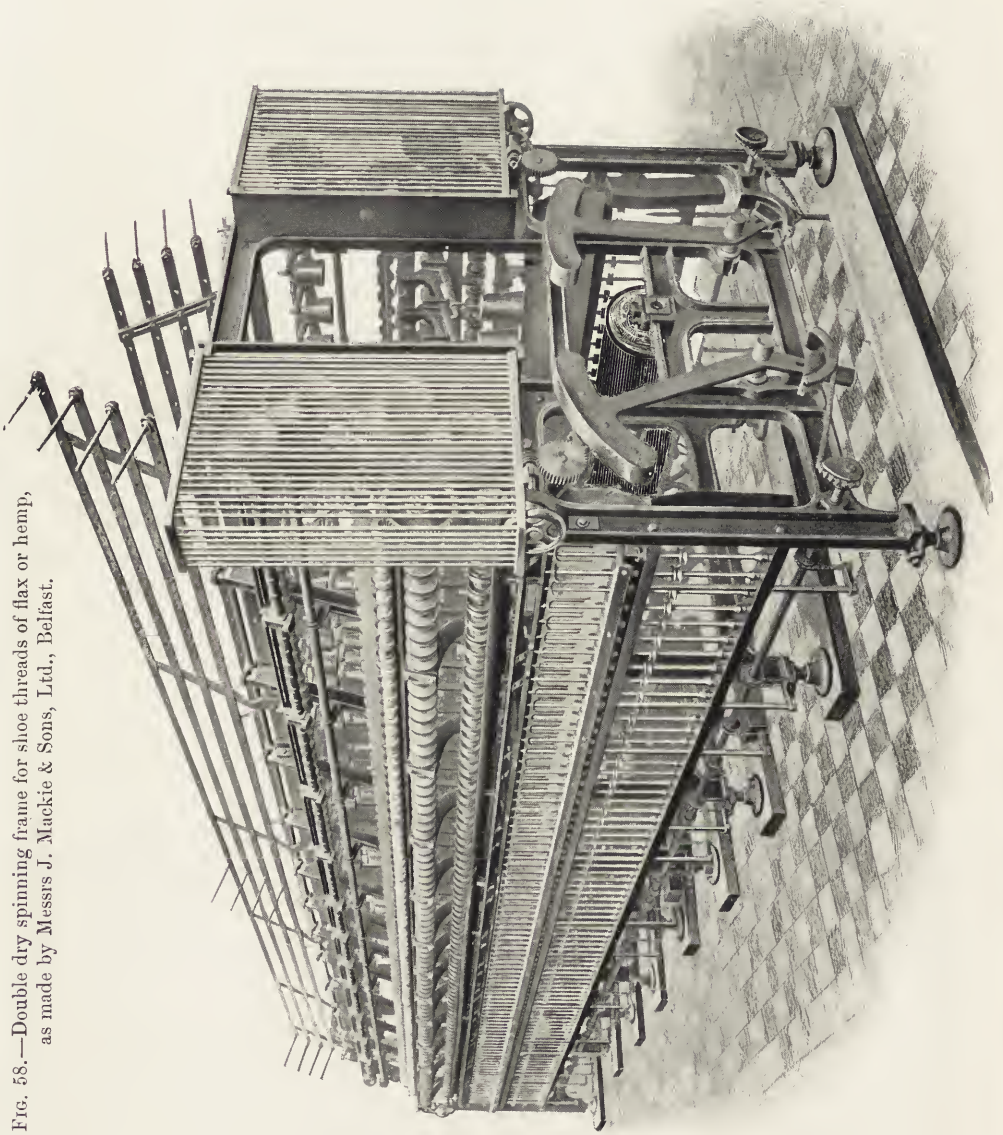

CHAPTER XII.

DRY AND DEMI-SEC SPINNING OF FLAX, HEMP, JUTE AND RAMIE.

The Dry Spinning Frame.—Although yarn as fine as 16's lea linen and weighing 4800 yards per lb. may be spun on the finest of the gill spinning frames which we have described in Chapter X., such a method of production is rare, and is only employed where a very level and superior yarn is required. Dry spinning frames, then, such as are shown in figs. 58 and 59, are used for materials such as jute (which cannot be spun very fine), for coarse flax tows where a bulky thread for filling purposes is required, or for superior flax and hemp yarns of medium counts when the maximum strength is sought for, such being obtained by allowing the ultimate fibres to remain joined together in a long length. A long reach frame of somewhat similar construction is also required for ramie or rhea, the ultimate fibres of which are long and strong.

Fig. 58 shows a good form of dry spinning frame specially adapted for spinning superior yarns, such as shoe threads, from flax and hemp.

Fig. 59 shows, in section and detail, a frame constructed upon the same principle, but having several special features which we will describe later on.

In the dry spinning frame, the bobbins of rove, produced as described in the last chapter, are placed upon stationary pins, seen in both figures and ranged above the feed rollers at such an inclination that the rove may be drawn off the bobbin at right angles with its axis.

The feed rollers are from $1\frac{1}{2}$ to $2\frac{1}{2}$ inches in diameter, of steel and fluted 12 to 20 per inch of diameter. The drawing rollers are likewise of steel, their bosses being 3 to 5 inches in diameter and $\frac{3}{4}$ to $1\frac{1}{8}$ inch face. The face of the bosses is also scored or fluted to 16 to 24 per inch. The pressing rollers, usually of sycamore, about 8 inches in diameter and tapered to a narrow face, say $\frac{1}{4}$ inch broad, are placed behind the metal drawing roller, against which they are pressed by springs or by a lever and weight as clearly shown in fig. 59. In a jute dry spinning frame the reach or distance from centre to centre of the drawing and retaining rollers is usually 9 inches. For long line flax and hemp it must often be 18 inches, and is consequently often made adjustable. In the frame shown in fig. 58, for instance, the reach may be raised or lowered, by means of screws coupled to a shaft passing through the frame. In passing between the feed and drawing rollers, the rove is guided and controlled by a breast plate supplemented by bearing rollers if the reach is very long. The length of the

reach being equal to that of the longest fibres, the breast plate may be made to take the place of gills in controlling the delivery of material to the drawing rollers. For the breast plate may be advanced or retired, either

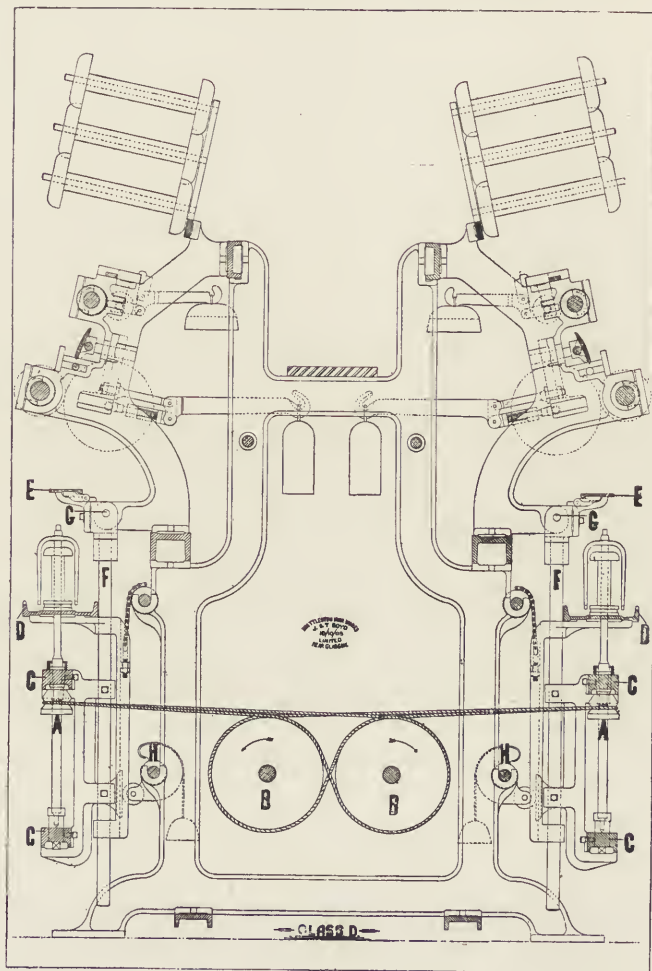

FIG. 59.—Boyd's patent swing rail dry spinning frame for hemp and jute.

partially or bodily, by means of adjusting screws, causing the rove which passes over it to be pressed against it with more or less tension, preventing the twist from running out of the rove and the short fibres from being gulped. The levelness of the yarn produced depends to a great extent upon the skilful regulation of the breast plate and bearing rollers. A small funnel-shaped tin conductor is used to guide the material to the narrow-faced drawing roller. The spindles, distant one from the other from 3 to

5 inches, are placed vertically in one row, the line of the spindle produced being slightly forward from the point of delivery, causing the end, while being twisted, to bear upon the eye of the thread plate E, fig. 59, which steadies it and prevents ballooning.

The flyers are serewed upon the spindle tops. The ends are lapped once or twice around the leg, and pass, through a semicircular nick in its flattened end, to the bobbin which runs loose upon the spindle. The bobbins have heads $1\frac{1}{2}$ to 3 inches in diameter and a 3 to 5 inch traverse according to the pitch of the frame. The base of the bobbin is grooved for the drag band, which, attached to the back of the builder, touches the bobbin base and passes over the nicked front edge of the builder, tension being maintained by a drag weight attached to the end of the cord. The drag upon the bobbin must be sufficient to put the requisite tension upon the end to prevent ballooning, since winding on is done by the flyer, which runs quicker than the bobbin, the latter being dragged round by the yarn. The difference in speed between flyer and bobbin is just sufficient to take up the yarn as spun, and naturally varies according to the diameter of the bobbin. The bobbin rests upon the builder, which is given an up-and-down motion by means of poker rods, chains, and a builder shaft, which is given a reciprocating motion by means of a heart wheel or a quadrant motion, such as is shown in fig. 58.

The spindles rest in footsteps set in the step-rail, which extends the whole length of the frame. They turn in brass collars set in the neck rail, and are caused to revolve at a speed of from 2000 to 4000 revolutions per minute by cords or tapes passing around a tin cylinder B and a wharve fixed upon the spindle.

A rove traverse motion above the feed rollers should always be provided to increase the life of both feed and drawing rollers.

The creel of the frame shown in fig. 58 is adapted for spinning double rove, a method of spinning which, by increasing the doublings twofold, adds considerably to the levelness of the yarn produced. The spinning of the double rove, however, of course increases the cost of production, since more roving spindles and complementary preparings will be required.

Swing Rail Dry Spinning Frame.—The special feature to be noticed in connection with the dry spinning frame, fig. 59, is the spindle driving. The spindles A are driven, each with a separate band, from a double row of cylinders B. This ensures the driving of the spindles on both sides of the frame in exactly similar conditions (which is impossible with a single cylinder as used in the ordinary frame). The spindle rails C, the lifter rails D, and the thread plates E are made in short sections of twelve spindles each. Instead of fixing the rails to the framing, each set is carried on a pair of swinging pokers F, centred close to the thread board on a strong stud G on the main framing, so that they are free to swing from and

towards the cylinder for the purpose of tensioning the bands. A pair of weighted levers, H, are employed to give the necessary pressure of the spindle rails and spindles outwards against the bands. In this way whatever tension is decided upon can with exactness be kept on each band. Thus all irregularities in the driving, caused by a damp or dry atmosphere affecting the bands, is overcome, and a minimum driving power can be fixed and relied upon. When a new band is put upon a spindle it is instantly stretched to the length of the bands on the other eleven spindles on the rail, as it receives the whole outward pressure applicable to twelve spindles.

By employing two cylinders BB, the down thrust of the spindles into their footsteps is prevented, thus saving loss of power and wear of spindle. The pull of the band on one side counteracts the pull from the other side, thus taking the strain (200 lbs. or more) off each cylinder.

In addition to the advantage of regularity of spindle driving, the suspended swing rail ensures absence of vibration in the spindle and thus causes the tension upon the end to be much more regular.

The spindles are fitted with patent self-oiling neeks which require oiling only once a month instead of at least twice per day, as in the ordinary frame.

It is claimed that, by the swing-rail arrangement of spindle driving, the bands are kept at one tension even in damp weather, and that the variation in their driving power does not exceed 5 to 10 per cent. throughout the whole of the spindles in a frame. Actual electric motor tests show that upon an ordinary frame of 4-inch pitch, one horse power drives 12.3 spindles at 2500 revolutions per minute, while with a swing-rail frame of similar pitch, one horse power drives 20.6 spindles at approximately the same speed.

Particulars of Dry Spinning Frames for Jute.—The following particulars of dimensions and speeds of dry spinning frames are in conformity with the ordinary practice of the jute spinning trade:—

Pitch of Frame.	3 $\frac{3}{4}$	4	4 $\frac{1}{2}$	5
Bosses per head,	8	8	6	6
Diameter of feed roller in inches,	2 $\frac{1}{2}$	2 $\frac{1}{2}$	2 $\frac{1}{2}$	2 $\frac{1}{2}$
Flutes per inch diameter of feed roller,	20	20	20	16
Diameter of drawing roller in inches,	4	4 $\frac{1}{2}$	4 $\frac{1}{2}$	5
Flutes per inch diameter of drawing roller,	16	16	16	12
Width of face of drawing roller in inches,	1 $\frac{1}{4}$	1 $\frac{1}{2}$	1 $\frac{1}{8}$	1 $\frac{1}{2}$
Dimensions of bobbins in inches,	3 $\frac{3}{4}$ × 2 $\frac{1}{4}$	4 × 2 $\frac{1}{2}$	4 $\frac{1}{2}$ × 2 $\frac{3}{4}$	5 × 3
Diameter of spindles in inches,	$\frac{9}{16}$	$\frac{1}{8}$	$\frac{5}{8}$	$\frac{11}{16}$
Diameter of wharve in inches,	1 $\frac{3}{4}$	1 $\frac{3}{4}$	2	2 $\frac{1}{4}$
Diameter of cylinder in inches,	10	10	10	10
Speed of cylinder, revolutions per minute,	600	560	585	660
Speed of spindle, revolutions per minute,	3000	2800	2600	2400
Turns per inch twist,	3 to 9	3 to 9	2 to 6	2 to 6
Reach in inches,	9	9	9	9
Drafts,	5 to 10	5 to 10	4 to 8	4 to 8



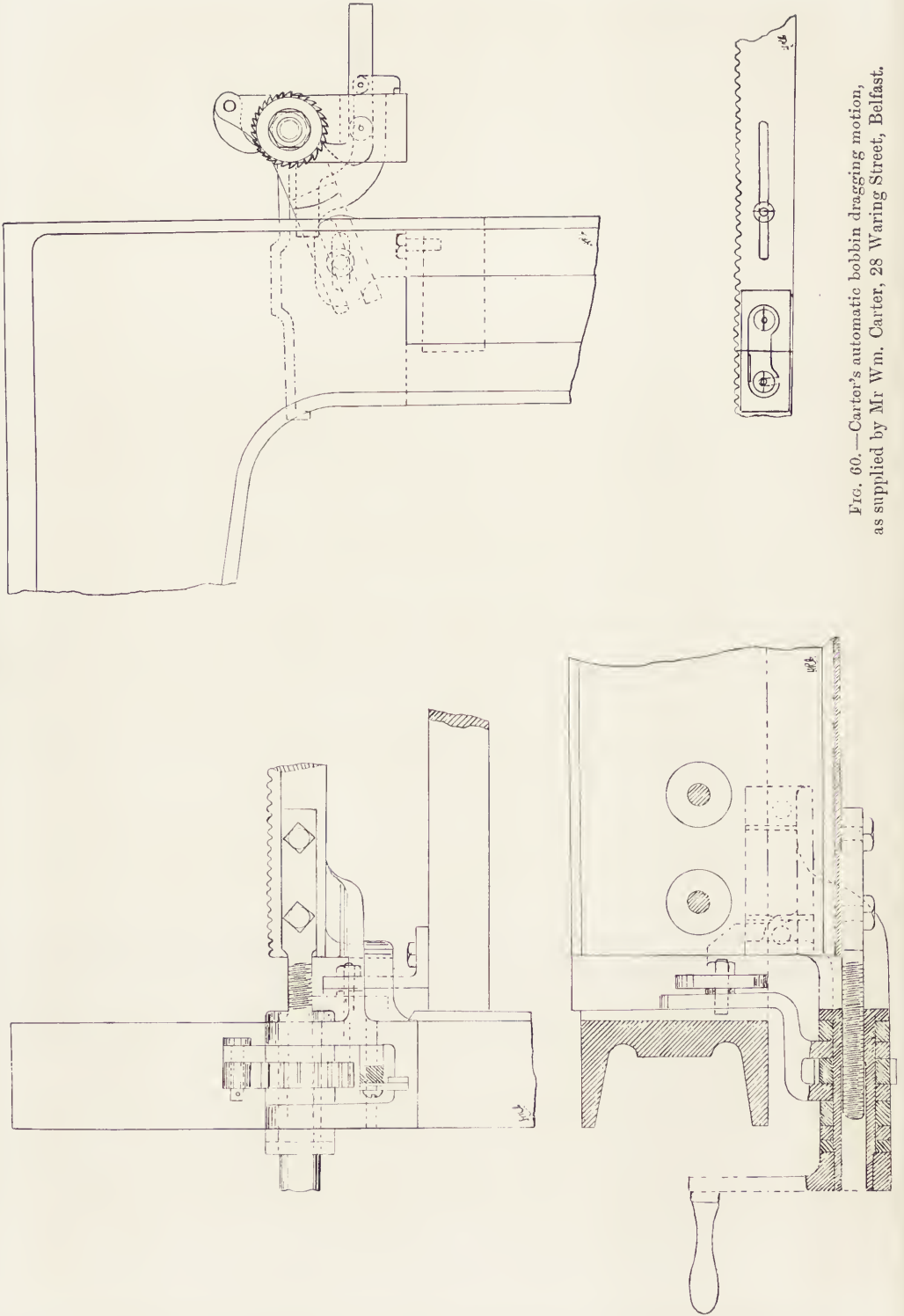

FIG. 60.—Carter's automatic bobbin dragging motion, as supplied by Mr Wm. Carter, 28 Waring Street, Belfast.

As in the gill spinning frame with fish-tail flyers and band or tape-driven spindles, the bobbins of the ordinary dry spinning frame are dragged by means of drag bands which are attached at the back of the builder, touch the base of the bobbin, and pass over a nicked builder strip, the tension being maintained by a drag weight attached to the free end of the band. The drag upon the bobbins is increased by shifting the bands further along on the nicked front builder strip, and in this way causing them to embrace a larger part of the base of the bobbin. This "tempering" of the drags requires some skill, and must be done regularly and uniformly as the bobbin fills and becomes heavier, and as the pull of the thread becomes more effective through acting upon the end of an increasing radial line.

When the bobbins are to be doffed, the drag bands must be set back, out of contact with the bobbin bases, and replaced in light contact with them when the frame is again started. Numerous automatic bobbin dragging motions have been tried and abandoned. In fig. 60 we give a view of the latest, which can be applied to gill, dry or wet spinning frame alike, and which is in use to-day, giving good results.

Carter's Automatic Bobbin Dragging Motion.—It will be seen that the upward motion of the builder is utilised to move round, by means of a ratchet and pawl, an internally threaded sleeve, which forms a nut working upon a screw attached to the front builder strip. The front nicked builder strip is made movable, while the screwed sleeve turns in a bracket attached to the builder, which bracket keeps it in position, so that in turning automatically it draws the nicked builder strip from right to left. As the builder falls the pawl slips over as many teeth of the ratchet wheel as it will move forward upon the return journey, the ratchet being kept from turning the while by the lower catch shown. The pawl may be caused to move forward more or less teeth each time, by shifting backwards or forwards the stud which is carried in a slotted bracket attached to the neck rail, and which works in an open-ended slot in the swinging arm which actuates the pawl. Thus for every two layers of yarn which are put upon the bobbin, the drag is slightly increased, so that the tension of the end remains regular from start to finish of the doff without any attention on the part of the spinner. The result is that there is no ballooning of the ends, that the yarn is built harder upon the bobbin, which consequently contains more yarn, and that the yarn is rounder and stronger, since the fibres lie closer together in consequence of having been twisted together under tension. The handle shown is provided to turn back the screwed sleeve, and in so doing carry back the nicked strip and put the drag bands out of contact with the bobbins for doffing. The handle is also used to wind the nicked strip forward again and bring the bands into contact with the bobbins before starting the frame with a fresh set of bobbins.

Draft Required.—The necessary spinning frame draft required to spin any given weight of yarn, depends upon the weight of rove from which it is to be spun. The weight of the rove may be designated in yards per ounce or in drams per 100 yards. In the former case, if the count of the yarn be expressed in leas or cuts of 300 yards per lb., the required draft is easily found by reducing both yarn and rove to the same denomination, *i.e.* yards per ounce, the draft required being in reality the ratio between the former and the latter. For instance, if we are given rove 30 yards per ounce, and are required to spin yarn 16 leas per lb., we find the yards per ounce in the yarn, *i.e.* $\frac{300 \times 16}{16} = 300$,

and taking the ratio between the two, or dividing the greater by the less, we find that the requisite spinning draft is $\frac{300}{30} = 10$. This rule is

much simplified by taking the yards per ounce in one lea yarn, or 18.75, as a constant number, which if multiplied by the lea required, gives the yards per ounce in that lea, which when divided by the yards per ounce in the rove gives the draft required. Taking the preceding example in this way, we find that the draft required is $\frac{18.75 \times 16}{30} = 10$. If the weight in drams of

100 yards of rove be one of the particulars given, the draft may be found by dividing that weight by the weight in drams of a similar length of yarn. Thus, if 100 yards of rove weigh 60 drams and it is required to spin yarn 10 leas per lb., we must find the weight in drams of 100 yards of 10 lea yarn. We know that in 1 lb. or 256 drams of that yarn there are $10 \times 300 = 3000$ yards, therefore 100 yards of yarn weighs $\frac{256}{30} = 8.53$ drams, and the draft required will be $\frac{60}{8.53} = 7$. This rule may be simplified by taking

85.3, or the weight in drams of 100 yards of 1 lea yarn, as a constant number, and dividing it into the product of the weight of 100 yards of rove and the lea to be spun. Thus, taking the foregoing example in this way we again find the required draft to be $\frac{60 \times 10}{85.3} = 7$.

Drafts may also be conveniently calculated by taking as bases the yards per ounce of rove and the weight of a bundle of yarn (60,000 yards) in lbs. The yards per ounce of yarn are 60,000 divided by the weight of a bundle in ounces, and the required draft the ratio between that result and the yards per ounce of rove. Thus the weight of a bundle of 8's being 25 lbs. and the rove from which it is spun 30 yards per ounce, the yards per ounce of yarn is $\frac{60,000}{25 \times 16} = 150$, and the required draft $\frac{150}{30} = 5$. In practice this rule is

much simplified by making $\frac{60,000}{16} = 3750$, a constant number to be divided

by the product of the weight of a bundle of yarn in lbs. and the yards per ounce of rove—thus $\frac{3750}{25 \times 30} = 5$ draft as before. Following the Scotch system, which is that almost always employed for jute yarns and in which the number of the yarn is denoted in lbs. per spyndle of 14,400 yards, the yards per ounce of yarn is easily found as before, by dividing the yards per spyndle by its weight in ounces, and then the draft required by dividing the yards per ounce of yarn by the yards per ounce of rove. Thus the yards per ounce of 3 lbs. yarn is $\frac{14,400}{3 \times 16} = 300$, to spin which yarn, on 10 of a draft, we will have to be supplied with rove weighing 30 yards per ounce. This calculation is simplified by taking $\frac{14,400}{16} = 900$ as a constant number and dividing it by the product of the lbs. per spyndle and the yards per ounce of rove—thus $\frac{900}{3 \times 30} = 10$ drafts.

The methods of calculation in Continental mills are often found to be identical with the foregoing, although in some cases the English avoirdupois weight is disappearing in favour of the metric system of weight, the base of which is the gramme. The English standard of length or yard and the bundle still remain, and probably will do so, as there is a considerable trade in yarn on both sides between Ireland and Scotland and the Continent. However, as the French metric system of yarn numbering is used to a small extent, we will explain it. Its base is a length of 1000 metres or one kilometre, and the number of the yarn is indicated by the number of kilometres required to weigh 500 grammes. For instance, 5000 metres of No. 5 yarn are required to weigh 500 grammes under the metric system. Since 300 yards equals 274.2 metres, and 1 lb. avoirdupois equals 453 grammes, No. 1 lea yarn Irish equals 3 metric, and No. 10 Irish equals No. 3 metric, and so on. It may be calculated that the weight of 50 metres of No. 1 yarn metric is 25 grammes, and that the weight of 50 metres of any other metric number is 25 grammes divided by that number. The draft required to spin any metric number is easily calculated by comparing the weight of 50 metres of rove with 50 metres of yarn. For instance, 50 meters of No. 5 metric yarn weighs $\frac{25}{5} = 5$ grammes, and if the rove weighs 45 grammes per 50 metres, a draft of $\frac{45}{5} = 9$ will be required to spin it.

If the English unit of length, or yard, be used in conjunction with the metric unit of weight or gramme, a convenient way of calculating the draft from the weight of rove is to divide the weight of 50 yards of rove in grammes by the weight in grammes of 50 yards of the yarn required. Fifty yards being one-sixth of 300 yards, or one lea, and there being 453

grammes per lb. avoirdupois, 50 yards of No. 1 lea Irish weighs $\frac{453}{6} = 75.5$ grammes, and 50 yards of No. 10 lea Irish $\frac{75.5}{10} = 7.55$ grammes. If it be required to spin the latter lea from rove weighing 75 grammes per 50 yards, a draft of $\frac{75}{7.55}$ or 10 will be necessary.

The weight of the rove may be conveniently expressed in leas per lb., and the draft required found by dividing the number of the rove into the number of the yarn. Thus the rove of which we have just been speaking, weighing 75 grammes per 50 yards, is in reality 300 yards per lb., or one lea, consequently the draft required to spin 10 from is $\frac{10}{1} = 10$. The number of any rove may be found by dividing 75.5 by the weight of 50 yards in grammes or by dividing the yards per ounce by 19, or by dividing 85.3 by the weight of 100 yards in drams.

Under the Scotch system of numbering, *i.e.* lbs. per spynkle, the order is reversed, and the draft obtained by dividing the lbs. per spynkle of rove by the lbs. per spynkle of yarn. The former is obtained by dividing 900 by the yards per ounce of rove, for there would be 900 yards per ounce in 1 lb. yarn or rove, or by multiplying the drams per 100 yards by 56. In practice it is necessary to give the yarn a longer draft than that theoretically calculated, since the twist, which is put into it after drafting, shortens or contracts by 1 to 12 per cent., the length delivered by the drawing rollers, and increases by a corresponding amount the weight per unit of length.

The draft, or the ratio between the surface speeds of the feed and drawing rollers of the dry spinning frame, is easily calculated, the wheels and diameter of the rollers being given. For instance—one of Walker's dry spinning frames has a feed roller wheel of 79 teeth working into a stud change pinion of 20 teeth compounded with a stud wheel of 34 teeth, which gears with the boss roller pinion of 30 teeth. The diameter of the top roller is $1\frac{3}{4}$ inches and that of the boss roller 4 inches, so that their relative surface speed or the draft of the frame is $\frac{79 \times 34 \times 4}{20 \times 30 \times 1\frac{3}{4}} = 10.2$. If the draft change pinion be left out of this calculation, a constant number is obtained which, if divided by the draft required, gives the pinion which must be used. Thus in the frame which we have taken as an example, the draft constant is $\frac{79 \times 34 \times 4}{30 \times 30 \times 1\frac{3}{4}} = 204$, which, if divided by the required draft or 10.2, gives the draft pinion as 20.

The twist, in turns per inch, or the number of turns made by the spindles while one inch of drawn rove is being delivered by the boss roller, is found as follows:—

Suppose that upon the other end of the boss roller there is a wheel of 124 teeth gearing through an intermediate with the twist change pinion of 30 teeth which is placed upon a key on the pap of the crown wheel, which has 80 teeth. This latter wheel gears directly with the cylinder pinion, which we will suppose has 22 teeth. The tin cylinder is 9 inches in diameter and the wharve on the spindles $1\frac{1}{2}$ inches, hence the spindles make $\frac{124 \times 80 \times 9}{30 \times 22 \times 1\frac{1}{2}} = 90$ turns for one of the boss roller. The latter is 4 inches in diameter, or $4 \times 3.1416 = 12.6$ inches in circumference, hence the spindles make $\frac{90}{12.6} = 7.1$ turns for every inch delivered by the boss roller, or, in other words, the yarn is twisted at the rate of 7.1 turns per inch. By combining the two last calculations and leaving out the twist change pinion, a twist constant is obtained which, when divided by the turns per inch twist desired, gives, as a result, the necessary twist pinion. Thus in this case the twist constant is $\frac{124 \times 80 \times 9}{22 \times 1\frac{1}{2} \times 12.6} = 214$, which, when divided by the turns per inch twist, or 7.1, gives the twist change pinion of 30 teeth as the result, thus $\frac{214}{7.1} = 30$.

The damping roller for demi-sec spinning is clearly to be seen in fig. 58, lying in its trough of water situated between the drawing roller and the thread plate eye.

A long reach frame is required for ramie or rhea spinning, whether wet or dry, as the ultimate fibres are too long and strong to be drawn upon a short reach. A frame made by Messrs Greenwood & Batley of Leeds is the one most usually employed to spin this fibre. In this frame the distance between the drawing and retaining rollers is divided into three portions by two long rollers with light wooden pressings, which serve to control and render the draft uniform. The damping roller should always be used in the ramie dry spinning frame, as the hairiness of ramie yarn is one of its greatest faults.

Ring spinning is almost universally employed for ramie, since that fibre presents none of the difficulties in the shape of shove, etc., which have led to its almost complete abandonment in flax and tow spinning.

Twisting on the Ring Frame.—The theory of twisting on the ring frame is quite different from anything hitherto described. The winding of the thread upon the bobbin is done in the same manner as it is in the roving frame when the bobbin leads (see p. 139). In this case there is no flyer, its place being taken by the traveller, which is free to move round the ring. If every minute a length equal to the product of the speed of the bobbin or spindle and the circumference of the former were delivered by the rollers, the traveller would remain stationary upon the ring and the

yarn would consequently receive no twist, but be merely wrapped upon the bobbin.

As in flyer spinning, the amount of twist may be regulated by altering the speed of the delivery roller, that of the spindles remaining constant. When every minute a quantity *less* than the surface speed of the bobbin is delivered to the spindle, it is taken up by the bobbin as before and the traveller pulled round upon the ring to compensate for what is wanting in length. Each revolution of the traveller round the ring puts one turn of twist into the thread, so that if the traveller makes twenty revolutions while one inch of yarn is being delivered, we say that the latter is receiving twenty turns per inch twist. From what we have said it will be seen that the twist which is being put into the yarn at any moment depends upon, or is affected by, the diameter of the bobbin at the point of winding on. This diameter of course varies from that of the empty bobbin or tube to that of the full pirn or eop. This is the objection which is most frequently urged against the use of the ring frame, yet if the variation in twist thus caused be carefully studied, it will be found in practice to be so small as to be unworthy of consideration. Suppose, for instance, that the roller delivers 14 yards = 504 inches per minute, and that the smaller diameter of the pirn is $\frac{1}{2}$ inch and the larger $1\frac{1}{2}$ inches, while the yarn is being wound upon the smaller diameter, the traveller will make $\frac{504}{\frac{1}{2} \times 3.1416} = 321$ revolutions per minute *less* than does the spindle, and when the larger diameter is opposite the traveller, the latter will make $\frac{504}{1\frac{1}{2} \times 3.1416} = 107$ revolutions *less* than the spindle. If the speed of the spindles be 4000 revolutions per minute, the maximum speed of the traveller will be $4000 - 107 = 3893$ revolutions per minute, putting in $\frac{3893}{504} = 7.7$ turns per inch twist, while its minimum speed will be $4000 - 321 = 3679$ revolutions per minute, putting in $\frac{504}{3679} = 7.3$ turns per inch twist, a variation of $7.7 - 7.3 = 0.4$ turn per inch, which is equivalent to a little over 5 per cent. The variation is, of course, less marked in finer and harder twisted yarns.

Ring spun yarn is almost invariably built upon a pirn or tube in eop form, which lends itself very conveniently to winding off endwise and without strain. The pirn build referred to is effected by giving the builder plates, in which the rings are set, a slow and short upward traverse with a return about three times as quick, in order that every alternate row may be wound in a spiral of comparatively greater pitch, forming a binding thread to keep the yarn from ravelling off while winding or weaving directly from the eop.

Ring spindles may be run much quicker than flyer spindles, since they

are not top-heavy and may be constructed on the Rabbeth principle. The best rings are rolled from solid steel without weld, great care being exercised in making them perfectly cylindrical. They are fixed in the ring, rail or builder in such a manner as to preserve the perfect circle. The friction of the traveller upon the ring is the chief difficulty experienced in ring spinning. When increased by the presence of dust and shove or water, it has led to the abandonment of the system, as in the case of flax and tow spinning, both dry and wet. The rings should be regularly oiled, and care must be taken that the diameter of the rings used does not bear too high a ratio to the smallest diameter of the tube, and that the weight of the travellers is suitable for the yarn being spun. When the yarn in passing from the traveller to the bobbin becomes the tangent of a comparatively small circle, and when the tension on the yarn at this point is split up into its component factors—*i.e.* a force pulling towards the centre of the ring and another pulling the traveller round the ring—it will be found that the latter force is comparatively small, hence it is that spinning on to the bare spindle is extremely difficult, and that when spinning on to a bobbin, the end generally breaks when it is being wound on to a small diameter. For this reason it is advisable to stop and start the frame when winding on to a large diameter.

In calculating the turns per inch twist upon the ring frame, it is usual to ignore the fact that the speed of the traveller is rather less than the speed of the spindle, so that this item may be found as in flyer spinning.

Ring frames are much more easily doffed than are flyer frames, since there are no flyers to be screwed off and on. The yarn does not drag the bobbin round, hence more yarn may be put upon the spindle than is possible in flyer spinning when the size of the bobbin is limited.

Experiments are now going on with a frame which, while possessing all the advantages of a ring frame, will, it is hoped, overcome all the difficulties hitherto encountered in employing that frame in the spinning of flax, hemp, tow and jute. The following are the main features of the frame to which we refer. The yarn may be wound in either cop or bobbin form. The step rail is lifted by the ordinary builder motion for ring or flyer frame winding. The spindle passes through a long collar, which protrudes on the upper side of the neck rail, and on a feather, through the wharve and the base of an open cup, which forms one piece with the wharve. The bobbin is fixed on the spindle and moves with it up and down, inside the above-mentioned cup. Upon the lip of the cup is a sort of flange, upon which turns a ring which has two eyes fixed in its upper edge. This ring is kept in place by an elastic ring, which is sprung into the interior of the cup, and which has upon it projections, half of which engage in a groove in the inside of the cup, and the other half with an inside flange in the revolving ring. The lower part of the wharve forms a sleeve which slips

over the outside of the collar fixed in the neck rail, and forms the bearing upon which the cup is turned by the band passing round the wharve. The surfaces in contact work in an oil bath, for around each spindle is a cup forming part of the neck rail and containing oil.

Attached to the neck rail, back and front, are supports projecting upwards to the height of the revolving ring, their tops being horizontal with it. The drag bands are attached to the support at the back, and passing round a groove in the ring, hang over the front support and afford a means of retarding to the required degree the revolution of the ring with the cup. Were the ring to revolve at the same speed as the cup, spindle and bobbin, no winding would take place, but its motion is just sufficiently retarded to cause the bobbin to wind the yarn upon itself.

The strain upon the yarn is then very slight, and it is hoped that a fine yarn may be spun without difficulty upon a bobbin, holding from one to two thousand yards, and that the bobbins may be doffed as filled without stopping the frame, which should mean a high production.

CHAPTER XIII.

THE WET SPINNING OF FLAX, HEMP, AND RAMIE YARNS.

The Wet Spinning Frame.—Figs. 61 and 62 show the usual form of wet spinning frame used for spinning flax, hemp, and tow yarn. The bobbins, full of rove, are brought from the roving frame and placed upon wooden or wire skewers A in the creel B C D, fig. 61. Brass or porcelain footsteps are inserted in the planks C and D, which support the skewers and bobbins, in which steps the points of the skewers turn freely, while they are supported in a vertical position by the staples E, or in holes in the plank above. The creel must be made wider if the frame is to be used for spinning "double rove," for in that case double the number of bobbins must be put in the creel at one time in order that there may be two ends per spindle instead of one. The rove passes from the bobbin, as shown, over the brass guide rod F, which should direct it in such a manner that it passes between the back of the trough G and lid H (without rubbing against either) and round another rod, I, which is placed near the bottom of the trough T, containing water at a temperature of from 100° to 170° F. The rod I is placed low in the trough in order that the rove may be kept as long as possible under the action of the hot water and be sufficiently macerated. The trough is supplied with water and steam by feed-pipes connecting it with the main supply pipes which pass above the frames. The proper position of the steam pipe in the trough is shown at J. Since heated water rises, the pipe J must be placed low down and far enough from the line of the rove to prevent the latter from being scorched.

From the rod I the rove is drawn by the feed-rollers K, over the lip L of the trough and rove guide M. The object of the latter, which is given a slow and short reciprocating horizontal motion by an eccentric moved by a worm wheel and worm upon the end of the feed roller K, is to cause the rove to traverse backwards and forwards over the face of the roller so as to distribute the wear pretty equally over its surface, and in this way increase its life. Were the rove to remain in one place upon the roller a track would soon be created which would prevent the roller N drawing as it should. N is the boss or drawing roller, moving at from four to sixteen times the surface speed of the feed roller K, and effecting, by the aid of the pressing rollers O

and P, an equal amount of drawing out or drafting. The rollers O K N are all brass covered, but the drawing pressing roller P is of wood, india-rubber or guttapercha. All these rollers are fluted to a pitch varying with the coarseness of the frame, and lying between 20 and 40 flutes per inch in diameter. The quality of the brass which covers these rollers,

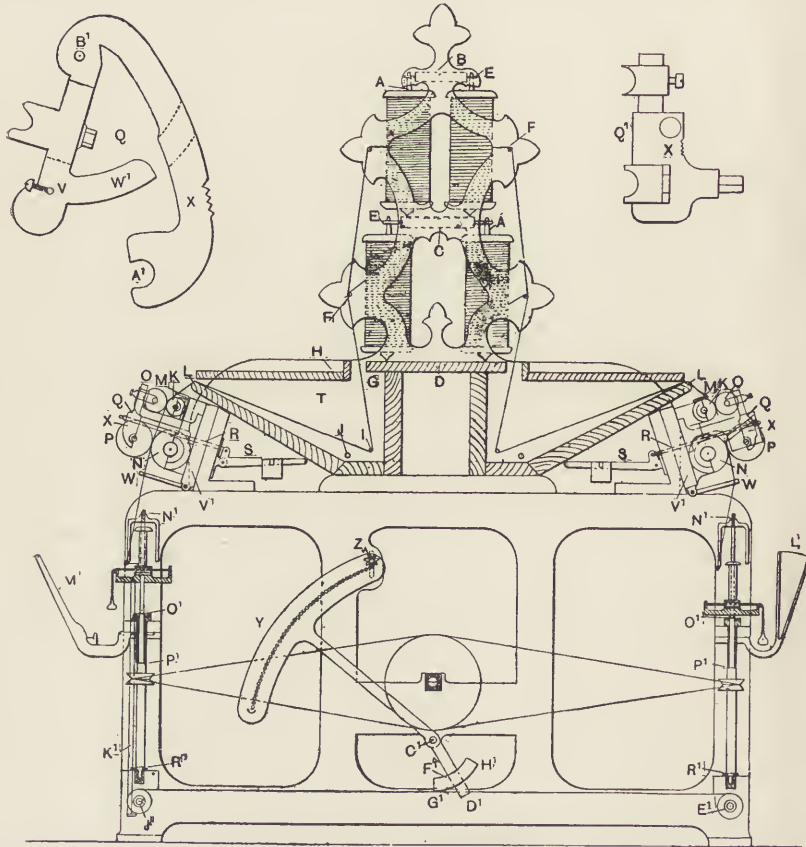

FIG. 61.—Section of wet spinning frame for flax, hemp or tow.

and the method of casting, are of great importance, especially for fine spinning. The metal must be close-grained and of equal density throughout, for blowholes and other flaws cause the flutes to be imperfect and prevent them from drawing properly. Most of the makers have special mixes and methods of casting, while in the same cases the bosses are compressed under great pressure while on the roller. The pressing rollers O and P are in pairs, upon either end of short axles. The means by which they are pressed against the feed and drawing rollers, which are in one long

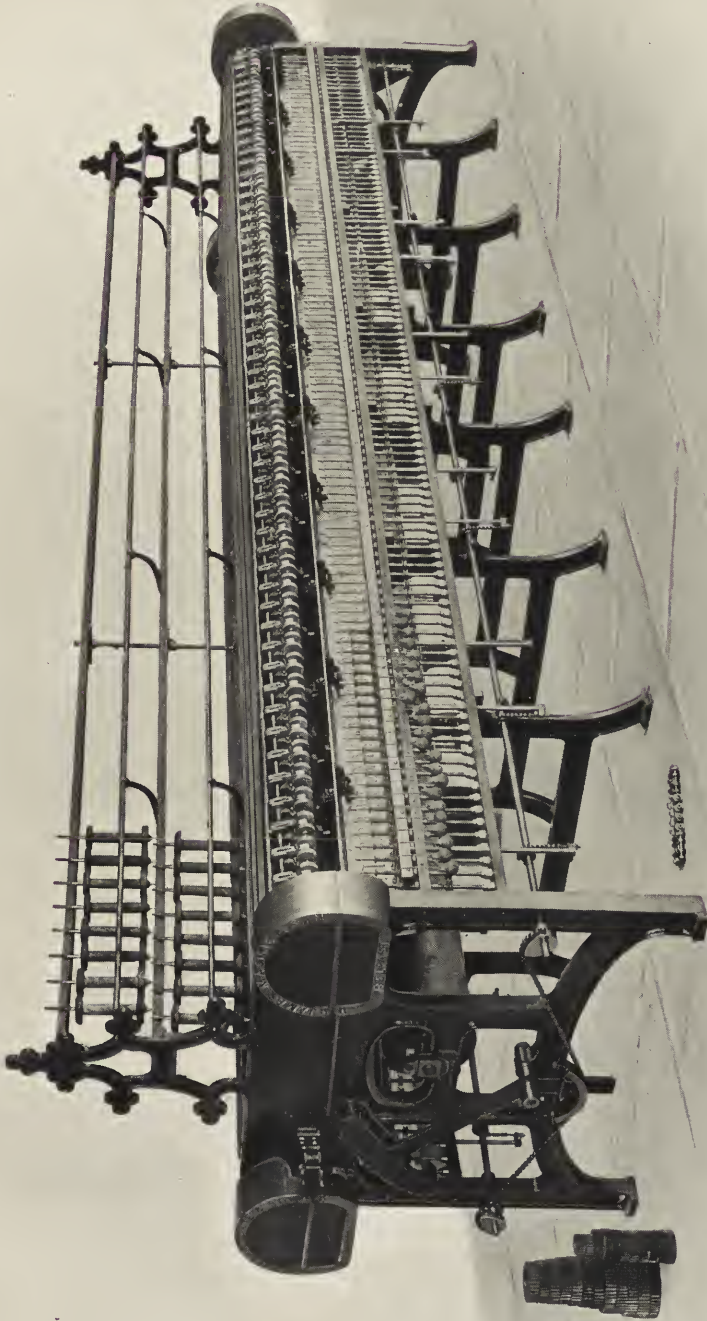

FIG. 62. — Wet spinning frame for flax, hemp or tow, as made by James Mackie & Sons, Ltd., Belfast.



length, is clearly shown. Q is a piece of brass, called the "saddle," having two bearings, which embrace the journals between each pair of pressing rollers. A pull is brought to bear upon it through the wire R, one end of which is attached to the short arm of the lever S, while the other passes through the saddle, which is tightened up by a nut upon the screwed end of the wire R, a washer or collar, called the "humbug," being interposed between the nut and the saddle.

A weight is placed upon the long arm of the lever, as shown, in a position necessary to give the required pressure, which varies from 60 to 180 lbs. The figure shows the frame fitted with rollers of an ideal size, under which conditions the lever is exerting its force most efficiently, the spring wire R being at right angles to the saddle and pressing the feed and drawing rollers directly into their bearings. Under these conditions the force exerted is distributed between the top and bottom rollers in quantities inversely proportional to the length of the perpendiculars let fall from their centres upon the wire. Since the feed roller with its bearing is frequently screwed up and down in order to lengthen or shorten the length of reach, or distance from the nip of the top roller to that of the bottom one, it follows that while the perpendicular distance of the centre of the drawing roller from the spring wire remains constant for the same size of bottom pressing roller, the length of a similar perpendicular from the centre of the feed roller varies with the reach. For this reason the effective pressure upon the feed roller diminishes with the length of the reach, or *vice versa*, while that upon the drawing roller is increased, or the reverse, in a like degree.

The size of the bottom pressing roller likewise materially affects the distribution of the pressure of the lever and weight between top and bottom rollers, for if the triangle of forces be studied, it will be seen that, the saddle being no longer perpendicular to the spring wire, the bottom roller receives a larger percentage of the pressure applied, part of which, however, is generally lost in pressure of the saddle against its stand. It may be said that, although the saddle and stand have been the subject of innumerable patents, they are a practical detail in spinning machinery which is still open to improvement. We show a few of the leading types in detail. They may be broadly classified into armless and armed saddles, the former being supported and kept in place by a single central stand, while the latter require a double stand, such as is shown on the right hand side of fig. 61. The advantage of an open or single stand is the additional room and freedom secured for cleaning, etc. Many spinners prefer a double or closed stand, because, if the stand be well spaced and the pressing roller axle of an exact length, the wooden or guttapercha rollers cover the brass bosses properly, enabling the boss roller to be run much longer without refluting. The bad practice of side and over the roller piecing, which is quite easy with an

open stand, is moreover rendered difficult, and often impossible, with a closed stand. The saddle Q' , shown in detail and detached at the right of the figure, is an armed saddle which is superior to that designed in the right hand side of the frame itself, for the reason that the bearing for the bottom pressing roller may be serewed in and out with the object of keeping the saddle perpendicular to the spring wire with every size of pressing roller, for the reason already given. In both of these saddles the top pressing roller seat may be shifted up or down to keep the point of contact of the rollers constant, whatever may be the length of the reach.

Another advantage which the armed saddle has over the armless one, is that the groove, cast in the stands at either side to receive the ends of the saddle arms, may be made at such an angle or curve that the point of contact of the bottom rollers may also be kept constant, whatever the size of the pressing roller. In all classes of saddles the angle of the spring wire and the saddle itself may be further adjusted, to a small extent, by shifting the point of the humbug in the nieks made to receive it, and shown in the enlarged saddles to the right and left. The small saddle shown to the left, in the frame, is an armless saddle, similarly constructed in other respects to those already described. It has the practical disadvantage of occasionally permitting the rollers to wear to one side or the other. The enlarged saddle to the left is perhaps the best of two-piece saddles. We will describe it rather minutely, as the theory of its leverage is interesting. It is supported in a single stand, in which its short arm is pivoted at V . The short arm carries the top roller bearing, and the long arm is pivoted to the upper extremity of the first, and carries the bottom pressing roller bearing. The spur W' on the short arm passes through the long arm, and makes the combination more rigid. The spring wire passes through the saddle at X , and is serewed up with a nut and humbug in the usual way. If the combination be studied, it will be seen that in the first instance the long arm acts as a lever of the first kind, the pressure applied at X being distributed between the points A and B' in inverse proportion to their perpendicular distance from the spring wire. The short arm of the saddle will now be seen to be a lever of the second kind with its fulcrum in the pin V , while the force is applied at the point B' against the resistance offered by the top pressing roller at a variable distance from the fulcrum V . This saddle has several structural defects which prevent the point of contact of the bottom pressing and boss rollers from being kept constant. Difficulty is also sometimes experienced in working with small pressing rollers, while with a long reach the pressure upon the retaining rollers is frequently insufficient.

Leaving the drawing rollers P and N , the thread passes to the action of the flyer and spindle, being steadied in its passage through the eye of the thread plate W . The thread plate eye is a round disc of brass riveted in a corresponding hole in the cast iron thread plate which is pivoted as

shown, to enable the bobbins to be readily doffed from the spindles. A small round hole is bored in the brass disc, into which hole the thread is inserted through a slanting or tangential slot communicating with the outer edge of the plate. This slot is cut in such a direction that the end does not tend to fly out while being twisted. The arrangement of the spindle and flyer is very similar to that of the dry spinning frame described in our last chapter. The flyer is screwed upon the top of the spindle in such a direction that resistance to rotation tends to tighten it. The flyer eye, being quickly cut by the hard and well-dragged thread, is of brass wire soldered into the hollow end of the flyer leg and turned into a curl. The bobbin is placed upon the spindle and rests upon the builder, being "dragged" by a cord which extends across the latter, from back to front, and carries a leaden weight at its extremity, as shown. Either the side or top of the front edge of the builder is nicked to hold the cord in the desired position, the drag being "tempered" or regulated by hand, or by the automatic bobbin dragging motion, fig. 60, as the bobbin fills, causing the drag band to embrace a larger section of the grooved base of the bobbin. The weight of the drags varies from one ounce for the finest yarns to sixteen ounces or more for heavy numbers.

An up-and-down traverse is given to the builders by means of the quadrant Y, turned by the small pinion Z on the end of the long shaft extending from the other end of the frame. The circular segment of the quadrant, which is only a quadrant in name, is set with one row of round brass pins, which serve as teeth, upon either side of which the teeth of the small driving pinions act. A semicircular guide at either end of the row of teeth causes the pinion to move round to the other side, which it is free to do, its shaft not being rigidly held, but moving in a slot, as shown. The quadrant turns upon a stud at C' and has a tailpiece, C' D', which, if the driving pinion cannot be placed in the centre of the frame, must make a suitable angle with the long arm of the quadrant, so that, while in motion, it makes similar angles on either side of a vertical line drawn through its rocking centre. The reason of this condition is that the builder shafts J' and E' are given a reciprocating rotary motion by means of adjustable chains attached to bosses upon their ends, and to a circular segment F', upon the tailpiece of the quadrant. The simplest way to obtain an absolutely uniform motion for the builder is to have the chains E' G' and J' H' always horizontal. This, however, is not always practicable, if the traverse of the builder has sometimes to be lengthened or shortened by moving the segment F' up or down upon the tailpiece C' D' of the quadrant.

Inconveniences of this sort may be avoided, or bobbins of special shape built, by the use of cam-shaped pieces or "irons," instead of round bosses upon the end of the builder shafts. Thus, for instance, a bobbin with a

large base and a small head may be used, and a large quantity of yarn placed upon it by building the said yarn in a large measure towards the base of the bobbin, by increasing the speed of the builder as it approaches its lower position, and *vice versa*. In explanation we may say that if the head of the bobbin be too large, the end will rub against it and cause breakages or fraying of the yarn. The capacity of the bobbin may be increased by giving the full bobbin a swell in the middle, by giving the builder a slow motion near its central position, and quickening that motion towards either extremity. The reciprocating rotary motion of the builder shafts is changed into a vertical up-and-down motion and communicated to the builder itself through rods K', known as "poker rods," one end of each being tapered and inserted in a taper hole in the builder, while the other end is attached to a short chain wrapped round a small boss upon the builder shaft. The reciprocating rotary motion of this latter shaft thus wraps on and lets off the short chains and raises or lets fall the builder, that on one side of the frame rising while the other descends. Flyer frames are at present at work building cops or pirms with a quick and short up-and-down traverse, as in the ring frame described in the last chapter. Two forms of splash boards are shown at L' and M'. The object of this accessory to the wet spinning frame, the use of which is rendered compulsory by law in some countries, is to protect the spinners from the spray thrown off by the revolving flyers, which in a coarse frame is of considerable density. It consists of strips of sheet iron, etc., supported in brackets of various forms, the chief qualifications of a good splash-board being ease in lifting out for cleaning and freedom to move forward to enable the spinner to reach her creel with facility. The spindles are driven in the ordinary way by bands from a single tin cylinder, as shown. The most suitable banding for wet work is coated with a red composition to protect it from the damp, and is composed of three strands of three to six threads of about $2\frac{1}{2}$'s cotton, made from long-stapled fibre. Tapes are also sometimes used for heavy work. They necessitate the use of a tension pulley and a wharve of different construction to that shown. The proportion of the tin cylinder to the wharve, as regards diameter, is usually about ten to one. To keep the spindle from jumping and the step from being unduly worn, the wharve should be shrunk upon the butt in a horizontal line with the centre of the tin cylinder. A well-proportioned spindle should have the length of its blade, N' O', two and a half times the pitch of the frame, or the traverse of its bobbin, or about a third of the total length of the spindle. The length of the neck, O' P', should be about half that of the blade. The butt P' R' is an inch or two longer than the blade. The diameter of the blade varies from $\frac{1}{5}$ to $\frac{1}{2}$ inch, the neck being about $\frac{1}{8}$ inch larger in diameter and the butt $\frac{1}{4}$ inch more than the blade. The wharve, besides being horizontal with the centre of the tin cylinder, should be upon the balance point of the spindle

in order to secure steady running. The angle of the rollers and the position of the latter in relation to the spindle and thread plate are important in consequence of the effect they have upon the strain put upon the yarn while spinning. The distance which the face of the delivery roller N stands back from the line of the spindle is termed the "projection," and varies from $\frac{1}{2}$ to $1\frac{1}{4}$ inch according to the strength and number of the yarn and the pitch of the frame. When the line of the spindle projects much beyond the face of the roller, a considerable strain is put upon the end, and *vice versa*. The thread plate eye must be absolutely vertically above the spindle top, and the plate itself, which should be high enough above the spindle to permit the spinner to insert her hand between the plate and flyer in order to stop the latter, should also be at right angles to the line of the thread between the thread plate eye and the point of delivery from the roller. The rollers may be advanced or retired with their seats and the beam V', which extends the whole length of the frame. The following table gives suitable settings for frames of various pitches:—

Pitch of Frame.	Bottom of Spindle Screw to Nip	Distance back from Line of Spindle.	Angle of Beam.	Angle of Rollers.	Distance from Spindle Screw to Thread Plate.
inches.	inches.	inches.	°	°	inches.
4	$9\frac{3}{4}$	$1\frac{1}{4}$	17	19	$3\frac{3}{4}$
$3\frac{1}{2}$	$8\frac{3}{4}$	$1\frac{1}{8}$	17	19	$3\frac{1}{4}$
3	$7\frac{3}{4}$	1	16	18	$2\frac{7}{8}$
$2\frac{3}{4}$	$7\frac{1}{4}$	$\frac{7}{8}$	16	18	$2\frac{5}{8}$
$2\frac{1}{2}$	$6\frac{3}{4}$	$1\frac{3}{8}$	15	17	$2\frac{3}{8}$
$2\frac{1}{4}$	$6\frac{1}{4}$	$\frac{3}{4}$	15	17	$2\frac{3}{8}$
2	$5\frac{3}{4}$	$1\frac{1}{8}$	15	17	2
$1\frac{3}{4}$	$5\frac{1}{4}$	$\frac{1}{2}$	15	17	2

The pitch of a frame is the distance from centre to centre of the spindles, and indicates the fineness of the frame. The line of angle of the rollers should be a prolongation of that drawn from the thread plate eye to the nip of the drawing rollers, in order that the end as delivered may not rub unduly upon either brass or pressing roller. The points of contact of the top and bottom brass rollers with their pressing rollers should be such that the lines joining their centres may cut the line from the thread plate eye, which touches the surfaces of both top and bottom brass rollers, at right angles.

The woods most used for pressing rollers are boxwood, willow, pear tree, thorn and beach, the former being suited to fine work, while the latter serves the purpose for frames of coarse pitch. Pure guttapercha, often costing 7s. 6d. per lb., is almost universally employed in the medium and coarse Continental trade, while vulcanised indiarubber forms a serviceable roller for tow spinning. When the brass roller has been well covered

by the pressing roller, it should work for seven or more years without refluting. The overlapping edges of the pressing roller soon become high, gather a great deal of dirt, and eventually necessitate the refluting of the boss. Pressing rollers of the same width as the brass bosses will work much longer and produce cleaner yarn, but until some plan is devised to keep top and bottom bosses accurately in position, the old method must continue. This is a detail in which the spinning frame is open to improvement, and we would recommend it to the attention of practical men.

The following table gives the pitch of frames upon which the various numbers may be most conveniently spun, together with the ordinary reaches, diameter of rollers, and flutes per inch in diameter:—

Range of Numbers.	Pitch of Frames.	Range of Reaches.	Top Roller.		Bottom Roller.		
			Diameter.	Flutes per Inch in Diameter.	Diameter.	Breadth of Face.	Flutes per Inch in Diameter.
	inch.	inches.	inch.		inch.	inch.	
8's to 16's lea,	3	5 to $2\frac{3}{4}$	2	16	$3\frac{3}{4}$	$1\frac{5}{8}$	20
12's to 25's lea,	$2\frac{3}{4}$	$4\frac{1}{2}$ to $2\frac{3}{4}$	$1\frac{1}{4}$	20	$3\frac{1}{4}$	$1\frac{3}{8}$	24
20's to 30's lea,	$2\frac{1}{2}$	$3\frac{1}{2}$ to $2\frac{1}{2}$	$1\frac{1}{3}$	24	$2\frac{3}{4}$	$1\frac{1}{4}$	30
30's to 40's lea,	$2\frac{1}{4}$	3 to 2	$1\frac{1}{4}$	30	$2\frac{1}{4}$	$1\frac{1}{4}$	32
40's to 60's lea,	$2\frac{1}{5}$	$2\frac{3}{4}$ to 2	$1\frac{1}{4}$	30	2	$1\frac{1}{4}$	32
60's to 90's lea,	2	$2\frac{1}{2}$ to $1\frac{3}{4}$	$1\frac{1}{8}$	32	$1\frac{3}{4}$	$1\frac{1}{3}$	36
90's to 140's lea,	$1\frac{3}{4}$	2 to $1\frac{3}{4}$	1	36	$1\frac{3}{4}$	$1\frac{1}{8}$	40
140's upwards.	$1\frac{1}{2}$	$1\frac{3}{4}$ inches.	$\frac{7}{8}$	40	$1\frac{3}{4}$	$1\frac{1}{8}$	40

If the reaches be not too short and the rollers are in fair order, it will be found that pressure varying from 140 lbs. on 3-inch frames to 100 lbs. on $1\frac{3}{4}$ -inch frames will give good results. The pressure is usually distributed between the drawing and retaining rollers in the proportion of about 2 to 1 respectively.

The height of the thread plate should be such that when the builder is at its highest point, a line drawn from the flyer eye to that of the thread plate should clear the head of the bobbin. The distance of the point of delivery of the yarn from the eye of the flyer varies from 7 inches in a fine frame to, say, 11 inches in a coarse one. The effective length of the flyer leg should be rather greater than the traverse of the bobbin plus the thickness of its head, and for a similar reason the length of the spindle blade, upon which the bobbin traverses up and down, must be at least equal in length to the over all length of the bobbin plus its traverse.

The flyer is of solid steel. Its head is tapped to screw upon the spindle top. It has two arms or legs, from outside to outside of which must be less than the pitch of the frame, the inside measure being sufficient to

clear a full bobbin of yarn. A wide flyer puts additional strain on the end in its passage through the thread plate eye, for which reason, when spinning wefts, it is advisable to use a narrow flyer, and consequently a bobbin with a small head. The top or head of the flyer is either closed or open. Those who believe in the first-named pattern hold that a closed head prevents dirt and water from getting upon the screwed spindle top. An open-topped flyer has the advantage that the head may be more perfectly tapped.

The nature of the material and of the flax spinning frame has prevented the attainment of such high spindle velocities as are now possible in the cotton frame.

Unlike a ring spindle, the flax throstle spindle must be rigid and have a sufficiently heavy butt end to balance it. The spindle "foot" rests in a brass footstep set in the "step rail." The neck works in a long collar set in the "neck rail." That part of the spindle between the neck and step rails is termed the spindle butt, and it is there that the wharve is fixed. The butt is of larger diameter than the neck, so that a collar is formed which, running against the brass tube or collar proper, prevents the spindle bouncing up and down, if it is inclined to do so. If the wharve is placed at a proper height in relation to the tin cylinder, which gives motion to the spindles through cotton bands, there should be no tendency to jump on the part of the spindles. The total length of the spindle is from 14 to 21 inches, according to the pitch of the frame. It weighs 9 to 25 ozs.

The wharve has usually a V-shaped groove for a cotton band, such being quite sufficient for medium and fine frames. Coarse frames, with heavy spindles, are often driven by tapes about an inch in breadth. Such a drive is inconvenient, since it necessitates the use of tension pulleys to maintain the driving tension of the bands. "Capstan" wharves are rather to be recommended for coarse work. Such a wharve is deeper, and has a shallow and broad groove around which the cord is wrapped twice, and in this way insures a good drive.

The tin cylinder which forms the driver of the spindles, on both sides of the frame, is usually 10 to 12 inches in diameter. If the frame be long, or if there be no means of inserting a long length of cylinder when once the frame is erected, it is made in two or more sections which are united together by socket joints provided with projecting lugs which engage and cause the sections to turn together. A few inches are left between each section, the short axle between them forming a journal, which may be supported by a bearing upon a cross beam. Needless to say, these central bearings must be kept well oiled and accurately lined up, or else they will be the cause of many broken cylinders.

The side of the spindle banding running on to the tin cylinder may be placed either to the right or left hand side of the wharve, turning the

spindle so as give either right or left hand twist to the yarn. As we have found that the term "right and left hand twist" is not everywhere understood in the same way, we may state that we here understand that the yarn has received right hand twist when the end twisted in the direction of the hands of a clock tends to become harder. In spinning, the yarn is twisted in this direction when the flyer, as looked at from above, turns in a contra-clockwise or negative direction. In ordinary weft spinning, the spindle and flyer turn in a positive or clockwise sense and put in left hand twist. It is only for special purposes that right hand twist is required, such as occasionally for sewing threads, for instance, where it is desired to give the thread its final twist in any special direction. Right hand and left hand twisting can only be done upon the same frame when the spindle tops upon which the flyers are attached are specially provided with a right hand and a left hand thread, the reason being that the flyer must be screwed on in the opposite direction to the revolution of the spindle, otherwise it will fly off.

In setting the traverse of the bobbin to the flyer eye, at the lowest position of the builder, the yarn should be delivered from the flyer eye and wound directly upon the bobbin barrel at a point quite close to the head of the bobbin. Similarly, when the builder is at its highest point, the thread should be wound upon the barrel close to its base. Since with the quadrant there must always be a short "dwell" in the motion of the builder as it changes direction, or as the quadrant pinion turns the last tooth in the rack, it is often found advisable to shorten the traverse by a fraction of an inch, leaving a small clearance space at each end of the bobbin barrel to accommodate the slight accumulation of yarn at this point caused by the "dwell" in the motion of the builder.

The bobbin is of wood such as boxwood, teak, mahogany, sabicú, etc., with top and bottom flanges. The former, or head, is not so deep as the latter, or base, which requires to be grooved for the drag band. The portion between the head and base is called the barrel. It is usually parallel and of a diameter superior to that of the spindle, which passes through it by an amount sufficient to give it resistance without unduly diminishing the yarn-holding capacity of the bobbin. The diameter of the bobbin barrel is sometimes slightly increased just at its junction with the ends, so that if the builder be rather defective through wear, by shortening the traverse slightly, a bobbin is built which may be wound off with an ease which would be lacking were the bobbin of the ordinary form. The bobbin barrel is bored out a close, but easy, fit for the spindle. Its interior is chambered to reduce the bearing and friction surface on the spindle blade. The walls of this chamber must be left sufficiently thick to preserve the requisite strength of the barrel. Boxwood is a fine-grained, hard and heavy wood, almost universally employed for small bobbins for

fine yarn. It is too heavy for the larger bobbins, so the lighter woods are employed as the size of the bobbin increases. Teak is a hard wood of rather open and cane-like structure. Bobbins made from this wood are thought to wear the spindle blade more than those of other species. Some spinners attribute this to the presence of sand in the pores of the wood, a supposition we are not disposed to confirm. Boxwood, we believe, gives the best working surface upon the spindle blade, for which reason this wood is often used to "bush" the bore of bobbins made of the lighter and softer woods. The size of the bobbin is proportionate to the pitch of the frame upon which it is to work. As a general rule the length of the traverse or barrel may be equal to the pitch of the frame or the distance from centre to centre of adjacent spindles, while the diameter of the head and base may be taken to be half the length of traverse.

Modification in the form of the bobbin may be made to suit special work, or with a specific object. For instance, if in spinning a weak weft yarn we use narrow flyers in order to reduce the strain put upon the end by the thread plate, we must also have a small-headed bobbin. In order that the bobbin may still contain the same quantity of yarn, we will have to lengthen the traverse or bobbin barrel. Or again, if for strong warp yarns we desire to get an additional drag upon the bobbin, we may provide the latter with an exceptionally large base, giving an increased friction surface for the drag band.

Having mentioned the subject of drag upon the bobbin, we may say that its intensity should be all that the yarn will stand, for besides augmenting the length which may be wound upon the bobbin, it increases the smoothness and strength of the yarn very materially in drawing the fibres into closer contact. If hard fibre be not perfectly drawn by the rollers, a heavy drag will often prevent the presence of "beads" in the yarn. A "bead" is caused by the presence of hard fibre whose component parts the rollers have been unable to draw out and separate. Around the central fibre are gathered others, which form a lump devoid of twist, a weak point and grave defect in any yarn.

Starting and Working a Frame.—Having described fairly minutely the working parts of a wet spinning frame, we will proceed to explain how such a machine is started as a yarn producer. Given a new frame, or one in which the old rove has been broken out for repairs, changing, cleaning, etc., the rove bobbins must be replaced in the ereel, the ends drawn over the rove rods, down between the back of the lid and trough, under the bottom rove guide, over the lip of the trough, and placed in position to be inserted in the nip of the feed roller when the frame is started. The water is then turned on and the trough filled to the required level, when the steam valve may be opened and the water raised to the required temperature. The frame may then be started and the ends of rove

inserted singly between the rollers by the spinner, "layer" or "piccer-up." The drawn end as delivered laps round either the boss or pressing roller, from which it is easily removed if the latter be kept well moistened.

There are two ways of attaching the newly formed yarn to the bobbin—*i.e.* either by "piecing up" or by "laying on." To accomplish the former, the worker is provided with a bobbin of yarn. Placing her left hand upon the top of the spindle and flyer, she stops them, and taking the end of the yarn with which she is provided, she places it in the flyer eye and carries it through the eye of the thread plate. Releasing the flyer, the end is lapped upon the bobbin, the latter being pulled round at the speed of the spindle as long as the other end is held. Breaking off the thread which she holds, from the bobbin, she transfers the end to her left hand and holds it near the extremity between her finger and thumb. Then with her right hand she takes the waste from the roller, and drawing the drawn and untwisted rove downwards at the speed at which it is being delivered, she adroitly unites it with the end which she holds in her left hand, which end she allows to slip through her fingers and twist in with the rove as delivered. This is practically the method by which the spinner pieces up a broken end in the ordinary way, the only difference being that, instead of placing a fresh end upon the bobbin, she must, if possible, find the broken end and, pulling off a sufficient length, thread the flyer and thread plate eyes and piece up the end as described. Needless to say, the process is much more difficult to execute than to describe, and requires years of practice. Laying on is still more difficult, and is only possible at slow or moderate speeds. It is effected by taking the end of rove as delivered from the boss roller, and by a quick motion of the hands twisting it into a thread between the palms. The thread, when formed, must be quickly put into the eye of the flyer with the right hand while it is held by the left, and both being released, the end is lapped upon the bobbin while the thread is being steadied and guided into the thread plate eye. In spinning superior yarns, laying on is sometimes practised for all ends requiring to be set spinning again, since the reelers can cut off the untwisted ends when they turn up and make a small weaver's knot, which is much superior to even a well-made piecing. When the doff or set of bobbins is full, all the ends should be got up and the frame stopped while the builder is in its middle position, lest the ends when broken off should be lost between the head or base of the bobbin and the yarn upon it. It will save much time and waste if all the ends can be set spinning prior to the doffing of the frame. When stopped, the doffers commence to draw a short length of yarn off the bobbin and to break off the threads, which they throw upon the trough lids. They first remove the flyers from the spindles and then the full bobbins, which they replace by empty ones after the spindle blades have been rubbed with an oily "patch." Replacing the

flyers, they bring down the ends again and thread the eyes. The drag bands are put back to their starting position and the frame slowly but steadily started. If all this has been carefully but quickly done, few, if any, ends should be broken. Each doffer should have a certain number of spindles assigned to her, according to her proficiency, so that all may be finished at the same time. If this be well managed, two minutes should suffice to doff a frame of 200 spindles.

The draft and twist may be changed on the wet spinning frame in a similar manner to that described in our last chapter when dealing with the dry spinning frame.

The reach being short, the draft gearing is, of course, more compact, consisting merely of the top roller wheel, draft change pinion, stud wheel on the horse head, and the boss roller pinion. An average draft of 9 or 10 is the rule, but when spinning double rove the draft is usually longer. A short draft always gives a more regular yarn, and is the thing for superior yarns and warps.

The number of turns per inch twist required is usually reckoned by multiplying the square root of thelea of the yarn by $1\frac{1}{2}$ for weft, $1\frac{3}{4}$ for light warp, 2 for full warp, and $2\frac{1}{4}$ or $2\frac{1}{2}$ for thread warp.

The effective circumference of a fluted roller is not the same as that of a plain roller of the same diameter, for the reason that the former develops a greater length when the material it delivers is pressed into the undulations of its surface. The finer the flutes, the shallower they are, and the more the surface of the roller approaches the form of a plain cylinder. The coarser the flutes, the deeper they are, and the greater the effective circumference of the roller. The actual circumference of the boss roller of the spinning frame may be determined by passing a slip of paper through the rollers when the frame is running, then counting off a number of indentations corresponding with the number of flutes in the boss, and cutting off the remainder of the paper. The length of the preserved piece when smoothed out will be the correct circumference of the boss. Carefully measured in this way, it will be found that the circumference of a roller with 20 to 24 flutes per inch is the product of 3.4 and the extreme diameter of the roller. For rollers with 26 to 32 flutes per inch, 3.35 multiplied by the extreme diameter gives the circumference, and similarly for rollers fluted up to 40 per inch their circumference is the product of 3.3 and the extreme diameter of the roller.

This increased development of the boss roller of wet spinning frames must not be lost sight of when making the twist calculation, since the drawing roller delivers a greater length than would a plain roller of the same diameter.

Wet Spinning of Ramie.—Fig. 63 shows the upper portion of a wet-spinning frame used for the ramie fibre. The strength of this fibre is due,

not, as in the case of flax or hemp, to gummy matter binding the individual filaments together, but to the length of individual filaments themselves, which in order to be spun fine must be entirely freed from all such gummy matter. Hence the length of the reach of even a wet spinning frame for ramie must be from 12 to 20 inches. This distance is divided into three portions by two long rollers with light wooden pressings, which serve to control and render the drafting uniform. The fibre is so clean that the ring system of spinning is usually employed in preference to the flyer.

Before leaving the subject of wet spinning, it will be of interest to

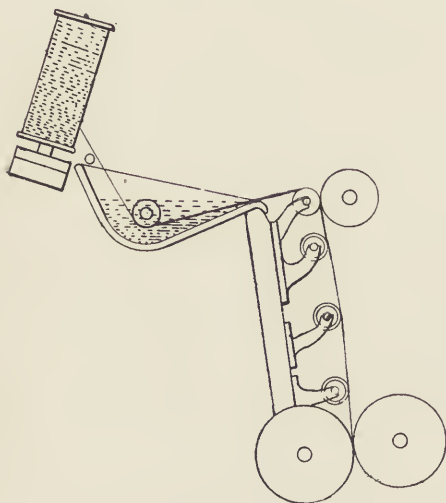

FIG. 63.—Part of ramie wet spinning frame.

mention a way of producing a lumpy yarn for fancy linens upon the wet spinning frame. Fig. 64 shows the means which Mr M'Meekin of Belfast has devised to produce the desired effect. It will be seen that, instead of the speed of the feed roller being periodically increased by means of eccentric wheels, as is sometimes done in a gill spinning frame, the feed or retaining roller is pushed quickly forward at intervals by means of a ratchet and pawl actuated by a connecting rod and a heart wheel. The mechanism consists of a pinion *b*, placed upon a cylinder shaft, which pinion transmits motion to a cam *g* through the wheels *c*, *e*, and *f*. The wheel *e* is a change wheel for varying the speed of the drive. The shaft upon which the cam is mounted is turned down, and enters slots in the two rods *h* and *h'*. Secured to each rod, by means of pins, is a runner or bowl, which is kept in rolling contact with the surface of the cam before mentioned. As the latter revolves, the radial action of the rods operates upon the bell-crank levers shown, and through them causes the pawls *w* to turn the ratchet wheel *o* on the retaining roller shaft *m*. Mounted loosely upon the shaft *m* is a free wheel *p*, which obtains its motion from the draw-roller shaft. This free wheel is provided with a series of driving pawls, which engage with a second ratchet wheel *w* on the retaining roller shaft. The cam *g* is shaped in such a way that at every revolution the arms *h* and *h'* are pushed quickly forward, accelerating for a short time the speed of the retaining roller. The ratchet mechanism referred to, being operated from the drawing roller through the horse-head stud wheel and

mention a way of producing a lumpy yarn for fancy linens upon the wet spinning frame. Fig. 64 shows the means which Mr M'Meekin of Belfast has devised to produce the desired effect. It will be seen that, instead of the speed of the feed roller being periodically increased by means of eccentric wheels, as is sometimes done in a gill spinning frame, the feed or retaining roller is pushed quickly forward at intervals by means of a ratchet and pawl actuated by a connecting rod and a heart wheel. The mechanism consists of a pinion *b*, placed upon a cylinder shaft,

draft change pinion, drives the feed roller at the usual speed when not affected by the throw of the cam. The acceleration of the speed of the retaining rollers at regular intervals produces lumps in the yarn at equal

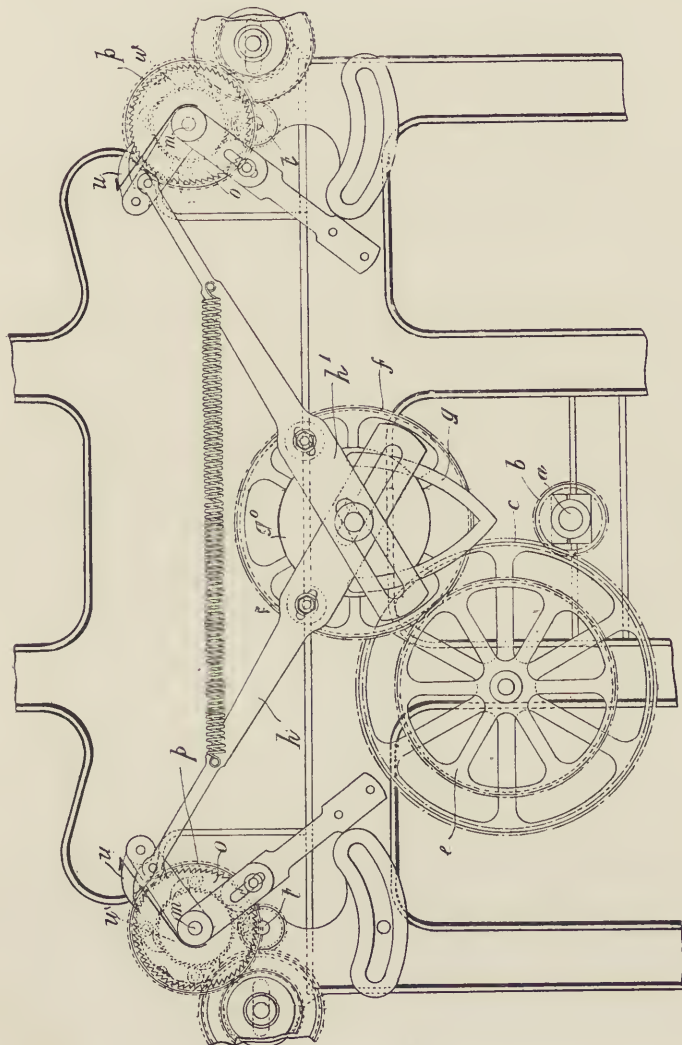

FIG. 64.

distances. Of course the thread plate eyes must be of sufficient size to let the lumps pass to the bobbin.

Cold Water Spinning.—Our chapter on wet spinning would be incomplete if we did not mention cold water spinning, which has within recent years received some attention at the hands of spinners.

Some classes of flax, usually devoid of any great strength, such as some of the dew-retted varieties, will spin very well through almost cold water, and often the water must be kept at a low temperature in order that the rove may draw through the trough without breaking. The harder and stronger the flax, the longer must it be subjected to the action of cold water, in order that the gum binding the fibres together may be softened sufficiently to enable them to be separated or drafted on a short reach.

The rove intended for cold water spinning should be put upon rove bobbins with perforated barrels, and these bobbins of rove steeped in water for some time prior to spinning. The perforated bobbin barrel permits the water to penetrate and act upon the interior layers of rove, so that all may become equally softened. In addition to this preparatory steeping, which should be of constant duration for the same rove, the bobbins, instead of being put in a creel, as in hot water spinning, are placed vertically upon upright pegs in a specially deep spinning frame trough kept full of water. In this trough they revolve quite freely, since the buoyancy of the water supports them and reduces friction. The advantages of this method of spinning, which answers admirably for some classes of flax, are the saving in the cost of steam for heating the troughs, and the cooler, drier, and more healthy atmosphere of the spinning room.

The Use of Alkalies for Maceration.—While the maceration of flax, hemp, or tow fibre is more easily accomplished in soft water than in hard, yet certain alkalies in solution have the effect of softening and eventually dissolving out the natural gum of the fibre. Practical use is made of this fact in the steeping and boiling of lincn yarns and cloth in soda lye, which forms part of the bleaching process.

The same alkalies, if used in the wet spinning trough, would no doubt enable the material to be spun on shorter reaches, but the danger of injury to the yarn, as regards both colour and strength, through the alkali gaining in strength as the yarn dries, precludes their use. There is, we believe, but one firm making use of such chemicals, the firm referred to being started and the mill equipped with machinery to carry out the patents of Mr Connor of Belfast. This gentleman proposed to use in the spinning trough a .5 to .75 per cent. solution of hydrodisodie phosphate, formed by dissolving 1 lb. of crystallised phosphate of soda in 12 to 15 gallons of water, which might be slightly acidulated with a weak acid, such as acetic or sulphurous. The worst of using any such compound is the injurious effect which it has upon any iron work with which it may come in contact, and the practical impossibility of protecting the journals, etc., of the spinning frame against such injury.

Size in the Spinning Trough.—Other spinners have tried to improve the quality of their yarns as regards strength, suppleness, "skin" gloss or lustre, by dissolving in the hot water of the spinning trough such substances

as starch, glucose, Iceland or Irish moss, etc. It has been found that the increased value and quality of the yarn spun in such a fashion does not warrant the increased expense and trouble incurred.

Turn Off and Speed of Spindles.—The quantity of yarn which a spindle can “turn off” in a given time is limited by the quality of the material and the speed of the spindle. If the flax or tow is really good for the number and the rove extremely level, the yarn may be spun with the spindle running at the greatest speed consistent with due wear and tear. If the material is not first-class and the ends break frequently, the yarn must be spun at a speed which will permit a skilful spinner to make good piecings, or, if the ends are laid on, to accomplish that operation.

There is one particular number best suited for each pitch of frame. Other numbers may be spun upon these frames, but at slower speeds, by reason of either the strength or weight of the yarn.

To spin a fine yarn upon a coarse frame, that yarn must be strong enough to pull round a heavy bobbin, and to stand the strain put upon it at the thread plate eye by reason of the “projection” of the rollers and the width of the flyer. To spin a coarse yarn upon a fine frame the speed of the spindles must be low enough to avoid the centrifugal force of the revolving flyer causing the ends to “balloon” out, and striking one against the other, to break each other down. It is also sometimes advisable to spin a superior yarn at a slow speed to avoid bad piecings, etc.

The question of whether it is advisable to spin at a high speed and get a good turn off even at the expense of making a little extra waste, is an important one for the manufacturer. Its solution depends upon the price of the material being spun, the cost of spinning remaining approximately constant. If flax be very dear, more may be lost by making, say, one per cent. more waste than would be gained by causing the spinner and frame to produce more yarn in the same time by increasing the speed of the spindle. On the other hand, if the material be very cheap it is often more profitable to run at a higher speed and get a good turn off, even if the waste on the spinning does seem a little bit excessive.

Spinning Room Belting.—One of the largest items in the expenditure necessary to keep the wet spinning room running is the cost of belting. A spinning room belt, owing to the conditions of running, and to the excessive and frequent changes of temperature and humidity of the atmosphere of the room, is indeed subject to a severe test. A cotton, canvas or woven belt thoroughly waterproofed or coated with indiarubber is undoubtedly the one best suited to withstand a varying temperature and damp atmosphere. Such a belt is, however, often found lacking in other properties required by the severe nature of the spinning frame drive. Indiarubber belts are heavy and expensive. For cheapness, lightness and durability the author prefers a reliable make of camel's-hair belting, kept in good order by the

regular application of a good belt syrup into the composition of which no resin enters.

Textile belts of any description are apt to wear unduly at the edges, owing to friction on the belt fork. This wear and tear may be minimised by having the guide pulleys correctly set, and by the use of porcelain rollers on the arms of the fork.

Arrangement of the Spinning Room.—The spinning room is usually sufficiently wide to take in two frames in width and to give a sufficiently wide passage down the centre of the room between the frames. The iron beams of the fireproof ceiling are supported by columns near the centre of the room and at one or both sides of the central alley. These columns support the brackets carrying the line shaft, which should have a speed of about 200 revolutions per minute and lie at right angles to the tin cylinder or driving shaft of the frame to be driven. The pulley end of the frame is usually kept away from the passage in order to avoid accidents and to give the longest driving belt possible, which is often as much as 50 or 60 feet. It will be easily understood that guide pulleys are required to carry the belt over the top and length of the frame, and to pass it vertically downwards to the driven pulley. These guide pulleys should not be less than 12 inches in diameter, in order to avoid excessive speed, friction, and wear and tear upon the spindles or studs upon which they turn. They should be thoroughly adjustable to any required angle. In setting them it should be borne in mind that the face of at least the one which carries the slack side of the belt must be in a vertical plane at right angles to the cylinder and passing between the fast and loose pulleys, while the centre of the line in which the driving side of the belt leaves its guide pulley must be in a line drawn from the centre of the face of the driving drum at right angles to the line shaft. If these principles be observed, much unnecessary friction upon the edges of the belt will be obviated and its life considerably lengthened.

In starting a frame after doffing, the belt is usually held half on and half off the fast pulley, in which position it slips and gives the desired slow motion. This practice is highly injurious to the belt, especially a textile one, as the edge bears heavily against the fork, and part of the inside face of the belt is heated and burned by friction upon the pulley. If the belt be a canvas or indiarubber one, the solution binding the layers together is often melted and runs, after which the belt soon breaks up.

The small cotton bands which drive the spindles are affected by the damp and changes of temperature in a similar manner as are the belts. They are generally found to contract and tighten up during the night, causing the frame to be heavy to start in the morning, when many bands break, being either rotten or weakened by cutting at the knot. Experiments are now in progress with a swing rail wet spinning frame similar to the dry

spinning frame described in our last chapter. The advantage of the swing rail, as before explained, is to overcome this difference in tension of the bands, which is still more marked in the wet than in the dry spinning room.

The make of banding most suitable for flax spinning frames is that composed of three strands—each of three, four, five or six plies of, say, $2\frac{1}{2}$'s cotton yarn, spun from fibre of good long staple. The 3×3 cotton banding is suitable for the finer frames, while the 3×6 is that usually employed upon a 3-inch frame.

Band Tying.—There are two ways of tying the bands around the spindle and the tin eylinder. The first, almost universally practised in Ireland, and the only proper way for fine frames, is by using the flat or interseeting loop knot, which is a very secure one if properly made. As the band is put on when the frame is running, we will describe how it should be done. A small weight, such as a drag weight, is attached by a single bow knot to the end of the band eord which the band tyer has in the form of a ball in the box upon which he sits. Passing his weight in between the spindles to the right or left of that one which requires a band, he follows it up with an iron rod, in the hooked end of which he catches the eord behind the weight, and in this way carries it forward and drops it over the revolving tin eylinder. Withdrawing the rod from above, he uses it to catch the eord again below the eylinder, and drawing it towards him he regains possession of the free end of the eord, from which he releases the weight. He has now one end of the band on each side of the spindle, the side which will run on to the wharve being to the right or left, according as the spindle is required to give left or right hand twist and being inclined upwards or downwards according to the side of the frame upon which the spindle is situated. Crossing and intertwining the ends, he forms a single knot upon the spindle butt below the wharve. Exerting his strength he stretches the band and pulls the knot tight. If the tin eylinder is revolving towards him, he has the short end in his right hand. If he is on the other side of the frame, the tin eylinder appears to be revolving away from him, and he has the short end in his left hand. Since the band is drawn tight upon the eylinder it has a tendency to be pulled round towards the left, but it must be steadily held in place by the long end of the band in the right hand, while the short end is again passed over and looped upon the tightly drawn long end, then passed behind the spindle and both ends drawn tightly *at the same time* into a properly formed flat knot, both ends being then cut off about one inch from the knot with a sharp knife. Care must be taken in performing this operation, which is a rather difficult one to learn, not to hold the band at rest for a lengthened period upon the tin eylinder, for if it should happen to rest upon one of the numerous soldered joints, the heat engendered by friction might, and often does, melt the solder and cause the eylinder to break in two. The knot formed as we have described is much

smaller than that made on the Continent, and for that reason is much more suitable for fine spinning, as a large knot causes the spindle to jump, and if, as in a fine frame, there is very little room between the spindle wharve and the poker rods, it may be caught and hold the band. The large knot we have spoken of is made as follows:—The band is passed round the tin cylinder as before and the ends brought out at either side of the spindle. The short end is crossed under the other, and then lapped twice round both sides together and drawn through the loop, forming a slip knot. The long end is then drawn tight and the knot slipped up close against the spindle and below the wharve. A notched piece of iron is then inserted between the knot and the spindle to prevent the band from moving, while the long end is cut to a length sufficient to make a single knot behind the slip knot, when the ends are cut short, the iron removed, and the band sprung upon the wharve.

Tapes for Spindle Driving.—Tape or cotton webbing, about an inch wide, is sometimes used instead of banding, especially for coarse frames. It is generally arranged that a single tape shall drive at the same time one or more spindles on each side of the frame.

The use of tapes necessitates the employment of tension pulleys, which are often a source of trouble. The tapes are cut to the exact length, and the ends joined by sewing or by a patent fastener.

Oiling in the Spinning Room.—Careful oiling is, if possible, more important in the spinning room than anywhere else. The quality of the oil used to lubricate such an immense number of spindles running at a high speed affects, in a marked degree, the power required to keep the roomful of machinery in motion. A spindle oil with too much body makes the frame heavy to drive, while, if the oil be too thin, it is not retained in the brass collar which surrounds the spindle neck. For heavy frames a very good mixed oil may be made by combining four parts of sperm oil with one part of mineral oil; but for fine frames, pure sperm oil is to be preferred. An oil or grease of considerable consistency is required for the slow running rollers working in open bushes, as a light oil would run off immediately.

How Black Threads are Produced.—The greatest care must be taken in oiling the rollers lest any oil should get upon the material being spun. Black threads in bleached yarn are generally caused by oil absorbed on the spinning frame. Black oil will often make its way from a roller bearing under the brass carriage or covering of a roller, and come to the surface through a blow-hole in the metal. The spinning room guide pulleys should be well greased every morning before the mill starts. The spindle necks should be oiled twice per day while at work, and the spindle steps once a week. The boss or drawing rollers should be oiled every day, but once a week will be found sufficient for the slow-moving top or feed rollers. Once

a week will also be found sufficient for the builder motion, but both draft and twist gearing had better be oiled twice a week.

Cuts per Spindle.—The rate of production of a spinning frame is usually calculated and compared in cuts or leas of 300 yards obtained per spindle, and per hour or per day.

Degree of Saturation of the Atmosphere of the Wet Spinning Room.—The frequently excessively humid, and, consequently, unhealthy atmosphere of the wet spinning room has led to the introduction of a "special rule" or clause of the Factory Act limiting the degree of saturation of the air in the wet spinning room. The instrument by which this is determined is known as a hygrometer, the most convenient form of which is a wet and dry bulb thermometer, such as is shown in fig. 65. These are two ordinary thermometers, side by side. The bulb of one is covered with muslin, which is connected by a wick with a water reservoir, so that it remains always moist. When the air is fairly dry, or still far from being completely saturated with moisture, evaporation from the muslin covering of the wet bulb is constantly going on, and an amount of heat corresponding with the rate of evaporation or dryness of the air is being extracted from the bulb, causing it to show a lower

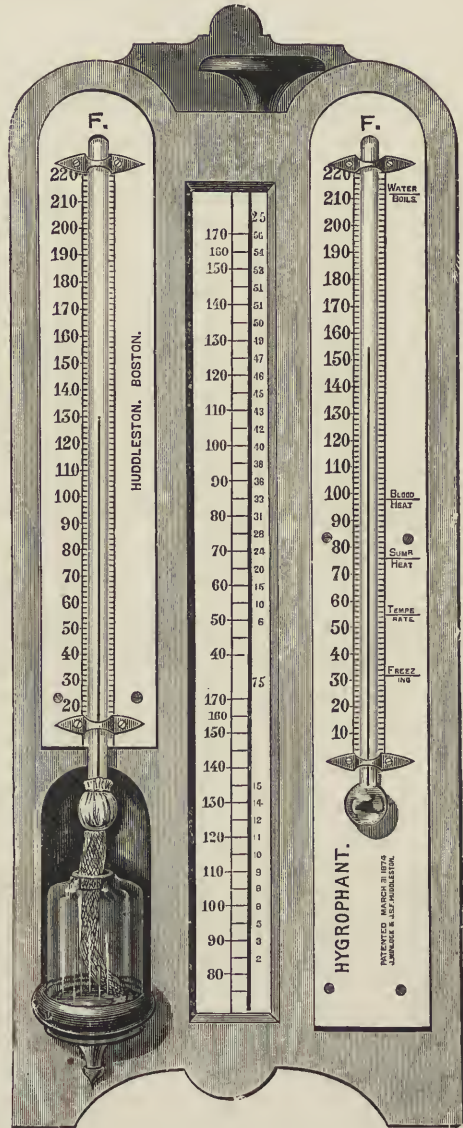

FIG. 65.—Hygrometer, as supplied by The Sturtevant Engineering Co., London.

temperature than its companion or dry bulb. When the air is fully saturated, no water will evaporate, and the two thermometers show

the same temperature. In order that the air may be sufficiently dry and healthy, the law requires that the wet and dry bulb thermometers show a difference of at least two degrees at the ordinary spinning room temperature. The chief source of the saturation of the air of the wet spinning room is the evaporation which is constantly going on from the surface of the hot water in the troughs. There are several ways of preventing this evaporation to a large extent, all practical ones being based on the reduction of the water surface in free communication with the atmosphere of the room. The apertures through which the steam escapes from the trough are (1) at the front, between the lid and the lip of the trough, and (2) at the back, through which the rove enters. In the first place, the surface of water in direct communication with these openings may be reduced to a minimum by fixing projecting ribs upon the under surface of the trough lid, the said ribs projecting downwards and into the water in the trough, and thus forming an effective steam trap. The means of carrying off the steam, the escape of which cannot be prevented, will be described in Chapter XIX., where the subject of ventilation will be fully discussed. The water surface in contact with the air of the room may be still further reduced by passing the rove into the trough through porcelain tubes, each accommodating two ends, so that, with the aid of one, a broken end, or one which has run through, may be easily replaced.

The quantity of shive and dust thrown off and extracted from the rove and yarn during the wet spinning process is truly surprising, and, especially with some sorts of flax, forms an important part of the waste or loss in spinning. The frames require frequent cleaning, the flyers throw off water and dirt upon the spinner, and the work, especially in coarse rooms, is of so dirty and onerous a character that it is becoming extremely difficult in many places to obtain hands. The spinners should be provided with waterproof aprons, and the frames should be fitted with splash-boards if the spinner's pass is wide enough, *i.e.* not less than 4 feet 6 inches from spindle to spindle. The splash-board, with its accompanying gutter, keeps the floor dry and free from waste, and thus goes a long way towards improving the working condition of the room. The waste is furthermore kept clean, and in a far better state to be utilised, as we will describe in our next chapter. A convenient form of splash-board is that supplied by Mr Wm. Carter, 28 Waring Street, Belfast. This splash-board may be maintained in three positions—*i.e.* its normal position, its forward position, for putting up rove, and its turn-down position, for doffing and cleaning.

The back of the trough and lid should be frequently looked to and cleaned, as short fibre often accumulates upon them, especially if the rove, on entering the trough, is too near to either. These short fibres, if not kept cleared off, are apt to come away periodically with the rove, forming objectionable slubs in the yarn. The water in the trough, as we said,

softens the gummy or pectic constituent of the flax, consequently, when the machinery is stopped for twelve or more hours, the rove remaining in the trough is frequently so softened and weakened by the action of the water, which dissolves out the gum, that, upon the frame being restarted, the rove breaks in the trough. If this is found to be the case with any special rove or material, the trough should be emptied of water for a week-end or holiday stoppage. Another frequent cause of trouble in morning starts is the presence of the gum which has been dissolved out from the flax, and which lies like starch upon the surface of the water in the trough. This sticky substance comes away at once in a mass with the rove, and if the yarn be not strong, the ends are broken down. The only remedy is to remove the gum by hand before starting the frame. The watering of the rollers and of the rove between them and between the top roller and the lid of the trough is an essential if a good start is to be made after a stoppage. If any part of the rove remains dry it will not draw freely, and will, in all probability, break. Where wooden rollers are used, they should be watered every few hours during a stoppage of any duration, until the room has quite cooled down. If this be not carefully done, the rollers will, in many cases, crack and break.

Removing Yarn from the Spinning Room.—There are several methods of sending the yarn from the spinning room to the reeling room. In coarse mills the bobbins are often placed in baskets which are returned with the empty bobbins. A better plan is to provide a set of five or six spiked trays for each side of the frame, the said trays being threaded upon a central rod to facilitate carriage. In this way each doffer may have a tray provided with a number of spikes equal to the number of spindles she is required to doff, while the same trays are a convenience to the reelers in spreading their work over the length of the reel. Another favourite way in fine mills is to have one spiked box or cage for each side of the frame, and to allot to one doffer the duty of collecting the full bobbins from the others, and of eaging or placing them upon the spikes in the box, which is then removed to the reeling room.

CHAPTER XIV.

FLAX, HEMP, JUTE AND RAMIE WASTE SPINNING.

Waste Spinning.—The spinning of vegetable stalk and leaf fibre wastes has not until within recent years received much attention nor attained the importance of cotton or woollen waste spinning. The reason of this state of affairs is no doubt the intractability of the material and the consequent difficulty in spinning it. Short fibres which fall or lap, and other wastes made in preparing and spinning hard fibre, such as Manila or New Zealand hemp, may be treated as tow and carded and prepared for a gill spinning frame, such as that shown in fig. 50, and spun into core or inside rope yarns, or into yarn to be used for twine lashings.

American Machinery for Spinning Hard Fibre Waste.—In figs. 66, 67, 68, and 69 are shown a system of machines which is used for treating the above class of waste in some American twine mills.

Fig. 66 is called a duster and cleaner, and is used to separate the waste or tow from the sweepings of the mill.

The sweepings are fed into the machine through the hopper; the dust and dirt is collected underneath, while the clean waste and tow is delivered at the rear of the machine in shape for the picker (fig. 67). This machine takes the clean waste and tow, and opens up the material into a form suitable to be fed in the card. It may also be used to open and pick fag ends of ropes and waste yarns so that the fibre may be utilised. Fig. 68 is the form of card employed. The fibre is fed upon the feed sheet to the right, and is delivered to the action of the cylinder, workers and strippers, which open out and parallelise the fibres, which are taken off by a single doffer and condensed into one narrow ribbon as seen on the left of the figure.

The sliver from the card is taken to the tow spinner (fig. 69), which is built on similar lines to the automatic spinner (fig. 48). The sliver passes between the pinned apron belts shown, which take the place of the chain gill of the latter machine, thence to the calender rollers and flyer, which twists it into yarn and winds it upon a bobbin.

The sweepings of flax, soft hemp and jute mills, as well as long card waste and the dropping from under the hackling machines, may be separated

from dust and shive by a passage through the waste shaker shown in fig. 70 and supplied by Messrs Thomas Jennings & Sons, Leeds. After being

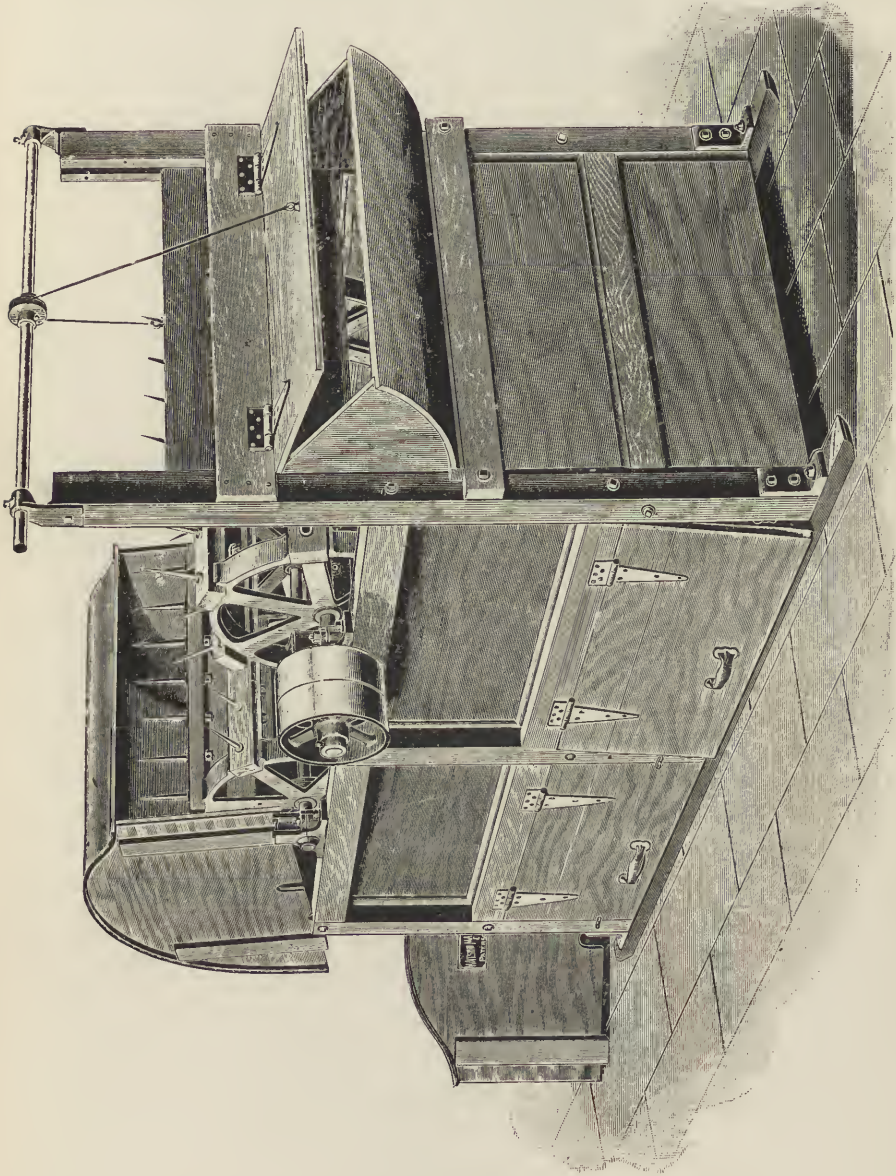

FIG. 66.—Duster and cleaner, as made by The Watson Machine Co., Paterson, New Jersey, U.S.

carefully picked and foreign substances removed, the cleaned fibre may be mixed with a longer material, carded and spun into coarse yarns of low quality.

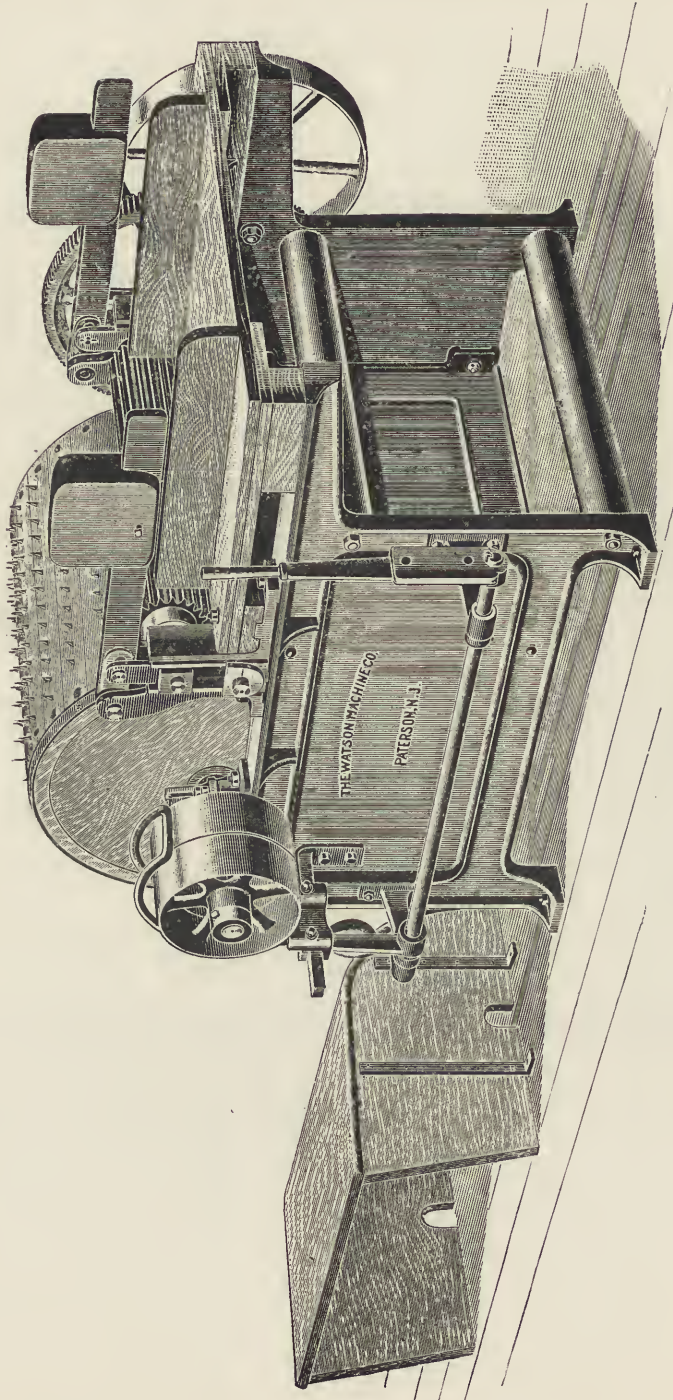

FIG. 67. — Picker for hard fibre waste and tow.

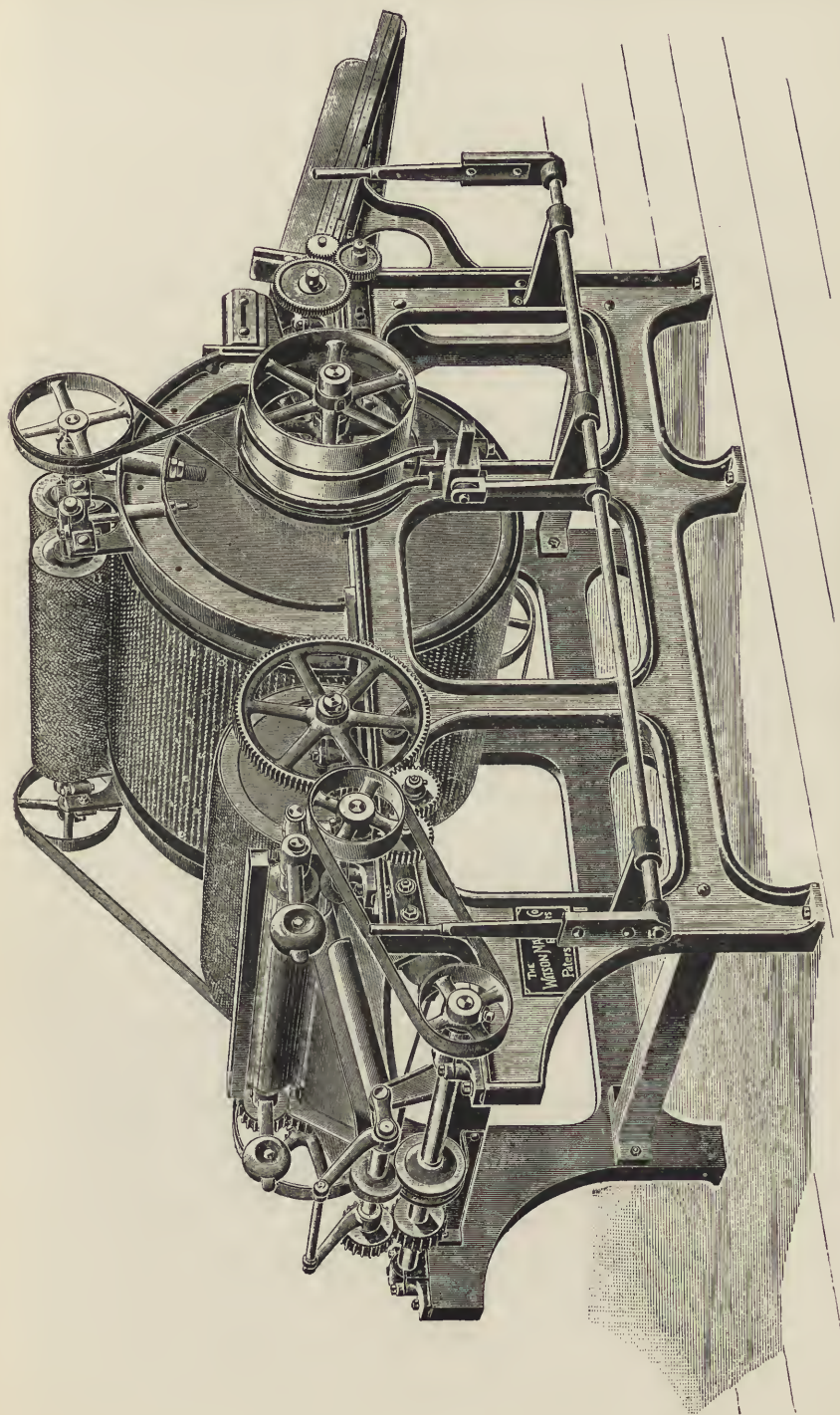

FIG. 68.—Card for hard fibre waste and tow.

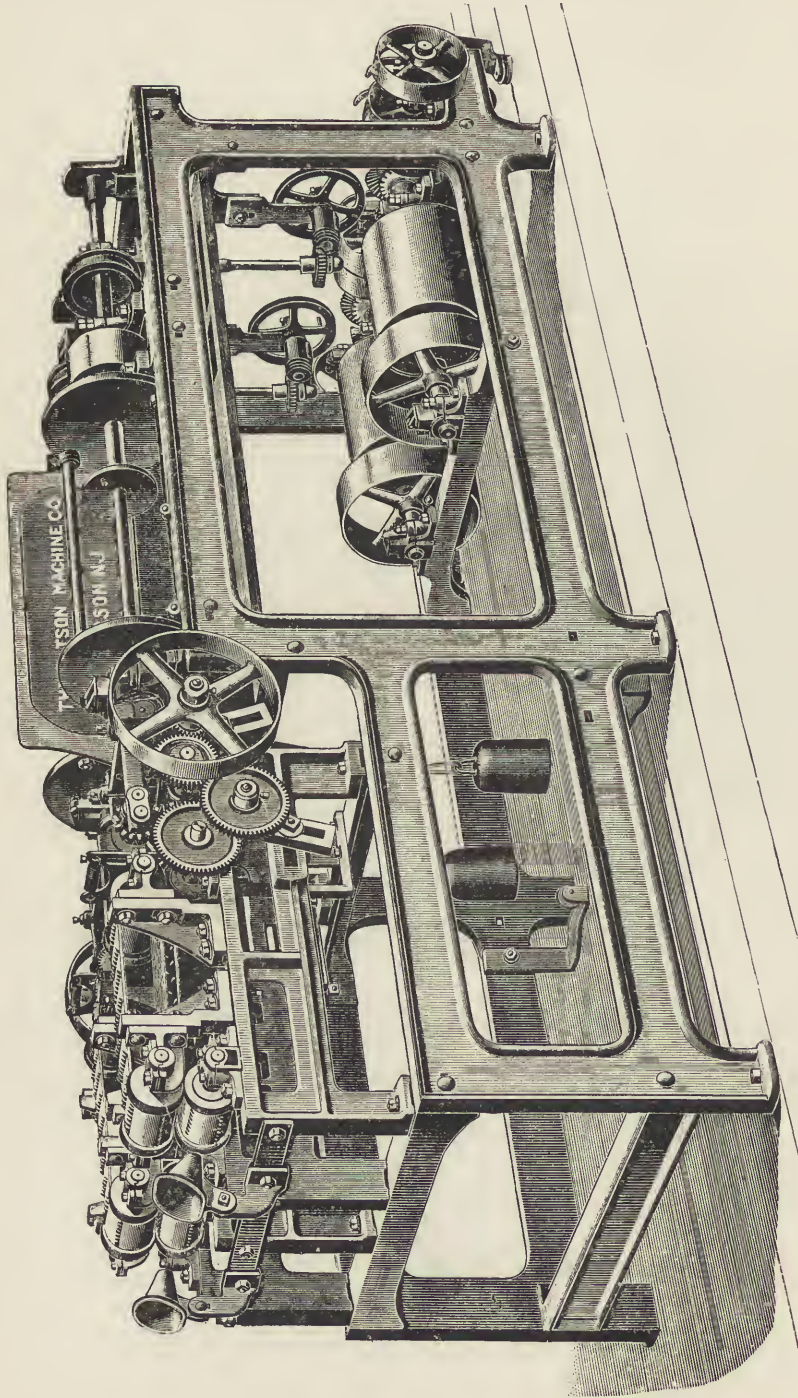

FIG. 69.—Tow spinner for hard fibre waste and tow.

Opening Flax "Bands" and Rope.—The fibre contained in the ropes and bands, which surround the "bobbins" and heads of Russian flaxes, may be utilised in a similar manner. The fibre is either separated by hand or by carding, after the rope has been first cut into short lengths, or by untwist-

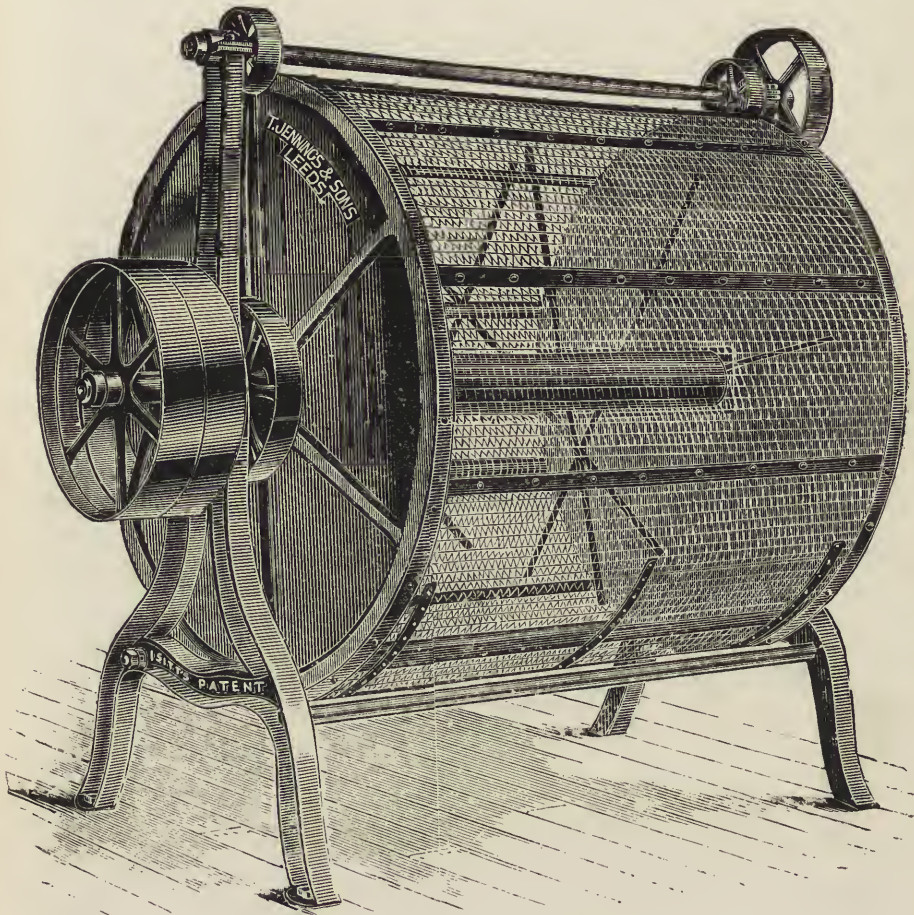

FIG. 70. —Isitt's patent waste shaker.

ing the ropes in the machine shown in fig. 71, which turns off 33 lbs. of excellent tow per day.

Noil Spinning.—Noils from the combing machine and hard waste produced in the wet spinning room are of such short staple that they require special machines and treatment. The former, being open and unmatted, is comparatively easily dealt with, although it is only suitable for coarse yarns up to about four leas per lb., which may be used for cords and twines. The

latter, which contains all the purest fibre, is so much matted as to require special machinery to open it and put the fibre into a suitable state to spin the fine and level yarns for which it is naturally adapted. We believe Mr Max Raabe and Messrs Porritt Brothers to be the pioneers in noil spinning, while Mr William Carter of Belfast has given the benefit of his lifelong experience in flax spinning to the question of the utilisation of its hard or wet waste in the production of a level and serviceable yarn.

Treatment of Wet Spinning Waste.—Wet spinning waste, after having been dried and picked by hand to separate foreign substances such as flyers,



FIG. 71.—Eves' patent rope untwister and opener,
as supplied by Mr W. Carter, 28 Waring Street, Belfast.

bobbins, cords, etc., may be roughly opened upon the tenter-hook "willy" as shown in fig. 72. The material to be operated on is spread by hand upon the feed lattice L, which delivers it slowly to the spiked wooden rollers F, which latter hold it against the action of the similarly spiked cylinder C, striking upwards as shown by the arrow. The upper feed roller F is cleared by the wooden brush roller H set with several rows of hair bristles, as shown, similar clearers B acting upon each of the workers W to strip off the material retained by their teeth and deliver it again to the cylinder C. The cylinder itself is stripped by the fan A revolving at a high speed in the direction shown, the roughly opened material being thrown out at the

opening E into an enclosed settling chamber of sufficient capacity to allow the air to settle and the flocculent material to fall. The teeth of the workers and cylinder are of flat forged steel about $\frac{1}{8}$ inch in thickness and of cockspur or tenter-hook shape driven into the beech lags, with which these rollers are covered, in rows arranged in such a way in the cylinder and the workers that, although close set, the teeth may not come in contact. Of the wooden staves D forming the rails of the fan, every alternate one is furnished with two rows of straight spikes, and the others have but one row of spikes and a strip of leather which rubs against the teeth of the cylinder and keeps them clean.

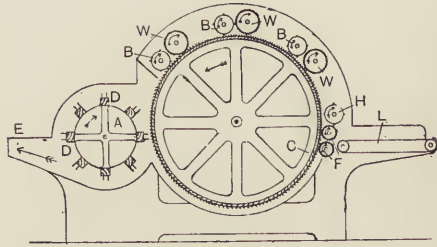

FIG. 72.—Tenter-hook willy for opening hard waste.

The upper portion of the machine is enclosed in a wooden cover to prevent dust and waste flying off, while the under covers are in the form of grids, which allow heavy impurities to fall through. The workers are driven slowly round in the direction shown by means of a chain and sprocket wheels, while the strippers and fan are driven at a comparatively high speed by one and the same belt from a pulley upon the cylinder axle.

The Garnett Machine.—The roughly opened waste from the willy should be more perfectly opened before being presented to the scribbler (fig. 73). The machine best adapted to do this is called a “Garnett” machine, as, besides opening, it breaks up long threads and fibres which would later on cause much inconvenience in the condenser (fig. 75). The Garnett machine is composed of swifts and workers, and resembles very much in general arrangement the scribbler shown in fig. 73. The machine is very strongly built, the cylinders and rollers being of cast iron turned up true. Its chief feature is the clothing, which is in reality a continuous strip of steel ribbon with saw-tooth edge, lapped on edge spirally round the rollers. Applied in this manner it is extremely strong, as indeed it requires to be. The material is spread upon a feed sheet, passed in through feed rollers, and doffed from the last doffer in an open condition by an ordinary doffing knife. When the teeth of the Garnett machine get choked up with waste and dirt, they must be cleaned by taking out the rollers, putting them in a frame, and while turning them round, passing a clearing tool across the face of the roller in the spiral groove formed in the clothing.

Opener and Knot Breaker.—Sykes’ opener and knot breaker, which are of similar construction, but coarser than the Garnett machine, may be used instead of the willy (fig. 72).

The perfectly opened waste from the Garnett machine is next batched. Instead of oil and water alone, an emulsion is formed by mixing a vegetable oil, such as olive, either alone or with oleine, with a solution of an alkali.

Batching.—A good mixture consists of 75 parts of olive, rape, castor or colza oil, 25 parts of alkaline solution containing 5 to 10 parts of caustic potash and 100 parts of cold water. A decoction of Irish or Iceland moss may be used instead of pure water. This emulsion is used, not so much as a lubricant, as to reduce the quantity of imperceptible waste, to increase rubbing in the condenser, and make a stronger shubbing and yarn. The batch should lie for at least twenty-four hours in order to let the lubricant, which has been put on with a watering can, permeate and diffuse itself throughout the mass, before the fibre is used to supply the hopper feeder shown to the left of fig. 73. This feeder is Tatham's "Rochdale" pattern, and similar in every way to the machine described on p. 81, fig. 32.

The Scribbler.—Leaving the lattice feed sheet of the automatic feeder, the material transfers itself to that of the scribbler proper, which delivers it into a pair of feed rollers M, about 3 inches in diameter, generally clothed with leather filleting set with steel points. The larger roller N, similarly clothed, is the "licker in," which takes up the fibre as delivered by the feed rollers and carries it forward towards the first cylinder or "breast," as it is often called. The fibre is not delivered direct to this cylinder by the licker-in, but is transferred to it by an "angle" stripper, as shown.

Three pairs of workers and strippers are shown upon the upper portion of the breast. These, together with the cylinder, turning in the direction shown, do their work of straightening out the fibre in a similar way and upon the same principles as the same organs of the ordinary tow card. The roller O is peculiar to this class of card. It is called the "fancy roller." Its work is to raise the fibres which are imbedded in the cylinder clothing so that they may be deposited upon the doffer Q. The "fancy" is covered with leather sheets, set with long and limber steel wire, considerably knee-bent in the reverse direction from that in which the roller revolves, as shown by the arrow. Its surface speed is slightly greater than that of the cylinder, so that the pins of these rollers slightly intersect one another, those of the fancy passing through those of the cylinder, raising the material imbedded in the latter, and keeping the cylinder clothing keen and in good condition. The doffer Q receives the material from the breast and carries it forward towards the next cylinder, to which it is transferred by another angle stripper, as shown. The same operations are repeated over the back and front swifts before the doffer R is reached, and the now attenuated web or fleece is doffed from it by a comb S, which is given a rapid vibratory motion by means of an eccentric and rod, as shown. A lancewood lath attached to the comb stock and pedestal supporting the doffer, forms a

radius bar which keeps the knife at its proper distance. The small roller shown on the top of this doffer R is placed there for the purpose of keeping the clothing of that roller clean and in good keen condition.

The fleece as doffed from the last doffer of the scribbler is carried away upon a narrow lattice which runs parallel and close up to the face of the doffer. This lattice runs round the lower of the three condensing rollers T, so that the scribbled material is formed into a sliver some 4 inches wide,

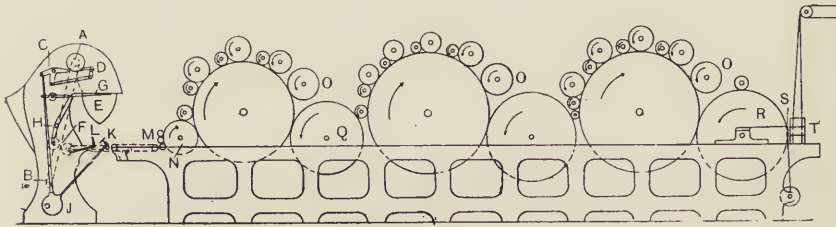

FIG. 73.—Scribbler with hopper feeder for flax waste spinning.

compressed and strengthened in passing between the heavy rollers T. This method of taking the fleece off the scribbler forms part of what is known as the Scotch feed arrangement, by means of which the material is transferred from the scribbler to the carder. Another and more complete view is given of this arrangement in fig. 74. Taking both together, it may be seen that the sliver passes from the calender rollers T to the lattice carrier U V, and thence over the swinging arm W to the feed lattice or sheet of the carder (fig. 75), upon which it is spread in a regular manner by the travelling carriage Y.

This carriage, which runs upon grooved pulleys and rods, as shown, is carried backwards and forwards across the face of the card, by means of the endless strap Z, upon which is riveted a stud which engages with the slotted piece A B of the carriage. A pair of tin rollers C are contained in the carriage in order to deliver the sliver properly downwards to the sheet below. Motion is given to these rollers by means of a pinion D compounded with a small grooved band pulley, around which the cord E F passes once. Since this cord is kept tight by the weight F, suspended upon one end, the pinion D is forced to turn as the carriage moves backwards and forwards, first in one direction and then in the other. Each of the tin rollers has a pinion upon the end of its axle which engages constantly with its fellow and alternately with the pinion D, the disengagement

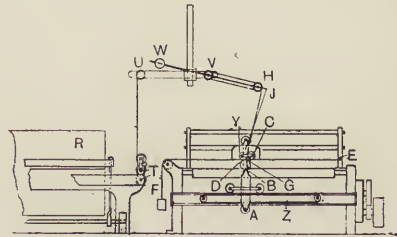

FIG. 74.—Scotch feed.

of one pinion and the engagement of the other being effected at the extremity of each traverse by the contact of the T-piece G with a stop, adjusted in the correct position at either side. The pinions, once changed, are kept in gear by the overlapping of the wedge-shaped ends of the pieces B and G, the latter being pressed downwards by a spiral spring enclosed in a chamber recessed in the piece G. In order that the Scotch feed may work smoothly and correctly, it is advisable to have the pulley V vertically above the rollers T, and the centre of the arc, in which B swings, vertically over the carriage when in the centre of its travel. The end H is pulled downwards, and all strain kept off the sliver by attaching the end of the rod J to the carriage by means of a cord. The speed of the carriage, and the rollers which it contains, must be made to correspond with the rate of delivery of the rollers T, so that the sliver may be kept tight without being broken. The surface speed of the feed lattice of the carder must likewise be so made to conform with the speed of delivery of the sliver

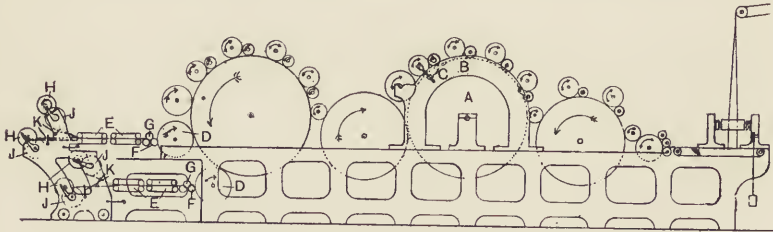

FIG. 75.—Carder and condenser for preparing slubbing from short waste.

to it that its entire surface may be equally covered without interruption, the edge of one row of sliver overlapping the one preceding in a regular manner. Until we come to the last swift of the carder, fig. 75, the arrangement of feeds, lieker in, angle strippers, breasts, swifts, workers, strippers, doffers and fancies is similar to that already described for the scribbler. The manner in which the swifts and their surrounding rollers are supported by means of "bends" is shown in connection with the swift A, fig. 73. The bends B are castings of semicircular or horseshoe form bolted to the sides of the framing. The fancy is supported upon a projection, as shown, while the workers and strippers work in brasses socketed upon the ends of screwed spindles, held in a position quite radial to the swift by means of metal straps. These screwed spindles, traversing a block C bolted upon the inside of the bend, may thus be screwed in and out to adjust the distance apart of swifts and rollers, which in a fine card is infinitesimal, although no roller, except the fancy, should actually touch the swift. The workers and strippers may be brought into light contact occasionally in order that the latter may keep the former keen; but, generally speaking, the clothing of both swifts and rollers should be

regularly ground and sharpened by means of emery rollers, in a manner to be described. The apparatus joined to the carder, to the left of fig. 75, is a condenser of the system known as a double doffer, tandem rubber, six or eight bobbiner. Such a machine is capable of making as many as ninety-six good threads and two waste threads from the fleec taken from a carder 60 inches wide, each thread frequently weighing no more than 300 yards per ounce. The way in which this is accomplished is as follows:—The doffers D are ringed, that is to say, their clothing is put on in perfectly parallel rings, alternating with spaces, the rings in one corresponding with the spaces in the other. One outside ring of each doffer is much broader than the others, its object being to take off the fibres on the edges of the swift which are defective, and to form them into a waste thread. As a general rule the rings upon the bottom doffer are slightly broader than those upon the top doffer, since the latter, meeting the fully-laden swift first, is apt to rob its comrade, causing the threads from the latter to be lighter, if the collecting surface of the rings be not increased. The ring doffers are stripped by small stripping rollers F covered with fine filleting, which are in turn stripped by smaller but similar stripping rollers G. Dividing rollers are now often introduced between the stripper and the rubber leathers, especially in fine machines, where difficulty is often experienced in keeping the threads apart by reason of long fibres and threads which unite them. The dividing roller should revolve at the same surface speed and in the same direction as the narrow ribbons of sliver and have as many V-shaped grooves as there are slivers passing over it. If the rubber leathers be given a slight lead, the ribbons may be drawn down into the grooves and kept separate. The rubbers E are leather aprons stretched over rollers as shown. They lie one on top of the other, almost or quite in contact, and having a reciprocating horizontal motion in different directions given to them by means of eccentrics, they rub the narrow slivers, which pass between them, into round and comparatively strong rovings or slubbings, at the same time delivering them forward to be wrapped upon the condenser bobbins H, which lie upon and are turned by the surface drums I. Wire guides K, with a rather quick horizontal traverse, build the slubbing into compact cheeses lying close together, but quite distinct, upon the barrel of the same bobbin. The prepare with which the material is impregnated keeps the rubber leathers soft and in good working condition. The leathers are usually plain, but occasionally, where difficulty is experienced in getting the stuff to turn over and rub into a strong slubbing, scored leathers of various makes are employed. The stripping roller F, working against the ring doffer, should be given a very slow backwards and forwards traverse to avoid being marked by the constant wear of the rings always in one place.

The presence in the material of long fibres and threads, and consequent

difficulty in the separation of the threads of slubbing, renders the use of the tape condenser preferable in some cases. In machines of this type, the division of the web from a plain doffer is effected by means of leather, tape or steel bands crossing each other and pressing against the rubber leathers. In condensers of the roller type which are suitable for fine slubbings, leather-covered rollers take the place of endless leather aprons. A series of these rollers are placed in pairs, fairly close together, one advantage of the arrangement being that with certain materials a lighter slubbing and increased production may be obtained by arranging the surface speeds of the rollers in such a way that a slight draft is obtained between each succeeding pair of rollers.

Card Clothing, or "Cards."—The clothing of cards for this description of work is put on in leaves or filleting, and is of the same class as that used for woollen, cotton or cotton-waste carding. It is extremely fine as compared with the ordinary clothing for flax, tow, hemp or jute cards, having from 100 to 600 pins per square inch. Its closeness and fineness, if kept keen, enable it to hold the short fibre, so that a very small percentage of waste is made; but, on the other hand, necessitates the use of the rollers called *fancies*, whose work is to raise the material, embedded in the pins, in such a manner that it is caught and carried off by the doffer. Were these rollers not employed upon the swifts, the pins of the latter would, in less than an hour, become so choked up with the fibre that they could no longer do any work. Even as it is, the cards must be stopped for "fettling" once a day, and even more frequently, when working dirty material. Fettling consists in clearing dirt, dust and short fibre out of the teeth of the card clothing by means of a species of comb known as a "fettler." The card clothing consists of staples of steel or iron wire set in leather or cotton cloth with indiarubber foundation. When set in leather, the leather should be of the best elastic calf hide, and put on in sheets about 5 inches wide, and in length equal to the width of the card. Filleting has almost invariably a foundation of cotton and indiarubber, and is put on in long strips from 1 inch to 3 inches wide, and wound spirally round the roller to be covered. In filleting, the pins are set in one of two different ways, known as "ribbed" and "twilled." The latter always shows a spiral groove when wrapped round the roller, while ribbed filleting joins up close. The leaves of clothing are tacked upon the surface of the roller, being well stretched the while. Filleting is also held by tacks at the ends, and at intervals in its length. There must, of necessity, be a space between the leaves of card clothing, but filleting is continuous, and for that reason is to be preferred, especially for the last swift and doffer, so that a continuous fleece may be obtained. The keenness of the clothing and the setting of the rollers are points of the utmost importance in carding fine material on cards of this description. If the clothing be not keen and the rollers sufficiently closely set, the material

will be rolled into balls and drop to waste below the card or be spewed out at the outside edges of the card. The finer the material, and the greater the number the threads of slubbing to be taken off the condenser, the closer must the cards be set. Although fine gauges are useful in setting or "keying" a card, yet, in many cases, the ear and eye can only be relied upon to insure that the rollers are not actually in contact. If light can be seen between the rollers, and no sound of brushing be heard, the rollers are out of contact. Such fine setting as we have described renders it absolutely necessary that the rollers should be perfectly cylindrical, and the pins of uniform length. To this end, the rollers are ground by emery rollers of equal breadth brought in contact with the pin points, and turned in either or both directions. In the case of workers and strippers which can be lifted out, this operation is accomplished in what is known as the grinding frame. For the swifts and doffers, the emery roller must be put in the place of the worker or stripper, and the swift or doffer and grinding roller turned in the desired direction. A little sharpening may be done at any time by means of a piece of wood covered with emery and known as a "strickle." This grinding puts a chisel point on the pins or wire, the same being frequently burred, which prevents the card working very well until the burrs have worn off, by use, or, in the case of the swifts, by the action of the fancy roller, and a more or less perfect needle point been formed. The fancy roller, at least, should be covered over, as this roller often throws out loose fibre. The waste shown will be lessened by covering in the cards completely, as in cotton waste spinning, but for fine work a smoother yarn will be obtained if the cards be left uncovered, for the flowings are apt to accumulate in the covers and get away in lumps.

The Drury Spinning Apparatus.—For very coarse yarns the slubbing may be spun directly and wound upon bobbins in the condenser itself by the use of a machine invented by a Mr Drury. As it is only suitable for very coarse work, a short description will suffice. The ribbons are stripped from the ring doffer by means of a specially shaped needle, then passed through an eye and caught between two revolving endless tapes, which, turning in contact and in opposite directions, impart twist and form a thread, which is then wound upon bobbins in the ordinary way.

Porritt's Spinning Frame for Short Waste Fibre.—Fig. 76 gives a view of a special spinning frame patented and successfully used by Messrs Porritt Brothers, for spinning flax noils into yarn up to 4 leas per lb. when the author was in Leeds some years ago. Its leading feature is the arrangement A, for putting in twist while drafting is going on—a course rendered necessary by the shortness and irregularity in length of the staple. This shortness and irregularity, combined with smoothness and inelasticity of the fibres, are the chief difficulties to be overcome, to which must be added, in the case of hard waste, the presence of pieces of thread twisted in the wet

state. Like Mr Raabe, Messrs Porritt Brothers formed their roving or slubbing by carding the material upon a scribbler and carder, such as are

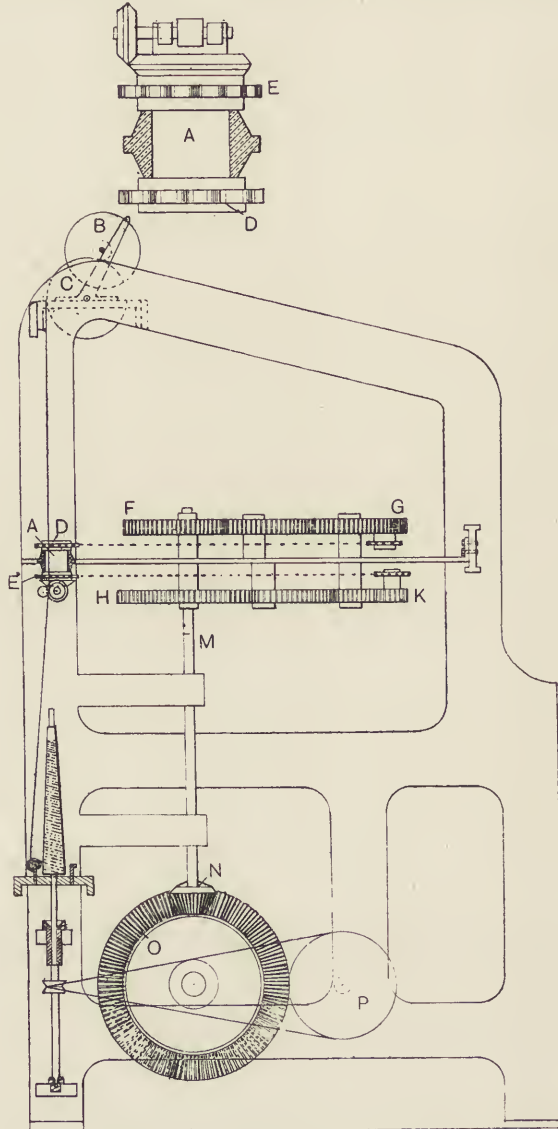

FIG. 76.—Porritt's dry spinning frame to spin slubbing of flax noils or waste from the condenser bobbin.

used for wool, and which have been shown in figs. 73 and 75. The fleece from the doffer of the carder was divided into narrow ribbons by means of

a condenser, such as has been described, which rubbed the said ribbons into a round slubbing that was wound upon the condenser bobbin shown at B, fig. 75, resting upon the surface drum C, the revolution of which causes the weak slubbing to unwind and pass down to the drafting and twisting apparatus A. The latter consists of a tubular boss A, turning in bearings fixed in one of the frame rails, as shown. At the upper end of this tube a sprocket chain wheel D is fixed. The lower portion of the tube A forms a bearing for two horizontal spindles, a boss on each of which forms the drawing roller. They hold and draw the slubbing by reason of pressure applied to them by springs. One of them is the driver, receiving its motion through a pair of bevel wheels, one fixed on the end of the roller and the other keyed on the pap of another sprocket wheel E, both turning freely upon the end of the tube A. It will be seen that the two together form a species of epicyclic gear, for the effective speed, and consequently, draft, imparted to the roller is materially effected by the direction in which the tube A is turned by the sprocket wheel D. The sprocket wheel E and bevel wheel must be driven in a contra-clockwise direction, in order to cause the rollers to draw the material downwards. If left hand twist is being put into the yarn, the tube must be driven in a clockwise direction by the sprocket wheel D, in which case the rollers gain in speed, since they are carried round their driver, while if the tube be turned in the opposite direction the rollers lose in drafting power. To modify these conflicting elements and to attain any desired result, the change gearing F G, H K is provided, both lines of gearing being driven by the vertical shaft M, turned by the bevel wheels N and O. The spindle, ring rail, ring and traveller are arranged in the manner shown and as previously described, the spindle being driven by the tin cylinder P.

The Celestin Martin Twist Tube Frame.—One of the best machines for fine waste spinning, and as regards production, is that made by the Société Anonyme Celestin Martin of Verviers, Belgium. It is a ring spinning frame, constructed in a somewhat similar fashion to the frame shown in fig. 76, and drafts and spins the slubbing from the condenser bobbin.

The drawing out or drafting of roving composed of the material of which we are now treating, which, unlike cotton, has no natural adhesion, is a most difficult matter. It cannot be done on a short reach on account of the presence of occasional long fibres. Upon a longer reach it cannot be satisfactorily accomplished without keeping the slubbing bound together, by means of twist, with the aid of a twist tube, an ingenious form of which is an important feature of the Celestin Martin frame. This tube, situated between the feed and drawing rollers, puts a sufficient degree of false twist into the slubbing to bind the fibres together and prevents the drawing away of short fibres from the long, which would occur were no such arrangement introduced. The theory of the twist tube is somewhat similar

to that principle of the woollen mule by which a draw is given to the slubbing, after it has got a little twist, through the stoppage of the rollers before the carriage has reached the end of its outward run. It is well known to woollen spinners that, if this slubbing has any irregularities, the twist will always run into the thin places, first leaving the slubs or thick places still soft and susceptible of elimination by a draw. In this way woollen yarns are frequently rendered more regular than the slubbing from which they were spun, and so, in this Belgian frame, there is a chance of a thick portion of the slubbing getting more than its share of the draft and being in consequence considerably reduced in size while the yarn gains in levelness.

The Waste Mule as used for cotton waste spinning may also be employed in spinning flax-waste and noils. Its chief disadvantages are—small production, impossibility of drafting, and difficulty in avoiding snarls.

On account of the non-elasticity and the immediate setting of the thread undergoing twisting, it is impossible to give any "gain" to the carriage. For the latter reason there is more yarn to be "backed off" the spindle top—hence the snarl, if the ends be not lifted off the spindle tops by a special motion before the end of the draw. Lack of elasticity in the thread also renders a "checking up" motion imperative to prevent snapping of the ends through contraction by twist. There should be two lines of bottom delivery rollers and one of top self-weighted rollers lying between them, in order that the slubbing may be firmly held. For 5 to 10 lea yarn, a mule of $2\frac{1}{2}$ inch gauge, and for 10 to 20 lea yarn a mule of $1\frac{3}{4}$ inch gauge, will be found suitable. Since the mule is not a constant spinner, its production is comparatively small for the large floor space occupied; hence a ring frame with twist tube is to be preferred for cheap production.

Ramie Waste Spinning.—Short ramie waste and noil is usually carded on a cotton card, and spun in the usual way.

CHAPTER XV.

YARN REELING, WINDING, DRYING, COOLING, AND BUNDLING.

Wet Warp Winding from the Spinning Bobbin.— Under ordinary circumstances most of the yarn from the spinning room is reeled into hanks, which is the form in which spinners usually sell to the weavers. If the spinners are weavers in addition, they may wind their warp yarns directly on to tin spools, upon a frame similar to fig. 80, and their wefts on to pirns or paper tubes upon a pirn-winding frame. It is every day becoming more common for spinners to sell their yarn in the workable form of cheeses and cops, and really, except when yarn is to be bleached, dyed, or boiled, there is no use in going to the expense of the intermediate process of reeling.

In the process of reeling, hanks are formed by winding the thread from the spinning bobbin round the circumference of the swift or fly, forming a continuous length 3600 or 1800 yards long, subdivided for convenience into twelve parts, each 300 or 150 yards in length. When made in the former way, the swift is $2\frac{1}{2}$ yards in circumference, 120 turns being consequently required to form each cut or lea of 300 yards, twelve of which cuts form the hank. If made up in the second way, the yarn is said to be "short reeled," for the swift has a circumference of only $1\frac{1}{2}$ yards, or the same as that of the swift of the cotton reel. Unlike the cotton standard, however, 100 threads or rounds of the reel go to make a cut or lea, twelve of such cuts forming the hank, which is consequently equal in length to one-half of a long-reeled hank. Flax and hemp yarn reels are generally double—that is to say, the same gables support two swifts, each of which gives employment to a reeler. The centre of the swift should be about 20 inches from the ground for the long reel and 26 inches for the short reel. The shifter or bobbin carrier, which extends the length of the reel, should lie close to the top of the swift, projecting backwards from the centre line. As the strain put upon the yarn, and consequently the ease with which it may be reeled, depends very much upon the construction of the reel itself, we will try to describe the principles to be borne in mind in designing a good reel.

The swift should be light and well balanced, so that it will remain at rest in any position, and never turn backwards of its own accord. In order

that the periphery of the swift may be nearly circular, the latter should have a sufficient number of rails and spokes, twelve being the most suitable number for the long reel and eight for the short reel. If the swift has a less number of spokes than that named, the segments formed between the rails will be too great, and will cause the yarn to be drawn irregularly from the bobbin and subject the thread to jerks and strains, causing excessive breakages in fine and weak yarns. If, on the other hand, the rails be too numerous and consequently close together, they are liable to injure the fingers of the operative and retard her progress when putting in the leasing. The standard sizes are, as we have said, $2\frac{1}{2}$ yards or 90 inches and $1\frac{1}{2}$ yards or 54 inches, being known as the 90-inch and 54-inch reel respectively. The actual circumference may be made rather less than this, however, say $\frac{1}{16}$ inch for the short reel and $\frac{1}{8}$ inch for the long reel, for the reason that the threads, lying more or less one on top of the other, increase the effective diameter of the reel. The swift is made collapsible in order that the hanks of yarn may be taken off it. A flange screwed to one pair of spokes is firmly secured by set-screws to the hollow barrel upon which the swift is built. The others may be freely moved round upon their axle or barrel. The swift is distended while at work, and the rails kept in place and at equal pitches by means of tapes attached to the inside of each, and to the fixed rail by means of a ring and screw. When the yarn is tightly lapped round the swift, the latter could not be conveniently caused to collapse were not one set of spokes arranged in such a way that they may be shortened and the rail at that end brought in towards the centre, and the yarn sufficiently slackened to admit of the other rails being brought together.

In order that the rail may be brought in towards the centre in the way we have described, it is either attached to slotted brackets clamped to the spokes by means of thumbscrews, or else to a bracket turning upon a pivot on the shortened end of the spokes. The swift turns upon ends shrunk in the barrel, and either turns in open bearings so that the end may be lifted out and the yarn passed over it when doffing, or in closed bearings, in which case a half-moon arrangement is required in order that the yarn may be passed round the centre.

A double-power reel is most conveniently turned by means of friction bowls, of leather or paper, on either end of a short shaft, driven at a slow speed by a belt from the line shaft. Friction plates are pressed against the bowls by means of footboards, connecting levers and rods, so that the reel may be started at will and stop of its own accord when the reeler removes her foot. Reels propelled by hand, and power reels with a handle and fast and loose pulley, are still at work, but are becoming rarer.

Upon the other end of the swift axle to that at which the yarn is usually taken off, is a worm working into a bell wheel upon a vertical or

horizontal spindle. A pin in the bell wheel presses back a spring, upon the end of which is a brass bell, which is thus caused to sound at each revolution of the bell wheel. Theoretically the bell wheel should have 120 teeth for the long reel and 100 teeth for the short reel, but usually one to four extra teeth are given in order to make up for any short count caused by broken threads. The worm upon the axle end is single-threaded, so that every time the swift completes 120, 100 or more revolutions, the bell rings, showing that a cut of yarn has been reeled.

Upon modern reels the rotation of the upright spindle carrying the bell wheel is used to give the bobbin carrier or shifter the lateral motion necessary to spread and build the yarn properly upon the swift. The shifter is of wood, about 6 inches in breadth and rather shorter than the reel. It has two cast iron ends, upon which it slides in the gables of the reel. The inside of one end piece forms a rack into which works the shifter pinion, upon the elongated part of which is a worm wheel actuated by the worm upon the upper end of the bell wheel spindle already alluded to. Starting close up against one gable of the reel, the shifter is thus moved, either to the right or left, a distance of some 3 or 4 inches, while the bell wheel makes twelve revolutions. After each hank has been completed the shifter must be lifted out of gear and put back into its starting position to the right or left. We have seen shifters moving both to the right and to the left, it being a matter of indifference when the reeler is once accustomed to it.

Yarn is said to be cross-reeled when the shifter has a quick backward and forward traverse across the face of the hank. Leasing is dispensed with for cross-reeled yarn, which is more easily wound again from the hank. The shifter should make four complete traverses for each revolution of the swift, cross the threads four times, and thus form complete diamonds in the round of the swift. The required motion may be easily given to the shifter by means of an eccentric driven from the axle of the swift and actuating a bell-crank lever by means of a connecting rod.

The bobbins of yarn are usually placed upon brass sockets which turn freely upon iron pins set at suitable distances along the shifter. In an old-fashioned reel of Continental make, the bobbins are placed upon short spindles turning freely in collars and steps fixed in a stationary rail, but in order that the tension of the yarn being reeled may remain as constant as possible, it is advisable that the bobbin should be actually upon the shifter in order that it may always maintain its position relative to the wire guide upon the front edge of the shifter.

Twenty to forty bobbins are usually carried upon the shifter at a distance of from 3 to 5 inches apart, according to the coarseness of the yarn being reeled and giving to the shifter and swift a length of from 8 to 10 feet. A 20-hank reel of 5-inch pitch is suitable for the coarser yarns up

to 16 leas ; a 25-hank reel of 5-inch pitch for yarns 16 to 30 leas per lb., a 30-hank reel of $3\frac{1}{2}$ -inch pitch for yarns of 30 to 100 leas, and a 40-hank reel of 3-inch pitch for all finer yarns.

The traverse given to the shifter must be rather less than the pitch of the bobbins in order that there may be a small space between the completed hanks. Thus a 23-worm wheel compounded with a 20-shifter pinion working into a rack of three teeth per inch will give the $\frac{120 \times 20}{23 \times 3} = 3\frac{1}{2}$ -inch shift suitable for a reel of 5-inch pitch.

Reels are still at work without automatic shifters, but the quality of the work which they turn out is inferior, because the yarn in each cut is built too much in one place and not properly and evenly spread. The number of revolutions per minute which a 90-inch and a 54-inch swift may make is about 70 and 100 respectively, but naturally depends very much upon the quality and strength of the yarn. The length of yarn between the bobbin and the point where the thread first touches the swift should be as short as possible in order to reduce breakages to a minimum ; and although the pins upon which the bobbin socket turns should be well oiled, care must be taken that the wooden shifter does not get so much saturated with oil as to run a risk of staining the yarn upon the swift, as sometimes occurs, especially in summer.

Having described the reel itself we will now speak of the manner of reeling, and draw attention to some important points which must be carefully watched if the hanks are to be easily rewound without excessive waste, in the factories of the weavers, upon the warp drum winder or the pirn weft winder.

The first operation of the reeler is to place and distribute her cages or trays of bobbins before her upon the box or reel which separates her from her comrade opposite. She may then place a bobbin upon each spindle or socket and bring the ends, four or six at a time, through their respective guides and attach them to one rail of the swift, which she has previously distended to its full circumference. Having satisfied herself that both bell and shifter are in their starting positions, she may now put the swift in motion by hand, or, if it be a power reel, by placing her foot upon the footboard, or by putting on the handle, if there be one. She must, while finding the ends and preparing fresh bobbins, keep a good look-out for a broken end or empty bobbin, and when such occurs stop the reel immediately, replace the bobbin, find the end and unite it with that upon the swift. She must find this latter, as when a bad reeler breaks a whole thread and joins it up, or puts her end between a hank and the rail without knotting the ends together, she adds to the labour of the winder and perpetrates the faults of cross-reeling and broken threads of which the winder reasonably complains. When the first cut or lea is completed, the

reeler cuts off the starting ends, which she ties to a rail of the swift and ties each of them in two loops round their respective cuts, drawing the latter at the same time slightly to one side at that place, in order to leave a small space between it and the following cut, which she then proceeds to wind in a similar manner. When the bell rings for the second cut, the reeler must first see that all the ends are whole and then commence to put in the "leasing." The object of leasing is to maintain each cut separate, in order that they may be easily counted and the broken threads easily found in winding.

Leasing is a fine twine of linen or cotton yarn about 1200 yards per lb. It should be cut in lengths about two and a half times as long as the breadth of a completed hank, or 8 to 12 inches. The middle portion of the short length of leas-band is placed round the first cut, the ends crossed and placed around the second cut, then crossed again and doubled into the threads upon the swift, ready at hand to continue the operation when the third and following cuts are completed. When the last or twelfth cut or lea is finished, the two free ends of the leas-band are made into a knot along with the end of the yarn, and all cut off short. The leas-band must not be tightened up too much, confining the cuts too close together, as in this case, if the yarn is to be boiled, bleached or dyed, difficulty will be experienced in obtaining good results, as the chemicals or colouring matter will be unable to penetrate between the threads where they are closely held together by too tight leasing.

The reel being finished, the swift may be collapsed and the hanks of yarn removed in one or more bouts, each of which should bear a ticket giving the number of the frame, yarn, and reeler.

To prevent mistakes, it is also advisable to have tickets of special colour for each mark of yarn. The knot used by the reeler in joining her ends should be a small one, known as a weaver's knot. It is made by holding an end in either hand, crossing them the right under the left, passing the long end in the right hand round the back of its own extremity, and in front of that of the end held in the left hand, forming a loop, which is held in place between the first finger and thumb of the left hand until the short end of the thread held by that hand is passed backwards through it and held under the thumb while the loop is drawn tight, forming a fast knot. All other knots which bad reelers like to make, such as overthumb or granny's knots, bunch knots, etc., must be rigorously suppressed, as they are too bulky, showing up badly in the cloth, if they do not break the thread by sticking in the shuttle or heedle eye or reed of the loom.

Odd hanks of yarn should be counted regularly, to prevent the reeler giving too many threads under or over count, and to detect and punish double cuts and faulty reeling.

Double cuts occur when the reeler, through negligence, forgets to insert her leasing at the completion of a cut, in order to separate it from the one following. The appearance of the yarn will be much improved by foreing the reelers to throw the short ends or cuttings which they make, well behind them, and not allow loose threads to become mixed with those upon the reel.

What is known as chain leasing is sometimes employed to provide half hanks to be used as bands in the bundling process, which we will describe later on. Chain leasing consists in tying two knots, about half an inch apart, upon the lease-band between the sixth and seventh cuts. The hank is thus easily separated into two parts when such are required, by cutting the band between the knots referred to.

A reel to be found in some German mills is designed to obviate the necessity of stopping the whole machine when a thread breaks or runs out, and to work more or less automatically. The swift is divided into sections long enough to accommodate ten or twelve hanks. The threads, when running, pass over and depress levers which, when released by the absence of the thread, rise and allow their tailpieces to engage with and stop the motion of an oscillating bar or revolving shaft, stopping one section of the swift in the same way and by similar means as in a cotton drawing frame, to which one of the older mechanical stop motions is applied.

It is a good idea to keep the greater part of the swift running while an end is being knotted, but the difficulty in keeping the automatic stop motion in order takes away any advantage, and shows once more that a simple machine is often the best.

Although the usual method, reeling is not the only way in which flax, hemp, and jute yarns are prepared for market.

Cop Winding.—It is becoming day by day more usual to sell fine flax wefts upon paper tubes which may be put directly into the weaver's shuttle, or from which the yarn may be pulled off endwise. The yarn is wound upon these tubes either on the spinning frame, in the manner described in Chapter XII., in which case it is also dried upon them, or it is dried on the bobbin and then wound upon the tube on a cop-winder, such as Boyd's.

In Boyd's cop-winder the spindles lie almost horizontally and are pressed into conical cups by means of a lever. The end of the spindle, which passes through the cup and upon which the empty tube is placed, is removable, and is driven by a clutch from the butt of the spindle which passes on a feather through a bevel pinion which drives it from the spindle shaft pinion. The thread guides are fixed upon an oscillating shaft, and have a traverse about equal to the height of the cone inside which the cop is formed. When the tube is empty it protrudes through the cop, and the yarn is lapped upon its base until it accumulates to such an extent that

its diameter becomes greater than the diameter of the cone, and it is forced backwards with the spindle which drives it.

In this way, the base of the cop being formed, the sides are kept perfectly parallel, the nose of the cop being always of the same conical shape as the interior of the forming cone or cup. An ingenious stop motion is arranged in such a way that when the tube becomes full the lever which pushes the spindle forward overbalances itself and draws the cop back, when the clutch disengages itself and motion of that spindle ceases. The firmness or hardness of the cop depends upon the tension of the yarn as it is drawn off the bobbin, upon the pressure with which the nose of the cop is pressed into the cone, and upon the length of the thread guide traverse. The thread is better bound together with a long traverse, a short traverse tending to make the cop brittle. Most cop-winders are built upon somewhat similar principles, but the spindles are vertical in many cases.

Fig. 77 shows a double cop-winding machine to wind flax, hemp and jute yarn direct from the bobbin and form cops 1 to $2\frac{1}{4}$ inches in diameter and from 6 to 12 inches long.

Yarn Drying.—There are several ways of drying yarn which has been spun wet or demi-sec. Woft yarn spun upon paper tubes for direct weaving, yarn upon the spinning bobbin and intended for the pirn or cheese winder, and warp yarn which has been wound wet on to tin spools for the warping machine, is generally put to dry in a hot chamber or “stove” in which the bobbins, tubes or spools rest upon iron plates, forming the lids of flat chests heated by steam. The difficulty of this sort of drying is the property which the yarn has of becoming slack upon the paper tube or bobbin, and of “drying away” from the head and base of the bobbin or spool upon which it is wound.

In the case of tubes, improvements have been made in their construction which remove this difficulty to some extent, but the difficulty of winding from wooden or metal bobbins without waste still remains, together with the inconvenience caused by the warping by heat of spinning bobbins dried in this way. Wooden bobbins which have been warped by heat may be brought back into shape by mixing and covering with damp sawdust and turning once or twice in the course of a few days.

As regards the drying of yarn in hanks, the reels of wet yarn should be collected from the reelers several times daily and handed over to the drying-loft men.

While it is being removed a note should be taken of the quantity of work turned off by each reeler, as the piecework system of payment is the most satisfactory, and almost universal.

Of the various methods of hank drying, the author believes that natural air-drying is the means best calculated to retain the “nature” in the yarn.

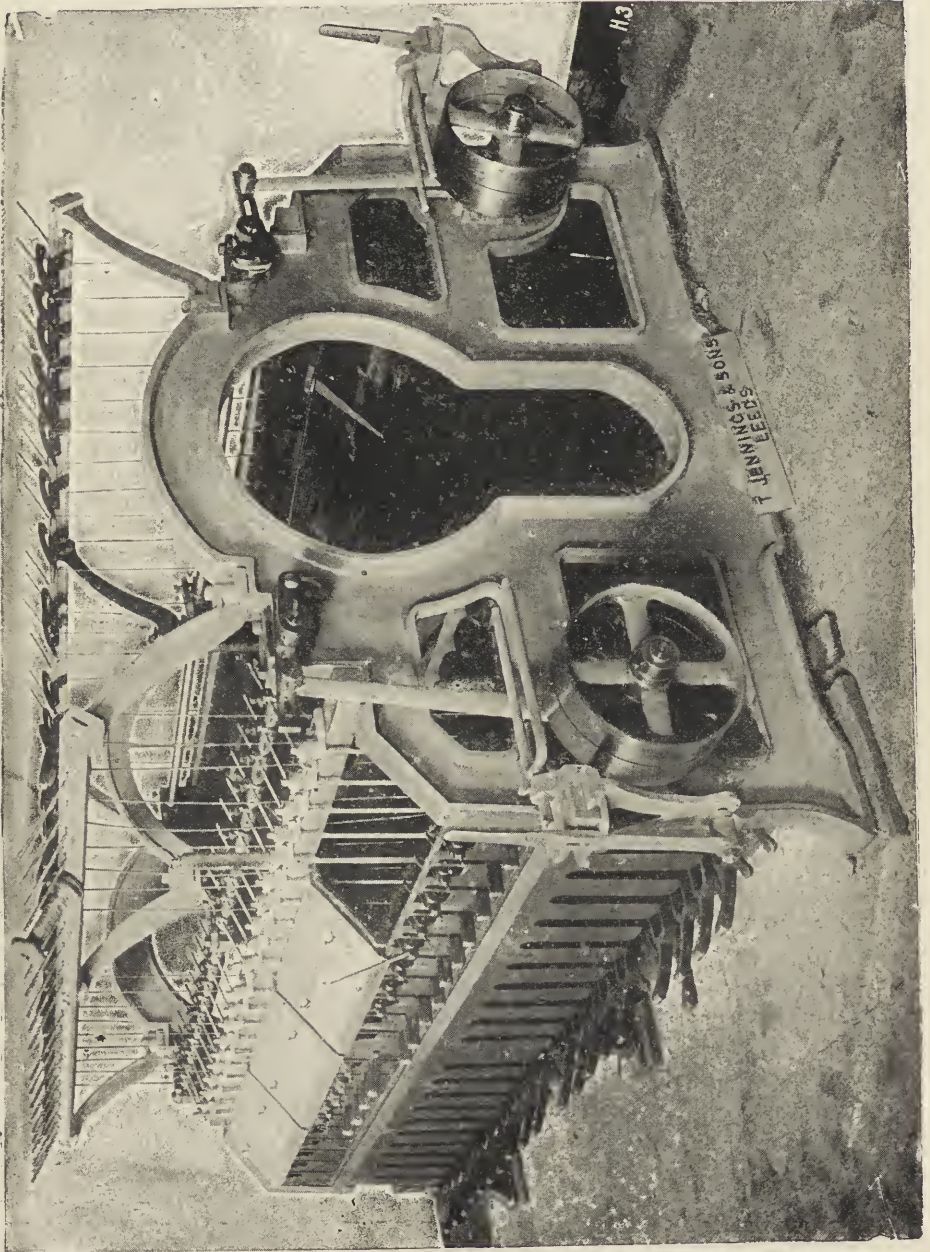

FIG. 77.—Double cop-winding machine.

Most mills lack space to dry their yarn in this fashion, even if the winter temperature and climate were suitable. Of quick methods of drying, that in which a current of dry and warm air is drawn through the yarn by a fan approaches most closely to the ideal.

The theory of all drying is, of course, the absorption of the moisture in the yarn by the dry air with which it is brought in contact. Since hot air can absorb and hold more moisture than can cold air, the former is usually employed, being removed or allowed to escape while still warm in order that it may carry its moisture with it.

In order that the yarn may be brought into intimate contact with the drying medium, the hanks should be well spread out upon poles long enough to contain, say, one reel of yarn. A second pole is usually suspended in the hanks to keep them straight and prevent their twisting round while drying, as they are inclined to do. The drying poles are supported in racks at either end, and when covered with yarn should be placed about 6 inches apart. Since the yarn actually touching the poles is prevented more or less from drying, when half dry the hanks should be rolled round, changing their position and exposing that portion of the hank.

Next to natural air-drying, perhaps the most economical method is to employ the heat thrown off by the boilers, which is considerable, even if they be covered with a nominally non-conducting composition. This is often done by constructing the drying loft immediately over the boiler house, in a series of flats and stages with openwork floors to allow the heat to ascend. To minimise the risk of fire, the structure should be almost entirely of iron laths and girder beams, supported by columns. A fire, if it occurs, may be quickly extinguished if a means be provided to allow a quantity of live steam to escape into the loft from the boilers underneath in case of need.

If the wet yarn be spread upon the poles during the day and all the windows shut at night, the air will, if of sufficient volume, absorb the moisture and dry the yarn. The hot and moisture-laden air is allowed to escape in the morning through the open windows, or is drawn off by a fan.

Fans are being employed more and more every day to assist drying. This they do by causing a current of air to circulate among the yarn, thus carrying off moisture-laden air and causing it to be replaced by dry air, which is more efficient as a dryer if it has been heated in circulating round the chimney or flues, as can easily be arranged, or drawn from the boiler-house, if that building be not immediately under the drying loft.

There are at least two other methods of hank drying in use. That known as the Scotch system is still at work in some Continental mills. Under this system the hanks of wet yarn are stretched in frames, which are placed in a vertical or horizontal air passage, which they completely fill.

Air, heated by a system of steam pipes, is drawn rapidly through the yarn by the aid of a fan.

The frames of yarn are put in at one end, moved onward automatically, and taken out at the other end, the operation being almost continuous.

Another system of hank drying consists in the use of a drying machine composed of a number of copper cylinders heated by steam which passes in through the hollow axles. These cylinders revolve, while round and between them are passed the hanks of damp yarn, linked together by rods, the whole machine resembling in principle the drying portion of a slashing or yarn-dressing machine. By using this method, the hanks are well stretched and the yarn has a more wavy and smooth appearance, which may in some cases add to its value. The greatest care is required in the use of this machine lest the yarn be scorched. The heat of the cylinder must be kept regular and the machine run through before a stoppage. Drying-loft men are generally paid piecework, *i.e.* per 100 hanks. One penny farthing per 100 hanks with an average lea of 75's will be found about right. If the average lea be lower the rate should be proportionately higher, since the work is heavier, and *vice versa*. As regards the dimension of an ordinary drying loft required to dry a given daily production of yarn, it will be found that a loft of 100,000 cubic feet capacity, divided into four storeys, with 9 feet head room and openwork floors, closed up and heated during a period of five to eight hours per night by 500 feet of 8-inch piping, filled with steam at an initial temperature of 300° F., will dry 1600 bundles of yarns averaging 75 leas per lb. The duration of steaming depends very much upon the weather and the arrangements of the loft with regard to fans or other means of producing a draught through it during the day-time, while the loft men are engaged in taking off and spreading the yarn upon the poles.

Yarn Cooling.—The complement of yarn drying is yarn cooling. To dry out the moisture from the core of heavy yarns, especially in a short time, by air at a high temperature, the outside of the thread is overdried and the yarn is in a harsh and brittle condition unfavourable to weaving. In this state the yarn must be allowed to absorb, with uniformity, about 5 to 8 per cent. of moisture, which it will do naturally if exposed to the outside air for a sufficient length of time. Want of space to accomplish this exposure forces most mills to water their yarn with a watering can and then to pile the damped yarn in order that the moisture may spread through the whole, as it will eventually do if the pile be frequently turned over. A cooling shed, with openwork sides and roof, in which the yarn is hung on poles as in the drying loft, is much to be preferred, especially if the air be kept moist and cool by a humidifier, such as is shown in figs. 135 and 136. Another good way to cool yarn is to spread it upon an earthen floor, covered with bass matting, or even upon a tiled ground floor.

Yarn Proofs.—In order that yarns being spun may be kept to their exact number or lea, proofs of reliable exactitude as to count, etc., are almost indispensable, and certainly advantageous. For this reason, every mill should have a small sample reel of twelve spindles, upon which a careful reeler should daily make a proof of twelve euts of the yarn being spun on each frame. As there is no reason why one of these twelve threads should fail while a eut is being reeled, a bell wheel of the exact number of teeth, 100 or 120, for short and long reel respectively, should be provided, its efficiency being further enhanced by supplementing the bell by a hand or marker, which, after the ringing of the bell as a warning, may be slowly brought round to an exact spot and the correct number of threads obtained. Again, as there is no reason why the threads should not be well spread upon this reel, the circumference of the swift should be absolutely exact, that is to say, $1\frac{1}{2}$ yards = 1.372 metres for the short reel, and $2\frac{1}{2}$ yards = 2.286 metres for the long.

Since the number and weight of the yarn is most conveniently ascertained in the yarn department, we will here make a few remarks upon a subject which affects, perhaps more than any other, the value of a spinner's yarn and the profit which he may make through spinning it.

In the first place, the uniformity in weight or "grist" of the yarn from bobbin to bobbin and from day to day, although seldom obtained by the consumers, is appreciated by them, since it affects the uniformity of their cloth. If, for instance, instead of a bundle of 30, a weaver is supplied with a bundle of the same weight, really composed of a half-and-half mixture of 28's and 32's, he will find his cloth correspondingly uneven in weight from yard to yard and piece to piece. The sewing-thread maker must be even more particular than the weaver, since two threads of dissimilar weight and diameter will not twist properly together, the smaller always trying to twist around the heavier, forming an unsightly thread, which is weaker than it would be were the strain equally divided among its component parts. For the convenience of those engaged in the trade at home and abroad we give the weight in lbs., ozs., and drams, and also in grammes, of a long reeled hank of flax or hemp yarn, corresponding to that of two short reeled hanks, both in the stove-dried state and under the atmospheric conditions prevalent in the British Isles. The author, after long experience and many experiments, believes that yarn in a stove-dried condition absorbs 8 per cent. of moisture if allowed to do so under natural conditions, and consequently holds that it is the amount of moisture which linen or hempen yarns should honestly contain. If they are sold drier, the spinner gives away an unnecessary quantity of material and a more brittle and less sightly yarn. If, on the other hand, the spinner sells a damper yarn, he may, in certain cases, make money by giving water instead of

yarn, but is liable to have to pay compensation through the yarns arriving at their destination light in weight through "drying in." The weights of the yarn given in the subjoined table are calculated upon the Irish linen yarn table. We should observe, however, that in the north of France, for

Lea.	Weight in Grammes of 1 Hank = 3600 yards.		Weight in lbs. and ozs. of 1 Hank = 3600 yards.						Weight in lbs. and ozs. of 1 Reel.					
	Cool.	Stove Dried.	Cool.			Stove Dried.			20 Hanks.		30 Hanks.		40 Hanks.	
			lbs.	ozs.	drs.	lbs.	ozs.	drs.	lbs.	ozs.	lbs.	ozs.	lbs.	ozs.
6	906	839	2	0	0	1	13	10	40	0	60	0	80	0
8	679	629	1	8	0	1	6	4	30	0	45	0	60	0
10	544	504	1	3	3	1	1	12	24	0	36	0	48	0
12	453	419	1	0	0	0	14	13	20	0	30	0	40	0
14	388	359	0	13	11½	0	12	11	17	2	25	11	34	4
16	340	315	0	12	0	0	11	2	15	0	22	3	30	0
18	302	280	0	10	11	0	9	14	13	5½	20	0	26	11
20	272	252	0	9	9½	0	8	14	12	0	18	0	24	0
22	248	229	0	8	11½	0	8	1	10	14½	16	5¾	21	13
25	217	201	0	7	11	0	7	2	9	9½	14	5¾	19	3
28	194	179	0	6	14	0	6	6	8	9	12	13¾	17	2
30	181	168	0	6	6½	0	5	15	8	0	12	0	16	0
32	170	157	0	6	0	0	5	9	7	8	11	4	15	0
35	155	144	0	5	7½	0	5	1	6	15½	10	4½	13	11
40	136	126	0	4	13	0	4	7	6	0	9	0	12	0
45	121	112	0	4	4½	0	3	15	5	5½	8	0¼	10	11
50	109	107	0	3	13½	0	3	9	4	13	7	3¾	9	10
55	99	92	0	3	8	0	3	4	4	6	6	9	8	12
60	91	84	0	3	3	0	2	15	4	0	6	0	8	0
65	84	77	0	2	15	0	2	12	3	11	5	8½	7	6
70	78	72	0	2	12	0	2	9	3	7	5	2½	6	14
75	73	67	0	2	9	0	2	6½	3	3¼	4	13	6	6½
80	68	63	0	2	6½	0	2	4	3	0	4	8	6	0
85	64	59	0	2	4	0	2	2	2	13	4	3½	5	10
90	60	56	0	2	2¼	0	2	½	2	10½	4	0	5	5
95	57	53	0	2	¼	0	1	14½	2	8½	3	12¾	5	1
100	54	50	0	1	14¾	0	1	13	2	6½	3	9¾	4	13
110	50	46	0	1	12	0	1	10	2	25¼	3	4	4	5½
120	45	42	0	1	9½	0	1	8	2	0	3	0	4	0
130	42	39	0	1	7½	0	1	6	1	13½	2	12¼	3	11
140	39	36	0	1	5¾	0	1	4½	1	11½	2	9¾	3	7
150	36	34	0	1	4½	0	1	3¼	1	9½	2	6¼	3	3
160	34	32	0	1	3¾	0	1	2	1	8	2	4	3	0
180	50	28	0	1	1	0	1	¼	1	5¼	2	0	2	10½
200	27	25	0	0	15½	0	0	14½	1	3¼	1	13	2	6½
250	22	20	0	0	12½	0	0	11½	0	15¼	1	7	1	14½
300	18	17	0	0	10¼	0	0	9½	0	12¾	1	3	1	9½

instance, the spinners, although nominally following that table, spin some of their numbers rather heavier. Thus, for instance, Lille spinners spin their 14's to weigh 40 kilogrammes per paquet, or 400 grammes per hank instead of 388. It is interesting here to notice the ease with which, under

the metric decimal system, the weight of a French paquet or six bundles may be calculated from the weight of one hank, for since there are 1000 grammes in a kilogramme, and 100 hanks in a six-bundle bunch or paquet, the weight in kilos of one hank of 14's lea is .388 kilo, and of one paquet 38.8 kilos.

The yarn table as used in the Scotch dry spun trade is as follows:—

Spyndle.	Hanks.	Heers.	Cuts.	Threads.	Yards.
0	0	0	0	1	2½
0	0	0	1	120	300
0	0	1	2	240	600
0	1	6	12	1440	3,600
1	4	24	48	5760	14,400

Another handy way of checking the number or lea of any linen yarn is to find the number of yards which weigh $\frac{1}{300}$ part of a pound avoirdupois. Such a number of yards correspond with the lea, since there are 300 yards in a cut.

The degree of twist in any given sample of yarn may be tested and found by the use of a handy little instrument in which a given length of thread, say 6 inches, is firmly held at one end, while the other end is turned in the reverse direction to that in which the thread was originally twisted, taking out the twist and registering the number of turns given, by a worm actuating a worm wheel, pointer and dial.

Thus if a hank of yarn be found to weigh 7 ozs. 11 drs. ; or if 25 yards be required to balance a small weight equal to $\frac{1}{300}$ part of a lb., the yarn is known to be 25's lea ; and if it be tested for twist and found to have 60 turns in 6 inches, or 10 turns per inch, it may be considered to have been twisted for warp on the basis of two upon the square root of the number, or $2\sqrt{25} = 2 \times 5 = 10$ turns per inch.

Yarn should be tested for strength frequently and regularly in order that its quality may be maintained and faults due to bad spinning detected and remedied.

The most convenient yarn tester for ordinary numbers is the "Porter." It consists of a plank, to the upper portion of which a Salter's spring balance is attached. At a distance below of about 34 inches is a plunger or piston, working in a vertical cylinder kept full of oil. The thread to be tested is attached to the hook of the spring balance and to the upper portion of the piston rod in such a way that the thread may not cut itself. The marker of the balance being at zero, the piston is allowed to descend in the cylinder, which it does very slowly and regularly, for there is a

small hole in the piston head through which the thick oil must pass as the piston descends. A gradual strain without jerk is thus put upon the yarn, and when it breaks the indicating finger is held in place upon the graduated scale by means of a rack and pawl arrangement, until the reading be taken, when it is put back to zero, the piston raised and another thread tried. Another yarn tester, as made by Mr Wm. Bywater, Leeds, is shown in fig. 78. It is very suitable for coarser yarns and twines, as it is made in various sizes and tests up to 1200 lbs. The strain is applied to the yarn by a hand wheel and screw as shown.

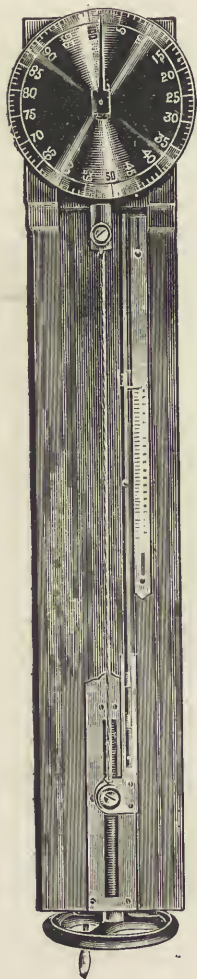

FIG. 78.—Yarn and twine testing machine.

Not less than ten threads of each sample should be tested to get a good average.

Bundling and Bunching Yarn.—There are two ways of making up hanks of flax, hemp and tow yarns for market: that is to say, they may be made into either long or short bundles or bunches. In length the long bunch is almost as long as the hank, say 40 inches, while the short bunch is only about half that length, or 20 inches. Yarns reeled on the 54-inch swift and short bunched, produce bunches about 13 inches long, resembling the cotton bunch. Scotch dry spun flax, hemp and jute yarns are almost invariably made up in long bunches, while coarse yarns in general are cheaply bundled in this way, which serves very well for any yarn which is to be delivered straight away to a neighbouring manufacturer or bleacher. If yarn is to be baled or sent long distances by rail or sea, it will arrive in a much better state if press bunched.

Long bundles are made in the bundling stool, which is a heavy and solidly-built stool about 46 inches long and 10 inches broad. Four or eight pegs form the sides of the stool at either side, leaving it an inside width of 8 to 10 inches. Twenty-five hanks or $1\frac{1}{2}$ bundles of coarse yarn, such as from 6 to 12 lea, will form a bundle of the dimensions given, while 50 hanks, or three bundles, may be united in a bundle of 14's to 25's lea, and 100 hanks or six bundles when dealing with finer yarns. In making a 25-hank stool bundle, four $\frac{1}{4}$ hanks should be used as bands, and being slightly twisted, laid across the stool at regular intervals; $1\frac{1}{2}$ hanks of yarn are then twisted into a head and laid lengthwise in the stool on top of

the bands. Four such heads form a row, and four rows of $1\frac{1}{2}$ hank heads, together with the bands, complete the 25-hank bundle, thus, $(16 \times 1\frac{1}{2}) + (4 \times \frac{1}{4}) = 24 + 1 = 25$.

The following table gives the ordinary range of breaking strains, in ounces, for ordinary wet spun numbers in flax line and tow yarns, while a good demi-sec spun line yarn in, say, 18-lea can stand a strain of 6 lbs., 8-oz. binder twine 100 lbs., 11 oz. binder twine 110 lbs., and so on.

Line Yarns.		Tow Yarns.	
Lea.	Breaking Strain in ounces.	Lea.	Breaking Strain in ounces.
10	56-76	10	46-56
12	46-65	12	42-49
14	44-62	14	37-45
16	42-56	16	33-43
18	40-52	18	30-42
20	39-49	20	26-40
22	35-42	22	24-38
25	32-37	25	22-35
30	29-34	30	20-27
35	25-30	35	19-25
40	22-26	40	18-23
45	19-25	45	17-21
50	18-22	50	16-19
55	16-18	60	15-18
60	14-17		
70	12-16		
80	11-15		
90	10-14		
100	9-13		
120	8-12		
130	7-10		
140	6-9		
150	5-8		
160	4-6		
180	$3\frac{1}{2}$ - $5\frac{1}{2}$		
200	3-5		
250	3-4		
300	2-3		

When his rows are complete, the bundler tightens the bands around his bundle in passing one end through the loop of the other, applying his knee and pulling tight, securing the end by tucking it once or twice under the tightened band. Fifty or 100 hank stool bunches are made in a similar manner, the former being composed of sixteen heads of three hanks, together with four half-hank bands, and the latter of sixteen heads of six hanks each, together with four one-hank bands.

Short bunches may also be made upon the stool, but the use of

the bundling press is now almost universal, and "pressed" yarn is preferred by manufacturers, since it is less tossed and broken, and the heads, if properly made, more easily opened out by the bleacher or winder.

A press suitable for a 25-hank bunch in 8's to 20's lea, 50 hanks in 20's to 40's lea, 100 hanks in 42's to 80's lea, and 200 hanks in 80's to 160's lea, may be conveniently 21 inches long, 8 inches wide and 12 inches deep when open, inside measurements. It is constructed of cast iron with side supports, between which the bands are placed, and corresponding hinged caps with clasps of various construction. The bottom is movable, and is raised to compress the bunch either by an Archimedean screw, with a nut, in the form of a bevel pinion, fixed in position and turned by another bevel upon the spindle of the hand wheel, with which the bundler applies the pressure without much labour; or by means of a spur pinion and cam wheel, the latter connected to the movable bottom by links, the lower ends of which embrace a stud fixed eccentrically in the cam wheel. Pressure is usually applied by hand in turning a capstan or hand wheel, upon the spindle of which, in the case of the screw press, is the endless worm actuating the worm wheel or nut block or the spur pinion giving motion to the cam wheel in presses of that construction; but power presses are not unknown in which the hand wheel is replaced by a fast and loose pulley and belt. A power press of this description should be provided with a knocking-off motion to shift the belt on to the slack pulley when the bunch is sufficiently pressed.

In making a 25-hank press bunch, four $\frac{1}{4}$ hanks are used as bands, each being separately and well twisted by a quick motion of the thumbs and fingers, while the hank hangs upon the "horn," a round bar of wood firmly fixed at one end. The bands are placed in position between the side supports and over the bottom of the press, which should be of wood and grooved to receive the bands. The heads are then formed, in the case in hand, 16 in number, each of $1\frac{1}{2}$ hanks laid in four rows of four heads each. To form the heads the bundler places a reel or half a reel of yarn upon his horn, and untwisting the hanks, separates the number required per head from the others. These he should turn round upon the horn to stretch and straighten the threads, pulling them tight occasionally with a jerk, which will cause some shove to fall. The "leasing" of the several hanks being in line and in view a few inches above his hand, he gives that portion of the hank about two turns of twist by a dexterous movement, and removing them from the horn, doubles the length exactly in half and twists the double into a head between his fingers, or in throwing the end twice under his arm. The head thus formed he places evenly and squarely in the press, taking care that, for the first and last row and the outside heads of each row, the leasing is always turned inwards and thus

hidden in the completed bunch. The last row being complete, the bundler secures the caps of the press, screws it up as described, and secures his bands in a similar manner as in the stool bundle. Releasing the press which was held by a ratchet and pawl, he allows the bottom to sink, and opening the caps lifts out the completed bunch. A 50-hank bunch may be made in a similar manner with 16 heads of three hanks each and four half-hank bands, and a 100-hank bunch with 16 heads of six hanks each and four one hank bands. Short-reeled yarn is pressed in a similar manner in a press of proportionate dimensions, which are those of a cotton yarn press. This yarn is usually tied with cord.

In this way a six-bundle bunch may be built of five rows of five heads, each head having eight short hanks, or 200 hanks in all. The following table gives particulars of press bunches built in the ordinary way:—

Leas.	English Bundles.	Belgian Paquets.	French Paquets.	Hanks in Bunch.	Heads in Bunch.	Hanks in Head.	Number of Bands.	Hanks in Bands.
Up to 20's lea, . . .	1 $\frac{1}{3}$	$\frac{1}{2}$	$\frac{1}{4}$	25	16	1 $\frac{1}{2}$	4	$\frac{1}{3}$
20's ,, 30's lea, . . .	3	1	$\frac{1}{3}$	50	16	3 $\frac{1}{2}$	4	$\frac{1}{3}$
35's ,, 45's lea, . . .	6	2	1	100	24	4	4	1
50's ,, 70's lea, . . .	6	2	1	100	16	6	4	1
75's ,, 160's lea, . . .	12	4	2	200	24	8	4	2
100's ,, 140's short reel, .	6	2	1	200	40	5	4	cord
160's upwards short reel, .	6	2	1	200	25	8	4	cord

The building of the bunches of yarn in compact piles in the yarn store requires a little practice. Rectangular piles covering various areas may be arranged with a given number of bunches per layer, so that the number of bunches in a pile is easily reckoned in estimating the number of bunches in a layer and multiplying by the layers in the pile. The number of bunches per layer, if not known, may be found by multiplying the number of times the length of the bunch is contained in one side of the pile by the number of heads or bunch ends which might be contained in the length of an adjacent side. To render the pile solid and firm, the bunches in one layer should cross, as much as possible, those in the layer underneath binding all together.

Weight of Bundles.—The following table gives the commercial weights of the English bundles, Belgian and French paquets in the various leas. It will be seen that the Belgian weights correspond with the English standard, while the French, through local custom, vary slightly in several numbers. Yarn should be put into store a few ounces heavier than its standard weight, lest it should become too light in hot weather. For the same

reason the yarn store should be dry, yet cool, and the sun's rays excluded. Buyers will seldom object to heavy yarns, say under 60's lea, being more than their standard weight, while they do object to the finer yarn, say above 100 leas, being heavier than they should be.

Leas.	English Bundle.		Belgian Paquet.	French Paquet.
	lbs.	ozs.	kilogrammes.	kilogrammes.
6	33	4	45·32	90·0
8	25	0	34·00	68·0
10	20	0	27·20	54·0 or 55·0
12	16	10	22·66	45·0
14	14	4	19·43	40·0 or 38·5
16	12	8	17·00	34·0
18	11	11½	15·11	30·0 or 31·0
20	10	0	13·60	28·0
22	9	1	12·36	25·0
25	8	0	10·88	22·0
28	7	2	9·71	20·0
30	6	10½	9·06	18·0
32	6	4	8·50	17·0
35	5	11¼	7·77	16·0
38	5	4	7·15	15·0
40	5	0	6·80	14·0
42	4	12	6·48	13·0
45	4	7	6·04	12·0
48	4	2½	5·66	11·5
50	4	0	5·44	11·0
52	3	13½	5·23	10·5
55	3	10	4·95	10·0
60	3	5¼	4·53	9·0
65	3	1	4·20	8·5
70	2	13½	3·88	8·0
80	2	8	3·40	7·0
90	2	3½	3·02	6·0
100	2	0	2·72	5·5
110	1	13	2·48	5·0
120	1	10½	2·27	4·5
130	1	8½	2·10	4·25
140	1	6¾	1·94	4·0
150	1	5¼	1·81	3·6
160	1	4	1·70	3·5
180	1	1¾	1·51	3·0
200	1	0	1·36	2·7

Balling.—Dry spun shoe yarns are generally balled from the spinning bobbin upon a hand balling machine such as is shown in fig. 100. Reaper yarns are balled from the automatic bobbin upon a two-spindle automatic machine such as is shown in fig. 79. In this machine each spindle works independently of the other, the formation of the balls being regulated by cams which ensure all balls being alike as to shape, weight and length of material.

Baleing yarn for exportation or transport to a considerable distance is most conveniently accomplished with the aid of a hydraulic press. The

bands of hoop iron with which the bale is to be secured are placed in grooves in the bottom of the press. A piece of hessian or other bagging, a little wider than the bale to be made and in length a little bit longer than the sum of three sides of the same bale, is next laid over the hoop iron band, and upon this the bunches of yarn are built in square layers, one layer binding the other. When the desired quantity of yarn has been built into the press another piece of hessian of similar length to the first is laid over the top layer in the reverse direction, and the hoop iron bands being passed through suitable grooves in the top of the press, the pumps are set going and the platform raised until the desired degree of compression is obtained, when the canvas is sewn strongly together and the bands pulled tight and riveted. When this is done and the water released, a compact and well-secured bale is obtained.

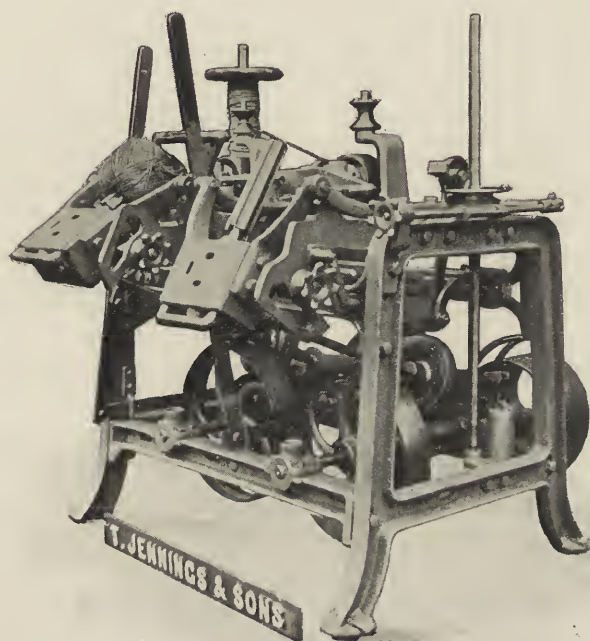

FIG. 79.—Baling machine.

The prices of wet and dry spun flax and hemp yarns and long line and carded jute yarns were at the time of writing—*i.e.* February 1904—as follows:—

Jute Yarns.

Lea.	Weft Carded.		Warp Carded.		Line.	
	Centimes. Kilos.	Pence. Pounds.	Centimes. Kilos.	Pence. Pounds.	Francs. Paquets.	Pence. Pounds.
1	42	1·90
2	43	1·95
3	44	2·00
4	53	2·40	54	2·45
5	54	2·45	55	2·50
6	55	2·50	57	2·60
7	56	2·55
8	59	2·68
10	...	3·33	45	3·73
12	...	3·7	39	3·93
14	37	4·20
16	38	5·00

Hemp Yarns.

Lea.	Line (Wet).		Line (Dry Spun).		Tow (Dry Spun).		Tow (Wet Spun).	
	Francs. Paquets.	Pence. Pound.	Francs. Paquets.	Pence. Pound.	Francs. Paquets.	Pence. Pound.	Francs. Paquets.	Pence. Pound.
5	197	8	161	6·6	172	7·1
6	166	8·5	165	8·3	136	6·8	146	7·3
7	142	8·4	150	8·8	118	6·9	126	7·4
8	127	8·4	134	8·9	106	7	109	7·6
10	106	8·9	108	9	90	7·5	93	7·8
12	95	9·5	95	9·6	82	8·2	81	8·2
14	85	9·6	88	10	77	8·7	77	8·7
16	80	10·6	78	10·4	73	9·7	70	9·3
18	76	11·5	75	11·3	64	9·7
20	70	11·4	62	10

The French paquet is equal to six English bundles or 360,000 yards. Ten centimes are about equal to one penny. One franc equals about 9½d. Irish yarns are subject to a 9 per cent. discount when sold to weavers and to 11 per cent. discount when sold through a commission house. The usual French terms are 6 per cent., 30 days.

YARN REELING, WINDING, DRYING, COOLING, BUNDLING. 225

French Dry Spun Flax Yarns.

Lea.	Tow Warp.		Tow Weft.		Line.	
	Francs. Paquets.	Shillings. Bundles.	Francs. Paquets.	Shillings. Bundles.	Francs. Paquets.	Shillings. Bundles.
6	135	<i>s. d.</i> 18 9	124	<i>s. d.</i> 17 3
8	116	16 0	96	13 1½
10	95	13 1½	78	10 9
12	86	12 0	72	10 0	102	14 1½
14	78	10 9	65	9 0	92	12 9
16	69	9 7½	59	8 1½	86	12 0
18	58	8 0	75	10 4½
20	57	7 10½	72	10 0
22	69	9 7½
25	68	9 6

Lea.	Wet Spun Flax Lines.						Wet Spun Flax Tows.			
	Weft.		Warp. Superior and Medium.		Light Warp.		Warp.		Weft.	
	Francs. Paquets.	Shillings. Bundle.	Francs. Paquets.	Shillings. Bundle.	Francs. Paquets.	Shillings. Bundle.	Francs. Paquets.	Shillings. Bundle.	Francs. Paquets.	Shillings. Bundle.
6	...	<i>s. d.</i>	...	<i>s. d.</i>	...	<i>s. d.</i>	150	<i>s. d.</i>	134	<i>s. d.</i>
8	125	...	104	...
10	109	...	87	...
12	142	99	...	76	...
14	90	...	128	...	98	...	86	8 7½	69	8 4½
16	79	...	110	...	87	...	77	8 0	61	7 9
18	72	...	98	...	79	...	70	7 7½	56	7 1½
20	67	8 3	90	...	72	...	66	7 4½	53	6 7½
22	61	7 6	82	...	65	...	61	6 10½	49	6 4½
25	54	7 0	78	...	59	...	57	6 7½	47	6 1½
28	51	6 6	74	...	55	...	54	6 4½	46	5 10½
30	49	6 3	70	...	51	...	49	6 1½	44	5 6
35	45	5 9	68	...	48	...	47	5 9	43	5 1½
40	43	5 4½	68	...	46	...	47	5 4½	42	4 10½
45	40	5 1½	68	...	45	5 1½	...	4 7½
50	39	4 10½	67	5 6	44	4 10½	...	4 6
55	38	4 9	67	5 3	42	4 4½
60	36	4 7½	67	5 1½	42
65	35	4 4½	67	5 0	41
70	34	4 3	67	5 0	41
75	33	4 1½	67	5 0	...	4 6
80	33	3 10½	69	5 0	...	4 6
85	33	3 9	70	5 1½	...	4 6
90	33	3 9	...	5 3	...	4 7½
100	33½	3 9	...	5 6	...	4 10½
110	34	3 9	5 0
120	...	3 9	5 1½

CHAPTER XVI.

THE MANUFACTURE OF THREADS, TWINES AND CORDS FROM FLAX, HEMP, JUTE, AND RAMIE YARNS.

Twisting and Cabling.—Threads, twines, cords, and ropes in the true sense of the term are composed of two or more single yarns twisted together.

If threads, twines, cords and strands thus formed are again twisted together, they are said to be "cabled." The operation of cabling is resorted to when a specially hard-surfaced thread, cord, or rope is required, as, for instance, some sorts of sewing thread, whipcord or driving ropes.

The first process consists in putting the yarn into a suitable form to commence the twisting operation.

If it be dry spun yarn, it may for cheapness sake be twisted from the spinning bobbin, although that way is not to be recommended for first-class work. If excellence is aimed at, the yarn should be re-wound on to larger bobbins or spools, or upon a winding frame of the sort shown in fig. 80, which is even more used for cotton.

In this machine the top spindles are fixed in a double row with brass bolsters and footsteps, the back row has larger wharves than the front row, and the bobbins should be changed from front to back when half filled. This equalises the speed of the yarn and renders a higher average speed of winding possible. In the illustration a creeper motion is shown in the centre of the frame. Its object is to automatically carry away the empty bobbins and deposit them in a basket at the end of the frame. If the yarn has been spun wet or demi-sec, or if it has been bleached or dyed, it must be wound from the hank upon spools before it can be twisted. Fig. 81 shows a single drum winding frame upon which fine yarns may be wound from 54-inch hanks, and figs. 82 and 83 winding frames which are suitable for the coarsest yarns. In this class of machine the flanged wooden spools upon which the yarn is to be wound rest upon the winding drums, so that the speed of winding is constant, no matter what may be the diameter of the spool of yarn. The thread guides are traversed by a cam or eccentric. A very similar machine is the split drum winding frame, in which machine

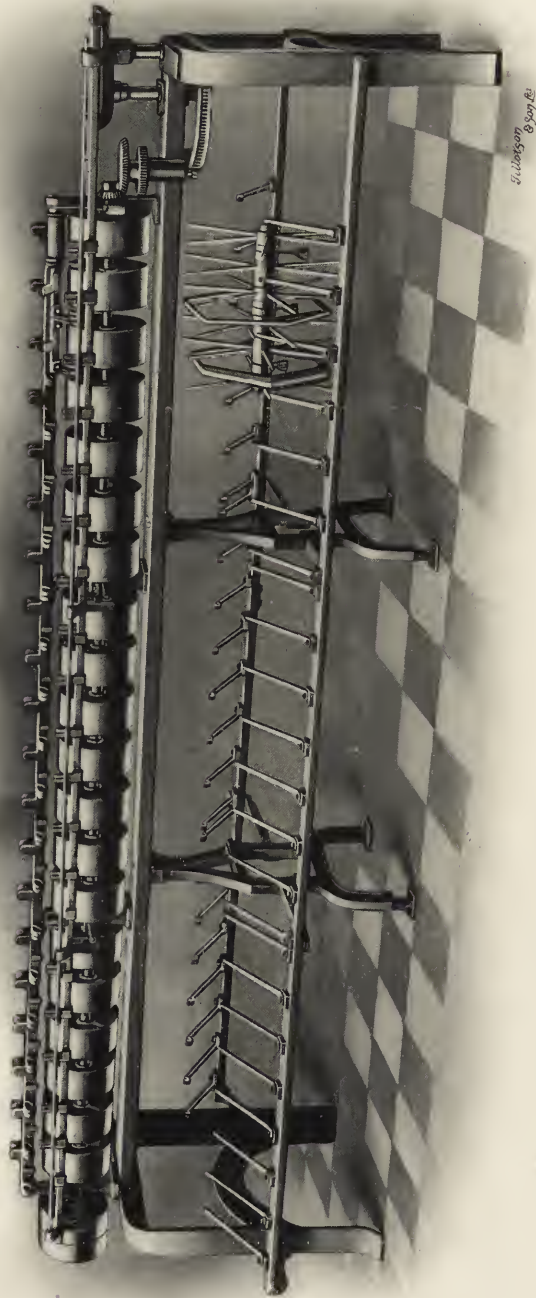
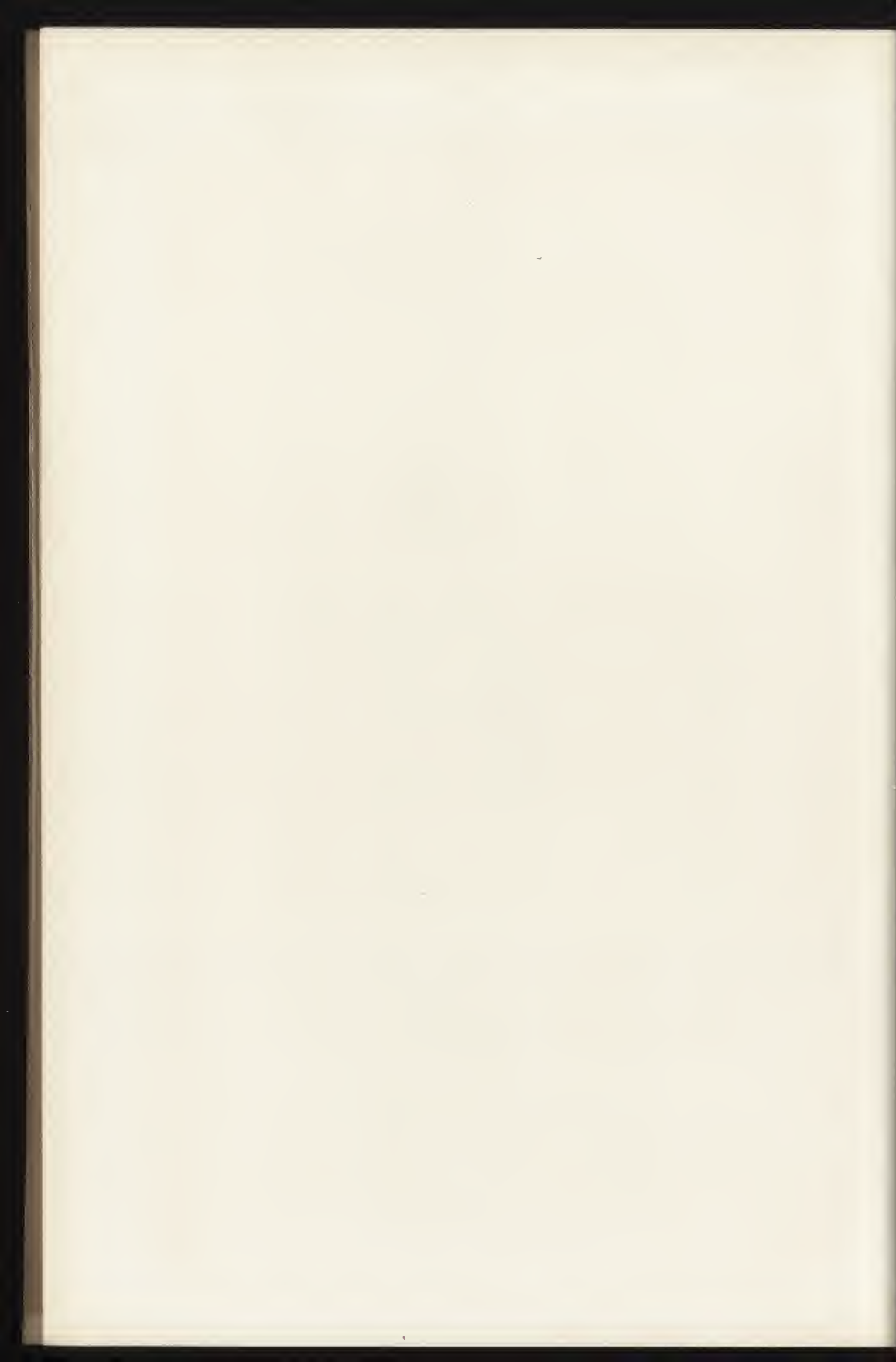

FIG. 81.—Improved single drum winding frame (latch and catch). (Made by Messrs Arundel & Co., Stockport, England.)



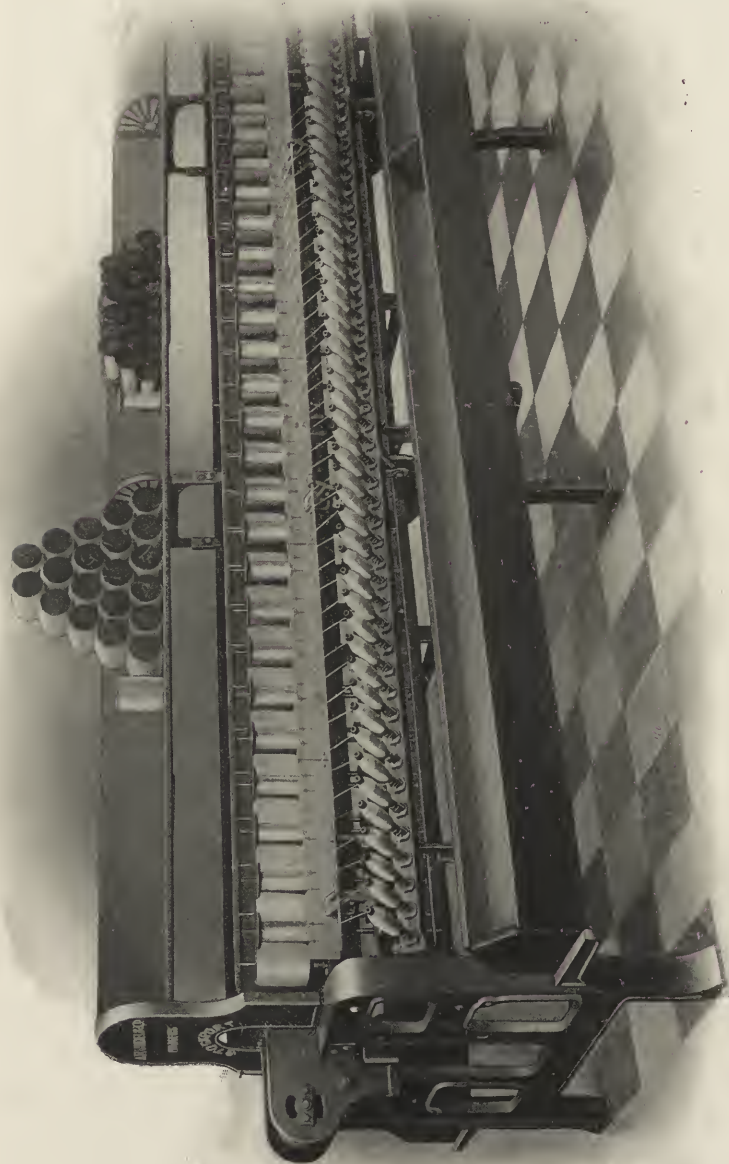

FIG. 80.—Upright spindle winding frame, with creeper motion for taking away empty bobbins.
(Made by Messrs Arundel & Co., Stockport, England.)

a split extending across from one side of the face of the revolving drum to the other, acts as a thread guide.

During this re-winding process the yarn may be passed through a narrow slit called a clearer or slubber, and freed from all lumps, slubs, bad piecings, etc., which are cut out, and the ends united by a weaver's or other small knot. A convenient adjustable slubber is that patented and made by Messrs J. & T. Boyd, Ltd., Glasgow. When a number of yarns are to be twisted together some people prefer to first *double* them together upon

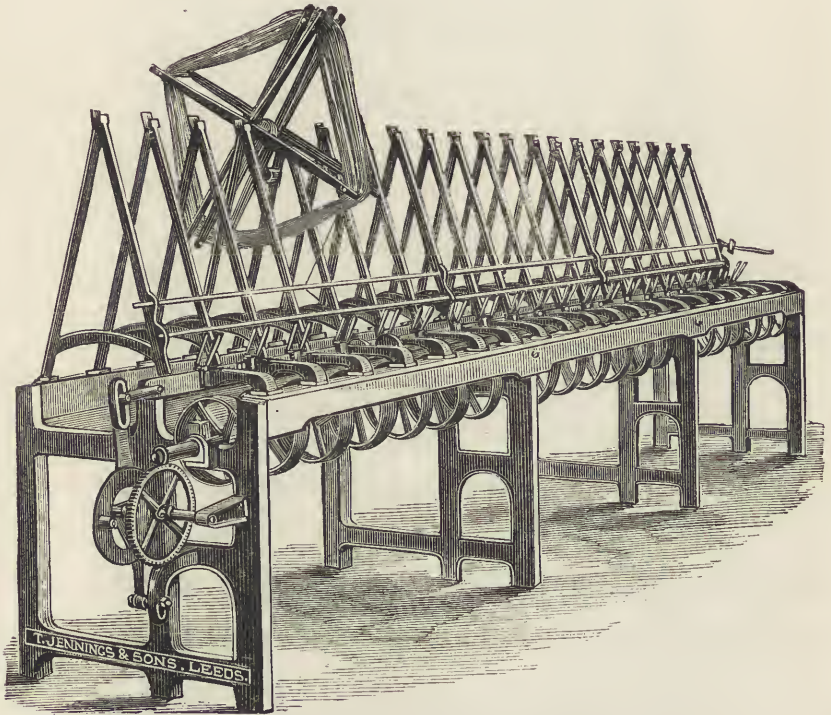

FIG. 82.—Winding or swifiting frame.
(Made by Thomas Jennings & Sons, Leeds, England.)

a doubling winding frame provided with detector stop motions for each end, destined to prevent winding taking place on any individual bobbin after one of the yarns has run out or broken. These bobbins of doubled yarns, or the required number of bobbins of single yarn, are then put up in the creel of the twisting frame, brought round and through the delivery rollers, and twisted by the flyer or traveller.

Figs. 84, 85, and 86 show different forms of twisting frames for making threads and cords from single yarns.

The first shows most clearly the way in which, for wet twisting, the yarn is first guided into a trough of water, then under and round the

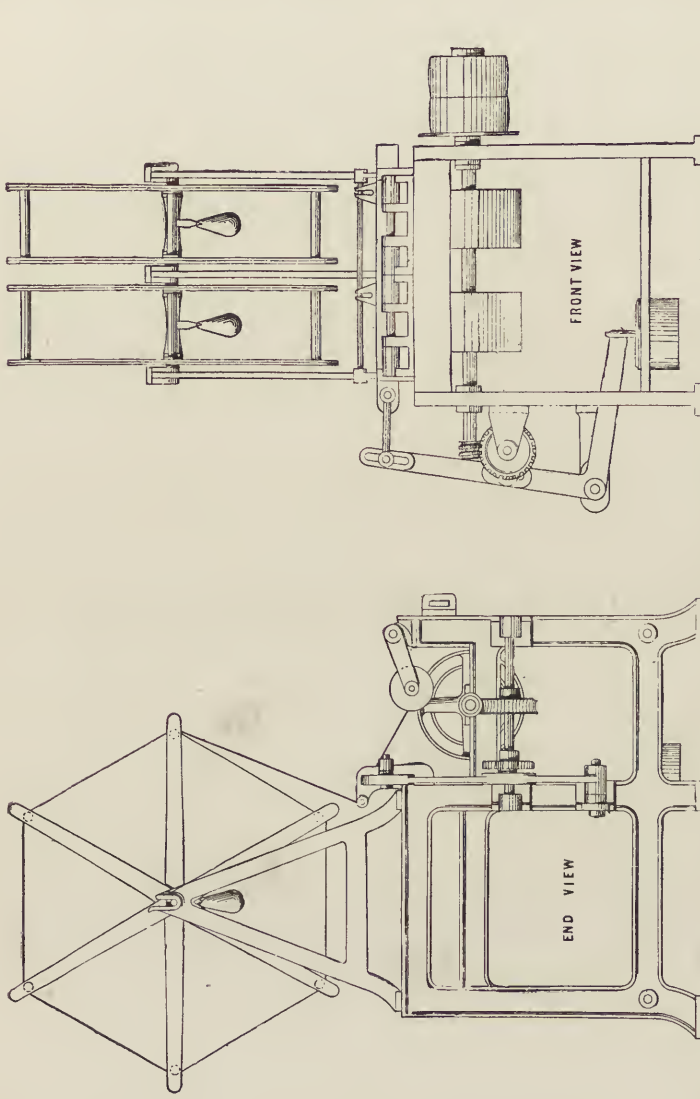

FIG. 83.—Winding or swifting frame. (Made by Mr. William Bywater, Leeds, England.)

bottom delivery roller and through the nip of the top pressing roller, then back round a guide and over the top of the upper delivery roller (on which it lies in a groove), through the thread plate eye to the twisting action of the flyer and spindle. In the frame shown in fig. 86 each spindle is provided

with a stop motion which, when one end of a set of threads being twisted together fails or breaks, instantly stops the individual spindle and roller, so that it is impossible for either to move further (leaving a perfectly twisted

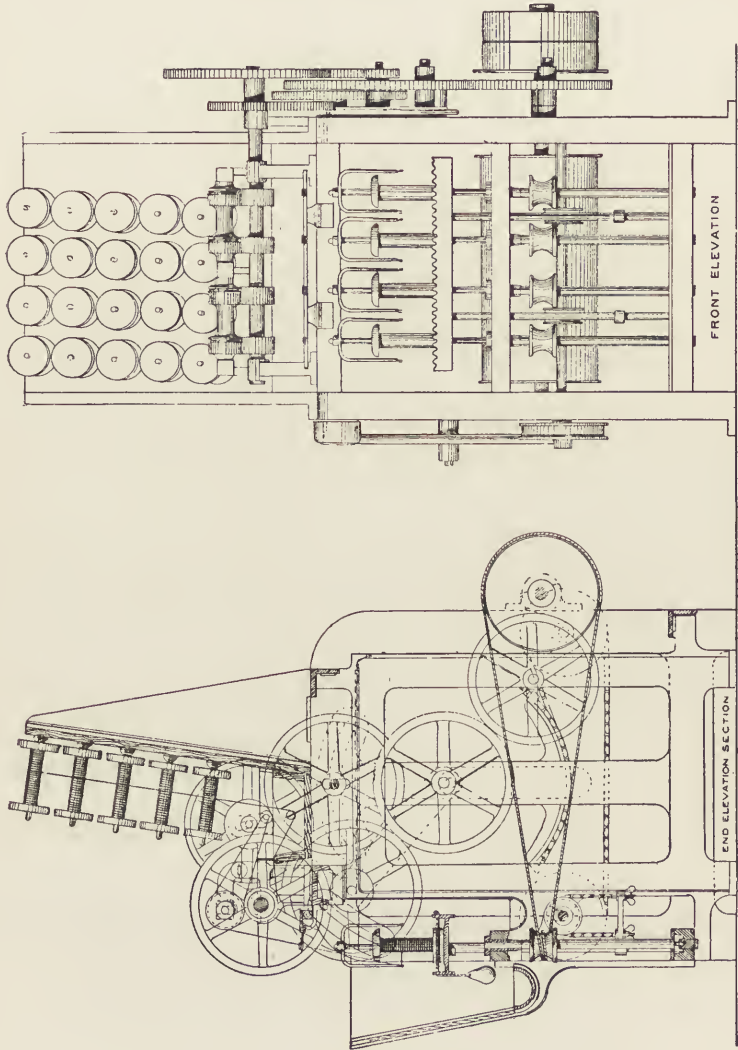

Fig. 84.—Twisting frame. (Made by Mr William Bywater, Leeds.)

thread between the feed roller and spindle and the broken end ready to be pieced in the single behind the delivery roller). A neat piecing in the single strand, and the proper amount of twist, where a piecing is made, are ensured, whilst bunch knots, singles, doubles and waste are avoided. No time is lost stooping down, stopping spindles, seeking the end

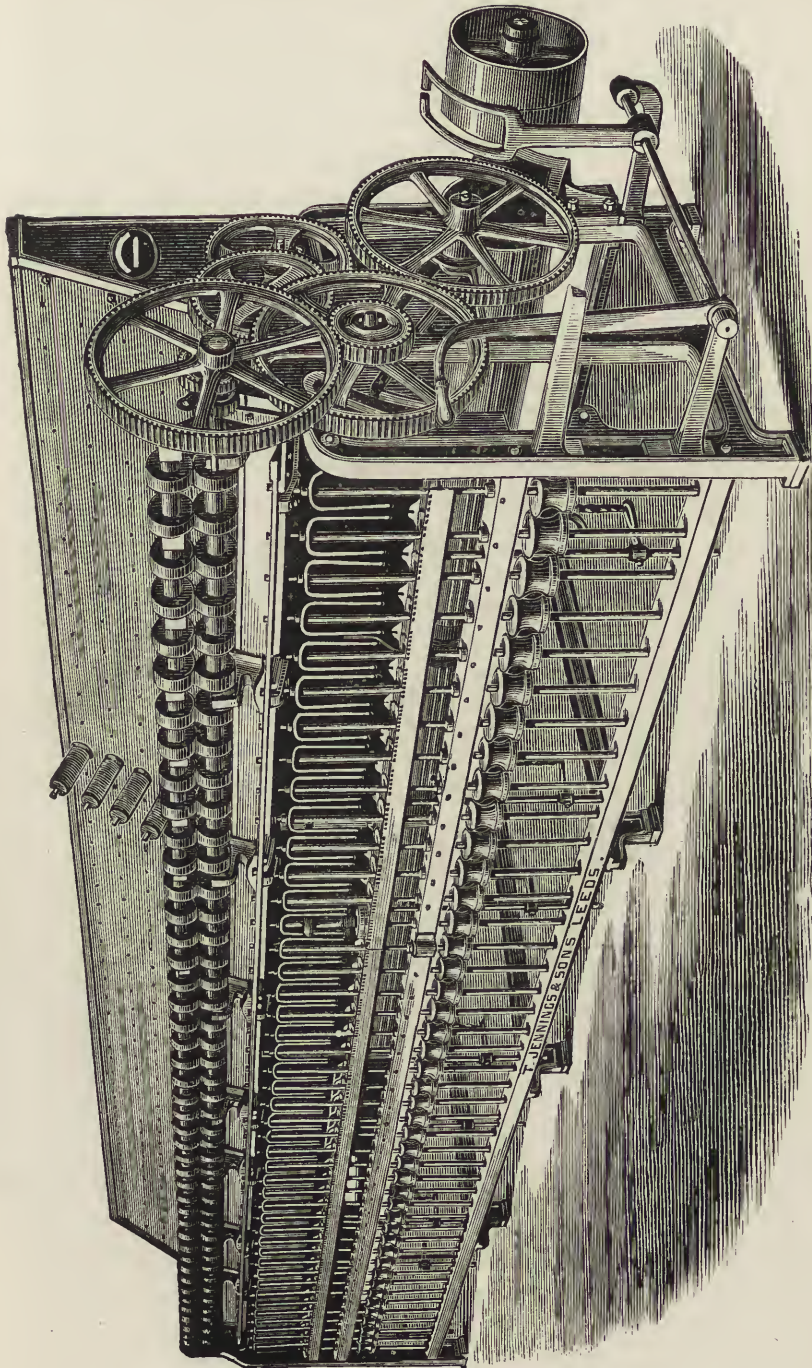

FIG. 85.—Twine twisting frame. (Made by Thomas Jennings & Sons, Leeds.)

upon the bobbin, and bringing it through the delivery rollers. Each bobbin may be doffed when filled, thereby saving the necessity of stopping the frame for doffing. Frames of the same make, but of a lighter class, fitted with high-speed flyer and ring spindles, are used for twisting sewing threads.

Flax for Threads.—Flax for thread must be very strong, and is generally chosen in the Irish, Flemish, Courtrai and Friesland markets. The coarser threads or yarns, such as shoe threads, which require great strength, are usually spun on the dry, demi-sec, or gill spinning principle, as already described. Fine yarns, for ordinary sewing threads, must be wet spun in the ordinary way. An ordinary fine roving frame may be converted into a gill spinning frame, capable of spinning up to 16's lea, by arranging the gearing for a long draft and high twist, and in order to obtain a decent turn off, by increasing the speed of the spindles, steadying them, if necessary, by cap plates. The finer qualities of Italian hemp may be, and are, frequently spun into yarns used by shoemakers and saddlers to make up into "waxed ends" for strong stitching. The strides made within recent years in shoe machinery, chiefly of American manufacture, and the consequent increase in the number of boot factories, has led thread makers to double and twist the old-fashioned single yarn or thread into a continuous "end" which is waxed, if required, either while being twisted or afterwards in the sewing machine. Such threads are known as "Blake," "McKay," or "Goodyear" threads, according to the make of sewing machine for which they are intended, and are composed of from 4 to 12 fold, 17's to 27's lea, twisted together by a number of turns equivalent, approximately, to the product of two and a half to three and the square root of the finished weight of the thread. Thus, a thread suitable for the Goodyear lock-stitch sole-sewing machine may have from four to ten yarns of 17½'s lea grey, or 20's lea bleached yarn, four to seven turns per inch twist, and capable of sustaining a weight of 26 to 60 lbs. A similar, but finer and harder, twisted thread is composed of from 4 to 10 fold 23 lea grey, or 27's lea bleached yarn, five to eight turns per inch twist, and capable of sustaining a weight of from 19 to 41 lbs. The construction of the sewing machine in which such threads are used, necessitates a very level and smooth thread. To obtain such, the individual yarns composing the thread must be held at a regular tension while being twisted together in the reverse direction to that in which they are spun. The finish and smoothness of the thread is further increased by passing it through a die or hole of the exact diameter of the thread, while being twisted and before winding on the bobbin. Such threads may be produced upon the ordinary twisting frames, such as are shown in figs. 84, 85 and 86, provided with creels to take in the required number of spools. The levelness of the thread is increased by adding to the frame the die plate referred to above, a register plate, a reed to spread the

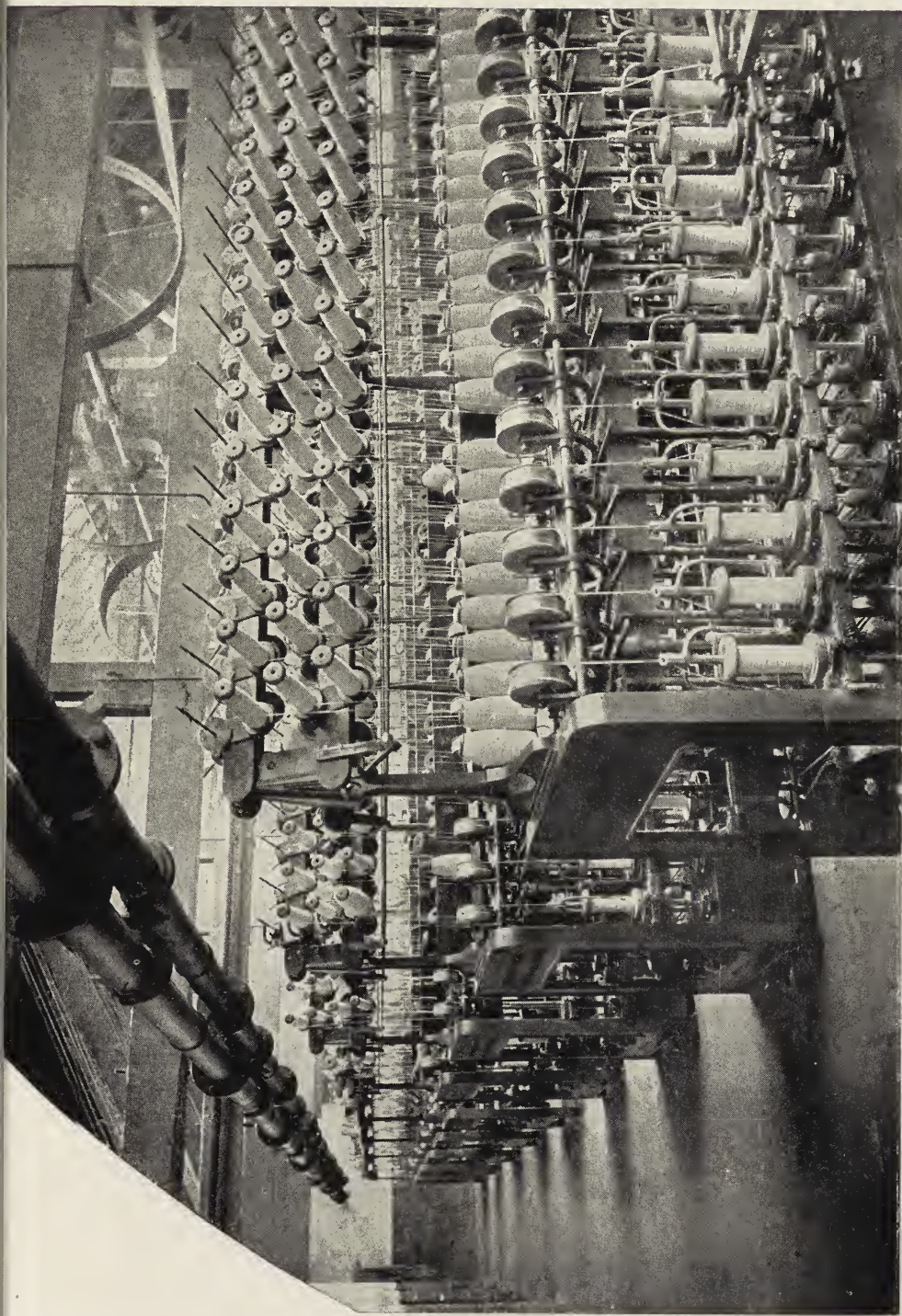
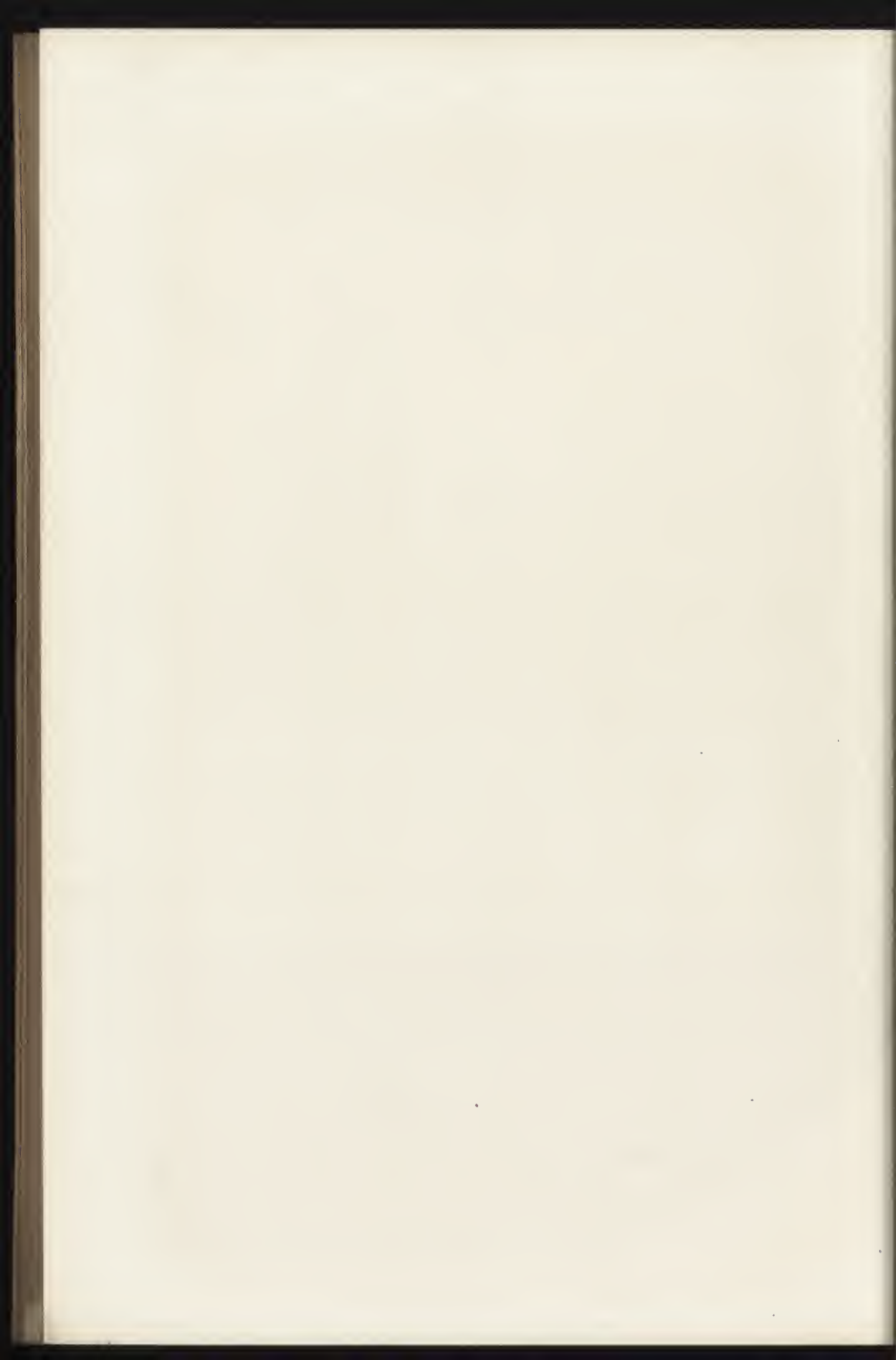

FIG. 86.—Boyd's patent stop-motion flyer twisters. (Made by Messrs J. & T. Boyd, Ltd., Glasgow.)



yarn, and lease rods to maintain an even tension and to enable a broken end to be replaced in its correct position. The bobbins may be dragged by metal drags, as shown in fig. 86, or controlled by differential gear, but the spindles should be positively driven by gearing in any case, in order that the correct twist may be maintained, notwithstanding the heavy drag required to draw the end through the die blocks. We believe that this class of thread is still further improved by being "cabled," or made on a machine constructed upon the Brownell principle, like those shown in figs. 87 and 88, but of lighter construction. The object is that a loose end may not untwist itself, which object is attained by giving each of the yarns composing the thread a "back-turn" or "forehard" while they are being twisted together—that is to say, giving the yarns an increased twist or merely maintaining their original twist, while the thread is being twisted in the opposite direction. The chief features of the Brownell machine are—a central spindle and bobbin for winding on and twisting the thread, around which are ranged the secondary spindles carrying the bobbins of single yarn. The latter are driven by belt or gearing, putting the desired amount of extra twist into the component yarns, which are drawn off their bobbins, through a forming block and compressor, twisted together in the reverse direction by the main flyer and wound upon the thread bobbin. It is advisable to have all the flyers positively driven by gearing, in order to avoid irregularities caused by slipping bands. For the same reason, the yarns must be drawn off their bobbins, and the thread twisted and wound at a constant speed, necessitating the use of haul pulleys which, with the gearing, form another example of epicyclic gear. The pair of haul pulleys have several grooves and work upon studs fixed in the face of the flyer frame or inside the head of the flyer, and are driven by a spur pinion on the end of the twist tube which passes through the turning centre of the flyer. This twist tube, through which the thread passes, is also given a positive motion, by means of gearing, in the same direction as that in which the flyer turns, hence the grooved haul pulleys are turned in one direction by their spur gearing engagement with the twist tube, while they are carried round the latter by their position on the head of the revolving flyer, which gives them a superior motion in the opposite direction. Their effective speed is, then, that due to the difference in driving power of the two motions, which difference, and consequently the turns per inch twist, may be changed by altering the speed of the twist tube. The thread from the compressor passes through the twist tube, round a small guide pulley, several times round the grooved haul pulleys, whence it passes to more small guide pulleys on the leg of the flyer, and thence to the bobbin, upon which it is wound in the ordinary way. To obtain a smooth and round thread, the tension of the component yarns must be as uniform as possible, and as it is prone to vary with the changing diameter of the bobbin from which it is being drawn,

the bobbin should be lightly dragged in a manner in which the intensity may be diminished as the bobbin empties.

The yarns, if desired, may be passed through water or melted wax when on their passage to the laying block. Wet twisting enables one to avoid snarled thread, while hardening the twist considerably. Thread which has been twisted very hard while dry, and is consequently inclined to snarl, remains quite straight if damped in the hank and dried under tension.

Cable Thread.—Ordinary flax and hemp sewing threads may be divided into two classes. The one known as cabled thread is usually stronger and with a harder surface, which withstands friction better than the other, which consists of several yarns twisted together into a strand in the ordinary way. Cabled thread has the same construction as a well-made rope—that is to say, a number of yarns are twisted into strands, and several strands—usually three—again twisted together into the finished thread. The principle of construction, and one which gives a thread which will retain its twist, is that the strands are formed by twisting in the opposite direction to that in which the yarns were spun, the direction being again reversed when the strands come to be combined together, a “back-turn” or “forehard” being usually provided to keep the twist imparted in one operation from being partially lost in the succeeding. Ingenious machines have been invented to complete the stranding and cabling operations in the same machine at one and the same time. Such machines have, around a central spindle, a number of groups of secondary spindles corresponding with the number of strands in the thread. Each secondary group contains as many spindles as there are yarns in the strand, and each spindle revolving on its axis and in groups of two or more around another, form a combination which may be compared to a solar system with a sun and groups of satellites, which, while themselves turning round, are again revolving round a sun of their own.

A 6-cord cable-laid flax thread, much used, in canary colour, for sewing boot and shoe uppers, may be formed in this way by taking, say, a good 50's Courtrai warp yarn, twisted to the left at the rate of seventeen to twenty turns per inch, and twisting two threads together to the right in a strand having twelve to fifteen turns per inch twist. Three of these strands are then twisted together to the left, forming a thread equal in weight to 8½'s lea, which may be twisted as highly as twelve turns per inch.

Ordinary linen threads for machine sewing are twisted upon a wet twisting frame, the yarns being preferably first doubled together and wound upon the same bobbin upon a good stop motion doubling winding frame.

The danger of “single” is thus obviated, as a good stop motion will stop the winding on of the yarn before a broken end has disappeared upon the bobbin. For instance, a good 60's 3-cord flax thread may be composed

of three yarns of No. 60's full warp twist, spun to the right and then twisted together to the left, forming a thread about equal in weight to 20 leas per lb. As a general rule threads are finished with the spindles running in a clockwise direction, looking at them from above. For this reason, if, as in the ordinary thread, there are two twisting operations, the yarn should be spun to the right, contra-clockwise or reverse twist. If there be three operations, as for cabled thread, spin to the left in the ordinary way.

Theory of Yarn and Thread Construction.—A single yarn is a narrow ribbon, of parallel fibres, which has been twisted to the right or left, forming a spiral which is more or less cylindrical in proportion to the number of turns of twist in a given length. If the theory of this operation be studied, and if a piece of yarn be carefully examined under the microscope, it will be seen that it is the outside edges of the ribbon which have been turned around a central or neutral axis, and that the fibres which compose the thread are straighter in the ratio of their distance from the outside. For this reason, with the same material, the greater the diameter of the yarn the weaker it is in proportion; and *vice versâ*, the finer the yarn is, the material being the same, the harder and proportionately stronger it is. It is the fibres on the outside of the yarn which bear the strain, because they are stretched in being twisted around the fibres which form the interior of the yarn, these latter being perhaps slightly compressed by the contraction in length of the yarn as it is being twisted. These facts may be taken advantage of when we wish to produce a thread as durable and strong as possible—sewing thread, for instance—because the thread will be stronger and more regular and durable, in proportion to the number of fine single yarns which are employed and twisted together.

Fancy Yarns.—In twisting yarns together for ordinary threads, twines, cords, and ropes, those yarns should be as level and regular as possible and all of the same grist or thickness, as if a coarse and a fine thread be twisted together the product will always have a wavy appearance, because the fine end will twist spirally round the coarser.

This fact is taken advantage of in producing the fancy yarn known as *fil ondulé*. Other fancy yarns are produced by doubling two or more threads together in special ways. For instance, what is known as "looped yarn" may be formed by delivering one of the ends more quickly than the rest, the excess length forming loops upon the main thread.

"Bead yarn" is produced by twisting together a right and left-handed twist yarn. The twist is taken out of the one, while it is increased in the other, the length of the former being increased while the latter is contracted in length, giving the product a wavy appearance.

"Nopped yarn" is produced in a somewhat similar manner to that in which "looped yarn" is produced. The excess length of the nopping thread is, however, let away more suddenly and quickly at regular intervals

by means of an arrangement of levers and swinging guides actuated by a cam causing the formation of hard, round nops or beads.

A great variety of effects may be obtained by employing yarns of various colours and combining them in different ways. Slubbed yarn is produced by delivering at regular intervals into yarns while twisting, short lengths of cotton slubbing, which is dyed the desired colour. Slubs may also be obtained of yarn only by stopping delivery of the main or ground thread at regular intervals and lapping around it, with a quick traverse motion of the required length, the slubbing thread which is constantly being delivered at a higher speed.

Range of Twines.—The usual range of twines which may be twisted upon the frames shown in figs. 84, 85, and 86, are, commencing with the finest, 2-fold 16-lea, 2-fold 12-lea, 3-fold 12-lea, 2-fold 8-lea, 3-fold 10-lea, 2-fold 6-lea, 3-fold 8-lea, 2-fold 5-lea, 2-fold 4-lea, 3-fold 6-lea, 3-fold 5-lea, 2-fold 3½-lea, 3-fold 4-lea, 3-fold 3-lea, 2-fold 2-lea, 3-fold 2-lea, 3-fold 1½-lea, 3-fold 1-lea, up to 6-fold 1-lea.

Suitable twists will be for—

2-fold 16 -lea,	440 turns per foot.
2-fold 12 -lea,	382 " "
3-fold 12 -lea, and 2-fold 8-lea,	312 " "
3-fold 10 -lea,	283 " "
2-fold 6 -lea,	270 " "
3-fold 8 -lea,	254 " "
2-fold 5 -lea,	246 " "
2-fold 4 -lea, 3-fold 6-lea,	220 " "
2-fold 3½-lea,	206 " "
3-fold 5 -lea,	201 " "
3-fold 4 -lea,	180 " "
3-fold 3 -lea, 2-fold 2-lea,	156 " "
3-fold 2 -lea,	127 " "
3-fold 1½-lea,	110 " "
3-fold 1 -lea,	90 " "
6-fold 1 -lea,	64 " "

Twine Laying or Cabling.—Fig. 87 shows a twine laying or cabling machine suitable for cords up to $\frac{1}{4}$ inch diameter. Either two or three stranded cords may be made. It is used for making fishing twines and whipcords. The yarns are given "forehard" by the spindles seen at the top of the frame, and then the ends passing downwards, pass through the forming top and are twisted together by the main spindle and flyer. Three ordinary makes of whipcords are 6-fold 10-lea, 6-fold 8-lea, and 6-fold 6-lea, which are composed of three strands of 2-fold yarn forehardened and twisted together in the opposite direction with 277 turns per foot twist for the 6-fold 10-lea, 248 turns per foot twist for the 6-fold 8-lea, and 215 turns per foot twist for the 6-fold 6-lea.

Figs. 88 and 89 show other forms of cabling machines. The latter is a form which is often used for twisting trawl twine, which is made from three threads of white Manila spun on the machine shown in fig. 49,

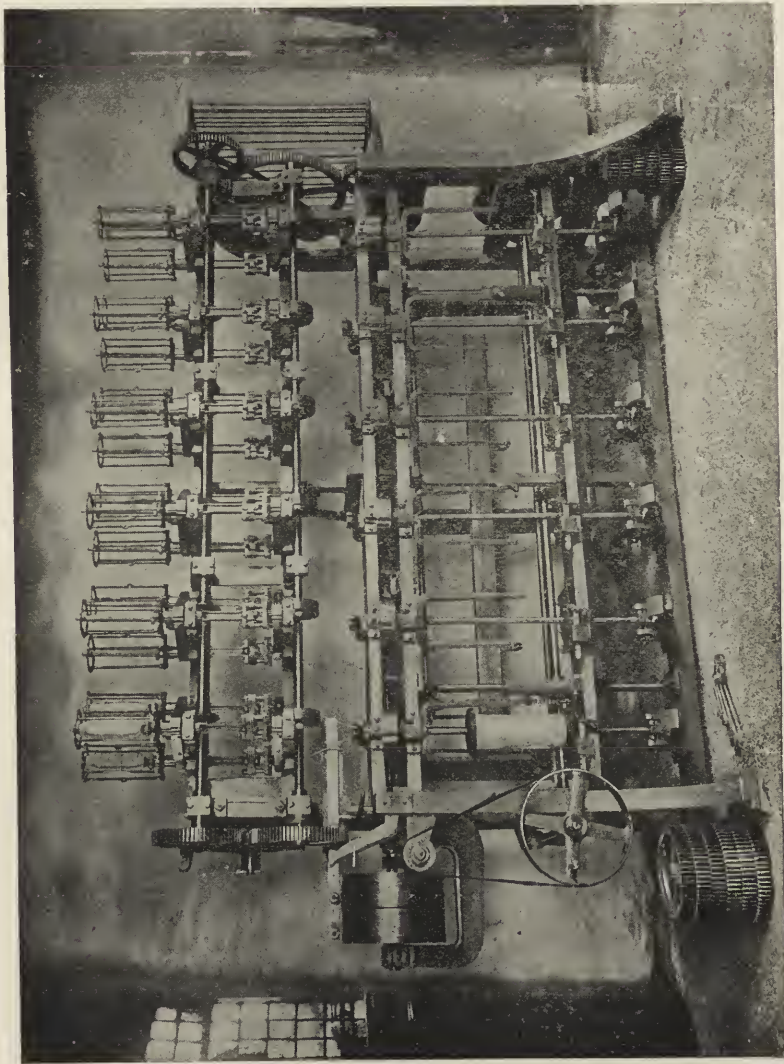

FIG. 87.—Cabling machine for cards. (Made by Mr William Bywater, Leeds.)

and each weighing 320 yards per lb. These when twisted together form a common make of trawl twine weighing 100 yards per lb., and which may be twisted with about 125 turns per foot.

A very good form of trawl twine laying machine is that made by Messrs

Samuel Lawson & Sons, Leeds. It is of very similar construction to that shown in fig. 89. In Lawson's machine, as in the American machine shown, motion is given from the line shaft to a horizontal parallel with it,

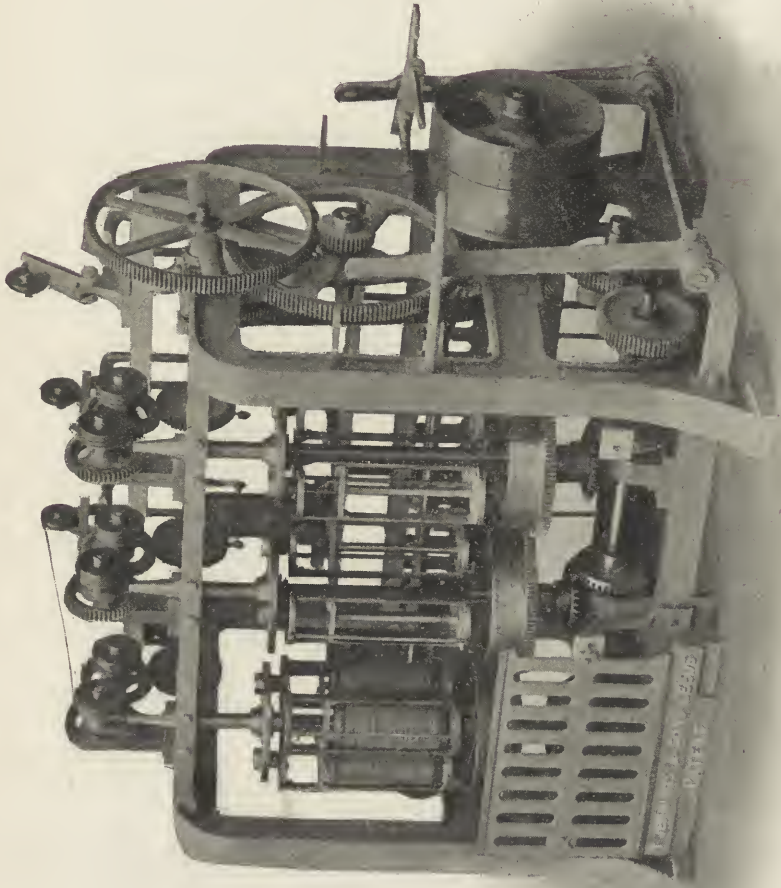

FIG. 88.—Cabling or laying machine. (Made by T. Jennings & Sons, Leeds.)

which is shown to the extreme right in fig. 89. Upon this latter shaft large bevel wheels gear with bevel pinions upon the extremities of the lower shafts. Upon these shafts are a series of pulleys. The first to the right is a drag pulley driving the sleeve of the bobbin carrier. Next comes the flyer pulley driving the flyer at a constant speed, and then an expansive

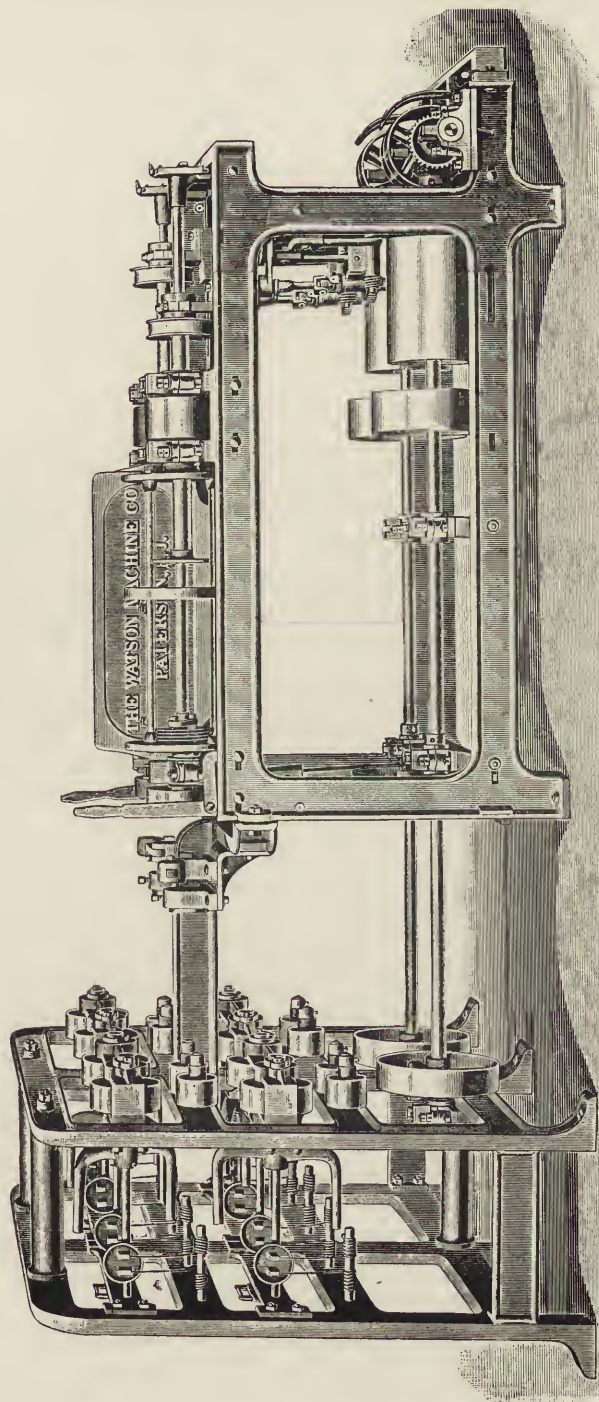

FIG. 89.—A 2-spindle machine to lay 2-, 3- or 4-ply cord. (Made by the Watson Machine Co., Paterson, New Jersey.)

twist pulley for a flat belt which drives the twist tube pulley at the requisite speed to put in the twist required. The last pulley to the left drives the "back twist" or forehardening flyers, of which there are three or four per main spindle.

In Lawson's machine the bobbins of yarn are connected with carriers through which tension is applied by means of friction drags. In the American machine, fig. 89, it will be seen that tension is obtained by means of spring pressers which bear against the surface of the yarn upon the bobbin.

In the former machine a stop motion is provided for each of the ends passing through the forming top. It consists of a wire with a heavy tail-piece for each end. The three or four wires are centred upon a stud, and

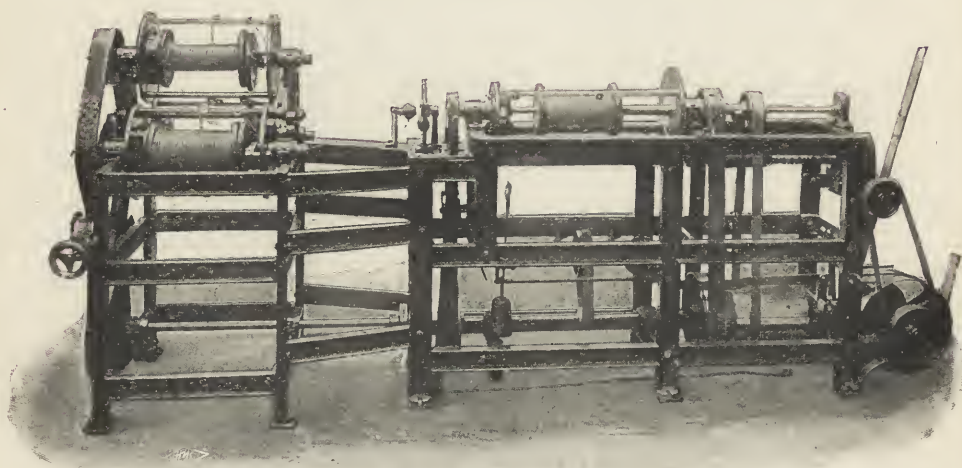

FIG. 90.—Horizontal laying machine for box and sash cords, clothes lines, etc. (2 to 4 fold).
(Made by Messrs James Reynolds & Co., Belfast.)

the heavy tailpieces are kept supported by the pressure of the end upon the wire arm of the lever. When an end breaks, the tailpiece falls upon the long arm of a lever, the short arm of which is connected with a catch which is pressed home by the pull of a spring upon an arm keyed to the starting side shaft. The catch is thus raised and the spring puts the belt on to the slack pulley. The main bobbin traverse, as in the automatic spinner, figs. 47 and 48, is driven by a worm upon the bottom shaft, driving into a worm wheel upon the bottom of an inclined shaft, upon the upper end of which is a bevel pinion which drives into a bevel wheel upon a right and left-hand screw which works the traversing block.

Figs. 90 and 91 show horizontal machines for laying or cabling 2-, 3-, 4-, 5-, 6-, 7-, or 8-fold box and sash cord, clothes lines, etc.

In twisting frames in which a delivery roller is used, the twist is

changed by increasing or diminishing the speed of that roller, and consequently augmenting or reducing the delivery. The speed of the spindles remaining constant, the degree of twist is inversely proportionate to the rate of delivery. The principle is exactly the same as in the wet and dry spinning frame described and explained in Chapters XII. and XIII. In machines which have no delivery rollers, such as figs. 89, 90, and 91, and in which the yarn is drawn through by haul pulleys as in the automatic spinner (p. 126), the twist is changed by means of the twist pulley, which drives the twist tube and through it affects the speed of the haul pulleys.

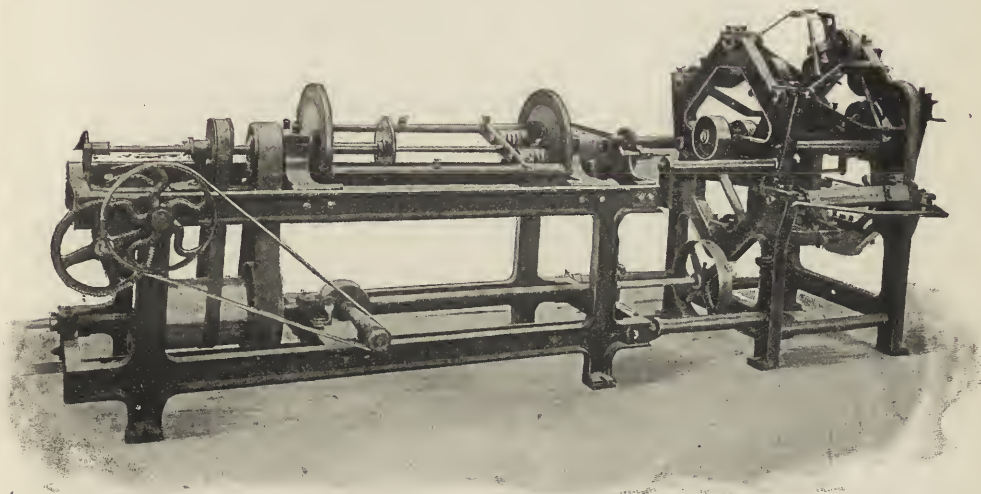

FIG. 91.—Horizontal laying machine for cords, etc. (5 to 8-fold).

The calculation for the twist may be made in exactly the same way as shown on page 127.

Sizing and Polishing Threads and Twine.—After threads and twines from soft fibre have been twisted, they are generally sized and polished. This is done by winding them from bobbin to bobbin through a special machine in which the thread or twine passes through troughs of starch and then between squeezing rollers, over circular brushes and heated cylinders, and into contact with rapidly revolving polishing rollers. Figs. 92, 93, and 94 give a good idea of what these machines are. The first is a twine washing and carding machine with two washing troughs and six carding rollers. The second is a twine polishing machine for fine twines up to 4-fold 8-lea, and the third a large polishing machine for coarser twines with one washing and three size troughs, three carding, five rubbing and four polishing rollers, and lastly, two drying cylinders. In fig. 92 it will be seen that the twine is first drawn from the twisting frame

bobbins through a water trough and then over three carding rollers covered with strong wire cards. These carding rollers remove much shive and inequalities from rough twines, and at the same time improve its

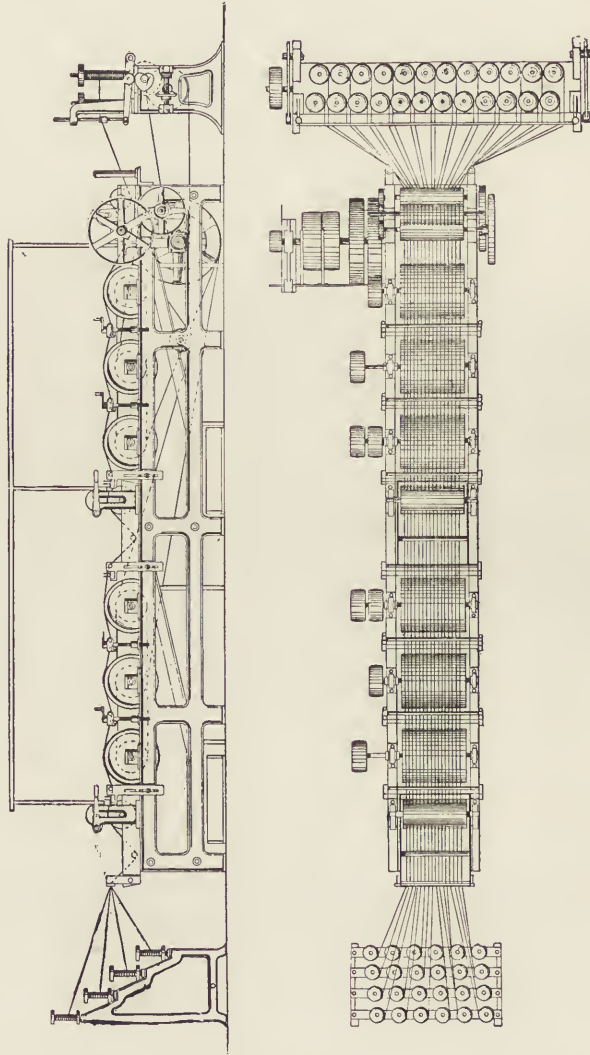

FIG. 92.—Twine twisting and carding machine. (Made by Mr Wm. Bywater, Leeds.)

colour. It will be seen that the twine then passes through a second water trough, and is still further cleaned by a second series of three carding rollers before being again wound upon bobbins in the winding-up frame. In the polishing machine, fig. 93, the twine first passes through a washing

trough and pair of squeezing rollers, then over a rubbing roller and into a size trough, then through squeezing rollers to the tin drying cylinder, around which it passes before coming in contact with the three polishing

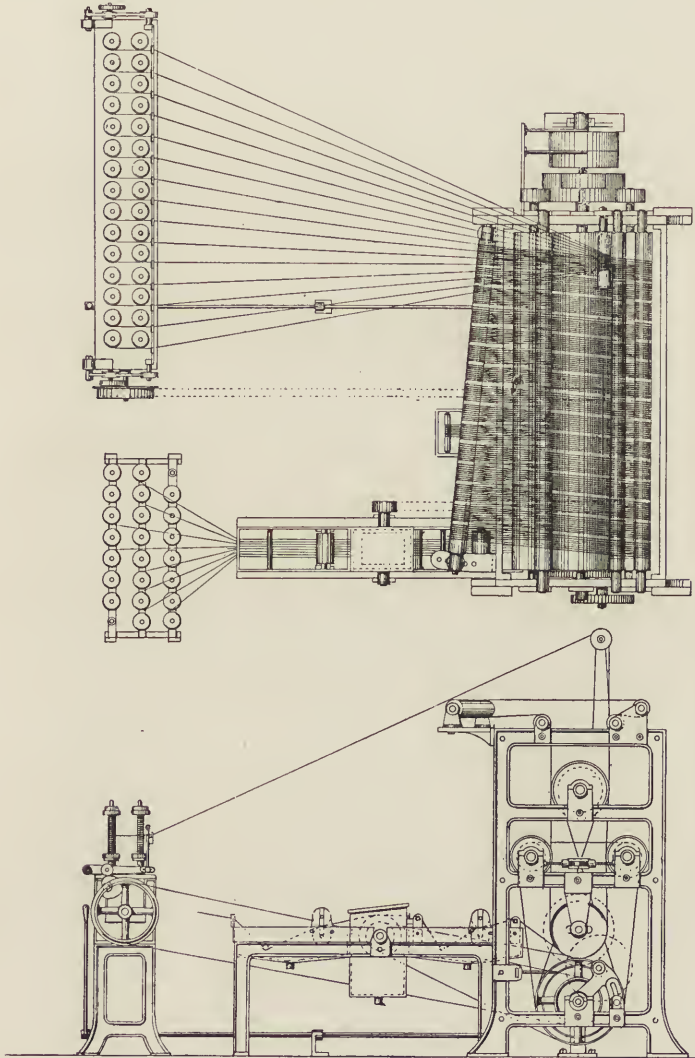

FIG. 93.—Twine polishing machine. (Made by Mr Wm. Bywater, L^o eds.)

rollers, whence it is guided to the winding-up spools. In the larger machine, fig. 96, the twines first pass through the washing trough and squeezing rollers and over three carding rollers, to the size trough and size squeezing rollers, and over one pair of rubbing rollers. Thence they pass through the second size trough and squeezing rollers to three more rubbing rollers,

after which the twines pass repeatedly around the two drying cylinders, between which they are brought in contact with the four rapidly revolving polishing rollers.

Fig. 95 gives a general view of a large twine polishing machine of

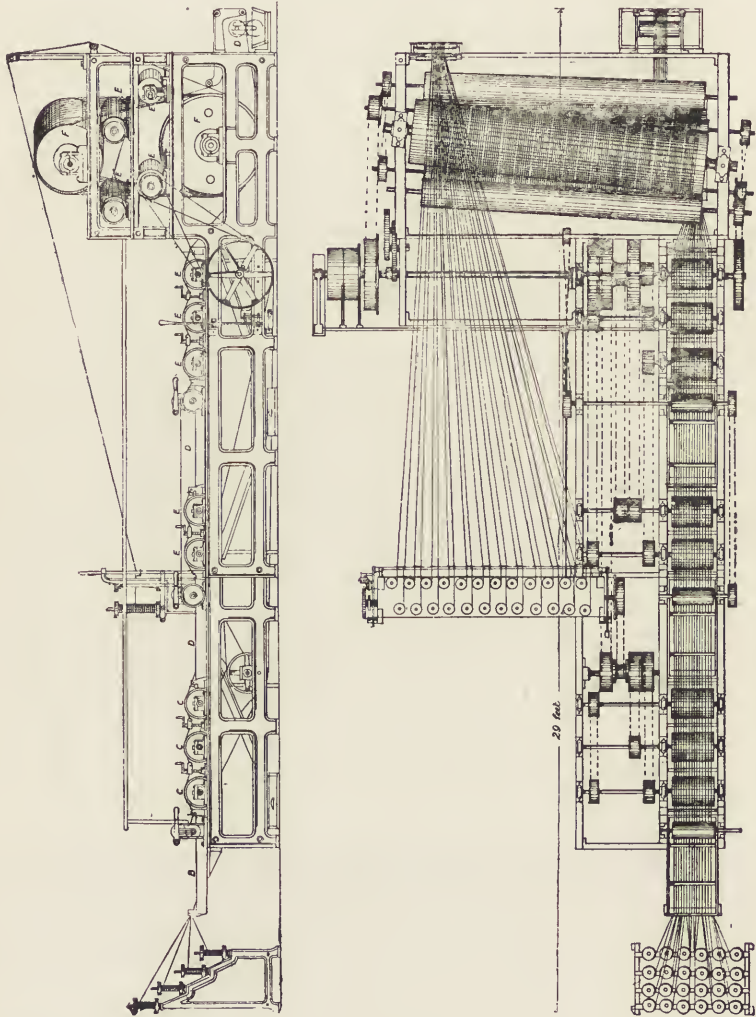

FIG. 94.—Twine polishing machine. (Made by Mr Wm. Bywater, Leeds.)

somewhat similar construction. Threads are sometimes sized in the hank, which, after being put through a pair of indiarubber squeezing rollers, is put on to the polishing rollers of the machine shown in fig. 96. The hank revolves there until sufficient lustre has been put upon the thread.

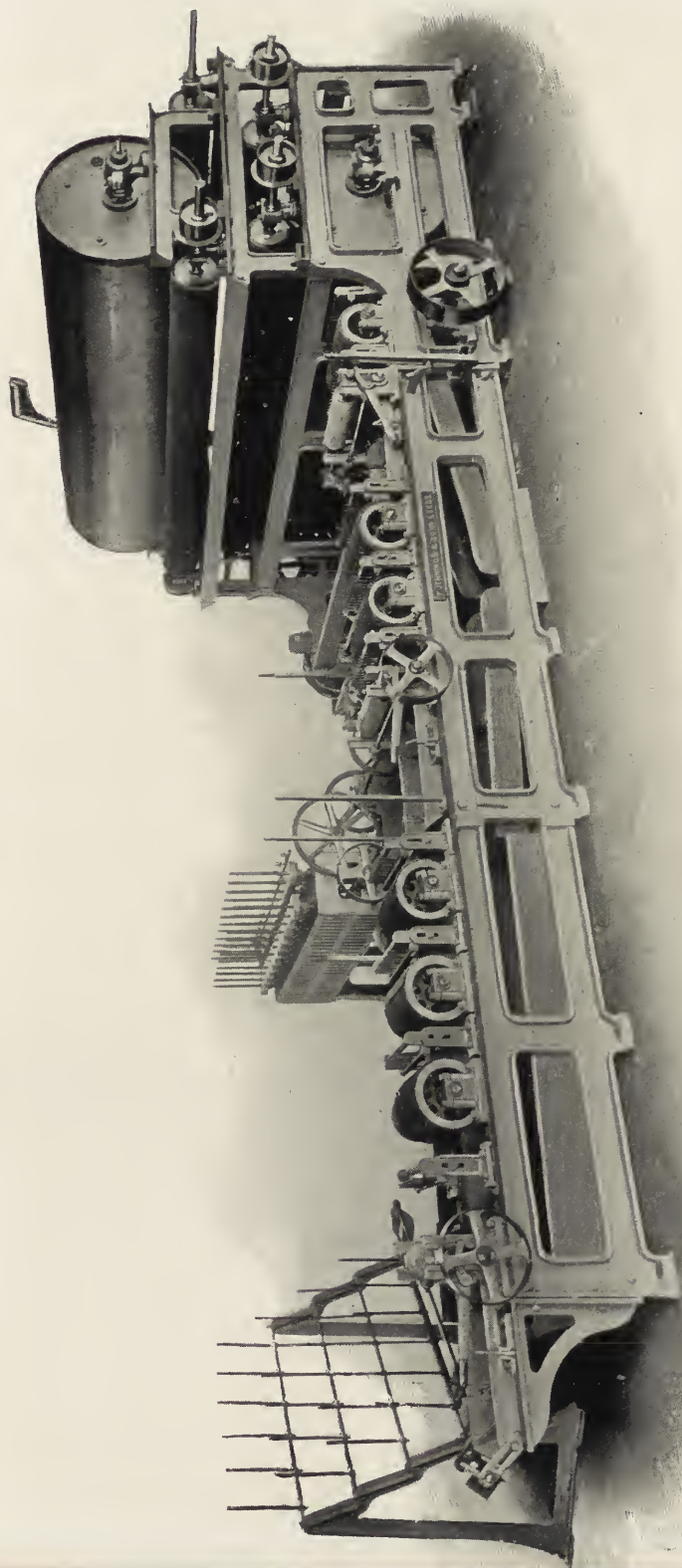

FIG. 95.—Improved large twine polishing machine. (Made by Messrs Thomas Jennings & Sons, Leeds.)

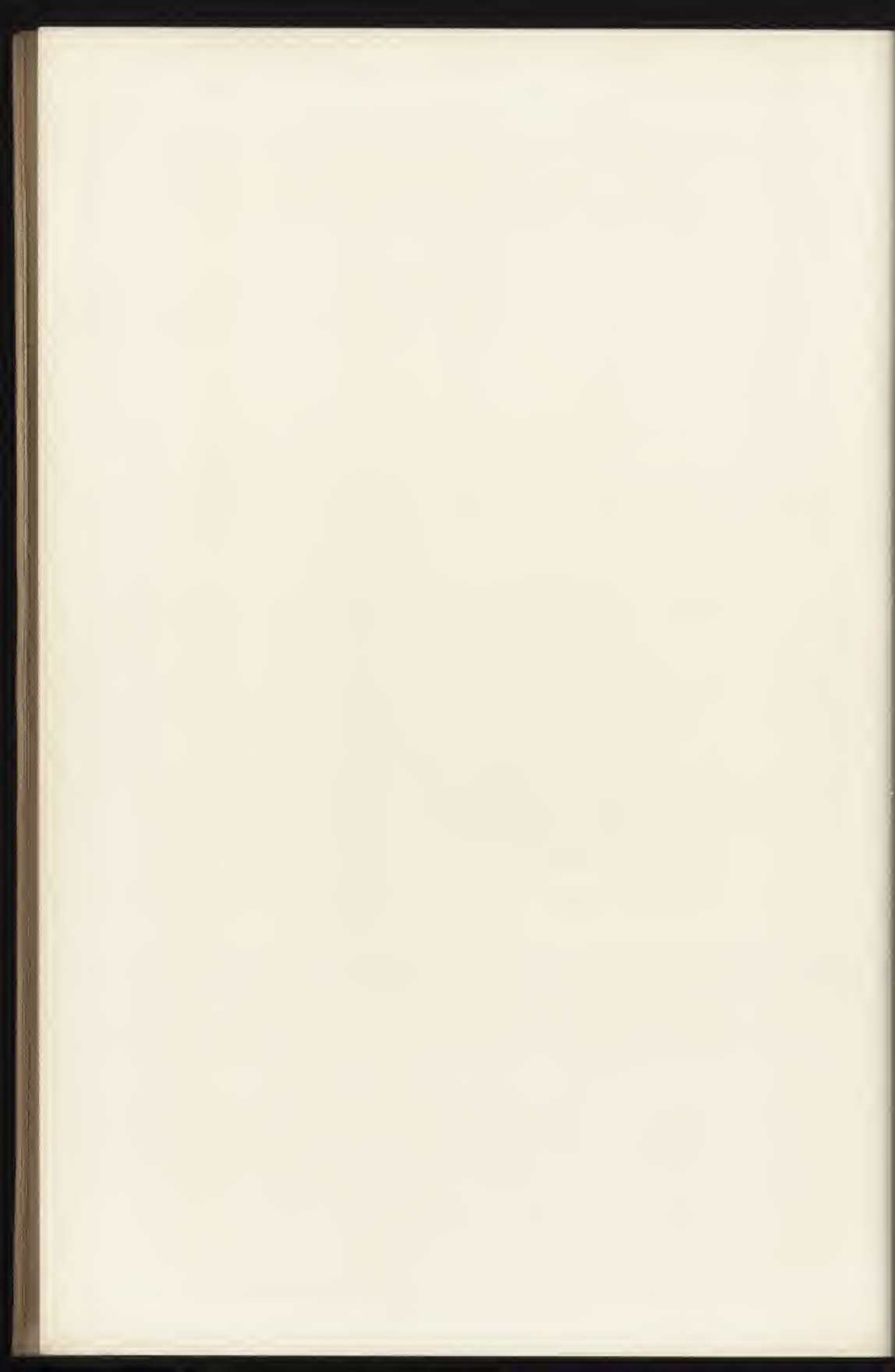

Fig. 97 is another form of cord bobbin-to-bobbin polishing machine used for polishing picture and window-blind cord.

Starch or Dressing.—Potato flour is much used in the preparation of starch or dressing for twines, while for threads such materials as oil, white wax, gum tragacanth, gum arabic, Castile soap, borax, salts of sorrel, alum, salt, gelatine, Iceland or Irish moss, zinc chloride, etc., are sometimes mixed in small quantities with the size or starch, if a patent glaze be not employed. Yarns for coloured threads should be hank dyed. For light shades the yarns must be first bleached or, at least, boiled in soda lye.

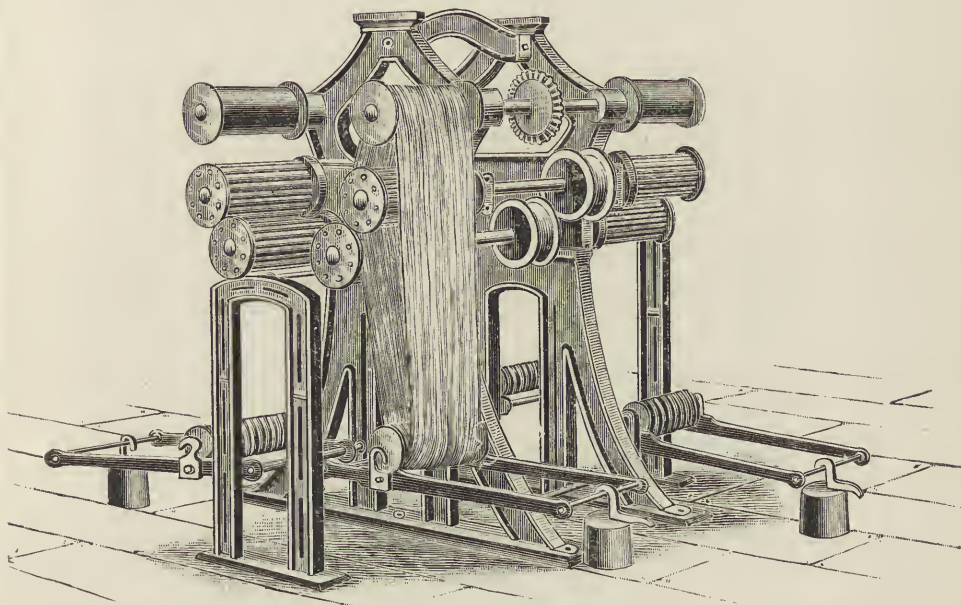

FIG. 96.—Double-sided hank polishing machine.
(Made by Messrs Walter M'Gee & Son, Ltd., Paisley.)

Softening Threads.—For some purposes linen threads require to be softened after twisting and reeling. This is done by placing the hanks upon the hooks of the hank twisting machine shown in fig. 98, which first twists the hanks tight in one direction and then automatically reverses the motion and twists them in the opposite direction, repeating the operation until the required degree of softness is attained. The bottom hook rail, of course, lifts as the hank shortens or contracts by twist, and in this way actuates, at a certain point, the reversing gear, consisting of the usual arrangement of two loose and one fast pulley with an open and crossed belt. The top hooks are turned by bevel gear, as shown.

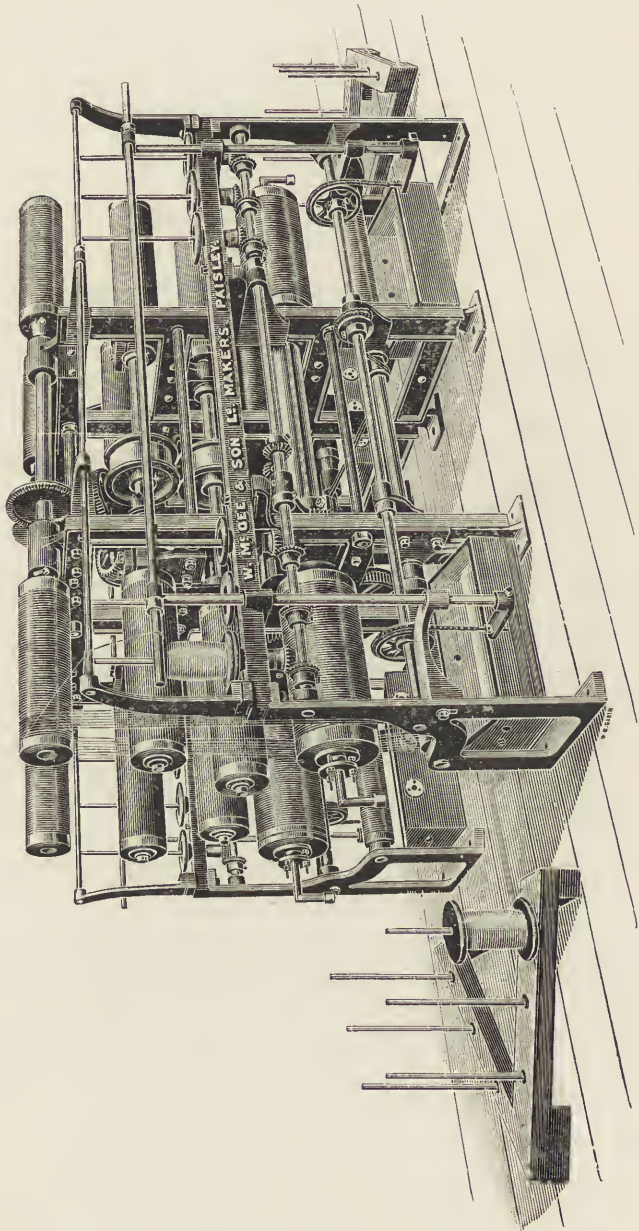

FIG. 97.—Bobbin-to-bobbin cord polishing machine. (Made by Messrs Walter M'Gee & Sons, Ltd., Paisley.)

Thread Glazing.—Threads are sometimes glazed in the hank by rolling under pressure in a machine similar to that shown in fig. 99. In this machine the middle roller, which is usually of compressed paper, swivels outwards, permitting the hank to be evenly spread around it and the tension roller. The middle roller is then swivelled back into its place and the work proceeds. An automatic crossing motion is applied so that every

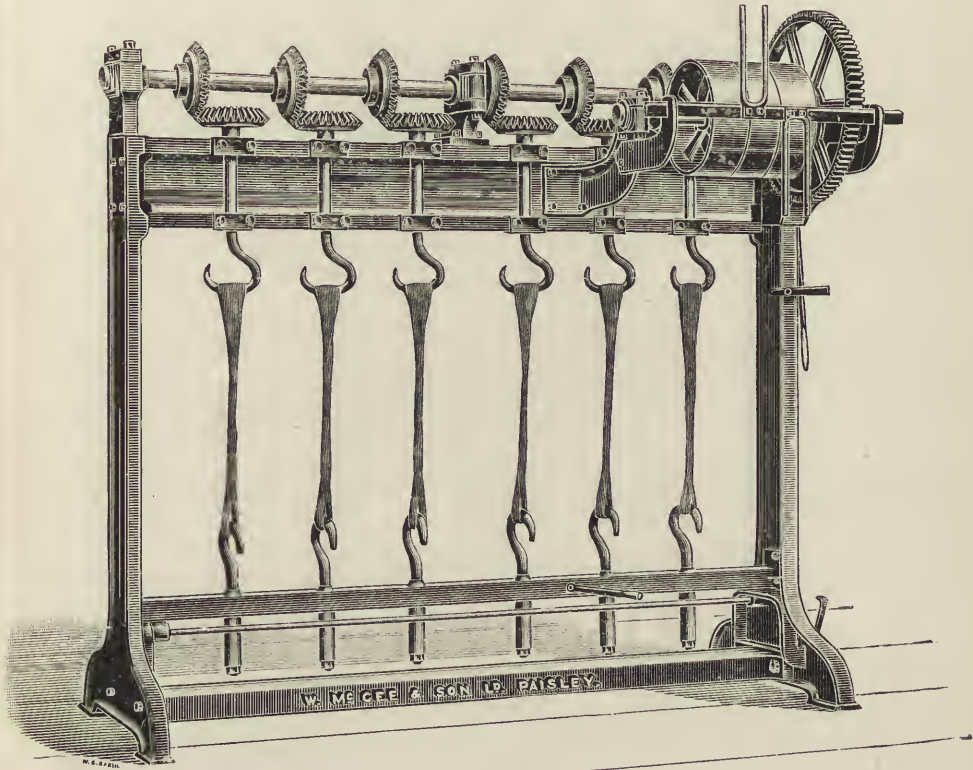

FIG. 98.—Hank twisting machine for linen or cotton threads.

thread of the hank is equally polished, and in order that every hank may be worked alike, there is also a knocking-off motion by means of which the time occupied in rolling each hank is automatically arranged, thus ensuring regularity of finish.

Balling Yarns, Threads and Twines.—Nearly all shoe yarns, as well as shop twines, are put upon the market in balls varying in weight from 1 oz. to 16 ozs. These balls are made upon a balling machine, which works upon the same principle as that used for reaper yarn and described on page 222. Figs. 100, 101, 102, 103, and 104, show different forms

of balling machines suitable for shoe threads and shop twines. Fig. 100 makes balls up to $2\frac{1}{4}$ inches diameter, the shaping of the ball being done by hand. Upon the machine, fig. 101, larger balls up to 6 inches diameter

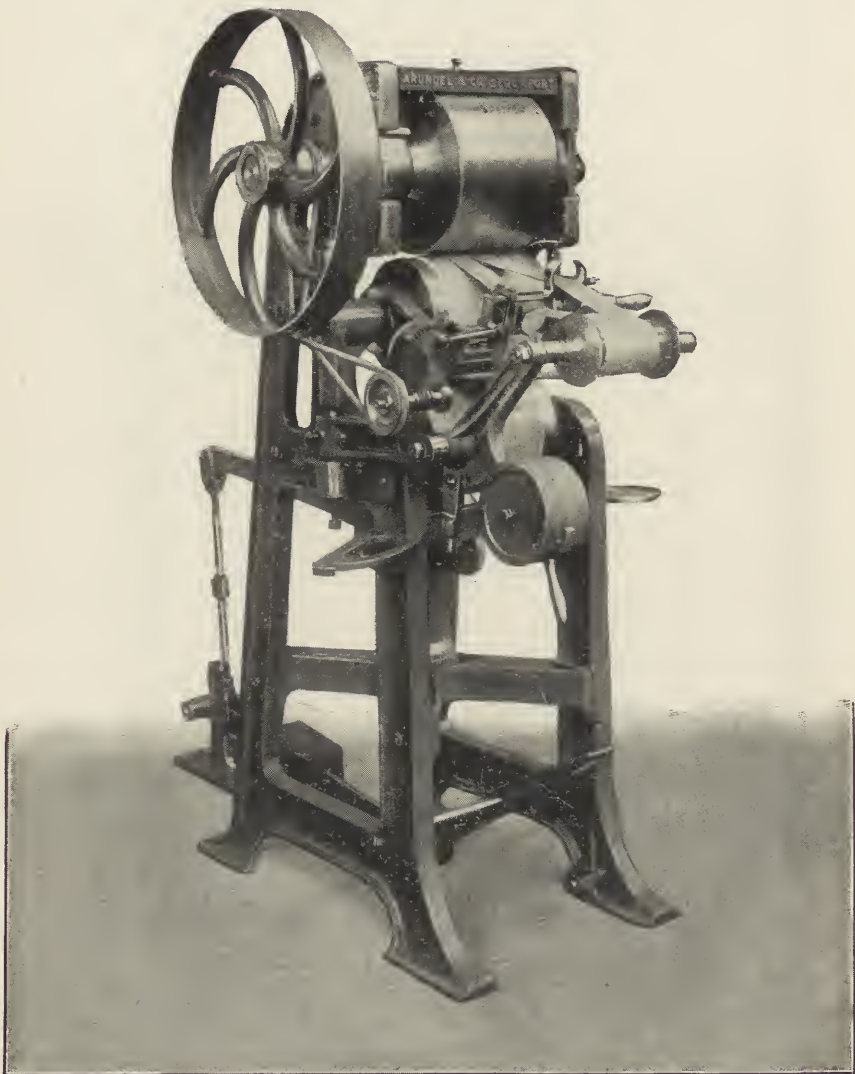

FIG. 99.—Improved yarn preparing machine. (Made by Messrs Arundel & Co., Stockport.)

may be made. The machine, fig. 102, is made in four sizes: No 1 for making small balls of yarn; No. 2 for balls of shoe thread; No. 3 for making $\frac{1}{4}$, $\frac{1}{2}$, and 1 lb. balls of shop twine, and No. 4 for making heavier twines into

2 lb. balls or less. These machines make two balls at once. The ball pegs are driven by a friction plate and change wheels.

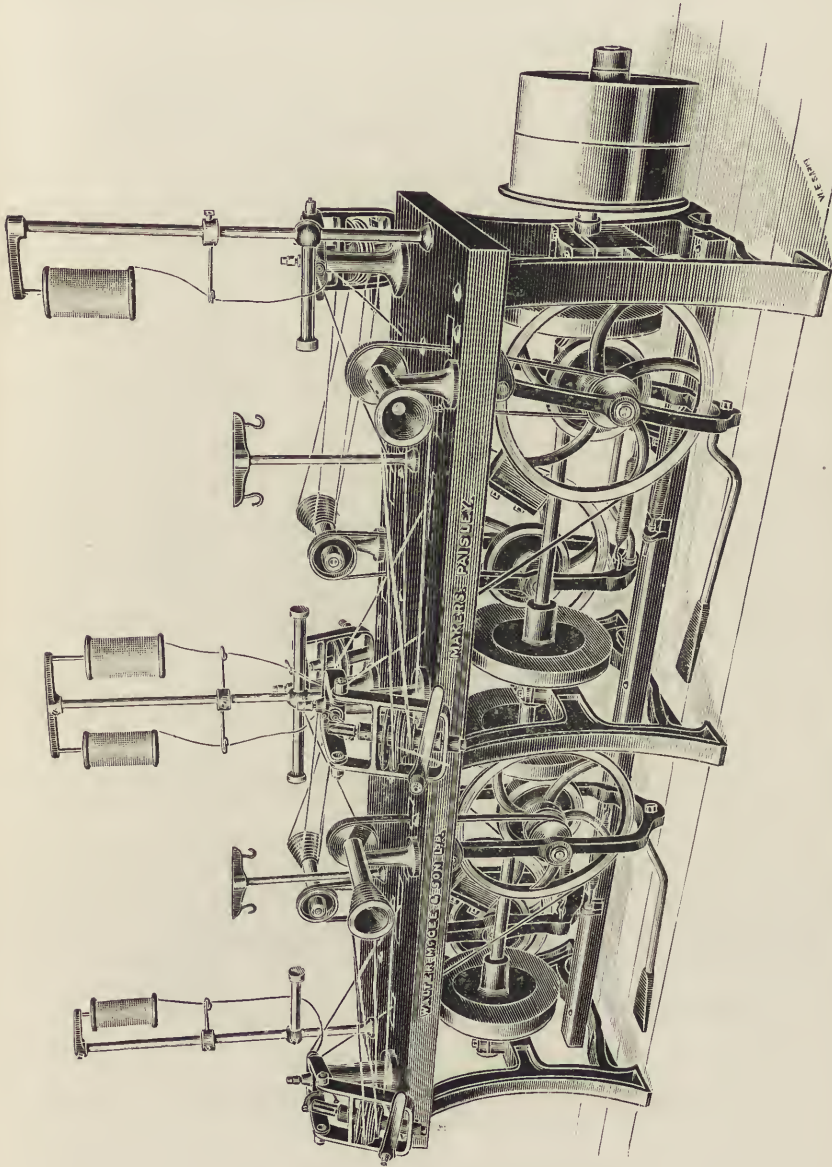

FIG. 100.—Hand balling machine. (Made by Messrs Walter M'Gee & Son, Paisley.)

The machines shown in figs. 103 and 104 are for still heavier twines, and will make balls up to 8 lbs. in weight. It will be seen that the

principal organs of the balling machine are the flyer and the ball peg upon which the ball is formed, and which lies at a variable angle between the

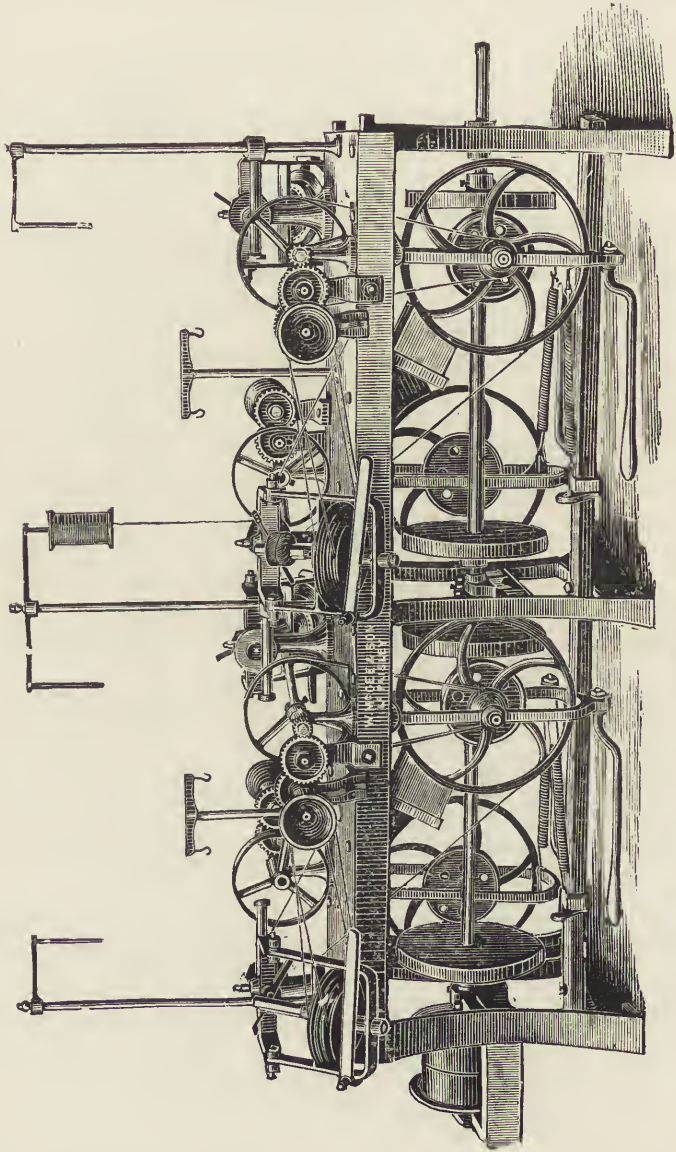

FIG. 101.—Balling machine for large balls.

legs of the flyer. The closeness together of the laps of thread or twine forming the ball depends upon the speed of the ball peg, which should be turned slowly upon its own axis. The ball is shaped by changing the

inclination of the ball peg either automatically or by hand, while the changes of speed are effected by shifting the position of a bowl upon a friction plate or cone, or by shifting a band upon the grooved cone pulleys.

Skeining Threads.—Carpet and tailors' threads are generally skeined upon a power reel, such as described on p. 207, "cross reeling" being preferable, as the end is more easily found. The swifts used are generally

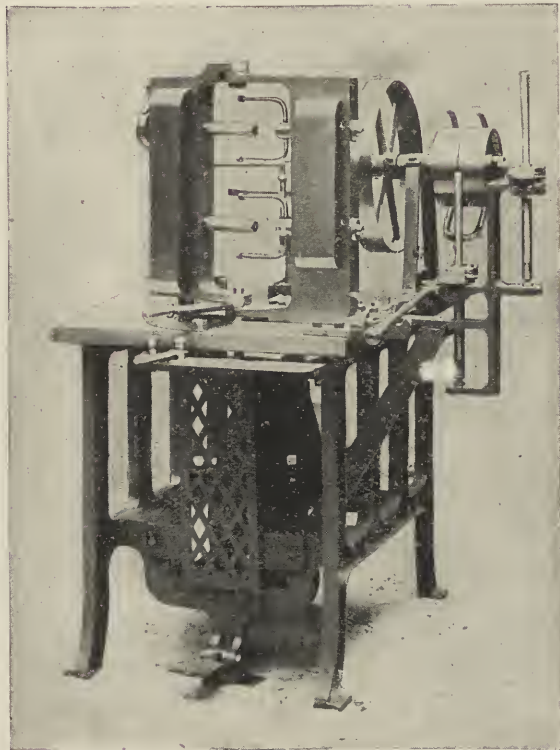

FIG. 102.—Balling machine (four sizes).
(Made by Mr Wm. Bywater.)

45, 50, 60, 72 or 90 inches in circumference, and the skeins 1 oz. or 2 oz. in weight. Bookbinders' and Jacquard threads are also usually skeined, the former in skeins $\frac{1}{2}$ oz. to 2 ozs. in weight, and the latter in skeins of 2 ozs. to 8 ozs. "Gilling" twine for fishing nets is generally balled. Shoe threads, carpet and tailors' threads, are also sometimes wound upon paper tubes on a split drum cheese winder or upon a roll winder, such as Leeson's Universal, or a machine like that shown in fig. 105.

Leeson's Universal Winder.—This machine is made in four sizes, and will make rolls from $2\frac{1}{4}$ to 12 inches long. In the smaller machines the

thread guide traverse is worked by a cam, but in the others it is worked by a screw. Each head is automatic in stopping at any given size of roll, or when the end breaks or runs off. It will be noticed that when the roll reaches a certain diameter the rate of thread traverse bears such a relation to the circumferential speed of the roll that the laps of thread lie closely and regularly. At that moment the rolls have a nice appearance, which renders them suitable for retailing.

“Randing” Twines.—Twines are sometimes made up into “rands” (see

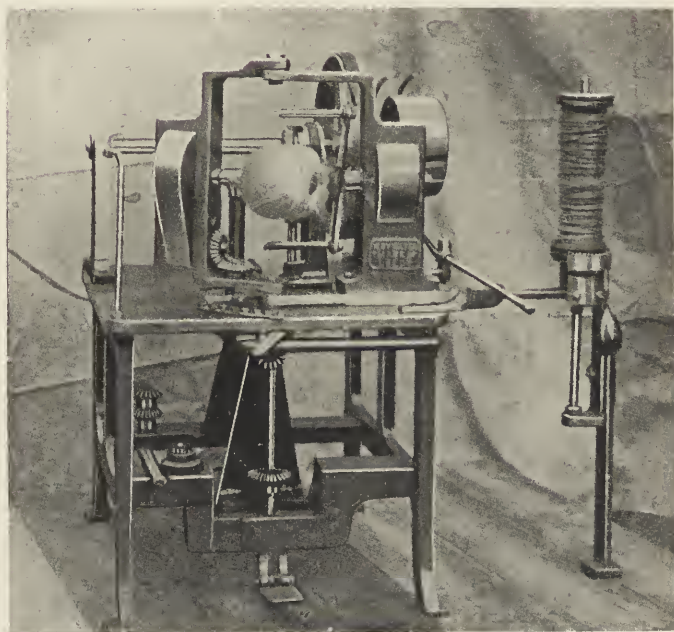

FIG. 103.—Balling machine (for large sizes). (Made by Mr Wm. Bywater.)

fig. 106) 10 inches to 4 feet in length upon the randing machine shown. The twine is first lapped round and between the hooks fixed at the required distance, the end being then wound on the “rand” by a leading screw, the speed of which is changeable to suit various thicknesses of twine.

Spooling of Sewing Threads.—Ordinary linen sewing threads are generally put upon the market on spools or reels one or two ounces in weight and containing a given length of thread. The inclined sides of the well-known reel or spool necessitate a winding machine of delicate and intricate construction. In the newest machines of this sort the empty reels are placed in a sort of magazine, from which they are fed, one by one, to the winding mandril or spindle. As many as ten spools may be wound at one time, and as they run up to 5000 revolutions per minute, a daily pro-

duction of 30 gross of 200 yard spools may be obtained. The spools are pushed on and off the winding spindles by means of a sliding piece and lever. The thread guide is attached to a rocking shaft, and kept pressed against the thread upon the spool by means of a suspended weight or a spring. The presser guide is traversed in opposite directions by means of right and left-handed screws, with which sectional nuts, attached to arms fitting loosely on the presser guide, are alternately brought in contact upon



FIG. 104.—Balling machine (for large balls).

the guide reaching the end of its traverse. These arms and nuts cause the presser guide to move in either direction, according to which of them is engaged with the screw above it. The distance which the presser guide is moved to the right or left, or the engagement or disengagement of the sectional nuts with their screws, is regulated by the contact of feelers attached to the thread guide, with the conical sides of the spool, or by a cylindrical traverse changer. This changer, if used, should have half as many long projections as there are layers of thread upon the spool to be wound, the length of these projections progressively increasing as the space between the conical ends of the spool increases. The sectional nuts are

raised into contact with the screws by means of springs. The arm of each nut has upon it a lip which engages the space between the projections on the changer. The nut is thus kept in contact with its screw until the inside of the lip is traversed beyond the end of the projection, when the nut falls out of contact with the screw. At the same moment, the other nut and arm

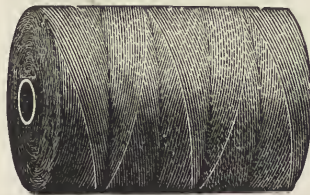
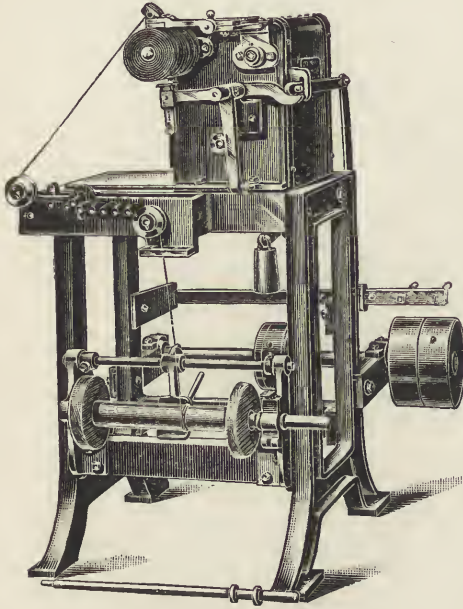

FIG. 105.—Roll winding machine.
(Made by Mr Wm. Bywater.)

are automatically raised, and the presser guide is traversed in a similar manner in the opposite direction. The raising of the nut at each end of the traverse turns the changer one division. The speed of the thread traverse is regulated, by the position of a belt upon a pair of cones, to suit the diameter of the thread being wound. When the spool is completely wound, a nick is automatically cut in its edge, and the end inserted and cut off, the full spool pushed off into a receptacle and replaced by an empty one from the magazine, the same being even automatically stamped or labelled in its passage through the machine.

Figs. 107, 108, 109, 110 and 111 show different systems of thread spooling machines. Fig. 107 is a hand machine, in which the girl has to fill the reels by her hand with a guide which is traversed by a right and left-handed screw. The machine, fig. 108,

is made in four sizes for spooling from 50 up to 10,000 yards. The attendants have only to fix the ends, take off the spools when full, and put on empty ones. The leading feature of the machine shown in fig. 109 is that there are two rows of spindles upon which the spools are filled. These spindles are fixed in a frame which revolves on bearings, so that, whilst the spools on one row of spindles are being filled with thread, the attendant can be taking off the full spools and putting empty ones on the

other row of spindles. Consequently, little loss of time takes place between the "sets," and the machine does a greater quantity of work, although not running at a high speed.

Fig. 110 is a self-acting spooling machine on Weild's principle. In this

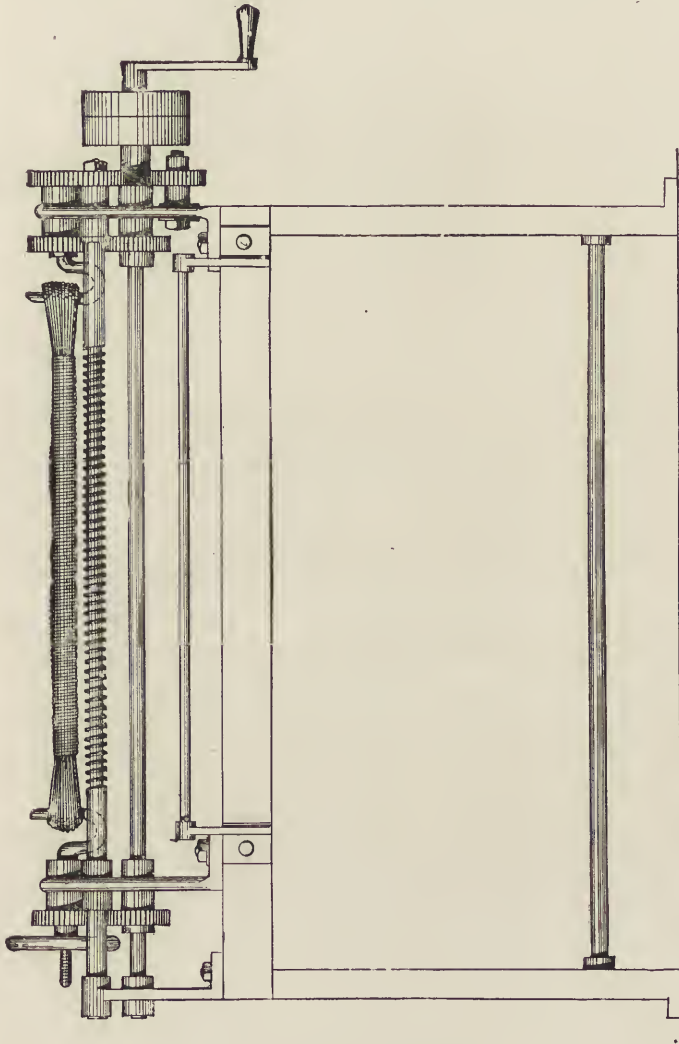

FIG. 106.—Randing machine. (Made by Mr. Wm. Bywater Leeds.)

machine the pressure of the thread guide on the surface of the spool is regulated by a cam, and the greater pressure comes only upon the last two layers. This machine is also convenient, in that half-filled spools are easily completed. The spools run on short centres, which cause them to run

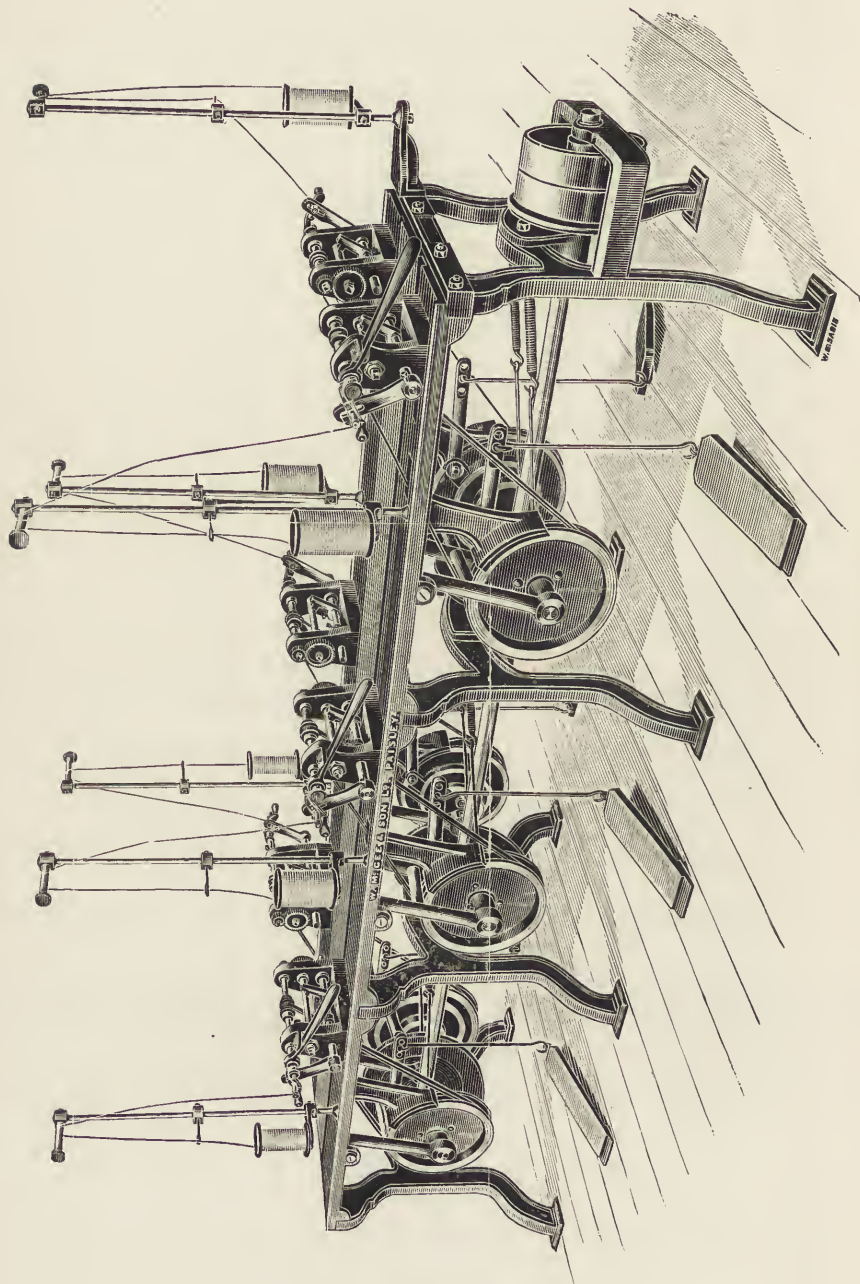

FIG. 107.—Hand spooling machine.

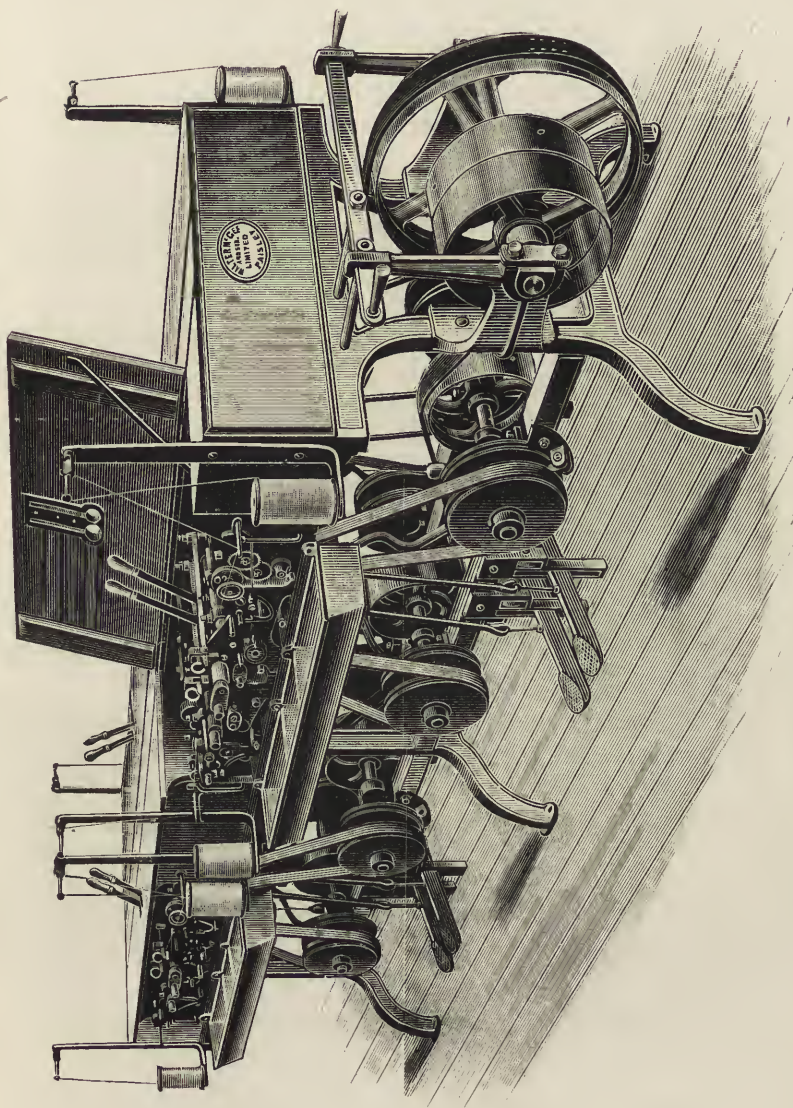

FIG. 108.—Improved semi-self-acting spooling machine (Conant system).

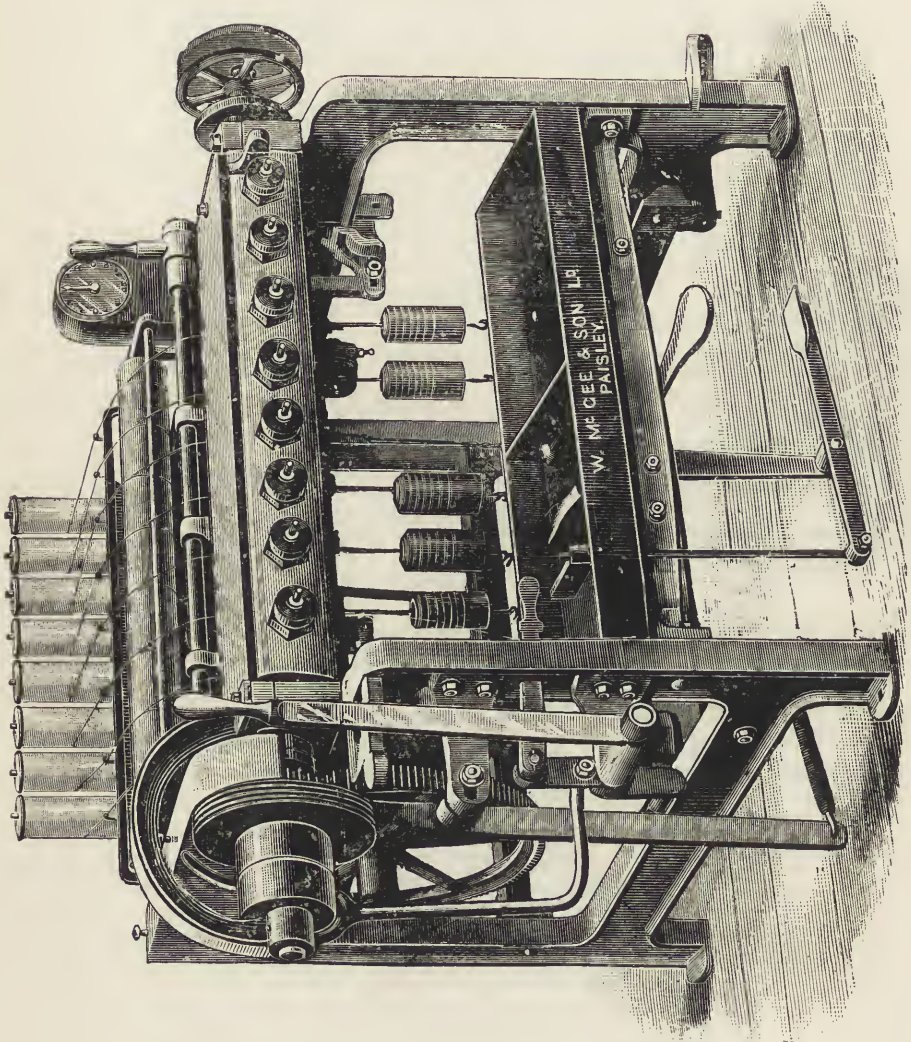

FIG. 109.—Improved 8-, 10-, or 12-spindle semi-self-acting spooling machine, for filling a number of spools at one operation (Smith's principle).



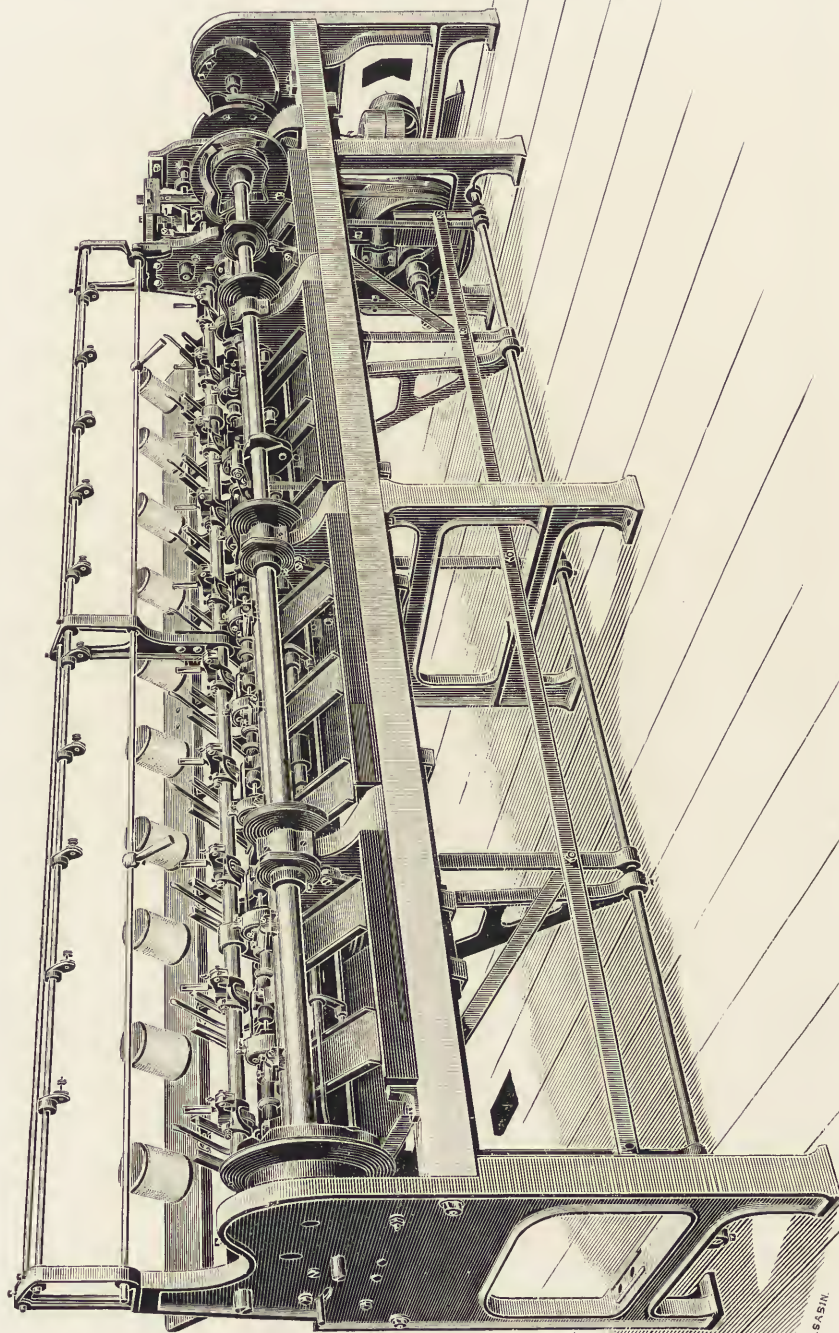

FIG. 111.—New automatic thread spooling machine (Booth's patent).

W. E. BASIN

truer and make better work. It will be noticed that there is a friction break on the top shaft for stopping the machine instantaneously when the belt is thrown off. The machine can wind spools from 1 inch long and 1 inch diameter to $2\frac{1}{4}$ inches long by $1\frac{3}{4}$ inches diameter. In the machine shown in fig. 111 the spindles are driven at both ends, enabling the spools to be run at a very high rate of speed.

Hand-measuring Reel and Re-winding Head.—A useful tool for the thread department is the hand-measuring reel and re-winding head shown in

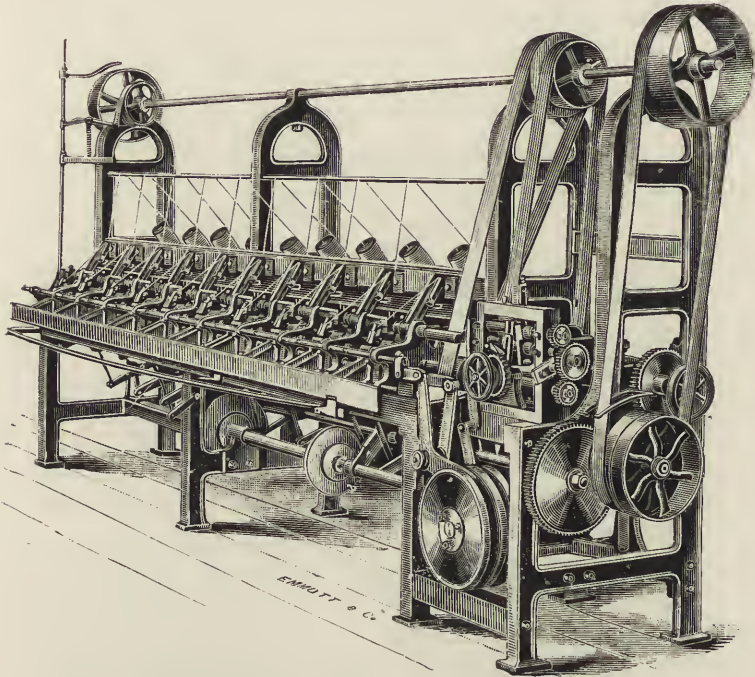

FIG. 110.—Improved self-acting spooling machine (Weild's principle).

fig. 112. The reel, which may be 36 inches in circumference, is convenient for verifying the length on small spools. There is a traverse motion for spreading the thread on the face of the reel, and a measuring motion to measure up to 1000 yards. The re-winding head shown to the left of the figure is for the purpose of re-winding on to large bobbins for re-spooling the thread which has been measured upon the reel.

Prices of Flax and Hemp Cords, Lines and Threads.—In order that the reader may have some idea as to the relative prices of flax and hemp cords, lines and threads and the yarns for producing them, we here give a comparative price list.

Flax gill spun shoe thread,	3 to 6 leas per lb.,	9d. to 12½d. per lb.
Flax gill-spun saddler's thread,	12 to 18	2s. to 2s. 2d. "
Shoemaker's hemp line yarn,	8 to 12	12d. to 13d. "
Dry and demi-sec hemp line yarn,	1 to 12	8d. to 12d. "
Dry and demi-sec hemp tow yarn,	1 to 12	5d. to 9d. "
Wet spun hemp line yarn,	3 to 25	7d. to 1s. 6d. "
Wet spun hemp tow yarn,	3 to 18	6d. to 11d. "
2-fold 6-lea to 2-fold 16-lea flax threads,		10d. to 17½d. "
2-fold 6-lea to 6-fold 16-lea demi-sec spun shoe threads,		14d. to 2s. "
2- or 3-ply hemp seaming twine,		8d. "
2- or 3-ply hemp shop twines,		6d. to 8d. "

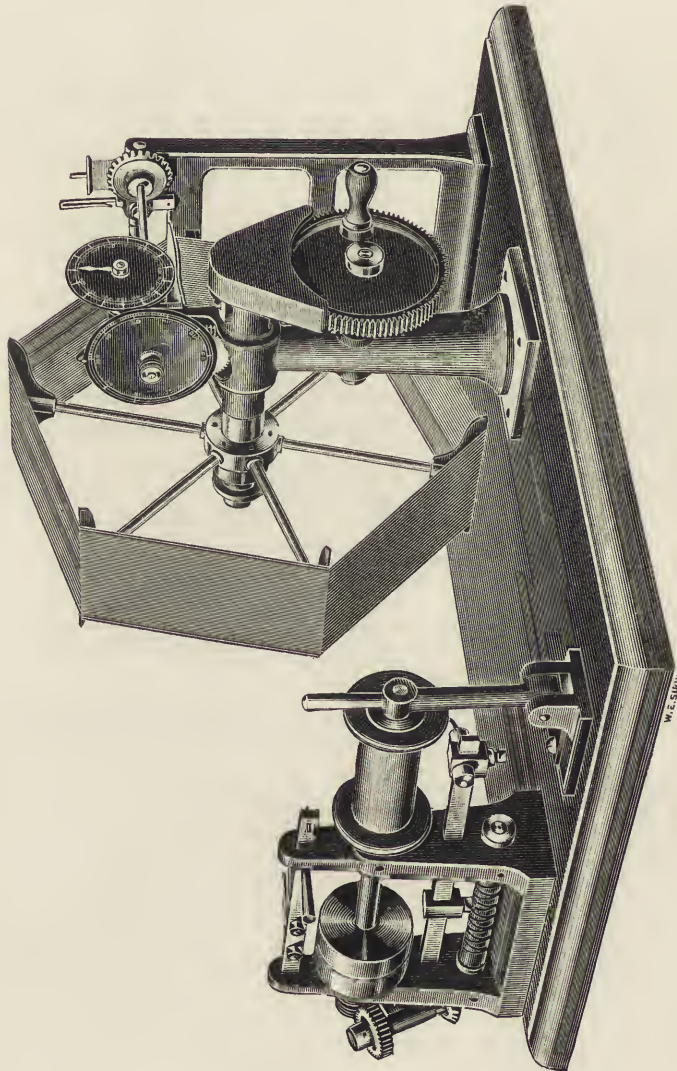

FIG. 112.—Hand-measuring reel and re-winding head.

CHAPTER XVII.

ROPE MAKING.

Construction of Ropes.—Hemp is practically the only one of the long vegetable fibres used by rope makers. The soft hemsps are best for the standing rigging of ships, or for running rigging where a heavy purchase is required, while Manila is preferred for light running rigging.

Ropes are made by twisting several yarns together into strands, each strand containing an equal number of yarns, then laying them up in a spiral form so that each separate yarn bears an equal strain. The strength of the rope is the combined strengths of each of the separate yarns, and unless these yarns be very carefully twisted together, so as to bring an equal strain upon each part, the rope is imperfect. The strands must then be smoothly, evenly and closely laid. Ropes may be divided into three classes, namely, hawser-laid, shroud-laid, and cable-laid.

A hawser-laid rope is composed of three strands of yarn, twisted to the right or with the sun.

A shroud-laid rope has four strands, and is twisted in the same direction as the foregoing.

A cable-laid rope is composed of three hawser-laid ropes twisted together to the left or against the sun. It thus actually contains nine yarn strands.

The remarks which were made on p. 235 about thread construction hold good also as regards ropes, for the best and strongest cordage is built up of a large number of single yarns composed of long fibres placed parallel to one another, with the end of one fibre overlapping the end of its neighbour, the whole being secured together by friction produced among them by twisting. As the strength of the fibres, however, is diminished when they are twisted out of the direction of the tensile strain which they are to sustain, no more twist should be given than is necessary to impart sufficient friction to prevent them from slipping and parting endwise.

In order to produce a cord or rope which will not stretch much, and in which the strain is equally borne by the large number of single yarns of which it is composed, the latter may be stretched and held without twisting whilst a few well twisted strands are wrapped around this central core,

producing a rope which will not stretch much and which will resist a good deal of friction.

Cablets are small cable-laid ropes measuring from 1 to 10 inches in circumference; larger sizes are termed cables. Shroud and hawser-laid ropes seldom exceed 10 inches in circumference.

Shroud-laid ropes require a core placed in the centre of the strands which are laid around it. As its object is merely to keep the strands in position, it is generally made of inferior yarn.

Flat hemp ropes are made of four or six ropes, each composed of three strands and laid alternately to the right and to the left; these are stretched side by side and sewn through in a zigzag direction.

Bolt rope, which is sewn around the edges of sails of ships, should be well made of fine yarns spun from the best Riga or Rhone hemp well tarred in the best Stockholm tar. There should not be too much tension when closing the strands, as it causes the rope to be hard to sew on. A hard stranded and flexible rope will last longer than a hard closed rope, which will generally break before it bends, and wears badly.

Lesson is the primary strand from which hawsers are made.

Strength of Ropes.—The strength of ropes made from the best Riga hemp is about 1700 lbs. per square inch of section.

The strength of ropes made from Manila hemp varies from 1100 to 1700 lbs. per square inch of section, according to the quality of the fibre.

Tarred ropes are about one-fourth less in strength than white cordage.

The larger the cordage the less its strength per unit of section.

The working or maximum proof strength of cordage may be calculated by multiplying the square of its circumference in inches by 200 to 300 lbs.

Rope Manufacture and Machinery.—Ropes are made in one of two ways—either in a long rope walk by means of machines which work in pairs, and which are technically known as the “foreboard” or “foreturn machine” and the “traveller,” or in an ordinary building upon “house machines,” which comprise stranding and closing machines. The length of a rope walk should not be less than 150 fathoms or 900 feet, so as to produce ropes of a minimum length of 120 fathoms.

The yarns used by the rope-walk spinner have either been spun by hand or have been bought from the machine spinner in the form of warps or hauls. If a tarred rope is to be manufactured, the hauls of yarn are first passed through the tarring machine, fig. 113, and then, after lying for a few hours, wound upon large bobbins in a yarn winding machine, such as is shown in fig. 114. In the tarring machine the tar is contained in a wooden tar tank 12 feet long, 18 inches wide, and 32 inches deep, which may advantageously be lined with copper. The tar is heated by solid drawn copper steam coils. The machine has a

powerful double-gear'd hauling-out apparatus, as well as a nipping and immersion apparatus.

Tarred rope is extensively manufactured, as it is less subject to injury

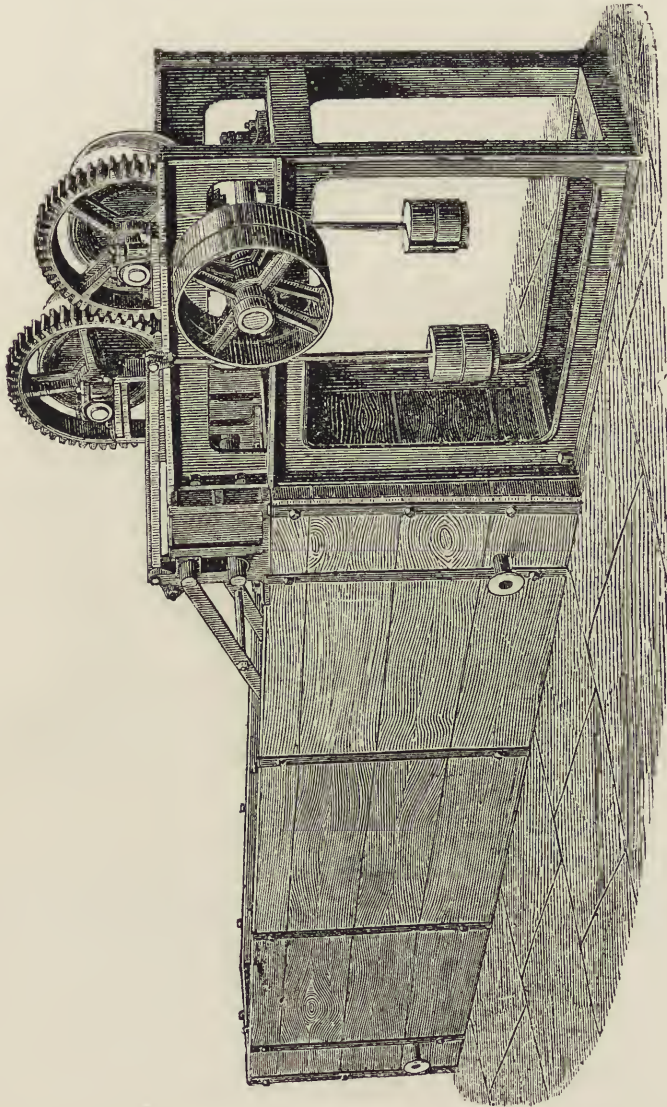

FIG. 113.—Yarn tarring machine. (Made by Thomas Barraclough, London.)

by the weather than white cordage. Rope yarns take up from 20 to 30 per cent. of their weight in tar. Russian hems take the tar particularly well. At one time it was thought that coal tar burned the strands and was

not suitable for ropes, but it is now recognised that this is not so, and it is consequently much used, as is also Archangel and Stockholm tar, or a mixture of both. The tar should be heated to 220° F. in order to evaporate the moisture. The speed of the yarn through the tar should not exceed 15 feet per minute.

The forming of a strand is the first operation in the production of a rope. In the rope walk this is done by means of the forming machine or traveller shown in fig. 115. This machine runs on rails from one end of the walk to the other, being made to travel by means of a ground rope, which, made fast at the ends of the walk, is coiled round a drum, so that by the revolu-

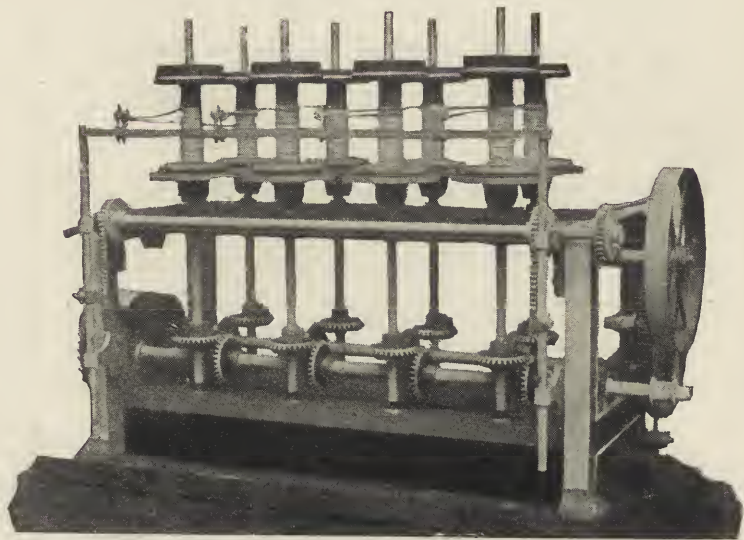

FIG. 114.—8-spindle yarn winding machine.
(Made by Thomas Barraclough, London.)

tion of the drum the machine is made to travel along the walk. The ground rope drum is caused to revolve by means of an endless rope called a fly rope, which takes a turn round a whelp wheel and, passing round pulleys at the top and bottom of the walk, acts as a driving rope, being driven by an engine. The revolution of the ground rope drum is communicated by means of gearing to the twisting hooks, or "nibs" upon which the yarns to be twisted into strands are hooked. Each hook takes the number of yarns required to form the strand, the yarns, after leaving their bobbins, passing first through separate holes in a register plate, shown in fig. 116, and then converging into one common point through a carefully bored and bell-mouthed cast iron tube set in a steam chest (also shown in fig. 116) which heats the tube. The hole in this tube is taper, and varies in diameter

for each size of strand. The hole in the tube necessary to form a strand for a rope 3 inches in circumference, for instance, being $\frac{1}{2}$ inch diameter at the

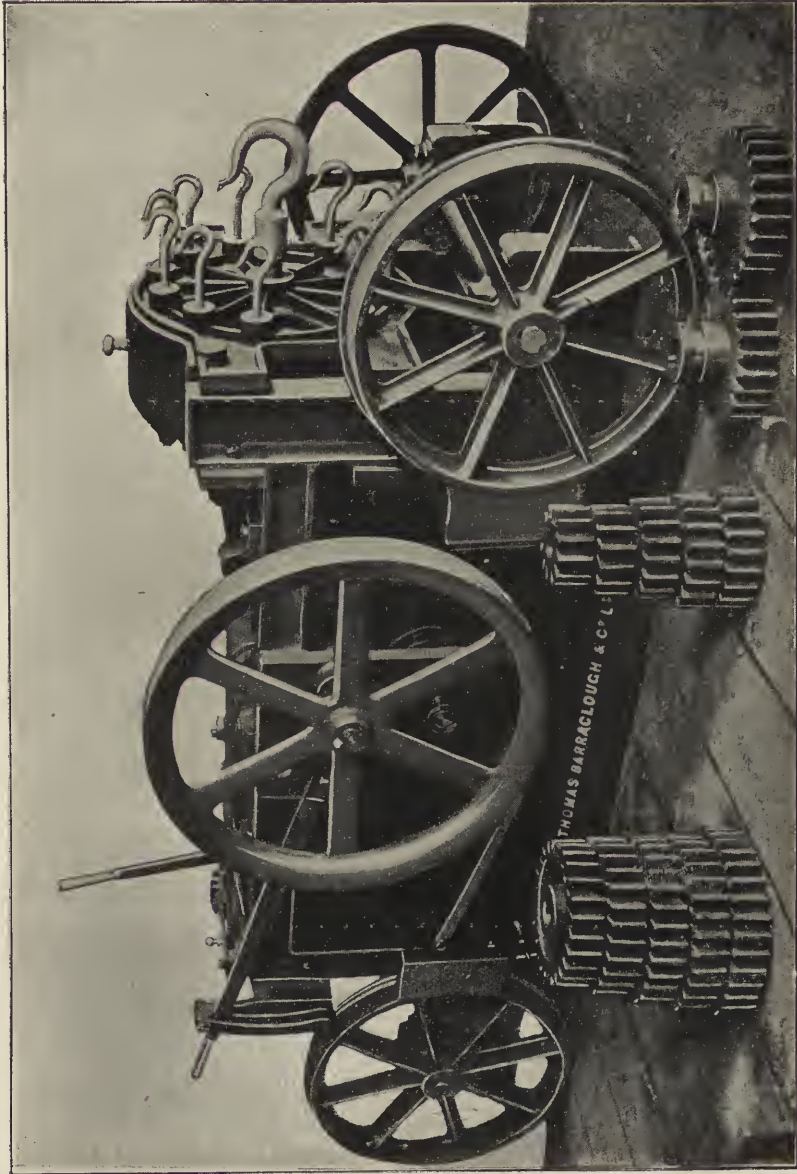

FIG. 115.—Traveller. (Made by Thomas Barraclough, London.)

smaller end and $\frac{9}{16}$ inch diameter at the larger end, and for the strands of a rope 2 inches in girth $\frac{5}{16}$ inch at the smaller end and $\frac{7}{16}$ inch at the larger

end, the convergent yarns from the concentric circles of drilled holes in the register plate enter the tube at the large trumpet-mouthed end and are forced through, fitting tightly into the tube; they are thus squeezed tightly together before being attached to the forming machine, fig. 117.

The correct twist is given to the strands by introducing a suitable change pinion into the gearing connecting the ground rope drum with the twisting hooks. The desired relative speed of hooks and backward motion of the traveller is thus easily obtained.

Register or Stranding Machine.—The “house machine” upon which strands may likewise be formed is called a register or stranding machine. Occupying comparatively little space, it twists the yarns into a strand, and



FIG. 116.—Steam chest, register plates and tubes.
(Made by Thomas Barraclough, London.)

winds the latter upon a drum as fast as formed. The yarns are drawn from bobbins placed in a “bank” as before, and after traversing the holes of a register plate pass through one hollow bearing of the revolving framework of the machine which carries the drawing pulleys, the winding drum, the guiding frame and its grooved barrel. Upon the outside bearing of the revolving frame is a clutch by means of which the frame is connected with, and put in motion by, a revolving shaft. After passing through the hollow bearing of the revolving frame, the yarns of the strand take half a turn around each of two drawing pulleys, and are thus drawn forward and twisted into the strand which, passing on, is delivered and automatically wound upon a drum in a regular manner by means of a guiding frame, which is made to move from end to end of the drum by means of a stud on the frame working in a spiral groove cut in a grooved and revolving barrel. The drawing pulleys, grooved barrel, and winding drum are all driven at the proper speed

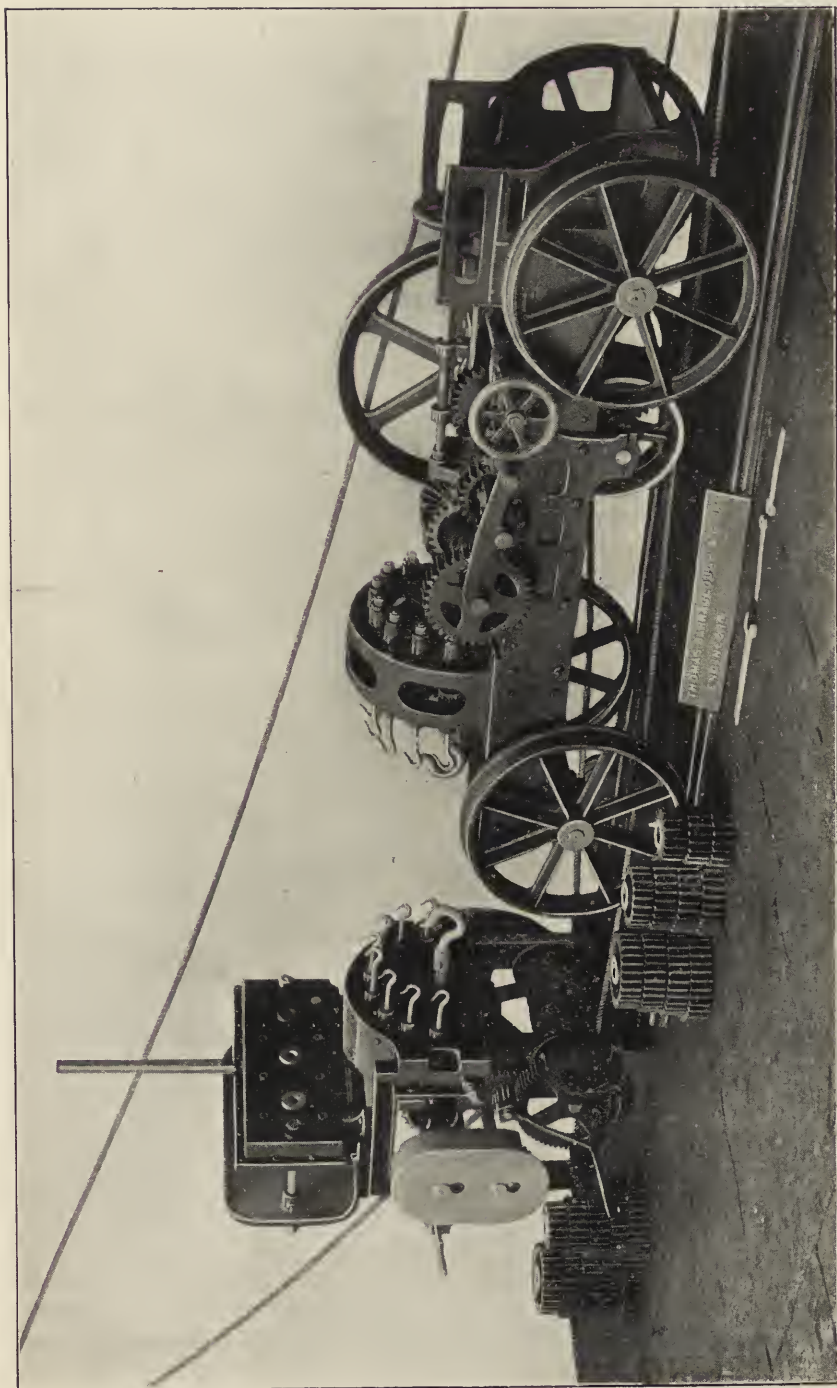

FIG. 117.—Foreturn machine and traveller.

by gearing which is put in motion by means of a spur-wheel gearing into a stationary pinion fixed to the plummer-block in which the hollow bearing revolves. A friction clutch is inserted in the train of gearing which connects the drawing pulleys and winding drum, so that the tension and speed of the strand remain constant, notwithstanding the gradually increasing diameter of the winding drum. Figs. 118 and 119 show horizontal stranding or registering machines of somewhat similar construction to the older machine just described. Change tubes are provided of exactly the same diameter internally as the outside diameter of the strand to be formed. The machine, fig. 118, is provided with an indicator to show the length of the strand made, also with a means of heating the change tubes by either gas or steam.

The strand made by the registering machine is sometimes re-wound upon

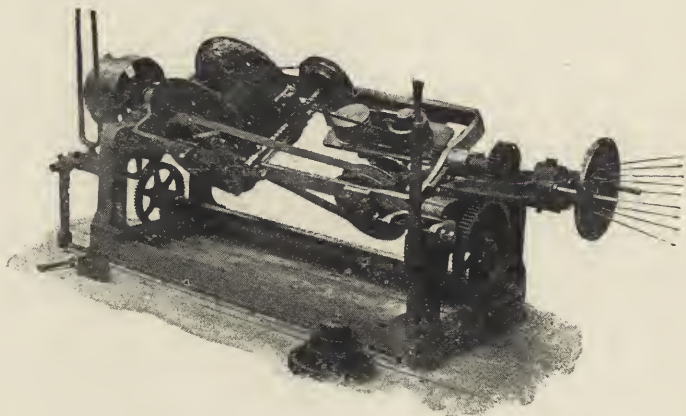

FIG. 118.—Horizontal stranding machine. (Made by Thomas Barraclough, London.)

another bobbin for the closing machine, in order that it may be laid into the rope in the same way, end for end, as that in which it was formed.

Horizontal Laying or Closing Machines.—Figs. 120, 121 and 122 show three forms of horizontal laying or closing machines for laying the strands from the stranding or register machines into ropes. Fig. 123 shows a vertical machine for the same purpose. It will be seen that these machines perform two operations, viz., they put additional twist into each strand, and then close the three or four strands into a rope, which is drawn through the machine by means of draw drums, and automatically wound upon a reel or bobbin. In fig. 120, for instance, three spools of strand from the forming machine figure are placed in the three revolving spool frames shown. The ends of strand pass first through the hollow bearings of the spool frames, and then together through a compressor to the draw drums,

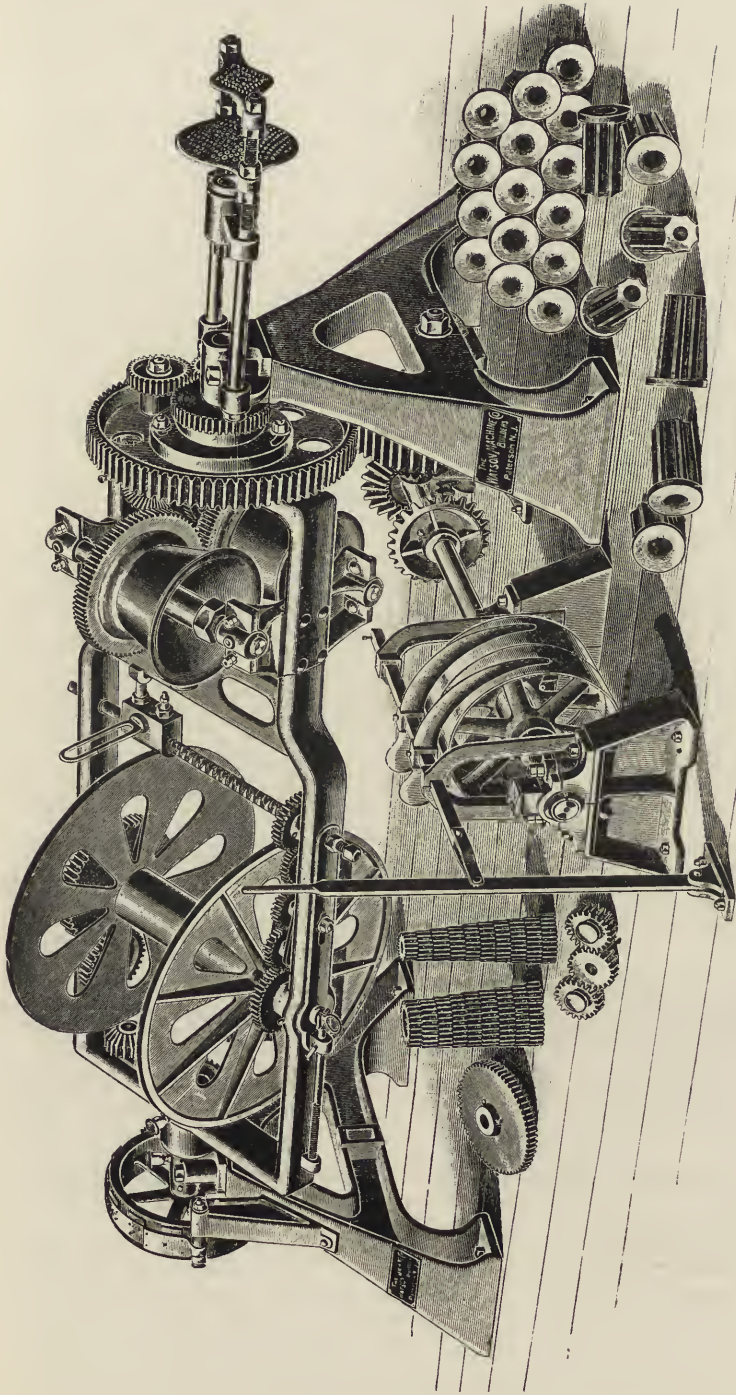

FIG. 119.—Horizontal strand forming machine to make strands from $\frac{3}{4}$ inch diameter to 2 inches diameter.

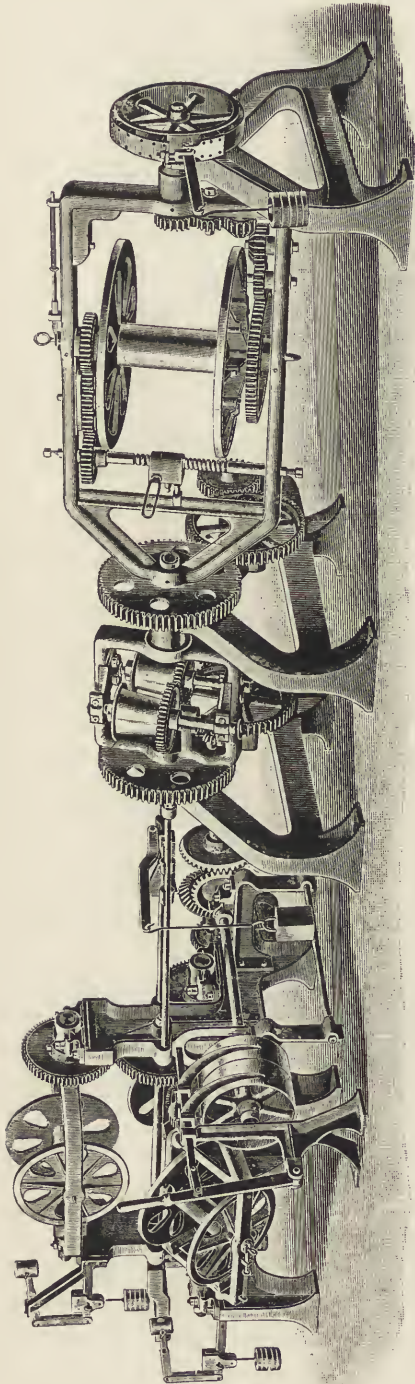

FIG. 120.—Horizontal strand closing or laying machine, to lay either 3 or 4 strands into rope from $\frac{1}{2}$ inch to 1 inch diameter.
(Made by The Watson Machine Co., Paterson, N.J.)

which, revolving with the rope drum frame, twist the strands together into a rope, which is delivered through the hollow bearing and automatically wound upon the drum shown. A uniform tension upon the strands is insured by friction breaks applied upon the edges of the strand spools.

Since, in these machines, the strands are closed into a rope by being twisted together in the reverse direction to that in which the strands themselves were originally twisted, the spool frames are turned in such a direction and at the requisite speed, not only to maintain the original twist of the strand, but also to give it a slight additional twist or forehand in order to ensure the yarns in each strand being thoroughly closed upon one another. The machines, figs. 122, 123, are furnished with a geared draw-off apparatus in the bobbin flyers to ensure perfect equality in the lengths of the strands. Stranding and closing machines are generally worked in sets, each set consisting of two stranding machines and one closing machine. Horizontal closing machines are preferable for the smaller sizes of ropes. Vertical machines are more advantageous for the larger

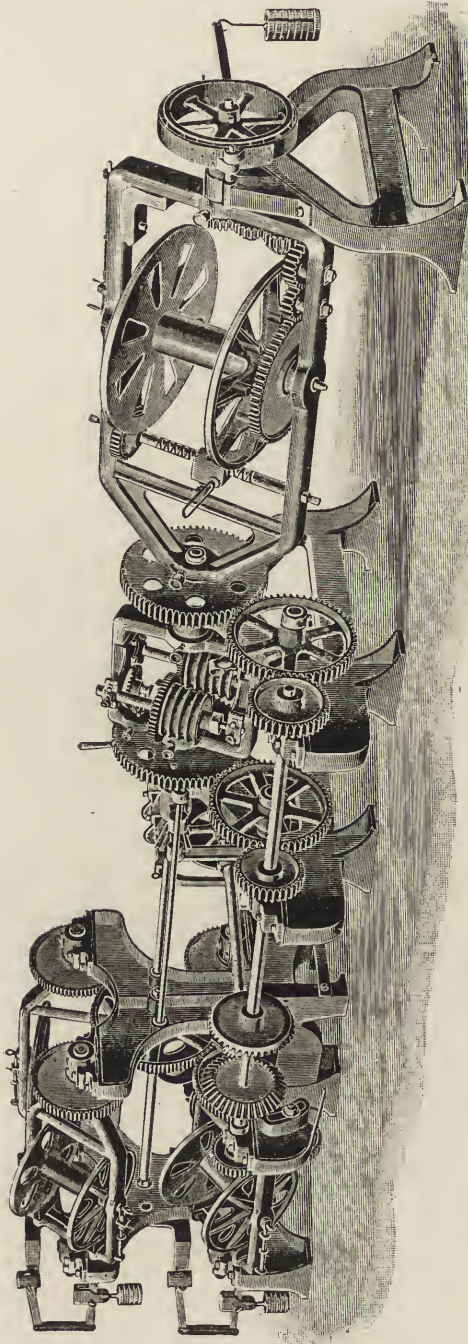

FIG. 121.—3- or 4-strand layer or closing machine to lay rope from 1 inch diameter to 2 inches diameter.
(Made by The Watson Machine Co., Paterson, N.J.)

sized ropes, principally on account of the greater facility afforded for putting the large strand bobbins in them.

The method employed in closing strands into a rope in a hand rope-walk is as follows:—The strands to be twisted together are each attached to one of the hooks of the “foreturn machine,” figs. 117 and 124, which is placed at one end of the walk. The other extremities of the strands

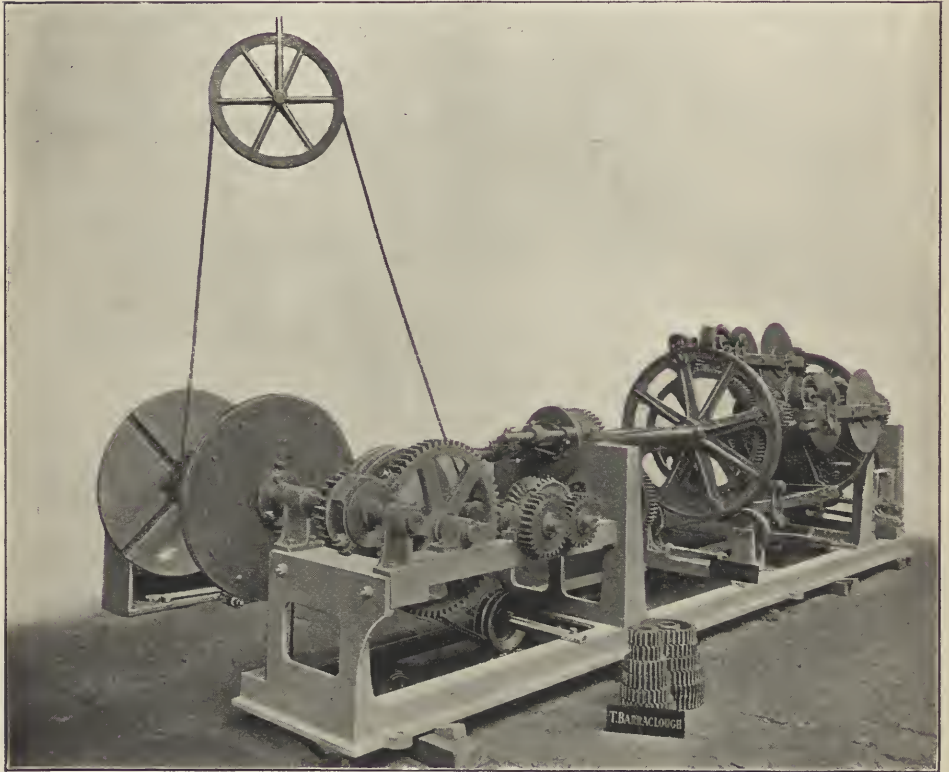

FIG. 122.—Horizontal 3- and 4-strand closing machine.
(Made by Thomas Barraclough, London.)

are attached, all together, to one of the hooks of the traveller, fig. 115, which is situated at the other end of the walk. The machines are shown together in fig. 117. The hooks turn in such a direction that while the traveller twists the strands together in the opposite direction to that in which they were formed, the hooks of the foreturn machine, turning in the opposite direction, prevent any loss of twist in the strands.

The strands for the rope are stretched tight along the walk from the hooks of the foreturn or laying machine at one end to the forelock

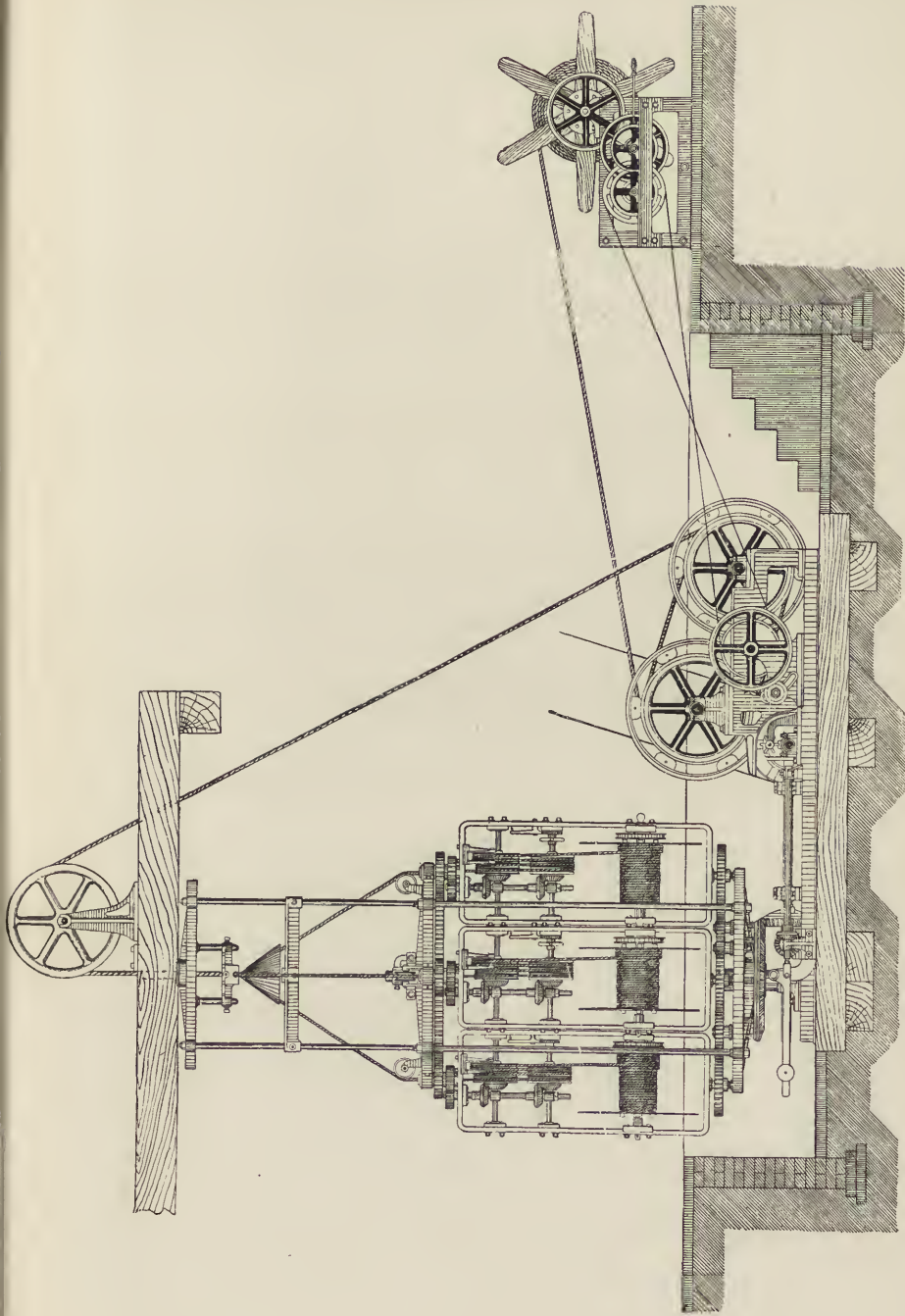

FIG. 123.—Vertical closing machine for 3- and 4-strand ropes. (Made by Thos. Barraclough, London.)

or hook of the lower lying machine or traveller, and are supported off the ground and kept separate by means of posts, placed at distances of every

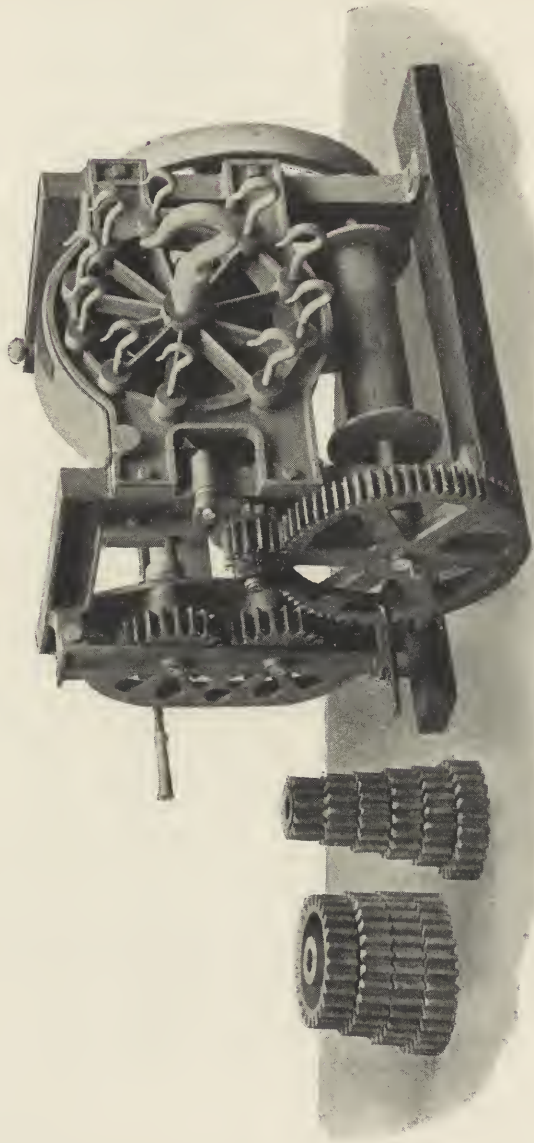

FIG. 124.—Foreturu machine. (Made by Thomas Barraclough, London.)

ten yards, with pegs to carry the strands. A taper piece of wood, fig. 125, called the laying top, is inserted between the strands close to the traveller towards which the smaller end points. The laying top has in it three longi-

tudinal grooves, A, B and C, each of which carries one of the strands. A "topstick," or handle D, passes through the top and affords a means of holding the top. Except for the smaller ropes, a top car is used for supporting the top. The forcturn machine being put in motion by means of a belt, and the traveller by means of the fly rope, the strands are laid close together, the top being forced backwards by the twist. The motion of the laying top must be very regular and slow, as it is governed by means of a piece of rope attached to the handle and coiled round the rope already twisted, thus acting as a drag. As the contraction by twist in closing the strands amounts to about 33 per cent. of the length of those strands, the traveller is drawn up the walk, its motion being retarded and the rope held tight by means of a break, or by weights placed on the framing of the machine. The degree of twist required to close strands into a firm rope is inversely proportional to the diameter of the rope. Calculated on the basis of sixteen turns per foot, which gives a well-made rope of 1 inch diameter—

A rope $\frac{3}{8}$ -inch in diameter may have 42 turns per foot.

"	$\frac{1}{2}$	"	"	32	"
"	$\frac{3}{4}$	"	"	25	"
"	$\frac{3}{4}$	"	"	21	"
"	$\frac{7}{8}$	"	"	18	"
"	$1\frac{1}{8}$	"	"	14	"
"	$1\frac{1}{4}$	"	"	13	"
"	$1\frac{3}{4}$	"	"	12	"
"	$1\frac{1}{2}$	"	"	11	"
"	$1\frac{3}{4}$	"	"	9	"
"	2	"	"	8	"
"	$2\frac{1}{4}$	"	"	7	"
"	$2\frac{1}{2}$	"	"	$6\frac{1}{2}$	"
"	3	"	"	$5\frac{1}{2}$	"

Compound Rope Machines.—

Most modern machine ropeworks are now supplied with compound rope machines such as are shown in figs. 126, 127, 128, and 129.

In fig. 126 it will be seen that the bobbins full of yarn are placed upon spindles in the wrought iron flyers. These flyers revolve each on its own axis in order to form the strands, and the flyers also revolve round a common centre (sun and planet motion), in order to lay up the rope, which is drawn through the machine by means of draw sheaves, and wound on to the

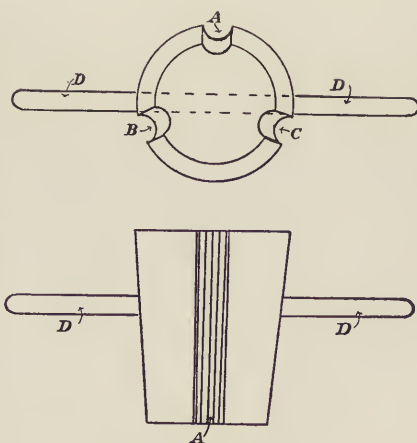

FIG. 125.—Laying top.

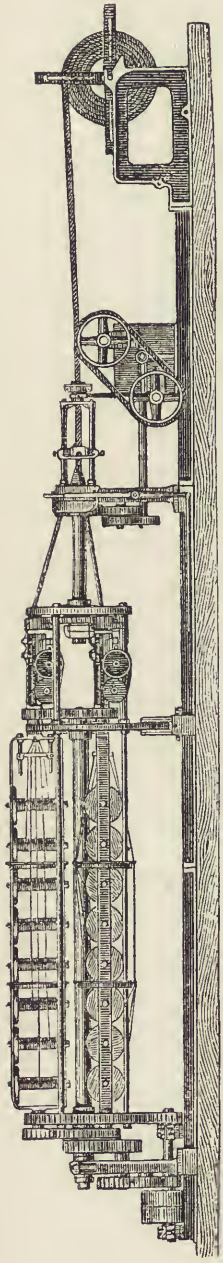

FIG. 126.—Horizontal compound hemp rope laying machine. (Made by Thomas Barraclough, London.)

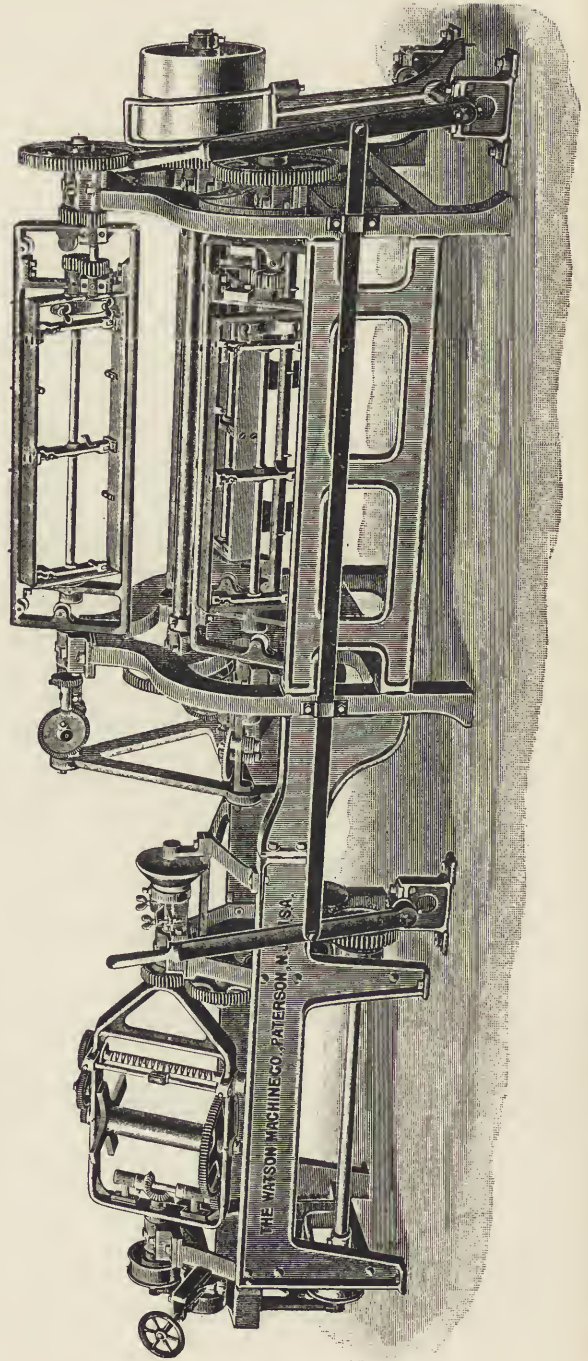

FIG. 127.—Six-thread horizontal rope machine for forming and laying rope from $\frac{3}{8}$ inch to $\frac{1}{4}$ inch in diameter.

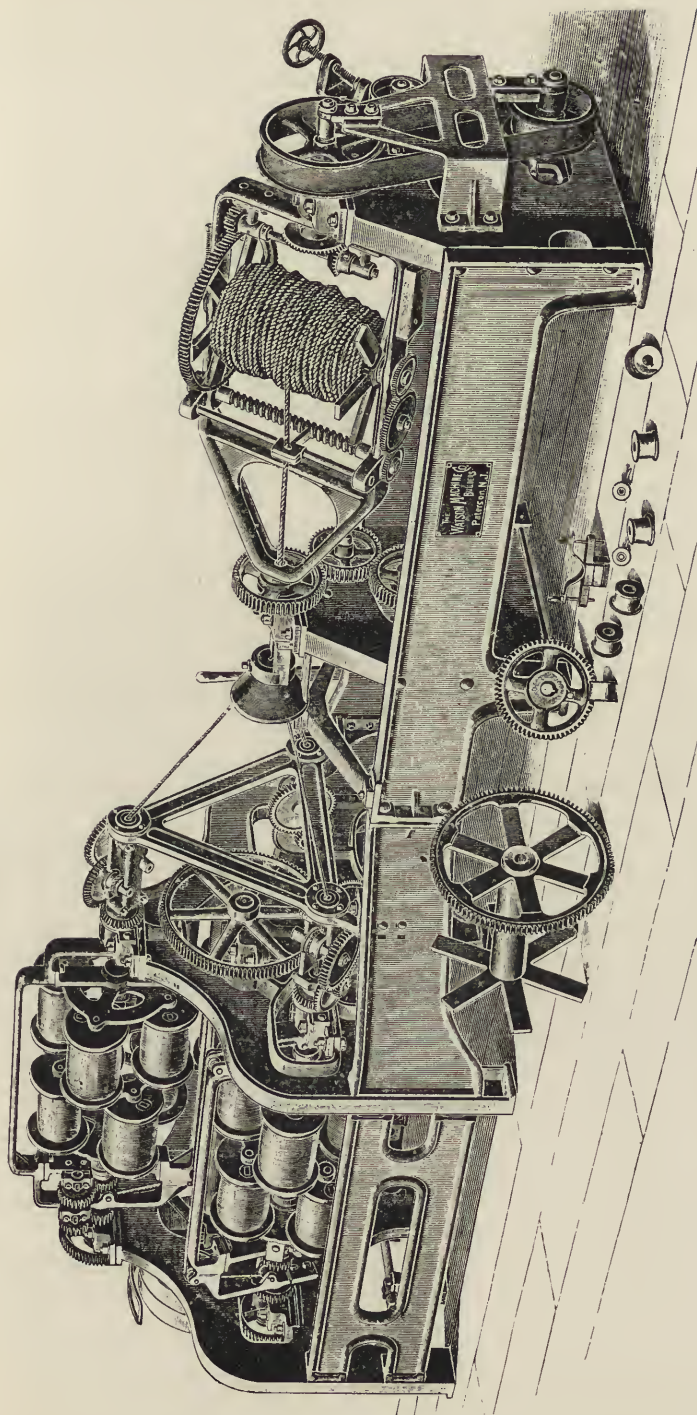

FIG. 128.—Twenty-four-thread compound rope machine to form and lay ropes in one operation.

rope reel as shown. The machine, fig. 127, is rather differently arranged. Two bobbins of yarn are placed upon the central spindle of each of the

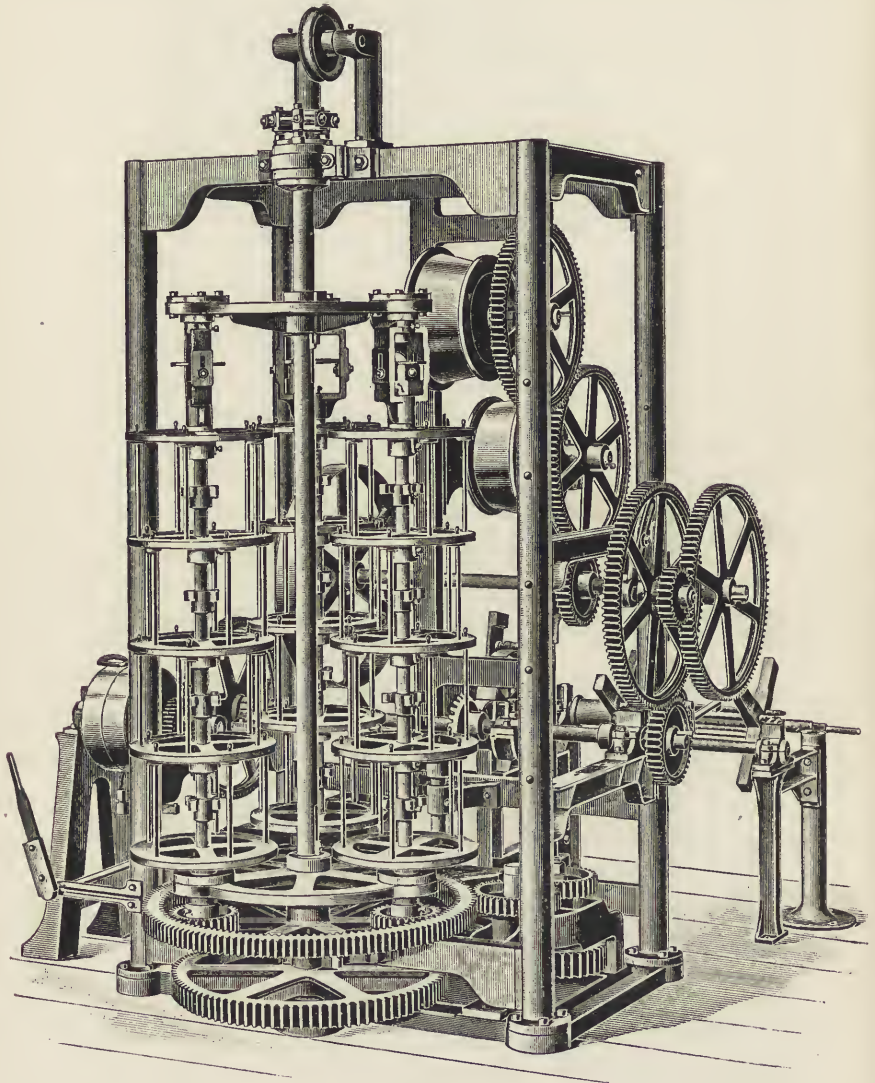

FIG. 129.—Sixty-thread vertical compound rope machine to form and lay rope from $\frac{3}{4}$ inch diameter to 1 inch diameter. (Made by The Watson Machine Co., Paterson, N.J., U.S.A.)

three flyers, which revolve in a fixed framework and merely serve to form the strands which, passing round the guide pulleys shown, are drawn forward by haul pulleys, thus ensuring that each strand is of equal length and

twist. The three strands meet in the centre of the machine where the top or cone is placed, and are laid together by the revolving take-up flyer, seen to the left of the figure, which contains the bobbin or reel for the finished rope. The rope is wound on automatically, and the bobbin is easily removed from the flyer. In the machine, fig. 128, each flyer contains eight bobbins of yarn, the ends being formed into strands which are drawn forward and laid into a rope, as in the previous machine. Fig. 129 is a vertical machine capable of forming three series of twenty threads each into strands, and laying the same into a rope, which it winds automatically upon the rope reel.

Change wheels should be provided for machines of these descriptions, by means of which the amount of twist imparted to each strand may be varied, so as to harden or soften it, also in order that the ropes may be laid with a hard or soft lay, thus enabling the machine to produce any description of rope which may be required.

Compound machines are very convenient, in that they take up very little space, require little driving power, and are very economical in the matter of wages, since one man is sufficient to attend to each machine.

Rules for Rope Makers.—The following rules and axioms may be found useful by rope makers:—

Since the basis of rope yarn numbering, as explained on page 133, is the number of threads per strand required to produce a three-strand hawser-laid rope which has a circumference of 3 inches, and since the section of the rope and the number of threads required is proportional to the square of the circumference of the rope—

To find the number of threads per strand for a three-strand rope of any diameter. Rule:—Square the circumference of the rope, multiply by the number of the yarn which it is proposed to use, and divide the product thus obtained by 9 or 3^2 .

To find the number of threads per strand for a four-strand shroud-laid rope of given diameter:—Divide the product of the square of the rope's circumference and the number of the yarn by $13\frac{1}{2}$.

To find the number of threads per strand for a three-strand cable, which, as we explained, consists of three hawser-laid ropes laid together and therefore contains nine primary strands:—Divide the product of the square of the circumference of the cable in inches and the number or size of the yarn by 36.

In a similar way the number of threads per strand for a four-strand cable is found by the following rule:—Divide the product of the circumference of the cable and the number of the yarn to be employed by 48.

As regards the lengths of the single yarns to be used in forming the strands, these, in consequence of the contraction by twist, require to be considerably longer than the length of rope to be produced. The following rules will be found useful in determining their approximate lengths.

The length of yarn to make a three-strand hawser-laid rope is found

as follows. Rule :—Multiply the length of the rope by 3 and divide by 2. To find the length of yarn to make a four-strand hawser-laid rope of given length, multiply the length of the rope by 11 and divide by 7.

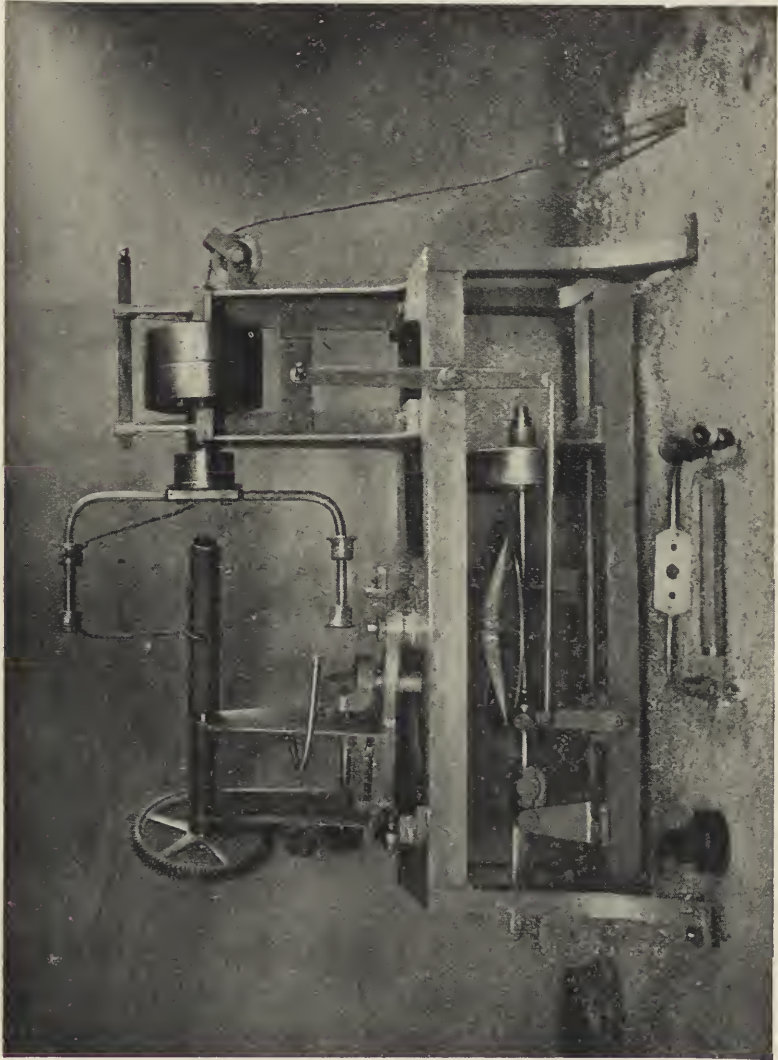

FIG. 130.—Coarse balling machine. (Made by Mr Wm. Bywater, Leeds.)

To find the length of yarns required to make a three-strand cable of given length, multiply the length of the cable by 5 and divide by 3.

To find the length of yarns to make a four-strand cable of given length, multiply the length of the cable by 7 and divide by 4.

The length of yarn required to make the core or heart for a four-strand hawser-laid rope is equal to the length of the rope multiplied by 5 and divided by 4.

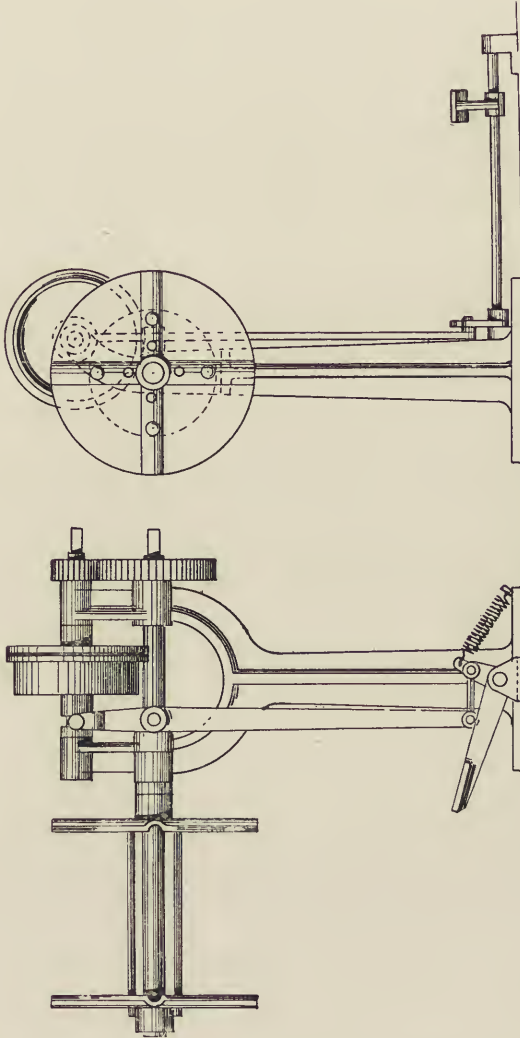

FIG. 131.—Coiling machine. (Made by Mr Wm. Bywater, Leeds.)

The length of yarn to make the heart for a four-strand *cable* is found by multiplying the length of the cable by 6 and dividing by 5.

The length of yarn to make bolt rope is equal to the length of the rope multiplied by 7 and divided by 5.

The circumference of a strand required to make a three-strand hawser-

laid rope is half that of the rope itself. For a four-strand hawser-laid rope it is equal to the circumference of the rope multiplied by 6 and divided by 15.

For a three-strand *cable* the size of the "lessom," or primary strand, is equal to the size of the cable divided by 4. The size of the lessom for a four-strand *cable* is found by multiplying the size of the cable by 2 and dividing by 9.

The length of *rope* required as a strand for a three-strand *cable* is equal to the length of the cable multiplied by 10 and divided by 9. For a four-strand cable it is equal to the length of the cable multiplied by 5 and divided by 4.

The diameter or bore of the tube employed in forming the strands for a three-strand hawser is found by dividing the size or circumference of the rope by 6. For a four-strand shroud-laid rope it is found in a similar manner by dividing the size or circumference of the rope by the number 7.

The following table gives the number of yarns per strand and the weight per fathom of various sizes of rope made from 25-thread yarn :—

Circumference of Rope in Inches.	Yarns per Strand 25-thread Yarn.	Weight per Fathom.	
		lbs.	ozs.
$\frac{3}{4}$	2 yarns per strand,	...	2
1	3 " "	...	$3\frac{1}{2}$
$1\frac{1}{4}$	5 " "	...	$5\frac{1}{2}$
$1\frac{1}{2}$	7 " "	...	$7\frac{1}{2}$
$1\frac{3}{4}$	9 " "	...	$10\frac{1}{2}$
2	11 " "	...	14
$2\frac{1}{4}$	14 " "	1	$1\frac{1}{2}$
$2\frac{1}{2}$	17 " "	1	$5\frac{1}{2}$
$2\frac{3}{4}$	21 " "	1	10
3	25 " "	1	$15\frac{3}{4}$
$3\frac{1}{2}$	34 " "	2	10
4	44 " "	3	7
$4\frac{1}{2}$	56 " "	4	$5\frac{3}{4}$
5	69 " "	5	6
$5\frac{1}{2}$	84 " "	6	8
6	100 " "	7	12
$6\frac{1}{2}$	117 " "	9	$1\frac{1}{2}$
7	136 " "	10	$8\frac{3}{4}$
$7\frac{1}{2}$	156 " "	12	$1\frac{3}{4}$
8	177 " "	13	$12\frac{1}{2}$

To find the inside diameter of the tube required in forming the *strands* for a three-strand *cable*, divide the circumference of the cable by 12. For a four-strand *cable* divide the circumference of the cable by 14. When a rope stretches, its circumference decreases inversely as the square root of relative increase in length. For instance, if 100 yards of rope having a circumference of 6 inches be stretched until it is 400 yards long, its cir-

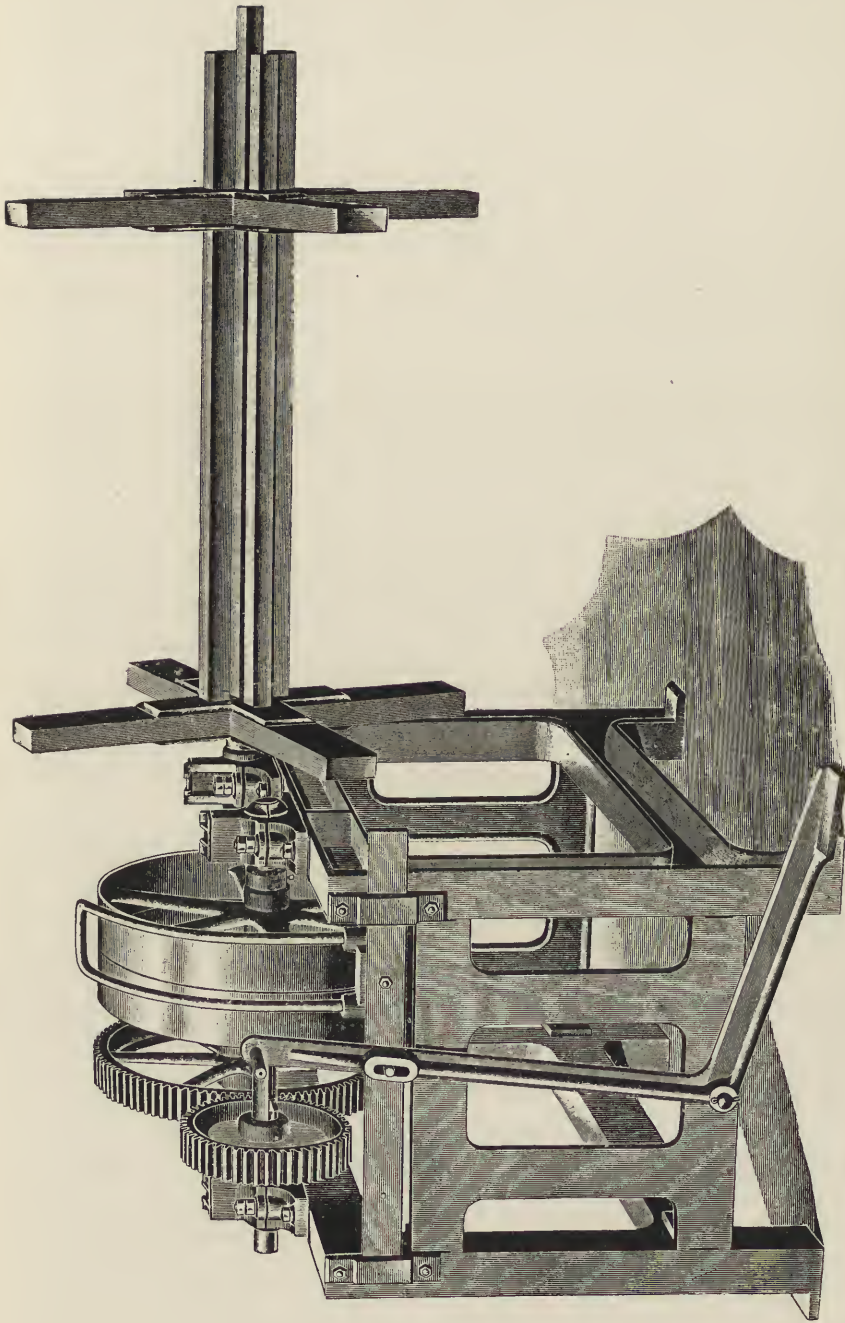

FIG. 132.—Geared rope reel. (Made by The Watson Machine Co., Paterson, U.S.A.)

circumference will then be $\frac{6}{\sqrt{4}} = 3$ inches ; or inversely, if 100 yards of 6-inch rope be stretched until its circumference is only 3 inches, its length is then $\frac{100 \times 6^2}{3^2} = 400$ yards.

Weight of Ropes.—With regard to the weight of ropes, the approximate weight in cwts. of 130 fathoms or 320 yards of three-strand cable may be found by squaring the size of the cable and dividing by 3. The approximate weight of one yard in lbs. may be found by multiplying the square of the circumference of the cable by 15, and dividing the product thus obtained by 128. The weight of shroud hawsers are to one another as the squares of their circumferences.

The weight of one fathom or two yards of 3-inch rope is approximately 31 ozs. The weight of the same length of any other sized rope may be found by squaring the circumference of the rope, multiplying by 31, and dividing the product by 9. The weight of one fathom of 6-inch rope is thus $\frac{6^2 \times 31}{9} = 124$ ozs. or 7 lbs. 12 ozs.

Balling Small Rope.—Small ropes up to $\frac{3}{4}$ -inch diameter when finished may be wound into balls up to 84 lbs. weight directly from the rope-walk or from the bobbin of a compound rope machine, fig. 128, upon a coarse balling machine, fig. 130.

Coiling Ropes.—Heavier ropes are generally coiled. The machine, fig. 131, which is power-driven by means of a friction pulley worked by a foot lever, makes coils up to 20 inches in diameter and 16 inches wide. The geared rope reel, fig. 132, is adapted to reel ropes from 1 inch to 2 inches in diameter. The ropes are now ready to be stored or sent out in fulfilment of orders.

CHAPTER XVIII.

THE MECHANICAL DEPARTMENT: REPAIRS—FLUTING—HACKLE-SETTING
—WOOD TURNING—OILS AND OILING.

The Mechanic Shop.—No mill should be without a well-equipped mechanic shop for the execution of the repairs necessary to keep the whole plant in a high state of efficiency. If the mill be sufficiently large to warrant the expense, a capable engineer should be employed, charged with the general oversight of the machinery of the whole mill—buildings, engines, boilers, shafting, dynamos, electric wiring, etc., included.

The shop itself should be under the immediate control of a foreman mechanic, who should arrange the work of the men, and see it properly carried out. In a wet spinning mill of say 20,000 fine spindles or 10,000 coarse spindles, a good mechanic, aided by a three or four years' apprentice, should be kept constantly employed in the spinning room, keeping the frames well lined up, renewing the brasses and thread plate eyes, as well as seeing that the rove guides maintain their maximum traverse—a most important point as regards the wear and tear of both the bottom brass roller and its wooden or guttapercha pressings. In a similar manner, two men will find sufficient occupation in maintaining the preparing machinery in good working condition. If the frames be at all coarse, or quickly driven, the wear and tear on the faller and slide ends is considerable, as it also is on the tappets which lift the fallers from the bottom slide. If these parts are not kept in good order, the work, both for the preparing master, hackle-setters, and mechanics, is augmented by the sticking and breaking of fallers, crushing of gills, etc. In a mill where automatic spinners are employed in spinning rope yarns, binder twine, etc., one mechanic per hundred spindles should be left in constant attendance upon these machines, setting the throats and regulating mechanism for different grists of yarn, and keeping all in good working order. Hopper feeders and combing machines likewise require a great deal of attention to get the best possible results.

The engineer should have at his command one or two skilled mechanics capable of working the machine tools, planing and shaping machines, wheel-cutting machine, boss roller fluting machine, etc., as well as of doing any

repairs necessary to the engine or mill gearing. If toothed gearing be used in the main power transmissions, they will frequently have to renew the wooden teeth in the mortice wheels, a job which, to be properly done, requires a certain amount of skill and knowledge of toothed gearing. An iron turner will also find constant employment in turning up castings of wheels and pulleys, guide pulley spindles, wet spinning frame reach screws, as well as the innumerable small brass fittings, serews, etc., always required. To his lot also falls the skimming of the preparing room front rollers, as well as of the journals of both preparing and spinning frame rollers when required, which should be never if they are of sufficient dimensions and well seated in suitable bearings. The boring out of such articles as brass bearings, spindle steps and collars, etc., also falls to the work of the lathe and iron turner, so that he will be kept well employed. The wood turner is another indispensable member of the staff. If the mill uses, cuts and turns up its own wooden spinning room pressings, he must have at least one assistant, or advanced apprentice. His chief work lies in the mounting and turning up of the wooden rollers for the preparing frames, a work rendered lighter and less costly if a large stock of really good and well-seasoned wood be kept for that purpose. One or two carpenters may be kept constantly employed upon the repairs necessary to keep the buildings and plant in order, re-cover the preparing room rubbers with flannel, etc.

A staff of five or six hackle-setters under a capable foreman will also be required to keep the gills, hackles and card clothing in order. If uninjured by crushes or other accidents, gill pins, as well as hackle and card pins, are cut by the fibre in the course of time, and must be replaced. The cards should be thoroughly examined when being cleaned, and all bent pins set and put in place, spoiled staves replaced or repaired, and the card clothing otherwise kept in perfect order. New gills and hackles must likewise be made and prepared to replace those which become past repair. To make these new gills and hackles, a drilling machine is required, provided with change gearing, ratchets, etc., so that any required number of pins per inch can be spaced off with the greatest nicety.

The Fluting Shop.—The fluting shop for the wet spinning frame pressing rollers is an important branch of the mechanical department, often placed for convenience in close proximity to the spinning room itself. If all or many wooden rollers are used, a considerable number of machines and fluters are required to keep pace with—as compared with indiarubber or guttapereha—the more frequent flutings required to make good work. A twenty or thirty-thousand spindle wet spinning mill will require six to eight single-headed fluting machines with about four attendants.

It is quite worth while to pay a fluting master to look after this important department, as a good spin depends so much upon the quality of the rollers and the wholeness of their flutes. Although the first cost is

high, the quality of the yarn is improved by using as much Persian boxwood as possible, as it is very hard and durable and takes a good smooth flute. The fluting master will be kept well employed in properly arranging the work, setting the machines, and maintaining the cutters in good working order. The latter should be sharpened twice a day and turned up once a week.

Boxwood, which is the most suitable wood for fine-spinning bosses, is of such a hard and brittle nature that its working properties are materially improved, its natural oil brought to the surface, and the wood mellowed by a steep of some weeks in water. The exact time required depends upon the quality of the wood and the temperature of the water. An active fermentation should have set in and subsided again, leaving the rollers slimy and oily, before they should be put in use.

The tool for fluting guttapercha and indiarubber bosses is stationary, while that for wood is circular and makes 600 to 800 revolutions per minute. The former cuts cleaner if a drop of water is kept constantly upon it. The diameter of the roller depends upon the pitch and number of flutes upon its periphery. Thus the diameter on the pitch line of a roller of ninety flutes, fluted to 30 per inch, is $\frac{90}{30} = 3$ inches. Its external diameter, or that by which it is gauged, is rather more than this, or the diameter of the pitch circle plus the depth of one flute.

The roller is held horizontally upon centres, moved backwards and forwards under the cutter by a crank, being shifted round at each stroke a distance equivalent to one flute by an index wheel and pawl, the latter actuated by an incline, as the carriage moves backwards and forwards. The cutter is moved upwards and downwards to suit the various diameters of rollers, by means of a screw and hand wheel. Various arrangements are used to fix the exact height of the cutter necessary to give the diameter of roller required by the index used. In one of them, an adjustable screw in the head is tightened down upon one of the steps of a graduated cam turning upon a centre directly underneath. This cam is shaped and stepped to give the diameter of rollers required for any number of flutes when the adjustable screw has been set to give one or any of them. A common way is to set the head by trial for one roller, to mark the position of the hand wheel, and to flute off a number of rollers of similar size by bringing the hand wheel round to the same point each time when lowering the cutter. An improvement upon the latter method is to so arrange the pitch of the screw which raises and lowers the head and cutter, that a half or quarter turn of the hand wheel diminishes the diameter of the roller by an amount corresponding with a given number of flutes. Thus, if in fluting a roller to 30 flutes per inch in diameter, we wish to diminish its diameter each time by an amount corresponding to three flutes, we must lower the head

$\frac{3}{30 \times 2} = \frac{1}{20}$ inch, which may be done by using a screw of ten threads per inch and giving the hand wheel one half turn for each size of roller, or a screw of five threads per inch and a quarter turn, or other similar combination. The edge of the hand wheel should be divided off by a suitable number of nicks, into which presses an adjustable spring. The spring, besides preventing the shifting of the screw by vibration, may be set for one roller, and all the others in the range may be fluted correctly by changing the index wheel and screwing round the hand wheel one or more nicks.

The question of fluting brings us back to the mechanic shop to see the machine used for fluting the long spinning frame rollers. In principle it is much the same as the machine already described. Its movements are, of course, much slower, since the rollers to be fluted are of brass and not of wood or guttapercha. Its fluting tools are stationary, while a very long carriage is moved backward and forward by means of an endless worm turned by bevel gearing, fast and loose pulleys, and quick and slow-speed belts.

The carriage may be arranged to carry two or more lines of rollers, while the head carries a like number of cutters.

During the cutting stroke the slow-speed belt is upon the fast pulley and the quick-speed belt upon the central loose pulley. As the carriage nears the end of its run, it shifts a lever which changes the belt—the slow-speed on to the loose pulley and the quick-speed on to the fast pulley, in order that as little time as possible may be lost in the return or non-effective stroke. The rollers are turned round a distance corresponding with one flute, before each cutting stroke, in a similar manner as in the small fluting machine. The fast and slow-speed belts should be crossed and open, or *vice versa*, to run the carriage backward and forward.

Scoring Rollers.—Analogous with fluting is the scoring of the calender rollers of a card, the drawing-off rollers of a breaker card, the front roller of a hemp drawing or roving frame, the bosses on a dry spinning frame drawing roller, or the ending rollers of an Erskine ender.

The latter are usually scored in a helical fashion, the roller being turned round to the required extent during the cutting stroke by means of a triangular slide.

Maintenance of Machinery.—Wet spinning frame boss or drawing rollers, if they receive proper treatment, should only require refluting once every six or seven years. If the rove traverse be too short, the bosses scored by the spinner's picker, or the flutes worn down by hard indiarubber pressing, etc., they must be refluted more frequently, decreasing the value of the frame each time. The parts which require the greatest amount of attention and repairs are the boss roller bearings and the spindle steps and collars. The great pressure which the former have to carry, and the high surface

speed, as compared with the top roller, of the journals which work in them, cause them to wear down quickly, increasing the projection or the distance back of the face of the drawing roller from the line of the spindle, and, consequently, the bearing upon the thread plate eye and the strain upon the yarn. Once every year at least, then, should the boss roller bearings be lined up and replaced by new brasses as soon as they get too thin. As long as sufficient body of metal remains, it is sufficient to "pack" them outwards by putting pieces of tin or sheet iron underneath or behind them in their seats. The mechanics who have charge of this work should be provided with a template, or short piece of roller, with one or two bosses of the proper size upon it. With the aid of this template they set the two end bearings at either side at the proper distance back from the spindle line, and then stretching a fine whipcord line tightly across from one end to the other in the centre of the brasses, and another cord on their bottom lips, they insert the remaining brasses and "pack" them out to this line. The greatest care should be taken that these brasses are tightly driven into their seats, for if they be not, they will retreat when the pressure goes on, and be worthless as a firm and stable bearing. The top roller brasses require to be replaced much less frequently, but should be re-lined up at the same time as those of the bottom roller. A change in the angle made by a line passing over the faces of the top and bottom rollers makes a great difference in the distribution of the pressure upon the rollers and the portion of the pressure applied, which is lost or rendered ineffective as an upward or downward thrust upon the stand that carries the saddle.

When the rove is suddenly broken off short in the reach, too large an angle frequently causes it to lap upon the top roller instead of continuing to fall downwards, as it should do until again caught by the drawing rollers.

Excessive wear in the spindle bearings, of both dry and wet frames, is as detrimental to a good spin as is a boss roller which is too far back or out of line. It causes the spindle to bounce and vibrate to such an extent as to render it impossible to spin a fine or weak yarn. If either the spindle neck or collar is too much worn, the latter must be replaced by a new one bored out an exact fit for the existing spindle neck, or the spindle must be changed for one having a neck of large diameter. Which of these courses will be found cheapest and most expedient depends upon the state of wear of the other parts of the spindle, notably the blade and top. If these parts be much worn, it is advisable to renew the spindle and save the collars; if the spindle is good, preserve it and renew the collars. End play in the spindle, producing bouncing, and caused by wear in the spindle step or bottom of neck collar, may be cured by inserting a thin zinc washer between the step rail and the rim of the brass step. The collar upon the spindle between its butt and neck is thus brought into contact with the brass neck

collar, effectually preventing bouncing of the spindle. The brass neck collars are secured in the neck rail by means of screws, which must be kept tight. The neck rail is apt to become bowed and out of line through being frequently struck by the hanging and swinging drag weights.

This constant striking causes an extension in the side struck, so that the rail is bowed outwards and must be straightened by blows upon the other side.

To maintain a good spin and perfectly formed bobbins, the builders and builder motion must be kept in good repair. Owing to the weight of the drags upon the front of the builder plates the holes in the latter, into which fit the conical ends of the poker rods, are apt to wear, allowing the builders to tilt forward, perhaps to such an extent that they touch and wear the spindle blade, or in any case form an imperfect bearing for the bobbins. The builder plates also wear around the spindle holes, where the bases of the bobbins rest upon them, and should be replaned periodically, especially if a change in the form or dimensions of the bobbin base be contemplated.

The thread plate eyes, too, cut more or less quickly, according to the nature of the yarn which has been spun through them.

A warp yarn, spun, as it should be, under a heavy drag and high tension, will naturally cut the eye more quickly than will a weft yarn spun under a low tension.

The thread plate eyes are short lengths of brass rod, set and riveted in the cast iron thread plate, immediately over the top of the spindle. The eyehole is bored through the centre of the brass and communicates with the outside of the plate by a slot, through which the end is passed. When this eyelet, as we have said, becomes cut, the eye must be knocked out and a fresh one put in. It is convenient to cast the brass eyes in round bars and to cut them off with a saw in lengths slightly greater than the thickness of the thread plate. The brass trough lip and the brass rove guides in the trough and creel will also wear and cut in time, in consequence of the passage of the rove over them, and must be shifted and replaced periodically. When new collars and steps are made for a frame they should be left tight, in order that they may be rimed out an exact fit after insertion in the bars.

Turning again to preparing machinery, the chief wear and tear is found in those parts which run at the highest speeds and do the most work. In the drawing frames it is the slides, screws and cams which require most attention; while in the roving frame we have in addition to keep the parts of the differential winding motion, the studs of the twist gearing, and the spindle bearings in good order. As regards the faller slides, it is the back and front end of the top and the front end of the bottom slide which wear the most. The top slide wears short in consequence of the

passage of the faller up and down at the back and front respectively. The bottom slide is grooved at the front where the faller touches it as it falls from the top slide. When the top slide becomes too short, there is an excess of play room for the faller in rising and falling, for which reason it frequently turns and jams. This slide can often be sufficiently lengthened by heating the ends and striking the under sides in such a way that a hollow is formed and the length of the slide considerably increased, its thickness being maintained. The cam upon the bottom screw, which lifts the faller on to the top slide, is the one which wears most. Like the other cams, it should be of the best tempered steel and specially case-hardened. To facilitate their being changed, these cams have usually a tailpiece which, passing through a slot in the end of the screw, enables them to be keyed to the latter. They must be carefully shaped to pass between the threads of their corresponding screws. It occasionally happens that a piece of the square screw thread is broken out. When this occurs it is best to dovetail and braze in another piece of steel, shaping it so as to render the thread true and continuous.

The "turning up" or sliding of the drawing frame and roving frame front rollers is a work for the iron turner, a work rendered necessary by the wear occasioned by the friction of the outside edges of the wooden pressing rollers upon it. As we believe that the reason for this occurrence is not generally understood, we will explain it. The boss or front roller revolves with a given angular velocity or surface speed. The outside surface speed of the sliver which passes over it is greater in consequence of the radius of the roller being increased by the thickness of the sliver. The surface speed of the sliver is imparted to the wooden pressing roller which rides upon it, consequently the wooden roller has a higher surface speed than the metal boss roller, a result which is intensified with regard to the edges of the wooden roller when the latter becomes indented over that part of its face which covers the sliver. This grooving of the boss roller is prevented, or at any rate diminished, by the traversing motion shown in fig. 40, which is now generally applied to all frames except the spread-board. When this motion is applied the journals are made extra long, and the roller given a very slow longitudinal reciprocating motion by means of a combination of lever, eccentric, worm, and worm wheel and ratchet and pawl, actuated, in the case of the drawing frame, by a crank and connecting rod, and often, in the case of the roving frame, by the up-and-down motion of the builder. Needless to say, this motion is equally advantageous for increasing the life of the journals upon which the roller turns. The brasses or bearings of the front roller wear down in time and must be packed up or replaced, else the top surface of the roller will become too low, and the fibres in being drafted, touch and cut the brass gill stocks.

“White metal” bearings give very good results in preparing machinery, although their use for wet spinning is not to be advocated. Brasses may be repaired with white metal by placing them between end pieces prepared to receive, at the proper height, a template journal or core which, being placed in position, enables the molten metal to be poured in and a serviceable bearing formed.

The back retaining or feed rollers are apt to wear outwards in consequence of the weight and thrust of the “jockey” roller upon them. When this occurs with that roller which is towards the front of the frame, it is apt to make it come in contact with the gills as the faller rises, if the nip be very short. If there be but one delivery per head on a drawing frame, or when, under certain circumstances, the bosses upon the delivery roller are not symmetrically placed with regard to the bearings of that roller, the latter wears down to that side upon which is the boss, in consequence of the weight of the calender roller upon it. There should be no wear upon the supports or U^s of the pressing rollers if brass or cast iron washers are always used upon the ends of the roller axles. They may be occasionally broken, however, by laps which, when “licking up” is prevalent, are apt to gather upon the end of the roller axle. If the support of one of the calender rollers is broken it should be replaced by another, or patched in such a way that its exact length is preserved, for, if the supports on either side be of unequal length, the calender roller will ride askew upon its boss and a drawn, unsightly and imperfect sliver be produced.

The remarks made in connection with the spinning frame spindles apply equally to those of the roving frame and twisting frame, although the same nicety of adjustment is not absolutely essential. An unbalanced flyer, or one with an arm broken, should never be allowed to continue in use, as the throw occasioned wears out the collar and at once causes the spindle to wobble.

The pins in the roving frame flyer heads will have to be renewed from time to time, as may also those in the bobbin carriers. The studs carrying intermediates, or double wheels, in frames of every description, must be kept thoroughly oiled, else constant repairs will be rendered necessary.

Lubrication.—Good lubrication in a mill is of paramount importance in saving of coal and cost of repairs. It has as its object the reduction of friction between two parts of a machine which must necessarily rub one over the other. These parts are sometimes flat surfaces, as in the case of the cross head of a horizontal steam engine, slipping along in its guides or slides, but more often they are a journal or cylindrical body and a hollowed-out bearing.

All metals are of more or less granular or crystalline structure, and when viewed under the microscope appear porous. Even when smooth to

the naked eye, they are not really smooth, but only comparatively so, so that when moved one over the other their surfaces interlock more or less, causing friction or resistance to motion.

Friction is reduced and perhaps sometimes almost eliminated by lubrication, or, in other words, by the insertion of a thin film of oil, etc., between the rubbing surfaces. The quality of the oil required depends chiefly upon the pressure which exists between the surfaces to be lubricated.

If a heavy journal be oiled with a light mineral oil, for instance, the lubricant will be squeezed out by the pressure exerted upon it, and will not be allowed to remain and form the oil layer required to keep the surfaces apart.

For such a journal—the crank-shaft bearing, for instance—an oil of considerable body or consistency is required. For a light bearing, on the other hand—such, for instance, as the neck and collar of a fine spinning spindle—a light oil, but one of really good lubricating power, such as Arctic sperm, is required. If a heavy oil were used for this purpose, although keeping the surfaces apart, it would retard the speed of a light and quick-running spindle and make the frame heavy to drive.

The cheapest form of lubricant is oil of mineral origin, sometimes called Oleonapthe I., II., etc. This oil, produced chiefly in the distillation of the illuminating oils, is lacking in body, but is of high specific gravity. Alone, these oils are rather poor lubricants, but are useful when mixed with vegetable and animal oils of low gravity. A mixture composed of three parts of best mineral or Oleonapthe II., and one part sperm or lard oil, for instance, forms a good and cheap ordinary spindle and light machinery oil. For fine work, however, it is best to employ the best sperm oil only. Pure mineral oil is not a good lubricant for wet spinning, as water will not combine with it. It is not retained between the spindle neck and collar, but is washed out or runs down the spindle butt.

Water will combine with a vegetable oil, forming a greasy emulsion. For this reason, rape or colza oil is much used in the spinning room in a pure state, to grease the spindle blades; or, mixed with mineral oil, to lubricate the spindle.

It is difficult to make a proper mixture of vegetable and mineral oil without raising the temperature of both, as they will not combine when cold. It is dangerous to use any oil that has a low flash-point—that is to say, one which gives off an inflammable vapour at a comparatively low temperature, say 150° F. Such an oil, if used on a heated journal, may cause a fire, especially if a light be brought near it and into contact with the inflammable vapour given off.

Although a heated journal should be unknown in a well-regulated mill, if such should occur, it should be cooled down by a copious supply of soapy water. Indeed with some badly-designed or overloaded engines it has been

found necessary to supply the crank-shaft bearings or those of the first motion shaft with a tank and supply pipe for soapy water, or with a supply of cold water which may have to be kept running all day. A cooling mixture which has been recommended for hot journals is formed by boiling together 4 lbs. of palm oil, 4 lbs. of tallow, 2 lbs. of salt, 2 lbs. of sulphur, 2 lbs. of blacklead, $\frac{1}{2}$ lb. saltpetre, and $\frac{1}{2}$ lb. of antimony, to which, after straining, should be added $\frac{1}{4}$ lb. of hartshorn and $\frac{1}{4}$ lb. of soap linament. Blacklead is often a useful substitute for a liquid lubricant where the presence of black oil is a disadvantage.

Mixed with tallow for guide pulley greases it is again useful, and in the form of the Belleville packing is one of the best materials the author has met with for the stuffing-box of the Corliss valve spindle.

Blacklead does not lubricate as does an oil, but rather fills up the pores in the rubbing surfaces, and forms a fine skin which facilitates the motion of the parts the one over the other.

The various greases supplied for lubricating purposes are economical, if properly applied, from the fact that they only run when required, or when the bearing, becoming hot, melts them. For this reason, tallow or mica grease may be advantageously used as a reserve in the oil-boxes of cards, or in the covers of preparing frame front roller bearings. In the former case the hard grease should rise above the oil holes which are left uncovered by grease, in order that a little oil may be given before the morning start. If the journal tends to heat during the course of the day, the grease melts, and supplies the oil required. In a similar manner, the grease contained in the boss roller journal covers remains solid until oil is required, when it furnishes the requisite supply.

Grease is almost universally employed in lubricating fans. If a Stauffer or similar lubricator be used on the end of a pipe communicating with the oil hole in the bearing, the fan, even when set in a window or outside wall, may be effectively lubricated from the interior of the building without the trouble and risk of getting to the outside. Grease lubricators should be on the "tell-tale" principle, that is to say, with a piston and spring for pushing on the grease, and a projecting knob, which shows how much grease remains in the lubricator. The greases most in use are the Stauffer, Kingfisher, Mica, and the various petroleum products.

One of the most important oils, both as regards quantity and quality, required in an establishment, is that for lubricating the inside surface of the steam cylinders. For this purpose an oil is required which remains undecomposed under the combined action of heat and pressure. The best cylinder oils are of mineral origin, are often of a dark colour, and, what is essential in this class of lubricant, have a very high flash and igniting point, 500° F. and 550° F. respectively.

All oils, especially those of a dark colour, should be well filtered

previous to use, in order to remove sand or other foreign substances which would cut up and spoil the bearing. An oil should be able to stand cold as well as heat without solidifying, for upon a cold frosty morning the load upon the engine is often considerably increased, for the reason that the oil in many of the bearings has become more viscid, if not actually congealed.

Oil Testing.—It is important that the manager or engineer of a mill should, from time to time, test the oils with which he is being supplied, to ascertain if they are quite suitable for the work, that they are unadulterated, and that the quality is being kept up. There is so much trickery carried on in the oil trade, that it is advisable to deal only with houses of standing, who have a reputation to keep up. The tests usually applied have as their object to ascertain the specific gravity, the body or fluidity, the flash-point, and the presence of acids in the oil.

Specific gravity is the weight of a given volume of oil compared with that of the same volume of water. The weight of a cubic foot of water is 1000 ozs., so that the weight in ounces of a cubic foot of oil actually represents its specific gravity in degrees. In practice, it is more usual and convenient to employ an instrument called a hydrometer in ascertaining the specific gravity of liquids. This instrument consists of a long glass stem, hermetically sealed, and terminating in a bulb loaded with quicksilver, etc. When plunged in a liquid, it stands and floats upright, its centre of gravity being very low down. The stem is graduated. The point to which the surface of the liquid, when the latter is water, reaches, may be marked 1000, and the other divisions marked off by trial in liquids of known specific gravity.

Specific gravities should be taken at the standard temperature of 60° F., or 15° C., for 5° F. makes a difference of 2° in the gravity of the oil. The following list shows the specific gravity of the more usual mill oils:—Water = 1; rape seed oil or colza = .914; olive oil = .914; raw linseed oil = .929; castor oil = .966; Arctic sperm = .881; tallow = .913; neatsfoot oil = .914; lard oil = .917; sperm or whale oil = .925; mineral = .886; Oleonapthe I. = .920; Oleonapthe II. = .900. An oil of high specific gravity does not of necessity possess much body. The body or fluidity of the oil is most easily tested by means of a pipette or graduated glass tube, provided with a small hole at one end and open at the other.

Comparative tests may then be made by drawing up a given quantity of oil into the tube, and watching the time it takes to empty itself drop by drop. Distilled water may again be used as a standard.

The flash-point of an oil may be determined by heating a small quantity in an open vessel in a spot protected from draughts, which would dispel the vapours given off. From time to time a lighted match should be passed over the mouth of the vessel. When the vapour catches fire, the temperature of the oil or the flash-point is noted. To test for the acids

which are sometimes present in oils which have been chemically refined or which have been developed by fermentation in vegetable or animal oils, a very good way is to put a sample in a glass bottle with a clean copper wire running air-tight through the cork. Place the bottle in a sunny window for a few weeks, and watch for the appearance of verdigris on the copper. If such appears, there are traces of acid in the oil which will act injuriously on the bearings of any machine to which it is applied.

Self-oiling Pedestals and Bearings.—Shafting turns in pedestals, supported in wall boxes, or upon beams, brackets or hangers. The old-fashioned pedestal has ordinary solid brass bearings, generally grooved to retain the oil, which is supplied by an oil bottle and needle lubricator fixed in the cap. Of late years oil bottles have been replaced in many instances by tell-tale lubricators for Kingfisher, mica or other grease. Several forms of self-oiling pedestals are in extensive use. One form has an oil reservoir underneath the brass, into which dip one or more endless chains, or wire or metal rings, which lie upon the upper surface of the shaft, and are there caused to revolve and carry up the oil with them. The oil as it runs from the end of the bearing is caught in an oil dish at each end and returned to the oil reservoir to be used over again. These pedestals work well if the dirty oil be drawn off periodically from the bottom of the reservoir; if this be not attended to, the chains will stick and become useless.

For heavy first or second motion shaft bearings, Mohler's patent self-lubricating bearing is the best the author has seen. The shaft has a cast iron collar fast upon it in the centre of the bearing, which collar works in corresponding grooves in top and bottom brasses. The bottom groove communicates with an oil reservoir under the bearing, so that the revolving collar carries up a good deal of oil with it. The upper part of the groove in the top brass is open, and has in it a scraper which scrapes off the oil carried up by the collar and spreads it over the surface of the journal.

Lubricators.—Lubricators for use upon the steam engine are usually of the adjustable needle type, by means of which any given number of drops per minute may be allowed to fall upon the bearing. There are also ingeniously devised lubricators by means of which measured quantities of oil are pumped into the cylinder against steam pressure, and the crank-shaft bearings, crank pins, etc., kept constantly lubricated with oil which circulates round and round, and is filtered and used over and over again. The waste oil which accumulates in the zinc trays placed underneath the cranks, etc., should be carefully filtered and used for unimportant bearings.

Indicator Trials.—Trials may be made as to the relative values of the different oils for the engine and shafting, spinning room, etc., by the use of the steam engine indicator noticed in Chapter XX.

CHAPTER XIX.

MODERN MILL CONSTRUCTION: HEATING, LIGHTING, VENTILATION AND HUMIDIFICATION.

Site for Mills.—In choosing the site for a mill some of the principal considerations are:—A good supply of hands (trained if possible); an unfailing and sufficient supply of water for condensing and other purposes (if the same can be used as a source of power, so much the better), proximity to a railway, canal or river, in order that coals, fibre and yarn may be delivered as cheaply as possible; and lastly, the vicinity of a ready market for the finished products.

For the spinning of fine yarns some climates and local meteorological conditions are more favourable than others. Ireland and Belgium, for instance, have become seats of the linen trade, which remains and flourishes there, while other countries, such as the United States of America, although taking the lead in other branches of industry, must own, after frequent attempts, that their country and climate are not suitable for the spinning of linen yarns, especially in the finer counts. It has long been recognised as a fact that the state of the atmosphere as regards moisture has a great effect upon the ease with which the spinning of vegetable fibres can be accomplished. Those countries and districts in which the rainfall is frequent and considerable, or which have large areas covered with water, which is constantly being evaporated and absorbed by the surrounding atmosphere, are found to be most suited to the spinning of such fibres.

As regards the buildings themselves, if they are to be well-built sheds or many-storeyed mills, a solid and dry foundation should be sought for. If the soil be clayey, a concrete foundation made with hydraulic lime should be provided, to avoid damp walls.

Mill Buildings.—A hand rope walk is the simplest form of building, being frequently little more than a long narrow shed of wood with a tarred felt roof. In length it should not be less than 900 feet, so that ropes of a minimum length of 120 fathoms may be produced.

Main mill buildings should, if possible, stand due north and south, in order that advantage may be taken of the first and last rays of daylight, and the lighting bill thereby reduced. The most favoured form of main

building for flax, fine hemp, jute and ramie spinning is a rectangle, usually of five storeys, from 150 feet to 200 feet in length and 45 feet to 50 feet in breadth.

On the Continent mills often exceed the latter dimensions as regards width, as longer frames are often employed, because, as is said, spinners wearing wooden shoes cannot turn easily and without danger, and consequently mind only one long side. For wet spinning the bays should be 9 feet wide, which, with piers of 3 feet 8 inches in breadth, gives a window 5 feet 4 inches in width between each pair of spinning frames. For dry spinning the frames are wider, as should also be the bays in which they stand.

The placing of the windows between the frames is an important point as regards light. The height of the rooms on the ground, first, second and third floors is from 12 to 13 feet. The top storey is usually lower, say 8 feet. The height of the windows is from 9 feet 6 inches to 10 feet 6 inches. According to the usual construction the floors are fireproof and supported by cast iron girder beams, and by rows of cast iron columns 8 inches to 10 inches in diameter, according to the storey. Wide mills of old construction have generally two rows of such columns, which are most inconvenient, in that the frames must be placed opposite the windows or else the columns pass through the centre of the frames. Old mills which are not too wide, and new mills in which proportionately heavy girder beams are used, have but one row of columns placed out of the centre and to one side of the centre spinning room pass.

Bricks and mortar of good quality must be employed, and the piers should be of sufficient section to bear the weight of the storeys above filled with heavy machinery.

The roof is often made flat with a parapet forming a reservoir of water for the spinning room, and, in the case of country mills, giving a supply of water under pressure in case of fire. The pressure in pounds per square inch of the water taken at any point is the product of the difference in level in feet and the decimal fraction 0·4. Thus if the level of the water in the reservoir be 50 feet above the ground, the greatest pressure of water obtainable from it will be $50 \times 0\cdot4 = 20$ lbs. per square inch, or about 1·3 atmospheres.

Heating and Ventilation.—New mills should be designed with a view to their proper heating and ventilation. As regards the general ventilation of a flax, hemp or jute mill, the dust generated in the hackling, carding and preparing departments is of such a character and volume as to require special means of removing it. These rooms are therefore generally treated separately in various ways, which we will presently describe. The wet spinning room, and the reeling room if ventilated at all, may be kept in a healthy state by the use of fans of the Blackman type set in the wall and

extracting the damp and vitiated air from the room, the balance of pressure being maintained by the entry of air through the doors and other apertures. This is termed the vacuum method of ventilation, and presents the inconvenience that the air which replaces that which is removed may and *does* find its way in anywhere, it may be even from drains or closets. The plenum method of ventilation is rather to be recommended, in that the fresh air is introduced from outside and is therefore pure, the vitiated air being expelled by the excess of pressure inside the room. Such an installation is that made by the Sturtevant Engineering Co., the usual arrangement being as depicted in fig. 133, in which it will be seen that a large fan or blower is located in the basement, draws in the outside air, and, passing it through or over

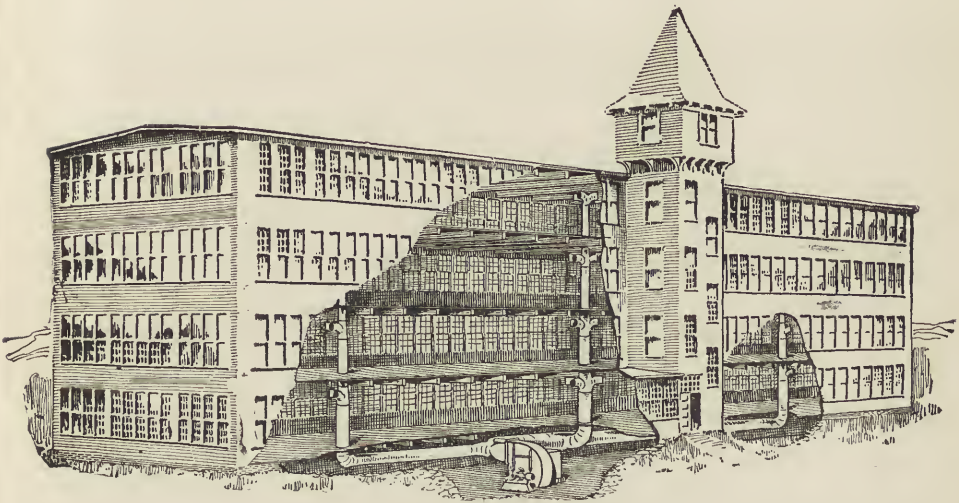

FIG. 133.—Sturtevant system of ventilation.

steam pipes in coils and a spray of steam or cold water placed in the main duct when required, distributes it about the building through ducts built into the walls or through metal pipes provided for the purpose. In a modified form this system is used upon the Continent to keep hackling shops and preparing rooms free of dust. To do so it is merely necessary to connect up the inlet of air to the fan with a large duct the ramifications of which extend under the floors of the rooms to be cleared, with which they communicate by openings of section proportional to their distance from the fan. These openings may be situated immediately underneath the machines which produce the dust, such as the hackling machine and drawing frame, and thus catch the dust as produced, the downward current of air preventing it from rising and polluting the atmosphere of the room. A water spray is placed on the inlet side of the fan, and effectually washes

and purifies the air before it is returned into the room. The dust falls, and is washed away by the waste water from the spray. A plenum is still maintained in the room, for the fan always drives in more air than it extracts, on account of the fresh air which it cannot be prevented from taking in through the water gutter, etc.

Thus a new mill may be designed with a view to a system of heating and ventilation such as we have described. Air ducts for both inlet and outlet may be built into the walls, underground ducts may be dug out and cemented for the ground floor rooms, while the upstairs rooms may have double ceilings or floors giving space for the requisite horizontal branches of the vertical air ducts. The ducts admitting air should be in the ceiling, thus avoiding draughts and preventing the rise of dust.

Roofs.—Substantially built sheds for ropeworks, etc., may be composed of bays about 18 feet wide and 12 to 13 feet high to the gutter. The roof should be of the saw-tooth pattern, the least sloping side being glazed. It is usually supported by beams, say 12 inches by 8 inches, and cast iron columns 6 inches in diameter and about 10 feet pitch. If a shed be humidified, it is generally necessary to make the roof double, and to fill it with cork or other non-conductor, in order to prevent excessive condensation at night when the temperature falls. This roof will also keep the shop cooler in hot weather. The Continental type of double-tiled roof lends itself particularly well to this operation.

Chimneys.—The building of the mill chimney must be carefully watched in order that it may remain perfectly straight and withstand the effects of the weather. A good foundation of concrete should first be provided, its dimensions depending upon the height and weight of the chimney, and the nature of the soil. Building should not proceed too quickly, in order that the mortar may dry before too much weight comes upon it. This is an important point, as, if the weather be wet, the mortar on that side which is most exposed to the rain, remains soft, and a bent chimney is the result. There is not nearly so much danger of this occurring if hydraulic lime be used in the mortar.

The bricks intended to form the corners of square and polygonal chimneys should be rather thicker than the rest, so that the jointing will be of necessity closer and stand the effects of the weather to which the corners are particularly exposed. A lightning conductor should always be provided, and be placed on the side of the chimney which is most exposed to rain. It should be composed of one or more points connected by a copper tape with a large copper plate buried in the ground at the base of the chimney.

Heating and Lighting.—If the heating of the mill be quite independent of its ventilation, it is best accomplished by means of high pressure steam, which will be found to be the most economical, if the piping be arranged to

form a circuit and to return the water of condensation under the check valve into the boiler.

Electric lighting has almost entirely superseded gas for mill lighting. However, there are still some mills making their own gas. Coal gas, oil gas, and water gas enriched with oil, are all employed for mill-lighting purposes. Nos. 6 and 7 burners are those usually employed, the former giving about 14, and the latter 16-candle power light with good gas. The standard of candle power is the amount of light produced by a standard candle weighing 6 per lb. and burning 120 grains of spermaceti wax per hour.

The electric current used to produce light for the mill with the aid of arc and incandescent lamps is usually generated by a dynamo driven by ropes or a belt from the shafting or mill engine. The size or capacity of a dynamo is usually expressed in watts, and is the product of the ampères of current it can furnish and the voltage or pressure of that current. An ohm is the unit of electrical resistance. A copper wire $\frac{1}{4}$ inch in diameter and a mile long offers a resistance of one ohm to the passage of the current. When a wire of an ohm resistance has its two ends kept at a difference of potential of one volt, there is a current of unit strength called an ampère in the wire. A volt is the electromotive force which in a circuit of one ohm resistance produces a current of one ampère. The electro-motive force in volts of current equals the current in ampères multiplied by the resistance in ohms, therefore the volts lost in a circuit equal the product of the ampères and ohms. To find the resistance of a cable 19/12 in a circuit 400 yards long, it being known that the resistance of a mile of 19/12 cable is .2709 ohms, we find by proportion that the resistance of $400 \times 2 = 800$ yards, is .117 ohms. If a current of 40 ampères be sent through the wire, by the time the current has reached the end of the 400 yards it has lost $40 \times .117 = 4.68$ volts.

Each candle power of light produced absorbs about 3.5 watts. When current is purchased from an electrical supply company it is measured in Board of Trade units, each of which is equivalent to 1 kilowatt hour. A kilowatt equals 1000 watts.

Dynamos are made with two, four, or more poles, and have a corresponding number of rows of brushes, which rest upon the collector and take off the current as produced. Carbon brushes upon a copper collector give the least trouble and spark the least.

Lamps are of two kinds—arc and incandescent or glow lamps. In the former, which take less force for a given candle power produced, the light is produced by the heating to incandescence of the ends of carbon pencils by reason of the heat engendered by the resistance experienced by the current in passing between their points, which are separated by a fraction of an inch. In the glow lamp, a fine filament of carbon, which offers a great resistance to

the passage of the current, is heated to incandescence in a hermetically sealed glass bulb in which a vacuum has been established. Were air present in the bulb the carbon filament would burn away immediately. If the dynamo is overloaded it is advisable to use glow lamps of low wattage, although they will not last long, especially if subject to vibration. Arc lamps are usually connected up in series of three lamps, and do very well for large works such as ropeworks, etc. The inverted type which throw the light upwards—upon a white ceiling, for instance, which reflects it downwards—are to be preferred, when possible, owing to the absence of shadows. For fine spinning rooms the incandescent lamp is to be preferred, two or three being placed in each spinner's stand at a height of about four feet above the floor level. There are four ways of connecting up electric lamps :

In series—that is, in single file. Arc lamps are generally connected in this way, so that the potential or voltage between the ends of the series must be the voltage required by one lamp multiplied by the number of lamps in the circuit. The current remains the same for any number of lamps.

In single parallel—that is, like a ladder; one lamp is in each step and the two sides form the main conductors. Glow lamps are generally connected up in this way, so that the potential or voltage between the conductors remains constant. The current varies according to the number of lamps.

In series parallel—that is, when more than one lamp is placed in each step of the ladder.

The three-wire system consists in the use of three parallel main wires, the centre one being the return wire, thus forming a sort of double parallel.

The theory of electricity is not difficult if it be borne in mind that the same laws which govern the flow of water may be applied to the electric current. If water circulate in pipes there is a loss of pressure due to friction, just as with electricity there is a loss of voltage when the current is sent through a conductor. The electric current, in forming a short circuit, takes the line of least resistance, just as water would do under like circumstances, and so on.

Air Supply.—Returning again to the question of ventilation and humidity. The Factory Act of 1889 provides that every apartment of a factory where artificial humidity is produced must be provided with means for the admission of at least 600 cubic feet of fresh air per hour for each person employed therein.

Again, under the Special Rules which the Secretary of State was authorised to make, by the Factory Act of 1891, for the spinning of flax, it was specified that in roughing and sorting shops, exhaust fans were to be provided so as to draw the dust forward and down from the face of the

worker. Under the same rules the carding and preparing rooms had also to be provided with fans.

In the Factory Act of 1895 it is enacted that 250 cubic feet of air space shall be provided for each person employed. This rule, taken in conjunction with a supply of 600 cubic feet of fresh air per head and per hour, means, that if the space is just legally sufficient for the number of hands employed, the air must be changed rather more than twice per hour.

In most modern mills the amount of air space per hand is well over the minimum, so that in many cases a complete renovation of the whole atmosphere *once* per hour is ample. In order that one may form an opinion as to the number of fans necessary to fulfil these conditions in any sized apartment, some idea must be gained as to the number of cubic feet of air which fans of various diameters and speeds can pass per minute or per hour. Taking the well-known Blackman fan as a standard for that type, a 14-inch fan will "blow in" or exhaust approximately one cubic foot of air per revolution per minute, or running at the usual speed of 1000 to 1500 revolutions per minute, it will move on the average, say $1250 \times 60 = 75,000$ cubic feet per hour. One such fan, then, should provide $\frac{75000}{900} = 125$ persons with 600 cubic feet of fresh air per head per hour, in compliance with the Act. Larger fans run at speeds inversely as the pitch of their blades will move quantities of air approximately proportional to the area of their delivery surface.

If the average velocity of the air passed by the fan be known in feet per minute, its volume in cubic feet is the product of the former and the area of the delivery surface in square feet. The velocity of the air, of course, varies with the speed of the fans. In Blackman fans driven at the usual speed, it varies from 1000 to 2400 feet per minute. The instrument employed in finding the velocity of air currents is called an anemometer, an improved form of which, as made by the Sturtevant Engineering Co., we show in fig. 134. The action of an anemometer depends either upon the velocity imparted to a vertical spindle by the air current acting upon hemispherical vanes placed upon the end of radial arms, or on the pressure exerted by the current upon a plate directly exposed to it and measured by the compression of a spring, or on the height of a water column supported by the same pressure. As regards the latter it may be said that the height of the water column supported is directly as the square of the velocity of the air, and that an air current with a velocity of 1430 feet per minute will support a water column a quarter inch in length.

In the ordinary method of ventilation the fans are usually set in frames in the outer walls of the building, or in a part of the window frame, the spindle of the fan being horizontal and at right angles to its frame.

For the ventilation of sheds, some recommend that the fans should be

fixed with a vertical spindle, so that they will work horizontally about 8 or 10 inches below the gutter line, thus giving a horizontal and diagonal draw upon the air, removing the hot atmosphere which rises to the top of the room without causing any draught upon the workers.

Humidity of Air Supply.—The humidity of the atmosphere exercises an important influence on the ease with which the preparing and spinning operations of vegetable fibres are accomplished.

In the flax and tow preparing room, the drawers find on a cold frosty morning, or when a dry March wind is blowing, that if the slivers do not

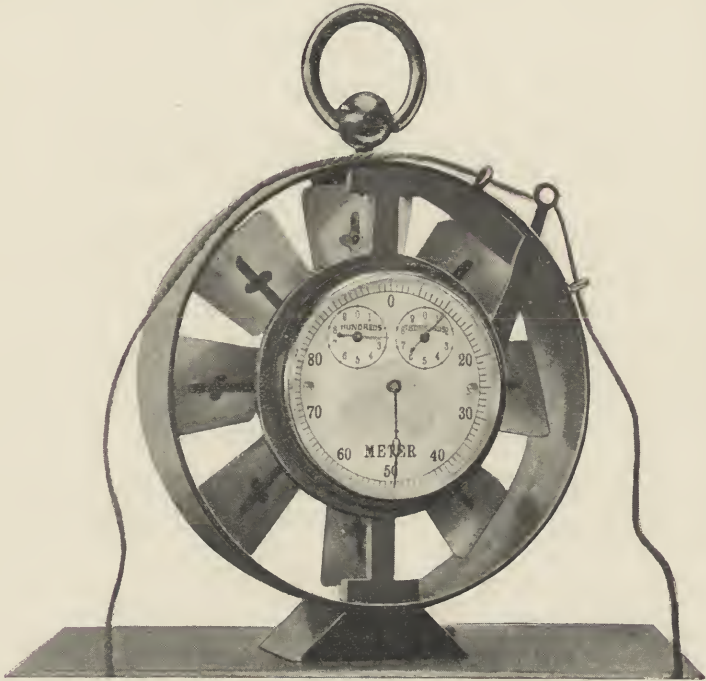

FIG. 134.—Improved anemometer, as supplied by the Sturtevant Engineering Co.

actually lap themselves upon the pressing rollers, so much fibre is carried away by the rollers and deposited upon the rubbers, that the sliver is rendered lighter by an appreciable amount.

Under such conditions, too, the rove is much more "hairy," and requires more twist to strengthen it, on account of the fibres not binding so well together through the lack of moisture.

No air is ever absolutely dry, although in the British Isles the east wind is often very dry.

Sometimes we experience an opposite state of the atmosphere when the air is saturated with moisture which condenses on every heat-absorbing object.

The air on a summer day, which we would consider to be fairly dry, might in reality contain a much larger quantity of moisture than does the air upon a winter's day when much rain has fallen. It is not the quantity of moisture contained in the air with which we must concern ourselves; it is its capacity for absorbing more. Warm air is capable of holding in suspension a much larger quantity of aqueous vapour than is cold air. When air at any temperature contains as much moisture as it is capable of absorbing, it is said to be saturated. Dew point is the temperature at which air is just saturated with a given quantity of moisture. If the dew point is high, the air contains a large quantity of moisture. If the air contains a small quantity of moisture, the dew point is correspondingly low. The temperature of dew point is best obtained with the aid of a hygrometer (previously described and shown in fig. 65) in the following manner:—

Multiply the difference between the temperatures of the wet and dry bulb by Glaisher's factor, which corresponds with the temperature of the air at the time of observation, and subtracting the product thus obtained from the temperature as indicated on the dry bulb, we get the temperature of the dew point. Glaisher's factors vary from 3.1 for 32° F. to 1 for 85° F., so that the factor for 75° F. being 1.5, the temperature of dew-point when the dry bulb indicates 75° F. and the wet bulb 73° F. is 75° F. - [(75 - 73)1.5] = 72° F. It is by reason of the variation in Glaisher's factor that the Factory Act of 1889 requires that the difference in reading of the wet and dry bulb thermometers should vary from 2 degrees at a temperature of 60° F. to 8 degrees at a temperature of 95° F. in order that the temperature of the dew point may be well below the temperature of the atmosphere, which will then be relatively dry.

A convenient form of automatic self-registering apparatus supplied by a Paris firm shows the humidity of the atmosphere from hour to hour and day to day. Its working is based on the expansion and contraction of a twisted thread of human hair which acts upon a finger arm, a pen upon the end of which traces a line upon a strip of paper which passes around a drum moved by clockwork.

In figs. 135 and 136 we show the improved Drosphore humidifier, which may be used with good effect in preparing and dry spinning rooms. Water under pressure is conveyed to the machine by a galvanised wrought iron pipe marked "inlet" in fig. 135.

The lower pipe, marked "outlet," receives the waste water, which returns to a tank fixed in a convenient place, where the water is filtered and used over again, so that none need run to waste. If a supply of water at 100 lbs. pressure is available it may be utilised, otherwise a small pump is required to get up the necessary pressure. The nozzle by means of which the water spray is formed is shown in section in fig. 136. The orifice of the nozzle may be washed when required by pulling the lever shown, when

a quantity of water is allowed to pass, which also cleanses the filter and flushes the return of the apparatus. When at work the water issues in the form of a fine mist all around the lower part of the machine, as shown in fig. 135. About 60,000 cubic feet of air per hour may be humidified with this apparatus.

A simple but effective method of purifying and humidifying the atmosphere of a room is that of Kestner. An air pipe surrounds three

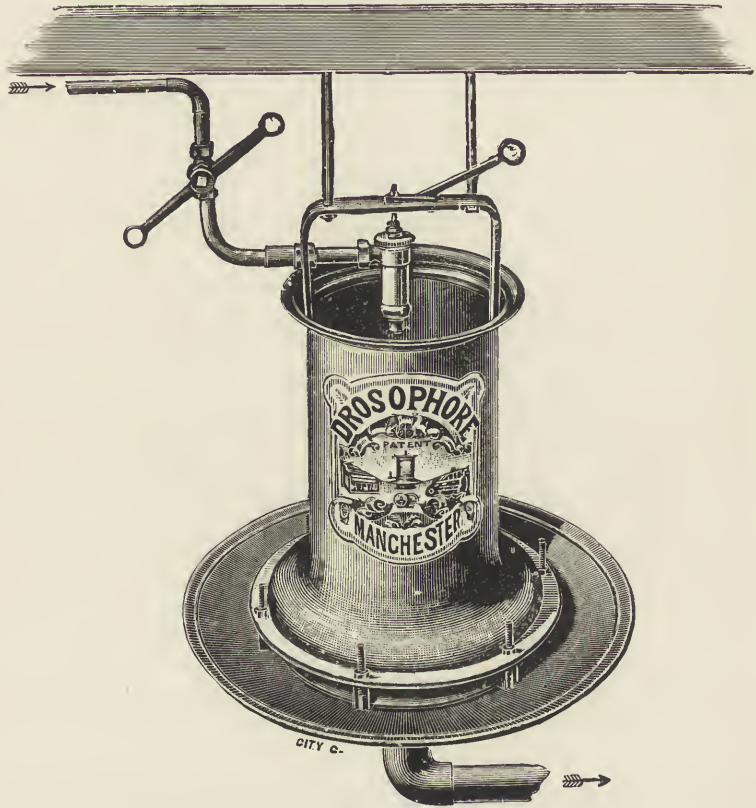

FIG. 135.—The improved "Drosophore" humidifier.

sides of the room. A fan is placed in one corner of the U thus formed and draws air through apertures in the opposite leg of the U, and at the same time a certain quantity of water which is spread over the internal surface of the tube by the force of the air current. The dust and fluff is retained by the damp sides of the tube and washed away with the surplus water, while the air is humidified in passing along two sides of the U and returned into the room through apertures in the third side after passing through the fan.

Systems of Ventilation :—Wilson-Clyma's.—One of the special methods of flax, hemp, tow and jute carding room ventilation is shown in figs. 137, 138, and 139. This system is associated with the name of Mr T. E. Wilson-Clyma of Ghent and Lille, who has made it the subject of several patents, brought it to a high state of perfection, and introduced it into many important mills in Belgium and the North of France. Fig. 137 shows the

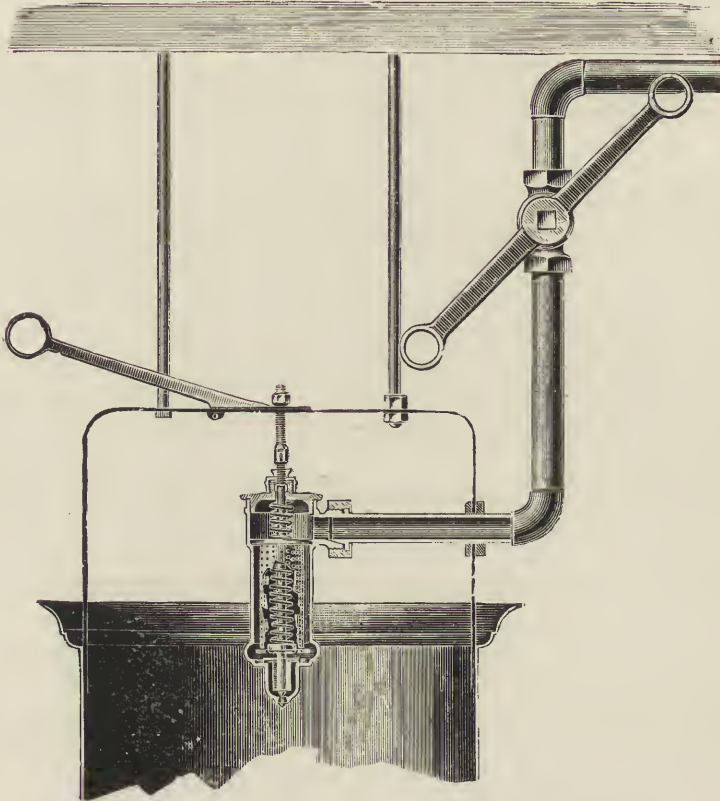

FIG. 136.—The "Drosophore" humidifier ; section of the nozzle.

yard of one of the most important flax mills which exist—the Société Linière Gantoise, the cyclone dust depositors and separators with dust chambers being clearly seen. It is in this mill, where it is applied to more than a hundred cards, that the system has reached its present state of efficiency. In figs. 138 and 139, E are conical excavations or card pits, the sides inclined and covered with glazed tiles, offering a perfectly smooth surface to allow the card waste to slip down, as it falls, to the ducts B of glazed earthenware pipes. A powerful fan D draws away the dust and waste and throws it up into the cyclone-separator C, which is constructed in such a

way that the heavy waste falls downwards into the chamber F, while the air escapes from the upper portion of the cyclone. The system works well if the sides of the pit are inclined at a proper angle, and if the ducts are of sufficient section. The amount of card waste is not increased by the suction of the fan, which is not intense, except at the apex of the cone and mouth of the duct, which are far removed from the card cylinder, and of comparatively small section. Practical experience has shown that the danger of fire being communicated from one card to another is not increased.



FIG. 137.—System, Wilson-Clyma, for the ventilation of carding rooms.

When the carding room is situated on an upper floor, the underground pit and air ducts must be replaced by metal conduits, the inside surfaces of which must be perfectly smooth.

The drawing off of the dust where generated and in a downward direction is the only really effective way of ventilating, and preventing the dust rising into the atmosphere of the room. The fan used with the above installation is that made by the Buffalo Forge Co., and is built on similar lines to the Sturtevant fan shown in figs. 140 and 141. These fans do not become obstructed by the waste, as do some centrifugal fans with closely-set blades.

Huglo's System.—Another system is that of Huglo, which may be thus described. Under each card is a pit about 18 inches deep. A fan is set in the front side of the pit under the feed sheet, the spindle of the fan being entirely covered to prevent the waste from lapping around it. The card is completely covered in, and the air to replace that removed by the

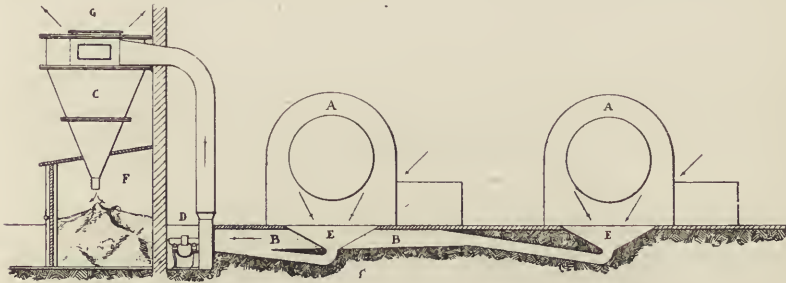

FIG. 138.—Section showing cards, conical pits, ducts, fan, cyclone and dust chamber for ventilation of carding rooms. System, Wilson-Clyma.

fan enters at all the small apertures around the roller axles, etc., preventing the dust from issuing into the room. An endless sheet of wire netting, situated in the main duct and turned at a regular speed, separates the

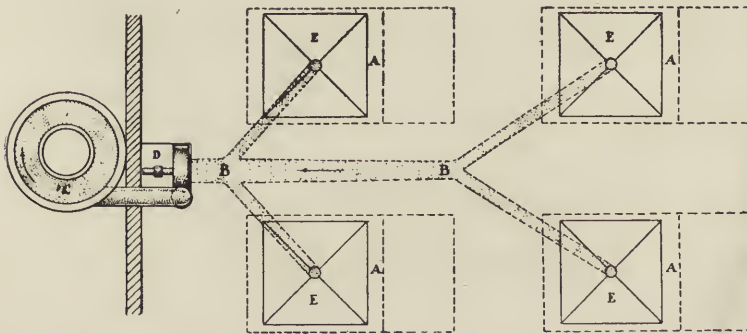

FIG. 139.—Ventilation of carding rooms. System, Wilson-Clyma.

dust from the waste, the former being expelled into the outer air and the latter collected by hand.

Carter's System.—It is to avoid the laborious and unhealthy operation of the gathering up and baling of the card waste by hand, as also any danger of the removal of valuable fibre from the card cylinders by the action of a strong air current, that Carter's system of card-room ventilation and mechanical and automatic waste removal and baling shown in figs. 142, 143, 144, and 145 has been devised.

Fig. 142 is a plan of a carding room containing eight cards.

Fig. 143 is a vertical and longitudinal section of a row of four cards showing the main and secondary waste removal lattices, a waste balling chamber, and cyclone dust separator and depositer.

Fig. 144 is a vertical transverse section showing the main air duct and waste removal lattice directly under the row of cards.

Fig. 145 is a longitudinal vertical section showing the main duct and travelling lattice immediately under the row of cards, with the lattice rollers.

The arrangement shown in figs. 144 and 145 is to be preferred when the

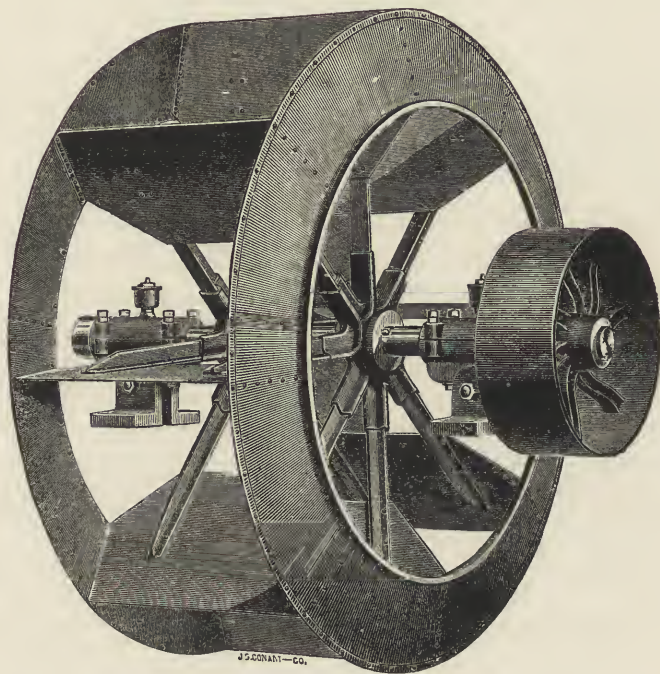

FIG. 140.—Fan wheel.

carding room is situated on an upper floor, as the duct required, being shallow, may be specially constructed and attached to the ceiling of the room underneath.

The apparatus is divided into two parts, one consisting of the fan or fans for the removal of the dust and of a cyclone depositer for causing the same to fall and accumulate in a sack or other receptacle, the other part consisting of travelling lattices to carry away the heavier waste and deposit it in bales or otherwise as desired.

The degree of draught may be reduced to a velocity just sufficient to carry away the light dust, leaving the heavier particles to be carried away

mechanically. The travelling lattices may be driven either continuously or intermittently. If continuously, the quantity of waste remaining upon them at any time is so small as to cause an insignificant amount of

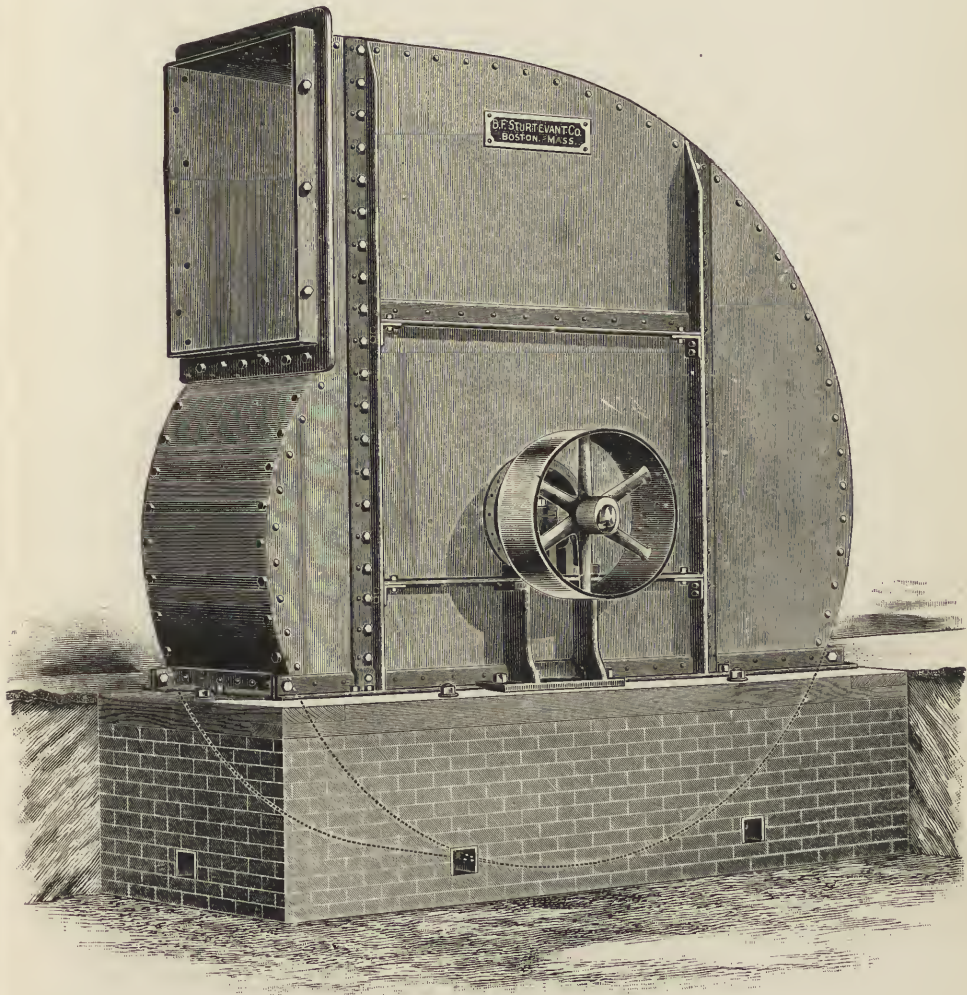

FIG. 141.—Sturtevant steel plate pulley fan.

damage in the case of fire. The travelling lattice may be of a fireproof material. The duct is of masonry, or, if on an upper floor, of sheet iron lined with fire tiles, and is also fireproof. Sprinklers may be placed in the upper portion of the duct, to come into operation on the outbreak of fire. The main lattice may be driven from one end by a belt and a series of

wheels to give a slow speed. The secondary lattices, if employed, may be driven separately from their own card by a chain and sprocket wheel, or may communicate motion one to the other by means of spur or bevel gearing, etc. The openwork lattices serve as a sieve, the shove which

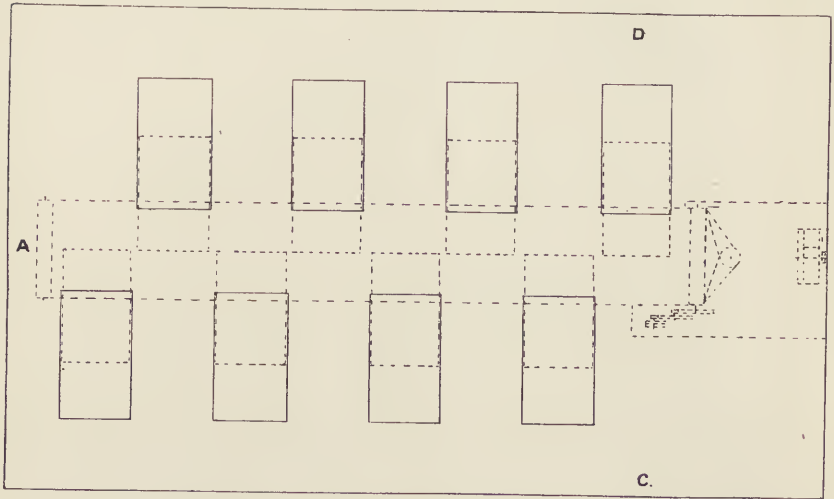

FIG. 142.—Plan of carding room fitted with Carter's ventilating and waste removal system.

falls through them, and is deposited in the bottom of the duct, being periodically removed by scrapers fastened when required upon the lattice, which may be turned in the reverse direction for a few minutes to scrape out the dust and shove. The iron framework supporting the lattices

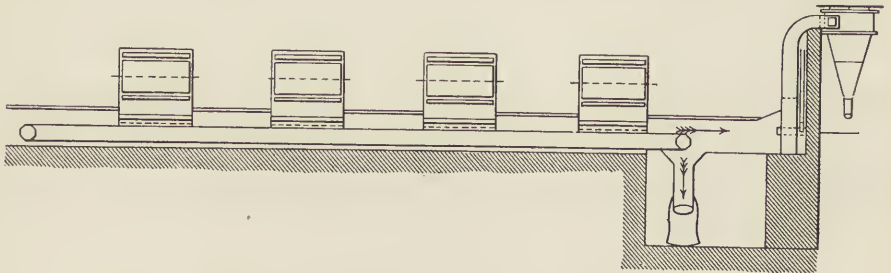

FIG. 143.—Longitudinal section of row of cards with air duct, travelling lattice, dust chambers and cyclone separator.

permits the hackle-setters to stand upon it, when they are occupied under the card, without doing any damage.

An inclined taper or bell-mouthed conductor or shoot, seen in fig. 143, is used to guide the waste into bales as it is delivered from the main travelling lattice.

The balling chamber, shown in figs. 142 and 143, is situated at the end of the main duct and travelling lattice. If on the ground floor, it is a cellar. If on an upper floor, it is a small outside building or a partitioned-off portion of the room beneath. Fig. 142 merely shows how a new and model room might be arranged. In old and existing rooms, the ducts and lattices must be arranged to suit circumstances. In every case the cards may be conveniently supported upon iron beams of **H** section, as shown in figs. 144 and 145, thus permitting the waste to fall directly upon the lattice underneath, which should be wider than the opening above it. When the card room is upstairs in a fireproof mill, the card should be placed in the

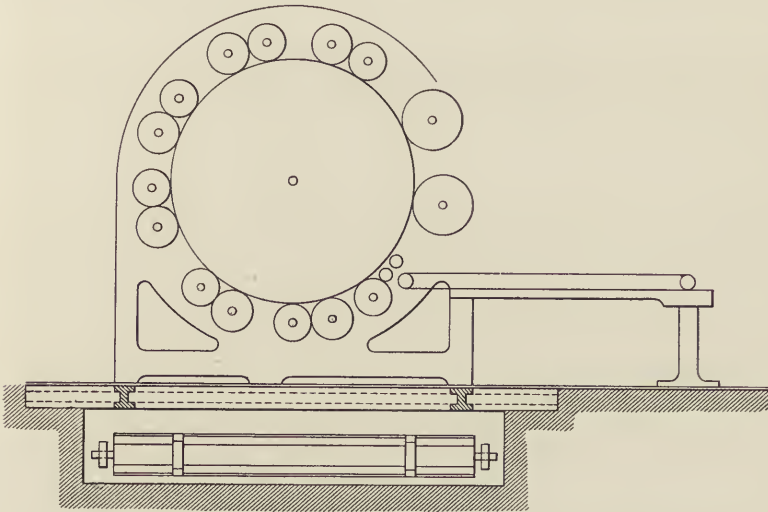

FIG. 144.—Transverse section through card, and air duct placed underneath.
Carter's system.

centre of a bay and be supported upon auxiliary iron beams extending from one main girder beam to another, so that the building is not weakened in any way by the cutting away of the arch of masonry underneath the card. Supplementary lattices are used when the main lattice cannot be passed underneath the row of cards. Their duty is to convey the waste and deliver it upon the main lattice. The advantages claimed for this system are that, unlike some systems, the apparatus may be applied whether the carding room be upon the ground floor or upon an upper storey, or whatever may be the arrangement of the cards in the room, and that the installation requires very little power. If the secondary lattices are driven from the cards themselves, motion ceases when the card is stopped, and force is thereby saved. There is a complete ventilation and automatic removal of waste without an increase in the quantity of card waste

produced; a saving in labour and a gain in health through avoidance of the necessity of removing the waste by hand and less damage in the case of fire, due to there being no accumulation of waste underneath the cards.

Ventilation of Hackling Machines.—Hackling machines are sometimes completely covered in and the dust which they generate drawn downwards through an orifice underneath into an air duct which is in communication with an extracting fan.

Protection against Fire.—Means should be provided to protect the mill buildings, stocks and plant against fire. So-called fireproof mills, built entirely of iron, bricks and mortar, are sometimes more damaged by fire

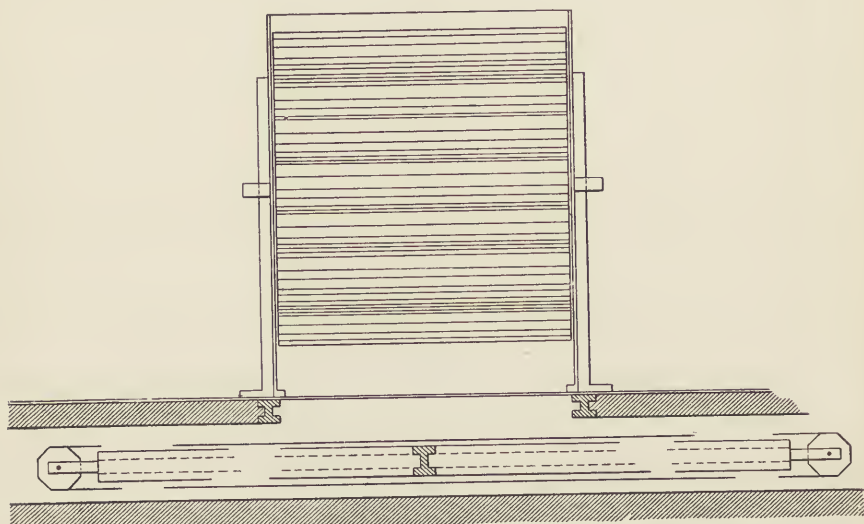

FIG. 145.—Longitudinal section through card, showing air duct, endless lattice and rollers. Carter's system.

than a mill in which wooden beams and columns are used, for the reason that wooden beams only char on the outside, the centre remaining solid, while iron beams and columns expand and twist with the heat, and often bring down the whole structure.

Fire buckets should be provided in each room, as well as extinguishers and hand grenades to be used at the moment of the outbreak. Automatic sprinklers are not so much used as they might be, considering their proved value in many an outbreak of fire. An installation of sprinklers consists in a system of piping attached to the ceiling and filled with water under pressure. The sprinkler nozzle is screwed into T^{1/2} on the pipe, and is constructed in such a way that immediately the heat caused by the fire underneath becomes sufficiently strong, the solder which holds the nozzle closed melts and a copious shower of water is thrown down upon the fire.

A bell may be connected with the system, and arranged in such a way that it commences and continues to ring when a sprinkler opens work.

All important works should have a volunteer fire brigade, especially if the mill is situated in the country and out of reach of an official and properly equipped brigade. In forming this brigade the men of the place should be regularly trained in the use of a good hand pump and the proper management of the hose-pipe.

Every mill should have an outside iron stairway with doors opening outwards for use in case of fire. The rooms should be separated by iron doors, double if possible, and the separation walls should project through the roof.

CHAPTER XX.

BOILERS AND ENGINES, STEAM AND WATER POWER.

Motive Power.—In the linen trade, as in almost every other industry, steam, with the exception of water, which is not always available, affords the cheapest motive force. Gas engines have been tried for mill driving, and proved a failure, and electricity, as at present available, must be regarded rather as a means of transmitting motion than as a motive power. Flax spinning mills on the wet system could not, of course, do without steam in any case, as in the ordinary way the water in the spinning troughs must be heated to a considerable temperature, and steam is generally required for drying, especially in winter. Nevertheless, if a spinning mill be situated near to a water course, a great saving may be effected by utilising this natural source of power either to drive the whole mill or to supplement the force derived from a steam engine. In days gone by the breast wheel was the favourite form of water motor. To-day the turbine is almost universally employed both for high and low falls. Of the different types of turbines there is none better than the Samson turbine supplied by Messrs James Gordon & Co., London. Fig. 146 shows the turbine in its upright form. It consists of a runner or wheel formed of heavy flanged steel plates, cast into a strong centre piece which is keyed upon the vertical shaft, by means of which motion is conveyed to the machinery to be driven. A cast iron band surrounds the whole and gives the wheel strength and durability, and at the same time renders it proof against injury through contact with wood and other foreign substances which may drift down the river. Fig. 147 shows the same turbine mounted horizontally. This form is specially suitable for falls of from 8 to 15 feet, where it can be placed in an open trough, race, or flume, without any connecting pipes or casing. The horizontal driving shaft may be conveniently extended through a stuffing box and gland in the side of the flume, and a belt or rope pulley mounted thereon. The water enters the turbine from the outside, passes through it, and is discharged through the draught tube seen to the right of the figure. Fig. 148 is a similar turbine fitted with a rope pulley and cased in, being fed with water through the supply pipe shown. Double the power may be obtained from a double turbine constructed on this principle, consisting of two

wheels mounted in the same case and upon the same horizontal shaft as shown in fig. 149.

Turbines may be used whenever a 3 to 3000 feet head of water is at hand. To ascertain the power available, the first step is to measure the amount of head or fall. This is most conveniently done by means of an engineer's level, which is run from a point at the upper line of water rights to a point at the lower line of rights. The vertical distance between these two points is the head or fall. The next step is to ascertain the quantity of water which the stream affords. This can be done by estimating the cross section of the stream in square feet and multiplying by the velocity in feet per minute, the result being the cubic feet of water passed per minute. This calculation is rendered easier by the construction of a weir, say out of a plank, and then measuring the depth of water which passes over it. This depth in feet multiplied by the width of the stream in feet gives the section in square feet. The average velocity of the current may be estimated by throwing a floating body into the stream at that place and timing it over a measured distance. The velocity of the



FIG. 146.—Upright Samson turbine. Supplied by Messrs James Gordon & Co., London.

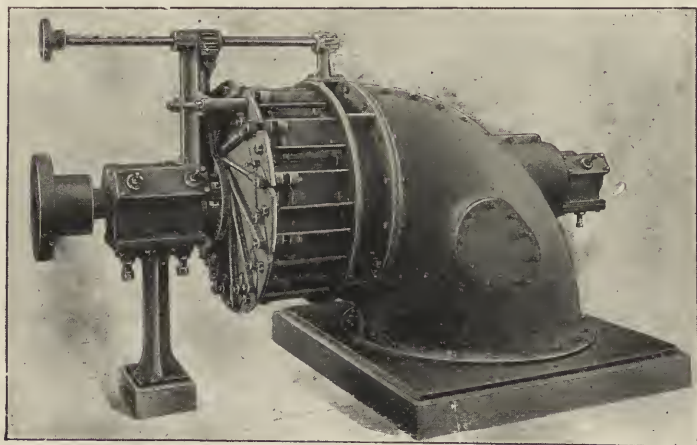

FIG. 147.—Horizontal Samson turbine. Supplied by Messrs James Gordon & Co., London.

water on the surface and in the middle of the stream will always be higher than it is near the edges and bottom, since there is friction

between the moving body of water and the sides and bottom of the stream, so that the velocity obtained will probably be rather over the mark. The weight of a cubic foot of water is about 62 lbs. The theoretical power available is the product of the weight of water which passes per minute, and the height or head through which it falls, divided by 33,000, the number of foot pounds which constitute a horse-power. The actual power which may be taken off is the product of the theoretical power and the efficiency of the water motor employed.

The efficiency of the types shown is about 80 per cent., which compares very favourably with that of other forms of water motors.

Before leaving the subject of turbines, we must mention that steam turbines are already on trial in textile mills, and may, before the end of the century, displace the use of the steam engine to some extent. Their possible greater efficiency lies in the fact that, running constantly in the same direction, there are no moving parts to be brought to rest at repeated intervals, as there are in the steam engine at each stroke of the piston.

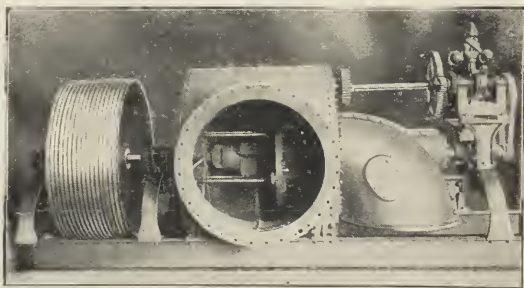

FIG. 148.—Horizontal Samson cased turbine.
Supplied by Messrs James Gordon & Co., London.

An important installation of steam turbines has just been made by the British Westinghouse Manufacturing Co., Ltd., in the large jute mill of Messrs Birkmyre Bros., on the river Hugli, near Calcutta. The turbines are of the multiple expansion parallel flow type, running at 1500 revolutions per minute with steam at 175 lbs. pressure per square inch, 200° F. superheat, and a 27½-inch vacuum. Each turbine exhausts into a vertical surface condenser having 4800 square feet of cooling surface.

Boilers.—Turning to the subject of steam, the boilers must first occupy our attention. In British flax, hemp, and jute mills, the Lancashire and Cornish types of boilers are almost universally employed, the number of the former exceeding that of the latter. Some few water-tube boilers of the Babcock & Wilcox type are likewise used, as they are also on the Continent.

In the north of France an externally-fired compound cylindrical boiler (shown in section in fig. 150) is a very favourite type. It is composed of three or more cylindrical shells, 3 to 4 feet in diameter, united one to the other by communicating tubes through which a man can just pass.

This boiler gives a large heating surface and is of large capacity, and easily cleaned, as there are no narrow and confined spaces as in a Lancashire boiler. Fig. 151 shows a Lancashire boiler of modern type. This boiler has, in common with the Cornish type, a large cylindrical body 18 to 30 feet in length, pierced from end to end, in the former type with two, in the latter type with one, cylindrical flue, in the front end of which the fire-grate is situated. The material used should be the best steel plate for high pressures, or the best Thornycroft or Staffordshire rolled plate for medium pressures. The front rings of the flue, upon which the fire impinges most, should be of the very best Low Moor or Bowling iron plate. For a Lancashire boiler, 30 feet long by 7 feet 6 inches diameter, to work at 150 lbs. pressure per square inch, the shell plates should be $\frac{3}{4}$ inch thick, and the longitudinal joints double-butt strapped and trebly riveted. For a similar boiler, to work at 100 lbs. steam pressure, half inch will be found a sufficient thickness for the shell plates, the longitudinal seams being double lap-jointed.

The indicated horsepower which can be supplied by a boiler of this type may be based on a coal consumption of 24 lbs. per square foot of grate area per hour, an evaporation of $8\frac{1}{2}$ lbs. of water per lb. of coal, and a water consumption of 18 lbs. per I.H.P. per hour for a compound Corliss condensing engine, and 23 lbs. per I.H.P. per hour for the simple Corliss condensing engine. Twenty-four lbs. of coal per square foot

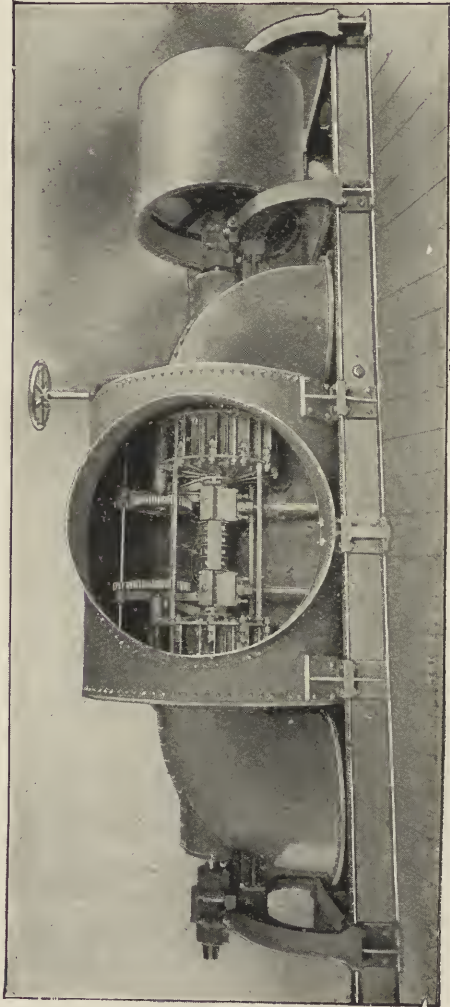

FIG. 149.—Double horizontal cased Samson turbine. Supplied by Messrs James Gordon & Co., London.

of grate area per hour should be easily consumed with an ordinary draught, and $8\frac{1}{2}$ lbs. of water, at an initial temperature of 25° F., evaporated per lb. of coal consumed. The flue plates may be the same thickness as the shell, or $\frac{1}{16}$ inch lighter, but the end plates should be $\frac{1}{8}$ inch heavier. The end plates are secured to the shell by means of angle iron and stayed by gusset plates secured by double angle irons. These gusset angle irons should never approach within 10 inches of the flue, in order that "grooving" may be avoided by giving elasticity to the end plate. Groov-

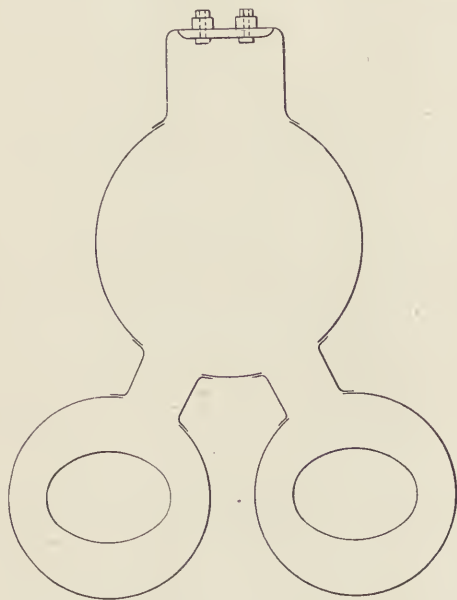

FIG. 150.—Section through a French generateur à bouilleurs.

ing is the weakening effect produced by the repeated bending backward and forward of a plate at a point where it is rigidly held, and in the end plate of a Lancashire or Cornish boiler is produced by the expansion and contraction of the flues which unite the end plates. The flues should be built up in sections, united by Adamson's flanged seam or expansion joint, and are often intersected by four or more Galloway tubes welded in. The use of Galloway tubes is now, we believe, being discontinued by some of the best makers. The manhole mouthpiece should be of wrought iron or steel double riveted to the shell of the boiler. The rivet holes should be drilled in position and never punched. Two longitudinal stay bolts usually pass through the boiler from one end to the other in order to strengthen the end plates, but should always remain slack to avoid grooving. The fire bars should rest on bearers riveted to the furnace plates. Numerous systems of moving fire bars, mechanical stokers, and force draughts have been devised, the most successful of the latter being probably the Meldrum system, in which the air is drawn into a closed ashpit by means of a special steam jet blower and forced through the fire on the grate. A very much poorer fuel may be burned successfully by the use of the Meldrum furnace. The steam is usually taken from Cornish and Lancashire boilers by means of an anti-priming pipe, but the use of steam domes or a collector is much to be preferred to supply the engine

with dry steam. The length of Lancashire boilers runs from 21 to 30 feet. The grate surface is from 25 to 39 square feet, the effective heating surface from 490 to 900 square feet, and the power from 280 to 440 I.H.P., according to size, with a good engine.

The Babcock & Wilcox boiler is a water-tube boiler with a cylindrical

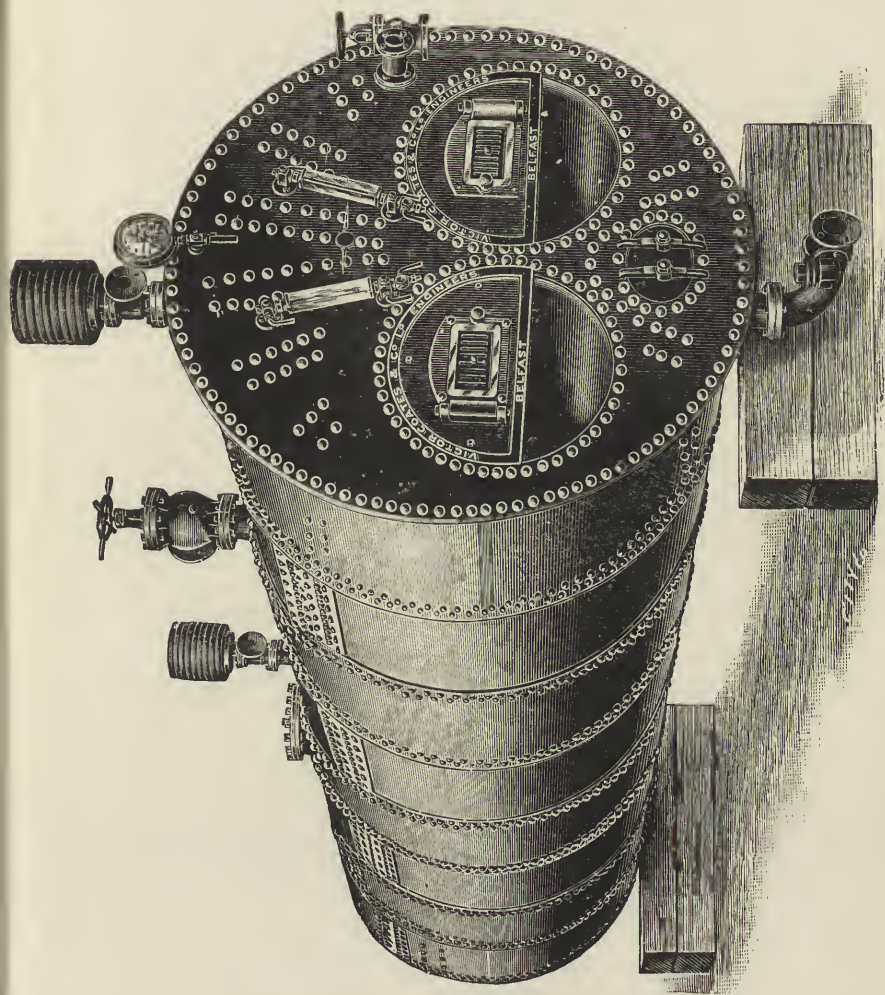

FIG. 151.—Lancashire boiler, as made by Messrs Victor Coates & Co., Ltd., Belfast.

body, which is placed rather high up. The tubes are about 4 inches in diameter, arc outside the body of the boiler, and extend in a slanting direction from front to back over the furnace, the flame and gases from which pass upwards through them over a high bridge and downwards through them again to the flue. With this class of boiler steam pressure

may be quickly raised, but falls equally quickly. For wet spinning mill work, where a store of steam is often required during the night for drying, etc., a boiler with more steam space is to be preferred. With hard or dirty water, water-tube boilers are often troublesome, from the fact that the tubes become choked and have often to be almost bored out, notwithstanding the fact that a mud-cock is provided and the sludge blown off daily. In water-tube boilers the furnace doors should be on the swinging principle, and arranged in such a way that if a tube should burst, the pressure of water and steam puts out the fire and holds the furnace door shut, to the protection of the firemen.

The setting of steam boilers is an important point, as the flues must be easily accessible for cleaning and for the examination of the boiler shell. In Lancashire and Cornish boilers the smoke, flames, and hot gases should, after leaving the internal flue or flues, pass into an external flue passing under the bottom of the boiler from back to front. At the front end of the boiler the gases are split into two parts, one part entering a side flue to the right and another part a similar flue passing along the left side of the boiler. At the back end of the boiler these flues communicate with the main flue leading through the economiser to the chimney. The two side walls of the bottom flue upon which the boiler rests should be as narrow as possible, in order to leave a large surface, and especially the longitudinal seams, uncovered. Fireclay is the material which must be used in the construction of the flues, the boiler resting on specially-shaped blocks of that material, the side flues covered with fireclay tiles, and the use of lime mortar carefully avoided. The blow-off or mud-cock being in the front bottom portion of the boiler, the latter should have an inclination of about 2 inches from front to back, in order to run the boiler completely dry for cleaning, etc. The bottom flue should be about 30 inches wide for a 5-foot boiler and 54 inches wide for an 8-foot boiler, its depth varying likewise from 24 to 30 inches. The narrowest part of the side flues should not be less than 12 inches. As regards height, the side flues should always extend above the top of the furnace crowns.

An apparatus known as an economiser should be inserted in the main flue between the boilers and the chimney. Its object is to utilise the large quantity of heat still possessed by the smoke and gases, in raising the temperature of the feed water. The gases from the boilers usually enter the main flue at a temperature of 400° to 700° F., and may be robbed of their heat to the extent of raising the feed water from a temperature of about 90° to 300° F. in extreme cases. When the feed water has a lower initial temperature than 90° F., which rarely occurs if water from the hot well of the engine be used, its passage into the economiser pipes sets up a most injurious "sweating" or condensation on the exterior surfaces of the tubes, causing rapid corrosion and caking of the soot. If the engine has a

condenser, water is, as we say, easily obtainable at a sufficient temperature from the hot well. When the engine is on the non-condensing principle, the exhaust steam may be conveniently used to heat the feed water to a temperature at which it may with safety be passed to the economiser. Practically the only economisers in use are Green's and Locoock's, which, to all intents and purposes, are the same. The cast iron pipes through which the feed water is circulated, and which offer the large heating surface required, are arranged vertically, in rows of from four to ten pipes, in a chamber forming part of the main flue, which is thus 40 to 90 inches wide at this point. The number of pipes which may be advantageously employed may be estimated at the rate of one pipe for every 3 I.H.P. developed by the engine. Thus a mill utilising 600 I.H.P. should have a battery of $\frac{600}{3} = 200$ economiser pipes. Satisfactory results may also be obtained by allowing four pipes to every ton of coal burnt per week.

The smoke in passing among the tubes deposits a large quantity of soot upon them, which soot, if not scraped off, would act as a non-conductor and prevent the absorption of heat. Scrapers have consequently to be employed to keep the outside surface of the tubes free from soot. These scrapers, which embrace the tubes, are given a slow but constant reciprocating up-and-down motion by means of chains, balance weights, and motive force, provided by a belt or electric motor. The soot as scraped off accumulates in a chamber underneath the apparatus, from which it is periodically removed. Should the scrapers become clogged at any time through the presence of humidity on the tubes, the economiser should be run dry, the hot gases left circulating among the tubes, and the scrapers kept going until the soot is burnt away and they work easily again. Care must be taken that the tubes are cold before water is again admitted, lest an accident should happen through a rapid rise in pressure. A safety valve should always be provided to minimise danger on that score. A reserve or alternative flue passes underneath the economiser, so that by the use of dampers the apparatus may be stopped for cleaning or repairs. If the economiser is much exposed it is advisable to empty it prior to a prolonged stoppage in frosty weather. The pipes are forced into taper sockets in the top and bottom boxes. Openings in the upper box opposite each pipe are closed by ground and taper cast iron stoppers or "lids." It is sometimes a little bit difficult to make these stoppers watertight when they are replaced after cleaning. The best way is to smear the faces with a little white lead and draw up the lid very tightly with a T-headed bolt and bridge piece, tapping around the hole all the while with a hammer. The use of red lead, and sometimes even of a very thin sheet of the metal lead, may have to be resorted to in extreme cases. A blow-off or mud-cock is provided, and should be blown off regularly every day, as, even with comparatively soft water, the tubes are apt to become choked by sediment

and incrustation. A thorough cleaning should be made at least once a year, it being found necessary in some cases to actually bore out the tubes, so completely are they filled with a calcareous deposit.

The prevention of incrustation on the internal surfaces of the boiler and of the economiser tubes is a matter of the very greatest importance, both as regards economy of fuel and durability of the boiler. Deposit of this sort prevents the passage of heat to the water, and is apt, especially in the case of the furnace plates, with which the flames come into actual contact, to cause overheating, burning, and injury. Incrustation is due to the presence in the feed water of salts of lime, magnesia, etc., which can only be removed by chemical means, necessitating the use of a water-purifying apparatus.

Water Testing and Purifying.—The presence of lime in the feed water may be detected by mixing with it a soap solution, when, if present, an insoluble lime compound in the form of a thick curd will form after sufficient soap has been added to neutralise the lime. In order to detect the presence of lime as carbonate or sulphate, the water is evaporated to one-eighth of its bulk. If the water remains clear it may be taken as a sign that lime is either absent altogether or present in the form of nitrate or chloride. Usually, however, the water becomes turbid, in which case add a little hydrochloric acid and watch the effect. If the liquid effervesces and becomes clear, the water contains carbonate of lime; on the contrary, if no effervescence takes place, it is sulphate of lime which is present: if it effervesces and partially clears, both carbonate and sulphate of lime are dissolved in the water.

Lime may also be detected by the addition of a solution of ammonium oxalate to the water in question. If lime be present a white precipitate of calcium oxalate is formed. When this precipitate has been removed by filtering, the presence of magnesia may be detected by concentrating the liquid by evaporation and mixing with it a solution of phosphate of soda and ammonia. If a white crystalline precipitate is thereby produced, it may be assumed that magnesia is present.

Bicarbonate of lime is easily detected by merely boiling the water or adding to it a clear solution of lime water. In both cases the lime falls as a white precipitate.

The precipitation of lime by the addition of lime water is the discovery of a certain Dr Clarke, and forms the basis of all systems of water softening and softeners.

The theory of Dr Clarke's process of purification and softening with lime is as follows:—Since calcium and magnesium carbonates are only soluble in water containing carbonic acid which it has extracted from the air, etc., the natural remedy is to employ some means which will rapidly and effectually absorb this acid. Dr Clarke used calcium hydrate or

slaked lime as the cheapest and most suitable agent for this purpose, and it is this material which is in general use to-day. The following equation expresses the theory of the process :—

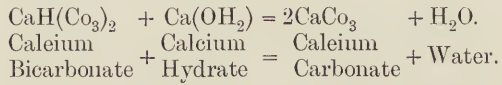

Only the temporary hardness is thus removed, and not even completely. It is best to use clear lime water for correction, because it possesses a known constant composition. The amount of such lime water which it is necessary to employ may be calculated after making an analysis of the water, or it may be found by actual experience. The addition of too much lime water must be avoided, and is readily detected by adding a few drops of a filtered decoction of cochineal to a small quantity of the water being treated. Excess of lime water changes the yellowish-red colour of the solution to a violet. A small quantity of caustic soda may also be conveniently added to the feed water to be purified, as, besides aiding in the precipitation of the lime, it forms sodium carbonate, which decomposes any sulphate of calcium or magnesia which may be present. The construction of an improved apparatus for employing Clarke's process upon boiler feed water is as follows:—The water to be purified is allowed to flow in regular quantities into the enlarged open end of a large vertical pipe, into which flow at the same time the necessary quantities of lime water and soda lye. The feed water is thus at the first intimately mixed with these re-agents and passes into the lower portion of the depositing tank—a large rectangular receptacle, the lower portion of which is divided up by a series of diaphragms or plates riveted on to the sides at an angle of 45°. The action of the lime water and soda lye is, as we explained, to precipitate the lime held in solution. The lower end of the vertical pipe just referred to is provided with a mud-cock, by means of which the pipe should be regularly purged of any accumulation of precipitated lime. The object of the diaphragms in the depositing tank is to split up the water into thin layers and to provide a large surface for precipitation. The diaphragms are inclined so that the lime may run to the side, where it accumulates, to be periodically run off by purge cocks. Rising upwards the water passes through a filter of sponges or wood shavings held in trays, and then flows off to the tank from which the boiler feed pump is supplied. The purified water should be regularly tested to see that lime water and soda are being employed in proper proportions. To do this, measure 100 cubic centimetres of purified water into a bottle, and then measure in gradually a standard soap solution by means of a burette or pipette graduated in cubic centimetres. After each addition of soap solution, shake the bottle and note the point when a froth or lather is

formed which will last for at least five minutes. If a great deal of soap is used in forming this lather, it may be taken that the water is still hard with dissolved lime. The standard soap solution referred to may be prepared by dissolving 10 grammes of Castile soap (60 per cent. olive oil) in 1 litre of weak alcohol. Such a solution contains exactly enough soap in 1 cubic centimetre to precipitate 1 milligramme of carbonate of lime. The alcohol should be about 35 per cent. strength.

Some other forms of water purifiers which are modifications of Clarke's apparatus and process are: Porter Clarke's, Gaillet Huet's, the "Stanhope Purifier," Lemaire's, the "Tyack Softener," the Slack and Brownlow Purifier, and the Archbutt-Deeling Purifier, etc.

Instead of purifying the feed water some people take steps to keep the deposit, left by the water as it evaporates, in a soft state or in the form of mud, and thus prevent the formation of a hard and injurious scale. The accumulation of mud may be blown off occasionally through the mud-cock and the boiler thus worked for a considerable time without cleaning. A sack of potatoes put into the boiler after cleaning is often used to produce this result, as is also sometimes the injection of given quantities of petroleum, barium (pure or in the form of aluminate), etc. The admission of oil, in any form, into the boiler is not to be advocated however, since it tends to induce priming or the passage of water with the steam to the engine. Some patent acid scale removers have a good effect in causing scale to fall or to prevent its formation. Due care must, however, be taken that the boiler plates are not attacked. With certain waters an admixture of caustic soda with the feed water has a good result, but if too much be employed it will exercise a most injurious effect on the brass boiler fittings, especially where there is already a small leakage. Some impure feed waters tend to corrode the internal surface of the boiler.

The suspension of a piece of zinc under the surface of the water in the boiler has a protective effect, since the zinc is first attacked and oxidised, when it swells up into a spongy mass. The zinc is more effective if it be connected with the boiler plates by a metallic conductor.

Feeding Boilers.—Boilers under pressure are generally supplied with water by means of the feed pump of the engine, which may draw its supply from the hot well, from a tank of softened and purified water, or from other supply. The water is turned on to the pump when required by the boilers, the feed valves of the latter having previously been left open. It is very convenient to have a small independent feed pump for use always, even when the main engine is stopped. If such a pump be not at hand, the only way of feeding boilers under pressure when no pump is available is by means of water under a sufficient head, which is seldom to be obtained, or by means of an apparatus known as Giffard's injector. The theory and construction of the injector is as follows:—Steam from the boiler is

admitted into the steam chamber of the injector, from which it is allowed to rush out through an adjustable narrow aperture into the water chamber connected with the water supply. The steam rushing out in a jet at high velocity pushes before it a small column of water, to which it gives the same high velocity and sufficient momentum to force open the conical check valve which separates the feed pipe from the boiler. Thus, contrary to what might be supposed, steam under a given pressure is able to force water into a boiler under the same pressure.

If the drain pipe from a series of heating pipes, such as those of the drying loft, for instance, be connected with the boilers through a check valve, the condensed steam or water there produced will flow naturally back into the boilers if there be at least a 10-foot head in order to increase the back pressure sufficiently to lift the valve. The feed water should enter the boiler under the water level and towards the rear, in such a way that the perhaps cold water does not impinge on the plates directly heated by the fire. The head of water necessary to feed the boiler under pressure may be calculated from the fact that a column of water 1 foot high and of 1 square inch sectional area weighs $\frac{1}{4}$ lb. Hence to feed a boiler under 60 lbs. steam pressure requires a head of over $\frac{60}{\frac{1}{4}} = 150$ feet.

Pressure Gauges.—Every steam boiler must be furnished with several safety appliances to avoid accidents. These should consist of one or more indicators to show the height of the water in the boiler, two safety valves, and a steam pressure gauge. All surfaces exposed on one side to the heat of the fire should be covered with water on the other. In Cornish and Lancashire boilers the furnace crowns should be well covered. Should they be left uncovered, the crown might become red-hot and cause the collapse of the flue, or, if water should unfortunately be admitted while they are in that condition, an explosion due to the too rapid generation and rise in pressure of the steam. The ordinary water gauge has a vertical gauge glass, the upper end of which is in communication with the steam space of the boiler while the lower end communicates with the water space. Both connections being open, the water rises in the tube to the same level as it is in the boiler, which is thus clearly seen. The gauge cocks should be opened and shut frequently and the tube purged, to avoid the possibility of its not acting as it should owing to deposit in any of its connections. Both steam and water inlets should be closed by ball valves, which cut off the supply automatically when a gauge glass breaks and the pressure becomes unbalanced. Besides the gauge glass, it is advisable to have a water level gauge, actuated by a float attached to a rod passing up through the top of the boiler, and carrying or actuating an index finger by means of a rack and pinion. The rod may, furthermore, be provided with projections, which, in certain positions, act upon valves and admit steam to sound low and high-water whistles. An ingenious

method of causing this class of indicator to show the water level is to fix a magnet on the upright rod moving in a steam-tight envelope. This magnet causes a light piece of steel tube to move up and down over the face of a graduated scale which is open to the air, and thus to indicate the water level. All pressure gauges in general use are constructed upon the Bourdon principle, which consists in the use of a closed copper pipe, bent round into almost circular form. The end communicating with the boiler is fixed, while the closed end is free, and is connected with an index hand, which moves over a graduated scale according as the steam pressure causes the curved tube to straighten itself out.

In England steam pressure is denoted in lbs. per square inch, while on the Continent it is spoken of in terms of kilogrammes per centimetre carré (square), or sometimes in atmospheres. Below we give a table showing the equivalents under the three systems.

Kilogrammes per centimetre carré.	Pounds per square inch.	Atmospheres.	Pounds per square inch.
1	14.22	1	14.7
2	28.45	2	29.4
3	42.67	3	44.1
4	56.89	4	58.8
5	71.11	5	73.5
6	85.34	6	88.2
7	99.56	7	102.9
8	113.78	8	117.6
9	128.01	9	132.3
10	142.23	10	147.0

Safety valves are either weighted by a dead weight or by a lever and weight. Those shown upon the top of the Lancashire boiler (fig. 151) are of the dead weight type. When a lever is used, its length should be such that the desired pressure is maintained when the weight is on the extremity of the lever, rendering it impossible for the weight on the valve to be augmented, either intentionally or by inadvertence. It is prudent to have a safety valve, as well as a water level gauge, of each sort, on every boiler. The area in square inches of the safety valve required by the Board of Trade for a boiler may be found by multiplying the square feet of fire-grate surface by 0.326 for a boiler working at 100 lbs. pressure per square inch, and by 0.375 for those working at 85 lbs. pressure. Thus a 7 foot 6 inch by 21 foot boiler with 30 square feet of grate surface will require a safety valve of $30 \times 0.326 = 9.78$ square inches when working at 100 lbs. pressure per square inch, and a larger valve of $30 \times 0.375 = 11.25$ square inches area if working at only 85 lbs. pressure. If the lift of the valve be equal to one-fourth part of its diameter, that lift will be sufficient

to pass the maximum amount of steam which can possibly escape. The pressure per square inch which may be maintained by a lever of given length and weight upon which a ball of given weight is hung may be calculated from the following formula :—

$$P = \frac{WL}{AF} + \frac{w \times g}{AF} + \frac{v}{A}, \text{ where}$$

P = pressure in lbs. at which the valve will blow.

W = weight of the ball on the lever in pounds.

L = length of the lever from the fulcrum to the weight, in inches.

A = area of the valve in inches.

F = length from the fulcrum of the lever to the valve spindle, in inches.

w = the weight of the lever itself.

g = the length from the fulcrum to the centre of gravity of the lever.

v = weight of the valve and spindle.

To find the weight W , which must be used to sustain a given steam pressure, the formula

$$W = \frac{AF \left\{ P - \left(\frac{w \times g}{AF} + \frac{v}{A} \right) \right\}}{L} \text{ must be used.}$$

To find the distance L from the fulcrum at which to place the weight to sustain a given pressure, use the formula

$$L = \frac{AF \left\{ P - \left(\frac{w \times g}{AF} + \frac{v}{A} \right) \right\}}{W}.$$

Firing the Boiler.—The manner of firing the boiler is of the greatest importance as regards the consumption of coal or the amount of water which can be evaporated by or power which can be obtained by burning one pound of fuel. The coal must be spread evenly and in a rather thin layer over the surface of the firegrate. The damper should be almost closed before opening the door for firing, in order to minimise cooling by an inrush of cold air. The clinker must be broken up with the sledge bar, and the fire cleaned as frequently as required by the quality of the coal. The feed of water should be as regular and constant as possible in order that full advantage may be taken of the economiser. The steam pressure should be maintained at the regulation pressure for the boiler and engine, for to work at a lower pressure means a larger coal consumption for the same work, since high pressure steam is more economical from the fact that fewer thermal units are required to raise steam at a high pressure

to a pressure 1 lb. per square inch higher, than are required to raise the pressure of low pressure steam by the same amount.

It is this physical law which leads up to the use of superheaters for dry steam, a principle which has already been adopted and is likely to grow in favour as the century grows older.

The firebars are usually of cast iron, but occasionally of rolled wrought iron. The space between the bars varies from $\frac{3}{8}$ inch to $\frac{1}{4}$ inch, according to the size of the fuel being used. Thin bars have the advantage of causing

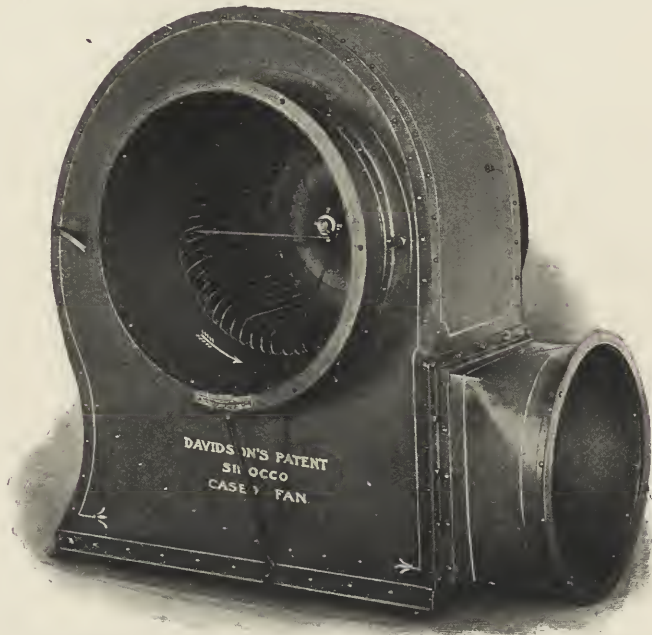

FIG. 152.—Davidson's Sirocco fan,
as supplied by Messrs White, Child & Beney, Ltd., London.

the air to be better split up in passing through the red-hot fuel. The bars will be kept cooler and last longer if the ash-pit be constructed in such a way that it may be kept full of water.

The draught obtainable by the use of a chimney rarely exceeds 1·1 inch of water, and is due to the difference in weight of the column of hot air contained in the chimney and that of a similar column of the outside air, consequently the diameter of the chimney has a much greater influence on the draught than has the height.

Within recent years high chimneys have been replaced in some instances by centrifugal or turbine fans of the Sirocco or Sturtevant type. A Sirocco fan is shown in figs. 152 and 153, while we showed the Sturtevant

type in Chapter XIX. by figs. 140 and 141. The air may be either propelled or drawn through the fire-grate, and the speed of the fan may be regulated to give the quantity of air required at any time to burn the smoke, etc. If properly applied, as shown in fig. 153, good results may be obtained, the force absorbed in driving the fans not exceeding the equivalent of $\frac{1}{2}$ per cent. of the coal consumed.

Steam Pipes.—Steam pipes of cast iron may be used for low pressures, but for high pressures they should be of copper, riveted steel plate, or electrically-welded wrought iron. If the pipes are long, expansion joints should be used. The pipes should be given a fall towards the boiler to

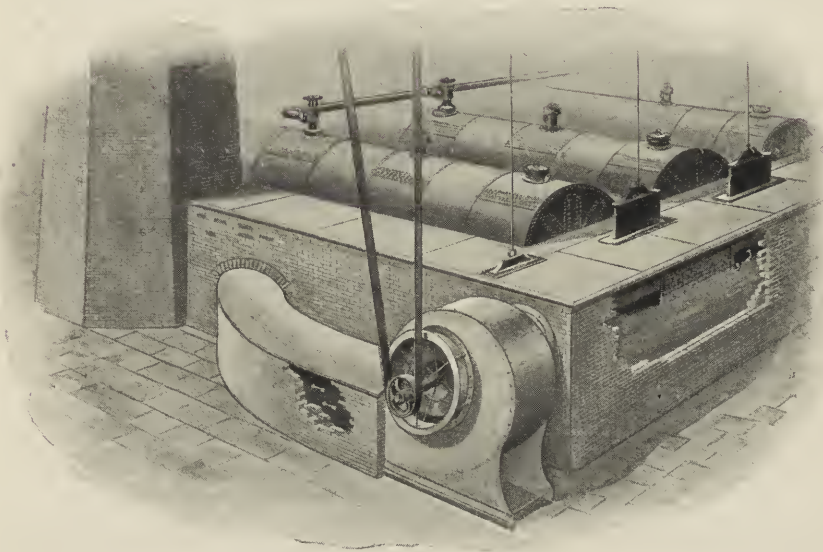

FIG. 153.—Induced draught produced by a Sirocco fan.

run off condensing water, and should be covered with a non-conducting composition, such as fossil-meal or asbestos rope.

Steam Engine.—No spinning mill or rope works can be considered up to date, or, indeed, be really economically worked, without a modern type of engine. The compound or triple-expansion horizontal engine is the one most generally employed, although in the Irish industrial capital a type known as the inverted cylinder vertical triple-expansion condensing engine has been very extensively and successfully adopted. A very good example of such an engine is that constructed by Messrs Victor Coates & Co., Ltd., Belfast, and driving such mills as that of the Brookfield Linen Co., Ltd., Belfast. This engine has three cylinders—19 inches, 29 inches, and 46 inches in diameter respectively, each having a stroke of 4 feet, and indicates 1000 horse-power when running at 75 revolutions per minute,

with a boiler pressure of 160 lbs. per square inch. Each of the three cylinders is supplied with four Corliss valves—two for steam admission and two for exhaust. In this particular engine the steam admission valves are fitted with Dobson's patent cut-off gear, which is controlled by a quick-speed governor in order to render the speed still more regular. The cylinders are arranged in regular succession—high pressure, intermediate, and low pressure—and have the Corliss valves placed at right angles to the crank-shaft, instead of parallel to it, as is often the case. The three cylinders are bolted together, and receivers thus formed between first and second and second and third respectively, connecting steam pipes being thus dispensed with. The piston rods are fitted with United States metallic packing, and the Corliss valve spindles arranged so that no packing is necessary. The piston heads are supplied with Rowan's patent rings. The cylinders are supported by columns resting on the bedplate, which carries the crank-shaft in six bearings. The crank-shaft is made of steel, built up of thirteen pieces carefully shrunk together and turned up. The fly-wheel, supported in two special bearings, is 15 feet in diameter, and has 30 grooves for $1\frac{3}{4}$ -inch cotton ropes. The air pump is worked by levers from the intermediate cylinder, and has a force pump at either side. A convenient "barring engine" is supplied for putting on ropes, etc., while white-metal is used for all the bearings.

As an example of another leading type of mill engine, and in order to show that Continental engineers have little to learn from us, we will briefly describe a large horizontal triple-expansion mill engine built by the Chemnitzehauer Maschinenfabrik, Saxony. This engine, which indicates 2000 horse-power, when running at 65 revolutions per minute and supplied with steam at 180 lbs. pressure per square inch, has four cylinders—a high-pressure cylinder $24\frac{1}{2}$ inches in diameter, an intermediate cylinder 37 inches in diameter, and two low-pressure cylinders each 55 inches in diameter, the stroke being 59 inches in length. All the cylinders are steam jacketed. The fly-wheel is $24\frac{1}{2}$ feet in diameter, and has 45 grooves for $1\frac{3}{4}$ -inch ropes, and weighs nearly 90 tons. The crank-shaft is of steel, the fly-wheel boss being $25\frac{1}{2}$ inches in diameter and the journals $17\frac{3}{4}$ inches.

As is usual in German and Swiss engines, Corliss valves are replaced by double-beat drop valves, which give excellent results. The low-pressure cylinders are connected with the condensers, which are exhausted by double-acting air pumps worked from the crank pins. A 92 per cent. vacuum is frequently obtained. The crank-shaft bearings are continuously lubricated by oil supplied by centrifugal pumps, as are also the piston rods by oil-pump driven from the gear shaft. Well-constructed engines, of either of the types we have described, can be worked with a coal consumption of from $1\frac{1}{4}$ to $1\frac{1}{2}$ lbs. per horse power per hour.

Another rather interesting type of engine, of which some examples are

to be found in flax mills, is the high-speed Willans engine, or its Continental counterpart the Belleville engine. This is a triple or quadruple expansion engine, running at the enormous speed of over 300 revolutions per minute. Its general form is seen in fig. 154. The cylinders are superposed, one

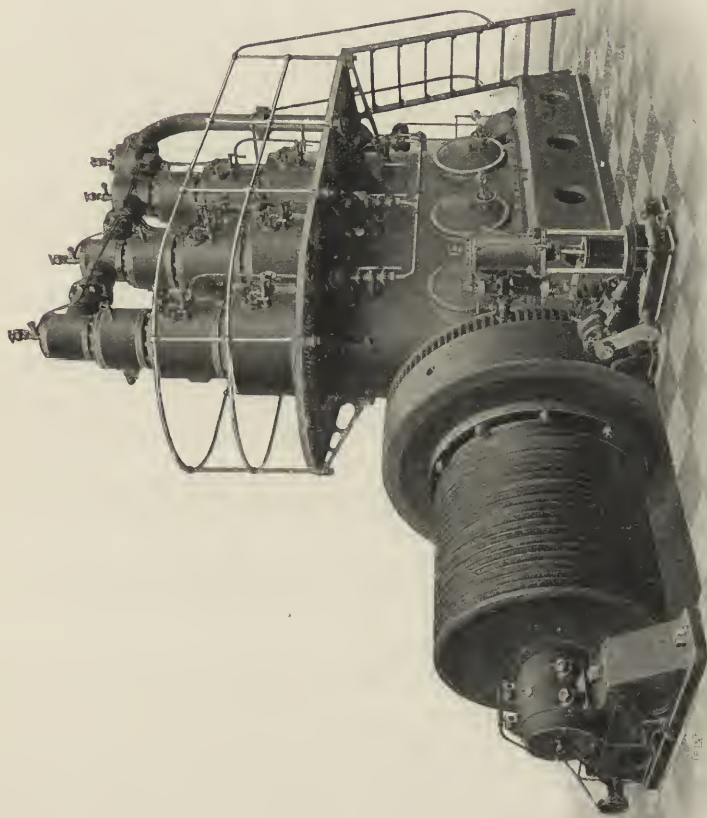

FIG. 154.—The Willans steam engine. As made by Messrs Willans & Robinson, Rugby.

hollow piston rod serving for all and conveying the steam from one to the other. The speed is very steady, about 900 impulses being given per minute. On account of its high speed a very small fly-wheel is required, and all the parts are comparatively small and light, and being made to gauge, may be kept in stock. The whole engine occupies remarkably little space for the power developed. The principal bearings run in oil baths, the others being supplied with oil by circulating pumps.

The accessories usually found in the engine-house comprise steam gauges, to indicate the initial steam pressure as well as that in the receiver; a vacuum gauge, to show the workings of the condenser; a counter, to register the number of revolutions made in a given time; perhaps a speed indicator of the Butler type; and what may sometimes prevent serious accidents, a Tate's electrical stop motion. Instead of or in addition to the latter, a system of electric bells should be arranged with each room, by means of which the engineer may be warned to stop the engine immediately in case of accident. In no industry is a steady drive more essential than in that of spinning, especially of fine numbers. A very useful adjunct to the engine is an instrument known as Moserop's Continuous Recorder, by means of which every momentary variation in the speed of the engine or shafting may be noted, as well as the times of starting and stopping the engine and the rise and fall of the steam pressure. The record is automatically kept upon a travelling paper band wound up at a regular speed by clockwork.

If an engine is required, it should be ordered of sufficient size to develop the power required when cutting off steam at one-fifth stroke. With modern engines the term "nominal horse power" has no meaning whatever. When applied to the old simple condensing beam engine it was of value in comparing the force of engines when calculated by dividing the piston area in square inches by 22, for a simple engine with a cylinder 30 inches in diameter might be said to be of $\frac{30 \times 30 \times .7854}{22}$ = about 70 N.H.P.

The brake or net horse power is now the only really satisfactory basis to go upon in denoting the power of an engine.

In the case of a small engine it may be determined by means of a dynamometer applied to the fly-wheel, or to a special pulley keyed upon the crank or first-motion shaft. In the case of large engines it is sufficiently accurate to deduct the power required to drive the engine alone, as found from the friction diagram, from the total indicated horse power.

Indicators.—Every mill should have a steam-engine indicator, which should be regularly used to detect defects in the working of the valve gear, etc., to show the operation of the steam engine generally, and to ensure economy in the use of steam and oil. The form of the indicator diagram shows the skilled engineer if the steam is being economically employed, if the valve gear and cut-off motions are working well and properly set to shut off and open at the most advantageous moment, if the piston rings and cylinder are worn and passing steam, etc., etc.

The steam-engine indicator is a most ingenious instrument, invented by Watt, and frequently improved and perfected to overcome difficulties

imposed by increased piston speeds and augmented steam pressures. It is a steam cylinder in miniature, containing a piston rod and piston, the head of which has usually an area of 1 square inch. The steam acts only upon the under side of the piston head, its force being measured by the compression of a spiral steel spring, of known strength, which is interposed between the piston head and the cylinder cover. By employing at the same moment twice as many indicators as the engine has cylinders, or by connecting the same instrument in turn with each end of the several cylinders of the engine to be tested, the effective force of the steam during each respective outward stroke may be accurately determined, as may also the value of the vacuum or absence or degree of back pressure during the return journey of the piston. The end of the small piston rod protruding from the cylinder of the indicator is connected with an ingenious link or parallel motion and pencil arm, which latter, being brought in contact with a sheet of paper surrounding a reciprocating drum, describes a boot-shaped figure, the area of which is a sure measure of the force developed by the steam admitted at one end of the cylinder during one revolution and of the additional effect given to the force of the steam, when admitted to the other side of the piston, by the vacuum or reduction in back pressure. In order that the diagrams taken may be of a convenient size, it is usual to employ a stronger spring for high pressures or for the high-pressure cylinder than for the lower pressures of the intermediate or low-pressure cylinder.

For instance, to indicate a compound engine running at 60 revolutions per minute with 100 lbs. per square inch boiler pressure, a spring which will be compressed $\frac{1}{200}$ of an inch for each pound pressure per square inch may be employed for the high-pressure cylinder, and one which is compressed $\frac{1}{100}$ of an inch for each pound per square inch pressure for the low-pressure cylinder. Since, in the Tabor indicator, for instance, the pencil mechanism multiplies the piston motion five times, these compressions are equivalent to $\frac{1}{40}$ inch and $\frac{1}{20}$ inch respectively at the end of the pencil arm. So much for the height of the indicator diagram. Its length depends upon the diameter of the paper drum, usually about 2 inches, and the amount of angular motion given to that drum by the reciprocating motion of the piston of the engine. The proportions of the latter must naturally be reduced to about 5 inches to suit the dimensions of the indicator card. In the case of a low-pressure beam engine, this is easily done by connecting the cord, which turns the paper drum, to a suitable point upon the radius bar. Upon a modern horizontal engine, such as is shown in fig. 155, some sort of reducing gear or pantagraph will be required. That supplied by the makers of the Tabor indicator, comprising cord drum, worm, and worm wheel upon the paper drum, may be applied to indicators of all makes, or a combination of levers and links may be devised to accomplish a like

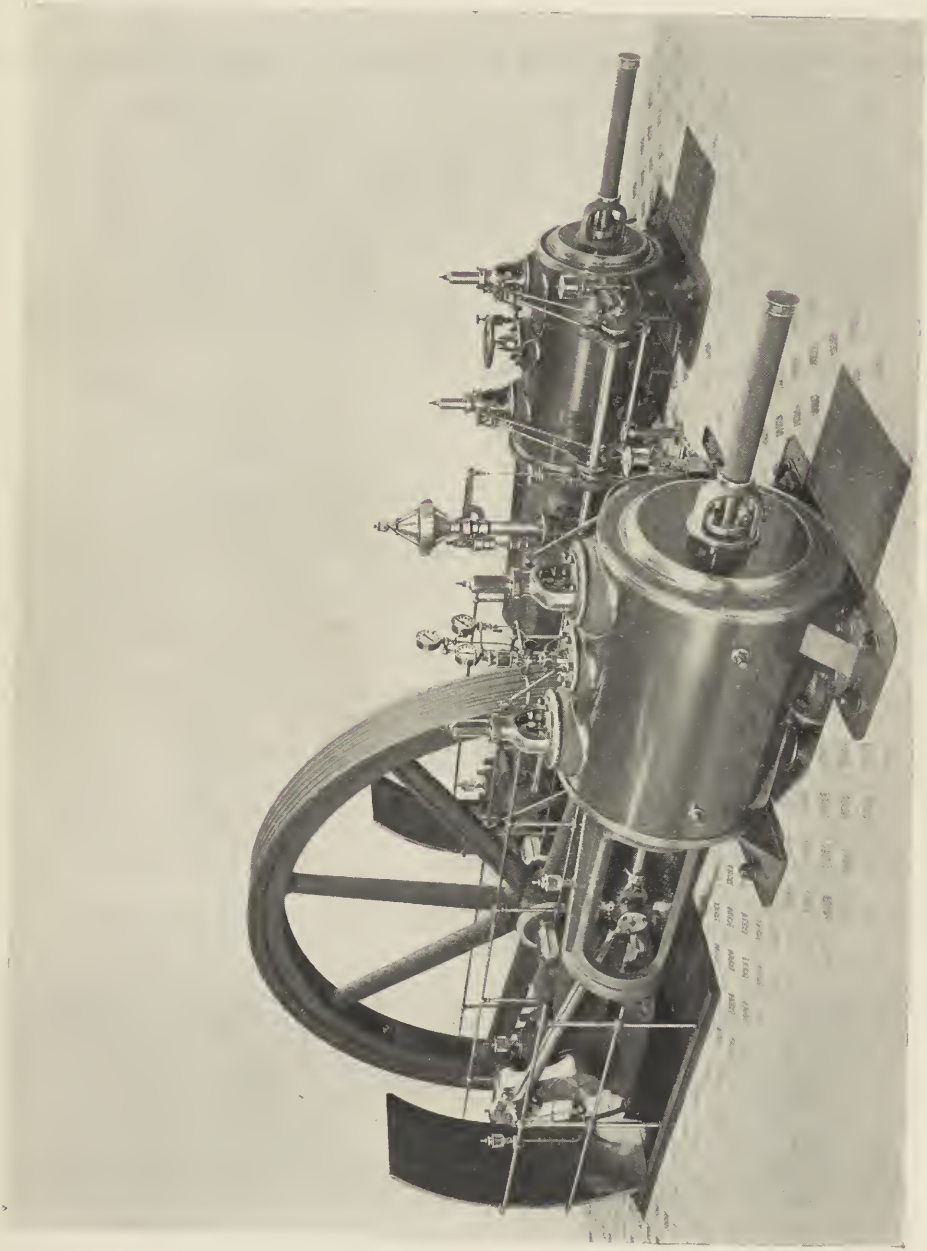

FIG. 155.—Sulzer's horizontal compound mill engine.

result. While the pull of the cord pulls the paper drum round in one direction, a coiled spring is required to bring it back again and take up the slack of the cord upon the return journey of the piston.

The way to use the indicator is as follows :—

Attach the instrument, by means of a screwed coupling provided, with the indicator cock to be found at either end of the cylinders of all modern engines. Unscrew the cylinder cover of the indicator and lift out with it the piston, to the head of which apply a small quantity of cylinder oil and replace, making sure that the spring inserted between the piston head and the cylinder cover is the proper one for the cylinder and engine to be indicated. Oil the pivots and joints of the pencil mechanism from time to time with a light oil—watch oil preferred—and make sure that they work perfectly smoothly and freely. Turn on the steam and heat the apparatus thoroughly. Fix a piece of paper of suitable size around the paper drum, where it is held by the clips provided. All being now ready, take the hook attached to the cord surrounding the cord and paper drum in one hand, and pull out the cord to its full extent in the direction of the reducing gear or the point to which it is to be attached with the cross head of the engine. The correct point of attachment will thus be found to give the paper drum the necessary movement without touching the stops at either end, or a circumferential distance of about $5\frac{1}{2}$ inches. The length of the cord is easily adjusted when required by means of a cord adjuster, such, for instance, as that supplied with the Tabor indicator. A suitable traverse having been obtained, the atmospheric line is first traced by bringing the pencil on the swinging pencil arm in contact with the paper on the reciprocating paper drum, the cocks being, of course, shut. The cocks are then opened, and after any small accumulation of water has been allowed to escape, the pencil is again brought into contact with the paper, and a boot-shaped figure is traced, when the steam may be shut off again, the cord disconnected and the instrument removed to the indicator cock at the other end of the cylinder, where the operation is repeated, the same paper serving for both diagrams, which will be traced at opposite ends of the card. The changing of the instrument from one end of the cylinder to the other may be avoided by connecting together the cocks, at either end of the cylinder, by a pipe, in the centre of which a three-way cock is fitted, to which the indicator may be attached. Moving the handle of this cock to either side puts one or other end of the cylinder in communication with the indicator, and diagrams from both ends may be quickly taken on the same paper without changing the position of the indicator.

In order that the indicated horse-power, as calculated from the area of the diagrams, may be absolutely accurate, it is essential that both ends of each separate cylinder should be indicated at one and the same moment. To do this one must, of course, be provided with two, four, six, or eight

instruments for simple, compound, triple, and quadruple expansion engines. An ingenious electrical attachment may be employed to enable *one* engineer to take all these diagrams at the same identical moment, a result which would be difficult to achieve by a number of men working in concert. It consists of an electro-magnet fixed to the barrel of each indicator and connected by wires to a switch on the battery box which the operator keeps beside him. Springs are used to keep the pencils out of contact with the papers until the current is switched on, when the electro-magnets attract armatures attached to the swivel plates and bring the pencils against their respective paper drums, the steam having been first turned on and the driving cords attached.

When only one instrument is available, the spring must be changed to indicate the high and low pressure cylinders respectively. The spring is, as we said, inserted between the piston head and the cylinder cover. In the Tabor indicator a small thumb-screw with ball and socket joint unites the piston rod to its head, which is in turn screwed to the lower portion of the spring, the upper end of the latter being screwed to the cylinder cover.

Looking first at the form or shape of the diagrams, which have been traced upon the cards, in order to see that the valves have been properly set, that the piston rings are steam-tight, and that the steam is economically employed, we will find that the figures taken from the high-pressure cylinder of a compound engine lie entirely above the atmospheric line, while those from the low-pressure cylinder lie chiefly below it. The height to which the former extends above the atmospheric line indicates the intensity of the initial steam pressure above the pressure of the atmosphere. On measuring this height to the scale of the spring used, it will be found to be less than the boiler pressure, in consequence of condensation in the connecting steam pipes, etc., and it should be the aim of the engineer to reduce this inequality and thereby save coal. The height to which the low-pressure diagram reaches above the atmospheric line indicates the pressure at which the steam was admitted to the low-pressure cylinder, which should be as nearly as possible the same as that at which it left the high-pressure cylinder. The distance to which the low-pressure diagram descends below the atmospheric line indicates the degree of vacuum produced by the condenser, which should, of course, be as nearly perfect as possible.

In either high or low-pressure diagrams the line which encloses the figure at the bottom will be found to be nearly horizontal, and is that traced during the return stroke of the piston when it is pushing the rarified steam before it into the receiver or condenser respectively. At either the right or left hand side of the figure, according to the end of the cylinder considered, it is curved upwards, indicating a rise in pressure, due to the closing of the exhaust port with the object of forming a cushion

of steam to bring the piston to rest at the end of the stroke without shock. The point at which this curve begins, and the height at which it reaches a vertical line bounding the extremity of the figure, indicates if the port has been closed too soon or too late. The line of steam admission and the rise in pressure thus produced mingles in with the line of compression, and it is rather difficult to separate them. If, however, this line, after reaching the vertical line already referred to, again recedes from it before attaining its full height, it may be taken as a sign that the admission of steam takes place too late. If, on the other hand, this line reaches a considerable height before touching the vertical line bounding the end of the stroke, it may be taken that the steam is admitted too early. After the figure has attained its maximum height, the top line, traced during the outward stroke of the piston, should be nearly horizontal, showing that the pressure has been kept up until the cut-off takes place. If this line falls away at once, before the point of cut-off, it shows that the steam is *wire drawn*, or that the steam pipe from the boilers or the valves are of insufficient section to supply the quantity of steam required by the speed and power of the engine. The abruptness of the angle at which the line of steam expansion leaves the line of steam pressure indicates the sharpness of the cut-off, depending in some cases on the quality of the oil with which the Corliss valves are lubricated. The cut-off should, of course, be as sharp as possible. The fraction of the stroke at which it takes place is shown upon the diagram by measuring the distance of the angle of cut-off from the end of the figure and comparing that distance with the total length of the latter. After the point of cut-off comes the expansion curve, which should approach the hyperbolic as nearly as possible. The abrupt fall in the expansion line, near the extremity of the diagram, indicates the point in the stroke at which the exhaust port was opened.

In order that full advantage may be taken of the steam expansion, exhaust should take place as late as possible, but always in time to let the line fall to its lowest position before the end of the stroke or the extremity of the diagram. The line running almost horizontally at the bottom of the figure is the back pressure or vacuum line, and completes the diagram of the cycle of operations.

Defects sometimes met with in the indicator diagram are: Serrations in the steam line caused by the oscillations in the reciprocating parts of the instrument; fall of the expansion curve below the hyperbole, due to a badly-fitted piston or oval cylinder; a loop formed by the admission line and the steam line generally, indicating that the exhaust closes too early in the stroke and that the steam remaining in the cylinder is compressed until it reaches a pressure exceeding that of the boiler, falling again when the steam port is opened.

To calculate the I.H.P., or indicated horse-power, from the diagrams,

we must first measure the average effective pressure as shown by the height of the figure. This may be done with the aid of a Coffin averaging instrument, or merely by measuring the height of the figure at, say, ten equidistant points and taking the true average of these measurements.

In using the averaging instrument above referred to, the tracing point is moved carefully along the line of the figure until the circuit is complete, when the reading of the graduated wheel is taken, representing the area of the diagram. The mean height corresponding with the average effective pressure is, of course, the area of the figure divided by its length.

The other particulars required for power calculation are: The area of the piston and piston rod and the speed of the piston. The area of the piston and rod, which must be taken, under the British system, in square inches, is ascertained by squaring the diameter of the piston or rod respectively in inches and multiplying by the decimal fraction $\cdot7854$. The speed of the piston in feet per minute is found by taking the length of the stroke in feet, or twice the length of the crank measured from the centre of the crank axle to the centre of the crank pin, and multiplying by the number of strokes per minute or twice the number of revolutions. The I.H.P. is then the product of the three factors—*i.e.* the mean effective pressure as obtained from the indicator diagrams, the area of the piston in square inches, and the piston speed in feet per minute, divided by the 33,000 foot pounds taken as the equivalent of one horse-power. In compound and triple-expansion engines this calculation must be made for each cylinder, the mean effective pressure being the average height of the diagrams from both ends taken together, and the results added together to obtain the total I.H.P. of the engine. To be absolutely accurate, the area of the piston rod, if it does not pass through both ends of the cylinder, must be deducted from the area of the piston when calculating the diagram for that end, or, what is simpler, one-half the area of the piston rod deducted from the piston area, and the effective area thus obtained used in calculating both diagrams together as described. When the piston rod passes through both ends of the cylinder its full diameter must of course be deducted from the piston areas. In continental practice the calculations for I.H.P. are similarly conducted, the areas being taken in square centimetres, the pressure in kilogrammes per square centimetre, and the piston speed in metres per second. The basis of horse-power is the moving of 75 kilogrammes through a distance of 1 metre per second. The following conversion factors may be found useful in this connection:—

Pounds per square inch $\times 0\cdot0703$ = kilos. per square centimetre.

British horse power $\times 1\cdot0139$ = force de cheval.

Kilos. per square centimetre $\times 14\cdot223$ = pounds per square inch.

Force de cheval $\times 0\cdot9863$ = horse-power.

With the aid of the indicator, etc., a useful trial may be made to find the efficiency of the coal, boiler, and engine in the following way:—Make sure that all steam valves and joints are tight, and that no steam escapes or is used other than by the engine. Prepare a method of measuring the water used by the boiler during the trial, either a water metre or a reservoir of regular form and sufficient capacity, the contents of which before and after the trial may be accurately calculated. Stop the engine for a few minutes in order that the water level in the boiler may be accurately marked, in order that it may be re-established at the end of the trial. Note also the steam pressure before and after the trial. Start the engine and take the diagrams frequently, say every quarter of an hour during the duration of the trial; note the number of revolutions made during that time by means of a counter, in order that the average speed per minute may be accurately determined. To terminate the trial, the water level in the boiler should be brought up to the same height as at the start, as should also the steam pressure. The coal used may then be noted, as may also the gallons of water used to maintain the water level in the boiler, and the average I.H.P. calculated from the diagrams taken and the average revolutions noted. A gallon of water weighing 10 lbs., the weight of steam used may be easily calculated, as may the pounds of water evaporated per pound of coal and the coal consumed per indicated horse-power and per hour.

To be absolutely exact, the water condensed in the connecting steam pipes should be deducted from the quantity of water introduced into the boiler, as should also any water which, owing to priming of the boiler, goes to the engine with the steam. The amount of priming, if any, may be detected by putting a measured quantity of salt into the boiler and evaporating the water of condensation from the steam piping. The quantity of salt which is found in the latter, in proportion to that put into the boiler and its capacity, will give the quantity of water to be attributed to priming.

CHAPTER XXI.

POWER TRANSMISSION—BELTS, ROPES, AND GEARING—ELECTRICAL POWER TRANSMISSION.

Power Transmission.—The development of power transmission by electricity is of such comparatively recent date that it is only employed in some of the newest mills and in some extensions to existing mills. In the latter case it has generally been adopted by reason of some difficulty in extending existing lines of shafting, owing to distance or mechanical inconvenience. Although it may not be the most economical method of transmitting power over short distances, still it is the only practicable method when a long distance has to be covered, and in every case it is an exceedingly handy and convenient method of power transmission, in that the speed of the driven shaft or machine may be changed at will and at work. The method of its application is as follows:—The power is generated by water, steam turbine or steam engine, as described in our last chapter, and utilised to drive the electric generator or dynamo, which may either be directly coupled or driven by a belt or ropes. The electric current supplied by this latter machine is then available to be conveyed any distance, through copper wires of suitable section, and utilised to impart motion to an electric motor or motors coupled directly to the shafting or machine to be driven, or driving them by means of a belt or ropes. Fig. 156 shows such an arrangement, *i.e.* a Westinghouse motor driving, by means of ropes, a line shaft which is in turn driving some twisting frames. The speed of the motor, and consequently that of the machine which it drives, may be altered by diminishing the voltage pressure or intensity of the current supplied by means of a resistance frame or rheostat.

One of the largest applications of electric driving to textile mills is that recently awarded to the British Westinghouse Co., Ltd., by Messrs Birkmyre Brothers to drive their jute mill on the river Hugli, near Calcutta. The motive power is furnished by steam turbines. The exciter generators, of 20 K.W., are mounted direct on extensions of the turbine shaft. The turbo generators are of 1300 K.W. capacity, and furnish a three-phase current at 440 volts and 25 periods. The greater part of the driving is

done by three 700-horse-power motors running at 290 revolutions per minute, and directly coupled to the shafting.

The direct coupling of the motors to the shafting is the method usually employed, being the least costly. The provision of a small motor for each machine, though convenient, is usually considered to be too expensive.

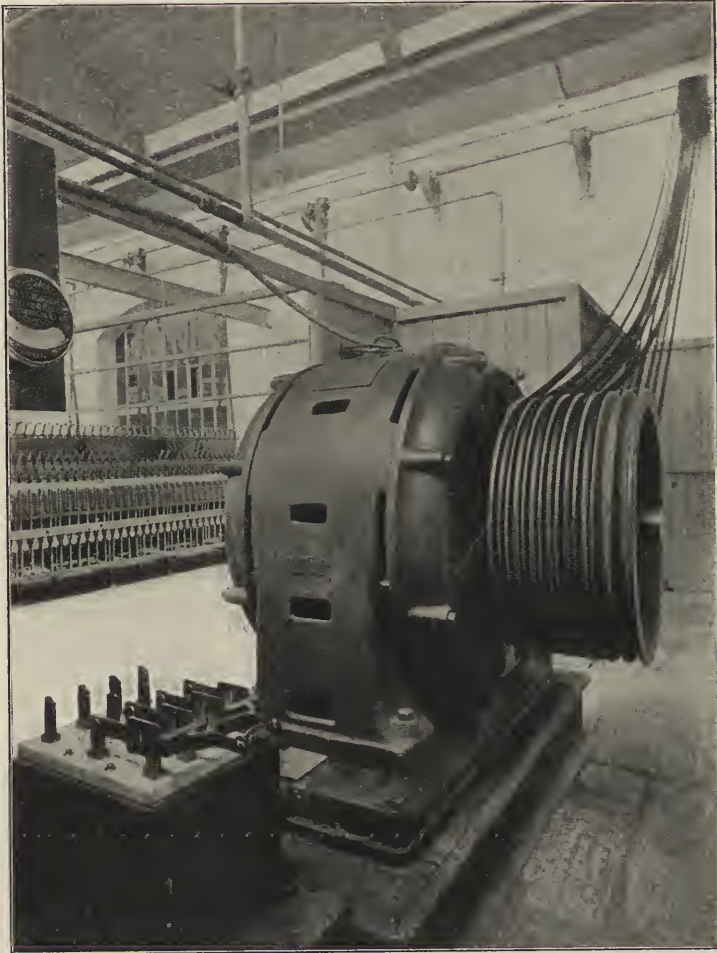

FIG. 156.—Westinghouse polyphase motor operating twisting frames.

Gearing.—The oldest method of power transmission is undoubtedly by means of toothed gearing. It is the only one which can be absolutely relied upon for accuracy, as both belts and ropes are capable of slipping. A great deal of science is required to construct the teeth properly, in order that the friction between them shall be the least possible. The pitch of

the teeth of small wheels is recognised as so many teeth per inch diameter. The diameter of the wheel is measured on the pitch circle, and is equal to the extreme diameter minus the depth of one tooth. The pitch of large wheels for mill gearing, however, is measured along the pitch circle, and is equal to the circumference of that circle divided by the number of teeth in the wheel. For wheels of this class, the thickness of the tooth as measured along the pitch line is equal to the pitch $\times 0.48$. The space between the teeth is therefore $0.52 \times$ pitch. The length of the tooth from the pitch line to the point should equal the pitch $\times 0.30$, and the length from the pitch line to the bottom of the tooth = 0.36 pitch. When such wheels are used to transmit power, one wheel of each pair may be fitted with wooden teeth morticed into the metal rim of the wheel and held by a pin passing through the tail end inside the rim. Such a wheel is called a mortice wheel. Its object is to give smoothness to the drive, and to reduce noise and vibration. With the same object, wheels built up in segments separated by blocks of indiarubber were also used, and later still, helical teeth, extending askew across the face of the wheel or arranged herring-bone fashion. When wheel gearing is used to drive a mill of several storeys, the fly-wheel of the engine is toothed and drives a spur pinion on the second motion shaft. Upon this shaft a bevel wheel gives motion to a vertical shaft, the base of which rests in a huge footstep, which on account of the weight upon it, requires a great deal of attention. The line shafts upon each storey of the mill are driven by bevel wheels, one of them a mortice wheel, from the vertical shaft.

Rope Driving.—In mills of modern construction, and in old mills where old engines have been thrown out and replaced by new ones, wheel gearing for the main drives has been entirely superseded by rope driving, which is much more convenient. The fly-wheel of the engine is grooved for the ropes, the number of which depends upon the power to be transmitted and the manner in which it is to be distributed. A rope $1\frac{3}{4}$ inches in diameter is a very convenient size to use. At a speed of 4500 feet per minute, which is a good average velocity when transmitting power from large rope fly-wheels, a good three-strand cotton driving rope will transmit 45 horsepower, if the diameter of the smallest pulley be not less than 4 feet 5 inches, or thirty times the diameter of the rope. Other diameters of ropes will transmit forces proportional to the squares of their diameters. The power which may be transmitted is also directly proportional to the velocity of the rope in feet per minute, which velocity should never exceed 4800 feet, since at high speeds the tension available for the transmission of power is considerably reduced by the centrifugal action of the rope.

The sides of the groove in which the rope works should be inclined to each other at an angle of about 45° . A very good form of groove which is recommended by Messrs Wm. Kenyon & Sons, Dunkinfield, Manchester,

whose three-strand cotton ropes enjoy a world-wide reputation, is shown in fig. 157.

Their method of setting out the groove as here shown possesses two good qualities, viz., accuracy and simplicity. Referring to the diagram, it will be seen that the first thing to do is to draw a circle the diameter of which corresponds with that of the rope, and then to draw in the central lines both vertically and horizontally. The points A and B are then

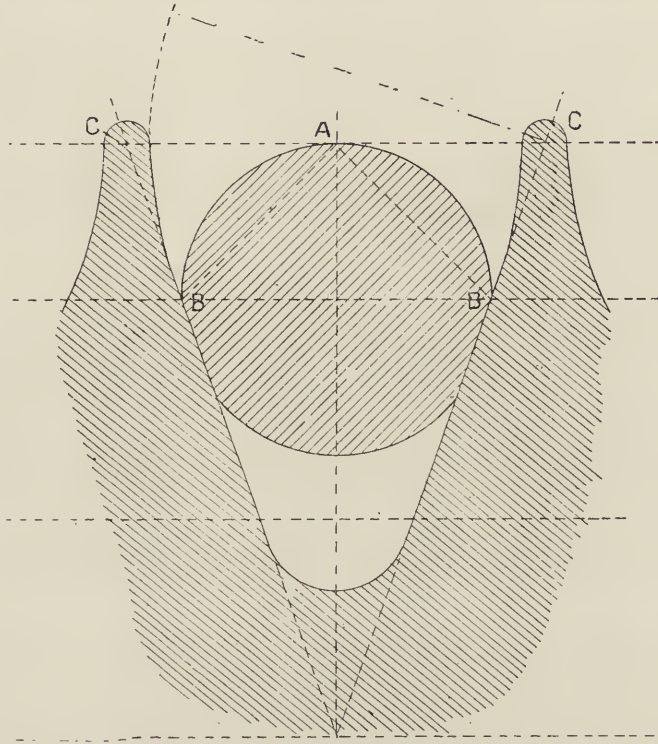

FIG. 157.—Method of setting out groove.

joined, and the length of this line becomes the standard of all succeeding measurements. By measuring off this length from the centre of the circle downwards along the vertical centre line, a centre is found for rounding off the bottom of the groove, and twice that distance along the same line fixes the apex in which the lines passing through B B converge.

The centres for rounding off the mid-feathers, or upper portions of the groove, are situated in a horizontal line drawn parallel to B B through the point A. These centres C are distant from A a space equal to A B.

The rope should be of sufficient diameter to rest on the sides of the groove, and not on the bottom. The resistance to slipping is very great

without wedging, and the weight of the rope helps it to leave the groove without loss of power.

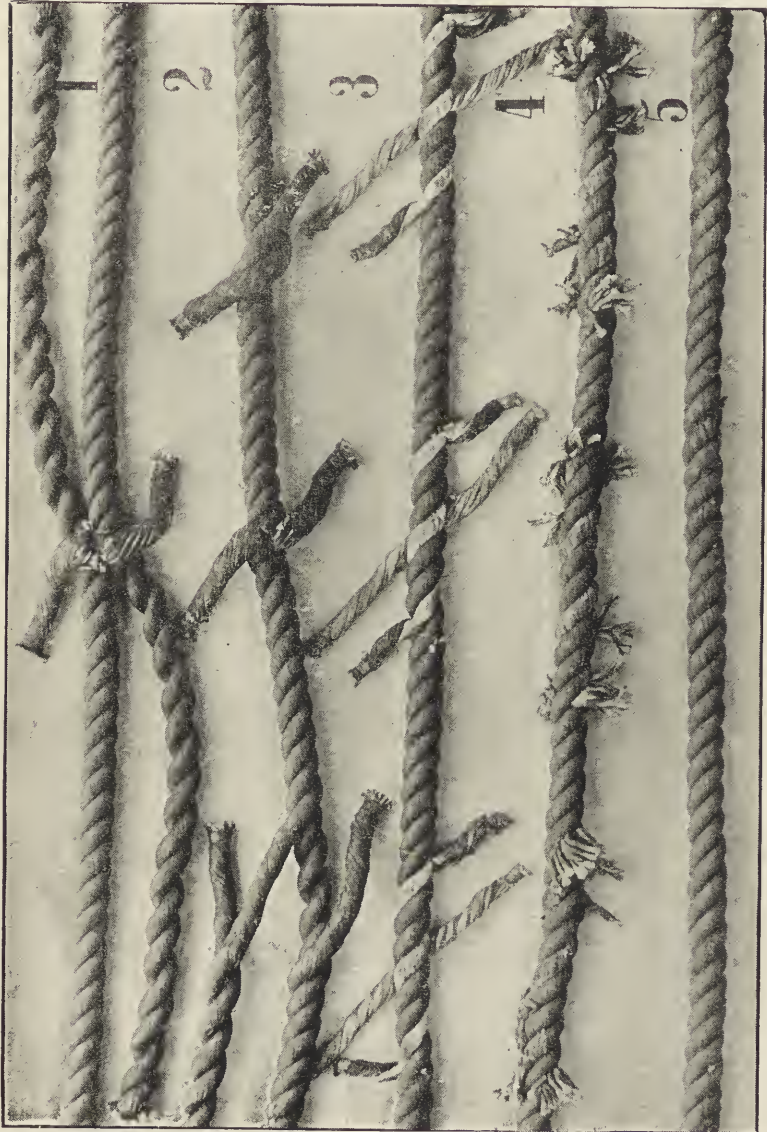

FIG. 158.—Method of splicing driving ropes.

In horizontal or inclined drives the power transmitted is somewhat increased. When the slack side of the rope is on the top, the rope will run more steadily, and be less liable to run or leap out of the groove than

when the slack side is underneath. When starting a rope-drive all the ropes should, if possible, be put on at the same time, to the same length, and consequently at equal tensions. Each rope will then do like amounts of work, and all will stretch alike and in a minimum degree.

The ends of the rope are joined or made continuous by means of a splicing, which should be carefully done by an expert rope splicer. If the splice be clumsily made, that part of the rope will be thicker, and the rope will run unsteadily and have a tendency to leap from its groove.

The method of splicing is shown in fig. 158.

The length of the splicing should not be less than seventy-two times the diameter of the rope, or say 10 feet 6 inches for a $1\frac{3}{4}$ -inch rope. The first operation is to measure off a distance equal to half the length of the splices from each end of the rope after its measurement has been taken with a cord, or by calculation, and the length of the splice added.

Then take out and cut away one strand from each side and whip the ends together at that point as shown in section 1 of the figure. Another strand from one side is then untwisted, and followed up and replaced by a strand from the other side as shown in section 2. The same thing is done with the other side, and the long ends cut off and thinned down by stripping off the outer shell as shown in section 3. These loose ends are then worked in round the strands and through the rope with the aid of a marlinspike, as in section 4, and then the remainders cut off, leaving the splice complete, level and smooth as shown in section 5.

Ropes usually serve to drive a shaft lying parallel to another, both driving and driven pulleys being in the same vertical plane. As seen from

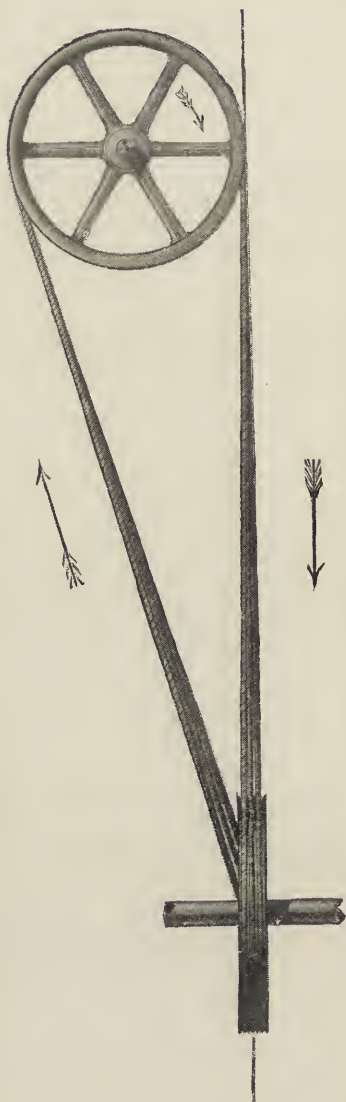

FIG. 159.—Half crossed vertical driving.

figs. 159 and 160, these conditions are not essential, and shafts at right angles to each other may be driven by either a half crossed vertical rope or with the aid of guide pulleys.

Tolerably long centres are a decided advantage to ropes working in the position shown in fig. 159, particularly if the pulleys are of large diameter. Long keyways should be cut in both shafts so that the pulleys may be

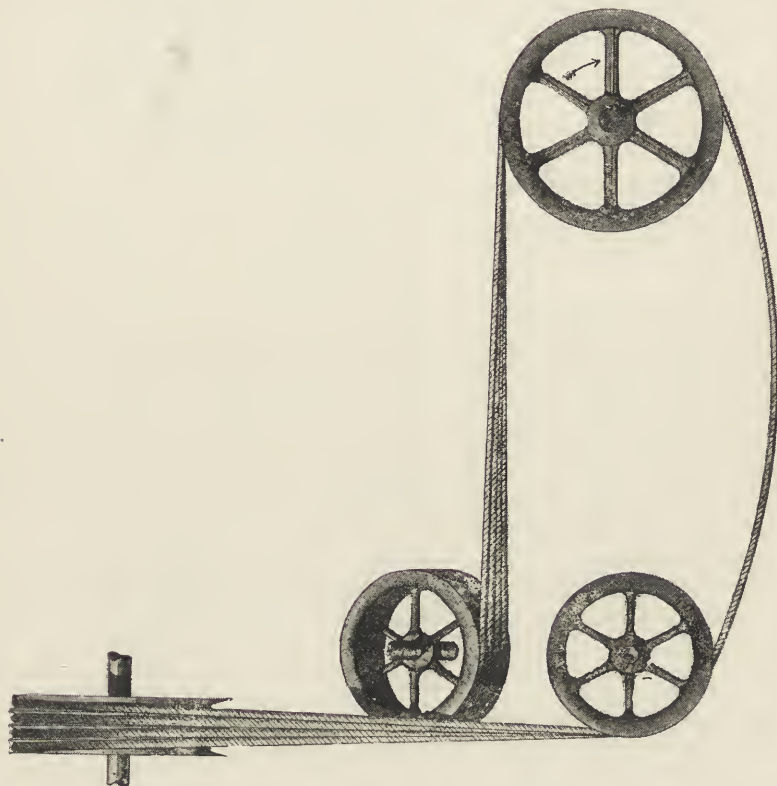

FIG. 160.—Driving with shafts at right angles.

brought into their best driving position, the theory being that the central groove of each pulley on the running-on side should be in the same vertical plane as the face of the other pulley.

Shafts lying at any angle to each other may be driven with the intervention of guide pulleys, as shown in fig. 160, the same conditions as above being observed in placing the guide pulleys in position.

Fig. 161 illustrates an arrangement which has been patented by Messrs Wm. Kenyon & Sons for driving spinning frames, roving frames, twisting frames, lathes and other light mill machinery by means of fast and loose

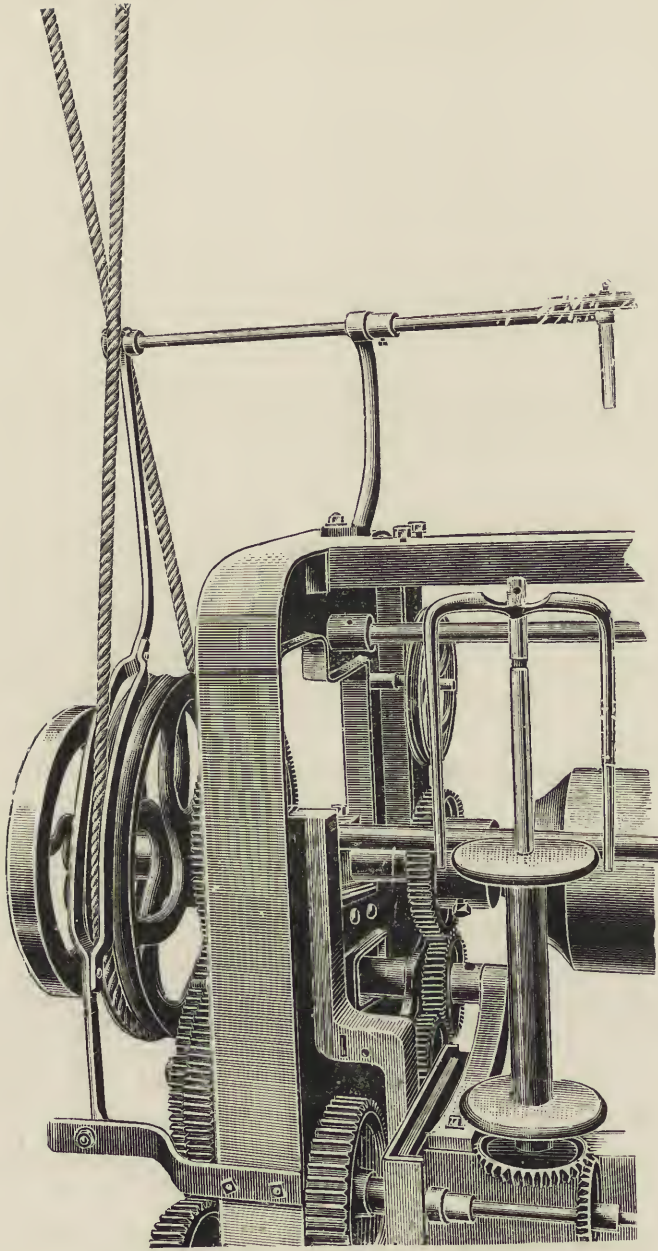

FIG. 161.—Application of rope driving to machinery by patent fast and loose pulleys.

pulleys. The rope is passed from fast to loose pulley by an ordinary fork or belt shifter, which, however, takes the curve of the pulley itself. A $\frac{1}{2}$ -inch cotton rope will in this way do the work of a 3-inch belt.

The American system of continuous driving is only mentioned to be condemned. This method of conveying a considerable force by means of one rope, wound round and round the pulleys and guided from side to side by large jockey pulleys fixed in slides and used as a means of maintaining a regular tension, is most severe upon the rope on account of the useless friction and angular wrench to which it is subjected. Besides, if the single splice breaks, the machinery must be stopped, whereas if a series of ropes be used the loss of one of them for a few hours can usually be borne without danger or inconvenience.

Although cotton is now generally allowed to be the best material for driving ropes, Manila and leather ropes are still used, especially on the Continent.

The machine-made Manila rope manufactured as described in Chapter XVII. is superior to the hand-made, in that it may be had in greater lengths, and is usually composed of finer yarns.

A French firm make a speciality of an 8-strand square and plaited rope for which they claim great flexibility and absence of stretch. Such a rope cannot turn in the groove as round cables frequently do. It used to be considered that the rolling of a rope in its groove tended to equalise the wear and gave the rope a longer life, for which reason the pulleys were often placed slightly out of line in order to induce rolling. The advantage of a turning rope is now denied, and the author's experience, at least as far as cotton ropes goes, tends to confirm this idea.

Leather ropes of buffalo hide are extremely durable on easy drives, but are hard to splice and require frequent tarring. The life of a Manila rope is considerably increased by regular oiling with castor oil, for instance, since, if unlubricated, the friction between the strands, in bending round the pulleys, tends to wear the interior of the rope and reduce its strength.

Belt Driving.—While a rope is prevented from slipping by a wedging action in its groove, a belt drives by reason of its grip or friction on the flat surface of a pulley. The greater the power to be transmitted, the greater must be the area of the surfaces in contact, hence the frequent slipping on pulleys of small diameter, and the reason why their use should be avoided when possible. Inequalities in the surface of the belt permit of the interposition of a body of air between its surface and that of the pulley, and reduce its driving power. This circumstance led to the introduction of the perforated rim pulley, the makers of which, however, lose sight of the fact that the perforations, through which the imprisoned air escapes, reduce considerably the area of the surfaces in contact. When there is perfect contact between belt and pulley and no air cushion, the pressure of the

atmosphere is unbalanced and exerts its full effect. The arc of contact between belt and pulley is increased by having the sag or slack side of the belt on the top, whenever possible, in horizontal and inclined drives. The greater the length of the belt, and also the more alike in diameter the driving and driven pulleys, the better. In no case should the proportion between the diameters of two pulleys working together exceed 6 to 1. The face of the pulley is usually made convex in order that the belt may remain in the middle in consequence of the tendency which a tight belt always has to run to the high side. The convexity should not be less than $\frac{1}{8}$ inch nor more than $\frac{1}{4}$ inch per foot in width. The pulley should be at least $\frac{1}{2}$ inch wider than the belt. About 3500 feet per minute is a good average speed for main driving belts, and about half that for frame belts. When a belt is doing no work, the tension upon both its sides is alike. When the belt is transmitting force the tension of the driving side exceeds that of the slack side by an amount proportional to the force transmitted. The force transmitted thus depends upon the difference in tension between the two sides of the belt and upon its surface speed. If T = the working tension of the tight side of the belt in pounds, t the tension of the slack side in pounds, and V the velocity of the belt in feet per minute, then the force transmitted is equal to $\frac{V(T-t)}{33,000 \times 2}$ horse-power.

The ultimate strength of single leather belting is about 700 lbs. per inch in width, the usual working tension about 110 lbs. per inch in width, and the tension when at rest about 20 lbs. per inch in width. Hence at a velocity of 3500 feet per minute, a single leather belt 1 inch in width will transmit $\frac{3500(110-20)}{33,000 \times 2} = 4.77$ horse-power. Upon this basis the width W of single-leather belting required to transmit any given number of horse-power at any given speed may be determined from the equation $W = \frac{3500 \times \text{H.P.}}{4.77 V}$, where V = the velocity in feet per minute and H.P. = horse-power.

The horse-power required to drive any machine may be determined in the following way:—Pass a strong cord through the hole which is usually to be found in the face of the fast pulley and make a knot or attach something in the inside which will prevent its drawing through. Give the cord a partial or a whole turn around the pulley and attach a Salter's spring balance, by means of which the pull necessary to start the frame may be seen. The tension thus indicated, multiplied by the working velocity of the belt in feet per minute and divided by 33,000, will give the horse-power required to drive the frame.

For mill work, leather is best adapted for ordinary drives in dry rooms at ordinary temperatures, such as preparing rooms, dry spinning rooms, ropeworks, etc. For hot or damp rooms, such as wet spinning rooms, etc.,

the author believes in the use of a reliable brand of camel's-hair belting, which is exceedingly strong and pliable, and is unaffected by changes of temperature, water, steam, etc. It is much lighter than many other textile belts, hence the pull upon the bearings, due to the weight of the belt, is reduced to a minimum, as is also the effects of centrifugal tension. Leather belting should be regularly oiled upon its back with castor oil in order to keep it in good working condition, while camel's-hair belting should be treated with a good belt syrup for a like reason, and also to increase its gripping power. Leather belting should be joined with belt laces, and textile belts by bifurcated rivets or similar fasteners, care being taken that all the joinings run in the same direction, which should be such that, if there be any slippage upon the smaller pulley, the joinings may be subjected to the least injury.

Rules in connection with Rope and Belt Driving.—The following rules in connection with belt and rope drives may be found useful.

1. To find the velocity of a rope or belt in feet per minute, the pulley diameter and the number of revolutions per minute being given :—Multiply the working diameter of the pulley in feet by 3·1416 and by the number of revolutions per minute.

2. To find the number of revolutions of a *driven* pulley, the number of revolutions of the driving pulley and the diameters of both pulleys being given :—Multiply the number of revolutions of the *driver* by its diameter, and divide by the diameter of the *driven*.

3. To find the diameter of a *driving* pulley, the diameter of the driven pulley and the revolution per minute of each being given :—Multiply the diameter of the driven pulley by its speed, and divide by the speed of the driver.

4. To find the diameter of a *driven* pulley to make any given number of revolutions, the diameter and speed of the *driver* being given :—Multiply the diameter of the driving pulley by its speed, and divide by the required speed of the driven pulley.

5. To increase or diminish the length of rope or belt for a change of pulleys :—Multiply half the difference in diameters of the pulleys by 3·1416, and the result will be the length by which the belt or rope must be lengthened or shortened.

6. To find the length of belt or rope necessary for any open drive :—To twice the distance from centre to centre of shafts add the amount required for the joint or splicing, and also the product of half the sum of the pulley diameters and 3·1416.

Thus the length of $1\frac{1}{2}$ -inch rope necessary for a drive where the distance from centre to centre of shafts is 60 feet, driving pulley 24 feet diameter, and driven pulley 4 feet in diameter, is $(2 \times 60) +$

$\left(\frac{1\frac{1}{2} \times 72}{12}\right) + \left\{ 3.1416 \times \left(\frac{24+4}{2}\right) \right\} = 120 + 9 + 44 = 173$ feet, allowing 9 feet, or seventy-two times the diameter of the rope, for the length of the splicing.

The length of belting required for a crossed drive depends so much upon the relative diameters of the pulleys that it is better to determine the length of the belt by actual measurement with an inextensible cord.

Pulleys and Bearings.—Rope pulleys are always of cast iron. Belt pulleys are either of cast iron, built up of wrought iron with a cast iron centre, or of wood. Wrought iron pulleys are less liable to breakages, and much safer, especially when running at high speed. Wooden pulleys can only be used in dry rooms, and are liable to warp and become slack upon the shaft. Pulleys should always be of the "split" pattern, or made in two halves to facilitate mounting upon the shafting.

For heavy drives they should always be keyed on. For light drives it is usually sufficient to tighten them on, if they be bored out a sharp fit for the shafting.

The shafting is usually of wrought iron or steel, and is either solid or hollow, the latter being stronger, weight for weight, and cheaper, if the cost of transport is high. It is subjected to two strains—*i.e.* that produced by torsion, and the other due to the weight of the pulleys and pull of the belts and ropes. The amount of the first depends upon the length of the shaft. The second is overcome by the provision of bearings at frequent intervals, and when possible, by balancing the strain of the belt upon either side of the shaft. When the shafting is merely used to transmit power, the distance apart of the bearings may be obtained from the formula $L = 5\sqrt[3]{d^2}$, where L = the length in feet between the supports and d the diameter of the shaft in inches. If the shaft carries pulleys, etc., the formula $L = 4.8\sqrt[3]{d^2}$ should be used. A 3-inch line shaft will transmit 45 horse-power when running at 150 revolutions per minute. The power transmitted by shafting varies directly as its velocity and as the cube of its diameter.

INDEX.

- ACID in oil, 296.
 Adamson's flanged seam, 320.
 Agave fibre, 2.
 Air supply per head and per hour, 302, 303.
 Alkalies in spinning trough, 180.
 American hemp, 16.
 Ampère, 301.
 Anemometer, 303.
 Angle of beam, 171; card pins, 77; rollers, 171, 289.
 Anti-priming pipe, 320.
 Apron-head, 101, 104.
 Arc lamps, 301, 302.
 Area of safety valve, 328; piston head and rod, 340.
 Arrangement of flues, 322.
 Automatic bobbin dragging motion, 157; feeder, 80, 81; self-registering hygrometer, 305; spinner, 120, 123, 127; sprinklers, 314; stop reel, 210.
 Average sort or lea, 57.

 BABCOCK & WILCOX boiler, 318, 321.
 Back turn, 234.
 Baleing yarn, 223.
 Balling machine, 250.
 yarn, thread and twine, 222, 247.
 Banding, 183.
 Band tying, 183.
 Barring engine, 332.
 "Base," 13.
 Batching jute, 22; mixture, 23; waste, 196.
 Beaded yarn, 60.
 Beads, 175.
 Bead-yarn, 235.
 Belgian paquet, 59.
 Bell motion, 65; for reel, 207.
 Belt driving, 350.
 lacing and fastening, 352.
 syrup, 182.
 Binder twine, 128.
 Black yarns, 60.
 threads, 184.
 tick, 45.
 Blake thread, 232.

 Blow-off or mud-cock, 322.
 Board of Trade unit, 301.
 Bobbin lead, 139.
 Bobbins, 12.
 Boilers, 318, 331.
 Boiling yarn, 4.
 Bolt rope, 262, 281.
 Book frame for ramie, 53.
 Boss or drawing roller, 68.
 Boss roller traverse motion, 100, 104.
 Bouncing spindles, 289.
 Bourdon pressure gauge, 328.
 Boxwood, 174.
 Boyle's process, 7.
 Braquing, 12, 13.
 Brake horse-power, 334.
 Breadth of gills, 115.
 Breaker card, 76, 77.
 Breaking and scutching flax and hemp, 4, 5.
 strain, 219.
 up, 76.
 Breast plate, 154.
 wheel, 316.
 Brook and Doxey's differential motion, 142.
 Brownell machine, 233.
 Builder chains, 170.
 change motion, 144, 146.
 Building cops on flyer frames, 170.
 Built up crank-shaft, 332.
 Bulking, 118.
 Bunching yarn, 218.
 Bundling press, 220.
 yarn, 218.
 Butler's speed indicator, 334.

 CABLE laid ropes, 261.
 Cabled thread, 234.
 Cablets, 262.
 Cabling, 226.
 Calorifuge, 331.
 Camel's-hair belting, 181, 351, 352.
 Candle power, 301.
 Capacity of fans, 303; of gills, 113.
 Capstan wharve, 173.
 Carbon brushes, 301.
 Card, 84.

- Card clothing, 90.
 doffer, 84.
 doffing knives, 87.
 filleting, 90.
 fires, 88.
 staves or lags, 76, 90.
 waste, 59.
 workers, 85.
- Carding, 80, 85.
 short waste, 196, 198, 200.
 twine, 242.
- Carpet thread, 251.
- Carter's system of card room ventilation, 309, 313.
- Casting motion, 38.
- Catch bar and dogs, 32, 38.
- Cellulose, 7.
- Chain bar drawing frame, 97, 98, 105.
 leasing, 210.
- Chambering, 174.
- Changers, 40.
- Changing index and builder pinions, 151.
- Channel, 32.
- Cheap weft yarn, 60, 61.
- China-grass, 3, 7, 17.
- C. I. F. and C. and F., 17.
- Clarke's water softener, 324, 325.
- Cleaning Manila hemp, 6.
 New Zealand hemp, 5.
- Clock system, 70.
- Closed stand, 167.
- Closing machine, 268.
- Coal burnt per square foot of grate area per hour, 319.
 consumption per I. H. P. per hour, 332.
 gas, 301.
- Coffin's averaging instrument, 340.
- Coiling ropes, 284.
- Cold water spinning, 179.
- Combe's brush and doffer machine, 36 ;
 stripper bar machine, 37.
- Combined hackler and spreader, 73.
- Combing machine, 115.
- Conductor on under side of silver plate, 100, 104.
- Conductors, 65, 66.
- Cones, 142, 143.
- Continental yarns, 59, 81.
- Continuous rope drive, 350.
- Contraction by twist, 275.
- Cooling mixture, 294.
 yarn, 214.
- Cop winding, 210.
- Cost of dressed line, 57, 58 ; of machinery, 49 ; of production, 60.
- Cotton ropes, 350.
- Cotton's brush and doffer hackling machine, 35 ; end comb, 51 ; head lifting motion, 35 ; stripper rod machine, 37.
- Courtrai flax, 14.
- Crimped sliver, 118.
- Cross-reeling, 207.
- Crown flaxes, 12.
 wheel, 140, 149.
- Crushes, 66.
- Cuts per spindle, 185.
- Cyclone depositor, 307.
- Cylinder oil, 294.
- DAMPING roller, 134, 161.
- Dead weight safety valves, 328.
- Decorticating agave fibre, 3 ; Manila hemp, 6.
- Decortication and degumming of ramie, 6.
- Delivery roller, 68.
- Devil card, 76, 77.
- Dew point, 305.
- Dew-retting, 4.
- Diameter of fluted roller, 287 ; hackle pins, 46 ; spindle blade, 170 ; spindle neck, 170.
- Differential motion, 140, 149.
- Dimensions of spinning bobbin, 175.
- Disc and scroll, 146, 147.
- Distance from nip of roller to thread plate eye, 172 ; of bearings apart, 353.
- Dobson's cut-off gear, 332.
- Doffing, 176.
 spinning frames, 157.
- Doosche's brush and doffer machine, 37.
- Double back shafts, 102.
 beat drop valves, 332.
 cuts, 209.
- Doubling, 95, 111.
 winding, 228.
- Draft calculation, 69, 129.
 gearing on spinning frame, 177.
 of card, 89 ; of drawing head, 92.
- Drafting, 95.
- Draining heating pipes into boiler, 327.
- Draught of chimney, 330.
- Drawing frame gearing, 99, 103.
- Dressed line numbers, 55.
- Drieband, 13.
- Drosophore humidifier, 305.
- Dry air, 305.
 spinning frame, 153.
 frame conductors, 154.
 frame flyers, 155.
 frame for jute, 156.
- Dry spun tow yarns, 93.
- Dust removal, 299.
- Dutch flax, 15.
- Duty on fibre, 19.
- Dynamo, 301.
- Dynamometer, 334.
- ECONOMISER, 322 ; pipes required for, 323.
- Effective circumference of fluted rollers, 177.
 heating surface, 321.
- Efficiency of boiler and engine, 341.
- "Eighteen," 54.
- Electric driving, 342, 343.
 light, 301.
- English yarn numbers, 133.
- Erskine's ender, 51.

- European hemp, 2.
 Evaporative power of coal, 319.
 Eve's anti-friction washers and nuts, 41.
 FAIRBAIRN'S brush and doffer hackling machine, 37.
 Fallers, 62, 64.
 Faller ends, 100.
 guides, 62.
 Fancy yarns, 235.
 Fast and loose pulleys in rope driving, 349, 350.
 Favourable climatic conditions to spinning, 297.
 Feed rollers, 105.
 Feeding card, 80, 81.
 the boiler, 326.
 Fibre selling conditions, 17.
 Fil ondulé, 235.
 Filler, 40.
 Filling engine, 28.
 Fine carding, 80.
 Finisher card, 80.
 Fire bars and grate, 320, 330.
 brigade, 315.
 Firing the boiler, 329.
 Flash point of oils, 295.
 Flat dressing frame, 52.
 hemp ropes, 262.
 Flax buying, 11.
 cut line, 25.
 exports, 19.
 for thread, 232.
 plant, 1.
 ripple, 2.
 sorting, 54.
 spinning spindles, 10. -
 Flemish flax, 14.
 Flutes per inch, 172.
 Fluting indiarubber and guttapercha bosses, 287.
 machine, 287.
 spinning frame roller, 286, 288.
 Flyer, 172.
 eyes, 169.
 lead, 139.
 Fly-rope, 275.
 F.O.B., 17.
 Force de cheval, 340.
 draught for boilers, 330.
 transmitted by ropes, 344.
 Foreboard machine, 262.
 Forehard, 234.
 Foreturn machine, 262, 272.
 Form of rope groove, 345.
 Forming machine, 265.
 tube, 282.
 French dry spuns, 225.
 flax, 15.
 hemps, 16.
 paquet, 59, 217, 224.
 Friction diagram, 334.
 Friesland flax, 15.
 Full white bleach, 4.
 GALLOWAY tubes, 320.
 Gamble's push-bar drawing head, 105.
 Gas burners, 301.
 Gearing of card, 88, 92.
 German flax, 58.
 Giffard's injector, 326, 327.
 Gill rivets, 64.
 spinning, 121.
 for thread yarns, 232.
 frame twist calculation, 134.
 stocks, 64.
 Gilling twine, 251.
 Gills, 112, 114.
 Girard, Philippe de, 9.
 Glaisher's factors, 305.
 Glazing threads, 247.
 Glow lamps, 301.
 Good pinning, 64.
 Goodyear lock stitch thread, 232, 233.
 Gradation of hackles, 46, 47.
 Graphite, 294.
 Greases, 294.
 Green's economiser, 323.
 Grooved boss rollers, 291.
 Grooving, 320.
 Grouping of machine hackles, 48.
 Growing ramie, 3.
 Gulped sliver, 64.
 Gum on hackle pins, 46.
 Gusset plates, 320.
 Guttapercha rollers, 171.
 HACKLER'S breakings, 55.
 Hackle-setters, 286.
 Hackling shop ventilation, 302.
 Half crossed rope drives, 348.
 Hairy rove, 304.
 Hand-dresser's tools, 30.
 Hand-dressing, 30, 31.
 Hand measuring reel, 259.
 Hand-scutched flax, 14.
 Hank drying, 213.
 polishing, 244.
 sizing, 244.
 Hard water, 324.
 Haul pulleys, 233.
 Hauls, 262.
 Hawser-laid rope, 261.
 Head of hackling machine, 32.
 of water, 327.
 Heavy spreading system, 116.
 Heat of furnace gases, 322.
 Heated journals, 293.
 Heating, 300.
 and ventilation, 298.
 Height of thread plate, 172.
 Hemp prices, 17.
 softening, 24.
 yarn prices, 224.
 High and low water whistles, 327.
 Hoff's flaxes, 12.
 Holder, 32.
 Hollow shafting, 353.
 Horizontal engine, 332.

- Horner's hackling machine, 32; head wheel, 32; improved lifting motion, 37; stripping rod machine, 36.
 Hours of labour, 59.
 House machines, 262.
 Humbug, 167.
 Humidity in hackling shop, 48; in the preparing room, 119; of atmosphere, 304; of spinning room, 185.
 Huglo's ventilating system, 309.
 Hydrometer, 295.
 Hygrometer, 185.
- INCANDESCENT** lamps, 301, 302.
 Indian hemp, 16.
 Indiarubber belts, 181.
 rollers, 17.
 Indicated horse-power, 339, 340.
 Indicator diagrams, 338.
 springs, 338.
 trials, 296.
 Indicators, 334.
 Induced draught for boiler, 330.
 Intersection, 47.
 Inverted cylinder vertical triple expansion engine, 331.
 Invoice book, 21.
 Irish flaxes, 14.
 hand-scutched flax, 14.
 Irons, 169.
 Italian hemp, 16.
- JACQUARD** thread, 251.
 Jockey rollers, 102, 105.
 Jute, 3, 10.
 marks, 17.
 yarn prices, 224.
- KEEPING** stock, 60.
 Kestner's humidifying system, 306.
 Kilowatt, 301.
 Knee bend, 76.
 Knifing, 21.
- LAMPS**, 301.
 Lancashire boiler, 319.
 Lap feeding, 94.
 Lawson's drawing head, 68; gill spinning machine, 128.
 Laying block, 234.
 dust, 300.
 machine, 268.
 on, 176.
 top, 274.
 Lea of yarn, to find, 217.
 Lead of faller, 64.
 Leasing, 209.
 Leather belting, 351.
 pressing rollers, 101.
 ropes, 350.
 Leesou's universal winder, 251.
 Left hand twist, 174.
 Length of a thread, 215; "bell," 65; gill pins, 113; Lancashire boilers, 320;
- rope splices, 347; rope walk, 262; safety valve lever, 328, 329; slides, 291; spindles, 135, 173; spindle blade, 170; spindle butt, 170; spindle neck, 170.
 Lessom, 262, 282.
 Level yarn, 215.
 Leverage, 66, 67.
 Licking up, 118, 304.
 Lift of safety valve, 328.
 Lifts of head per minute, 49, 50.
 Lighting, 300.
 Line of pressure, 101.
 Line store, 56.
 Lines of spinning frame, 171.
 Lining-up, 289.
 Locock's economiser, 323.
 Long and short reel, 205.
 Longitudinal stay bolts, 320.
 Loose conductors, 66.
 Lot-book, 21.
 Lubrication, 292.
 Lubricators, 296.
- MACERATION**, 180.
 Machine sheets, leathers, hackles, brush and doffer, 34, 35.
 tows, 49.
 McKay thread, 232.
 Magnetic water gauge, 328.
 Making a mix, 61.
 Mangle wheel, 132.
 Manhole mouthpiece, 320.
 Manila hemp, 2, 6, 10, 16.
 ropes, 350.
 Material required per bundle, 59.
 Mauritius hemp, 2, 16.
 Maximum yield in machine hackling, 44.
 Mechanic shop, 285.
 Mechanics, 285.
 Meldrum furnace, 320.
 Metric system of yarn numbering, 159.
 Mill building, 297, 298.
 chimney, 300.
 gearing, 343.
 Mixing flax, 60, 61.
 Morning starts, 182.
 Mortice wheels, 344.
 Moscrop recorder, 334.
 Motive power, 316.
- NAP** extractor, 54.
 Natural air drying, 211, 213.
 Neck-rail, 173.
 Net horse-power, 334.
 New brasses, collars, and spindles, 289.
 New Zealand hemp, 2, 5, 16.
 Nibs, 264.
 Noil spinning, 193.
 Noils, 115, 193.
 Nominal horse-power, 334.
- OHM**, 301.
 Oil gas, 301.

- Oils, 292.
 One-doffer card, 87.
 sliver per head, 111.
 Open stand, 167.
 Opening hard waste, 194, 195.
 Organs of the card, 89.
 Output of dynamo, 301.

 PATENT automatic screwing for hackling machine, 44.
 Pectose, 7.
 Pernau and district flax, 13.
 Piecing out, 26.
 up, 176.
 Piling yarn, 221.
 Pirrie's frame, 163, 164.
 Pitch-circle of wheel, 344.
 Pitch of frame, 171.
 of screws, 115.
 Plenum method of ventilation, 299.
 Poker rods, 170.
 Polishing thread and twine, 241.
 Porter yarn tester, 217.
 Position of thread plate, 171; of wharve, 170.
 Power required to drive machinery, 351;
 to drive spinning frames, 156.
 of crown-wheel, 148; of shafting, 353.
 transmission, 342.
 transmitted by belts, 351.
 Precautions against fire, 314.
 Prepare for ramie, 8.
 Preparing room constant numbers, 119.
 system, 106, 111.
 Press-bunches, 220, 221.
 Pressing rollers for preparing, 68.
 Pressure in atmospheres, 328; in kilogs.
 per centimetre carré, 328.
 on drawing rollers, 66, 67; on spinning rollers, 167, 172.
 gauge, 327.
 Prices of cords, lines, and twines, 260.
 Projection, 171, 289.
 Proofs, 215.
 Proportions of wheel teeth, 344.
 Protection duty, 59.
 Pulling flax, 2.
 Push-bar drawing head, 91.

 RAMIE, 3, 6, 10.
 preparing, 120.
 spinning frame, 161.
 Randing twine, 252.
 Reach on dry spinning frame, 153.
 Reaches, 114, 172.
 Reaper yarn, 128.
 Reeler's knot, 209.
 Reeling, 205, 208.
 Register plate, 266.
 Relative speeds of card rollers, etc., 89.
 Renewing teeth in mortice wheels, 286.
 Repairing screws, 291.
 Repairs to spinning frames, 288, 289.
 Rest of head, 34.

 Retting flax and hemp, 3, 4.
 Rewinding head, 259.
 Rhea, 3, 6.
 Right-hand twist, 174.
 Ring bobbins, 162.
 push-bar drawing-frame, 105.
 Rings for ring spinning, 163.
 "Rise," 13.
 Roller washers, 66.
 Roof reservoir, 298.
 Rope construction, 261.
 driving, 344.
 groove, 345.
 pulleys, 353.
 tow, 193.
 yarn, 93.
 yarn numbers, 133.
 yarn spinner, 131.
 Rotary head, 90, 91.
 Rougher's tools, 26.
 Roughing, 26, 27.
 shop ventilation, 302.
 Rove, to change weight of, 117, 118.
 bobbin winding, 139.
 stock, 152.
 Roving bobbins, 137.
 frame, 135.
 frame flyers, 136.
 Rubbers, 68, 69.
 Rules for belt and rope driving, 352; for rope makers, 279.
 Running a hackling machine, 38.
 Russian flax and hemp exports, 12.
 flax and hemp laws, 12.
 flaxes, 11, 13.
 hemp, 12, 16.
 tows, 11.
 weights, 14.
 Rusty boilers, 326.

 SADDLE, 167.
 Safety devices, 92.
 pin, 104.
 stairway, 315.
 valve, 327.
 Sag of ropes, 346.
 Saturated air, 305.
 Scale prevention, 326.
 in steam boilers, 324.
 Scoring rollers, 288.
 Scotch spyndle and yarn numbers, 133.
 yarn table, 217.
 Screws, 62.
 Scutcher, 21.
 Self-oiling bearing, 296.
 necks, 156.
 Series, 302.
 Setting bobbin traverse, 302; breaker cards, 78; conductors, 112; fallers and screws, 104; guide pulleys, 182; of cards, 86; of steam boilers, 322; the hackling machine brush, 35; the intersection of hackling machine, 49.
 Shafting, 353.

- Shed construction, 300.
 Shift in machine hackling, 45.
 Shiry yarn, 60.
 Shoe threads, 232.
 Shop twines, 236.
 Short nips, 91, 115.
 drafts, 111, 177.
 Shroud-laid rope, 261, 262.
 Single parallel, 302.
 row machine hackle, 46.
 Sirocco fan, 330.
 Sisal hemp, 2.
 Site for mill, 297.
 Size of boiler flues, 322.
 in spinning trough, 180.
 Sizing threads and twines, 241.
 Skewing threads, 251.
 Slack slivers, 65.
 Sliver formation, 65.
 lap machine, 84.
 Slubbed yarn, 236.
 Slumberger comb, 115.
 Society wages, 56.
 Softening threads, 245.
 Soil for flax, 1.
 Sorter's complement, 56.
 "ten," 54.
 tools, 54.
 Sorting operations, 55.
 raw fibre, 20.
 Sowing flax, 1.
 Specific gravity of oils, 295.
 Speed counter, 334.
 of card cylinder, 76; card strippers,
 78, 79; hackling machine brush, 50;
 doffer, 50; sheets, 49, 50; ropes,
 344; roving frame bobbins, 132;
 roving frame spindles, 136, 138;
 spinning-room shaft, 182; spinning
 spindle, 155, 181.
 Spindle banding, 170.
 foot, 135, 173.
 tapes, 170.
 Spindles in roving frame, 135.
 Spinning bobbin, 174.
 drafts, 158, 160.
 frame quadrant, 169.
 frame reaches, 172.
 room belting, 181.
 room cages, 187.
 room oiling, 184.
 short waste, 201, 203.
 trough, to prevent escape of steam from,
 186.
 Spiral drawing frame, 95.
 Splash-board, 186.
 Splicing ropes, 346, 347.
 Split drum winder, 128, 226.
 Spool winding, 226.
 Spooling sewing threads, 252.
 Spread-board, 62, 63.
 Spreading, 70.
 Spring pressers, 240.
 wire, 67.
 Stacking, 26.
 Standard soap solution, 326.
 Starch or dressing, 245.
 Steam, preventing escape of, from spinning
 trough, 186.
 boiler, 318.
 dome, 320.
 engine, 331.
 engine indicator, 334, 337.
 pipes, 331.
 turbine, 318.
 Steeping boxwood bosses, 287.
 flax in the Lys, 4.
 jute, 4.
 Step rail, 173.
 Stocking raw fibre, 20.
 Storing yarn, 211.
 Strand formation, 264.
 Stranding machine, 266.
 Strength of ropes, 262.
 Stripper cocks, 36.
 rods, 36.
 Strippers, 85.
 Structure of vegetable fibre, 7.
 Sturtevant ventilating system, 299.
 Superheaters, 330.
 Sweeting on economiser pipes, 322.
 Swing rail, 133.
 spinning frame, 155.
 Switch, 30.
 Systems, 95.
 TAILOR's thread, 251.
 Tapes for spindle driving, 184.
 Tare allowed on flax, 18.
 Tarred ropes, 262.
 Tarring machine, 262, 263.
 ropes, 263, 264.
 Tate's electric stop motion, 334.
 Teak, 175.
 Tempering drags, 157.
 Testing for hard water, 324, 325.
 for strength, 217.
 oils, 295.
 Theory of regular spreading, 71.
 thread construction, 235.
 yarn construction, 235.
 Thread for sole sewing, 232.
 plate, 168.
 plate eyes, 168, 290.
 to test twist of, 217.
 Threading flyer, 136.
 Threads per strand, 279, 282.
 Three-wire system, 302.
 Throw-off motion, 72.
 Throwing-out motion, 38.
 Tin cylinder, 173.
 Tipple box, 39.
 press, 40.
 Tippling, 39.
 up, 31, 32.
 Top cart, 275.
 Total doublings, 95.
 drafts, 95.

- Touch pin, 27.
 Tow box, 35.
 catcher, 37.
 combing, 115.
 mix, 93.
 mixing, 93.
 Traveller, 262, 265.
 Trawl twine, 237.
 twine spinner, 129.
 Turbines, 316-318.
 Turn off, 181.
 Turning hackles into group, 49.
 Turns per inch twist, 177.
 Twist calculation, 161, 130.
 constant number, 133, 139.
 for rope yarns, 133; for twines, 236;
 in rope, 275; in rove, 137, 138; of
 flax, hemp, jute, and tow yarns, 133.
 pinion, 137, 138.
 Twisting, 226.
 on ring frame, 161, 162.
 sewing threads, 232.
 Two-piece saddle, 168.

 UNIVERSAL winder, 251.

 VACUUM method of ventilation, 299.
 Ventilation of hackling machine room, 314.
 Vibrating spindle, 289.
 Volt, 301.

 WALLOON flax, 15.
 Warp winding, 205.
 Waste in yarn production, 59.
 spinning, 188.
 Water column, 303.
 gas, 301.
 level gauge, 327.
 power, 316.
 press, 327.
 pressure due to head, 298.
 purifiers, 326.
 retting, 4.
 turbine, 316, 317.

 Watering spinning rollers, 187.
 Waterproof aprons, 186.
 Watts, 301.
 Wear of builder plates, 290.
 Weeding flax, 2.
 Weigh-off book, 21, 56.
 Weight of yarn, 221, 222; of card sliver,
 87; of drags, 169; of one hank of
 yarn, 216; on safety valve lever, 329;
 ropes, 282, 284; steam required per
 I.H.P. per hour, 319.
 Weild's thread spooling machine, 255.
 Wet spinning frame, 165.
 spinning of ramie, 177.
 spun yarn prices, 225.
 twisting, 229.
 Wharve, 173.
 Whipeord, 236.
 White metal brushes, 292.
 Width of pressing rollers, 172; of spinning
 room, 182.
 Willans' engine, 333.
 Wilson-Clyma's ventilating system, 307,
 308.
 Wire-drawn steam, 339.
 Wood for spinning pressing rollers, 171.
 pulleys, 353.
 Workers, 85.
 Workers' charge, 119, 120.
 Wrought iron pulleys, 353.

 YARN, breaking strains, 219.
 cooling, 214.
 drying, 211.
 drying machine, 214.
 for thread, 215.
 lea of, 217.
 proofs, 215.
 shifter, 207, 208.
 slubber, 228.
 twist of, 217.
 Yellow yarns, 60.
 Yield of line from hackling machine, 49,
 56.

A SELECTION FROM
CHARLES GRIFFIN & CO.'S PUBLICATIONS
OF
SCIENTIFIC AND TECHNICAL WORKS.

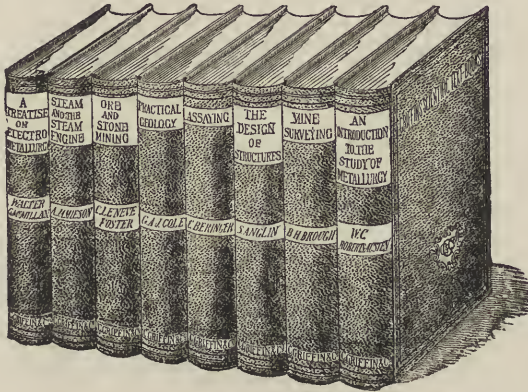

MESSRS. CHARLES GRIFFIN & COMPANY'S PUBLICATIONS may be obtained through any Bookseller in the United Kingdom, or will be sent on receipt of a remittance to cover published price and postage. To prevent delay, Orders should be accompanied by a Cheque or Postal Order crossed "UNION OF LONDON AND SMITH'S BANK, Chancery Lane Branch."

* * For *INDEX*, see next page.



✉ COMPLETE TECHNICAL, MEDICAL, and GENERAL CATALOGUES forwarded Post-free on Application.

LONDON:
EXETER STREET, STRAND.

1/5/09.
M.T. 64.

	PAGE
ADAMS (W. P.), Motor Car Mechanism, -	33
AITKEN (T.), Road Making, -	79
ALFORD (C. J.), Mining Law, -	57
ALLINGHAM (W.), Meteorology, -	41
ANDREWS (L.), Electricity Control, -	46
ANGLIN (S.), Design of Structures, -	26
ARCHBUTT & DEELEY, Lubrication, -	32
ATHERTON (Wm.), Design of Beams, -	26
BARKER (D. W.), Works by, -	40, 41
BAUER (M.), Precious Stones, -	68
BERINGER (J. J. & C.), Assaying, -	66
BICHEL & LARSEN, Explosives, -	58
BILES (Prof.), Works by, -	28, 37
BJÖRLING (P. R.), Peat, -	75
BLACKMORE (E.), Mercantile Marine, -	40
BLOUNT (B.), and BLOXAM (A. G.), Eng. and Manuf. Chemistry, -	72
BLYTH (A. Wynter), Foods and Poisons, -	71
BOHLE & ROBERTSON, Transformers, -	46
BORCHERS (Dr.), Electric Smelting, -	67
BROUGH (E. H.), Mine Surveying, -	56
BROWN (W. R.), Works by, -	45
BRUCE (Robt.), Food Supply, -	53
BUCK (R. C.), Algebra & Trigonometry, -	42
BURNS (D.), Colliery Electricity, -	57
BUTTERFIELD, (W. J. A.), Gas, -	77
CAIN & THORPE, Synthetic Dyestuffs, -	82
CARTER (H. R.), Long Fibre Spinning, -	83
CASTELL-EVANS, Chemical Tables, -	71
CHATLEY (H.), Works by, -	27, 48
CLARK (J.), Soil Bacteria, -	73
CLAYWORKER'S HANDBOOK, -	75
COLE (Prof. G. A. J.), Works by, -	52, 85
COLE (W. H.), Light Railways, -	30
COLLINS (H. F.), Lead and Silver, -	64
COX (S. H.), Prospecting for Minerals, -	53
CROTCH (A.), Telegraphic Systems, -	47
CUNNINGHAM, Docks and Harbours, -	27
DAVEY (H.), Pumping Machinery, -	36
DIXON (C.), Bird Life, -	85
DONKIN (Bryan), Works, -	23
DURR (Geo.), Bleaching, &c., -	84
DUNBAR (Prof.), Sewage Treatment, -	76
DUPRE & HAKE, Manual of Chemistry, -	70
EICHHORN, Wireless Telegraphy, -	47
FARNSWORTH, Cons. Steel Work, -	84
FARRELL (F. J.), Dyeing and Cleaning, -	26
FIDLER (Prof.), Bridge-Construction, -	26
FIELD (E. R.), Mining Report Book, -	57
FOSTER (Sir C. Le Neve), Works by, -	54
GAIRNS (J. F.), Loco. Compounding, -	30
GATEHOUSE (F.), Cement Handbook, -	76
GINSBURG (Dr.) Shpmasters' Duties, -	43
GISSING (F. T.), Peat, -	75
GOLDING (H. A.), Bonus Tables, -	31
GROSSMANN (J.), Chem. Engineering, -	70
GRÜNWARD (J.), Enamelling on Metal, -	79
GULLIVER (G.), Metallic Alloys, -	60
GURDEN (R.), Traverse Tables, -	31
GUTTMANN (O.), Blasting, -	57
HALSE (E.), Spanish Mining Terms, -	83
HANNA (W. L.), Textile Fibres, -	83
HARBORD (F. W.), Steel, -	65
HARRISON (J. W.), Sanitation, -	78
HEBL & ESCH, Rubber Goods, -	81
HEWLETT (G.), Dict. Sea Terms, -	44
HEYLIN (H.), Cot. Weavers' Handbook, -	83
HICKS (J. A.), Mineral Oil Testing, -	61
HOBBS (L.), Engine Design, -	27
HODGSON (R. B.), Emery Grinding, -	32
HOOGHWINKEL (G.), Signalling in Mines, -	58
HUGHES (H. W.), Coal Mining, -	55
HURST (Chas.), Works by, -	29
HURST (G. H.), Works by, -	80
INGLE (H.), Agricultural Chemistry, -	73
JAMIESON (Prof.), MANUALS, -	34
JOHNSON (J. C. F.), Getting Gold, -	59
JUDE (A.), Steam Turbine, -	23
JULIAN (H. F.) and SMART (E.), Cyaniding Gold and Silver Ores, -	59

	PAGE
KASSNER (T.), Gold Seeking, -	59
KERR (G. L.), Works by, -	55
KNECHT & RAWSON, Dyeing, -	82
LAFAR, Technical Mycology, -	74
LAMBERT, Glue, Gelatine, &c., -	81
LARARD (C. E.), Eng. Calculations, -	31
LAW (E. F.), Alloys, -	64
LAWN (J. G.), Mine Accounts, -	57
LEEDS (F. H.), Acetylene, -	77
LIECKFELD (G.), Oil Motors, -	33
LIVERSIDGE, Engine-Room Practice, -	29
MACKENZIE (T.), Mechanics, -	42
MACLEOD (W. A.) and WALKER (C.), Metallurgical Chemistry, -	60
M-LAREN, Elem. Mech. Eng., -	33
McMILLAN (W. G.), Electro-Metallurgy, -	67
— & BORCHERS, Electric Smelting, -	67
McWILLIAM, Foundry Practice, -	68
MESSUM (S.), Hydrographic Surveying, -	37
MIDDLETON (R. E.), Water Supply, -	77
MILL (Dr. R. H.), New Lands, -	53
MILLAR (W. J.), Latitude & Longitude, -	42
MITCHELL (C. A.), Flesh Foods, -	72
— & HEPWORTH (T. C.), Inks, -	81
MORGAN (J. J.), Metallurgical Tables, -	67
MUNRO (J. M. H.), Agric. Chem., -	74
MUNRO & JAMIESON'S Elect. Pkt-bk., -	47
MUNRO (R. D.), Works by, -	32
NAYLOR (W.), Trades' Waste, -	76
NICHOLSON (W.), Smoke Abatement, -	76
NORMANDY (F.), Sea Water Distillation, -	36
NORTH (S.), Oil Fuel, -	61
OPPENHEIMER (C.), Works by, -	74
OSMOND & STEAD, Micro. Anal. Metals, -	60
PARK (J.), Works by, -	56, 59
PEARCE (W. J.), Painting, -	80
PETTIGREW (W. F.), Loco. Eng., -	30
PHILLIPS & BAUERMAN, Metallurgy, -	60
POYNTING & THOMSON, Physics, -	49
PRAEGER (R. L.), Open Air Botany, -	85
RANKINE'S Works, -	35
RAWSON, GARDNER, & LAYCOOK, Dictionary of Dyestuffs, -	82
REDGRAVE (G. R.), Cements, -	76
REDWOOD (Sir Boverton), Petroleum, -	61
— & THOMSON, Handbook, Petroleum, -	61
REID (Geo., M.D.), Sanitation, -	78
RICHMOND (H. D.), Works by, -	73
RIEMER (J.), Shaft Sinking, -	58
ROBERTS-AUSTEN, Metallurgy, -	63
ROBINSON (Prof.), Hydraulics, -	36
ROSE (T. L.), Gold, Metallurgy of, -	68
ROTHWELL (C. F. S.), Textile Printing, -	83
SCHWARTZ (Dr. von), Fire Risks, -	77
SEATON (A. E.), Works by, -	44
SEXTON (Prof.), Works by, -	66, 70
SHOWELL (P. G.), Navigation Definitions, -	44
SINDALL, Paper Technology, -	75
SMITH (C. A.), Suction Gas Plants, -	28
SMITH (J. W.), Dustless Roads, -	79
SMITH (Prof. R. H.), Works by, -	45
SMITH (W.), Shipmaster's Medical Help, -	43
SOLOMON (H. G.), Electricity Meters, -	46
STEWART (R. W.), Elementary Physics, -	48
STRICKLAND (F.), Petrol Motors, -	33
SUPLEE (H. H.), Mech. Pocket-Book, -	45
SYKES (Dr. W. J.), Brewing, -	75
TRAILL (T. W.), Boilers, -	29
TROTMAN (S. R.), Leather, -	81
TURNER (Thos.), Works by, -	65, 66, 68
WALTON (T.), Works by, -	38, 43
WANG (C. Y.), Antimony, -	65
WEBER (Dr. C. O.), India Rubber, -	81
WELLS (S. H.), Engineering Drawing, -	32
WILEY (T. E.), Jeweller's Art, -	68
WILLOUGHBY (Dr. E. F.), Milk, -	73
WOOD (Francis), Sanitary Engineering, -	78
WORDINGHAM, Electrical Stations, -	46
WRIGHT (Dr. A.), Oils and Fats, -	71
ZERR & RUBENCAMP, Colour Manuf. -	80

GRIFFIN'S STANDARD PUBLICATIONS.

	PAGE
Applied Mechanics.	35, 45, 34
Civil Engineering,	35
Design of Structures,	26
Bridge-Construction,	26
Design of Beams,	26
Constructional Steelwork,	26
Dock and Harbour Engineering,	27
Engineering Drawing,	32
Engine Design,	27
Central Electrical Stations,	46
Electricity Control,	46
,, Meters,	46
Transformers,	46
Telegraphic Systems,	47
Light Railways,	30
Sanitary Engineering,	78
Locomotive Engineering,	30
Locomotive Compounding,	30
Marine Engineering,	44
The Screw Propeller,	44
The Steam Turbine,	28
Marine Steam Turbine,	28
Engine-Room Practice,	29
Pocket-Book,	44
Present Day Shipbuilding,	38
Design of Ships,	37
Steel Vessels,	38
Stability of Ships,	37
The Steam Engine,	34, 35
Valves and Valve-Gearing,	29
Carburettors, Vaporisers & Valves,	30
Gas, Oil, and Air Engines,	28
Oil Motors, and their Uses,	33
Petrol Motors and Cars,	33
Suction Gas Plants,	28
The Problem of Flight,	27
The Force of the Wind,	48
Stresses in Masonry,	48
Mechanical Eng. for Beginners,	33
Boilers: Land and Marine,	29
,, "Steam" and "Kitchen,"	32
,, Heat Efficiency of,	28
Oil Fuel,	61
Pumping Machinery,	36
Hydraulic Machinery,	36
Sea Water Distillation,	36
Grinding Machinery,	32
Lubrication and Lubricants,	32
Rules and Tables,	35
Practical Calculations,	31
Bonus Tables,	31
Electrical Pocket-Book,	47
The Calculus for Engineers,	45
Measurement Conversions,	45
Traverse Tables,	31

LONDON: CHARLES GRIFFIN & CO., LIMITED, EXETER STREET, STRAND

FOURTH EDITION, *Revised, with Numerous Diagrams, Examples, and Tables, and a Chapter on Foundations. In Large 8vo. Cloth. 16s.*

THE DESIGN OF STRUCTURES:

A Practical Treatise on the Building of Bridges, Roofs, &c.

By S. ANGLIN, C.E.,

Master of Engineering, Royal University of Ireland, late Whitworth Scholar, &c.

"We can unhesitatingly recommend this work not only to the Student, as the BEST TEXT-BOOK on the subject, but also to the professional engineer as an EXCEEDINGLY VALUABLE book of reference."—*Mechanical World.*

In Large Crown 8vo. Handsome Cloth. With 201 Illustrations. 6s. net.

AN INTRODUCTION TO

THE DESIGN OF BEAMS, GIRDERS, AND COLUMNS IN MACHINES AND STRUCTURES.

With Examples in Graphic Statics.

By WILLIAM H. ATHERTON, M.Sc., M.I.MECH.E.

"A very useful source of information. . . . A work which we commend very highly."—*Nature.*

FOURTH EDITION, *Thoroughly Revised. Royal 8vo. With numerous Illustrations and 13 Lithographic Plates. Handsome Cloth. Price 30s.*

A PRACTICAL TREATISE ON BRIDGE-CONSTRUCTION:

Being a Text-Book on the Construction of Bridges in Iron and Steel.

FOR THE USE OF STUDENTS, DRAUGHTSMEN, AND ENGINEERS.

By T. CLAXTON FIDLER, M. INST. C. E.,

Prof. of Engineering, University College, Dundee.

"The new edition of Mr. Fidler's work will again occupy the same CONSPICUOUS POSITION among professional text-books and treatises as has been accorded to its predecessors. SOUND, SIMPLE, AND FULL."—*The Engineer.*

In Medium 8vo. Pp. i-xv + 248, fully Illustrated. Price 10s. 6d. net.

CONSTRUCTIONAL STEELWORK:

Being Notes on the Practical Aspect and the Principles of Design, together with an Account of the Present Methods and Tools of Manufacture.

By A. W. FARNSWORTH,

Associate Member of the Institute of Mechanical Engineers.

"A worthy volume, which will be found of much assistance. . . . A book of particular value."—*Practical Engineer.*

LONDON: CHARLES GRIFFIN & CO., LIMITED, EXETER STREET, STRAND.

In Large 8vo. Handsome Cloth, Gilt, Uniform with *Stability of Ships* and *Steel Ships* (pp. 37, 38). With 34 Folding Plates and 468 Illustrations in the Text. 30s. net.

The Principles and Practice of DOCK ENGINEERING.

By BRYSSON CUNNINGHAM.

GENERAL CONTENTS.

Historical and Discursive.—Dock Design.—Constructive Appliances.—Materials.—Dock and Quay Walls.—Entrance Passages and Locks.—Jetties, Wharves, and Piers.—Dock Gates and Caissons.—Transit Sheds and Warehouses.—Dock Bridges.—Graving and Repairing Docks.—Working Equipment of Docks.—INDEX.

"We have never seen a more profusely-illustrated treatise. It is a most important standard work, and should be in the hands of all dock and harbour engineers."—*Steamship*.
"Will be of the greatest service to the expert as a book of reference."—*Engineer*.

In Large 8vo. With Folding Plates and Numerous Illustrations. 16s. net.
A COMPANION VOLUME TO "DOCK ENGINEERING."

THE PRINCIPLES AND PRACTICE OF HARBOUR ENGINEERING.

By BRYSSON CUNNINGHAM.

CONTENTS.—Introductory.—Harbour Design.—Surveying, Marine and Submarine.—Piling.—Stone, Natural and Artificial.—Breakwater Design.—Breakwater Construction.—Pierheads, Quays, and Landing Stages.—Entrance Channels.—Channel Demarcation.—INDEX.

"The best and most complete book we have seen on the subject."—*Steamship*.
"This is a standard work . . . sure to prove a valuable book of reference."—*Shipping World*.

In Large Crown 8vo. Handsome Cloth. 4s. 6d. net.

THE THERMO-DYNAMIC PRINCIPLES OF ENGINE DESIGN.

By LIONEL M. HOBBS,

Engineer-Lieutenant, R.N.; Instructor in Applied Mechanics and Marine Engine Design at the Royal Naval College, Greenwich.

"Serves its purpose admirably . . . should prove of invaluable service . . . well up-to-date."—*Shipping World*.

In Large 8vo. Cloth. Fully Illustrated. 10s. 6d. net.

THE PROBLEM OF FLIGHT.

By HERBERT CHATLEY, B.Sc. (ENG.), LONDON,
Professor of Civil Engineering, Tong Shan Engineering College, N. China.

CONTENTS.—The Problem of Flight.—The Helix.—The Aéroplane.—The Aviplane.—Dirigible Balloons.—Form and Fittings of the Airship.—APPENDICES (*The Possibility of Flight, Weight, A Flexible Wing, Theory of Balance, Bibliography*).—INDEX.

"An epitome of the knowledge available on the subject."—*Scotsman*.

LONDON: CHARLES GRIFFIN & CO., LIMITED, EXETER STREET, STRAND.

In Handsome Cloth. With 252 Illustrations. 15s. net.

THE THEORY OF THE STEAM TURBINE.

A Treatise on the Principles of Construction of the Steam Turbine,
with Historical Notes on its Development.

By ALEXANDER JUDE.

CONTENTS.—Fundamental.—Historical Notes on Turbines.—The Velocity of Steam.—Types of Steam Turbines.—Practical Turbines.—The Efficiency of Turbines, Type I.—Trajectory of the Steam.—Efficiency of Turbines, Types II., III. and IV.—Turbine Vanes.—Disc and Vane Friction in Turbines.—Specific Heat of Superheated Steam.—Strength of Rotating Discs.—Governing Steam Turbines.—Steam Consumption of Turbines.—The Whirling of Shafts.—Speed of Turbines.—INDEX.
"One of the latest text-books . . . also one of the best . . . there is absolutely no padding."—*Sir William White* in the *Times Engineering Supplement*.

In Large Crown 8vo. Handsome Cloth. With 131 Illustrations. 6s. net.

LECTURES ON THE MARINE STEAM TURBINE.

By PROF. J. HARVARD BILES, M. INST. N. A.,

Professor of Naval Architecture in the University of Glasgow.

"This is the best popular work on the marine steam turbine which has yet appeared."—*Steamship*.

Works by BRYAN DONKIN, M. INST. C. E., M. INST. MECH. E., &c.

FOURTH EDITION, Revised and Enlarged. With additional Illustrations.
Large 8vo, Handsome Cloth. 25s. net.

A TEXT-BOOK ON GAS, OIL, AND AIR ENGINES.

By BRYAN DONKIN, M. INST. C. E., M. INST. MECH. E.

"The best book now published on Gas, Oil, and Air Engines."—*Engineer*.

In Quarto, Handsome Cloth. With Numerous Plates. 25s.

THE HEAT EFFICIENCY OF STEAM BOILERS (LAND, MARINE, AND LOCOMOTIVE).

By BRYAN DONKIN, M. INST. C. E.

GENERAL CONTENTS.—Classification of Different Types of Boilers.—425 Experiments on English and Foreign Boilers with their Heat Efficiencies shown in Fifty Tables.—Fire Grates of Various Types.—Mechanical Stokers.—Combustion of Fuel in Boilers.—Transmission of Heat through Boiler Plates, and their Temperature.—Feed Water Heaters, Superheaters, Feed Pumps, &c.—Smoke and its Prevention.—Instruments used in Testing Boilers.—Marine and Locomotive Boilers.—Fuel Testing Stations.—Discussion of the Trials and Conclusions.—On the Choice of a Boiler, and Testing of Land, Marine, and Locomotive Boilers.—Appendices.—Bibliography.—INDEX.

"Probably the MOST EXHAUSTIVE *résumé* that has ever been collected. A PRACTICAL BOOK by a thoroughly practical man."—*Iron and Coal Trades Review*.

In Large Crown 8vo. Cloth. Fully Illustrated. 5s. net.

SUCTION GAS PLANTS.

By PROF. C. A. SMITH, of the East London Technical College.

CONTENTS.—Introduction.—Details of Construction.—Fuel and Testing.—Application and Uses of Suction Plants.—Working the Plant.—Typical Plants.—Plants for Special Purposes.—Total H.P.—Effluent.—Cost of Gas Production.—The Gas Engine.—Bibliography.—Calorific Value of Coal Gas.—Of Solid Fuels.—Gas Analysis.—Destruction of Tar in the Producer.—Detection of CO in Exhaust.—Capital Cost.—INDEX.

LONDON: CHARLES GRIFFIN & CO., LIMITED, EXETER STREET, STRAND.

FOURTH EDITION, Revised. Pocket-Size, Leather, 12s. 6d.

BOILERS, MARINE AND LAND: THEIR CONSTRUCTION AND STRENGTH.

A HANDBOOK OF RULES, FORMULÆ, TABLES, &C., RELATIVE TO MATERIALS,
SCANTLINGS, AND PRESSURES, SAFETY VALVES, SPRINGS,
FITTINGS AND MOUNTINGS, &C.

FOR THE USE OF ENGINEERS, SURVEYORS, BOILER-MAKERS,
AND STEAM USERS.

By T. W. TRAILL, M. INST. O. E., F. E. R. N.

Late Engineer Surveyor-in-Chief to the Board of Trade.

"Contains an ENORMOUS QUANTITY OF INFORMATION arranged in a very convenient form. . .
A MOST USEFUL VOLUME . . . supplying information to be had nowhere else."—*The Engineer*.

SIXTH EDITION, Revised. Large Crown 8vo. With numerous
Illustrations. 6s. net.

ENGINE-ROOM PRACTICE:

A Handbook for Engineers and Officers in the Royal Navy and Mercantile
Marine, including the Management of the Main and Auxiliary
Engines on Board Ship.

By JOHN G. LIVERSIDGE, R.N., A.M.I.C.E.

Contents.—General Description of Marine Machinery.—The Conditions of Service and
Duties of Engineers of the Royal Navy.—Entry and Conditions of Service of Engineers of
the Leading S.S. Companies.—Raising Steam.—Duties of a Steaming Watch on Engines
and Boilers.—Shutting off Steam.—Harbour Duties and Watches.—Adjustments and
Repairs of Engines.—Preservation and Repairs of "Tank" Boilers.—The Hull and its
Fittings.—Cleaning and Painting Machinery.—Reciprocating Pumps, Feed Heaters, and
Automatic Feed-Water Regulators.—Evaporators.—Steam Boats.—Electric Light
Machinery.—Hydraulic Machinery.—Air-Compressing Pumps.—Refrigerating Machines
—Machinery of Destroyers.—The Management of Water-Tube Boilers.—Regulations for
Entry of Assistant Engineers, R.N.—Questions given in Examinations for Promotion of
Engineers R.N.—Regulations respecting Board of Trade Examinations for Engineers, &c.

"This VERY USEFUL BOOK. . . ILLUSTRATIONS are of GREAT IMPORTANCE in a work
of this kind, and it is satisfactory to find that SPECIAL ATTENTION has been given in this
respect."—*Engineers' Gazette*.

FIFTH EDITION, Thoroughly Revised and Greatly Enlarged.
With Numerous Illustrations. Price 10s. 6d.

VALVES AND VALVE-GEARING:

A Practical Text-book for the use of Engineers, Draughtsmen, and Students.

By CHARLES HURST, PRACTICAL DRAUGHTSMAN.

PART I.—Steam Engine Valves.	PART III.—Air Compressor Valves and Gearing.
PART II.—Gas Engine Valves and Gears.	PART IV.—Pump Valves.

"MR. HURST'S VALVES and VALVE-GEARING will prove a very valuable aid, and tend to the
production of Engines of SCIENTIFIC DESIGN and ECONOMICAL WORKING. . . Will be largely
sought after by Students and Designers."—*Marine Engineer*.

"As a practical treatise on the subject, the book stands without a rival."—*Mechanical
World*.

Hints on Steam Engine Design and Construction. By CHARLES
HURST, "Author of Valves and Valve Gearing." SECOND EDITION,
Revised. In Paper Boards, 8vo., Cloth Back. Illustrated. Price
1s. 6d. net.

CONTENTS.—I. Steam Pipes.—II. Valves.—III. Cylinders.—IV. Air Pumps and Con-
densers.—V. Motion Work.—VI. Crank Shafts and Pedestals.—VII. Valve Gear.—VIII.
Lubrication.—IX. Miscellaneous Details.—INDEX.

"A handy volume which every practical young engineer should possess."—*The Model
Engineer*.

LONDON: CHARLES GRIFFIN & CO., LIMITED, EXETER STREET, STRAND.

THIRD EDITION, Revised. With numerous Plates reduced from Working Drawings and Illustrations in the Text. 21s.

A MANUAL OF LOCOMOTIVE ENGINEERING:

A Practical Text-Book for the Use of Engine Builders,
Designers and Draughtsmen, Railway
Engineers, and Students.

By WILLIAM FRANK PETTIGREW, M.INST.C.E.

Contents.—Historical Introduction, 1763-1863.—Modern Locomotives: Simple.—Modern Locomotives: Compound.—Primary Consideration in Locomotive Design.—Cylinders, Steam Chests, and Stuffing Boxes.—Pistons, Piston Rods, Crossheads, and Slide Bars.—Connecting and Coupling Rods.—Wheels and Axles, Axle Boxes, Hornblocks, and Bearing Springs.—Balancing.—Valve Gear.—Slide Valves and Valve Gear Details.—Framing, Bogies and Axle Trucks, Radial Axle Boxes.—Boilers.—Smokebox. Blast Pipe Firebox Fittings.—Boiler Mountings.—Tenders.—Railway Brakes.—Lubrication.—Consumption of Fuel, Evaporation and Engine Efficiency.—Repairs, Running, Inspection, and Renewals.—Three Appendices.—Index.

"The work CONTAINS ALL THAT CAN BE LEARNED from a book upon such a subject. It will at once rank as THE STANDARD WORK UPON THIS IMPORTANT SUBJECT."—*Railway Magazine.*

In Large 8vo. Fully Illustrated. 8s. 6d. net.

LOCOMOTIVE COMPOUNDING AND SUPERHEATING.

By J. F. GAIRNS.

CONTENTS.—Introductory.—Compounding and Superheating for Locomotives.—A Classification of Compound Systems for Locomotives.—The History and Development of the Compound Locomotive.—Two-Cylinder Non-Automatic Systems.—Two-Cylinder Automatic Systems.—Other Two-Cylinder Systems.—Three-Cylinder Systems.—Four-Cylinder Tandem Systems.—Four-Cylinder Two-Crank Systems (other than Tandem).—Four-Cylinder Balanced Systems.—Four-Cylinder Divided and Balanced Systems.—Articulated Compound Engines.—Triple-Expansion Locomotives.—Compound Rack Locomotives.—Concluding Remarks Concerning Compound Locomotives.—The Use of Superheated Steam for Locomotives.—INDEX.

"A welcome addition to the library of the railway engineer."—*Engineering Times.*

In Large 8vo. Handsome Cloth. With Plates and Illustrations. 16s.

LIGHT RAILWAYS AT HOME AND ABROAD.

By WILLIAM HENRY COLE, M.INST.C.E.,

Late Deputy-Manager, North-Western Railway, India.

"Will remain, for some time yet a STANDARD WORK in everything relating to Light Railways."—*Engineer.*

"The whole subject is EXHAUSTIVELY and PRACTICALLY considered. The work can be cordially recommended as INDISPENSABLE to those whose duty it is to become acquainted with one of the prime necessities of the immediate future."—*Railway Official Gazette.*

In Demy 8vo. Handsome Cloth. Profusely Illustrated.

CARBURETTORS, VAPORISERS, AND VALVES.

By EDWARD BUTLER, M.I.Mech.E.

LONDON: CHARLES GRIFFIN & CO., LIMITED, EXETER STREET, STRAND.

In Crown 8vo. Handsome Cloth. Fully Illustrated. 6s. net.

PRACTICAL CALCULATIONS FOR ENGINEERS.

By CHARLES E. LARARD,

A.M.Inst.C.E., M.I.Mech.E., Wh.Exh.,

Head of the Mechanical Engineering Department at the Northampton Institute, London, E.C.

AND H. A. GOLDING, A.M.I.Mech.E.

CONTENTS.—SECTION I.—Contracted Methods of Calculation.—Technical Mensuration.—Practical Calculation by Logarithms.—The Slide Rule and its Applications.—Squared Paper and its Uses. SECTION II.—Pulleys and Wheels in Train.—Speed Ratios and Practical Examples.—Principle of Moments Applied to Practical Problems.—Work and Power.—Energy and Speed Fluctuations.—Transmission of Work through Machines.—Friction and Efficiency.—Transmission of Power.—Shafting.—Motion on a Circle.—Momentum, Acceleration, and Force Action. SECTION III.—Temperature Scales.—Units of Heat.—Specific Heat.—Heat and Work.—Heat Value of Fuels.—Heat Losses in Engine and Boiler Plant.—Properties of Steam.—Moisture and Dryness Fraction.—Steam and Fuel Calculations.—Boiler Efficiency.—Size of Boiler.—Engine Calculations.—Power, Indicated and Brake.—Calculations for Dimensions.—Steam Consumption and Willans Law.—Efficiencies, Comparative Costs of Power Production.—Commercial Efficiency. SECTION IV.—The Commercial side of Engineering.—Calculation of Weights.—Division of Costs, Material and Labour, Shop Charges and Establishment Charges.—Estimates.—Profit.—Use of Squared Paper in the Estimating Department and to the General Management.

"Exactly what it should be in order to make it useful to students and practitioners of engineering."—*Manchester Guardian*.

SIXTH EDITION. Folio, strongly half-bound, 21s.

TRAVERSE TABLES:

Computed to Four Places of Decimals for every Minute of Angle up to 100 of Distance.

For the Use of Surveyors and Engineers.

By RICHARD LLOYD GURDEN,

Authorised Surveyor for the Governments of New South Wales and Victoria.

** Published with the Concurrence of the Surveyors-General for New South Wales and Victoria.

"Those who have experience in exact SURVEY-WORK will best know how to appreciate the enormous amount of labour represented by this valuable book. Every Surveyor in active practice has felt the want of such assistance FOR KNOWING OF THEIR (the Tables) PUBLICATION WILL REMAIN WITHOUT THEM."—*Engineer*.

Strongly Bound in Super Royal 8vo. Cloth Boards. 7s. 6d. net.

BONUS TABLES:

For Calculating Wages on the Bonus or Premium Systems.

For Engineering, Technical and Allied Trades.

By HENRY A. GOLDING, A.M.I.MECH.E.,

"Cannot fail to prove practically serviceable to those for whom they have been designed."—*Scotsman*.

HORSE-POWER COMPUTERS.

By H. A. GOLDING, A.M.I.MECH.E., A.M.I.A.E.

For Steam, Gas, and Oil Engines. Complete with Explanatory Pamphlet. In Box. 5s. net.

For Petrol Motors. Complete with Explanatory Pamphlet. In Envelope. 6d. net.

Detailed Prospectus on Application.

LONDON: CHARLES GRIFFIN & CO., LIMITED, EXETER STREET, STRAND.

SECOND EDITION. Large 8vo, Handsome Cloth. With
Illustrations, Tables, &c. 21s. net.

Lubrication & Lubricants:

A Treatise on the Theory and Practice of Lubrication, and on the
Nature, Properties, and Testing of Lubricants.

BY
LEONARD ARCHBUTT, F.I.C., F.C.S.,
Chemist to the Mid. Ry. Co.

AND
R. M. DEELEY, M.I. Mech.E., F.G.S.
Chief Loco. Super., Mid. Ry. Co.

CONTENTS.—I. Friction of Solids.—II. Liquid Friction or Viscosity, and Plastic Friction.—III. Superficial Tension.—IV. The Theory of Lubrication.—V. Lubricants, their Sources, Preparation, and Properties.—VI. Physical Properties and Methods of Examination of Lubricants.—VII. Chemical Properties and Methods of Examination of Lubricants.—VIII. The Systematic Testing of Lubricants by Physical and Chemical Methods.—IX. The Mechanical Testing of Lubricants.—X. The Design and Lubrication of Bearings.—XI. The Lubrication of Machinery.—INDEX.

"Contains practically ALL THAT IS KNOWN on the subject. Deserves the careful attention of all Engineers."—*Railway Official Gazette*.

FOURTH EDITION. *Very fully Illustrated. Cloth, 4s. 6d.*

STEAM - BOILERS:

THEIR DEFECTS, MANAGEMENT, AND CONSTRUCTION

By R. D. MUNRO,

Chief Engineer of the Scottish Boiler Insurance and Engine Inspection Company.

"A valuable companion for workmen and engineers engaged about Steam Boilers, ought to be carefully studied, and ALWAYS AT HAND."—*Coll. Guardian*.

BY THE SAME AUTHOR.

KITCHEN BOILER EXPLOSIONS: Why
they Occur, and How to Prevent their Occurrence. A Practical Handbook
based on Actual Experiment. With Diagram and Coloured Plate. 3s.

In Crown 8vo, Cloth. Fully Illustrated. 5s. net.

EMERY GRINDING MACHINERY.

A Text-Book of Workshop Practice in General Tool Grinding, and the
Design, Construction, and Application of the Machines Employed.

By R. B. HODGSON, A.M. INST. MECH. E.

"Eminently practical . . . cannot fail to attract the notice of the users of this class of machinery, and to meet with careful perusal."—*Chem. Trade Journal*.

FIFTH EDITION. In Two Parts, Published Separately.

A TEXT-BOOK OF

Engineering Drawing and Design.

By SIDNEY H. WELLS, W.H.Sc., A.M.I.C.E., A.M.I. MECH. F.

VOL. I.—PRACTICAL GEOMETRY, PLANE, AND SOLID. 4s. 6d.

VOL. II.—MACHINE AND ENGINE DRAWING AND DESIGN. 4s. 6d.

With many Illustrations, specially prepared for the Work, and numerous Examples, for the Use of Students in Technical Schools and Colleges.

"A CAPITAL TEXT-BOOK, arranged on an EXCELLENT SYSTEM, calculated to give an intelligent grasp of the subject, and not the mere faculty of mechanical copying. . . . Mr. Wells shows how to make COMPLETE WORKING-DRAWINGS, discussing fully each step in the design."—*Electrical Review*

LONDON: CHARLES GRIFFIN & CO., LIMITED, EXETER STREET, STRAND.

IN THREE PARTS. Crown 8vo, Handsome Cloth. Very Fully Illustrated.

MOTOR-CAR MECHANISM AND MANAGEMENT.

By W. POYNTER ADAMS, M. INST. E. E.

PART I.—THE PETROL CAR. 5s. net.

SECOND EDITION. With important new Appendix, illustrating and defining parts of actual cars in use.

Contents.—SECTION I.—THE MECHANISM OF THE PETROL CAR.—The Engine.—The Engine Accessories.—Electrical Ignition and Accessories.—Multiple Cylinder Engines.—The Petrol.—The Chassis and Driving Gear.—SECTION II.—THE MANAGEMENT OF THE PETROL CAR.—The Engine.—The Engine Accessories.—Electrical Ignition.—The Chassis and Driving Gear.—General Management.—APPENDIX.—GLOSSARY.—INDEX.

"Should be carefully studied by those who have anything to do with motors."—*Automobile and Carriage Builders' Journal.*

PART II.—ELECTRICAL AND PETROL ELECTRICAL MOTOR CARS.

Pp. i.-x. + 202. With 50 Illustrations. 5s. net.

In Large 8vo. Handsome Cloth. Very Fully Illustrated. 18s. net

A MANUAL OF PETROL MOTORS AND MOTOR-CARS.

Comprising the Designing, Construction, and Working of Petrol Motors.

By F. STRICKLAND.

GENERAL CONTENTS.—PART I.: ENGINES.—Historical.—Power Required.—General Arrangement of Engines.—Ignition.—Carburettors.—Cylinders, Pistons, Valves, &c.—Crank Shafts, Crank Chambers, Cams, Runners, Guides, &c.—Pumps.—Flywheels.—Pipe Arrangements.—Silencers.—Engine Control, Balancing.—Motor Cycle Engines.—Marine Motors.—Two-Cycle Motors.—Paraffin Carburettors.—Gas Producers PART II.: CARS.—General Arrangements.—Clutches.—Transmission.—Differential Gears.—Universal Joints.—Axles.—Springs.—Radius Rods.—Brakes.—Wheels.—Frames.—Steering Gear.—Radiator.—Steps, Mudguards, Bonnets, &c.—Lubrication.—Ball Bearings.—Bodies.—Factors of Safety.—Calculations of Stresses.—Special Change Speed Gears.—Special Cars.—Commercial Vehicles.—Racing Cars.—INDEX.

"Thoroughly practical and scientific. . . . We have pleasure in recommending it to all."—*Mechanical Engineer.*

In Medium 8vo. Handsome Cloth. Fully Illustrated. 15s. net.

OIL MOTORS.

Their Development, Construction, and Management.

By G. LIECKFELD. (Authorised English Edition).

CONTENTS.—Liquid Fuels for Power Production.—Development of the Petrol and Paraffin Motors.—Working of the Later Paraffin and Petrol Engines.—Ignition Devices.—Examples of Stationary Petrol, Alcohol, Paraffin, and Crude Oil Engines.—Automobiles.—Ship, Boat, and Air-ship Engines.—Vehicles, &c., Driven by Internal Combustion Engines.—Erection and Attendance of Engines Driven with Liquid Fuel.—Correcting Irregularities in Running.

In Crown 8vo. Handsome Cloth. With 105 Illustrations. 5s. net.

MECHANICAL ENGINEERING FOR BEGINNERS.

By R. S. M'LAREN.

CONTENTS.—Materials.—Bolts and Nuts, Studs, Set Screws.—Boilers.—Steam Raising Accessories.—Steam Pipes and Valves.—The Steam Engine.—Power Transmission.—Condensing Plant.—The Steam Turbine.—Electricity.—Hydraulic Machinery.—Gas and Oil Engines.—Strength of Beams, and Useful Information.—INDEX.

"The best of its kind we have seen, and should be in the hands of every apprentice."—*Steamship.*

LONDON: CHARLES GRIFFIN & CO., LIMITED, EXETER STREET, STRAND.

WORKS BY

ANDREW JAMIESON, M.INST.C.E., M.I.E.E., F.R.S.E.,
Formerly Professor of Electrical Engineering, The Glas. and W. of Scot. Tech. Coll.

PROFESSOR JAMIESON'S ADVANCED TEXT-BOOKS.

In Large Crown 8vo. Fully Illustrated.

STEAM AND STEAM-ENGINES, INCLUDING TURBINES

AND BOILERS. For the Use of Engineers and for Students preparing for Examinations. With 800 pp., over 400 Illustrations, 11 Plates, many B. of E., C. and G., Questions and Answers, and all Inst. C.E. Exams. on *Theory of Heat Engines*. SIXTEENTH EDITION, Revised. 10s. 6d.

"The BEST BOOK yet published for the use of Students."—*Engineer*.

APPLIED MECHANICS & MECHANICAL ENGINEERING.

Including All the Inst. C.E. Exams. in (1) Applied Mechanics; (2) Strength and Elasticity of Materials; (3a) Theory of Structures; (ii) Theory of Machines; Hydraulics. Also B. of E.; C. and G. Questions.

Vol. I.—Comprising 568 pages, 300 Illustrations, and Questions: Part I., The Principle of Work and its Applications; Part II.: Friction, Lubrication of Bearings, &c.; Different kinds of Gearing and their Applications to Workshop Tools, &c. SIXTH EDITION. 8s. 6d.

"FULLY MAINTAINS the reputation of the Author."—*Pract. Engineer*.

Vol. II.—Comprising Parts III. to VI., with over 800 pages, 371 Illustrations; Motion and Energy, Theory of Structures or Graphic Statics; Strength and Elasticity of Materials; Hydraulics and Hydraulic Machinery. FIFTH EDITION. 12s. 6d.

"WELL AND LUCIDLY WRITTEN."—*The Engineer*.

* * Each of the above volumes is complete in itself, and sold separately.

PROFESSOR JAMIESON'S INTRODUCTORY MANUALS

Crown 8vo. With Illustrations and Examination Papers.

STEAM AND THE STEAM-ENGINE (Elementary

Manual of). For First-Year Students, forming an Introduction to the Author's larger Work. TWELFTH EDITION, Revised and Enlarged. 3/6

"Should be in the hands of EVERY engineering apprentice."—*Practical Engineer*.

MAGNETISM AND ELECTRICITY (Practical Elementary

Manual of). For First-Year Students. With Stud. Inst. C. E. and B. of E. Exam. Questions. SEVENTH EDITION, Revised and Enlarged. 3/6.

"A THOROUGHLY TRUSTWORTHY Text-book. PRACTICAL and clear."—*Nature*.

APPLIED MECHANICS (Elementary Manual of).

For First-Year Students. With B. of E., C. and G.; and Stud. Inst. C. E. Questions. EIGHTH EDITION, Revised and Greatly Enlarged. 3/6.

"The work has VERY HIGH QUALITIES, which may be condensed into the one word 'CLEAR.'"—*Science and Art*.

A POCKET-BOOK of ELECTRICAL RULES and TABLES

For the Use of Electricians and Engineers. By JOHN MUNRO, C.E., and Prof. JAMIESON. Pocket Size. Leather, 8s. 6d. NINETEENTH EDITION.

[See p. 47.]

LONDON: CHARLES GRIFFIN & CO., LIMITED, EXETER STREET, STRAND.

WORKS BY W. J. MACQUORN RANKINE, LL.D., F.R.S.

Thoroughly Revised by W. J. MILLAR, C.E.

- A MANUAL OF APPLIED MECHANICS:** Comprising the Principles of Statics and Cinematics, and Theory of Structures, Mechanism, and Machines. With Numerous Diagrams. Crown 8vo, Cloth. SEVENTEENTH EDITION. 12s. 6d.
- A MANUAL OF CIVIL ENGINEERING:** Comprising Engineering Surveys, Earthwork, Foundations, Masonry, Carpentry, Metal Work, Roads, Railways, Canals, Rivers, Waterworks, Harbours, &c. With Numerous Tables and Illustrations. Crown 8vo, Cloth. TWENTY-THIRD EDITION. 16s.
- A MANUAL OF MACHINERY AND MILLWORK:** Comprising the Geometry, Motions, Work, Strength, Construction, and Objects of Machines, &c. With nearly 300 Illustrations. Crown 8vo, Cloth. SEVENTH EDITION. 12s. 6d.
- A MANUAL OF THE STEAM-ENGINE AND OTHER PRIME MOVERS.** With a Section on GAS, OIL, and AIR ENGINES, by BRYAN DONKIN, M.Inst.C.E. With Folding Plates and Numerous Illustrations. Crown 8vo, Cloth. SEVENTEENTH EDITION. 12s. 6d.
- USEFUL RULES AND TABLES:** For Architects, Builders, Engineers, Founders, Mechanics, Shipbuilders, Surveyors, &c. With APPENDIX for the use of ELECTRICAL ENGINEERS. By Professor JAMIESON, M.Inst.C.E., M.I.E.E. SEVENTH EDITION. 10s. 6d.
- A MECHANICAL TEXT-BOOK:** A Practical and Simple Introduction to the Study of Mechanics. By Professor RANKINE and E. F. BAMBER, C.E. With Numerous Illustrations. Crown 8vo, Cloth. FIFTH EDITION. 9s.

. The "MECHANICAL TEXT-BOOK" was designed by Professor RANKINE as an INTRODUCTION to the above Series of Manuals.

MISCELLANEOUS SCIENTIFIC PAPERS. Part I. Temperature, Elasticity, and Expansion of Vapours, Liquids, and Solids. Part II. Energy and its Transformations. Part III. Wave-Forms, Propulsion of Vessels, &c. With Memoir by Professor TAIT, M.A. With fine Portrait on Steel, Plates, and Diagrams. Royal 8vo. Cloth. 31s. 6d.

"No more enduring Memorial of Professor Rankine could be devised than the publication of these papers in an accessible form. . . . The Collection is most valuable on account of the nature of his discoveries, and the beauty and completeness of his analysis."
—*Architect.*

LONDON: CHARLES GRIFFIN & CO., LIMITED, EXETER STREET, STRAND

THIRD EDITION, *Thoroughly Revised and Enlarged. With 60 Plates and Numerous Illustrations. Handsome Cloth. 34s.*

HYDRAULIC POWER AND HYDRAULIC MACHINERY.

BY

HENRY ROBINSON, M. INST. C.E., F.G.S.,
FELLOW OF KING'S COLLEGE, LONDON; PROF. EMERITUS OF CIVIL ENGINEERING,
KING'S COLLEGE, ETC., ETC.

CONTENTS—Discharge through Orifices.—Flow of Water through Pipes.—Accumulators.—Presses and Lifts.—Hoists.—Rams.—Hydraulic Engines.—Pumping Engines.—Capstans.—Traversers.—Jacks.—Weighing Machines.—Riveters and Shop Tools.—Punching, Shearing, and Flanging Machines.—Cranes.—Coal Discharging Machines.—Drills and Cutters.—Pile Drivers, Excavators, &c.—Hydraulic Machinery applied to Bridges, Dock Gates, Wheels and Turbines.—Shields.—Various Systems and Power Installations—Meters, &c.—INDEX.

"The standard work on the application of water power."—*Cassier's Magazine.*

Second Edition, Greatly Enlarged. With Frontispiece, several Plates, and over 250 Illustrations. 21s. net.

THE PRINCIPLES AND CONSTRUCTION OF PUMPING MACHINERY

(STEAM AND WATER PRESSURE).

With Practical Illustrations of ENGINES and PUMPS applied to MINING, TOWN WATER SUPPLY, DRAINAGE of Lands, &c., also Economy and Efficiency Trials of Pumping Machinery.

BY HENRY DAVEY,

Member of the Institution of Civil Engineers, Member of the Institution of Mechanical Engineers, F.G.S., &c.

CONTENTS—Early History of Pumping Engines—Steam Pumping Engines—Pumps and Pump Valves—General Principles of Non-Rotative Pumping Engines—The Cornish Engine, Simple and Compound—Types of Mining Engines—Pit Work—Shaft Sinking—Hydraulic Transmission of Power in Mines—Electric Transmission of Power—Valve Gears of Pumping Engines—Water Pressure Pumping Engines—Water Works Engines—Pumping Engine Economy and Trials of Pumping Machinery—Centrifugal and other Low-Lift Pumps—Hydraulic Rams, Pumping Mains, &c.—INDEX.

"By the 'one English Engineer who probably knows more about Pumping Machinery than ANY OTHER' . . . A VOLUME RECORDING THE RESULTS OF LONG EXPERIENCE AND STUDY."—*The Engineer.*

In Large Crown 8vo. Handsome Cloth. Fully Illustrated.

SEA WATER DISTILLATION.

By FRANK NORMANDY, of the Middle Temple, Barrister-at-Law.

CONTENTS.—Distilling Machinery.—Sea Water.—Steam.—Multiple Distillation.—The Evaporator.—The Distilling Condenser.—Pumping Machinery.—Useful Memoranda:—The Filter, Prevention of Corrosion and Decay of Metals, Removal of Scale, Cleaning, Overhauling, &c.—INDEX.

LONDON: CHARLES GRIFFIN & CO., LIMITED, EXETER STREET STRAND.

In Large Svo. Handsome Cloth. Profusely Illustrated. In Two VOLUMES, Each Complete in itself, and SOLD SEPARATELY.

THE DESIGN AND CONSTRUCTION OF SHIPS.

By JOHN HARVARD BILES, M.Inst.N.A.,

Professor of Naval Architecture in Glasgow University.

Volume I.—CALCULATIONS AND STRENGTH. With 36 Folding Plates, and 245 other Illustrations. Complete in itself, with Index. 25s. net.

CONTENTS.—PART I.—Areas, Volumes, and Centres of Gravity. PART II.—Ship Calculations. PART III.—Strength of Ships.

“No teacher of naval architecture nor scientifically-equipped student can afford to be without this volume . . . will doubtless remain the standard for many years”—*Times*.

Volume II., dealing with Stability, Waves, Oscillations, Resistance and Propulsion, Design and Construction, is in active preparation, and will be ready very shortly.

BY PROFESSOR BILES.

LECTURES ON THE MARINE STEAM TURBINE.

With 131 Illustrations. Price 6s. net.

See page 28.

Royal Svo, Handsome Cloth. With numerous Illustrations and Tables. 25s.

THE STABILITY OF SHIPS.

BY

SIR EDWARD J. REED, K.C.B., F.R.S., M.P.,

KNIGHT OF THE IMPERIAL ORDERS OF ST. STANILAUS OF RUSSIA; FRANCIS JOSEPH OF AUSTRIA; MEDJIDIE OF TURKEY; AND RISING SUN OF JAPAN; VICE-PRESIDENT OF THE INSTITUTION OF NAVAL ARCHITECTS.

“SIR EDWARD REED'S ‘STABILITY OF SHIPS’ IS INVALUABLE. The NAVAL ARCHITECT will find brought together and ready to his hand, a mass of information which he would otherwise have to seek in an almost endless variety of publications, and some of which he would possibly not be able to obtain at all elsewhere.”—*Steamship*.

In Crown Svo. Handsome Cloth. Fully Illustrated.

HYDROGRAPHIC SURVEYING.

For the Use of Beginners, Amateurs, and Port and Harbour Masters.

By COMMANDER S. MESSUM, R.N.,

Instructor in Nautical Surveying, R.N. College, Greenwich.

CONTENTS.—Sextant.—Protractor.—Station Pointer.—Theodolite.—Projections.—Symbols and Abbreviations.—Plotting and Triangulation of a Small Plan.—Mast-head Angle Survey.—Meridian Distances.—APPENDIX.—INDEX.

LONDON: CHARLES GRIFFIN & CO., LIMITED, EXETER STREET, STRAND.

WORKS BY THOMAS WALTON,
NAVAL ARCHITECT.

FOURTH EDITION. Illustrated with Plates, Numerous Diagrams, and
Figures in the Text. 18s. net.

**STEEL SHIPS;
THEIR CONSTRUCTION AND MAINTENANCE.**

*A Manual for Shipbuilders, Ship Superintendents, Students,
and Marine Engineers.*

BY THOMAS WALTON, NAVAL ARCHITECT,
AUTHOR OF "KNOW YOUR OWN SHIP."

CONTENTS.—I. Manufacture of Cast Iron, Wrought Iron, and Steel.—Com-
position of Iron and Steel, Quality, Strength, Tests, &c. II. Classification of
Steel Ships. III. Considerations in making choice of Type of Vessel.—Framing
of Ships. IV. Strains experienced by Ships.—Methods of Computing and
Comparing Strengths of Ships. V. Construction of Ships.—Alternative Modes
of Construction.—Types of Vessels.—Turret, Self Trimming, and Trunk
Steamers, &c.—Rivets and Rivetting, Workmanship. VI. Pumping Arrange-
ments. VII. Maintenance.—Prevention of Deterioration in the Hulls of
Ships.—Cement, Paint, &c.—INDEX.

So thorough and well written is every chapter in the book that it is difficult to select
any of them as being worthy of exceptional praise. Altogether, the work is excellent, and
will prove of great value to those for whom it is intended.—*The Engineer.*

In Handsome Cloth. Very fully Illustrated. 7s. 6d. net.

PRESENT-DAY SHIPBUILDING.

For Shipyard Students, Ships' Officers, and Engineers.

BY THOS. WALTON.

GENERAL CONTENTS.—Classification.—Materials used in Shipbuilding.—
Alternative Modes of Construction.—Details of Construction.—Framing,
Plating, Rivetting, Stem Frames, Twin-Screw Arrangements, Water
Ballast Arrangements, Loading and Discharging Gear, &c.—Types of
Vessels, including Atlantic Liners, Cargo Steamers, Oil carrying Steamers,
Turret and other Self Trimming Steamers, &c.—INDEX.

"Simple language . . . clear and easily followed illustrations."—*Times
Engineering Supplement.*

"We heartily recommend it to all who have to do with ships."—*Steamship.*

NINTH EDITION. *Illustrated. Handsome Cloth, Crown 8vo. 7s. 6d.*

The Chapters on Tonnage and Freeboard have been brought thoroughly
up to date, and embody the latest (1906) Board of Trade Regulations on
these subjects.

KNOW YOUR OWN SHIP.

BY THOMAS WALTON, NAVAL ARCHITECT.

*Specially arranged to suit the requirements of Ships' Officers, Shipowners,
Superintendents, Draughtsmen, Engineers, and Others,*

CONTENTS.—Displacement and Deadweight.—Moments.—Buoyancy.—Strain.—
Structure.—Stability.—Rolling.—Ballasting.—Loading.—Shifting Cargoes.—Effect of
Admission of Water into Ship.—Trim Tonnage.—Freeboard (Load-line).—Calculations.—
Set of Calculations from Actual Drawings.—INDEX.

"The work is of the highest value, and all who go down to the sea in ships should make them-
selves acquainted with it."—*Shipping World* (on the new edition).

LONDON: CHARLES GRIFFIN & CO., LIMITED, EXETER STREET, STRAND.

GRIFFIN'S NAUTICAL SERIES.

EDITED BY EDW. BLACKMORE,
Master Mariner, First Class Trinity House Certificate, Assoc. Inst. N.A.;
AND WRITTEN, MAINLY, by SAILORS for SAILORS.

"THIS ADMIRABLE SERIES."—*Fairplay*. "A VERY USEFUL SERIES."—*Nature*.
"EVERY SHIP should have the WHOLE SERIES as a REFERENCE LIBRARY. HAND-
SOMELY BOUND, CLEARLY PRINTED and ILLUSTRATED."—*Liverpool Journ. of Commerce*.

The British Mercantile Marine: An Historical Sketch of its Rise
and Development. By the EDITOR, CAPT. BLACKMORE. 3s. 6d.

"Captain Blackmore's SPLENDID BOOK . . . contains paragraphs on every point
of interest to the Merchant Marine. The 243 pages of this book are THE MOST VALU-
ABLE to the sea captain that have EVER been COMPILED."—*Merchant Service Review*.

Elementary Seamanship. By D. WILSON-BARKER, Master Mariner,
F.R.S.E., F.R.G.S. With numerous Plates, two in Colours, and Frontispiece.
SIXTH EDITION, Thoroughly Revised. With additional Illustrations, &c. 6s.

"THIS ADMIRABLE MANUAL, by CAPT. WILSON BARKER, of the 'Worcester,' seems
to us PERFECTLY DESIGNED."—*Athenæum*.

Know Your Own Ship: A Simple Explanation of the Stability, Con-
struction, Tonnage, and Freeboard of Ships. By THOS. WALTON, Naval Architect.
NINTH EDITION. 7s. 6d.

"MR. WALTON'S book will be found VERY USEFUL."—*The Engineer*.

Navigation: Theoretical and Practical. By D. WILSON-BARKER
and WILLIAM ALLINGHAM. SECOND EDITION, Revised. 3s. 6d.

"PRECISELY the kind of work required for the New Certificates of competency.
Candidates will find it INVALUABLE."—*Dundee Advertiser*.

Marine Meteorology: For Officers of the Merchant Navy. By
WILLIAM ALLINGHAM, First Class Honours, Navigation, Science and Art Department.

With Illustrations and Maps, and facsimile reproduction of log page. 7s. 6d.

"Quite the BEST PUBLICATION on this subject."—*Shipping Gazette*.

Latitude and Longitude: How to find them. By W. J. MILLAR,
C.E. SECOND EDITION, Revised. 2s.

"Cannot but prove an acquisition to those studying Navigation."—*Marine Engineer*

Practical Mechanics: Applied to the requirements of the Sailor.
By THOS. MACKENZIE, Master Mariner, F.R.A.S. THIRD EDITION, Revised. 3s. 6d.

"WELL WORTH the money . . . EXCEEDINGLY HELPFUL."—*Shipping World*.

Trigonometry: For the Young Sailor, &c. By RICH. C. BUCK, of the
Thames Nautical Training College, H.M.S. "Worcester." THIRD EDITION, Revised.
Price 3s. 6d.

"THIS EMINENTLY PRACTICAL and reliable volume."—*Schoolmaster*.

Practical Algebra. By RICH. C. BUCK. Companion Volume to the
above, for Sailors and others. SECOND EDITION, Revised. Price 3s. 6d.

"It is JUST THE BOOK for the young sailor mindful of progress."—*Nautical Magazine*.

The Legal Duties of Shipmasters. By BENEDICT WM. GINSBURG,
M.A., LL.D., of the Inner Temple and Northern Circuit; Barrister-at-Law. SECOND
EDITION, Thoroughly Revised and Enlarged. Price 4s. 6d.

"INVALUABLE to masters. . . . We can fully recommend it."—*Shipping Gazette*.

A Medical and Surgical Help for Shipmasters. Including First
Aid at Sea. By WM. JOHNSON SMITH, F.R.C.S., Principal Medical Officer, Seamen's
Hospital, Greenwich. THIRD EDITION, Thoroughly Revised. 6s.

"SOUND, JUDICIOUS, REALLY HELPFUL."—*The Lancet*.

LONDON: CHARLES GRIFFIN & CO., LIMITED, EXETER STREET, STRAND.

GRIFFIN'S NAUTICAL SERIES.

Introductory Volume. Price 3s. 6d.

T H E

British Mercantile Marine.

BY EDWARD BLACKMORE,

MASTER MARINER; ASSOCIATE OF THE INSTITUTION OF NAVAL ARCHITECTS;
MEMBER OF THE INSTITUTION OF ENGINEERS AND SHIPBUILDERS
IN SCOTLAND; EDITOR OF GRIFFIN'S "NAUTICAL SERIES."

GENERAL CONTENTS.—**HISTORICAL:** From Early Times to 1486—Progress under Henry VIII.—To Death of Mary—During Elizabeth's Reign—Up to the Reign of William III.—The 18th and 19th Centuries—Institution of Examinations—Rise and Progress of Steam Propulsion—Development of Free Trade—Shipping Legislation, 1862 to 1875—"Locksley Hall" Case—Shipmasters' Societies—Loading of Ships—Shipping Legislation, 1884 to 1894—Statistics of Shipping. **THE PERSONNEL:** Shipowners—Officers—Mariners—Duties and Present Position. **EDUCATION:** A Seaman's Education: what it should be—Present Means of Education—Hints. **DISCIPLINE AND DUTY—**Postscript—The Serious Decrease in the Number of British Seamen, a Matter demanding the Attention of the Nation.

"INTERESTING AND INSTRUCTIVE . . . may be read WITH PROFIT and ENJOYMENT."—*Glasgow Herald.*

"EVERY BRANCH of the subject is dealt with in a way which shows that the writer 'knows the ropes' familiarly."—*Scotsman.*

"THIS ADMIRABLE book . . . TEEMS with useful information—Should be in the hands of every Sailor."—*Western Morning News.*

SIXTH EDITION, *Thoroughly Revised. With Additional Illustrations and a new Chapter on Clouds.*

A MANUAL OF
ELEMENTARY SEAMANSHIP.

BY

D. WILSON-BARKER, MASTER MARINER; F.R.S.E., F.R.G.S., &c., &c.
YOUNGER BROTHER OF THE TRINITY HOUSE.

With Frontispiece, Numerous Plates (Two in Colours), and Illustrations
in the Text.

GENERAL CONTENTS.—The Building of a Ship; Parts of Hull, Mast, &c.—Ropes, Knots, Splicing, &c.—Gear, Lead and Log, &c.—Rigging, Anchors—Sailmaking—The Sails, &c.—Handling of Boats under Sail—Signals and Signalling—Rule of the Road—Keeping and Relieving Watch—Points of Etiquette—Glossary of Sea Terms and Phrases—Index.

. The volume contains the NEW RULES OF THE ROAD.

"THIS ADMIRABLE MANUAL, by CAPT. WILSON-BARKER of the 'Worcester,' seems to us PERFECTLY DESIGNED, and holds its place excellently in 'GRIFFIN'S NAUTICAL SERIES.' . . . Although intended for those who are to become Officers of the Merchant Navy, it will be found useful by ALL YACHTSMEN."—*Athenæum.*

. For complete List of GRIFFIN'S NAUTICAL SERIES, see p. 39.

LONDON: CHARLES GRIFFIN & CO., LIMITED, EXETER STREET, STRAND.

GRIFFIN'S NAUTICAL SERIES.SECOND EDITION, *Revised and Illustrated.* Price 3s. 6d.**NAVIGATION:
PRACTICAL AND THEORETICAL.**

By DAVID WILSON-BARKER, R.N.R., F.R.S.E., &c., &c.,

AND

WILLIAM ALLINGHAM,

FIRST-CLASS HONOURS, NAVIGATION, SCIENCE AND ART DEPARTMENT.

With Numerous Illustrations and Examination Questions.

GENERAL CONTENTS.—Definitions—Latitude and Longitude—Instruments of Navigation—Correction of Courses—Plane Sailing—Traverse Sailing—Day's Work—Parallel Sailing—Middle Latitude Sailing—Mercator's Chart—Mercator Sailing—Current Sailing—Position by Bearings—Great Circle Sailing—The Tides—Questions—Appendix: Compass Error—Numerous Useful Hints &c.—Index.

"PRECISELY the kind of work required for the New Certificates of competency in grades from Second Mate to extra Master. . . . Candidates will find it INVALUABLE."—*Dundee Advertiser.*

"A CAPITAL LITTLE BOOK . . . specially adapted to the New Examinations. The Authors are CAPT. WILSON-BARKER (Captain-Superintendent of the Nautical College, H.M.S. 'Worcester,' who has had great experience in the highest problems of Navigation), and MR. ALLINGHAM, a well-known writer on the Science of Navigation and Nautical Astronomy."—*Shipping World.*

*Handsome Cloth. Fully Illustrated. Price 7s. 6d.***MARINE METEOROLOGY,**

FOR OFFICERS OF THE MERCHANT NAVY.

By WILLIAM ALLINGHAM,

Joint Author of "Navigation, Theoretical and Practical."

With numerous Plates, Maps, Diagrams, and Illustrations, and a facsimile Reproduction of a Page from an actual Meteorological Log-Book.

SUMMARY OF CONTENTS.

INTRODUCTORY.—Instruments Used at Sea for Meteorological Purposes.—Meteorological Log-Books.—Atmospheric Pressure.—Air Temperatures.—Sea Temperatures.—Winds.—Wind Force Scales.—History of the Law of Storms.—Hurricanes, Seasons, and Storm Tracks.—Solution of the Cyclone Problem.—Ocean Currents.—Icebergs.—Synchro-nous Charts.—Dew, Mists, Fogs, and Haze.—Clouds.—Rain, Snow, and Hail.—Mirage, Rainbows, Coronas, Halos, and Meteors.—Lightning, Comets, and Auroras.—QUESTIONS.—APPENDIX.—INDEX.

"Quite the BEST publication, and certainly the MOST INTERESTING, on this subject ever presented to Nautical men."—*Shipping Gazette.*

* * For Complete List of GRIFFIN'S NAUTICAL SERIES, see p. 39.

LONDON: CHARLES GRIFFIN & CO., LIMITED, EXETER STREET, STRAND.

GRIFFIN'S NAUTICAL SERIES.

THIRD EDITION, REVISED. With Numerous Illustrations. Price 3s. 6d.

PRACTICAL MECHANICS:
Applied to the Requirements of the Sailor.By THOS. MACKENZIE, *Master Mariner, F.R.A.S.*

GENERAL CONTENTS.—Resolution and Composition of Forces—Work done by Machines and Living Agents—The Mechanical Powers: The Lever; Derricks as Bent Levers—The Wheel and Axle: Windlass; Ship's Capstan; Crab Winch—Tackles: the "Old Man"—The Inclined Plane; the Screw—The Centre of Gravity of a Ship and Cargo—Relative Strength of Rope: Steel Wire, Manilla, Hemp, Coir—Derricks and Shears—Calculation of the Cross-breaking Strain of Fir Spar—Centre of Effort of Sails—Hydrostatics: the Diving-bell; Stability of Floating Bodies; the Ship's Pump, &c.

"WELL WORTH the money . . . will be found EXCEEDINGLY HELPFUL."—*shipping World.*

"NO SHIPS' OFFICERS' BOOKCASE will henceforth be complete without CAPTAIN MACKENZIE'S 'PRACTICAL MECHANICS.' Notwithstanding my many years' experience at sea, it has told me *how much more there is to acquire.*"—(Letter to the Publishers from a Master Mariner).

WORKS BY RICHARD C. BUCK,

of the Thames Nautical Training College, H.M.S. 'Worcester.'

A MANUAL OF TRIGONOMETRY:*With Diagrams, Examples, and Exercises. Price 3s. 6d.*

THIRD EDITION, Revised and Corrected.

* * Mr. Buck's Text-Book has been SPECIALLY PREPARED with a view to the Examinations of the Board of Trade, in which Trigonometry is an obligatory subject.

"THIS EMINENTLY PRACTICAL and RELIABLE VOLUME."—*Schoolmaster.*

A MANUAL OF ALGEBRA.*Designed to meet the Requirements of Sailors and others.*

SECOND EDITION, Revised. Price 3s. 6d.

* * These elementary works on ALGEBRA and TRIGONOMETRY are written specially for those who will have little opportunity of consulting a Teacher. They are books for "SELF HELP." All but the simplest explanations have, therefore, been avoided, and ANSWERS to the Exercises are given. Any person may readily, by careful study, become master of their contents, and thus lay the foundation for a further mathematical course, if desired. It is hoped that to the younger Officers of our Mercantile Marine they will be found decidedly serviceable. The Examples and Exercises are taken from the Examination Papers set for the Cadets of the "Worcester."

"Clearly arranged, and well got up. . . . A first-rate Elementary Algebra."—*Nautical Magazine.*

SECOND EDITION, Revised. With Diagrams. Price 2s.

LATITUDE AND LONGITUDE: How to Find them.

By W. J. MILLAR, C.E.,

Late Secretary to the Inst. of Engineers and Shipbuilders in Scotland.

"CONCISELY and CLEARLY WRITTEN . . . cannot but prove an acquisition to those studying Navigation."—*Marine Engineer.*

"Young Seamen will find it HANDY and USEFUL, SIMPLE and CLEAR."—*The Engineer.*

* * For complete List of GRIFFIN'S NAUTICAL SERIES. see p. 39.

LONDON: CHARLES GRIFFIN & CO., LIMITED, EXETER STREET, STRAND.

GRIFFIN'S NAUTICAL SERIES.

SECOND EDITION, Revised and Extended. In Crown 8vo. Price 4s. 6d.

THE LEGAL DUTIES OF SHIPMASTERS.

BY BENEDICT WM. GINSBURG, M.A., LL.D. (CANTAB.).

Of the Inner Temple and Northern Circuit; Barrister-at-Law.

General Contents.—The Qualification for the Position of Shipmaster—The Contract with the Shipowner—The Master's Duty in respect of the Crew: Engagement; Apprentices; Discipline; Provisions, Accommodation, and Medical Comforts; Payment of Wages and Discharge—The Master's Duty in respect of the Passengers—The Master's Financial Responsibilities—The Master's Duty in respect of the Cargo—The Master's Duty in Case of Casualty—The Master's Duty to certain Public Authorities—The Master's Duty in relation to Pilots, Signals, Flags, and Light Dues—The Master's Duty upon Arrival at the Port of Discharge—Appendices relative to certain Legal Matters: Board of Trade Certificates, Dietary Scales, Stowage of Grain Cargoes, Load Line Regulations, Life-saving Appliances, Carriage of Cattle at Sea, &c., &c.—Copious Index.

"No intelligent Master should fail to add this to his list of necessary books. A few more of it may SAVE A LAWYER'S FEE, BESIDES ENDLESS WORRY."—*Liverpool Journal of Commerce.*

FIRST AID AT SEA.

THIRD EDITION, Revised. With Coloured Plates and Numerous Illustrations, and comprising the latest Regulations Respecting the Carriage of Medical Stores on Board Ship. Price 6s.

A MEDICAL AND SURGICAL HELP**FOR SHIPMASTERS AND OFFICERS
IN THE MERCHANT NAVY.**

BY WM. JOHNSON SMITH, F.R.C.S.,

Principal Medical Officer, Seamen's Hospital, Greenwich.

* * The attention of all interested in our Merchant Navy is requested to this exceedingly useful and valuable work. It is needless to say that it is the outcome of many years' PRACTICAL EXPERIENCE amongst Seamen.

"SOUND, JUDICIOUS, REALLY HELPFUL."—*The Lancet.*

NINTH EDITION. Revised, with Chapters on Trim, Buoyancy, and Calculations. Numerous Illustrations. Handsome Cloth, Crown 8vo. Price 7s. 6d.

KNOW YOUR OWN SHIP.

BY THOMAS WALTON, NAVAL ARCHITECT.

Specially arranged to suit the requirements of Ships' Officers, Shipowners, Superintendents, Draughtsmen, Engineers, and Others.

This work explains, in a simple manner, such important subjects as:—Displacement.—Deadweight.—Tonnage.—Freeboard.—Moments.—Buoyancy.—Strain.—Structure.—Stability.—Rolling.—Ballasting.—Loading.—Shifting Cargoes.—Admission of Water.—Sail Area.—&c.

"The little book will be found EXCEEDINGLY HANDY by most officers and officials connected with shipping. . . . Mr. Walton's work will obtain LASTING SUCCESS, because of its unique fitness for those for whom it has been written."—*Shipping World.*

BY THE SAME AUTHOR.**STEEL SHIPS: Their Construction and Maintenance.**

(See page 38.)

* * For Complete List of GRIFFIN'S NAUTICAL SERIES, see p. 39.

LONDON: CHARLES GRIFFIN & CO., LIMITED, EXETER STREET, STRAND.

SIXTEENTH EDITION, *Thoroughly Revised. Large 8vo, Cloth.*
 pp. i-xxiv+712. *With 250 Illustrations, reduced from*
Working Drawings, and 8 Plates. 21s. net.

A MANUAL OF MARINE ENGINEERING:

COMPRISING THE DESIGNING, CONSTRUCTION, AND
WORKING OF MARINE MACHINERY.

By **A. E. SEATON, M.I.C.E., M.I.Mech.E., M.I.N.A.**

GENERAL CONTENTS.—PART I.—Principles of Marine Propulsion.
 PART II.—Principles of Steam Engineering. PART III.—Details of
 Marine Engines: Design and Calculations for Cylinders, Pistons, Valves,
 Expansion Valves, &c. PART IV.—Propellers. PART V.—Boilers.
 PART VI.—Miscellaneous.

"The Student, Draughtsman, and Engineer will find this work the MOST VALUABLE
 HANDBOOK of Reference on the Marine Engine now in existence."—*Marine Engineer.*

NINTH EDITION, *Thoroughly Revised. Pocket-Size, Leather. 8s. 6d.*

A POCKET-BOOK OF MARINE ENGINEERING RULES AND TABLES,

FOR THE USE OF

**Marine Engineers, Naval Architects, Designers, Draughtsmen,
Superintendents and Others.**

By **A. E. SEATON, M.I.C.E., M.I.Mech.E., M.I.N.A.,**

AND

H. M. ROUNTHWAITE, M.I.Mech.E., M.I.N.A.

"The best book of its kind, and the information is both up-to-date and reliable."—
Engineer.

In Large 8vo. *Handsome Cloth. With Frontispiece, 6 Plates,
65 other Illustrations, and 60 Tables. 12s. 6d. net.*

THE SCREW PROPELLER

And other Competing Instruments for Marine Propulsion.

By **A. E. SEATON, M.INST.C.E., M.I.MECH.E., M.I.N.A.**

In Pocket Size. *With 368 Pages. 3s. 6d. net.*

ENGLISH-SPANISH and SPANISH-ENGLISH.

SEA TERMS AND PHRASES.

By **FLEET-PAYMASTER GRAHAM-HEWLETT.**

"Most complete . . . useful . . . we can heartily recommend it."—*Steamship.*

In Crown 8vo. *Handsome Cloth. Many Diagrams. 2s. 6d. net.*

DEFINITIONS IN NAVIGATION AND NAUTICAL ASTRONOMY.

By **P. GROVES-SHOWELL,**

Head of the Navigation Department, L.C.C. School, Poplar.

"Mr. Groves-Showell writes with a full knowledge of his subject, and with admirable
 clearness."—*Shipbuilder.*

LONDON: CHARLES GRIFFIN & CO., LIMITED, EXETER STREET, STRAND.

SECOND EDITION, *Revised.* In Crown 8vo, extra, with Diagrams and Folding-Plate. 7s. 6d. net.

**THE CALCULUS FOR ENGINEERS
AND PHYSICISTS,
INTEGRATION AND DIFFERENTIATION,
With Applications to Technical Problems;
AND
CLASSIFIED REFERENCE LIST OF INTEGRALS.**

By PROF. ROBERT H. SMITH, A.M.INST.C.E., M.I.MECH.E., &c.

"Interesting diagrams, with practical illustrations of actual occurrence, are to be found here in abundance. THE VERY COMPLETE CLASSIFIED REFERENCE TABLE will prove very useful in saving the time of those who want an integral in a hurry."—*The Engineer.*

In 4to, Boards. 7s. 6d.

**MEASUREMENT CONVERSIONS
(English and French):**

43 GRAPHIC TABLES OR DIAGRAMS, ON 28 PLATES.

Showing at a glance the MUTUAL CONVERSION OF MEASUREMENTS
in DIFFERENT UNITS

**Of Lengths, Areas, Volumes, Weights, Stresses, Densities, Quantities
of Work, Horse Powers, Temperatures, &c.**

For the use of Engineers, Surveyors, Architects, and Contractors.

By PROF. ROBERT H. SMITH, A.M.INST.C.E., M.I.MECH.E., &c.

* * * These TABLES form the most unique and comprehensive collection ever placed before the profession. By their use much time and labour will be saved, and the chances of error in calculation diminished.

THIRD EDITION. Pocket Size, Leather Limp, with Gilt Edges and Rounded Corners, printed on Special Thin Paper, with Illustrations, pp. i-xii + 834. Price 18s. net.

(THE NEW "NYSTROM")

THE MECHANICAL ENGINEER'S REFERENCE BOOK.

By HENRY HARRISON SUPLEE, B.Sc., M.E.

"We feel sure it will be of great service to mechanical engineers."—*Engineering.*

**THE STUDENT'S MECHANICS:
An Introduction to the Study of Force and Motion.**

By WALTER R. BROWNE, M.A., M.INST.C.E.

With Diagrams. Crown 8vo, Cloth, 4s. 6d.

"Clear in style and practical in method, 'THE STUDENT'S MECHANICS' is cordially to be recommended from all points of view."—*Athenæum.*

By THE SAME AUTHOR.

FOUNDATIONS OF MECHANICS.

Papers reprinted from the *Engineer.* In Crown 8vo, 1s.

LONDON: CHARLES GRIFFIN & CO., LIMITED, EXETER STREET, STRAND.

ELECTRICAL ENGINEERING.

SECOND EDITION, Revised. In Large 8vo. Handsome Cloth. Profusely Illustrated with Plates, Diagrams, and Figures. 24s. net.

CENTRAL ELECTRICAL STATIONS:

Their Design, Organisation, and Management.

By CHAS. H. WORDINGHAM, A.K.C., M. INST. C.E., M. INST. MECH. E.,
Late Memb. of Council Inst. E.E., and Electrical Engineer to the City of Manchester;
Electrical Engineer-in-Chief to the Admiralty.

"One of the MOST VALUABLE CONTRIBUTIONS to Central Station literature we have had for some time."—*Electricity*.

In Large 8vo. Handsome Cloth. Profusely Illustrated. 12s. 6d. net.

ELECTRICITY CONTROL.

A Treatise on Electric Switchgear and Systems of Electric Transmission.

By LEONARD ANDREWS,

Associate Member of the Institution of Civil Engineers, Member of the Institution of Electrical Engineers, &c

General Principles of Switchgear Design.—Constructional Details—Circuit Breakers or Arc Interrupting Devices.—Automatically Operated Circuit-Breakers.—Alternating Reverse Current Devices.—Arrangement of Bus Bars, and Apparatus for Parallel Running.—General Arrangement of Controlling Apparatus for High Tension Systems.—General Arrangement of Controlling Apparatus for Low Tension Systems.—Examples of Complete Installations.—Long Distance Transmission Schemes.

"Not often does the specialist have presented to him so satisfactory a book as this. . . . We recommend it without hesitation to Central Station Engineers, and, in fact, to anyone interested in the subject."—*Power*.

Large 8vo, Cloth, with 334 Pages and 307 Illustrations. 16s. net.

ELECTRICITY METERS.

By HENRY G. SOLOMON, A.M. Inst. E.E.

CONTENTS.—Introductory.—General Principles of Continuous-Current Meters.—Continuous-Current Quantity Meters.—Continuous-Energy Motor Meters.—Different Types—Special Purposes, *i.e.*, Battery Meters, Switchboard Meters, Tramcar Meters.—General Principles of Single- and Polyphase Induction Meters.—Single-phase Induction Meters.—Polyphase Meters.—Tariff Systems.—Prepayment Meters.—Tariff and Hour Meters.—Some Mechanical Features in Meter Design.—Testing Meters.—INDEX.

"An earnest and successful attempt to deal comprehensively with modern methods of measuring current or power in electrical installations."—*Engineering*.

In Large 8vo. Handsome Cloth. Fully Illustrated.

TRANSFORMERS.

By HERMANN BOHLE, M.I.E.E.,

Prof. of Electrotechnics, S.A. College, Cape Town,

AND PROFESSOR DAVID ROBERTSON, B.Sc., A.I.E.E., OF BRISTOL.

CONTENTS.—General Principles.—Magnetising and No-Load Currents.—Losses in Transformers.—Iron Losses.—Copper Losses.—Temperature Rise.—Magnetic Leakage.—Leakage Inductance.—Vector Diagrams for Transformers.—Systematic Testing of Transformers.—Insulating Materials.—Examples of Construction.—Design of Transformers.—Applications of Transformers.—Regulating and Phase-Changing Transformers.—INDEX.

LONDON: CHARLES GRIFFIN & CO., LIMITED, EXETER STREET, STRAND.

In Large Crown 8vo. Handsome Cloth. Fully Illustrated. 5s. net.

TELEGRAPHIC SYSTEMS, AND OTHER NOTES.

A Handbook of the Principles on which Telegraphic Practice is Based.

By ARTHUR CROTCH, of the Engineer-in-Chief's Department, G.P.O.

CONTENTS.—Batteries, Primary and Secondary.—Universal Battery Working.—Duplex Telegraphy.—Duplex and Quadruplex Telegraphy.—Automatic Telegraphy.—Multiplex Telegraphy.—The Hughes Type Printing Instrument.—The Baudot System.—The Murray Type Printing Telegraph.—Test and Battery Boxes.—Circuit Concentration, &c.—Repeaters.—Submarine Telegraphy.—Wireless Telegraphy.—INDEX.—LIST OF DIAGRAMS OF CONNECTIONS.

"This book is a particularly good one . . . we can thoroughly recommend it . . . a handy book of ready reference."—*Electrical Review*.

In Large 8vo. Profusely Illustrated. 8s. 6d. net.

WIRELESS TELEGRAPHY.

By GUSTAVE EICHHORN, Ph.D.

CONTENTS.—Oscillations.—Closed and Open Oscillation Systems.—Coupled Systems.—The Coupling Compensating the Aerial Wire.—The Receiver.—Comparative Measurement in the Sender.—Theoretical Results and Calculations in respect of Sender and Receiver.—Close- and Loose-Coupled Sender and Receiver.—Formulae.—The Ondameter.—Modern Apparatus and Methods of Working.—Conclusion.—Bibliography.—INDEX.

"Well written . . . and combines with a good deal of description a careful investigation of the fundamental theoretical phenomena."—*Nature*.

NINETEENTH EDITION. Leather, Pocket Size, with 810 pages. 8s. 6d.

A POCKET-BOOK OF ELECTRICAL RULES & TABLES

FOR THE USE OF ELECTRICIANS AND ENGINEERS.

By JOHN MUNRO, C.E., & PROF. JAMIESON, M.Inst.C.E., F.R.S.E.

"Wonderfully Perfect. . . . Worthy of the highest commendation we can give it."—*Electrician*.

GRIFFIN'S ELECTRICAL PRICE-BOOK: For Electrical, Civil, Marine, and Borough Engineers, Local Authorities, Architects, Railway Contractors, &c. Edited by H. J. DOWSING. SECOND EDITION. 8s. 6d.

ELECTRIC SMELTING AND REFINING. By Dr. W. BORCHERS and W. G. McMILLAN. [See p. 67.]

ELECTRO-METALLURGY, A Treatise on. By WALTER G. McMILLAN, F.I.C., F.C.S., and W. R. COOPER. [See p. 67.]

ELECTRICAL PRACTICE IN COLLIERIES. By D. BURNS, M.E., M.Inst.M.E. [See p. 57.]

ELECTRICAL SIGNALLING IN MINES. By GERALD J. HOOG-WINKEL, M.I.E.E., &c. [In Active Preparation.]

LONDON: CHARLES GRIFFIN & CO., LIMITED, EXETER STREET, STRAND.

In Four Volumes. Crown 8vo. Fully Illustrated. Sold Separately.

AN ELEMENTARY TEXT-BOOK OF PHYSICS.

By R. WALLACE STEWART, D.Sc. (LOND.)

JUST PUBLISHED. Cloth. With 142 Illustrations. 3s. 6d. net.

LIGHT.

CONTENTS. — Introductory. — Rectilinear Propagation of Light. — Photometry. — Reflection at Plane Surfaces. — Reflection at Spherical Surfaces. — Refraction. — Refraction through Lenses. — Dispersion. — INDEX.

Vol. II. With 141 Pages and 48 Illustrations. 2s. 6d. net.

SOUND.

CONTENTS. — Simple Harmonic Vibration. — Production of Sound. — Wave Motion. — Propagation of Sound. — Characteristics of Sound. — Reflection and Refraction of Sound. — Velocity of Sound in Air and Water. — Transverse Vibration of Strings. — Longitudinal Vibration of Rods and Columns of Air. — INDEX.

Other Volumes in Preparation, and which will be Published Shortly,

HEAT. MATTER.

In Large 8vo. With Bibliography, Illustrations in the Text, and Seven Plates. 12s. 6d.

THE MEAN DENSITY OF THE EARTH.

An Essay to which the Adams Prize was Adjudged in 1893 in the University of Cambridge.

By J. H. POYNTING, Sc.D., F.R.S.

"Cannot fail to be of great and general interest."—*Athenæum*.

JUST PUBLISHED. In Crown 8vo, Cloth. Illustrated with Diagrams. 3s. net.

THE FORCE OF THE WIND.

By HERBERT CHATLEY, B.Sc. ENG. (LOND.),

Professor of Civil Engineering, Tong Shan Engineering College, N. China.

CONTENTS. — Practical Importance of Wind Pressure. — Impulsive Force of the Wind. — Variations in Velocity. — Stream Line Theory. — Stress in Structures due to Wind. — Windmills. — Train and Motor Resistance. — Effect of Wind on Water. — Scouring Effect of Wind. — INDEX.

In Crown 8vo. Handsome Cloth. With 22 Diagrams.

STRESSES IN MASONRY.

By HERBERT CHATLEY, B.Sc. ENG. (LOND.).

CONTENTS. — Strength of Stone. — Walls. — Columns and Piers. — Brackets and Cantilevers. — Simple Arches. — Vaults and Skew Arches. — Domes. — Retaining Walls and Domes. — Artificial Stone. — Re-inforced Concrete. — INDEX.

LONDON: CHARLES GRIFFIN & CO., LIMITED, EXETER STREET, STRAND.

In Five Volumes. Large 8vo. Sold Separately.

A TEXT-BOOK OF PHYSICS.

By J. H. POYNTING, Sc.D., F.R.S.,

Professor of Physics, Birmingham University,

And Sir J. J. THOMSON, M.A., F.R.S.,

Professor of Experimental Physics in the University of Cambridge.

INTRODUCTORY VOLUME. FIFTH EDITION, Revised. Fully Illustrated.
10s. 6d.

PROPERTIES OF MATTER.

CONTENTS.—Gravitation.—The Acceleration of Gravity.—Elasticity.—Stresses and Strains.—Torsion.—Bending of Rods.—Spiral Springs.—Collision.—Compressibility of Liquids.—Pressures and Volumes of Gases.—Thermal Effects Accompanying Strain.—Capillarity.—Surface Tension.—Laplace's Theory of Capillarity.—Diffusion of Liquids—Diffusion of Gases.—Viscosity of Liquids.—INDEX.

"We regard this book as quite indispensable not merely to teachers but to physicists of every grade above the lowest."—*University Correspondent*.

VOLUME II. FIFTH EDITION. Fully Illustrated. Price 8s. 6d.

SOUND.

CONTENTS.—The Nature of Sound and its chief Characteristics.—The Velocity of Sound in Air and other Media.—Reflection and Refraction of Sound.—Frequency and Pitch of Notes.—Resonance and Forced Oscillations.—Analysis of Vibrations.—The Transverse Vibrations of Stretched Strings or Wires.—Pipes and other Air Cavities.—Rods.—Plates.—Membranes.—Vibrations maintained by Heat.—Sensitive Flames and Jets.—Musical Sound.—The Superposition of Waves.—INDEX.

"The work . . . may be recommended to anyone desirous of possessing an EASY UP-TO-DATE STANDARD TREATISE ON ACOUSTICS."—*Literature*.

VOLUME III. THIRD EDITION, Revised. Fully Illustrated. Price 15s.

HEAT.

CONTENTS.—Temperature.—Expansion of Solids.—Liquids.—Gases.—Circulation and Convection.—Quantity of Heat; Specific Heat.—Conductivity.—Forms of Energy; Conservation; Mechanical Equivalent of Heat.—The Kinetic Theory—Change of State; Liquid, Vapour.—Critical Points.—Solids and Liquids.—Atmospheric Conditions.—Radiation.—Theory of Exchanges.—Radiation and Temperature.—Thermodynamics.—Isothermal and Adiabatic Changes.—Thermodynamics of Changes of State, and Solutions.—Thermodynamics of Radiation.—INDEX.

"Well up-to-date, and extremely clear and exact throughout. . . . As clear as it would be possible to make such a text-book"—*Nature*.

Remaining Volumes in Preparation—

LIGHT; MAGNETISM AND ELECTRICITY.

LONDON: CHARLES GRIFFIN & CO., LIMITED, EXETER STREET, STRAND.

GRIFFIN'S LOCAL GOVERNMENT HANDBOOKS.

WORKS SUITABLE FOR MUNICIPAL AND COUNTY ENGINEERS,
ANALYSTS, AND OTHERS.

See also Davies' *Hygiene*, p. 99, and MacLeod's *Calculations*, p. 110 General Catalogue.

- Gas Manufacture (The Chemistry of).** A Handbook on the Production, Purification, and Testing of Illuminating Gas, and the Assay of Bye-Products. By W. J. A. BUTTERFIELD, M.A., F.I.C., F.C.S. With Illustrations. FOURTH EDITION, Revised. Vol. I., 7s. 6d. net. Vol. II., *in preparation*. [See page 77.]
- Water Supply:** A Practical Treatise on the Selection of Sources and the Distribution of Water. By REGINALD E. MIDDLETON, M.Inst.C.E., M.Inst.Mech.E., F.S.I. With Numerous Plates and Diagrams. Crown 8vo. 8s. 6d. net. [See page 77.]
- Central Electrical Stations:** Their Design, Organisation, and Management. By C. H. WORDINGHAM, A.K.C., M.I.C.E. SECOND EDITION. 24s. net. [See p. 46]
- Electricity Control.** By LEONARD ANDREWS, A.M.Inst.C.E., M.I.E.E. 12s. 6d. net. [See page 46.]
- Electricity Meters.** By HENRY G. SOLOMON, A.M.Inst.E.E. 16s. net. [See page 46.]
- Trades' Waste:** Its Treatment and Utilisation, with Special Reference to the Prevention of Rivers' Pollution. By W. NAYLOR, F.C.S., A.M.Inst.C.E. With Numerous Plates, Diagrams, and Illustrations. 21s. net. [See page 76.]
- Calcareous Cements:** Their Nature, Preparation, and Uses. With some Remarks upon Cement Testing. By GILBERT REDGRAVE, Assoc.Inst.C.E., and CHAS. SPACKMAN, F.C.S. SECOND EDITION. With Illustrations, Analytical Data, and Appendices on Costs, &c. 15s. net. [See page 76.]
- Road Making and Maintenance:** A Practical Treatise for Engineers, Surveyors, and others. With an Historical Sketch of Ancient and Modern Practice. By THOMAS AITKEN, Assoc.M.Inst.C.E., &c. SECOND EDITION, Revised and Enlarged. 21s. net. [See page 79.]
- The Principles of Sewage Treatment.** By Prof. DUNBAR, of Hamburg. Translated by H. T. CALVERT, M.Sc., Ph.D., F.I.C. 15s. net. [See page 76.]
- Light Railways at Home and Abroad.** By WILLIAM HENRY COLE, M.Inst.C.E., late Deputy Manager, North-Western Railway, India. Large 8vo, Handsome Cloth, Plates and illustrations. 16s. [See page 30.]
- Practical Sanitation:** A Handbook for Sanitary Inspectors and others interested in Sanitation. By GEO. REID, M.D., D.P.H., Medical Officer, Staffordshire County Council. With Appendix (re-written) on Sanitary Law, by Herbert Manley, M.A., M.B., D.P.H., Barrister-at-Law. THIRTEENTH EDITION, Thoroughly Revised. 6s. [See page 78.]
- Sanitary Engineering:** A Practical Manual of Town Drainage and Sewage and Refuse Disposal. By FRANCIS WOOD, A.M.Inst.C.E., F.G.S. SECOND EDITION, Revised. Fully Illustrated. 8s. 6d. net. [See page 75.]
- Dairy Chemistry:** A Practical Handbook for Dairy Managers, Chemists, and Analysts. By H. DROOP RICHMOND, F.I.C., Chemist to the Aylesbury Dairy Company. SECOND EDITION, Revised. With Tables, Illustrations, &c. Handsome Cloth. [See page 73.]
- Dairy Analysis:** The Laboratory Book of. By H. DROOP RICHMOND, F.I.C. Fully Illustrated, Cloth. 2s. 6d. net. [See page 73.]
- Milk: Its Production and Uses.** With Chapters on Dairy Farming, The Diseases of Cattle, and on the Hygiene and Control of Supplies. By EDWARD F. WILLOUGHBY, M.D. (Lond.), D.P.H. (Lond. and Camb.), 6s. net. [See page 73.]
- Flesh Foods:** With Methods for their Chemical, Microscopical, and Bacteriological Examination. A Handbook for Medical Men, Inspectors, Analysts, and others. By C. AINSWORTH MITCHELL, B.A., F.I.C., Mem. Council Soc. of Public Analysts. With numerous Illustrations and a coloured Plate. 10s. 6d. [See page 72.]
- Foods:** Their Composition and Analysis. By A. WYNTER BLYTH, M.R.C.S., F.C.S., Public Analyst for the County of Devon, and M. W. BLYTH, B.A., B.Sc. With Tables, Folding Plate, and Frontispiece. FIFTH EDITION, Thoroughly Revised. 21s. [See page 72.]

LONDON: CHARLES GRIFFIN & CO., LIMITED, EXETER STREET, STRAND.

Demy 8vo, Handsome cloth, 34s.

Stratigraphical Geology & Palæontology,

ON THE BASIS OF PHILLIPS.

By ROBERT ETHERIDGE, F.R.S.,

OF THE NATURAL HIST. DEPARTMENT, BRITISH MUSEUM, LATE PALÆONTOLOGIST TO THE GEOLOGICAL SURVEY OF GREAT BRITAIN, PAST PRESIDENT OF THE GEOLOGICAL SOCIETY, ETC.

With Map, Numerous Tables, and Thirty-six Plates.

"No such compendium of geological knowledge has ever been brought together before."—*Westminster Review*.

"If PROF. SRELEY's volume was remarkable for its originality and the breadth of its views. Mr. ETHERIDGE fully justifies the assertion made in his preface that his book differs in construction and detail from any known manual. . . . Must take HIGH RANK AMONG WORKS OF REFERENCE."—*Athenæum*.

AIDS IN PRACTICAL GEOLOGY:

WITH A SECTION ON PALÆONTOLOGY.

By PROFESSOR GRENVILLE COLE, M.R.I.A., F.G.S.

FIFTH EDITION, Thoroughly Revised. With Frontispiece and Illustrations. Cloth. 10s. 6d.

GENERAL CONTENTS.—

- PART I.—SAMPLING OF THE EARTH'S CRUST.
- PART II.—EXAMINATION OF MINERALS.
- PART III.—EXAMINATION OF ROCKS.
- PART IV.—EXAMINATION OF FOSSILS.

"DESERVING OF THE HIGHEST PRAISE. Here indeed are 'Aids' INNUMERABLE and INVALUABLE. All the directions are given with the utmost clearness and precision."—*Athenæum*.

"That the work deserves its title, that it is full of 'Aids,' and in the highest degree PRACTICAL," will be the verdict of all who use it."—*Nature*.

OPEN-AIR STUDIES IN GEOLOGY:

An Introduction to Geology Out-of-doors.

By PROFESSOR GRENVILLE COLE, M.R.I.A., F.G.S.

For details, see Griffin's Introductory Science Series, p 85.

Crown 8vo. Handsome Cloth. 2s. 6d.

RESEARCHES ON THE PAST AND PRESENT HISTORY

OF

THE EARTH'S ATMOSPHERE.

Including the latest Discoveries and their Practical Applications.

By DR. THOMAS LAMB PHIPSON.

PART I.—The Earth's Atmosphere in Remote Geological Periods.

PART II.—The Atmosphere of our present period. Appendices; Index.

"The book should prove of interest to general readers, as well as to meteorologists and other students of science."—*Nature*.

LONDON: CHARLES GRIFFIN & CO., LIMITED, EXETER STREET, STRAND.

GRIFFIN'S "NEW LAND" SERIES.

Practical Hand-Books for the Use of Prospectors, Explorers, Settlers, Colonists, and all Interested in the opening up and Development of New Lands.

EDITED BY GRENVILLE A. J. COLE, M.R.I.A., F.G.S.,
Professor of Geology in the Royal College of Science for Ireland, and Examiner in the University of London.

In Crown 8vo. Handsome Cloth. 5s.
With Numerous Maps Specially Drawn and Executed for this Work.

NEW LANDS:

THEIR RESOURCES AND PROSPECTIVE ADVANTAGES.

By HUGH ROBERT MILL, D.Sc., LL.D., F.R.S.E.,

"A want admirably supplied. . . . Has the advantage of being written by a progressed Geographer."—*Geographical Journal*.

With many Engravings and Photographs. Handsome Cloth, 4s. 6d.

FOOD SUPPLY.

By ROBERT BRUCE,

Agricultural Superintendent to the Royal Dublin Society.

With Appendix on Preserved Foods by C. A. MITCHELL, B.A., F.I.C.

"The work is one which will appeal to those intending to become farmers at home or in the Colonies, and who desire to obtain a general idea of the true principles of farming in ALL ITS BRANCHES."—*Journal of the Royal Colonial Inst.*

FIFTH EDITION. *With Illustrations. Handsome Cloth, 5s.*

PROSPECTING FOR MINERALS.

A Practical Handbook for Prospectors, Explorers, Settlers, and all interested in the Opening up and Development of New Lands.

By S. HERBERT COX, Assoc.R.S.M., M.Inst.M.M., F.G.S.,

Professor of Mining at the Royal School of Mines.

GENERAL CONTENTS.—Introduction and Hints on Geology—The Determination of Minerals: Use of the Blow-pipe, &c.—Rock-forming Minerals and Non-Metallic Minerals of Commercial Value: Rock Salt, Borax, Marbles, Lithographic Stone, Quartz and Opal, &c., &c.—Precious Stones and Gems—Stratified Deposits: Coal and Ores—Mineral Veins and Lodes—Irregular Deposits—Dynamics of Lodes: Faults, &c.—Alluvial Deposits—Noble Metals: Gold, Platinum, Silver, &c.—Lead—Mercury—Copper—Tin—Zinc—Iron—Nickel, &c.—Sulphur, Antimony, Arsenic, &c.—Combustible Minerals—Petroleum—General Hints on Prospecting—Glossary—Index.

"This ADMIRABLE LITTLE WORK . . . written with SCIENTIFIC ACCURACY in CLEAR and LUCID style. . . . An IMPORTANT ADDITION to technical literature . . ."
—*Mining Journal*.

LONDON: CHARLES GRIFFIN & CO., LIMITED, EXETER STREET, STRAND

WORKS BY
SIR CLEMENT LE NEVE FOSTER, D.Sc., F.R.S.

SIXTH EDITION. With Frontispiece and 716 Illustrations. Price 34s.

ORE & STONE MINING.

By SIR C. LE NEVE FOSTER, D.Sc., F.R.S.,
LATE PROFESSOR OF MINING, ROYAL COLLEGE OF SCIENCE.

REVISED, AND BROUGHT UP-TO-DATE

By BENNETT H. BROUGH, F.G.S., Assoc.R.S.M.

GENERAL CONTENTS.

INTRODUCTION. Mode of Occurrence of Minerals.—Prospecting.—Boring.—Breaking Ground.—Supporting Excavations.—Exploitation.—Haulage or Transport.—Hoisting or Winding.—Drainage.—Ventilation.—Lighting.—Descent and Ascent.—Dressing—Principles of Employment of Mining Labour.—Legislation affecting Mines and Quarries.—Condition of the Miner.—Accidents.—Index

"We have seldom had the pleasure to review a work so thorough and complete as the present one. Both in manner and in matter it is FAR SUPERIOR TO ANYTHING ON ITS SPECIAL SUBJECT HITHERTO PUBLISHED IN ENGLAND."—*Athenæum*.

"Not only is this work the acknowledged text-book on metal mining in Great Britain and the Colonies, but that it is so regarded in the United States of America is evidenced by the fact that it is the book on that subject recommended to the students in most of the mining schools of that country."—*The Times*.

In Crown 8vo. Handsome Cloth. With nearly 300 Illustrations, many of them being full page reproductions of views of great interest. Price 7s. 6d. net.

THE ELEMENTS OF MINING AND QUARRYING.

An Introductory Text-Book for Mining Students.

By SIR C. LE NEVE FOSTER, D.Sc., F.R.S.,
Late Professor of Mining at the Royal College of Science.

GENERAL CONTENTS. — INTRODUCTION. — Occurrence of Minerals. — Prospecting.—Boring.—Breaking Ground.—Supporting Excavations.—Exploitation.—Haulage or Transport.—Hoisting or Winding.—Drainage.—Ventilation.—Lighting.—Descent and Ascent.—Dressing, &c.—INDEX.

"A remarkably clear survey of the whole field of mining operations."—*Engineer*.

"Rarely does it fall to the lot of a reviewer to have to accord such unqualified praise as this book deserves. . . . The profession generally have every reason to be grateful to Sir C. Le Neve Foster for having enriched educational literature with so admirable an elementary Text-book."—*Mining Journal*.

In Large Crown 8vo. Fully Illustrated. 6s. net.

THE INVESTIGATION OF MINE AIR:

An Account by Several Authors of the Nature, Significance, and Practical Methods of Measurement of the Impurities met with in the Air of Collieries and Metalliferous Mines.

EDITED BY

SIR CLEMENT LE NEVE FOSTER, D.Sc., F.R.S.,
AND J. S. HALDANE, M.D., F.R.S.

We know of nothing essential that has been omitted. The book is liberally supplied with illustrations of apparatus."—*Colliery Guardian*.

LONDON: CHARLES GRIFFIN & CO., LIMITED, EXETER STREET, STRAND.

WORKS ON COAL-MINING.

FIFTH EDITION, Revised and Greatly Enlarged. With 4 Plates and
690 Illustrations. Price 24s. net.

A TEXT-BOOK OF COAL-MINING:
*FOR THE USE OF COLLIERY MANAGERS AND OTHERS
ENGAGED IN COAL-MINING.*

By HERBERT WILLIAM HUGHES, F.G.S.,
Assoc. Royal School of Mines, General Manager of Sandwell Park Colliery.

GENERAL CONTENTS.—Geology.—Search for Coal.—Breaking Ground.—Sinking.—Preliminary Operations.—Methods of Working.—Haulage.—Winding.—Pumping.—Ventilation.—Lighting.—Works at Surface.—Preparation of Coal for Market.—INDEX.

"Quite THE BEST BOOK of its kind . . . as PRACTICAL in aim as a book can be . . . The illustrations are EXCELLENT."—*Athenæum*.

"We cordially recommend the work."—*Colliery Guardian*.

"Will soon come to be regarded as the STANDARD WORK of its kind."—*Birmingham Daily Gazette*.

FOURTH EDITION, Thoroughly Revised and Greatly Enlarged. Re-set
throughout. Large Crown 8vo. Handsome Cloth. 12s. 6d.

PRACTICAL COAL-MINING:
**A MANUAL FOR MANAGERS, UNDER-MANAGERS,
COLLIERY ENGINEERS, AND OTHERS.**

With Worked-out Problems on Haulage, Pumping, Ventilation, &c.

By GEORGE L. KERR, M.E., M.INST.M.E.

CONTENTS.—The Sources and Nature of Coal.—The Search for Coal.—Sinking.—Explosives.—Mechanical Wedges.—Rock Drills and Coal-cutting Machines.—Coal-cutting by Machinery.—Transmission of Power.—Modes of Working.—Timbering Roadways.—Winding Coal.—Haulage.—Pumping.—Ventilation.—Safety Lamps.—Surface Arrangements, Surveying, Levelling, &c.

"An ESSENTIALLY PRACTICAL WORK, and can be confidently recommended. No department of Coal-Mining has been overlooked."—*Engineers' Gazette*.

SECOND EDITION, Revised. In Crown 8vo. Handsome Cloth.
With 200 Illustrations. 3s. 6d.

ELEMENTARY COAL-MINING:
**FOR THE USE OF STUDENTS, MINERS, AND OTHERS
PREPARING FOR EXAMINATIONS.**

By GEORGE L. KERR, M.E., M.INST.M.E.

CONTENTS.—Sources and Nature of Coal.—Exploration and Boring for Coal.—Breaking Ground.—Explosives, Blasting, &c.—Sinking and Fitting of Shafts.—Modes of Working.—Timbering Roadways.—Winding and Drawing.—Haulage.—Pumping and Drainage.—Ventilation.—Cleaning and Sorting Coal.—Surveying, &c.

"An abundance of information conveyed in a popular and attractive form. . . Will be of great use to all who are in any way interested in coal mining."—*Scottish Critic*.

LONDON: CHARLES GRIFFIN & CO., LIMITED. EXETER STREET, STRAND

THIRTEENTH EDITION, Revised. With Numerous Diagrams.
Cloth, 7s. 6d.

A TREATISE ON MINE-SURVEYING:

*For the use of Managers of Mines and Collieries, Students
at the Royal School of Mines, &c.*

By BENNETT H. BROUGH, ASSOC.R.S.M., F.G.S.,
Formerly Instructor of Mine-Surveying, Royal School of Mines.

CONTENTS. — General Explanations. — Measurement of Distances. — Miners Dial. — Variation of the Magnetic Needle. — Surveying with the Magnetic Needle in the Presence of Iron. — Surveying with the Fixed Needle. — The German Dial. — The Theodolite. — Traversing Underground. — Surface Surveys with the Theodolite. — Plotting the Survey. — Calculation of Areas. — Levelling. — Connection of the Underground and Surface Surveys. — Measuring Distances by Telescope. — Setting-out. — Mine-Surveying Problems. — Mine Plans. — Application of the Magnetic Needle in Mining. — Photographic Surveys. — APPENDICES. — INDEX.

"Its CLEARNESS of STYLE, LUCIDITY of DESCRIPTION, and FULNESS of DETAIL have long ago won for it a place unique in the literature of this branch of mining engineering, and the present edition fully maintains the high standard of its predecessors. To the student, and to the mining engineer alike, ITS VALUE is inestimable. The illustrations are excellent."—*The Mining Journal*.

In Crown 8vo. Handsome Cloth. Fully Illustrated. 6s. net.

A HANDBOOK ON THEODOLITE SURVEYING AND LEVELLING.

For the use of Students in Land and Mine Surveying.

By PROFESSOR JAMES PARK, F.G.S.

CONTENTS. — The Scope and Object of Surveying. — Land Surveying. — The Theodolite. — Chains and Steel Bands. — Obstacles to Alignment. — Meridian and Bearings. — The Theodolite Traverse. — Co-ordinates of a Station. — Calculation of Omitted or Connecting Line in a Traverse. — Calculation of Areas. — Subdivision of Land. — Triangulation. — Determination of True Meridian, Latitude and Time. — Levelling. — Railway Curves. — Mine Surveying. — Surveying Boreholes. — INDEX.

"A book which should prove as useful to the professional surveyor as to the student."—*Nature*.

SECOND EDITION, Revised. Crown 8vo. Handsome Cloth. Illustrated. 6s.

MINING GEOLOGY.

A TEXT-BOOK FOR MINING STUDENTS AND MINERS.

By PROF. JAMES PARK, F.G.S., M.Inst.M.M.,

Professor of Mining and Director of the Otago University School of Mines; late Director Thames School of Mines, and Geological Surveyor and Mining Geologist to the Government of New Zealand

GENERAL CONTENTS. — Introduction. — Classification of Mineral Deposits. — Ore Veins, their Filling, Age, and Structure. — The Dynamics of Lodes and Beds. — Ore Deposits Genetically Considered. — Ores and Minerals Considered Economically. — Mine Sampling and Ore Valuation. — The Examination and Valuation of Mines. — INDEX.

"A work which should find a place in the library of every mining engineer."—*Mining World*.

LONDON: CHARLES GRIFFIN & CO., LIMITED, EXETER STREET, STRAND.

WORKS FOR MINERS AND STUDENTS.

THIRD EDITION. *In Crown 8vo. Handsome Cloth. With 30 New Illustrations.*

ELECTRICAL PRACTICE IN COLLIERIES.

By D. BURNS, M.E., M.INST.M.E.,

Lecturer on Mining and Geology to the Glasgow and West of Scotland Technical College.

Units of Measurement, Conductors, &c.—The Theory of the Dynamo.—The Dynamo, Details of Construction and Working.—Motors.—Lighting Installations in Collieries.—Pumping by Electricity.—Electrical Haulage.—Coal Cutting.—Miscellaneous Applications of Electricity in Mines.—Coal Mines Regulation Act (Electricity).—INDEX.

"A clear and concise introduction to electrical practice in collieries."—*Mining Journal*.

In Crown 8vo, Handsome Cloth. 8s. 6d. net.

MINING LAW OF THE BRITISH EMPIRE.

By CHARLES J. ALFORD, F.G.S., M.INST.M.M.

CONTENTS.—The Principles of Mining Law.—The Mining Law of Great Britain.—British India.—Ceylon.—Burma.—The Malay Peninsula.—British North Borneo.—Egypt.—Cyprus.—The Dominion of Canada.—British Guiana.—The Gold Coast Colony and Ashanti.—Cape of Good Hope.—Natal.—Orange River Colony.—Transvaal Colony.—Rhodesia.—The Commonwealth of Australia.—New Zealand, &c.—INDEX.

"Cannot fail to be useful . . . we cordially recommend the book."—*Mining World*.

FOURTH EDITION. *In Large 8vo. Price 10s. 6d.*

MINE ACCOUNTS AND MINING BOOK-KEEPING.

For Students, Managers, Secretaries, and others.

With Examples taken from Actual Practice of Leading Companies.

By JAMES GUNSON LAWN, A.R.S.M., A.M.Inst.C.E., F.G.S.,
Head of the Mining Department, Camborne School of Mines.

EDITED BY SIR C. LE NEVE FOSTER, D.Sc., F.R.S.

"It seems impossible to suggest how Mr. LAWN's book could be made more COMPLETE or more VALUABLE, careful, and exhaustive."—*Accountants' Magazine*.

SECOND EDITION. *In Pocket Size, Strongly Bound in Leather, 3s. 6d.*
Provided with Detachable Blank Pages for MS.

**THE MINING ENGINEERS' REPORT BOOK
AND DIRECTORS' AND SHAREHOLDERS' GUIDE TO MINING REPORTS.**

By EDWIN R. FIELD, M.INST.M.M.

*With Notes on the Valuation of Property, and Tabulating Reports,
Useful Tables, and Examples of Calculations, &c.*

"An ADMIRABLY compiled book which Mining Engineers and Managers will find EXTREMELY USEFUL."—*Mining Journal*.

In Crown 8vo. Handsome Cloth, Illustrated. 10s. 6d. net.

**A DICTIONARY OF
SPANISH AND SPANISH-AMERICAN MINING, METALLURGICAL
AND ALLIED TERMS.**

To which some Portuguese and Portuguese-American (Brazilian) Terms are added.

By EDWARD HALSE, A.R.S.M.,

Mem. Inst. Ming. and Metall., of the Eng. Inst. of Ming. and Metall. Engrs., &c., &c.

"Will be found of the greatest service to the mining profession."—*Mining Journal*.

LONDON: CHARLES GRIFFIN & CO., LIMITED, EXETER STREET, STRAND.

WORKS ON SINKING, EXPLOSIVES, &c.

In Medium 8vo, Handsome Cloth. With 18 Figures in the Text,
and 19 Folding Plates. 10s. 6d. net.

SHAFT-SINKING IN DIFFICULT CASES.

By J. RIEMER,

TRANSLATED BY J. W. BROUGH, A.M. INST. C.E.

CONTENTS.—Shaft Sinking by Hand.—Shaft Sinking by Boring.—The Freezing Method.—The Sinking Drum Process.—BIBLIOGRAPHY.—INDEX.

“The translator deserves the thanks of the mining community for placing this valuable work before them. . . . The work is one which every mining engineer should include in his library.”—*Mining World*.

SECOND EDITION, Revised. In Large 8vo, with Numerous Illustrations
and Folding Plates. 10s. 6d.

BLASTING: AND THE USE OF EXPLOSIVES.

By OSCAR GUTTMANN, M. INST. C.E., F.I.C., F.C.S.

CONTENTS.—Historical Sketch.—Blasting Materials.—Qualities and Handling of Explosives.—The Choice of Blasting Materials.—Preparation of Blasts.—Chamber Mines.—Charging of Boreholes.—Determination of Charge.—Blasting in Boreholes.—Firing.—Results of Working.—Various Blasting Operations.—INDEX.

“Should prove a *vade-mecum* to Mining Engineers and all engaged in practical work.”—*Iron and Coal Trades Review*.

In Medium 8vo, Cloth. With many Illustrations in the Text.
Four Full Page Plates and Four Folding Tables. 6s. net.

NEW METHODS OF TESTING EXPLOSIVES.

By C. E. BICHEL.

TRANSLATED AND EDITED BY ALEX. LARSEN, M. INST. C.E.

CONTENTS.—Introductory.—Historical.—Testing Stations.—Power Gauges.—Products of Combustion.—Rate of Detonation.—Length and Duration of Flame.—After-Flame Ratio.—Transmission of Explosion.—Conclusions.—Efficiency.

“Its pages bristle with suggestions and actual experimental results to an extent seldom found in a volume of five times its size.”—*Arms and Explosives*.

In Crown 8vo. Handsome Cloth. Fully Illustrated.

A MANUAL ON ELECTRICAL SIGNALLING IN MINES.

By GERALD J. HOOGHWINKEL, M. INST. E. E., M. I. MIN. E.

CONTENTS.—SECTION I.—Electric Haulage Signals—(a) Acoustic Signals.—(b) Optical Signals.—(c) Acoustic Optical Signals.—Current Supply.—Batteries.—Accumulators.—Main Supply.—Design and Construction of Signalling Installations.—Maintenance of Signalling Installations. SECTION II.—Electric Shaft Signals—(a) Acoustic Signals.—(b) Electro-Mechanical Signals.—(c) Optical Acoustic Signals.—Signals for Winding Minerals.—For Winding Men.—Signalling from the Cage.—Emergency Signals.—Bells.—Mine Telegraphs.—Mine Telephones. SECTION III.—Special Applications in Mines.

LONDON: CHARLES GRIFFIN & CO., LIMITED, EXETER STREET, STRAND

SECOND EDITION, Revised Throughout. In Medium 8vo. With Numerous Plates, Maps, and Illustrations. 21s. net.

CYANIDING GOLD & SILVER ORES.

A Practical Treatise on the Cyanide Process; its Application, Methods of Working, Design and Construction of Plant, and Costs.

By H. FORBES JULIAN,

Mining and Metallurgical Engineer; Specialist in Gold; Late Technical Adviser of the Deutsche Gold und Silber Scheide Anstalt, Frankfort-on-Maine.

AND EDGAR SMART, A.M.I.C.E.,

Civil and Metallurgical Engineer.

"A handsome volume of 400 pages which will be a valuable book of reference for all associated with the process."—*Mining Journal*.

"The authors are to be congratulated upon the production of what should prove to be a standard work."—*Page's Magazine*.

In Large Crown 8vo. With 13 Plates and many Illustrations in the Text. Handsome Cloth. 7s. 6d. net.

THE CYANIDE PROCESS OF GOLD EXTRACTION.

A Text-Book for the Use of Metallurgists and Students at Schools of Mines, &c.

By JAMES PARK, F.G.S., M.INST.M.M.,

Professor of Mining and Director of the Otago University School of Mines; late Director Thames School of Mines, and Geological Surveyor and Mining Geologist to the Government of New Zealand.

FOURTH ENGLISH EDITION. Thoroughly Revised and Greatly Enlarged. With additional details concerning the Siemens-Halske and other recent processes.

"Deserves to be ranked as amongst the BEST OF EXISTING TREATISES."—*Mining Journal*.

THIRD EDITION, Revised. With Plates and Illustrations. Cloth, 3s. 6d.

GETTING GOLD: A GOLD-MINING HANDBOOK FOR PRACTICAL MEN.

By J. O. F. JOHNSON, F.G.S., A.I.M.E.,

Life Member Australasian Mine-Managers' Association.

GENERAL CONTENTS.—Introductory: Prospecting (Alluvial and General)—Lode or Reef Prospecting—Genesiology of Gold—Auriferous Lodes—Drifts—Gold Extraction—Lixiviation—Calcination—Motor Power and its Transmission—Company Formation—Mining Appliances and Methods—Australasian Mining Regulations.

"PRACTICAL from beginning to end . . . deals thoroughly with the Prospecting, Sinking, Crushing, and Extraction of gold."—*Brit. Australasian*.

In Crown 8vo. Illustrated. Fancy Cloth Boards. 4s. 6d.

GOLD SEEKING IN SOUTH AFRICA:

A Handbook of Hints for intending Explorers, Prospectors, and Settlers.

By THEO KASSNER,

Mine Manager, Author of the Geological Sketch Map of the De Kaap Gold Fields.

With a Chapter on the Agricultural Prospects of South Africa.

"As fascinating as anything ever penned by Jules Verne."—*African Commerce*.

LONDON: CHARLES GRIFFIN & CO., LIMITED, EXETER STREET, STRAND

Large 8vo. Handsome Cloth. With Illustrations.
12s. 6d. net.

METALLURGICAL ANALYSIS & ASSAYING :

A THREE YEARS' COURSE

FOR STUDENTS OF SCHOOLS OF MINES.

By W. A. MACLEOD, B.A., B.Sc., A.O.S.M. (N.Z.),

Formerly Assist.-Director, Thames School of Mines (N.Z.), and Lecturer in Chemistry, University of Tasmania; Director of Queensland Government School of Mines, Charters Towers :

AND CHAS. WALKER, F.C.S.,

Formerly Assist.-Demonstrator in Chemistry, Sydney University; Lecturer in Chemistry and Metallurgy, Charters Towers School of Mines

PART I. —Qualitative Analysis and Preparation and Properties of Gases.
PART II. —Qualitative and Quantitative Analysis. PART III. —Assaying, Technical Analysis (Gas, Water, Fuels, Oils, &c.).

"The publication of this volume tends to prove that the teaching of metallurgical analysis and assaying in Australia rests in competent hands."—*Nature*.

In Crown 8vo, Beautifully Illustrated with nearly 100
Microphotographs of Steel, &c. 7s. 6d. net.

MICROSCOPIC ANALYSIS OF METALS.

By FLORIS OSMOND & J. E. STEAD, F.R.S., F.I.C.

CONTENTS.—Metallography considered as a method of Assay.—Micrographic Analysis of Carbon Steels.—Preparation of Specimens.—Polishing.—Constituents of Steel; Ferrite; Cementite; Pearlite; Sorbite; Martensite; Hardenite; Troostite; Austenite.—Identification of Constituents.—Detailed Examination of Carbon Steels.—Conclusions, Theoretical and Practical.—Apparatus employed.—APPENDIX.

"There has been no work previously published in English calculated to be so useful to the student in metallographic research."—*Iron and Steel Trades' Journal*.

In Crown 8vo. Handsome cloth. With 102 Illustrations. 6s. net.

A HANDBOOK ON

METALLIC ALLOYS:

Their Structure and Constitution.

By GILBERT H. GULLIVER, B.Sc., F.R.S.E.

CONTENTS.—Methods of Investigation.—Solution Theory, and the Chemical Equilibrium of Mixed Substances.—Binary Alloys in which no Definite Chemical Compounds are Formed.—Binary Alloys which Show Evidence of the Formation of Definite Chemical Compounds.—Equilibrium Conditions in Metallic Mixtures.—The Bronzes, Brasses and the Steels.—Alloys of more than two Metals.—Bibliography.—INDEX.

"Probably the clearest and best exposition of the portion of the field with which the author treats which has hitherto appeared in the English language."—*Engineer*.

THIRD EDITION. With Folding Plates and Many Illustrations 36s.

ELEMENTS OF

METALLURGY.

A PRACTICAL TREATISE ON THE ART OF EXTRACTING METALS
FROM THEIR ORES.

By J ARTHUR PHILLIPS, M.Inst.C.E., F.C.S., F.G.S., &c.
AND H. BAUERMAN, V.P.G.S.

LONDON: CHARLES GRIFFIN & CO., LIMITED, EXETER STREET, STRAND

SECOND EDITION, Revised, Enlarged, and Re-set Throughout on Larger Page.
With Valuable Bibliography, New Maps, Illustrations, &c. 45s. net.

IN TWO VOLUMES.
A TREATISE ON

PETROLEUM.

By SIR BOVERTON REDWOOD,
D.Sc., F.R.S.E., Assoc. Inst. C.E., F.I.C.

CONTENTS.—SECTION I.: Historical Account of the Petroleum Industry.—SECTION II.: Geological and Geographical Distribution of Petroleum and Natural Gas.—SECTION III.: The Chemical and Physical Properties of Petroleum and Natural Gas.—SECTION IV.: The Origin of Petroleum and Natural Gas.—SECTION V.: The Production of Petroleum, Natural Gas, and Ozokerite.—SECTION VI.: The Refining of Petroleum.—SECTION VII.: The Shale Oil and Allied Industries.—SECTION VIII.: The Transport, Storage, and Distribution of Petroleum.—SECTION IX.: The Testing of Crude Petroleum, Petroleum and Shale Oil Products, Ozokerite, and Asphalt.—SECTION X.: The Uses of Petroleum and its Products.—SECTION XI.: Statutory, Municipal, and other Regulations relating to the Testing, Storage, Transport, and Use of Petroleum and its Products.—APPENDICES.—BIBLIOGRAPHY.—INDEX.

"It is indisputably the most comprehensive and complete treatise on petroleum, and this statement is true, no matter on what branch of the industry a test of its merits is made. It is the only book in existence which gives the oil man a clear and reliable outline of the growth and present-day condition of the entire petroleum world. . . . There is a wonderfully complete collection of plates and illustrations."—*Petroleum World*.

SECOND EDITION, Revised. With Illustrations. Price 8s. 6d. net.

A HANDBOOK ON PETROLEUM. FOR INSPECTORS UNDER THE PETROLEUM ACTS,

And for those engaged in the Storage, Transport, Distribution, and Industrial Use of Petroleum and its Products, and of Calcium Carbide. With suggestions on the Construction and Use of Mineral Oil Lamps.

By CAPTAIN J. H. THOMSON,
H.M. Chief Inspector of Explosives,
AND SIR BOVERTON REDWOOD,
Author of "A Treatise on Petroleum."

"A volume that will enrich the world's petroleum literature, and render a service to the British branch of the industry. . . . Reliable, indispensable, a brilliant contribution."—*Petroleum*.

In Crown 8vo. Fully Illustrated. 2s. 6d. net.

THE LABORATORY BOOK OF MINERAL OIL TESTING.

By J. A. HICKS,
Chemist to Sir Boverton Redwood.

Should be on the shelves of every analytical chemist in practice."—*Chemical Trade Journal*.

In Large Crown 8vo, Cloth. Fully Illustrated 5s. net.

OIL FUEL: ITS SUPPLY, COMPOSITION, AND APPLICATION.

By SIDNEY H. NORTH,

LATE EDITOR OF THE "PETROLEUM REVIEW."

CONTENTS.—The Sources of Supply.—Economic Aspect of Liquid Fuel.—Chemical Composition of Fuel Oils.—Conditions of Combustion in Oil Fuel Furnaces.—Early Methods and Experiments.—Modern Burners and Methods.—Oil Fuel for Marine Purposes.—For Naval Purposes.—On Locomotives.—For Metallurgical and other Purposes.—Appendices.—INDEX.

"Everyone interested in this important question will welcome Mr. North's excellent text-book."—*Nature*.

THE PETROLEUM LAMP: Its Choice and Use. A Guide to the Safe Employment of the Paraffin Lamp. By CAPT. J. H. THOMSON and SIR BOVERTON REDWOOD. Illustrated. 1s. net.

"A work which will meet every purpose for which it has been written."—*Petroleum*.

LONDON: CHARLES GRIFFIN & CO., LIMITED, EXETER STREET, STRAND

Griffin's Metallurgical Series.

STANDARD WORKS OF REFERENCE

FOR

Metallurgists, Mine-Owners, Assayers, Manufacturers,
and all interested in the development of
the Metallurgical Industries.

EDITED BY

Sir W. ROBERTS-AUSTEN, K.C.B., D.C.L., F.R.S.

In Large 8vo, Handsome Cloth. With Illustrations.

INTRODUCTION to the STUDY of METALLURGY.

By the EDITOR. SIXTH EDITION. (See p. 63.)

GOLD (The Metallurgy of). By THOS. KIRKE ROSE, D.Sc., Assoc. R.S.M., F.C.S., Chemist and Assayer of the Royal Mint. FIFTH EDITION. 21s. (See p. 63.)

LEAD (The Metallurgy of). By H. F. COLLINS, Assoc. R.S.M., M.Inst.M.M. SECOND EDITION. (See p. 64.)

SILVER (The Metallurgy of). By H. F. COLLINS, A.R.S.M., M.Inst.M.M. SECOND EDITION. (See p. 64.)

IRON (The Metallurgy of). By T. TURNER, A.R.S.M., F.I.C., F.C.S. THIRD EDITION, Revised. 16s. net. (See p. 65.)

STEEL (The Metallurgy of). By F. W. HARBOR, Assoc.R.S.M., F.I.C., with a Section on Mechanical Treatment by J. W. HALL, A.M.Inst.C.E. THIRD EDITION. 25s. net. (See p. 65.)

ALLOYS AND THEIR INDUSTRIAL USES. By EDWARD F. LAW, Assoc.R.S.M. Profusely Illustrated, Just Published, 12s. 6d. net. (See p. 64.)

ANTIMONY (Chemistry, Mineralogy, Geology, Metallurgy, &c.). By C. Y. WANG, M.A., B.Sc. Just Published. 12s. 6d. net. (See p. 65.)

Will be Published at Short Intervals.

METALLURGICAL MACHINERY: the Application of Engineering to Metallurgical Problems. By HENRY CHARLES JENKINS, Wh.Sc., Assoc.R.S.M.

COPPER (The Metallurgy of). By THOS. C. CLOUD, Assoc. R.S.M.

* * Other Volumes in Preparation.

LONDON: CHARLES GRIFFIN & CO., LIMITED, EXETER STREET, STRAND.

GRIFFIN'S METALLURGICAL SERIES.

SIXTH EDITION, thoroughly Revised and considerably Enlarged. Large 8vo, with numerous Illustrations and Micro-Photographic Plates of different varieties of Steel.

An Introduction to the Study of
METALLURGY.

BY

Sir W. ROBERTS-AUSTEN, K.C.B., D.C.L., F.R.S., A.R.S.M.,

Late Chemist and Assayer of the Royal Mint, and Professor of Metallurgy
in the Royal College of Science.

Revised throughout by F. W. HARBORD, A.R.S.M., F.I.C.

GENERAL CONTENTS.—The Relation of Metallurgy to Chemistry.—Physical Properties of Metals.—Alloys. The Thermal Treatment of Metals.—Fuel and Thermal Measurements.—Materials and Products of Metallurgical Processes.—Furnaces.—Means of Supplying Air to Furnaces.—Thermo-Chemistry.—Typical Metallurgical Processes.—The Micro-Structure of Metals and Alloys.—Economic Considerations.

"No English text-book at all approaches this in the COMPLETENESS with which the most modern views on the subject are dealt with. Professor Austen's volume will be INVALUABLE, not only to the student, but also to those whose knowledge of the art is far advanced."—*Chemical News*.

FIFTH EDITION, Revised, Considerably Enlarged, and in part Re-written.
With Frontispiece and numerous Illustrations. 21s.

THE METALLURGY OF GOLD.

BY

T. KIRKE ROSE, D.Sc.Lond., Assoc.R.S.M.,

Chemist and Assayer of the Royal Mint.

GENERAL CONTENTS.—The Properties of Gold and its Alloys.—Chemistry of the Compounds of Gold.—Mode of Occurrence and Distribution of Gold.—Shallow Placer Deposits.—Deep Placer Deposits.—Quartz Crushing in the Stamp Battery.—Amalgamation in the Stamp Battery.—Other Forms of Crushing and Amalgamating Machinery.—Concentration in Gold Mills.—Dry Crushing.—Re-grinding.—Roasting.—Chlorination: The Plattner Process, The Barrel Process, The Vat-Solution Process.—The Cyanide Process.—Chemistry of the Cyanide Process.—Refining and Parting of Gold Bullion.—Assay of Gold Ores.—Assay of Gold Bullion.—Statistics of Gold Production.—Bibliography.—INDEX.

"A COMPREHENSIVE PRACTICAL TREATISE on this important subject."—*The Times*.

"The MOST COMPLETE description of the CHLORINATION PROCESS which has yet been published."—*Mining Journal*.

"Adapted for all who are interested in the Gold Mining Industry, being free from technicalities as far as possible, but is more particularly of value to those engaged in the industry."—*Cape Times*.

LONDON: CHARLES GRIFFIN & CO., LIMITED, EXETER STREET, STRAND.

GRIFFIN'S METALLURGICAL SERIES.

EDITED BY SIR W. ROBERTS-AUSTEN, K.C.B., F.R.S., D.C.L.

In Large Svo. Handsome Cloth. With Illustrations.

SECOND EDITION, Revised Throughout and Enlarged. Illustrated.

THE METALLURGY OF LEAD.

BY H. F. COLLINS, ASSOC.R.S.M., M.INST.M.M.

A Complete and Exhaustive Treatise on the Manufacture of Lead, with Sections on Smelting and Desilverisation, and Chapters on the Assay and Analysis of the Materials involved.

"A THOROUGHLY SOUND and useful digest. May with EVERY CONFIDENCE be recommended."—*Mining Journal*.

SECOND EDITION, Revised Throughout and Enlarged. Illustrated.

THE METALLURGY OF SILVER.

Comprising Details regarding the Sources and Treatment of Silver Ores, together with Descriptions of Plant, Machinery, and Processes of Manufacture, Refining of Bullion, Cost of Working, &c.

"The author has focussed A LARGE AMOUNT OF VALUABLE INFORMATION into a convenient form. . . . The author has evidently considerable practical experience, and describes the various processes clearly and well."—*Mining Journal*.

JUST PUBLISHED. With Frontispiece in Colours, and Beautiful Series of Photo-micrographs. 12s. 6d. net.

ALLOYS

AND THEIR INDUSTRIAL APPLICATIONS.

BY EDWARD F. LAW, A.R.S.M.

CONTENTS.—Introduction.—Properties of Alloys.—Methods of Investigation.—Constitution.—Influence of Temperature on Properties.—Corrosion of Alloys.—Copper Alloys, Brass, Bronzes.—Special Brasses and Bronzes.—German Silver and Miscellaneous Copper Alloys.—White Metal Alloys.—Anti-Friction Alloys.—Aluminium Alloys.—Silver and Gold Alloys.—Iron Alloys.—Miscellaneous Alloys (Amalgams, &c.).—INDEX.

LONDON: CHARLES GRIFFIN & CO., LIMITED, EXETER STREET, STRAND.

GRIFFIN'S METALLURGICAL SERIES.

THIRD EDITION, Revised. With Numerous Illustrations. Large 8vo.
Handsome Cloth. 25s. net.

With Additional Chapter on The Electric Smelting of Steel.

THE METALLURGY OF STEEL.

BY F. W. HARBORD, ASSOC.R.S.M., F.I.C.

With 37 Plates, 280 Illustrations in the Text, and nearly 100 Micro-
Sections of Steel, and a Section on

THE MECHANICAL TREATMENT OF STEEL.

BY J. W. HALL, A.M.INST.C.E.

ABRIDGED CONTENTS.—The Plant, Machinery, Methods and Chemistry of the Bessemer and of the Open Hearth Processes (Acid and Basic).—The Mechanical Treatment of Steel comprising Mill Practice, Plant and Machinery.—The Influence of Metalloids, Heat Treatment, Special Steels, Microstructure, Testing, and Specifications.

The *Engineer* says, at the conclusion of a review of this book:—"We cannot conclude without earnestly recommending all who may be interested as makers or users of steel, which practically means the whole of the engineering profession, to make themselves acquainted with it as speedily as possible, and this may be the more easily done as the published price, considering the size of the book, is extremely moderate."

THIRD EDITION, Revised and Enlarged. With many new Plates.
16s. net.

THE METALLURGY OF IRON.

BY THOMAS TURNER, ASSOC.R.S.M., F.I.C.,

Professor of Metallurgy in the University of Birmingham.

General Contents.—Early History of Iron.—Modern History of Iron.—The Age of Steel.—Chief Iron Ores.—Preparation of Iron Ores.—The Blast Furnace.—The Air used in the Blast Furnace.—Reactions of the Blast Furnace.—The Gaseous Products of the Blast Furnace.—The Fuel used in the Blast Furnace. Slags and Fluxes of Iron Smelting.—Properties of Cast Iron.—Foundry Practice.—Wrought Iron.—Indirect Production of Wrought Iron.—The Puddling Process.—Further Treatment of Wrought Iron.—Corrosion of Iron and Steel.

"A THOROUGHLY USEFUL BOOK, which brings the subject UP TO DATE. OF GREAT VALUE to those engaged in the iron industry."—*Mining Journal.*

* * For Professor Turner's *Lectures on Iron-Founding*, see page 68

JUST PUBLISHED. In Large 8vo. Handsome Cloth. Fully Illustrated.
12s. 6d. net.

ANTIMONY:

Its History, Chemistry, Mineralogy, Geology, Metallurgy, Uses and Preparation. Analysis, Production and Valuation.

By C. Y. WANG, M.A., B.Sc.,

Mem. Am. Inst. Mining Eng.; Mem. Iron and Steel Institute; Mining Engineer to the Chung Lou General Mining Company; Geologist for the Hunan Province, China, &c., &c.

LONDON: CHARLES GRIFFIN & CO., LIMITED, EXETER STREET, STRAND

TENTH EDITION. With Tables and Illustrations. Cloth, 10s. 6d.

A TEXT-BOOK OF ASSAYING:

For the use of Students, Mine Managers, Assayers, &c.

By J. J. BERINGER, F.I.C., F.C.S.,
Public Analyst for, and Lecturer to the Mining Association of, Cornwall.

AND C. BERINGER, F.C.S.,
Late Chief Assayer to the Rio Tinto Copper Company, London,

GENERAL CONTENTS. — PART I. — INTRODUCTORY; MANIPULATION: Sampling; Drying; Calculation of Results—Laboratory-books and Reports. METHODS: Dry Gravimetric; Wet Gravimetric—Volumetric Assays; Titrometric, Colorimetric, Gasometric—Weighing and Measuring—Reagents—Formule, Equations, &c.—Specific Gravity.

PART II.—METALS: Detection and Assay of Silver, Gold, Platinum, Mercury, Copper, Lead, Thallium, Bismuth, Antimony, Iron, Nickel, Cobalt, Zinc, Cadmium, Tin, Tungsten, Titanium, Manganese, Chromium, &c.—Earths, Alkalies.

PART III.—NON-METALS: Oxygen and Oxides; The Halogens—Sulphur and Sulphates—Arsenic, Phosphorus, Nitrogen—Silicon, Carbon, Boron—Useful Tables.

"A REALLY MERITORIOUS WORK, that may be safely depended upon either for systematic instruction or for reference."—*Nature*.

"This work is one of the BEST of its kind."—*Engineer*.

In Crown 8vo. Handsome Cloth. Fully Illustrated. 3s. net.

AN INTRODUCTION TO PRACTICAL METALLURGY.

By PROF. THOMAS TURNER, A.R.S.M., F.I.C.,
Professor of Metallurgy in the University of Birmingham.

CONTENTS.—Introduction.—Sampling and Weighing.—Metals and Alloys.—Oxidation and Reduction.—Examination of Fire Clay.—Slags and Fluxes.—Examination of Fuel.—Iron Ores.—Determination of Muffle Temperatures.—Silver and Silver Assay.—Assay of Silver Bullion.—Assay of Silver Ores.—Gold Assay.—Assay of Gold Ores.—Properties of Mercury.—Micro-Structure of Metals.—Iron and Steel.—Electro-Deposition.—Appendix.—INDEX.

"It is an excellent and handy book for its purpose, and will have a far wider range of usefulness than for class work alone."—*Practical Engineer*.

FOURTH EDITION, Revised. With Numerous Illustrations. 6s.

A TEXT-BOOK OF ELEMENTARY METALLURGY.

Including the Author's PRACTICAL LABORATORY COURSE.

By A. HUMBOLDT SEXTON, F.I.C., F.C.S.,
Professor of Metallurgy in the Glasgow and West of Scotland Technical College.

GENERAL CONTENTS.—Introduction.—Properties of the Metals.—Combustion.—Fuels.—Refractory Materials.—Furnaces.—Occurrence of the Metals in Nature.—Preparation of the Ore for the Smelter.—Metallurgical Processes.—Iron.—Steel.—Copper.—Lead.—Zinc and Tin.—Silver.—Gold.—Mercury.—Alloys.—Applications of ELECTRICITY to Metallurgy.—LABORATORY COURSE.

"Just the kind of work for Students COMMENCING the study of Metallurgy, or for ENGINEERING Students."—*Practical Engineer*.

LONDON: CHARLES GRIFFIN & CO., LIMITED, EXETER STREET, STRAND.

In Large 8vo. Handsome Cloth. Price 4s.

QUANTITATIVE METALLURGICAL ANALYSIS.

TABLES FOR LABORATORY USE.

ON THE PRINCIPLE OF "GROUP" SEPARATIONS.

By J. JAMES MORGAN, F.O.S., M.S.C.I.

"The Author may be CONGRATULATED on the way his work has been carried out."—*The Engineer*.

THIRD EDITION, Revised, Enlarged, and Re-written.

A TREATISE ON

ELECTRO-METALLURGY:

Embracing the Application of Electrolysis to the Plating, Depositing, Smelting, and Refining of various Metals, and to the Reproduction of Printing Surfaces and Art-Work, &c.

BY

WALTER G. McMILLAN, F.I.C., F.C.S.,

Late Lecturer in Metallurgy at Mason College, Birmingham.

Thoroughly Revised by W. R. COOPER.

"Excellent, . . . one of the BEST and MOST COMPLETE manuals hitherto published on Electro-Metallurgy."—*Electrical Review* (on the Second Edition).

SECOND EDITION, Thoroughly Revised and Enlarged. In large 8vo.
With Numerous Illustrations and Three Folding-Plates. 21s. net.

ELECTRIC SMELTING & REFINING:

A Practical Manual of the Extraction and Treatment
of Metals by Electrical Methods.

Being the "ELEKTRO-METALLURGIE" of Dr. W. BORCHERS.

Translated from the Latest German Edition by WALTER G. McMILLAN,
F.I.C., F.C.S.

CONTENTS.

PART I.—ALKALIES AND ALKALINE EARTH METALS: Magnesium, Lithium, Beryllium, Sodium, Potassium, Calcium, Strontium, Barium, the Carbides of the Alkaline Earth Metals.

PART II.—THE EARTH METALS: Aluminium, Cerium, Lanthanum, Didymium.

PART III.—THE HEAVY METALS: Copper, Silver, Gold, Zinc and Cadmium, Mercury, Tin, Lead, Bismuth, Antimony, Chromium, Molybdenum, Tungsten, Uranium, Manganese, Iron, Nickel, Cobalt, and the Platinum Group.

"COMPREHENSIVE and AUTHORITATIVE . . . not only FULL of VALUABLE INFORMATION, but gives evidence of a THOROUGH INSIGHT into the technical VALUE and POSSIBILITIES of all the methods discussed."—*The Electrician*.

"DR. BORCHERS' WELL-KNOWN WORK . . . must of NECESSITY BE ACQUIRED by every one interested in the subject. EXCELLENTLY put into English with additional matter by Mr. McMILLAN."—*Nature*.

"Will be of GREAT SERVICE to the practical man and the Student."—*Electric Smelting*.

LONDON: CHARLES GRIFFIN & CO., LIMITED EXETER STREET, STRAND.

In Medium 8vo. Handsome Cloth. Fully Illustrated. 15s. net.

GENERAL FOUNDRY PRACTICE:

*A Practical Handbook for Iron, Steel and Brass Founders,
Metallurgists, and Students of Metallurgy.*

By A. McWILLIAM, A.R.S.M., AND PERCY LONGMUIR.

CONTENTS.—Introduction.—General Properties of Matter.—Moulding Sands.—Facing Sands and Facings.—Foundry Tools.—Moulding Boxes.—Handling Material in the Foundry.—Open Sand Moulding.—Cores.—Elementary Aspects of Moulding.—Green Sand Moulding.—Securing Cores in Moulds.—Moulding from Guides.—Bench, Oddside, and Plate Moulding.—Machine Moulding.—Dry Sand Moulding.—Loam Moulding.—Chill Casting.—Casting on other Metals.—Burning.—Weighting and Binding Materials.—Shrinkage, Contraction, and Warping.—Dressing Castings.—Common Faults due to Mould and Pattern.—Malleable or Wrought Iron, Steel and Malleable Cast Iron.—Cast Iron.—Refractory Materials.—Fuels and Furnaces.—Mixing by Analysis.—Remelting.—Working the Cupola.—Further Treatment of Cast Iron.—High Temperature Measurement.—Steel.—Notes on Metals other than Iron.—Alloys.—Mechanical Testing.—Micrographic Analysis.—Common Faults.—Foundry Management.—INDEX.

"The student of foundry work . . . needs no other text-book. . . . The book contains a tremendous amount of information, and is well written."—*Engineering Times.*

Extra Crown 8vo. With 48 Illustrations. 3s. 6d. net.

LECTURES ON IRON-FOUNDING.

By THOMAS TURNER, M.Sc., A.R.S.M., F.I.C.,

Professor of Metallurgy in the University of Birmingham.

CONTENTS.—Varieties of Iron and Steel.—Application of Cast Iron.—History.—Production.—Iron Ores.—Composition.—The Blast Furnace.—Materials.—Reactions.—Grading Pig Iron.—Carbon, Silicon, Sulphur, Phosphorus, Manganese, Aluminium, Arsenic, Copper, and Titanium.—The Foundry.—General Arrangement.—Re-melting Cast Iron.—The Cupola.—Fuel Used.—Changes due to Re-melting.—Moulds and Moulding.—Foundry Ladles.—Pouring and Pouring Temperature.—Common Troubles.—Influence of Shape and Size on Strength of Castings.—Tests.

"Ironfounders will find much information in the book."—*Iron Trade Circular Ryland's*.

In Large 4to, Library Style. Beautifully Illustrated with 20 Plates, many in Colours, and 94 Figures in the Text. £2, 2s. net.

PRECIOUS STONES:

Their Properties, Occurrences, and Uses.

A Treatise for Dealers, Manufacturers, Jewellers, and for all Collectors and others interested in Gems.

By DR. MAX BAUER, OF THE UNIVERSITY OF MARBURG.

TRANSLATED BY L. J. SPENCER, M.A. (CANTAB.), F.G.S.

"The plates are remarkable for their beauty, delicacy, and truthfulness. A glance at them alone is a lesson on precious stones, whilst the perusal of the work itself should add a new interest to any casket of jewels or cabinet of gems, or even to a jewellers' window."—*Athenæum.*

In Large Crown 8vo. With Numerous Illustrations. 8s. 6d.

THE ART OF THE GOLDSMITH AND JEWELLER.

**A Manual on the Manipulation of Gold and the
Manufacture of Personal Ornaments.**

By THOS. B. WIGLEY,

Headmaster of the Jewellers and Silversmiths' Assoc. Tech. School, Birmingham.

ASSISTED BY J. H. STANSBIE, B.Sc. (LOND.), F.I.O.,

Lecturer at the Birmingham Municipal Technical School.

LONDON: CHARLES GRIFFIN & CO., LIMITED, EXETER STREET, STRAND.

THIRD EDITION, Revised, Enlarged, and Re-issued. Price 6s. net.

A SHORT MANUAL OF
INORGANIC CHEMISTRY.

By A. DUPRÉ, Ph.D., F.R.S.,
AND WILSON HAKE, Ph.D., F.I.C., F.C.S.,
Of the Westminster Hospital Medical School

"AN EXAMPLE OF THE ADVANTAGES OF THE SYSTEMATIC TREATMENT of a Science over the fragmentary style so generally followed. BY A LONG WAY THE BEST of the small Manuals for Students."—*Analyst*.

In Handsome Cloth. With nearly 50 Illustrations. 3s. 6d. net.

THE ELEMENTS OF CHEMICAL ENGINEERING.

By J. GROSSMANN, M.A., Ph.D., F.I.C.

WITH A PREFACE BY

SIR WILLIAM RAMSAY, K.C.B., F.R.S.

CONTENTS.—The Beaker and its Technical Equivalents.—Distilling Flasks, Liebig's Condensers.—Fractionating Tubes and their Technical Equivalents.—The Air-Bath and its Technical Equivalents.—The Blowpipe and Crucible and their Technical Equivalents.—The Steam Boiler and other Sources of Power.—General Remarks on the Application of Heat in Chemical Engineering.—The Funnel and its Technical Equivalents.—The Mortar and its Technical Equivalents.—Measuring Instruments and their Technical Equivalents.—Materials Used in Chemical Engineering and their Mode of Application.—Technical Research and the Designing of Plant.—Conclusion.—Chemicals and Materials.—INDEX.

"Excellent. . . . Every student of chemistry attending a technical course should obtain a copy."—*Chemical News*.

LABORATORY HANDBOOKS BY A. HUMBOLDT SEXTON,

Professor of Metallurgy in the Glasgow and West of Scotland Technical College.

OUTLINES OF QUANTITATIVE ANALYSIS.

FOR THE USE OF STUDENTS.

With Illustrations. FIFTH EDITION. Crown 8vo, Cloth, 3s.

"A COMPACT LABORATORY GUIDE for beginners was wanted, and the want has been WELL SUPPLIED. . . . A good and useful book."—*Lancet*.

OUTLINES OF QUALITATIVE ANALYSIS.

FOR THE USE OF STUDENTS.

With Illustrations. FOURTH EDITION, Revised. Crown 8vo, Cloth, 3s. 6d.

"The work of a thoroughly practical chemist."—*British Medical Journal*.

"Compiled with great care, and will supply a want."—*Journal of Education*.

ELEMENTARY METALLURGY:

Including the Author's Practical Laboratory Course.

[See p. 66.]

LONDON: CHARLES GRIFFIN & CO., LIMITED, EXETER STREET, STRAND.

In Two Vols., Large 8vo. With Illustrations. Sold Separately.

CHEMISTRY FOR ENGINEERS AND MANUFACTURERS.

BY

BERTRAM BLOUNT, F.I.C., & A. G. BLOXAM, F.I.C.

VOLUME I.—Chemistry of Engineering, Building, and Metallurgy.—*General Contents.*—INTRODUCTION.—Chemistry of the Chief Materials of Construction.—Sources of Energy.—Chemistry of Steam-raising.—Chemistry of Lubrication and Lubricants.—Metallurgical Processes used in the Winning and Manufacture of Metals. Price 10s. 6d.

VOLUME II.—The Chemistry of Manufacturing Processes.—*General Contents.*—Sulphuric Acid Manufacture.—Alkali, &c.—Destructive Distillation.—Artificial Manure.—Petroleum.—Lime and Cement—Clay and Glass.—Sugar and Starch.—Brewing and Distilling.—Oils, Resins, and Varnishes.—Soap and Candles.—Textiles and Bleaching.—Colouring Matters, Dyeing and Printing.—Paper and Pasteboard.—Pigments and Paints.—Leather, Glue, and Size.—Explosives and Matches.—Minor Manufactures. SECOND EDITION, Thoroughly Revised. Illustrated. 16s.

SECOND EDITION. In Large 8vo. Handsome Cloth. With 800 pages and 154 Illustrations. 25s. net.

OILS, FATS, BUTTERS, AND WAXES : THEIR PREPARATION AND PROPERTIES, AND MANUFACTURE THERE- FROM OF CANDLES, SOAPS, AND OTHER PRODUCTS.

BY C. R. ALDER WRIGHT, D.Sc., F.R.S.,

Late Lecturer on Chemistry, St. Mary's Hospital Medical School; Examiner in "Soap" to the City and Guilds of London Institute.

Thoroughly Revised, Enlarged, and in Part Rewritten

BY C. AINSWORTH MITCHELL, B.A., F.I.C., F.C.S.

"Will be found ABSOLUTELY INDISPENSABLE."—*The Analyst.*

"Will rank as the STANDARD ENGLISH AUTHORITY ON OILS and FATS for many years to come."—*Industries and Iron.*

In Two Volumes, Half Morocco, each complete in itself.

PHYSICO-CHEMICAL TABLES

For the Use of Analysts, Physicists, Chemical Manufacturers and Scientific Chemists.

Volume I.—Chemical Engineering, Physical Chemistry. 24s. net.

Volume II.—Chemical Physics, Pure and Analytical Chemistry.

[*Shortly.*]

BY JOHN CASTELL-EVANS, F.I.C., F.C.S.,

Lecturer on Inorganic Chemistry and Metallurgy at the Finsbury Technical College.

The Work comprehends as far as possible ALL RULES AND TABLES required by the Analyst, Brewer, Distiller, Acid- and Alkali-Manufacturer, &c., &c.; and also the principal data in THERMO-CHEMISTRY, ELECTRO-CHEMISTRY, and the various branches of CHEMICAL PHYSICS. Every possible care has been taken to ensure perfect accuracy, and to include the results of the most recent investigations.

LONDON: CHARLES GRIFFIN & CO., LIMITED, EXETER STREET, STRAÑD.

SIXTH EDITION, Thoroughly Revised. Fully Illustrated.

FOODS: THEIR COMPOSITION AND ANALYSIS.

By A. WYNTER BLYTH, M.R.C.S., F.I.C., F.C.S.,

Barrister-at-Law, Public Analyst for the County of Devon, and
Medical Officer of Health for St. Marylebone.

AND M. WYNTER BLYTH, B.A., B.Sc., F.C.S.

GENERAL CONTENTS.—History of Adulteration.—Legislation.—Apparatus.—“Ash.”—Sugar.—Confectionery.—Honey.—Treacle.—Jams and Preserved Fruits.—Starches.—Wheaten-Flour.—Bread.—Oats.—Barley.—Rye.—Rice.—Maize.—Millet.—Potatoes.—Peas.—Lentils.—Beans.—Milk.—Cream.—Butter.—Oleo-Margarine.—Cheese.—Lard.—Tea.—Coffee.—Cocoa and Chocolate.—Alcohol.—Brandy.—Rum.—Whisky.—Gin.—Arrack.—Liqueurs.—Absinthe.—Yeast.—Beer.—Wine.—Vinegar.—Lemon and Lime Juice.—Mustard.—Pepper.—Sweet and Bitter Almonds.—Annatto.—Olive Oil.—Water Analysis.—Appendix: Adulteration Acts, &c.

“A new edition of Mr. Wynter Blyth's Standard work, ENRICHED WITH ALL THE RECENT DISCOVERIES AND IMPROVEMENTS, will be accepted as a boon.”—*Chemical News*.

FOURTH EDITION, Thoroughly Revised. In Large 8vo, Cloth, with
Tables and Illustrations. 21s. net.

POISONS: THEIR EFFECTS AND DETECTION.

By A. WYNTER BLYTH, M.R.C.S., F.I.C., F.C.S.,

Barrister-at-Law, Public Analyst for the County of Devon, and
Medical Officer of Health for St. Marylebone.

GENERAL CONTENTS.—I.—Historical Introduction. II.—Classification—Statistics—Connection between Toxic Action and Chemical Composition—Life Tests—General Method of Procedure—The Spectroscope—Examination of Blood and Blood Stains. III.—Poisonous Gases. IV.—Acids and Alkalies. V.—More or less Volatile Poisonous Substances. VI.—Alkaloids and Poisonous Vegetable Principles. VII.—Poisons derived from Living or Dead Animal Substances. VIII.—The Oxalic Acid Group. IX.—Inorganic Poisons. *Appendix*: Treatment, by Antidotes or otherwise, of Cases of Poisoning.

“Undoubtedly THE MOST COMPLETE WORK on Toxicology in our language.”—*The Analyst*.
“As a PRACTICAL GUIDE, we KNOW NO BETTER work.”—*The Lancet (on the Third Edition)*

Crown 8vo, Handsome Cloth. Fully Illustrated. 10s. 6d.

FLESH FOODS:

With Methods for their Chemical, Microscopical, and Bacteriological Examination.

A Practical Handbook for Medical Men, Analysts, Inspectors and others.

By C. AINSWORTH MITCHELL, B.A., F.I.C., F.C.S.

“A compilation which will be most useful for the class for whom it is intended.”—*Athenaeum*.

LONDON: CHARLES GRIFFIN & CO., LIMITED, EXETER STREET, STRAND.

SECOND EDITION. With Numerous Tables, Fully Illustrated.

DAIRY CHEMISTRY

FOR DAIRY MANAGERS, CHEMISTS, AND ANALYSTS

A Practical Handbook for Dairy Chemists and others
having Control of Dairies.

By H. DROOP RICHMOND, F.I.C.,
CHEMIST TO THE AYLESBURY DAIRY COMPANY.

Contents.—I. Introductory.—The Constituents of Milk. II. The Analysis of Milk. III. Normal Milk: its Adulterations and Alterations, and their Detection. IV. The Chemical Control of the Dairy. V. Biological and Sanitary Matters. VI. Butter. VII. Other Milk Products. VIII. The Milk of Mammals other than the Cow.—Appendices.—Tables.—Index.

“ . . . In our opinion the book is the BEST CONTRIBUTION ON THE SUBJECT THAT HAS YET APPEARED in the English language.”—*Lancet* (on the First Edition).

Fully Illustrated. With Photographs of Various Breeds of Cattle, &c.
6s. net.

MILK: ITS PRODUCTION & USES.

With Chapters on Dairy Farming, The Diseases of Cattle, and on the Hygiene and Control of Supplies.

By EDWARD F. WILLOUGHBY,
M.D. (Lond.), D.P.H. (Lond. and Camb.).

“ We cordially recommend it to everyone who has anything at all to do with milk.”—*Dairy World*.

In Crown 8vo, Fully Illustrated. 2s. 6d. net.

THE LABORATORY BOOK OF DAIRY ANALYSIS.

By H. DROOP RICHMOND, F.I.C.,
Analyst to the Aylesbury Dairy Co., Ltd.

“ Without doubt the best contribution to the literature of its subject that has ever been written.”—*Medical Times*.

In Large Crown 8vo. Cloth. Fully Illustrated. 4s. 6d. net.

ELEMENTARY AGRICULTURAL CHEMISTRY.

By HERBERT INGLE, B.Sc., F.I.C., F.C.S.

CONTENTS.—Introduction.—The Atmosphere.—The Soil.—Natural Waters.—The Plant.—Manures.—Crops.—The Animal.—Foods and Feeding.—The Dairy.—Miscellaneous.—INDEX.

AT PRESS. In Crown 8vo. Handsome Cloth. Illustrated.

SOIL BACTERIA.

By JAMES CLARK, M.A., D.Sc., A.R.C.S.,
Principal of the Academy, Kilmarnock.

LONDON: CHARLES GRIFFIN & CO., LIMITED, EXETER STREET, STRAND.

In Large 8vo. Handsome Cloth.

AGRICULTURAL CHEMISTRY AND ANALYSIS :
A PRACTICAL HANDBOOK FOR THE USE OF AGRICULTURAL STUDENTS.

By J. M. H. MUNRO, D.Sc., F.I.C., F.C.S.,
 Professor of Chemistry, Downton College of Agriculture.

[*In Preparation.*]

In Large 8vo. Complete in Two Volumes.

Each Volume Complete in Itself, and Sold Separately.

TECHNICAL MYCOLOGY :
The Utilisation of Micro-organisms in the Arts and Manufactures.

By DR. FRANZ LAFAR,

Prof. of Fermentation-Physiology and Bacteriology in the Technical High School, Vienna.
 TRANSLATED BY CHARLES T. C. SALTER.

Vol. I.—SCHIZOMYCETIC FERMENTATION.
Vol. II.—EUMYCETIC FERMENTATION.

NOTE.—Part I. of Vol. II. was issued separately at 7s. 6d. Copies of Part II., Vol. II., have, therefore, been bound up to enable those possessing Part I. to complete their copies.

"The first work of the kind which can lay claim to completeness in the treatment of a fascinating subject. The plan is admirable, the classification simple, the style is good, and the tendency of the whole volume is to convey sure information to the reader."—*Lancet.*

Crown 8vo, Handsome Cloth. With Diagrams. 7s. 6d. net.

[*Companion Volume to "FERMENTS," by the same Author.*]

TOXINES AND ANTITOXINES.

By CARL OPPENHEIMER, Ph.D., M.D.,
 Of the Physiological Institute at Erlangen.

TRANSLATED FROM THE GERMAN BY

C. AINSWORTH MITCHELL, B.A., F.I.C., F.C.S.

With Notes, and Additions by the Author, since the publication of the German Edition.

"For wealth of detail, we have no small work on Toxines which equals the one under review."—*Medical Times*

In Crown 8vo, Handsome Cloth. Price 7s. 6d. net.

FERMENTS : AND THEIR ACTIONS.

A Text-book on the Chemistry and Physics of Fermentative Changes.

By CARL OPPENHEIMER, Ph.D., M.D.

TRANSLATED BY C. AINSWORTH MITCHELL, B.A., F.I.C., F.C.S.

ABRIDGED CONTENTS.—Introduction.—Definition.—Chemical Nature of Ferments.—Influence of External Factors.—Mode of Action.—Physiological Action.—Secretion.—Importance of Ferments to Vital Action.—Proteolytic Ferments.—Trypsin.—Bacteriolytic and Hæmolytic Ferments.—Vegetable Ferments.—Coagulating Ferments.—Saccharifying Ferments.—Diastases.—Polysaccharides.—Enzymes.—Ferments which decompose Glucosides.—Hydrolytic Ferments.—Lactic Acid Fermentation.—Alcoholic Fermentation.—Biology of Alcoholic Fermentation.—Oxydases.—Oxidising Fermentation.—Bibliography.—INDEX.

"Such a veritable *multum in parvo* has never yet appeared."—*Brewers' Journal.*

LONDON : CHARLES GRIFFIN & CO., LIMITED, EXETER STREET, STRAND

THIRD EDITION. In Handsome Cloth. Fully Illustrated. 21s. net.
PRINCIPLES AND PRACTICE OF BREWING.
 FOR THE USE OF STUDENTS AND PRACTICAL MEN.

By WALTER J. SYKES.

REVISED BY ARTHUR R. LING, F.I.C., F.C.S.,
 Editor of the Journal of the Institute of Brewing.

CONTENTS.—Physical Principles Involved.—The Chemistry of Brewing.—The Microscope.—Vegetable Biology.—Fermentation.—Water.—Barley and Malting.—Arrangement of Brewery Plant.—Quantities of Materials.—Fermentation.—Antiseptics.—Finings.—Characteristics of Beer.—Diseases of Beer.—INDEX.

"A thorough and comprehensive text-book . . . up-to-date . . . a standard text-book."—*Brewers' Journal*.

In Crown Svo. Handsome Cloth. Fully Illustrated. 6s. net.

PEAT: Its Use and Manufacture.

By PHILIP R. BJÖRLING, Consulting Hydraulic Engineer,
 AND FREDERICK T. GISSING.

GENERAL CONTENTS.—Introduction.—The Formation of Peat.—Area and Depth of Bogs in Principal Countries.—Manufacture of Peat Fuel, &c.—Cut Peat, Dredged Peat, and Manufactured Peat.—Machinery employed in the Manufacture of Peat Fuel.—Peat Moss Litter, and the Machinery employed in its Manufacture.—Peat Charcoal and its Manufacture.—Cost of making Peat Fuel and Charcoal.—Other Productions derived from Peat, such as Tar, Manure, Candles, Dyes, Paper, &c.—BIBLIOGRAPHY.—INDEX.

"The treatment throughout is clear and interesting . . . excellent plates."—*Engineering*.

Companion Volume to the above. In Crown Svo. Handsome Cloth. Fully Illustrated.

COMMERCIAL PEAT:
 Its Uses and Its Possibilities.

By F. T. GISSING,

Joint Author with P. R. BJÖRLING of "Peat: Its Use and Manufacture."

In Medium Svo, Handsome Cloth. Fully Illustrated. 12s. 6d. net.

PAPER TECHNOLOGY:
 AN ELEMENTARY MANUAL ON THE MANUFACTURE, PHYSICAL QUALITIES,
 AND CHEMICAL CONSTITUENTS OF PAPER AND OF
 PAPERMAKING FIBRES.

With Selected Tables for Stationers, Publishers, and Others.

By R. W. SINDALL, F.C.S.

Exceedingly instructive and particularly useful."—*Paper Makers' Monthly Journal*.

In Crown Svo. Handsome Cloth. With 30 Illustrations. 6s. net.

THE CLAYWORKER'S HANDBOOK.

An Epitome of the Materials and Methods employed in Brickmaking and Pottery.

By THE AUTHOR OF "THE CHEMISTRY OF CLAYWORKING," &c.

GENERAL CONTENTS.—Materials used in Clayworking; Clays, Engobes, Glazes, Colours, Water, Fuel, Oils, and Lubricants.—The Preparation of the Clay, Mining and Quarrying, Weathering, Washing, Grinding, Tempering, and Pugging.—Machinery; Boilers, Engines, General Machinery, Sieves, Mixing Machinery, Presses, &c.—Dryers and Drying.—Engobing and Glazing.—Setting or Charging, Transport.—Kilns.—Firing.—Discharging, Sorting, and Packing.—Defects and Waste.—Tests, Analysis and Control.—BIBLIOGRAPHY.—TABLES.—INDEX.

"We can thoroughly recommend this handy little book to all our readers."—*Brick and Pottery Trades' Journal*.

LONDON: CHARLES GRIFFIN & CO., LIMITED, EXETER STREET, STRAND

In Large 8vo. Cloth. With 147 Illustrations. 15s. net.

A MANUAL OF

THE PRINCIPLES OF SEWAGE TREATMENT.

BY PROF. DUNBAR,

Director of the Institute of State Hygiene, Hamburg.

ENGLISH EDITION BY HARRY T. CALVERT, M.Sc., Ph.D., F.I.C.,
Chief Chemical Assistant, West Riding of Yorkshire Rivers Board.

CONTENTS.—Growth of River Pollution.—Legal Measures taken by Central and Local Authorities.—Rise and Development of Methods of Sewage Treatment.—Earlier Views on Methods of Treatment.—Characteristics of Sewage.—Objects of Purification Works.—Methods for the Removal of Suspended Matters.—For the Removal of Putrescibility.—Disinfection.—Supervision and Inspection of Works.—Utility and Cost.—INDEX.

*Beautifully Illustrated, with Numerous Plates, Diagrams, and
Figures in the Text. 21s. net.*

TRADES' WASTE:

ITS TREATMENT AND UTILISATION.

Handbook for Borough Engineers, Surveyors, Architects, and Analysts.

BY W. NAYLOR, F.C.S., A.M. INST. C.E.,

Chief Inspector of Rivers, Ribble Joint Committee.

"There is probably no person in England to-day better fitted to deal rationally with such a subject."—*British Sanitarian.*

In Handsome Cloth. With 59 Illustrations. 6s. net.

SMOKE ABATEMENT.

*A Manual for the Use of Manufacturers, Inspectors, Medical Officers of
Health, Engineers, and Others.*

BY WILLIAM NICHOLSON,

Chief Smoke Inspector to the Sheffield Corporation.

"We welcome such an adequate statement on an important subject."—*British Medical Journal.*

SECOND EDITION. In Medium 8vo. Thoroughly Revised and Re-Written.
15s. net.

CALCAREOUS CEMENTS:

THEIR NATURE, PREPARATION, AND USES.

With some Remarks upon Cement Testing.

BY GILBERT R. REDGRAVE, ASSOC. INST. C.E.,

Assistant Secretary for Technology, Board of Education, South Kensington,

AND CHARLES SPACKMAN, F.C.S.

"We can thoroughly recommend it as a first-class investment."—*Practical Engineer.*

In Handsome Cloth. 5s. net.

A HANDBOOK FOR CEMENT WORKS' CHEMISTS.

BY FRANK B. GATEHOUSE, F.C.S.

GENERAL CONTENTS.—Introduction.—Chemicals and Apparatus.—Books.—Analysis and Calculations of Raw Materials.—Analysis of Fuel, Kiln Gases, Lubricants and Water.—Cement Analysis.—Gypsum, Plaster, &c., Burnt Lime.—APPENDICES.—INDEX.

"Will be of great use in Cement Works."—*Architect.*

"Concise . . . excellent . . . a useful addition to Cement Literature."—*Concrete.*

LONDON: CHARLES GRIFFIN & CO., LIMITED, EXETER STREET, STRAND.

With Four Folding Plates and Numerous Illustrations. Large 8vo.
8s. 6d. net.

WATER SUPPLY:

A Practical Treatise on the Selection of Sources and the Distribution of Water.

By REGINALD F. MIDDLETON, M. INST. C. E., M. INST. MECH. E., F. S. I.

ABRIDGED CONTENTS.—Introductory.—Requirements as to Quality.—Requirements as to Quantity.—Storage Reservoirs.—Purification.—Service Reservoirs.—The Flow of Water through Pipes.—Distributing Systems.—Pumping Machines.—Special Requirements.

"As a companion for the student, and a constant reference for the technical man, we anticipate it will take an important position on the bookshelf."—*Practical Engineer*.

In Large Crown 8vo. Fully Illustrated. In Two Volumes.

VOLUME I. FOURTH EDITION. Price 7s. 6d. net.

,, II. THIRD EDITION. READY SHORTLY.

THE CHEMISTRY OF

GAS MANUFACTURE:

A Hand-Book on the Production, Purification, and Testing of Illuminating Gas, and the Assay of the Bye-Products of Gas Manufacture.

By W. J. ATKINSON BUTTERFIELD, M. A., F. I. C., F. O. S.,
Formerly Head Chemist, Gas Works, Beckton, London, E.

"The BEST WORK of its kind which we have ever had the pleasure of reviewing."—*Journal of Gas Lighting*.

With Diagrams and Illustrations. 5s. net.

ACETYLENE:

THE PRINCIPLES OF ITS GENERATION AND USE.

By F. H. LEEDS, F. I. C., F. C. S.,

Member of the Society of Public Analysts and of the Acetylene Association;

AND W. J. ATKINSON BUTTERFIELD, M. A., F. I. C., F. C. S.,
Consulting Chemist, Author of "The Chemistry of Gas Manufacture."

"Brimful of information."—*Chem. Trade Journal*.

"We can thoroughly recommend the book to the manufacturer as a reliable work of reference, to the user as supplying valuable hints on apparatus and methods of procedure, and to the student as a safe and certain guide."—*Acetylene*.

Large 8vo. Handsome Cloth. Price 16s. net.

FIRE AND EXPLOSION RISKS:

A Handbook of the Detection, Investigation, and Prevention of Fires and Explosions.

By DR. VON SCHWARTZ.

Translated from the Revised German Edition

By C. T. C. SALTER.

ABRIDGED GENERAL CONTENTS.—Fires and Explosions of a General Character—Dangers arising from Sources of Light and Heat.—Dangerous Gases.—Risks Attending Special Industries.—Materials Employed.—Agricultural Products.—Fats, Oils, and Resins.—Mineral Oils and Tar.—Alcohol, &c.—Metals, Oxides, Acids, &c.—Lightning Ignition Appliances, Fireworks.

"The work affords a wealth of information on the chemistry of fire and kindred topics."—*Fire and Water*.

"A complete and useful survey of a subject of wide interest and vital importance."—*Oil and Colourman's Journal*.

LONDON: CHARLES GRIFFIN & CO., LIMITED, EXETER STREET, STRAND.

FOURTEENTH EDITION, Thoroughly Revised. The Appendix on Sanitary Law being Entirely Re-Written for this Edition. Price 6s.

PRACTICAL SANITATION: A HAND-BOOK FOR SANITARY INSPECTORS AND OTHERS INTERESTED IN SANITATION.

By GEORGE REID, M.D., D.P.H.,
*Fellow, Mem. Council, and Examiner, Sanitary Institute of Great Britain,
and Medical Officer to the Staffordshire County Council.*

With an Appendix on Sanitary Law.

By HERBERT MANLEY, M.A., M.B., D.P.H.,
Barrister-at-Law.

GENERAL CONTENTS.—Introduction.—Water Supply: Drinking Water, Pollution of Water.—Ventilation and Warming.—Principles of Sewage Removal.—Details of Drainage; Refuse Removal and Disposal.—Sanitary and Insanitary Work and Appliances.—Details of Plumbers' Work.—House Construction.—Infection and Disinfection.—Food, Inspection of; Characteristics of Good Meat; Meat, Milk, Fish, &c., unfit for Human Food.—Appendix: Sanitary Law: Model Bye-Laws, &c.

"A VERY USEFUL HANDBOOK, with a very useful Appendix. We recommend it not only to SANITARY INSPECTORS, but to HOUSEHOLDERS and ALL interested in Sanitary Matters."—*Sanitary Record.*

In Handsome Cloth. With 53 Illustrations. 3s. 6d. net.

LESSONS ON SANITATION.

By JOHN WM. HARRISON, M.R.SAN.I.,

Mem. Incor. Assoc. Mun. and County Engineers; Surveyor, Wombwell, Yorks.

CONTENTS.—Water Supply.—Ventilation.—Drainage.—Sanitary Building Construction.—Infectious Diseases.—Food Inspection.—Duties of an Inspector of Nuisances and Common Lodging Houses.—Infectious Diseases Acts.—Factory and Workshop Acts.—Housing of the Working Classes Act.—Shop Hours Acts.—Sale of Food and Drugs Acts. The Margarine Acts.—Sale of Horseflesh, &c.—Rivers Pollution.—Canal Boats Act.—Diseases of Animals.—Dairies, Cowsheds and Milkshops Order.—Model Bye-Laws.—Miscellaneous.—INDEX.

"Accurate, reliable, and compiled with conciseness and care."—*Sanitary Record.*

SECOND EDITION, Revised. In Crown 8vo. Handsome Cloth. Profusely Illustrated. 8s. 6d. net.

SANITARY ENGINEERING:

A Practical Manual of Town Drainage and Sewage and Refuse Disposal.

*For Sanitary Authorities, Engineers, Inspectors, Architects,
Contractors, and Students.*

By FRANCIS WOOD, A.M.INST.C.E., F.G.S.,

Borough Engineer and Surveyor, Fulham; late Borough Engineer, Bacup, Lancs.

GENERAL CONTENTS.

Introduction.—Hydraulics.—Velocity of Water in Pipes.—Earth Pressures and Retaining Walls.—Powers.—House Drainage.—Land Drainage.—Sewers.—Separate System.—Sewage Pumping.—Sewer Ventilation.—Drainage Areas.—Sewers, Manholes, &c.—Trade Refuse.—Sewage Disposal Works.—Bacterial Treatment.—Sludge Disposal.—Construction and Cleansing of Sewers.—Refuse Disposal.—Chimneys and Foundations.

"The volume bristles with information which will be greedily read by those in need of assistance. The book is one that ought to be on the bookshelves of EVERY PRACTICAL ENGINEER."—*Sanitary Journal.*
"A VERITABLE POCKET COMPENDIUM of Sanitary Engineering. . . . A work which may, in many respects, be considered as COMPLETE. . . . COMMENDABLY CAUTIOUS . . . INTERESTING . . . SUGGESTIVE."—*Public Health Engineer*

LONDON: CHARLES GRIFFIN & CO., LIMITED, EXETER STREET, STRAND.

SECOND EDITION. *In Large 8vo. Handsome Cloth. Beautifully Illustrated. With Plates and Figures in the Text. 21s. net.*

ROAD MAKING AND MAINTENANCE:

A Practical Treatise for Engineers, Surveyors, and Others.

WITH AN HISTORICAL SKETCH OF ANCIENT AND MODERN PRACTICE.

By THOS. AITKEN, Assoc. M. INST. C. E.,

Member of the Association of Municipal and County Engineers; Member of the Sanitary Inst.; Surveyor to the County Council of Fife. Cupar Division.

WITH NUMEROUS PLATES, DIAGRAMS, AND ILLUSTRATIONS.

CONTENTS.—Historical Sketch.—Resistance of Traction.—Laying out New Roads.—Earthworks, Drainage, and Retaining Walls.—Road Materials, or Metal.—Quarrying.—Stone Breaking and Haulage.—Road-Rolling and Scarifying.—The Construction of New, and the Maintenance of existing Roads.—Carriage Ways and Foot Ways.

"The Literary style is EXCELLENT. . . . A COMPREHENSIVE and EXCELLENT Modern Book, an UP-TO-DATE work. . . . Should be on the reference shelf of every Municipal and County Engineer or Surveyor in the United Kingdom, and of every Colonial Engineer."—*The Surveyor*.

In Handsome Cloth. Fully Illustrated. 10s. 6d. net.

DUSTLESS ROADS. TAR MACADAM.

By J. WALKER SMITH,

Borough Engineer and Master of Works, Edinburgh.

CONTENTS.—Necessity for Improved and Standard Road Construction.—Tar.—Standardisation of Matrix.—Aggregate for Macadam—Different Modes of Preparing and Laying.—Mechanical Mixing.—Effects of Wear, Density, Porosity, Distribution of Weight.—Scavenging; Watering and Maintenance.—Camber; Gradient, Noiselessness, Hygienic Advantages.—Rolling.—Tractive Effort.—Statistics.—Tar Spraying on Ordinary Macadam Surfaces.—APPENDICES.—INDEX.

In Demy 8vo. Handsome Cloth. With Many Tables.

THE THEORY AND PRACTICE OF ENAMELLING ON IRON AND STEEL.

By JULIUS GRÜNWARD,

Technical Chemist and Works' Manager.

CONTENTS.—Introduction.—The Raw Materials.—The Mixing, Dissolving, and Application of Enamel.—Heating and Pickling Goods in the Rough.—Correct laying on.—Baking Enamelled Ware.—Decoration of Enamelled Objects.—Photo-Ceramics in their Application to Enamels.—General and Statistical Chapter.—The History of Enamels and their Uses.—INDEX.

LONDON: CHARLES GRIFFIN & CO., LIMITED, EXETER STREET, STRAND.

In Large 8vo. Handsome Cloth. Profusely Illustrated. 30s. net.

A TREATISE ON
COLOUR MANUFACTURE.

A Guide to the Preparation, Examination, and Application of all the
Pigment Colours in Practical Use.

By GEORGE ZERR AND DR. R. RÜBENCAMP.

AUTHORISED ENGLISH TRANSLATION BY DR. C. MAYER, OF BURGENDORF.

"This comprehensive guide . . . useful and interesting."—*Oil and Colour Trades Journal*.

FOURTH EDITION, Revised and Enlarged. With Illustrations. 12s. 6d.

PAINTERS' COLOURS, OILS, AND VARNISHES:
A PRACTICAL MANUAL.

By GEORGE H. HURST, F.C.S.

GENERAL CONTENTS.—Introductory—THE COMPOSITION, MANUFACTURE, ASSAY, and ANALYSIS OF PIGMENTS, White, Red, Yellow and Orange, Green, Blue, Brown, and Black—LAKES—Colour and Paint Machinery—Paint Vehicles (Oils, Turpentine, &c., &c.)—Driers—VARNISHES.

"A THOROUGHLY PRACTICAL book. . . . Satisfactorily treats of the manufacture of oils, colours, and pigments."—*Chemical Trades' Journal*.

In Crown 8vo. Handsome Cloth. With Illustrations. 5s.

THE PAINTER'S LABORATORY GUIDE.

A Student's Handbook of Paints, Colours, and Varnishes.

By GEORGE H. HURST, F.C.S.

ABSTRACT OF CONTENTS.—Preparation of Pigment Colours.—Chemical Principles Involved.—Oils and Varnishes.—Properties of Oils and Varnishes.—Tests and Experiments.—Plants, Methods, and Machinery of the Paint and Varnish Manufactures.

"This excellent handbook, . . . the model of what a handbook should be."—*Oils, Colours, and Drysalteries*.

THIRD EDITION, Revised. In Crown 8vo. extra. With Numerous Illustrations and Plates (some in Colours), including Original Designs. 12s. 6d.

Painting and Decorating:

*A Complete Practical Manual for House
Painters and Decorators.*

By WALTER JOHN PEARCE,

LECTURER AT THE MANCHESTER TECHNICAL SCHOOL FOR HOUSE-PAINTING AND DECORATING

"A THOROUGHLY USEFUL BOOK . . . GOOD, SOUND, PRACTICAL INFORMATION in a CLEAR and CONCISE FORM."—*Plumber and Decorator*.

"A THOROUGHLY GOOD AND RELIABLE TEXT-BOOK. . . . So FULL and COMPLETE that it would be difficult to imagine how anything further could be added about the Painter's craft."—*Builders' Journal*.

LONDON: CHARLES GRIFFIN & CO., LIMITED, EXETER STREET, STRAND.

SECOND EDITION. In Large 8vo. Handsome Cloth. With 4 Plates and Several Illustrations. 16s. net.

THE CHEMISTRY OF INDIA RUBBER.

A Treatise on the Nature of India Rubber, its Chemical and Physical Examination, and the Determination and Valuation of India Rubber Substitutes.

Including the Outlines of a Theory on Vulcanisation.

By CARL OTTO WEBER, PH.D.

"Replete with scientific and also with technical interest. . . . The section on physical properties is a complete *résumé* of every thing known on the subject."—*India-rubber Journal*.

In Handsome Cloth. Fully Illustrated.

THE MANUFACTURE OF RUBBER GOODS.

By ADOLF HEIL AND DR. W. ESCH.

TRANSLATED BY EDWARD W. LEWIS, A.C.G.I., F.C.S.,

Chemist to Messrs. J. G. INGRAM & SON, London.

GENERAL CONTENTS.—Raw Material and its Preparation.—Vulcanisation.—Rubber Mixings.—Manufacture of Soft Rubber Goods.—Manufacture of Hard Rubber Goods.—Regeneration of Waste Rubber.—Specific Gravity of Rubber Goods.—INDEX.

In Large Crown 8vo. Fully Illustrated. 5s. net.

GLUE, GELATINE, AND THEIR ALLIED PRODUCTS,

A Practical Handbook for the Manufacturer, Agriculturist, and Student of Technology.

By THOMAS LAMBERT,

Analytical and Technical Chemist.

CONTENTS.—Historical.—GLUE.—GELATINE.—Size and Isinglass.—Treatment of Effluents produced in Glue and Gelatine Making.—Liquid and other Glues, Cements, &c.—Uses of Glue and Gelatine.—Residual Products.—Analysis of Raw and Finished Products.—APPENDIX.—INDEX.

"A sufficient account of modern methods of working, chiefly from a practical standpoint. A book . . . of real value."—*Chemical News*.

In Large 8vo. Handsome Cloth. Fully Illustrated. 15s. net.

LEATHER TRADES' CHEMISTRY.

A Practical Manual on the Analysis of Materials and Finished Products.

By S. R. TROTMAN, M.A., F.I.C.,

Public Analyst for the City of Nottingham, Member of the International Association of Leather Trades' Chemists.

SYNOPSIS OF CONTENTS.—Standard Solutions.—Acids, Alkalies, &c.—Water.—Depilation and Delimiting.—Fleshings, &c.—Glue.—Spent Liquors.—Mineral and Vegetable Tanning Agents.—Oils.—Soaps.—Varnishes.—Skin.—Leather.—Dyestuffs.—Degreasing Agents.—Effluents.—GLOSSARY.—INDEX.

"Mr. Trotman has admirably succeeded in his aim. . . . Practically every section the leather trade chemistry is gone into."—*Leather Trades' Review*.

In Large 8vo. Handsome Cloth. With Plates and Illustrations. 7s. 6d. net.

THE MANUFACTURE OF INK.

A Handbook of the Production and Properties of Printing, Writing, and Copying Inks.

By C. A. MITCHELL, B.A., F.I.C., F.C.S., & T. C. HEPWORTH.

"Thoroughly well arranged . . . and of a genuinely practical order."—*British Printer*.

LONDON: CHARLES GRIFFIN & CO., LIMITED, EXETER STREET, STRAND.

THE TEXTILE INDUSTRIES.

SECOND EDITION, *Thoroughly Revised Throughout. In Two Large Volumes. Handsome Cloth.*

A MANUAL OF DYEING:
 FOR THE USE OF PRACTICAL DYERS, MANUFACTURERS, STUDENTS,
 AND ALL INTERESTED IN THE ART OF DYEING.

BY

E. KNECHT, Ph.D., F.I.C.,

Head of the Chemistry and Dyeing Department of
 the Technical School, Manchester; Editor of "The
 Journal of the Society of Dyers and Colourists;"

CHR. RAWSON, F.I.C., F.C.S.,

Late Head of the Chemistry and Dyeing Department
 of the Technical College, Bradford; Member
 of the Council of the Society of Dyers and Colourists;

AND RICHARD LOEWENTHAL, Ph.D.

GENERAL CONTENTS.—Chemical Technology of the Textile Fabric—
 Water—Washing and Bleaching—Acids, Alkalies, Mordants—Natural
 Colouring Matters—Artificial Organic Colouring Matters—Mineral Colours
 —Machinery used in Dyeing—Tinctorial Properties of Colouring Matters
 Analysis and Valuation of Materials used in Dyeing, &c., &c.

"This authoritative and exhaustive work . . . the MOST COMPLETE we have yet seen
 on the subject."—*Textile Manufacturer.*

In Large 8vo, Handsome Cloth. Pp. i-xv + 405. 16s. net.

THE SYNTHETIC DYESTUFFS,

AND

THE INTERMEDIATE PRODUCTS FROM WHICH THEY ARE DERIVED.

By JOHN CANNELL CAIN, D.Sc. (MANCHESTER AND TÜBINGEN),
 Technical Chemist,

AND JOCELYN FIELD THORPE, Ph.D. (HEIDELBERG), F.R.S.,
 Lecturer on Colouring Matters in the Victoria University of Manchester.

Part I. Theoretical. Part II. Practical. Part III. Analytical.

"We have no hesitation in describing this treatise as one of the most valuable books
 that has appeared. . . . Will give an impetus to the study of Organic Chemistry
 generally."—*Chemical Trade Journal.*

*Companion Volume to Knecht & Rawson's "Dyeing." In Large 8vo.
 Handsome Cloth, Library Style. 16s. net.*

A DICTIONARY OF

DYES, MORDANTS, & OTHER COMPOUNDS

USED IN DYEING AND CALICO PRINTING.

*With Formulæ, Properties, and Applications of the various substances described,
 and concise directions for their Commercial Valuation,
 and for the Detection of Adulterants.*

By CHRISTOPHER RAWSON, F.I.C., F.C.S.,

Consulting Chemist to the Behar Indigo Planters' Association; Co-Author of "A Manual
 of Dyeing;"

WALTER M. GARDNER, F.C.S.,

Head of the Department of Chemistry and Dyeing, Bradford Municipal Technical College;
 Editor of the "Journ. Soc. Dyers and Colourists;"

AND W. F. LAYCOCK, Ph.D., F.C.S.,

Analytical and Consulting Chemist.

"Turn to the book as one may on any subject, or any substance in connection with the
 trade, and a reference is sure to be found. The authors have apparently left nothing out."
 —*Textile Mercury.*

LONDON: CHARLES GRIFFIN & CO., LIMITED, EXETER STREET, STRAND.

In Crown 8vo. Cloth. With Numerous Illustrations. 6s. net.
THE COTTON WEAVERS' HANDBOOK.
*A Practical Guide to the Construction and Costing of Cotton Fabrics,
 with Studies in Design.*

By HENRY B. HEYLIN,
 Of the Royal Technical Institute, Salford.

CONTENTS.—Weaving.—Designing.—Weaves.—The Power Loom and its Accessories.—Analysing or Dissection of the Cloth.—Cloth Quoting or Costing.—Division of the Cotton Industry in England.—Yarns for Manufacturing Purposes.—The Selection of Warp Yarns and Yarn Testing.—Read and Heald Counting and Calculations.—Important Labour Units in a Weaving Mill.—Miscellany.—Illustrations of Machinery.—Examination Questions.—INDEX.

“Mr. Heylin's text-book is a very reliable one. It is difficult to mark out any special points among so much excellent matter.”—*Dyer and Calico Printer.*

Large 8vo. Profusely Illustrated with Plates and Figures in the Text.
 16s. net.

**THE SPINNING AND TWISTING OF LONG
 VEGETABLE FIBRES**
 (FLAX, HEMP, JUTE, TOW, & RAMIE).

*A Practical Manual of the most Modern Methods as applied to the Hackling, Carding
 Preparing, Spinning, and Twisting of the Long Vegetable Fibres of Commerce.*

By HERBERT R. CARTER, Belfast and Lille.

GENERAL CONTENTS.—Long Vegetable Fibres of Commerce.—Rise and Growth of the Spinning Industry.—Raw Fibre Markets.—Purchasing Raw Material.—Storing and Preliminary Operations.—Hackling.—Sorting.—Preparing.—Tow Carding and Mixing.—Tow Combing.—Gill Spinning.—The Roving Frame.—Dry and Demi-sec Spinning.—Wet Spinning.—Spinning Waste.—Yarn Reeling.—Manufacture of Threads, Twines, and Cords.—Rope Making.—The Mechanical Department.—Modern Mill Construction.—Steam and Water Power.—Power Transmission.

“Meets the requirements of the Mill Manager or Advanced Student in a manner perhaps more than satisfactory. . . . We must highly commend the work as representing up-to-date practice.”—*Nature.*

In Large 8vo, Handsome Cloth, with Numerous Illustrations. 9s. net.
TEXTILE FIBRES OF COMMERCE.
 A HANDBOOK OF

The Occurrence, Distribution, Preparation, and Industrial Uses of the
 Animal, Vegetable, and Mineral Products used in Spinning and Weaving
 By WILLIAM I. HANNAN,

Lecturer on Botany at the Ashton Municipal Technical School, Lecturer on Cotton
 Spinning at the Chorley Science and Art School, &c.

“USEFUL INFORMATION. . . . ADMIRABLE ILLUSTRATIONS. . . .”—*Textile Recorder.*

In Large 8vo, with Illustrations and Printed Patterns. Price 21s.
TEXTILE PRINTING:
 A PRACTICAL MANUAL.

Including the Processes Used in the Printing of
 COTTON, WOOLLEN, SILK, and HALF-
 SILK FABRICS.

By C. F. SEYMOUR ROTHWELL, F.C.S.,

Mem. Soc. of Chem. Ind.; late Lecturer at the Munic. Tech. School, Manchester.

“By FAR THE BEST and MOST PRACTICAL BOOK ON TEXTILE PRINTING which has yet been
 brought out, and will long remain the standard work on the subject.”—*Textile Mercury.*

LONDON: CHARLES GRIFFIN & CO., LIMITED, EXETER STREET, STRAND.

Large 8vo. Handsome Cloth. 12s. 6d.

BLEACHING & CALICO-PRINTING.

A Short Manual for Students and
Practical Men.

By GEORGE DUERR,

Director of the Bleaching, Dyeing, and Printing Department at the Accrington and Bacup
Technical Schools; Chemist and Colourist at the Irwell Print Works.

ASSISTED BY WILLIAM TURNBULL

(of Turnbull & Stockdale, Limited).

With Illustrations and upwards of One Hundred Dyed and Printed Patterns
designed specially to show various Stages of the Processes described.

GENERAL CONTENTS.—COTTON, Composition of; BLEACHING, New Processes; PRINTING, Hand-Block; Flat-Press Work; Machine Printing—MORDANTS—STYLES OF CALICO-PRINTING: The Dyed or Madder Style, Resist Padded Style, Discharge and Extract Style, Chromed or Raised Colours, Insoluble Colours, &c.—Thickeners—Natural Organic Colouring Matters—Tannin Matters—Oils, Soaps, Solvents—Organic Acids—Salts—Mineral Colours—Coal Tar Colours—Dyeing—Water, Softening of—Theory of Colours—Weights and Measures, &c.

"When a READY WAY out of a difficulty is wanted, it is IN BOOKS LIKE THIS that it is found."—*Textile Recorder*.

"Mr. DUERR'S WORK will be found MOST USEFUL . . ." The information given is of GREAT VALUE. . . . The Recipes are THOROUGHLY PRACTICAL."—*Textile Manufacturer*.

In Handsome Cloth. With 76 Illustrations. 5s. net.

DYEING AND CLEANING.

By FRANK J. FARRELL, M.Sc., &c.

GENERAL CONTENTS.—Technology of the Textile Fibres.—Dry Cleaning.—Wet Cleaning.—Dyeing.—Dry Dyeing.—Special Methods, Cleaning and Dyeing Skin Rugs, Feathers, and Hats.—Finishing.—APPENDICES.—INDEX.

"A timely and valuable contribution . . . well got up in every way."—*Dyer and Calico Printer*.

LONDON: CHARLES GRIFFIN & CO., LIMITED, EXETER STREET, STRAND.

"Boys COULD NOT HAVE A MORE ALLURING INTRODUCTION to scientific pursuits than these charming-looking volumes."—Letter to the Publishers from the Headmaster of one of our great Public Schools.

Handsome Cloth, 7s. 6d. Gilt, for Presentation, 8s. 6d.

OPEN-AIR STUDIES IN BOTANY:

SKETCHES OF BRITISH WILD FLOWERS
IN THEIR HOMES.

By R. LLOYD PRAEGER, B.A., M.R.I.A.

Illustrated by Drawings from Nature by S. Rosamond Praeger,
and Photographs by R. Welch.

GENERAL CONTENTS.—A Daisy-Starred Pasture—Under the Hawthorn—By the River—Along the Shingle—A Fragrant Hedgerow—A Connemara Bog—Where the Samphire grows—A Flowery Meadow—Among the Corn (a Study in Weeds)—In the Home of the Alpines—A City Rubbish-Heap—Glossary.

"A FRESH AND STIMULATING book . . . should take a high place . . . The illustrations are drawn with much skill."—*The Times*.

"BEAUTIFULLY ILLUSTRATED. . . . One of the MOST ACCURATE as well as INTERESTING books of the kind we have seen."—*Athenæum*.

"Redolent with the scent of woodland and meadow."—*The Standard*.

With 12 Full-Page Illustrations from Photographs. Cloth.
Second Edition, Revised. 8s. 6d.

OPEN-AIR STUDIES IN GEOLOGY:

An Introduction to Geology Out-of-doors.

By GRENVILLE A. J. COLE, F.G.S., M.R.I.A.,

Professor of Geology in the Royal College of Science for Ireland,
and Examiner in the University of London.

GENERAL CONTENTS.—The Materials of the Earth—A Mountain Hollow—Down the Valley—Along the Shore—Across the Plains—Dead Volcanoes—A Granite Highland—The Annals of the Earth—The Surrey Hills—The Folds of the Mountains.

"The FASCINATING 'OPEN-AIR STUDIES' of PROF. COLE give the subject a GLOW OF ANIMATION . . . cannot fail to arouse keen interest in geology."—*Geological Magazine*

"A CHARMING BOOK, beautifully illustrated" —*Athenæum*.

Beautifully Illustrated. With a Frontispiece in Colours, and Numerous
Specially Drawn Plates by Charles Whympers. 7s. 6d.

OPEN-AIR STUDIES IN BIRD-LIFE:

SKETCHES OF BRITISH BIRDS IN THEIR HAUNTS.

By CHARLES DIXON.

The Spacious Air.—The Open Fields and Downs.—In the Hedgerows.—On Open Heath and Moor.—On the Mountains.—Amongst the Evergreens.—Copses and Woodland.—By Stream and Pool.—The Sandy Wastes and Mud flats.—Sea-laved Rocks.—Birds of the Cities.—INDEX.

"Enriched with excellent illustrations. A welcome addition to all libraries."—*Westerminster Review*.

LONDON: CHARLES GRIFFIN & CO., LIMITED. EXETER STREET, STRAND.

Twenty-fifth Annual Issue. Handsome cloth, 7s. 6d.

(To Subscribers, 6s.).

THE OFFICIAL YEAR-BOOK

OF THE

SCIENTIFIC AND LEARNED SOCIETIES OF GREAT BRITAIN AND IRELAND.

COMPILED FROM OFFICIAL SOURCES.

Comprising (together with other Official Information) *LISTS* of the *PAPERS* read during the Session 1907-1908 before all the *LEADING SOCIETIES* throughout the Kingdom engaged in the following *Departments of Research* :—

- | | |
|---|---|
| § 1. Science Generally : <i>i.e.</i> , Societies occupying themselves with several Branches of Science, or with Science and Literature jointly. | § 6. Economic Science and Statistics. |
| § 2. Mathematics and Physics. | § 7. Mechanical Science, Engineering, and Architecture. |
| § 3. Chemistry and Photography. | § 8. Naval and Military Science. |
| § 4. Geology, Geography, and Mineralogy. | § 9. Agriculture and Horticulture. |
| § 5. Biology, including Microscopy and Anthropology. | § 10. Law. |
| | § 11. Literature |
| | § 12. Psychology. |
| | § 13. Archæology. |
| | § 14. MEDICINE. |

"FILLS A VERY REAL WANT."—*Engineering*.

"INDISPENSABLE to any one who may wish to keep himself abreast of the scientific work of the day."—*Edinburgh Medical Journal*.

"The YEAR-BOOK OF SOCIETIES is a Record which ought to be of the greatest use to the progress of Science."—*Lord Playfair, F.R.S., K.C.B., M.P., Past-President of the British Association.*

"It goes almost without saying that a Handbook of this subject will be in time one of the most generally useful works for the library or the desk."—*The Times.*

"British Societies are now well represented in the 'Year-Book of the Scientific and Learned Societies of Great Britain and Ireland.'"—(Art. "Societies" in New Edition of "Encyclopædia Britannica," vol. xxii.)

Copies of the *FIRST ISSUE*, giving an Account of the History, Organization, and Conditions of Membership of the various Societies, and forming the groundwork of the Series, may still be had, price 7/6. *Also Copies of the Issues following.*

The YEAR-BOOK OF SOCIETIES forms a complete INDEX TO THE SCIENTIFIC WORK of the sessional year in the various Departments. It is used as a HANDBOOK in all our great SCIENTIFIC CENTRES, MUSEUMS, and LIBRARIES throughout the Kingdom, and has become an INDISPENSABLE BOOK OF REFERENCE to every one engaged in Scientific Work.

LONDON: CHARLES GRIFFIN & CO., LIMITED, EXETER STREET, STRAND.

