

Digitized for Microsoft Corporation
by the Internet Archive in 2007.

From Prelinger Library.

May be used for non-commercial, personal, research,
or educational purposes, or any fair use.

May not be indexed in a commercial service.



MESOZOIC

FUTURE ->?

PRE-PLANETARY TIME

PALEOZOIC

ZOIC

Recreation

JAN 14 1957

500
MILLION
YEARS

EACH TICK
EQUALS
MILLION
YEARS

Henry Pfeiffer Library
Mac... College
Jack... Illinois

LOOK TO

PORTER



FOR THE FINEST IN GYMNASIUM EQUIPMENT

You can look further but you can't "buy better" than PORTER. Long time pioneers in the design and manufacture of top quality, long enduring gym equipment, PORTER is a solid choice in thousands of schools, universities, clubs, and institutions.

Why not give your next gymnasium equipment requirements the PORTER treatment?

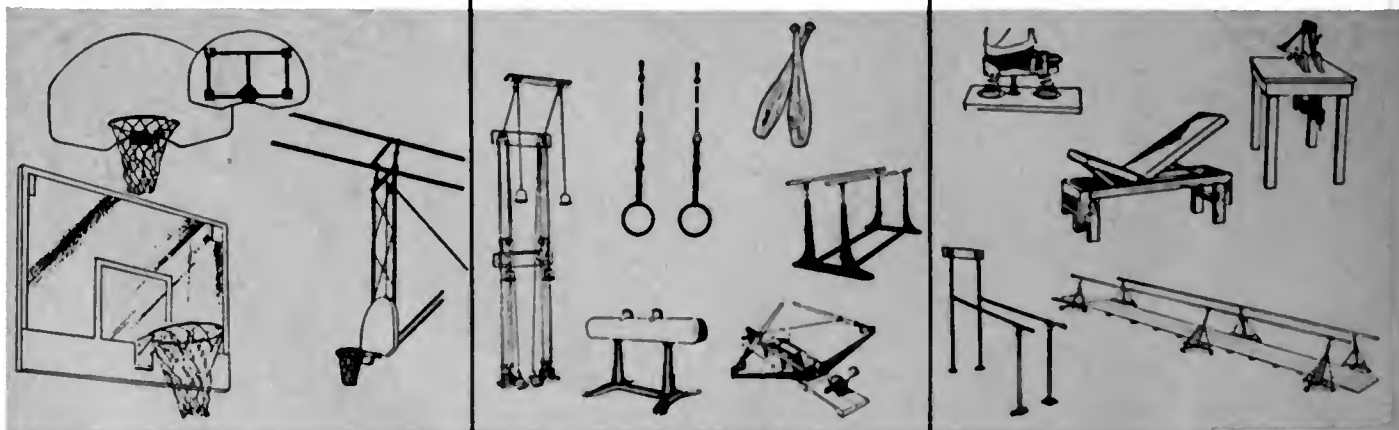

PORTER'S LINE OF GYMNASIUM EQUIPMENT IS COMPLETE BUT IT IS ALSO AUTHENTIC

- Basketball Backstops
- Corrective Equipment
- Chest Machines
- Climbing Ropes
- Anthropometric Equipment
- Stall Bars
- Parallel Bars
- Horizontal Bars
- Spring Boards
- Rowing Machines
- Vaulting Horses
- Vaulting Bucks
- Jump Standards
- Mats and Mat Trucks
- Game Standards

PORTER engineers are always available for assistance in the selection and installation of every kind of gymnasium or corrective equipment.



Nearly a Century of Quality Manufacturing

THE J. E. PORTER CORPORATION
OTTAWA • ILLINOIS

BUILDERS OF GYMNASIUM, PLAYGROUND AND BASKETBALL EQUIPMENT

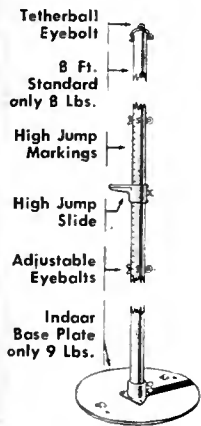

NEW! jayfro
Multi-Purpose
ALUMINUM STANDARD
Use it 12 Ways!

- Interchangeable
Indoors and Outdoors for
- VOLLEY BALL • SADMINTON
 - TENNIS • PADDLE TENNIS
 - HIGH JUMP • TETHERBALL
- ✓ Official specifications
 - ✓ Lightweight
 - ✓ Easy to install and move
 - ✓ No maintenance
 - ✓ Six different models



jayfro
BASKETBALL STEEL CHAIN NETS

3 Years Guarantee!
outdoors or indoors

Also Featuring Jayfro's Custom Built
New and Improved!

✓ **PADDLE TETHERBALL SETS**

Revolutionary and Exciting New!

✓ **SHUFFLEBOARD SETS**
with "RUBBER CUSHIONED" DISCS

• Send for Free Catalog •

JAYFRO ATHLETIC SUPPLY CO.
Dept. RC, Box 1065, NEW LONDON, CONN.

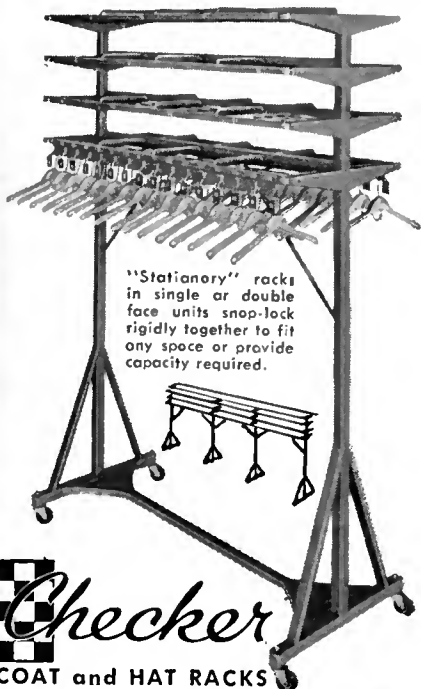

"Stationary" racks in single or double face units snap-lock rigidly together to fit any space or provide capacity required.

Checker

COAT and HAT RACKS

Style D.F. 4-40, Portable Checker Rack (Illustrated) is 4 ft. 2 in. long; holds 40 coats and hats; goes wherever needed on large, ball-bearing-swivel casters. Comes with or without checks and snap-on numbers. Strongly welded of square tubular, heavy gauge and highly embossed furniture steel. Smart in modern baked finishes. Give lifetime service—never sag, creak or sway. 3 ft., 4 & 5 ft. units available, as well as other efficient space saving equipment for every church, school, commercial, industrial and institutional need.

Write for Bulletin CK-515

VOGEL-PETERSON CO.
1121 W. 37th Street • Chicago 9, Illinois

FREE!

THIS BIG ILLUSTRATED LEATHERCRAFT CATALOG

There is no finer source of materials for Leathercraft projects of all kinds . . . easy-to-assemble kits to enable beginners to make billfolds, gloves, purses, belts and other attractive items . . . top quality tooling and carving leathers for advanced craftsmen. Also complete line of Leathercraft tools, accessories, supplies and instruction books.

ATTENTION METALCRAFT HOBBYISTS

Here is a comprehensive illustrated catalog from which you can make your selection of aluminum and copper in sheets and shapes for many projects; copper, aluminum and brass foil for metal tooling; kilns, colors and kits for metal enameling; instruction books, tools and accessories for metalcraft of all kinds.

SEND TODAY FOR EITHER OR BOTH FREE CATALOGS

J. C. LARSON CO.
820 S. TRIPP AVE., DEPT. 6205
CHICAGO 24, ILLINOIS

866

Superior Design, Construction and PERFORMANCE

far greater strength and SAFETY!

AMERICAN
Approved
PLAYGROUND AND SWIMMING POOL EQUIPMENT

The wise choice of experienced buyers for nearly half a century.

WRITE FOR LITERATURE



You'll find exciting ideas for

- ★ CHILDREN'S CRAFTS
Valentines, Easter Eggs
- ★ ITALIAN STREET FAIR
- ★ SPRING FLOWERS TO MAKE
- ★ "WHAT'S MY NAME" PARTY
- ★ ORIENTAL PARTY TRIM
- ★ DO-IT-YOURSELF CRAFTS



in **"Here's An Idea"**

The Spring edition of "Here's An Idea" — published by Dennison — is full of wonderful things to do and things to make — from brightening a hall to decorating an Easter egg. You'll find ideas for lampshades, picture frames, parties, window decorations, showers, gift wraps, favors. Lots of full-color pictures — clear, easy-to-follow instructions.

ONLY 50¢ WHERE YOU BUY DENNISON CREPE PAPER OR MAIL THIS COUPON

DENNISON, Dept. N-189
300 Howard Street, Framingham, Mass.

I enclose 50¢. Please send me the Spring edition of "Here's An Idea."

Name

Street

City Zone State

Dennison

Recreation*



THE MAGAZINE OF THE RECREATION MOVEMENT

Editor in Chief, JOSEPH PRENDERGAST
Editor, DOROTHY DONALDSON
Editorial Assistant, AMELIA HENLY
Business Manager, ALFRED H. WILSON

CONTENTS

ASSOCIATE EDITORS
Recreation Administration, GEORGE BUTLER
Program Activities, VIRGINIA MUSSELMAN

GENERAL FEATURES

Vol. L Price 50 Cents No. 1

Otto Tod Mallery (Tribute)	4
They Built a Park	10
The Launching of the International Recreation Association	<i>Thomas E. Rivers</i> 12
Newspapers and Recreation	<i>W. H. Wallace</i> 14
Dr. Abolfazl Sadry (In Memoriam)	15
NRA 1957 District Conference Schedule.....	Inside Back Cover

On the Cover

TIME MOVES INTO THE FUTURE. Children watch the time clock in the Hall of Geology at the Museum of Science in Humboldt Park, Buffalo, New York. Each tick equals a million years. Photo reprinted from *Hobbies*, through courtesy of Mrs. Verne L. Simril of Williamsville, New York, an amateur photographer who won a \$1,000 award for another snapshot, and courtesy of Miss Emily H. Zurbrick, Buffalo Society of Natural Sciences.

ADMINISTRATION

Next Month

An excellent article on adolescence by Helen Rapp, one on "Family Recreation—Foe of Juvenile Delinquency" by Charles A. Bucher, suggestions for your February parties and for your annual meeting. The editorial by Sherwood Gates, taken from his address to volunteers of the Cooperative Community Exchange Project group, is an excellent presentation of his concept of "The 'Why' of Recreation."

Some Yardsticks—for Relating Participation to Costs	<i>H. C. Hutchins</i> 23
Planning for Recreation Parks in California.....	<i>George Butler</i> 25
Latest Agency Information	27

Photo Credits

Page 4, courtesy Franklin Institute; 17, Algoma Record-Herald.

PROGRAM

The Dugout—A Youth Center that Serves.....	<i>Edgar W. Nell</i> 16
Musical Games and Their Creative Use.....	<i>Leah M. Jaffa</i> 18
Programs on Exhibition (Idea of the Month).....	21
Lacquer Batik (How To Do It!).....	<i>Frauk A. Staples</i> 22

REGULAR FEATURES

Things You Should Know.....	6
Letters	8
On the Campns	<i>Alfred B. Jensen</i> 27
Market News	28
Hospital Capsules	<i>Beatrice H. Hill</i> 29
Personnel Notes	29
Books and Pamphlets Received, Magazine Articles.....	30
Index to Advertisers	30
New Publications	31
How To Do It! Idea of the Month.....	See Program
Recreation Leadership Training Courses.....	Inside Back Cover

RECREATION is published monthly except July and August by the National Recreation Association, a service organization supported by voluntary contributions, at 8 West Eighth Street, New York 11, New York, is on file in public libraries and is indexed in the *Readers' Guide*. Subscriptions \$4.00 a year. Canadian and foreign subscription rate \$4.50. Re-entered as second-class matter April 25, 1950, at the Post Office in New York, New York, under Act of March 3, 1879. Acceptance for mailing at special rate of postage provided for in Section 1103, Act of October 3, 1917, authorized May 1, 1924. Microfilms of current issues available University Microfilms, 313 N. First Street, Ann Arbor, Michigan.

Space Representatives: H. Thayer Heaton, 94 Garfield Place, Lynbrook, Long Island, New York; Mark Minahan, 168 North Michigan Avenue, Chicago, Illinois.

Copyright, 1957, by the

National Recreation Association, Incorporated

Printed in the U.S.A.

18



* Trade mark registered in U. S. Patent Office.

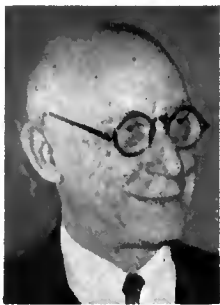

Otto Tod Mallery

1880 - 1956

OTTO TOD MALLERY died on December 16 in his seventy-sixth year. He was struck by a car while taking an evening stroll near his home in Philadelphia. Here ended a life of splendid service to his fellow man. Mr. Mallery was a creative thinker and a pioneer. While recreation was closest to his heart, he was a man of many interests. He was interested in and ready to do something about immediate, local problems but he was equally concerned with problems around the world. He gave generously of his time and his substance at the local, national and international levels.

As the late Howard Braucher, executive secretary and president of the National Recreation Association for many years, once said: "Otto Mallery has been one of the great leaders in the recreation movement nationally and locally in Philadelphia. In his own life he has embodied the recreation spirit, and he has been supremely gifted in interpreting it to others. It is on the farseeing, statesmanlike, devoted, missionary spirit of persons like Otto Mallery that the National Recreation Association and the movement as a whole have been built."

Mr. Mallery was a charter member of the Philadelphia Playgrounds Association which later became the Philadelphia Recreation Association, one of the oldest active private agencies in the recreation field having been formed just six months after the National Recreation Association was established. From 1907 to 1948 he served the Philadelphia group actively, first as treasurer, then for many years as president and since 1948 as chairman emeritus. In 1908 Mr. Mallery became the president of the Philadelphia Recreation Commission, the first great stride toward making recreation a municipal responsibility. At a luncheon in Philadelphia on November 30, 1956, he was presented with an official award by the City of Philadelphia. It paid tribute to him as the Father of Recreation in Philadelphia, a term which has been applied to him on many occasions.

After serving four years on the Council of the Playground Association of America, which later became the National Recreation Association, Mr. Mallery was elected in 1912 to the Board, upon which he served for the remainder of his life. Thus he gave to this Association forty-eight years of untiring service. Since 1951 he has served as chairman.

To Mr. Mallery goes the distinction of being the prime mover in establishing the International Recreation Association which was created at the International Recreation Congress in Philadelphia last October. He was a charter member of its Board. He was active at the National Recreation Congresses, including the International Recreation Congress, being always ready to help.

Many public honors came to Mr. Mallery and these were

accepted with deference and humility, and shared with others with whom he was associated. Mr. Mallery's many official connections with government and private groups are outlined in *Who's Who in America*. Among these, he was formerly senior business specialist of the United States Department of Commerce. He served in 1937 as economic advisor to the United States delegation to the International Labor Office, and later as consultant to the National Resources Planning Board and as a member of the Advisory Committee of the National Youth Administration. For several years he served on the Pennsylvania State Planning Board. He was also a member of the Philadelphia City Charter Committee which was instrumental in paving the way for the splendid recreation system there.

Books written by Mr. Mallery include *Economic Union and Durable Peace*, 1943 and *More Than Conquerors*, 1947. A major article, "Economic Union and Enduring Peace," was written for the *Annals of the American Academy of Political and Social Science*, of which organization he served as trustee. He was also founder and chairman of the Interdependence Council, with operations in forty-nine nations. The council is dedicated to bringing people of various nations together on the basis of those things upon which they can agree. It perfected a "Declaration of Interdependence" which was acted upon in the Philadelphia room where the Declaration of Independence was signed.

Graduating from Princeton University in 1902, Mr. Mallery took graduate work at the University of Pennsylvania and Columbia University. Always interested in music, he played the bass viol in the family chamber music ensemble in which his wife and four children were the principal participants. At a Recreation Congress in Atlantic City, Peter Dykema, music specialist, undertook to form a brass band composed of Congress delegates who had never touched their respective instruments before. Mr. Dykema quickly demonstrated the rudiments of these instruments, held rehearsals and then directed two numbers performed by the group at one of the later sessions of the Congress. It was characteristic of Mr. Mallery that he participated in this activity with great enthusiasm playing the trombone.

The recreation spirit was an inseparable part of Otto Mallery and he was one of its most gifted lay interpreters. Furnishing by his own life an example of outstanding volunteer lay leadership, he wrote in his editorial in the Golden Anniversary Issue of RECREATION last June, "The ultimate strength of the National Recreation Association lies in the devotion and civic spirit of thousands of lay men and women on boards, committees, and foundations who steadily hold the line and keep advancing it." ●

MORE THAN

100,000

U.S. SCHOOLS AND COLLEGES EACH YEAR SPECIFY

America's Finest Sports Equipment by

VOIT

NEW YORK 11

DANVILLE, ILL. · LOS ANGELES 11

Selected RONALD Books . . .

PRINCIPLES OF RECREATION

John L. Hutchinson, Columbia University. This widely used textbook provides a fundamental treatment of recreation which clarifies the basic concepts underlying the organization of

leisure activity. Discusses the responsibilities and functions of the recreation profession, and its cultural significance. 310 pp. \$3.75

THE THEORY OF PLAY

Elmer D. Mitchell, University of Michigan; and Bernard S. Mason. Fully covers the history of the play movement, the theory of play, the role

of play in modern life. Analyzes today's problems of administration and organization. Revised edition of a pioneering textbook. 542 pp. \$4.75

● 2nd Edition—Just Published!

FOLK DANCING in High School and College

Grace I. Fox, Florida State University; and Kathleen Gruppe Merrill, University of Miami. An exciting group of nineteen foreign dances and eight American square dances. Each includes

step-by-step directions for presenting the dance, and simply arranged musical scores for piano accompaniment. 25 ills., 20 musical scores, 90 pp. 8 1/2 x 11. \$3.50

SQUARE DANCES OF TODAY

— and How to Teach and Call Them

Richard Kraus, Columbia University. This widely-used book contains directions for teaching and calling 15 singing squares; 26 patter squares; 14 cir-

cle play parties, couple dances, and long-ways. Instructions for teaching ice breakers and mixers. 52 ills., 31 musical scores, 130 pp. 6 7/8 x 10. \$3.25

RHYTHMS AND DANCES for Elementary Schools

Dorothy La Salle, Wayne State University. A popular collection of music fundamentals, music characterizations, singing games, and folk dances. Includes an alphabetical listing of rhy-

thms and dances, and a glossary of dance steps, terms, and formations. Rev. Ed. 27 ills., 124 musical scores, 201 pp. 6 7/8 x 10. \$4.25

THE RHYTHM OF THE REDMAN

Julia M. Buttrec, Seton Foundation. An anthology of North American Indian songs, dances, ceremonies, lore, and art. Describes 43 dances, includes detailed descriptions of 10 ceremonies,

with history, chants, songs, and music. Materials and procedures used in Indian art are carefully outlined. 71 musical scores, songs. 95 ills., 280 pp. \$5

Through bookstores or from:

THE RONALD PRESS COMPANY

15 East 26th Street, New York 10, N. Y.

START ROLLER SKATING for

maximum gym use



Roller Skating is the one sport in which all your students can participate. It handles large groups of boys and girls quickly and easily, and does not require a change of clothes. The equipment is relatively inexpensive. Little supervision is needed. That's why more and more schools are making roller skating a definite part of their physical education and recreation programs.

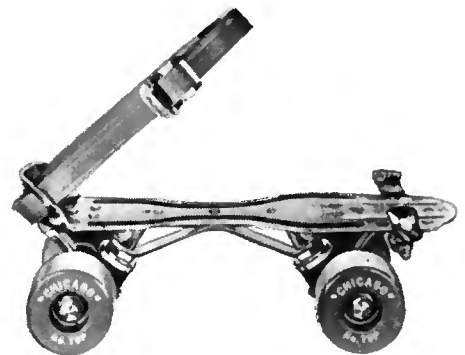

NEW RUBBER-PLASTIC WHEELS ARE KIND TO GYM FLOORS

These new Duryte rubber-plastic wheels outwear others and are guaranteed not to mar or scratch the floors. "Chicago" has a skate designed for any type of floor surface or finish. Write today for free details on roller skating programs and skating equipment.



4490-A West Lake, Chicago 24, Ill.

•
•
•
•
•

Things You Should Know . .

•
•
•

For the New Year

In thy journeys to and fro,
God direct thee;
In thy happiness and pleasure,
God bless thee;
In care, anxiety, or trouble,
God sustain thee;
In peril and in danger,
God protect thee.

—*St. Francis of Assisi*

▶ **THE STEERING COMMITTEE** of Keep America Beautiful, Inc., has been expanded from five to seven members. NRA's Joseph Prendergast is chairman of the KAB National Advisory Council for the coming year.

▶ **REPRINTS OF TWENTY-TWO SECTIONS** of *Park and Recreation Structures*, a 1938 National Park Service publication dealing with the design and construction of park and outdoor facilities, may now be purchased from the Superintendent of Documents, Washington 25, D.C. The sections, all profusely illustrated with construction plans and photographs, were reprinted because of extensive demand by builders and planners of parks and recreation areas. Do-it-yourself enthusiasts have also found them a valuable source of information on various types of outdoor construction. The individual sections are variously priced.

▶ **NEW CHEMICAL CONTROL FOR POND ALGAE** has been tested on the five-acre spring-fed lake at the Los Angeles State and County Arboretum in Arcadia. The lake has been cleansed of surface algae by use of a special chemical. Almost completely covered with a heavy coating of algae, the surface of the lake was made crystal clear within a few days after spraying with a newly developed fungicide known as Phygon-XL.

First use of Phygon-XL in California was in irrigation canals, later in ponds. It has cleared water for fishing, swimming, boating and irrigation. So far, the anti-algae chemical does not appear to have harmed the large stock of fish in the arboretum lake.

▶ **IN AN EFFORT TO HELP SPEARHEAD A COMMUNITY-WIDE ATTACK ON JUVENILE DELINQUENCY**, the Health and Welfare Council, Inc. of Philadelphia has announced plans to develop an integrated program to combat juvenile crime and misbehavior. The Community Chest will spend \$100,000 of reserve funds to help finance the project. The council will work closely with the Youth Service Board in developing a broad approach. Member agencies of the council concerned with the problem will play a major part in helping shape the program.

▶ **A FACT-FINDING SURVEY** of how public and private agencies in New York are fighting juvenile delinquency is being conducted by Mayor Wagner's Juvenile Delinquency Evaluation Project, headed by Robert M. MacIver, a renowned sociologist and professor emeritus of political science at Columbia University. Joseph Prendergast of NRA is on the consultant's committee.

▶ **FORMAL AGREEMENT REACHED EARLY THIS MONTH** clears the way for the THIRTY-NINTH NATIONAL RECREATION CONGRESS to be held in Long Beach, California, September 30 - October 4, 1957, under the combined sponsorship of the National Recreation Association, the American Recreation Society, the California Recreation Society, the Long Beach Recreation Commission, and the Los Angeles County Park and Recreation Department. It will be planned under the direction of a policy and program committee chaired by NRA Executive Director Joseph Prendergast. The executive committee with representatives from the five sponsoring agencies met for the first time in

Long Beach on December 19. Wide representation on the full Policy and Planning Committee is scheduled.

▶ **THE CALIFORNIA AND PACIFIC SOUTHWEST DISTRICT RECREATION CONFERENCE** will take place in Sacramento, February 24-27. Scheduled speakers include Dr. Paul Douglass, on "Personnel"; Dr. Sherwood Gates, on the "Why" of Recreation" (to appear in the February issue of RECREATION); and Mrs. Bartlett B. Heard, member of the California Recreation Commission, on "The Place of the Board Member in a Recreation and Park Department."

▶ **JUNE WILL AGAIN BE NATIONAL RECREATION MONTH IN 1957.** One of its features will be the awarding of National Recreation Association Citations for Outstanding Service to local citizens, organizations and groups. The nominating forms will be sent out with the January 20 issue of the NRA Affiliate Membership Letter. The closing date for nominations will be March 15. We hope that the awarding of such citations can be a continuing process from year to year, so do not try to nominate all of the people at once.

1956 Recreation and Park Yearbook

The striking growth of the recreation movement since the founding of the National Recreation Association in 1906 is portrayed in this volume which records the public recreation and park facilities and services in the United States in 1955. Information concerning federal and state agencies is included for the first time. It includes reports from twelve federal agencies, 185 state authorities, 2,660 municipal and county departments, 279 private organizations, and 3,000 individuals. All of these control and operate lands used for recreation or provide recreation programs or services. Many local, state, district and national organizations participated in its preparation, thus making the fortieth *Yearbook* to be issued by the Association truly a cooperative undertaking.

\$2.00 a copy

Handweaver & Craftsman



New Ideas
**PRACTICAL
PROJECTS**
for
WEAVERS
Of All Ages
IN
**EVERY
ISSUE**

Listed above are typical articles of special interest to recreation directors.

Single Issues \$1.00 a copy

Published Quarterly — 64 Informative Pages

Write today for brochure and prices on back issues.

A subscription to Handweaver & Craftsman and a complete file of back issues will provide you with a live weaving library.

Handweaver & Craftsman

DEPT. R, 246 FIFTH AVENUE, NEW YORK 1

Single copy \$1, 1 yr. \$4, 2 yrs. \$7.50, 3 yrs. \$10, 5 yrs. \$15

Canadian postage 50c year extra, Pan American and foreign \$1

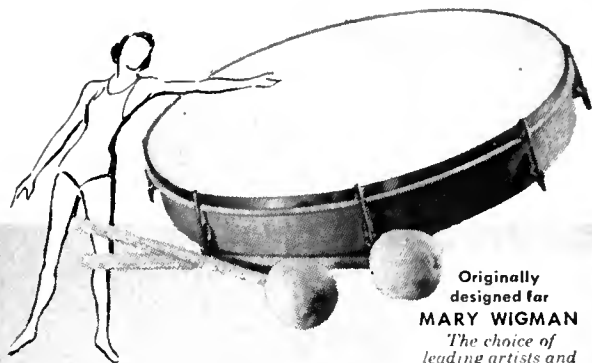

Originally designed for
MARY WIGMAN
The choice of leading artists and foremost schools

*Your group will dance
better to the exciting beat of the*
GRETSCH DANCE DRUM

In the actual dance or as a dramatic accompaniment, the Gretsch Dance Drum lends itself to colorful interpretations of modern, classical and oriental themes.

Light and sturdy—Weighs 23 ounces, has 3-ply laminated rock maple rim, finished in transparent lacquer in natural color. Head of specially selected real skin with bright nickel-plated straining hoop and eight nickel tensioning brackets. In ordering mention X4145—Price \$15.00, postage extra.

Lamb's-wool-head beaters—Used with the Gretsch Dance Drum singly or in pairs. Order #5250 at \$2.50 each, postage extra.

R-157

GRETSCH The FRED. GRETSCH Mfg. Co.
60 Broadway, Brooklyn 11, N. Y.

Makers of fine musical instruments for over 70 years

**CHOICE
OF OVER 5,000
SCHOOLS**

**PRECISION
MADE - NO ADJUSTMENT
NECESSARY**

**RECOMMENDED
FOR AAU AND COLLEGE
COMPETITION**

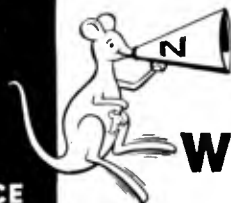

Build Winning Teams...

with NISSEN TRAMPOLINES*

Regulation

MODEL 77-A



*Reg. U. S. Pat. Off.

Write today for **FREE** catalog, and name of nearest dealer

NISSEN TRAMPOLINE COMPANY

200 A Avenue, N. W., Cedar Rapids, Iowa, U. S. A.

NISSEN TRAMPOLINE COMPANY, LTD.

London, England

If it isn't a NISSEN, it isn't a TRAMPOLINE

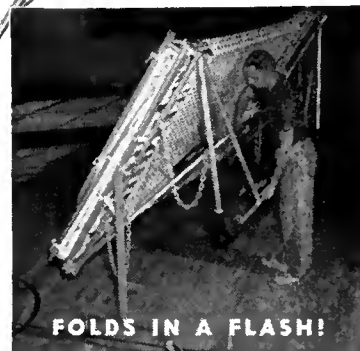

FOLDS IN A FLASH!



Readers! You are invited to send letters for this page to Editor, RECREATION, 8 West Eighth Street, New York 11—so that your ideas, opinions and attitudes may be exchanged with others on the wide range of subjects of concern to us all. Here is your chance to agree or disagree with the authors of our articles. Keep letters brief—not more than 250 words.

—The Editors.

For Recreation Students

Sirs:

I was quite interested in the suggestion by Robert E. Coady of the Cincinnati, Ohio, Public Recreation Commission staff, in the April 1956 issue of RECREATION, that colleges make more extensive use of professional leaders to help recreation majors prepare realistically for the field.

When Jay Ver Lee* was superintendent of recreation in Colorado Springs, he and his staff worked quite closely with the faculty at Colorado College in preparing those students who were interested in entering the profession, and they were able to bring to the classes experience and knowledge not found in textbooks. As a former student of Mr. Ver Lee, I can certainly endorse the value of such outside professional leaders.

* Mr. Ver Lee is currently superintendent of recreation in Oakland, California.

The Huntington Park Recreation Department would very definitely be interested in such an exchange program as suggested by Mr. Coady, and we should be most happy to make ourselves available for such an assignment.

RALPH C. WILSON, *Director of Recreation, Huntington Park, California.*

"Special Recreation" Staff

Sirs:

There is one suggestion I would like to make in the area of recreation for handicapped children. At present I am conducting a five-year demonstration recreation program to integrate hearing impaired children with normal hearing children in recreation and social activities.

It has become apparent after a year and a half that this type program, with modifications, should concern itself with all handicapped youngsters. At

this point, a problem confronts us. Handicapped youngsters should not have to be served by "demonstration" or "pilot" programs but should be served by permanent recreation programs that are provided for all children in the community. Whose responsibility, then, is it to provide year-round programs for these youngsters?

I sincerely believe that staff devoted to "special recreation" should be included in public departments of recreation throughout the country in order to provide permanent recreation service to as many handicapped youngsters as possible. This staff would devote full time to this program. I would be very much interested in knowing if there are any public recreation departments which would give support to this type program.

ROBERT H. DOMBRO, *Recreation Therapist, Baltimore Hearing Society, Baltimore, Maryland.*

750 Recreation Books

Sirs:

I have in my possession a copy of *A Guide to Books on Recreation* (RECREATION Part II, September 1956) which is an annotated list of over seven hundred and fifty books on this subject. This would be invaluable to me in my work; and if it is at all possible could you send me three copies? The material came to my attention through a recreation major at the University of Minnesota, who has been helping me set up a recreation program.

LEWIS C. LAWTON, JR., *Christian Education Director, Knox Presbyterian Church, Minneapolis, Minnesota.*

A "Short Snorter"

Sirs:

While at the Second International Congress in Philadelphia I had the pleasure of attending the session entitled "International Exchange Program for Recreation Leaders."

In response to a request by Tom Lantz, superintendent of public recreation in Tacoma, Washington, as to what road we should take in this field of international recreation exchange, some very fine comments were made by participants from the United States and foreign countries. Personally I feel very strongly about this entire project; however, there is a question in my mind regarding the best avenue of approach.

I have given the editor of your magazine a dollar bill to start what I hope will become the longest "short snorter" in the world—to be added to by as many people as possible in the United States and other countries all over the world. My idea is that the entire sum

SOMETHING NEW!

Classified Advertising

in

Recreation Magazine

Here's your chance to list, at small cost, information such as:

- Help Wanted
- Workshops and Conferences
- Positions Wanted
- Educational Opportunities
- Services Available
- Items for Exchange

For further information and rates write:

RECREATION MAGAZINE CLASSIFIED ADS
8 West Eighth Street, New York 11, N.Y.

from this "short snorter" be awarded to the person who can present to the NRA International Recreation Service, and the U.S. State Department, the best and most practical method or plan of achieving "Recreation through Peace-creation," or "Peace through Recreation," or "How We Can Promote Better International Understanding through Recreation."

The following are a few of the questions to be considered. Can it be achieved:

1. Through the visits to this country of foreign recreationists — on an annual basis?
2. Through a mutual exchange whereby recreationists of the United States visit foreign countries?
3. Through an international organization?
4. And what part should our government play in this and what should be its contribution?

If the "short snorter" does not materialize, please put my dollar into the general fund.

Vallejo, California, has contributed. Now how about YOU?

KEITH A. MACDONALD, *Executive Director, Greater Vallejo Recreation District, Vallejo, California.*

- The new International Recreation Association and NRA International

Recreation Service are both already taking steps to answer these questions of Keith's. What do you think of his suggestion of a "short snorter," and what do you think the money should be used for?—Ed.

The "Hi Fi's"

Sirs:

Wasn't the "Hi Fi" letter a fine one? [From a teen-ager's letter in Reporter's Notebook, October 1956 issue.—Ed.] It supports my long-time contention that these "Hi Fi" people (teen-agers) are about the finest we have. They have acquired the ability to reason and have not, yet, developed some of our adult bias and, yes, the unreasoning prejudices which we often acquire somewhere along the line. It is inspiring to see how often the "Hi Fi" can come up with the best and, even to adults, the most desirable reaction to an opportunity to produce.

I like "Hi Fi," and all of the implications it bears as to the actual, the real, situation. The letter causes me to wish even more that I might again try to be a real "Hi Fi" and, since I have little hope that such may be accomplished, to at least be counted as a vociferous fan in their cheering section.

RALPH J. ANDREWS, *Director, North Carolina Recreation Commission, Raleigh, North Carolina.*

"PLAY SAFE" — BE SURE IT'S A



FLEXI SWING SEAT
marked "FLEXI"

CHAMPION RECREATION EQUIPMENT, INC.
Standard and Custom Built Playground Equipment
Write for Literature
P. O. 474 Highland Park, Ill.

100% ALUMINUM TABLE TENNIS TABLE

FOR OUTDOOR AND INDOOR USE

Here at last is the Heavy-Duty Aluminum Table Tennis Table featuring Durability and Economy. Sturdily Constructed to Withstand Extreme Abuse from Play and Weather. Built to Last a Life-time.

- Regulation Bounce and Construction.
- Attractively Finished with Green Anodized Non-Glare Surface.
- In 2 sections—4 Legs Each Section. Easily Separated into 2 Tables.
- When Separated Has Many Uses.
- No Maintenance or Replacement Problems.
- Outlasts Wooden Tables by Many Years.
- A tremendous success in Colleges, Schools, Camps, etc.

ESPECIALLY DESIGNED & CONSTRUCTED

For Heavy-Duty Use In:

Outdoor and Indoor Recreation Centers, Playgrounds, Resorts, Clubs, Camps, Ocean-going Vessels, Etc.

For Full Details, Write:

All-Metal Tennis Table Co.
760 George St. — Teaneck, N. J.

IS CAMPING part of YOUR program ?

A.C.A. membership can be of value to you as it is to an increasing number of Recreation Departments incorporating Organized Camping in their programs.

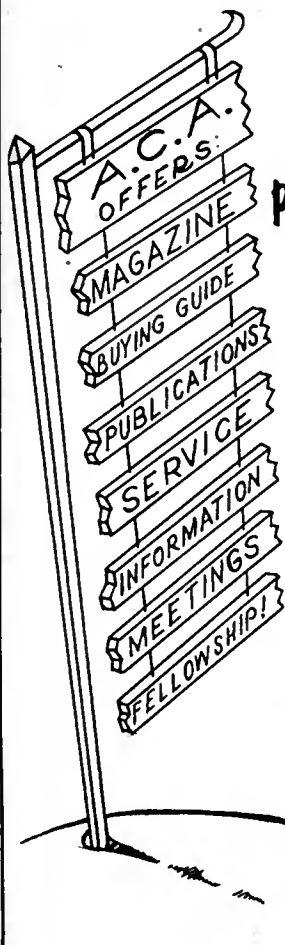

Write For Information
American Camping Association
Bradford Woods
Martinsville, Ind.

IDEA BOOK ENAMEL ON COPPER



64 PAGES

Learn jewelry making; latest enameling processes and techniques from step-by-step illustrated instructions. Book lists many new copper items, complete supplies, tools & equipment. Send for your copy of this valuable reference book today! It's FREE!!

THE COPPER SHOP
A Div. of Immerman & Sons • Dept. 142
1812 East 13th • Cleveland 14, Ohio

Jamison PLAYGROUND EQUIPMENT

Be sure to check the many exclusive features of this rugged line. Write for free catalog of 254 items.
Jamison Manufacturing Co. Since 1925
731 South Mettler Street
Los Angeles 3, California



Hogansville's Sportsmen's Club, once forbidden swampland, is now one of Georgia's top recreation areas, thanks to the interest and industry of its people, and local and state government.

They Built a Park

A STRANGE REQUEST came to the wardens of Okefenokee Swamp in southern Georgia a few years back. Could a few alligators be shipped alive to west central Georgia near the Alabama line?

It was all part of a plan eventually involving over three hundred "U.S." [United States Rubber Company] employees, their neighbors and their families—a plan that turned forbidding swampland into a beautiful park and bountiful game preserve. It happened in Hogansville, Georgia, home of the textile division's Stark, Reid and Asbeston plants.

Today the one hundred and twenty-acre area, including seventy-five acres of lakes with some of the state's best fish-



"U.S." employees, such as the above, tackled the forbidding terrain and details of the construction. Things moved quickly!

*Starting with a swamp,
a deserted brickyard,
and a bunch of alligators—
"U.S." people and their neighbors
took on a big job. . . .*

ing, goes under the more attractive name of the Tri-County Sportsmen's Club. Some of the original founders, however, still refer to it nostalgically as "the mudholes."

Tri-County's site formerly was a collection of clay pits in operation between 1879 and 1929. In 1949 a group of local wildlife enthusiasts were casting around for a game preserve. Old-timers remembered the clay pits, now covered by dense undergrowth and a veritable haven for wildlife including some not-so-welcome inhabitants such as water moccasins and copperheads.

Once decision was made that this was the spot, things moved quickly. The tract's owners agreed to sell for \$750. Funds for purchase were raised by the sixteen founders (who organized the Sportsmen's Club on October 1, 1949) from their own savings and by borrowing from the local bank, headed by one of the charter members. Within a year membership swelled to 240, reaching 350 at the end of the second year.

The members worked up a sweat regularly during the next five years as swamp disappeared and the park emerged. Working on Saturdays and holidays, armed with picks, axes, shovels and hushhooks, they cleared out years of tangled undergrowth, hacked pathways along the lake shores, installed drainage ditches, bridged streams and low-lying swampland, and laid out picnic and play areas.



The ladies are not to be left out! These, from St. James Methodist Church, are selling cakes. Whole families attended, helped to celebrate.



At the right, boys whose fathers are plant employees examine their catch which, fortunately, does not involve them with any pesky 'gators.



They opened the park in style with a real Georgia barbecue and an old-fashioned Brunswick stew served to jubilant builders.

During this time three dams and spillways were built to insure water levels in the fishing area. The district game commissioner, a club member, arranged with the director of state hatcheries to stock the lakes with five thousand bass to augment native catfish and bream. A county commissioner, another Tri-County member, arranged for building a connecting road from the highway to the tract.

All of this, of course, followed the snake hunt which, in turn, involved acquisition of the nine alligators.

Open warfare had been declared on copperheads and water moccasins and over four hundred were killed in two years. The request for 'gators went out in the second phase of this campaign because the amphibians were natural enemies of snakes. They quickly put the finishing touches on the reptile problem.

But they posed another problem. The 'gators, whose eyes shone like red-hot coals at night and whose silent stalking

was thought to account for some missing dogs, also frightened women and children and even gave menfolk creepy feelings when they were seen in the park's fishing area.

One by one, the alligators were captured and turned loose in the nearby Chattahoochee, where they could make their way back to warmer climes in south Georgia and Florida.

Physical improvements to add to the tract's recreational worth were next, once the land had been cleared and the area's natural beauties revealed. One member donated an unused peach shed which became, along with other salvaged materials, a big shelter complete with electricity and a double outdoor fireplace.

An unused former church building standing on U.S. Rubber property was contributed by the company and used for construction of a five-room caretaker's cottage. Donating valuable time and labor, plant employees also constructed a modern concrete and brick barbecue pit and outdoor grill. Enlarging the park and picnic grounds, the club purchased and erected strong, durable playground equipment—swings, slides, seesaws, a merry-go-round, and so on; and when dad purchased a boat with an outboard motor, there was additional fun for all the family.

In time even more improvements were added. Up-to-date outdoor fireplaces, brick and concrete picnic tables, benches and porch-type swings, concrete dance pavilion with house for music box, a concession building and toolshed, an electric pump for the well, shelters along the lake shores, and better toilet facilities.

Turning a forbidden and forgotten swamp into this thing of beauty was an effort in the highest order of community relations. Besides, the people of "U.S." say, it was fun. ●

Reprinted with permission from Us, the magazine of United States Rubber Company, July-August 1956.

The Launching of

The International Recreation Association



Thomas Rivers, IRA's director general, left, and his board chairman, Lord Luke.

THE LONG DREAMED of International Recreation Association is now a reality:

- After extensive conferences and correspondence with leaders of youth and other recreation agencies, government and non-government, in all parts of the world;
- And in response to a resolution from a group of nineteen foreign authorities responsible for recreation and youth services in thirteen countries, brought to America by the United States Department of State to study the recreation movement of America;
- And after formal request by the International Advisory Committee of the International Recreation Congress organized to aid in conducting this world gathering of recreation leaders;
- And after the approval of the National Advisory Committee on International Recreation Service, NRA, a group of forty-six professional recreation authorities representing the professional recreation movement in America;
- And with the active leadership and support of the National Recreation Association (U.S.A.), a national citizen agency which for fifty years has served the recreation forces of America;
- The International Recreation Association—incorporated under the laws of the State of New York—was established in Philadelphia, Pennsylvania, October 3, 1956.

by
**Thomas
E.
Rivers**
•
*Director
General*

The International Recreation Association has been organized to provide, on a cooperative basis, urgently needed international recreation services under an international board of directors, with the participation and cooperation of recreation agencies in other countries. Recreation services provided to other countries thus will no longer be solely the extension work of one country's recreation agency, but will come from this international voluntary clearing house, managed by an international board of directors and supported by many countries.

Lord Luke of Pavenham, internationally known industrialist and president of the National Playing Fields Association of England, was elected chairman of the Board of Directors, with the following as vice-presidents: G. D. Sondhi of India, Dr. h. c. Georg von Opel of Germany, General Carlos Romulo of the Philippines, Staff Major Kamal El-Din Hussein of Egypt, Yukio Kagayama of Japan.

A sixth vice-president is to be chosen from South America. Also the organization will begin its service with an extraordinary group serving on its board of directors, the organization of which is not yet complete. Those already selected are listed on next page.

International Recreation Association Objectives

The International Recreation Association's objectives are to:

- Serve as a central clearing house for the exchange of information and experience among recreation agencies of the world.
- Aid countries to establish central recreation service agencies upon request.
- Forward the development of a world recreation movement designed to enrich the human spirit through wholesome use of leisure.
- Encourage the provision of land and facilities, training of leaders, development of varied programs, and public interpretation of the values of play for children, recreation for youth, and creative use of leisure for all ages.
- Provide a medium through which the recreation authorities of the world may work in unity on one of the common problems of man.

Services

The new Association will:

- Maintain a central office to service the world's recreation agencies.
- Provide correspondence and consultation services on specific problems.
- Provide field service to countries desiring help with central recreation agencies.
- Provide field service on specific aspects of program.
- Encourage the exchange of recreation leaders among nations.
- Cooperate with the United Nations and its affiliated agencies.
- Publish a bulletin for recreation agencies to exchange information.
- Aid and encourage programs for training leadership for recreation.
- Arrange for international and regional conferences.
- Encourage the contribution of funds—public and private—to the development of recreation services for all mankind.

The International Recreation Association Board approved a budget of \$201,266 for the year 1957, to provide for a headquarters staff, field service to countries, world recreation service bulletin, and regional conferences. Services are to be provided in accord with the approved budget only if and when funds are secured.

The National Recreation Association has voted to make available the full time of the director general, some secretarial service, limited office space in the Carnegie Endowment International Center, 345 East 46th Street, New York City, and certain other technical services for a three-year period pending the securing of independent financing by the International Recreation Association. We earnestly solicit support from all sources in funds, cooperation, and services.

Grant Titsworth, a vice-president of the NRA Board of Directors, who presided at the IRA organization meeting at the Congress, closed the meeting by reading this statement from Otto T. Mallery:

"Here in this city of Philadelphia we proclaimed our freedom and independence over one hundred and fifty years ago. In that proclamation 'the pursuit of happiness' was singled out as one of the rights and goals of American citi-

BOARD OF DIRECTORS

ARKAN ABADI	IRAQ	PROF. MIRO MIHOVILOVIC	YUGOSLAVIA
<i>Former Minister of Social Welfare</i>		<i>Distinguished educator</i>	
DR. PANOYIOTIES BRATZIOTIES	GREECE	DR. DORIS W. PLEWES	CANADA
<i>President of the University of Athens</i>		(Temporary Liaison)	
MRS. HOWARD BRAUCHER	UNITED STATES	<i>Consultant on Recreation for Ministry of Welfare</i>	
<i>Wife and co-worker of the late president of the NRA, one of the organizers and leaders of the movement</i>			
RAYMOND CORTAT	FRANCE	JOSEPH PRENDERGAST	UNITED STATES
<i>Director General of Youth and Sports</i>		<i>Executive Director of NRA</i>	
DR. NORMAN COUSINS	UNITED STATES	LT. COL. FRANK RISQUEZ	VENEZUELA
<i>Editor of the Saturday Review</i>		<i>Director of National Sports Institute</i>	
DR. J. A. DEKONING	HOLLAND	T. E. RIVERS	UNITED STATES
<i>President of the Council on Cultural Contacts</i>		<i>Executive Secretary of NRA International Recreation Service</i>	
HOWARD HENDERSON	UNITED STATES	JULIO J. RODRIGUEZ	URUGUAY
<i>Vice-President of J. Walter Thompson Company</i>		<i>Leader of recreation for forty years</i>	
STAFF MAJOR KAMAL EL-DIN HUSSEIN	EGYPT	GENERAL CARLOS ROMULO	PHILIPPINES
<i>Minister of Education</i>		<i>World-known and respected statesman</i>	
YUKIO KAGAYAMA	JAPAN	DR. ABOLFAZL SADRY *	IRAN
<i>President of the Japan National Recreation Association</i>		<i>Leader of recreation and physical education</i>	
THABET NAZIF KHALIDI	JORDAN	SVEN SALEN	SWEDEN
<i>Deputy Representative to the United Nations</i>		<i>Industrialist and President of Outdoor Recreation Association of Sweden</i>	
DR. C. T. O. KING	LIBERIA	G. D. SONDDH	INDIA
<i>Ambassador and Permanent Representative to the United Nations</i>		<i>Leader in sports and recreation for thirty years</i>	
T. Y. LEE	CHINA	SIR PERCY SPENDER	AUSTRALIA
<i>Manager of New York Office of Bank of China</i>		<i>Ambassador to the United States</i>	
NORMAN LOURIE	ISRAEL	DR. ARMANDO URIBE	COLUMBIA
<i>President of National Playing Fields Association of Israel</i>		<i>Department of Social Action</i>	
LORD LUKE OF PAVENHAM	ENGLAND	DR. GIOVANNI VALENTE	ITALY
<i>President of National Playing Fields Association of England</i>		<i>President of ENAL (National Association for the Welfare of Workers)</i>	
OTTO T. MALLERY	UNITED STATES	MRS. WILLIAM L. VAN ALLEN	UNITED STATES
<i>Chairman of the NRA Board of Directors</i>		<i>Social and civic leader and member of NRA Board of Directors</i>	
MRS. WILLIAM L. MATHESON	UNITED STATES	H. S. VAN DER WALT	UNION OF SOUTH AFRICA
<i>Social and civic leader</i>		<i>Secretary for Recreation, Arts and Science</i>	
MRS. ETHEL BAUZER MEDEIROS	BRAZIL	W. J. A. VAN LANGENBERG	CEYLON
<i>Social and civic leader</i>		<i>Minister of Communications</i>	
		DR. H. C. GEORG VON OPEL	GERMANY
		<i>Industrialist and leader in recreation</i>	
		ROBERT WILDER	UNITED STATES
		<i>Executive Vice-President of National Forge and Ordnance Company</i>	

* Recently deceased.

zens.

"Today, in launching the International Recreation Association, we are proclaiming that right for all mankind. We worked and sacrificed for it in the United States. I believe, under this organization, leaders in the far corners of the earth will join together in unity for the same end."

No time in history has been more

propitious for such an agency as the recreation forces of the world have called for and which is now established.

In our hands is the responsibility of helping all men to face with confidence the leisure soon to be the portion of everyone. We pray for strength and unity and resources to meet the challenge that is ours at this time, one of the most exciting moments in history. ●

MR. RIVERS is director general of the International Recreation Association. For over thirty-eight years he has been one of the leaders in the national and international recreation movement as a member of the NRA staff. Since 1923 he has served as secretary of the National Recreation Congress.

In 1926 he helped to organize and launch the graduate division of the National Recreation School. From 1943 to 1956 he served as secretary of the National and Inter-American Music Week Committee. In 1952 he went around the world to hold recreation conferences with leaders in thirteen countries; in 1953 he became executive secretary of the International Recreation Service and visited twenty-two countries in Europe and the Middle East.

Newspapers and Recreation



W. H. Wallace



There are several mediums of communication in any community with which the recreation department needs a close rapport. These include radio, television and the newspaper. A close working relationship with each is necessary if a recreation department is to reach and serve its entire constituency; but, with none is this rapport more important than with the local newspaper.

The warp and woof of the average community, particularly in non-metropolitan areas, is continually affected by the editorial policy of the local newspaper. The minds, interests, and therefore the emotions, of a community can be dramatically influenced by continual contact with what is down "in black

W. H. WALLACE is director of the Hanford, California, Department of Recreation and Parks.

and white." For some inexplicable reason, people tend to believe, to a far greater degree, in what they read more than in what they hear. This being the case, it is obvious that we in the public recreation field must, at nearly any cost, secure good relations with the newspaper in our area.

The phrase "at nearly any cost" is not meant to imply that such cooperation is difficult to obtain. In most cases, the personnel of the paper is only too glad to work closely with the recreation staff. They are as concerned as we are about doing the best possible job. They seek news—the *who, where, when, why* and *what*—of events in their area. What is more important, they sincerely appreciate any assistance we can give them.

How can they best be approached? As in all human relations, sincere

friendly discussion is in order. Few individuals will rebuff a person genuinely interested in fulfilling his delegated task. The key word is *genuine*. This eliminates the hypocritical person who takes whatever he can get from the newspaper, with no effort to reciprocate in kind. When we show a desire to help them, they in turn will assist us.

Our recreation activities are *important* news. News for and about newspaper subscribers and the children of subscribers. News reporters know this well and seek to capitalize on it. If recreation people write their "stuff" in newspaper style, provide several appropriate pictures, and get material in on time, the editor will be grateful for the opportunity given him. This mutually advantageous relationship results in a better service to the customers of each agency.

The recreation department staff in Hanford, California, has a deep sense



of appreciation to the personnel of the local paper. We know a large portion of our success is the result of their assistance. The clippings shown here give evidence that newspapers are willing to promote the public recreation program.

To illustrate, here is an account of what one paper has done. The Hanford *Sentinel* is published six days a week, with an average of twelve to fourteen pages. The community, of some 11,000 people, is a county seat and the paper is the only daily in the county. This means that it cannot occupy itself solely with the life of one community, but must cover the county.

With this in mind, copies of the paper were checked to find out how much coverage the recreation department had received during one year. We found that, during 1955, there were 312 separate articles concerning recreation projects, programs, and activities. Eighty of these articles were on the front page, some under banner lines. Eight favorable editorials discussed, promoted, and complimented the local recreation program. There were seventy-six pictures of various events. The total coverage was 3,029 column inches in twelve months. At the prevailing local rate for display ads—\$1.05 per column inch—the local department had received \$3,180.45 worth of space during 1955 without charge. At no time during this period did anyone in the department strive to have a record-breaking year for publicity.

The newspaper cosponsored two recreation department projects during the year. One was solicitation of funds to build a \$3,500 addition to a newly purchased recreation center. As a direct result of this campaign, some \$1,800 in cash and materials were donated. The emphasis of the paper stimulated a wave of donated labor, resulting in the project being completed without recourse to tax money.

The second project was a six-week puzzle contest, originated by the recreation director. This contest, cosponsored by the newspaper and the recreation department, literally provided thousands of hours of citizen recreation for the community. The paper put up \$250 in cash prizes, plus the hundreds of column inches necessary to cover it. It was a tremendous success, and would have been utterly impossible without the wholehearted support of the press.

The puzzle, a combination of "Scrabble" and a crossword puzzle, was printed each week. The first puzzle had a simple diagram and each succeeding one had a more elaborate design with a higher possible score. We called the contest "Scriboscore" and used this word as the basis around which we arranged each diagram. Each letter had a point value and the object was to fill in the puzzle to obtain the highest possible score.

In each of the first five puzzles, the winner received \$15 for attaining the highest score, plus a bonus of fifty per

cent if his score topped that of the recreation director—providing he was a subscriber to the paper. The sixth and culminating prize was \$100, with the same possible bonus. (The recreation director was beaten five times.)

Obviously, the paper boosted its circulation with the contest; but, the horn of the recreation department was also loudly blown, and it received much good will from the project.

Throughout the year, the varied program of the department was supported by full coverage in the news columns. Special events were stimulated by pictures and editorial comment. The seasonal sports programs received exceptional support. The paper continually extended itself to arouse interest and urge attendance, thus assuring full use of the taxpayer's dollar.

The above is mentioned simply to illustrate the cooperation which newspapers are willing to give if properly approached. A hesitant, apologetic reluctance to seek the full cooperation of the newspaper is simply damming (spell it as you will) the channel of one's opportunities.

Recreation departments have something to offer the newspapers and they, in turn, certainly have much for us. One helps the other. Therefore, let us go all out to cement a relationship between the department and the newspaper which will bless the taxpayer, serve the citizen, stifle the critic, and further good will for all. ●



In Memoriam

Dr. Abolfazl Sadry

Dr. Abolfazl Sadry, a leader of recreation and physical education in Iran, died suddenly in Australia. He had been director of the Iranian Physical Education Department in the Ministry of Education and president of the Iranian National Olympic Committee.

Dr. Sadry had studied recreation in the United States in 1953 and upon his return home helped inaugurate a similar movement there. He attended the recent International Recreation Congress in Philadelphia and was elected to the Board of Directors of the new International Recreation Association.

IRA Director General Thomas E. Rivers said of Dr. Sadry, "His vision, friendliness and zeal for the development of youth through recreation will be missed not only in this country, but by the world recreation movement." ●

PROGRAM SECTION—This section of RECREATION now includes the type of material previously appearing in *Recreation Program Aids*. This change has been made because we wish to make our magazine ever more useful to recreation leaders at both the program and administrative level.

The Dug-Out

A Youth Center that Serves

The teen-agers of a small town, in serving others, find they are serving themselves.

Committee in charge of the annual youth rally show gifts, donated by famous persons, to be given away as door prizes.



BELIEVING that the best way to serve one's self is to serve others, the youth club in Algoma, Wisconsin, has consistently stressed this theme, and the young people have expressed as much, possibly even more, interest in "doing for others" as in planning and carrying out activities for their own entertainment.

The adult leaders and advisors of the club find that this principle is much more conducive to organizational long-life and the sustained interest of the young people themselves than the purely "youth center" idea. They believe that the best way to prevent an early demise is to have definite objectives, a job to do. They feel it necessary to pause for redefinition of this objective from time to time, but the goal is always to find a job and then do it.

Each activity is a project in itself, something which can be completed in a relatively short period of time. No one, young people especially, has any particular interest in or gets any particular pleasure out of long range projects. The

turnover in youth-group membership is high, making long-range projects impractical.

The Algoma Youth Club's long life is something of a record. It has been in operation without a break since February, 1944. Starting in a small unused city-owned room, it two years later graduated into larger rented quarters; and in the summer of 1955 the city council provided one of the largest and finest buildings in the state for this purpose. Now called The Dug-Out, it has a large youth center room, gymnasium-auditorium, arts and crafts and meeting areas totaling almost 16,000 square feet of floor space. The building is on the shore of Lake Michigan.

The club is sponsored by and functions under the supervision and guidance of the Algoma Department of Recreation, Parks and Playgrounds in a city of less than 4,000 population. Community interest and backing, so essential to any youth program, is evidenced by funds for remodeling and maintenance, and city residents have contributed all club furnishings from table games and billiard tables to bowling alleys, television set, public address system, a new, modern juke box and a sound movie projector.

EDGAR W. NELL is director of the Department of Recreation, Parks and Playground, in Algoma, Wisconsin.



Workshop at the rally demonstrates home manufacture of arrows. Program has something for everyone.

The over-all planning always calls for a balanced program to provide for a wide variety of individual interests; and the leadership is chosen by the members themselves. This is a selection which is respected and carries with it the necessary contagious enthusiasm.

The service theme was highlighted by the 1955 CARE fund-raising project which started with a goal of \$50.00 and resulted in more than twice that sum in the two weeks allotted for the work. It won the club the *World Week* citizenship award and *Parents Magazine* Youth Group Achievement Award.

The CARE project got under way with the appointment of a general committee, which was broken down into subcommittees to conduct the various phases of the campaign. The fund-raising projects included: a bake sale for which the young people themselves did a great deal of actual food preparation; a no-expense jukebox dance; a snow shoveling project wherein designated "gangs" voluntarily shoveled private walks, for a contribution to the club's CARE fund; a huge glass bowl in the center for the deposit of cash which would ordinarily have been spent at the snack bar; and a rag pick-up, with city residents requested to place containers of rags and old clothing at the curb.

Other service projects have included a Christmas dance at which admission was a canned or packaged food item. All the admissions were boxed and delivered to needy families in the area. The club also organized and sponsored a Christmas-Carol Parade in which almost all of the civic and church organizations of the city participated, with live floats depicting scenes from the various carols without any sort of prize or award other than personal satisfaction.

Another holiday project was an attempt to make sure, through personal visits to practically every home on a block-worker basis, that any and all newcomers and visitors were made part of the community and its life.

A "Courteous Driver" contest awarded prizes and certificates to courteous teen-age drivers and letters of censure to teen-agers who were observed violating rules of driving courtesy. Observations and judging were made by a "secret" committee appointed from the club membership. The state

motor vehicle department commended the project and the Algoma police department requested that it be repeated.

Other projects have included an Americanism essay contest, a "Why Vote?" essay contest, participation in March of Dimes, Heart Fund, ground observer corps—with over sixty members volunteering for regular assignment—a program of entertainment presented at the county home for needy, and Brotherhood Week. Sponsorship of a youth rally with the accent on wholesome leisure time activities and good citizenship has been an annual event. More fund-raising projects of the club include a public variety show which draws three capacity houses each year, sale of Christmas trees and decorations, an ice cream social, pancake supper and similar events.

The club center offers such participation activities as orchestra and record dances, billiards, table tennis, roller skating, basketball, archery, volleyball, indoor softball and others. Clubs within the club provide for specialized activities such as arts and crafts, music, drama and nature. There also are special excursion trips, luncheons and dinners, all types of athletic leagues, ice skating parties, swimming, golf, special holiday parties, cabaret dances, socials

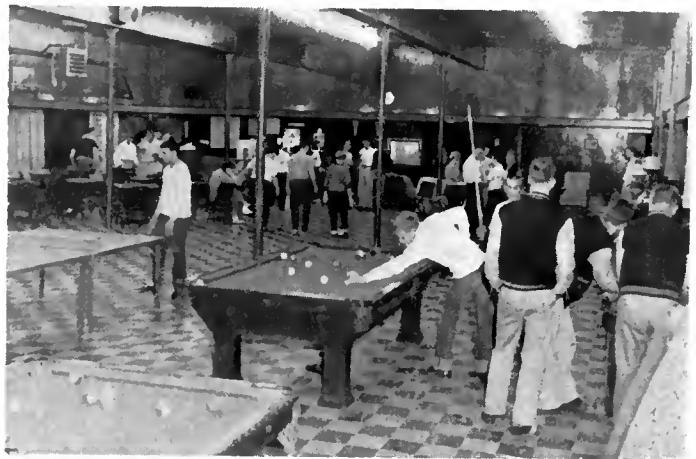

Interior of the youth center portion of The Dug-Out. A connecting room houses the gymnasium-auditorium.

and picnics, and a weekly hour-long radio program.

Even with all this, adult leaders feel that were it not for the interest in "doing unto others," the thirteen-year existence of the organization would have been in jeopardy many times. This service spirit was typified again when the club's youth council chose as its 1956 Christmas project the raising of the \$180.00 necessary for adoption of a needy youth through the Foster Parents' Plan for War Children.

Using past experience as a criterion, we're sure that the young members undoubtedly will meet the necessary quota and will make such adoption a personal matter, with an exchange of letters and personal gifts above and beyond their financial contribution. They know that this type of interest and activity assures many more benefits than purely self-centered interests. The good will so necessary for community support and backing and for sustained club life is put into practice, and the personal satisfaction of being useful, which all teen-agers crave, is the result.* ●

* See also "Help Raising' Teen-Agers," RECREATION, December 1956, page 488.

Musical Game

Leah M. Jaffa

MUSICAL GAMES used by leaders and counselors—at bunk parties or during rainy days at camp, in the center meeting rooms as clubs wait for meetings to begin, and in many informal settings—can be activities as ends in themselves. As such, they can help groups to get acquainted, provide emotional outlets, develop skills, strengthen interpersonal relations and the “we” feeling.

Some games can be even more than ends in themselves; they can serve as jumping off points for creative activities in the related arts: pantomime, dance, and dramatic improvisation.

By their very nature some games call upon simple elements of free expression: “Do the action the music suggests” (see Game III, Variation Two below); “Tap out the rhythm of a conversation” (Game II, Variation Two); “Make a sketch of a song title we’re to guess” (Game VI, Form Two). Any one of these can develop into fullblown creative activity, with firm purposes and direction.

Moreover, members having fun playing a game together are comfortable and relaxed. It is during these moments of freedom from tension that conditions are most favorable for emotional expression, for the use of imagination and inventiveness.

There is room for a great deal of flexibility in the way each game may be used so that, through the selection of the song, the word, or the action, it may be related to the interests of the group. The leader’s approval of the use of the phrase “rock and roll” for Game IV may be the touch needed to help one particular teen-age group relax. The selection of music for Games I, II, III, and IV, can meet a variety of tastes, can create a mood, can be suggestive of holidays and other experiences.

Games which are marked as being usable in small groups and by various ages (Games I, II, III, and V) are recommended for family programming. Adaptation of the games to various ages will increase the repertoire: a teen-age game which would be a loss to a children’s group, if played as described, becomes usable with simple adaptations. Some variations are outlined; others will suggest themselves.

Reprinted with permission from Jewish Center Program Aids, published by the Jewish Community Center Division of the National Jewish Welfare Board. MISS JAFFA is the board’s consultant on programming with the arts and is also executive secretary of the National Jewish Music Council.

Leaders and counselors are urged to encourage members and campers to suggest variations. When a group is familiar with a game, the leader’s question, “In what other ways can this be played?” will stimulate some to find new approaches and new uses, and can open the floodgates of imagination.

I. MUSICAL ICE-BREAKER. Size of group: 20 to 200. Age: Children through older adults.

The leader, knowing how many are to be present, decides upon the number of teams into which he will divide the group. If, for example, there are to be fifty people, he may want to work toward five teams of ten each. He then decides upon five familiar songs, and writes one title on each of ten pieces of paper, another on each of ten other slips, and so on.

Upon arriving, each person is given one piece of folded paper on which a title is written. At the signal, all begin walking about the room, each singing his own given song. Those singing the same song find each other, and credit is given for teams which get together first.

Variation One: Pantomime. Size of group: 20 to 200. Age: Children eight to twelve (all ages if people know each other).

Each person not only sings his given song, but also acts out one aspect of it, while looking around to see who else is pantomiming the same song.

Variation Two: Mixed group size 20 to 200. Age: Pre-teens through older adults.

To use this game as a way of setting up couples, enough songs are selected in advance so that each couple is given its own song title. Each person seeks someone singing the same song. Each song title should be written on only two cards of different colors, one color for girls, one for boys.

II. THE BEAT-THE-RHYTHM GAME. Size of group: 4 to 25. Age: Children of four through older adults.

The leader taps out the first phrase of a familiar song, giving the group a cue as to its general type: folksong, popular song, opera, and so on. The person who recognizes the song is asked to start it. Since the song is to be a familiar one, all he needs to do is sing the first note; everyone can pick it up. The leader encourages all to join in. They sing as much of the song as desired. The person who guesses the first song now has the next turn at tapping out or clapping the rhythm of another song which the group is to guess. If he cannot think of one immediately, the leader can say:

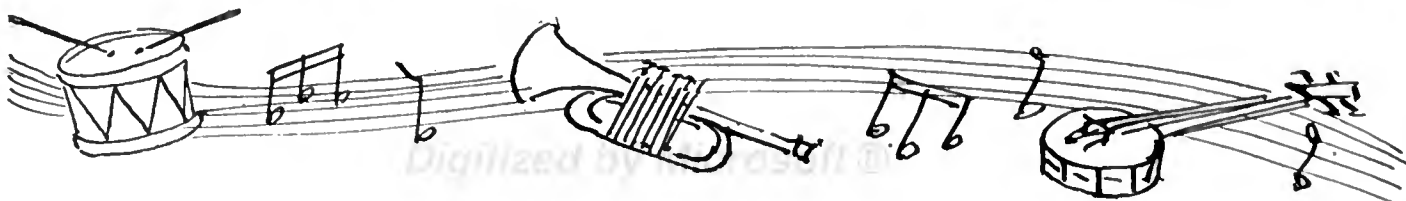

d Their Creative Use

For leaders and counselors of groups—in camps, schools, public or private recreation organizations, institutions, churches, industries, service clubs.

"While you're thinking of one, will someone else give us a rhythm?" This is suggested so that no one will ever feel the pressure of being "put on the spot."

With a group larger than six people, a patter such as: "This is a (type of song). Ready?" will help to focus attention so that the tapping will be clearly heard.

When used with children, it is suggested that the songs be very familiar ones, preferably those being currently sung by the group.

Variation One: Rhythms. Size of group: 6 to 12. Age: Children four to ten.

A rhythmic pattern can also suggest the name of a person. The leader might ask: "Whose name am I tapping (or clapping)?" If he claps *light, light, light, heavy*, it might be Sylvia Green. If he claps *heavy, light, heavy, light*, he might mean Henry Goldberg, and so forth. The group guesses. Then the leader asks for a volunteer to call out a series of names of people in the group. One at a time, as the child calls each name, someone else or all volunteer to clap its rhythm. Then, after a while, when this is clearly understood, felt, and enjoyed, the leader suggests trying to stay with one pattern and repeating it. For example, for John Silver: *heavy, hold, light, light; heavy, hold, light, light*. If the name is repeated again and again, while all do the clapping, a rhythmic movement suggests itself. If all then stand when there is open floor space, children will take turns improvising movements to the rhythm. They can play "follow-the-leader," or each might show and enjoy his own movement. This can be the beginning of the group creation of a dance.

Variation Two: Creative Music. Size of group: 6 to 12. Age: Children four to eleven.

A rhythm pattern might also suggest a phrase of words. The leader claps a sentence, asking what it suggests. *Heavy, light, light, light, heavy* might suggest to a child: "I don't want to go!" If the leader asks, "Why?" another child might answer by clapping and speaking: "I'm too tired."

The leader can here again begin to encourage a dramatic improvisation of a scene developing a situation. Why is the child tired? What has he been doing? What does he want? If the children can be encouraged to improvise a melody to the phrases, instead of just speaking them, we soon have an improvised opera—the clapping can be forgotten, and each actor is making up tunes to express the progress of the story.

Through this experience the group can learn that opera is a play with music helping to establish the mood; that music is another way of expressing feelings and ideas; that music talks.

III. HOT AND COLD. For Action. Size of group: 6 to 35. Age: Pre-teens through older adults.

With "It" out of the room, the players decide upon an action which they would like him to follow in connection with a selected second person in the room; for example, they want him to walk to Helen and take off her glasses.

When "It" is called in, the group begins to sing any song of its choosing. "It" begins to walk around the room. As he comes close to the person selected, and is therefore "hot," they sing loudly; as he passes or moves away, getting "cold," they sing softly. The loud music guides him to the right person. Once there, he must try different actions, until, with the help of the music (loud as he gets closer to the right action, and soft if he is missing it) he discovers the action the group wants him to do.

Variation One: Size of group: 6 to 35. Age: Young adults, adults, and older adults.

Group decides to try to get "It" to do something with another person, such as dancing or picking up an object and moving it elsewhere. (Caution: It is wise to make the rules of this variation clear before "It" leaves the room.)

Variation Two: Size of group: 10 to 35. Age: Children seven to ten.

"It" is told that when he comes in the group will want him to dance with a special person. He is to find the person through the "loud" and "soft" singing of the group.

Another possible direction might be: "When you find the partner we have selected for you, you are to skip (or march, or trot, or do the action the piano or record suggests) with this partner," or "Play follow the leader with the person you find," in which case the partner improvises rhythmic movement to music which "It" is to follow.

IV. THE THREE-SYLLABLE WORD GAME. Size of group: 15 to 50. Age: Children eight through older adults.

With "It" out of the room, the group selects a three-syllable word; for example, "pho-to-graph." The players are then divided into three sections, each to chant its own syllable to any tune; for example, "Yankee Doodle." Section A sings the first syllable only, fitting it to the tune; Section B the second; and Section C the third. All sing at



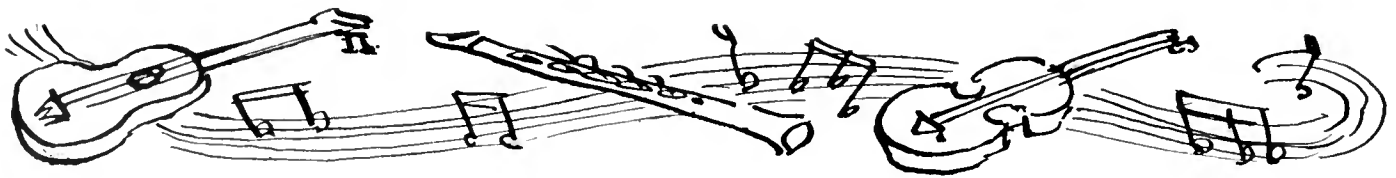

once, not loudly, using the same melody and following one leader. "It" is called in. He listens, watches the lips of the singers, and tries to recognize the word.

Variation One: Size of group: 15 to 50. Age: Pre-teens to adults.

As they become familiar with the game, players like to "scramble" syllables; for example, Section A chants the last syllable, Section B the first, Section C the middle one.

Variation Two: Size of group: 6 to 12. Age: Pre-teens and teen-agers.

In this variation, suggested and used by Sheila Fleischmann, the group decides upon a phrase giving a direction for something they want "It" to do upon his return to the room, using as many words as there are people in the group; for example, if there are ten in the group, the phrase might be, "Please go to the door, then turn out the light." Each person sitting in the circle chants his word to the tune selected, all singing at once, and not loudly. "It" tries to recognize the direction being sung and follow it.

Variation Three: With Pantomime. Size of group: 12 to 24. Age: Pre-teen through young adult.

In this variation, suggested and used by Aaron Krasner, the group is divided into several sections, each going to its own corner to select a slogan with as many words as there people in the group; for example, "A rolling stone gathers no moss." At a given signal, the members of Group One begin to chant, each his own word, but all singing the same melody together. Members of the other two groups watch, listen, and try to determine the slogan.

If they do not find the correct answer, the group does it again; this time each acts out his word as he chants. The effect is amusing, because each person is pantomiming something else, and if all are relaxed, it can be a lot of fun.

V. CATEGORIES. Size of group: 10 to 35. Age: Children eight through older adults.

The group is divided into teams. All are given five minutes to list song titles for each of several categories; for example, foods, seasons, Bible, weather, Sabbath.

Then, at the given signal, the leader asks one of the teams to sing a song in the first category. Before the song is finished, the leader calls on another team for a song in the same category, then another team, and so on.

The team called must respond at once, and no repeats are allowed. The leader decides the most appropriate time to go on to the next category.

This game can be used to motivate the learning of new songs in categories for which their repertoire is felt to be limited. With certain groups, the leader's remark: "If you were writing a song in the category of weather, what would you want to say?" might lead to writing an original song.

VI. WHAT'S MY TITLE? Size of group 8 to 50. Age: Children ten through older adults.

The object of the game is to suggest titles of familiar

songs through dramatics, art, or storytelling. The group tries to guess the titles. With alert leadership, the guessing is followed by singing.

Form One: With Charades.

If the group is small, a charade representing the song title can be planned by an individual or a team, on the spot. If the charades are used for mass activity, they are best planned and rehearsed by a committee, a club or a bunk, in advance of the program.

Form Two: With Sketches or Painting.

A group no larger than about twenty-five is divided into teams of no less than four each. Teams are in the corners of the room. One representative of each team goes to the center of the room, where all representatives, simultaneously, are given a song title by the leader. Each returns to his team and begins to sketch a picture of the meaning of the song as effectively and quickly as possible, without speaking to anyone. The team which guesses the song title first, and can sing the song, wins the most points.

If this game is used for a mass activity, a committee prepares paintings representing songs which are in the repertoire of the group, in advance of the program. The audience is to guess the song titles. The singing which accompanies the guessing always seems to have the flavor of spontaneity.

Form Three: With Creative Storytelling.

If the group is small, each person writes the name of a familiar song on a piece of paper and keeps it. The leader begins an improvised story which, after a minute or two, suggests the song on his paper, preferably one very familiar to the group. When the song is named correctly, everyone sings it. Group members then volunteer, when ready, to pick up on the story, each leading to an event or a statement which suggests the song on his paper. An alert group guesses the correct song and sings it.

If this game is to be used for a mass activity, a story suggesting a series of familiar songs is written in advance by an individual, a committee, a group. It is presented by the writer or writers; the audience guesses which song is being suggested by each episode and sings it.

VII. A HIT PARADE OF FAVORITE SONGS.

A hit parade of favorite songs can serve as the program for a mass activity of a group that has a common repertoire of songs (closing banquet at camp, and so on). A committee decides upon ten songs which are favorites and prepares a mimeographed "ballot," illustrated if possible. Each member marks the ballot according to favorites: he marks his top favorite, his second, and so on. All know that the results will be announced at the mass activity. As the program starts, only a small committee knows the outcome of the election. With due fanfare, the master of ceremonies announces "Song Hit Number Ten"; the group sings it; then number nine, and so on, until finally, after due suspense, the top favorite is reached. ●

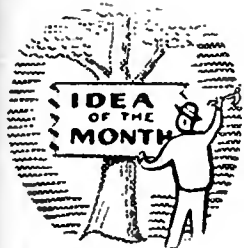

Programs on Exhibition

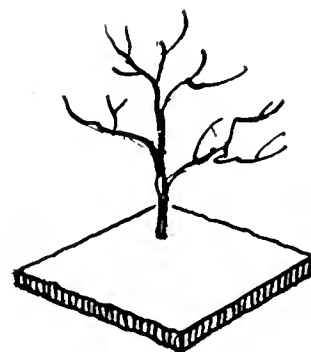

January is a good time to think of ways of publicizing recreation programs. A series of miniature exhibits, developed by Catherine Simpson of the recreation department of Oklahoma City, Oklahoma, dramatizes the recreation facilities, programs and holiday celebrations. Our write-up is based upon seeing colored slides and may not do them justice—but the idea is here for you to develop.

Such an exhibit of miniatures can go on tour, is perfect for a bank, library or store window; makes a vivid table decoration at a banquet; will liven up a board meeting. Here are a few ideas. Add your own—and get your craft groups busy!

EACH LITTLE exhibit or diorama requires a flat wood or plastic foam base, about twelve inches square, and a small, branched tree limb or twig. Arranging and decorating these is a very interesting project. Small accessories can be made or purchased from novelty shops or dime stores. A white card set in front of each exhibit contains pertinent information and identification.

For Holidays and Special Days

Easter. The small tree, anchored to the white tissue-paper covered base, is decorated with tiny Easter hats and cutout paper lanterns. A little nest, filled with colored gumdrop eggs, is placed at the base of the tree.

Halloween. The tree is anchored to a corner of the base, which is covered with straw. Small black paper cats decorate the tree, and several “tombstones,” cut from plastic foam, are scattered underneath. A black paper spook peers out from behind each tombstone.

Thanksgiving. The small tree, left bare, is attached to a corner of the base. Under the tree is a tiny table set with plates and silverware. A pipe-cleaner figure of a Pilgrim woman holds a turkey.

Christmas. A conventional evergreen Christmas tree is trimmed with tiny candy canes, miniature balls, glitter, and other baubles. Under it may be a crèche, Santa and reindeer, toys, or so on.

Valentine's Day. The tree is painted white and hung with tiny red hearts. The

base is covered with a gold or silver paper doily cut to fit. Two pipe-cleaner figures or dolls, one a boy and the other a girl, exchange hearts.

Other Program Activities

Snow Play. The base of plastic foam, or wood covered with plastic foam, has a tree in one corner decorated with bits of cotton to simulate snow. Small twigs of evergreen dot the base, interspersed with some pipe-cleaner figures on skis while smaller ones tumble in the “snow.”

Music. The base is covered with metallic paper. The tree, in the center, is painted gold and covered with angel hair. Under the tree is a miniature grand piano with a pipe-cleaner pianist.

Swimming. The base is covered with green matting or paper simulating grass. The tree, in one corner, is decorated with small flowers. Diagonally across from the tree is a small pan, painted blue inside and filled with water, to represent a pool. In the pool are several small dolls, celluloid or rubber, for swimmers and a tiny beachball.

Football. The base is covered with green matting or paper for turf. The tree, in a corner, is decorated with tiny pennants in college colors. On the other side of the base is a goalpost in two colors. Two teams of pipe-cleaner football players are in playing positions, with a miniature football between them.

Basketball. Similar to football, except

for a miniature basketball goal, on a pole, with groups of pipe-cleaner basketball players under it.

Art. The tree is decorated with small flowers and underneath it is a miniature easel and pipe-cleaner artist in smock and beret.

Folk Dancing. The tree is decorated with little lanterns and pipe-cleaner or doll figures in folk costumes dance beneath it.

Picnics. The tree is decorated with bits of colored yarn to simulate autumn foliage. Underneath is a miniature picnic table and bench, a tiny make-believe fire or outdoor fireplace. Pipe-cleaner figures are at the table and the fire.

Lantern Parade. The tree is decorated with small lanterns. A pan of water with a white edge around it simulates a lake. Small pipe-cleaner figures holding tiny paper lanterns are marching around it.

Nature. The tree covered with tiny blossoms is placed in the center. A small bird or butterfly sits on a twig. The base is covered with green matting or paper to indicate grass. Miniature animals—squirrels, rabbits, deer—are under the tree.

Drama. The tree is painted silver and the base is covered with glossy white paper. On it is a little platform, made from a small box, covered with black paper. Several pipe-cleaner figures are “on stage.”

Similar miniature dioramas can depict various playground activities, puppet shows, storytelling, boating and fishing, senior citizen activities, caroling, all your community's own special events (pageants, fairs, festivals, and so on). Other exhibits can show miniature models of community center buildings, band shells and other recreation structures. You can even have a miniature board meeting in action. ●

LACQUER BATIK

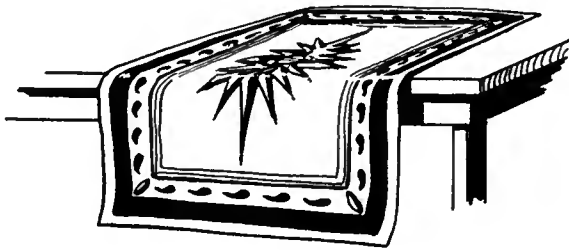

MATERIALS

Clear lacquer ~ dyes ~ cloth ~ carbon paper ~ thumbtacks.

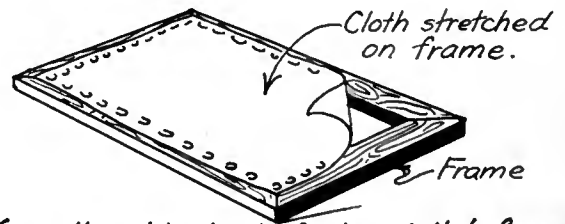

METHOD

1. Stretch cloth on wooden frame. (use thumbtacks to fasten cloth to frame).
2. Draw design on paper and then transfer it with carbon paper to the cloth.
3. Outline drawing with solid line of clear lacquer on both sides of the cloth.

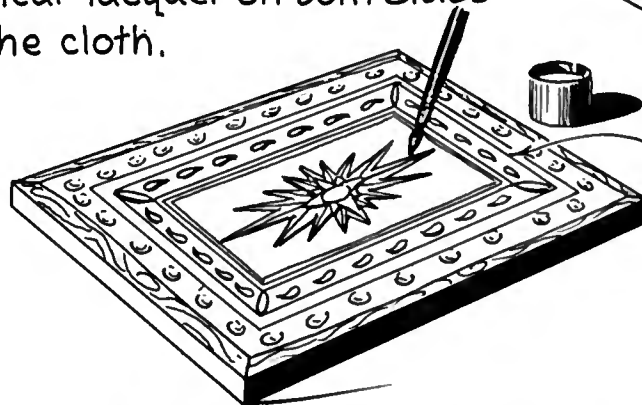
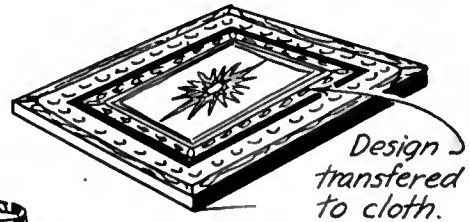

4. When lacquer is thoroughly dry paint design with dye colors.

Painting the design with dye colors.

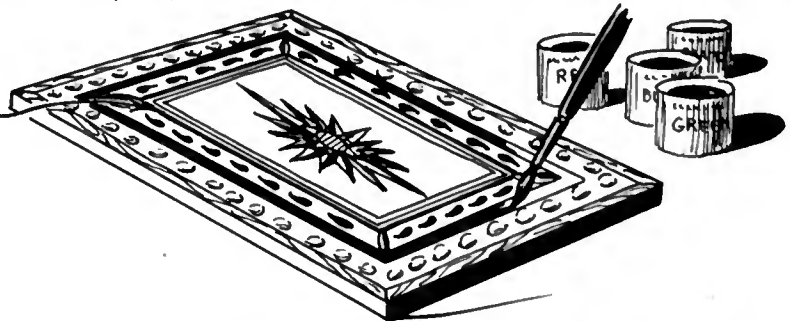

5. Remove cloth from stretcher and hem edges to complete batik.

ADMINISTRATION SECTION—This section of RECREATION appears monthly and is specifically addressed to recreation executives, although many other parts of the magazine should be of interest and of value to them.

Do you, as a recreation or park executive, think in terms of dollars or of human values?

Some Yardsticks- for Relating Participation to Costs*

H. C. Hutchins

ONE OF THE DIFFICULT tasks of the recreation profession is to shift the basis of fiscal thinking, both our own and that of the general public, from dollars to human values. If we are in business in order to bring about favorable changes in the lives of people, then our sights should be set on the ends to be achieved—the values derived from our services—rather than on the means to those ends as represented by dollars in the budget. The budget itself is a necessary tool of good administration—but nothing more than a tool.

Virtually everyone engages in some recreation with reasonable regularity. The only person who doesn't is a hermit, who is continually doing only what he chooses to do. Most people can do only some of the things they want to do for their recreation; and therein lies both the obligation and the opportunity of the recreation leader. It is his job to make it possible for people to enjoy the activities they desire. If this premise is sound, the leader cannot measure his success in terms of numbers reached, but by the effects of his services on individual human lives.

A woman I know has been confined for some years to a wheelchair by arthritis. Two years ago, in order to broaden her horizon a bit, her husband took her with him to a week-long recreation leadership institute. During that week, an artist on the staff aroused her interest in painting—with the result that her whole life has been affected by her newly discovered ability to capture some of the beauty around her. This illustrates the impact of recreation opportunity on an individual human life. Think of the human and social values to be gained from such guidance. They are clearly those of a qualitative nature.

Can such values be measured by a standard based on the proportion of total government operating cost devoted to parks and recreation? Can it be said that an executive is doing five-sixths of a maximally effective job if he is spend-

ing five dollars per capita for parks and recreation as compared with the desirable standard of six dollars per capita? Without doubt, the executive who is using up five per cent of his city's total operating budget and is spending close to six dollars per capita for parks and recreation services is likely to be achieving some of the human values illustrated. At the same time, it is quite possible for him to be spending all of these funds on a small portion of the people in his community. These two yardsticks—proportion of total operating costs of government and per capita costs for parks and recreation—are the commonly accepted standards; yet they are manifestly insufficient for measuring the impact of the services on the lives of people. Let's examine some other possibilities.

As our civilization becomes urbanized and our urban centers become more and more congested, people are losing contact with the soil. The good earth is the source of man's food, clothing, shelter, and even his spiritual sustenance; yet it is possible today for a person to live his whole life without direct personal contact with the natural environment. In the cities one can walk for blocks without even

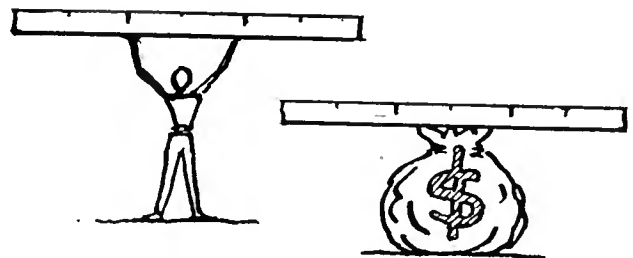

seeing the earth. In smaller towns, Mr. Citizen rides to his business, day after day, at speeds which effectually prevent any close examination or real understanding of those parts of the natural environment which he cannot help but see. Small wonder it is that he gains little appreciation of the importance of natural resources, such as soil and water and forests, except as these resources continue to make possible

DR. HUTCHINS is assistant professor of education and coordinator of the recreation curriculum at the University of Wisconsin.

* Presented at the Great Lakes District Conference, 1955, Grand Rapids, Michigan.

the production of things he needs. Small wonder it is that he protests feebly, if at all, when someone proposes taking a park, carefully preserved for the use of all, as a site for a school or a reservoir or an industry.

Do you suppose this same Mr. Citizen would let his home be taken arbitrarily just because someone else happened to want it? He wouldn't give it up without a fight. It has meaning for him: he understands its significance in terms of security for himself and his family. By the same token, should we not recognize it as part of our professional responsibility to attach meaning to the soil and the resources it provides for man? Do we not, as a profession, have an obligation to preserve the heritage which furnishes a major part of the human satisfactions we choose to call recreation? I think we do!

Let's look for a moment then at the means of translating these natural resource values into human values. Perhaps it offers us a standard of value not expressed in dollars. To what extent does your program afford opportunity for camping experience? Are you encouraging and working with school authorities to afford school camping for children? How about family camping, or camping for older adults, all proven feasible in the last decade? Do you provide garden plots where people can regain some sense of dependence on the soil? How often do you use nature materials such as rocks, lichens, vines, bark, or the colors and designs in nature as the basis for handcrafts? Here, it seems to me, is a significant yardstick for measuring effectiveness of a recreation program: Does it include experiences which foster understanding of man's dependence on the soil?

Another such yardstick might be the degree to which the individual is encouraged and aided to develop his own recreation. Just think for a moment of all the people who have not been attracted by our organized recreation activities or are not able to engage in group activities. Are not these people a part of our constituency and thereby a part of our professional responsibility? Here are the retired person, the shut-in, the handicapped youngster, the busy executive or housewife who need recreation outlets to give them the particular kind of satisfactions they happen to want. Beyond this, there is the generation growing up today which might be characterized as recreationally helpless or, at least, in danger of becoming so. Their chores are done largely by machines; many of the pastimes provided for them are in the form of television, movies, and spectator events.

The important question is: How much is the recreation profession doing to help people develop their own personal forms of recreation? Are you giving families any direct assistance in planning the vacations for which they now have time and money? Do you offer program planning aid to organizations which wish to put on their own play sessions? Do you encourage clubs and leagues you have helped establish to become independent, so they may have the experience of doing for themselves and so your professional leadership may be free to work with others? Are meeting places provided for hobby groups? Do you make available a workshop where the antique hound can refinish a spool bed or where the budding archer can make his own bow and

arrows? Do you regularly reach into the homes of the community by means of radio, television, newspapers and other publicity media with interest-arousing ideas and instructions to encourage people to develop their own personal recreation? Here, then, is still another yardstick of effectiveness for recreation services based on human values rather than costs.

The extent to which family solidarity is fostered by the services of the recreation department might be a further yardstick of effectiveness. The family is the basic biological, social and economic unit of our society; yet the forces which are tending to smash this social atom seem to become increasingly stronger. Daily work, school attendance, social or club engagements, movies draw family members away

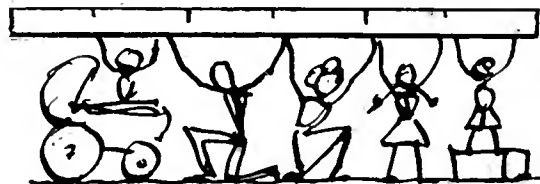

from home. Radio and television invade the home and distract attention from family concerns. If we, as members of a profession, hold the values of family life to be important, then we certainly should do something about it. Indeed, there are few professions in a position to make such an impact on family life as that of recreation.

What help in the way of family-group recreation is offered by your department: for devices and simple facilities to make a backyard a recreation place, for stay-at-home evenings, for family parties, games, projects, fun? Does your office or your public library have a supply of up-to-date references or books on these subjects? Are your neighborhood recreation centers designed and equipped for family recreation? Is your staff at these centers competent and interested enough to encourage family-group participation? What do you offer as inducement to family groups (such as family rates, for example) to encourage their attendance at spectator events? Do you offer enough variety of recreation opportunities at your centers so there is something for every member of the family at appropriate times, and thus foster a common interest in recreation within the family circle?

Here, then, are three possible yardsticks for appraising the effectiveness of recreation services in terms of human values rather than dollars. We might express them this way:

- Does your budget reflect opportunities which bring people in contact with the soil?
- Does your budget reflect services which encourage self-reliance in recreation matters?
- Does your budget reflect effort to foster family solidarity through recreation experiences?

Manifestly these yardsticks are not of such nature that they can be used to show degrees of effectiveness, at least in this form. Nor are they the only important qualitative factors in budget making that reflect human values. Nevertheless, they do suggest that members served and dollars spent are by no means the most important means of evaluating recreation services. ●

Recreation, park, and planning authorities have been looking forward eagerly to this publication. It is based on a study of California conditions conducted by a staff directed by Dr. Josephine D. Randall, formerly superintendent of recreation in San Francisco, under a representative committee, with the advice of consultants and an advisory council of California state and local authorities. The study was financed by the Rosenberg Foundation of San Francisco. The report is generously illustrated with photographs, sketches and diagrams.

The guide presents planning principles and the basis for determining space standards for recreation parks in urban population centers in the State of California. The wide variations in conditions found in different California municipalities and their effect upon recreation space and facility needs are emphasized. The State of California is divided into six regions with different characteristics, and specific recommendations are made for municipalities in each. Consideration is also given to the changing requirements of communities, based upon estimates of their future population.

A detailed and interesting forecast is made of the major factors which will influence planning for recreation in California during the next twenty years. Fourteen basic and widely applicable principles for recreation planning are proposed.

Definitions clarifying the terminology used in the report are given for several types of areas. However, the guide deals primarily with the neighborhood recreation center and the community recreation park, which generally are comparable to what are commonly called the neighborhood playground and the community playfield, respectively. Since these two terms have been nationally recognized and widely accepted as referring to standard types of recreation areas for many years, it

Planning for Recreation Parks in California

A Guide*

Reviewed by George Butler

would have been appropriate and useful to have given them some recognition in the report. One might also raise a question as to the desirability, in the guide, of applying the term "recreation park" to certain types of parks in view of the fact that the essential function of *all* parks is to provide recreation.

The outstanding feature of the guide is the list of the essential functional units to be provided in areas designed to serve neighborhood, community and city-wide recreation needs, their space requirements, and the recommended acreage for each type of area. The proposed space standards are far in excess of previous recommendations by national and local agencies, including the National Recreation Association. The report establishes goals which challenge recreation and planning agencies to lift their sights.

The desirability of cooperative planning by municipal and school authorities is emphasized throughout the guide. Separate space standards proposed for neighborhood and community areas when they adjoin schools or are separate sites vary widely, but the basis for these variations is not indicated. Had the report included the school site standards recommended by the California State Department of Education and described the features provided by school sites, the standards for the areas adjoining schools would have much greater significance.

Most standards for recreation space—or for school sites—are related to the population to be served because the

areas are provided for people, and presumably more space is needed as the number of persons to be served increases. The California report, however, makes no differentiation in the recreation space requirements of neighborhoods or communities of widely different populations and proposes no definite relationship between needed park acreage and a city's population.

Only two pages are devoted to a consideration of city-wide recreation areas and facilities. They contain recommendations for a service population of 100,000 only, but offer no suggestion as to how these space standards should be modified when applied to cities of different size. Among the city-wide features listed is an eighteen-hole golf course, which is the only type of area for which a ratio to population is proposed. It is doubtful, however, that many sections of the country will accept the recommendation that a city of 100,000 should provide a square mile developed exclusively for public golf.

Like any report which deviates from tradition and in which general principles are implemented by detailed specific proposals, the guide is certain to be challenged at various points.

In spite of its shortcomings, the guide merits careful study by all who are concerned with city planning and the development of recreation and park areas. Its analysis of conditions that have made leisure a factor of primary importance makes clear the need for additional recreation areas and facilities in the years ahead. Every community, in preparing plans for the extension or improvement of its recreation properties, can utilize to advantage the planning principles stated and interpreted here. The detailed listing of individual areas and facilities to be provided in the neighborhood, community and city-wide centers affords a useful checklist for localities planning such centers; and the diagrammatical layouts suggest a useful method of planning a recreation area in order to assure the effective use of space and satisfactory relationships between the various units.

Sincere appreciation is due the individuals and organizations that made possible preparation of the California planning guide. ●

* Published by the California Committee on Planning for Recreation, Park Areas and Facilities. State of California Recreation Commission, 721 Capitol Avenue, Sacramento 14. Pp. 78. \$2.00.

Latest Agency Information

Striking facts from *1956 Recreation and Park Yearbook**—an important feature of the National Recreation Association's Fiftieth Anniversary Year.

Federal Agencies

Federal properties set aside for recreation or available for limited recreation use far exceed in area those held by other non-federal government agencies. For example, the National Park Service administers 23,899,000 acres; the Fish and Wildlife Service, 17,472,000 acres; the Forest Service 180,000,000 acres; the Corps of Engineers, 5,600,000 acres; and the Bureau of Land Management, 470,000,000 acres.

Camping, picnicking, skiing, swimming, hiking, riding, mountain climbing, hunting, and fishing are popular forest activities; the same activities, except for fishing, are carried on in the national parks, as well as various interpretive programs. On the refuges, fishing, hunting, picnicking, swimming, boating, photography, and wildlife observation attract the largest number of visitors; public lands are used primarily for hunting, fishing, camping. Reservoir areas of the Corps of Engineers, Reclamation Bureau and Tennessee Valley Authority afford opportunity for picnicking, camping, swimming, boating and nature activities.

Visitors to the federal areas in 1955 included more than 50,000,000 at the areas under the National Park Service, nearly 7,250,000 at the wildlife refuges and fish hatcheries, more than 9,500,000 at the reclamation reservoir areas, nearly 46,000,000 at the forests, 62,000,000 at the Corps of Engineers projects, and more than 36,000,000 at the Tennessee Valley Authority reservoirs, dams, and steam plants.

State Agencies

Properties owned by the states and used for recreation are of many types: parks, roadsides and waysides, historic sites, monuments and memorials, res-

ervations, fish and game preserves, forests, reservoirs, and recreation areas such as beaches and camps. Roadsides and waysides, numbering over 4,000, are most numerous, but parks are most widely distributed among the states. Nearly 500,000 acres were acquired for fish and game preserves, refuges and sanctuaries in the five-year period ending in 1955.

Attendance or visits during 1955 at less than one-half of the areas reporting exceeded 232,000,000, of which three fourths were at the state parks. The activities most frequently reported are picnicking, fishing, camping, swimming, boating, and hiking.

Many state agencies control or operate no properties but provide a variety of recreation services; for example, in twenty-six states the agricultural extension services conduct short courses for training recreation leaders. In nineteen states the education department and in thirty-two states the state college or university provide recreation consultation service to localities. In forty states the health department regulates public swimming pools and bathing beaches. Library agencies in thirty-four states operate traveling libraries. Planning departments conduct local surveys of areas and facilities in seven states.

City and County Agencies

Of the 2,939 local, county and district agencies providing parks or community recreation service in 1955, 923 are separate recreation authorities; 920 administer recreation in conjunction with parks, whereas school authorities number 343. Of the 913 authorities employing one or more persons for recreation leadership on a full-time, year-round basis, 531 or 58 per cent are separate recreation departments, 282 are park departments and 45 are school authorities.

Parks and other dedicated recreation

areas, not including school sites, reported by 1,907 cities and counties number 20,417 and comprise a total of 748,701 acres. Of this amount 78,820 acres or a little more than one-tenth of the total were acquired during the five-year period ending in 1955. Nearly 50,000 acres in school sites were also reported usable for recreation and more than 23,000 were actually used for community recreation in 1955.

Diversified programs under leadership were conducted at 18,224 outdoor playgrounds in 1,956 cities; nearly two-thirds had leadership during the summer only; more than 5,000 through the year. A total of over 13,000,000 individuals were registered at the playgrounds in 708 cities; total 1955 attendance in 1,478 cities exceeded 420,000,000.

Paid workers in all recreation and park positions total 142,928; of this number 76,878 were employed for recreation leadership. Workers in maintenance, operation and other non-leadership positions, employed on a full-time, year-round basis, outnumber the recreation leaders serving on this basis by more than four to one. Of 45,396 such workers, only 8,387 give full time the year-round to recreation leadership. Six out of seven park administrative and professional workers other than recreation leaders were employed on a full-time, year-round basis in 1955.

Total 1955 expenditures for recreation and parks in 2,381 cities and counties exceeded \$380,000,000. Of this amount nearly \$93,000,000 was spent for land, buildings and improvements; \$62,000,000 for recreation leadership salaries and wages. Bond issues for recreation and parks voted during 1951-55 inclusive totaled \$158,755,384.

Other *Yearbook* figures relate to activities, buildings and indoor centers, indoor and outdoor recreation facilities, volunteers, sources of funds, park department organization in large cities, lighted facilities, and attendance, among others. For each local agency reporting, columns are provided for recording forty items; the *Yearbook* therefore affords a basis for comparing the situation in the various cities as well as presenting a picture of park and recreation developments throughout the nation. ●

* Just published. Available from the National Recreation Association. \$2.00.



On the Campus

A. B. Jensen

Students Conduct Workshop

Springfield College students conducted a two-day workshop on leadership and problem-solving in November. Min A. Baillie reports in the college's publication, the *RYL News*.

The workshop was organized and led by students in a recreation and youth leadership course in group relations as a field work assignment. It was carried through without faculty instruction. A large number of recreation majors attended. Also present were physical education and teacher education majors.

The workshop concerned itself with club and organization problems in the areas of motivation, leadership, communication and responsibility. "One of the most significant values of the workshop is the inter-club relations taking place," says Miss Baillie. "It was possible for the first time for officers of various student organizations to exchange views, realize similarities in their problems and attempt to work toward a common goal—improvement."

The workshop used a number of small-group discussion techniques, including feed-back, role playing, and film lead-offs.

A report including evaluations will be compiled and distributed to club officers to complete the workshop's activity.

MRA Scholarships

The Michigan Recreation Association has awarded Henry Schubert Scholarships to three students majoring in recreation at Michigan colleges. The students are: Barbara Bestervelt and Richard Reichel, both at Michigan State University, and James Beers at Eastern Michigan State College. All plan to enter the field of community recreation after graduation.

Great Lakes Park Institute

The eleventh annual Great Lakes Park Institute will be held at Pokagon State Park in Indiana February 25-March 1. The institute is conducted by the Indiana University Department of Recreation in cooperation with sev-

eral other organizations. One of the topics for 1957 will be "Leadership Techniques." Another will be "Techniques for Getting the Best Contributions from the Staff."

Recreation majors traditionally aid with the operation of the institute, providing staff services to the professional workers attending.

Graduate Stipends Raised

Graduate recreation assistants will receive increased stipends at the University of Illinois, according to Professor Charles Brightbill. Half-time assistants will receive \$2,100 instead of the present \$1,800. Quarter-time graduate aids will receive \$850, an increase of \$100. In addition, both are exempt from payment of tuition and other basic fees.

College Education Pays Off

Education Summary quotes Rudolph Neuberger, president of The Tuition Plan, as saying that a college education is "clearly the best investment parents can make." Mr. Neuberger points out that the college education pays off financially with an average in earnings of about \$100,000 more than those of a high school graduate.

In its October 1956 report the publication revealed that 390,000 college students—one out of six undergraduates and one out of five graduate students received federal aid in 1954. This aid, according to National Science Foundation figures, averaged more than \$1,000 per student.

Dr. Welborn Appointed

Dr. Gene Welborn has been appointed associate professor of recreation and physical education at Ithaca College. He is responsible for instruction in professional courses including philosophy of recreation, organization and administration, methods and materials, and juvenile delinquency. He also is faculty advisor for the recreation majors' club and the corecreation program.

Dr. Welborn, a University of Illinois graduate, did his master's work at Indiana University and his doctoral work at New York University.

New Personnel Publications

Recreation majors will want to read carefully *Personnel Standards in Community Recreation Leadership*, published recently by the National Recreation Association.

This report, by the Committee on Placement of the NRA National Advisory Committee on the Recruitment, Training and Placement of Recreation Personnel, is the latest in a series extending back to 1931. It cites latest recommended standards for education and experience for recreation leadership positions. It also suggests minimum starting salaries, and lists the duties and responsibilities for a wide variety of positions in community recreation.

A basic guide to the career field, *Personnel Standards in Community Recreation Leadership* belongs in the personal library of every student who plans to work in recreation. It is a guide to the skill and knowledge needed for all types of jobs, and should be helpful especially to those faced with the problem of choosing worthwhile electives or minors.

Also new is a career monograph, prepared for the Bellman Publishing Company by W. C. Sutherland, director of the NRA Recreation Personnel Service. Titled *Recreation Leadership*, it is a comprehensive summary of the field and its importance, professional education, positions and career opportunities, organizations employing recreation leadership, and related material.

Mr. Sutherland, a graduate of Drake University and of the National Recreation School, writes from the viewpoint of an experienced national consultant who has, in twenty-thousand interviews and innumerable other contacts, learned the needs and desires of employers, candidates, students, and colleges. His balanced presentation has special value for the recreation major and his advisors for this reason.

Both publications are available from the Recreation Book Center, 8 West Eighth Street, New York 11. *Personnel Standards* (RBC #415A) is \$2.00 per copy. *Recreation Leadership* (Monograph RBC #422A) is \$1.00 per copy.

MR. JENSEN is special assistant to the executive director, NRA.

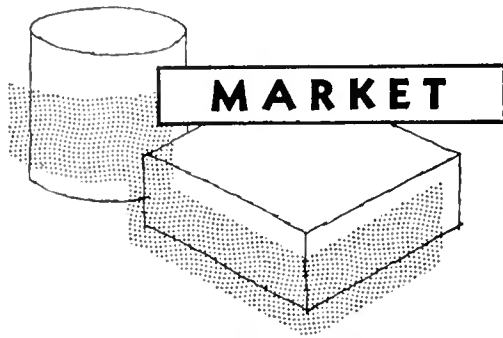

NEWS

If you are interested in any of these products, write directly to the manufacturer at the address given. PLEASE mention that you read about it on RECREATION magazine's Market News page.

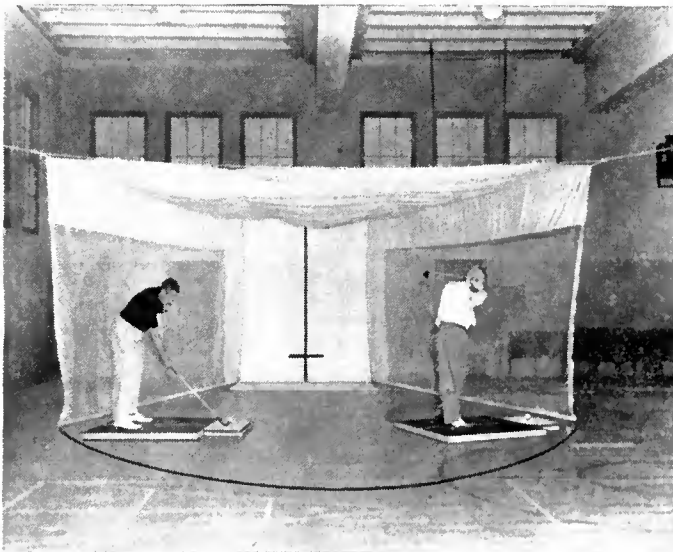

◆ The Pak-A-Way Golf Driving Range—a complete package golf driving range for use indoors—can be set up for use or folded against a wall by one person in less than two minutes. Easy to install, it may be attached to concrete, brick, block or frame wall of any size gymnasium or other room. Designed for both right- and left-handed players, it includes net, backstop and driving platforms with built-in rubber tees and brush mat. Two persons can use the range at a time. The ball cannot be driven out of the driving range, cannot rebound or ricochet back against the player. When not in use, the assembly may be rolled up and fastened to top bar, lifting the entire unit completely out of reach, leaving the floor area free for other purposes. Berlin Chapman Company, Berlin, Wisconsin.



◆ The "Wonder Roof" is the first in a new line of low-cost long-span roof decks, custom engineered by Wonder Building Corporation of America, for school gymnasiums, convention halls, arenas, and similar buildings. "Wonder

Roof" was chosen for the Phoenix, Arizona, Coliseum because of its low cost, speed of erection, and the unobstructed view it will allow of the area proper. Complete roof deck (shown here) is a clear span, 120 feet wide and 260 feet long, covering the building's center section. Erected in seven and a half days, it consists of curved eighteen-gauge galvanized corrugated steel sheets, two feet wide and from six to ten feet long, fastened by nuts and bolts to form self-supporting arches in patented trussless design. Wonder Building Corporation of America, 30 North LaSalle, Chicago, Illinois.

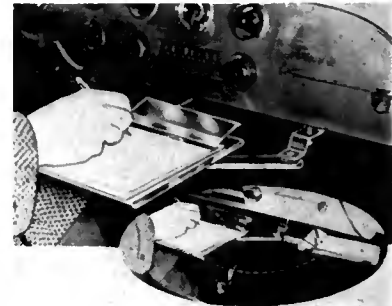

◆ Travel-Desk permits writing in comfort right in the car. A handy pad, held secure by the heavy spring clip at the top of the desk (it also holds maps, papers or records) right alongside the driver, provides a

convenient way to make notes. Easily installed in a matter of minutes without drilling, it swings under the dash, out of the way when not in use. Travel-Desk is always level (four leveling screws do the job), whatever the dashboard angle, and is always rigid. General Industrial Company, 5742 North Elston Avenue, Chicago 30.

◆ The New Clearview Nameplate Press is a compact, carefully designed marking machine for stamping individual letters and numbers on all types of identification plates and tags. This new machine can also be used for scores of other identification purposes, marking keys, toolroom tags, bathhouse tags, nameplate badges for personnel, storage-bin tags, inventory tags and many other items. A complete catalog is available from Clearview Company, 172 Stanton Street, New York 2.

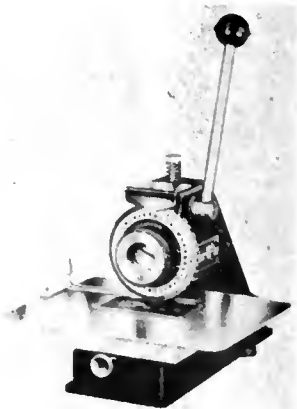

National Sports and Vacation Show

The biggest variety of sports and recreation exhibits ever staged under one roof in New York City will be shown at the 1957 National Sports and Vacation Show in the New York Coliseum, February 15-24. In addition to hundreds of fishing tackle, camping, wildlife, archery, hunting, boating, travel and vacation exhibits, there will be new and expanded how-to clinics.

Hospital Capsules

Beatrice H. Hill

Final plans for the study of recreation in hospitals—being made by the National Recreation Association in conjunction with the Council for the Advancement of Hospital Recreation—were discussed at a meeting in Philadelphia in October.

Present were: Dr. Martin Meyer, Division of Mental Health, Indianapolis; Dr. John Silson, medical research expert, New York City; Madolin E. Cannon and Lillian Summers, American National Red Cross, Washington, D.C.; William Lawler, National Association of Recreation Therapists; R. C. Boyd, American Association of Health, Physical Education and Recreation; Dr. Gerald Fitzgerald, University of Minnesota; Dr. Edith Ball, New York University; Russell Dean, Office of Vocational Rehabilitation, Department of Health, Education and Welfare, Washington, D.C., Alfred Jensen and Beatrice H. Hill, National Recreation Association, New York City; Dr. Harold Meyer, University of North Carolina; Percy Clapp, Veterans Administration, Washington, D.C.; Dr. John Hineman, American Medical Association, Chicago; Dr. Maximilian Menkes, American Psychiatric Association, Washington, D.C.

At the meeting it was brought out

MRS. HILL is the NRA consultant on hospital recreation.

that the American Psychiatric Association, American Hospital Association, and the American Medical Association Council on Professional Practices are interested in the study and will cooperate.

It was decided to conduct the study somewhat differently than previously planned:

1. A very brief questionnaire to go to every administrator of every hospital in this country to establish exactly where hospital recreation exists.

2. Upon return of these, to pick two hundred of what appear to be the most extensive programs and to send out a detailed questionnaire to the administrators at these hospitals. This questionnaire to be designed to evaluate the place of recreation in a hospital setting. A summary of this part of the study is to be sent to the American Medical Association and American Hospital Association for their advice on criteria.

3. To send a detailed questionnaire to every recreation professional working in hospitals to determine education and experience backgrounds, job responsibilities and any other facts which will help decide who is responsible for hospital recreation today and what is being done.

4. To send a questionnaire to colleges giving graduate and undergraduate curricula in hospital recreation concerning curricula subject matter. ●

PERSONNEL NOTES

● The National Recreation Association was one of the cooperating agencies participating in the National Conference on Professional Preparation of Recreation Personnel, held in Washington, D.C., in November. Other organizations included the American Camping Association, American Recreation Society, College Recreation Association, National Association of Social Workers, National Industrial Association, Society of State Directors of Health, Physical Education and Recreation, and The Athletic Institute. The conference was sponsored by the American Association of Health, Physical Education and Recreation and dealt with recreation curriculum at the un-

dergraduate and graduate level. Approximately eighty-five delegates, including W. C. Sutherland of NRA, attended representing schools and cooperating agencies.

● Another appointment has been made to the NRA National Internship Program. Charles Hofer, Jr., started December 3 in Oakland, California, where he will intern under the close supervision of Jay Ver Lee, superintendent of the local department. Mr. Hofer received an AA degree from Kemper Military School, Boonville, Mississippi, and his bachelor's degree in recreation at the University of Illinois. While still in training he received experience in the recreation departments at Urbana and Decatur, Illinois. ●

monroe

FOLDING BANQUET TABLES



If you are on the Board of your Church, Lodge, Club, School, etc., you will be interested in this modern Folding Banquet Table.

AND MONROE TRUCKS



Completely finished tops, resistant to most serving hazards. Used with or without table cloths.

Write for Table and Truck Catalog and special price discounts to institutions and organizations.

Monroe Co., 181 Church St., Colfax, Ia.

Italian Mosaic Tile Set . . \$4.95

Create your own decorations with this marvelous, new easy-do ceramic tile kit. Contains ready cut frame (for hot-plate or wall plaque) Handsome Italian ceramic tiles, special mosaic tile cement, grout, & simple-to-follow instructions.

DEXTRA Crafts & Toys, Inc., Dept R4
1246 Commonwealth Ave., Boston 34, Mass.

Wear Your Golden Age Club Pin With Pride Wherever You May Go



EXACT SIZE

Designed by representatives of over 100 Golden Age clubs and used nationally. Gold colored metal with evergreen tree in jewelers' enamel. Symbolic of long life, strength and perseverance. The words LOVE, PLAY, LEARN, SERVE (greatest values of club membership) enameled in black. The border is a laurel wreath for honor. Safety catch.

Available Only to Authentic Clubs.

50¢ each, minimum order 10 pins.

James Spencer & Co. 22 N. 6th Street
Philadelphia 6, Pa.

NATIONAL BASES



● PRECISION BUILT ● QUALITY GUARANTEED

Nationally Preferred

Write for our new Base Catalog.

NATIONAL
Sports Company
370 N. MARQUETTE STREET
Fond du Lac, Wisconsin

Books & Pamphlets Received

- CANDLE BOOK, THE, Carli Laklan. M. Barrows and Company, 425 Fourth Avenue, New York 16. Pp. 190. \$3.50.
- CHORAL READINGS FOR FUN AND RECREATION, Helen A. Brown and Harry J. Heltman, Editors. The Westminster Press, Witherspoon Building, Philadelphia 7. Pp. 63. Paper \$1.00 (five or more copies \$.90).
- CONCRETE AND MASONRY, Emanuele Stieri. Barnes & Noble, 105 Fifth Avenue, New York 3. Pp. 277. Paper \$1.75.
- FAMOUS DANCERS, Jane Muir. Dodd, Mead & Company, 432 Fourth Avenue, New York 16. Pp. 159. \$3.00.
- 50 MUSICAL MIXERS (Revised Edition). Square Your Sets, 3302 Fifteenth Street A, Moline, Illinois. Pp. 40. Paper \$1.00.
- FOUR DECADES OF ACTION FOR CHILDREN—A Short History of the Children's Bureau, Dorothy E. Bradbury. Superintendent of Documents, U.S. Government Printing Office, Washington 25, D.C. Pp. 90. \$.35.
- HISTORY OF FIREARMS, A, W. Y. Carman. St. Martin's Press, 103 Park Avenue, New York 17. Pp. 207. \$3.00.
- HOCKEY: OFFICIAL GUIDE & RULE BOOK 1956. Amateur Hockey Association of the U.S., 2309 Broadwalk, Atlantic City, New Jersey. Pp. 120. \$.50.
- HOME HEALTH EMERGENCIES. Equitable Bureau of Public Health, 393 Seventh Avenue, New York 1. Pp. 256. Free.
- HOW TO BE A BETTER MEMBER, Horace Coon. New American Library of World Literature, 501 Madison Avenue, New York 22. Pp. 128. \$.35.
- HOW TO IMPROVE YOUR TRACK & FIELD. The Athletic Institute, 209 South State Street, Chicago 4. Pp. 64. \$.50.
- HOW TO PLAN AND CONDUCT WORKSHOPS AND CONFERENCES, Richard Beckhard. Association Press, 291 Broadway, New York 7. Pp. 60. \$1.00.
- HOW TO USE AUDIO-VISUAL MATERIALS, John W. Bachman. Association Press, 291 Broadway, New York 7. Pp. 60. \$1.00.
- KNOW THE GAME SERIES: BADMINTON, pp. 39; NETBALL, pp. 40; RUGBY UNION FOOTBALL, pp. 43; SQUASH RACKETS, pp. 32. Sport Shelf,

10 Overlook Terrace, New York 33. Paper \$.75 each.

LOOK FORWARD TO YOUR RETIREMENT. U. S. Chamber of Commerce, 1615 H Street, N.W., Washington 6, D. C. Unpagged. Single copies free (in quantities, \$.05).

PROFESSIONAL STANDARDS FOR PERSONNEL WORK (Pamphlet #13). Society for Personnel Administration, 5506 Connecticut Avenue, N.W., Washington 15, D. C. Pp. 32. \$.50.

PROGRAM PLANNING FOR BUS TRIPS, Bernard Warach and Rowena Shoemaker. Play Schools Association, 41 West 57th Street, New York 19. Pp. 32. \$.60.

READING. Association for Childhood Education International, 1200 Fifteenth Street, N.W., Washington 5, D. C. Pp. 32. Paper \$.75.

RIDING HIGH—The Story of The Bicycle, Arthur Judson Palmer. E. P. Dutton & Company, 300 Fourth Avenue, New York 10. Pp. 191. \$5.95.

SUCCESS AT SOCCER, Frank Butler, Editor. Sport Shelf, 10 Overlook Terrace, New York 33. Pp. 127. \$3.00.

TALL ONE, THE—A Basketball Story, Gene Olson. Dodd, Mead & Company, 432 Fourth Avenue, New York 16. Pp. 211. \$2.75.

TRIPS FOR CHILDREN (Guide to places of interest in New York City). Play Schools Association, 41 West 57th Street, New York 19. Pp. 11. \$.25.

TRUE-TO-LIFE SERIES: AL ALLIGATOR, pp. 48; BILLY BASS, pp. 47; BOBBY BLUEGILL, pp. 47; CHARLEY COTTONTAIL, pp. 50; FREDDY FOX SQUIRREL, pp. 49; MAC MALLARD, pp. 50; TOMMY TROUT, pp. 48; BOB WHITE, pp. 50; WILLIE WHITETAIL, pp. 49; WOODY WOODCOCK, pp. 50. All by R. W. Eschmeyer. Fisherman Press, Oxford, Ohio. Paper \$.50 each; cloth \$1.00 each.

YOUR CHILDREN'S BUREAU. Superintendent of Documents, U. S. Government Printing Office, Washington 25, D. C. Pp. 43. \$.20.

Periodicals

AMERICAN HERITAGE. American Heritage Publishing Company, 551 Fifth Avenue, New York 17. Published bi-monthly. \$2.95 per copy; \$12.00 annually (hard cover).

COMMUNITY EDUCATION. Bureau of Community Education, New York City Board of Education, 110 Livingston Street, Brooklyn, New York. Published three times per year. Free.

Magazine Articles

ADULT LEADERSHIP, *December 1956*
The Use and Abuse of Parliamentary Procedure, *Joseph F. O'Brien*.
What Do You Really Do When You Lead? *Morton Alpern*.

THE CRIPPLED CHILD, *October 1956*
Don't Shut Out the Shut-ins, *Elizabeth George Speare*.
My Pet Theory is Pet Therapy, *Marguerite Henry*.

INDUSTRIAL SPORTS AND RECREATION, *October 1956*
Retiring Without Rusting.

JOURNAL OF HEALTH, PHYSICAL EDUCATION, RECREATION, *November 1956*
Education for Leisure, *Norman P. Miller*.

Orienteering, *Bjorn Kjellstrom*.
NATIONAL PARENT TEACHER, *September 1956*

What Is the Press Doing to Teen-Agers? *Karin Walsh*.

SCHOLASTIC COACH, *November 1956*
A Fall Training Program for High School Basketball, *Garland F. Pinholster*.

A Good Sportsmanship Plan, *Ralph L. Bontrager*.

INDEX OF ADVERTISERS

	PAGE
All-Metal Tennis Table Company	9
American Camping Association	9
American Playground Device Company	1
Champion Recreation Equipment Company	9
Chicago Roller Skate Company	5
The Copper Shop	9
Dennison	1
Dextra Crafts & Toys Company	29
The Fred. Gretsch Manufacturing Company	7
Handweaver & Craftsman	7
Jamison Manufacturing Company	9
Jayfro Athletic Supply Company	1
J. C. Larson Company	1
The Monroe Company	29
National Sports Company	29
Nissen Trampoline Company	7
The J. E. Porter Corporation .. Inside Front Cover	
The Ronald Press	5
James Spencer & Company	29
Voit Rubber Corporation	5
Vogel-Peterson Company	1

NEW

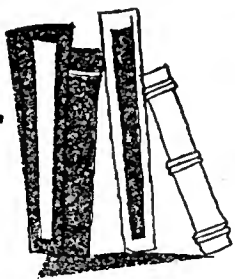

PUBLICATIONS

Covering the Leisure-time Field

Horizons For Older People *

George Gleason. The Macmillan Company, 60 Fifth Avenue, New York 11. Pp. 137. \$2.95.

Among the many books on the older adult now being published, this one has a "switch." Instead of writing about what *should* be done, Dr. Gleason writes primarily about what *is* being done. Much of his material was gathered by questionnaire, personal interviews, correspondence and in trips across the continent.

From factual information of this sort, the author has written a simple easy-to-read book that includes definite recommendations, suggestions and a sound philosophy on the tremendous possibilities of a program for older adults, not only for themselves but for the community and the nation. It should be especially useful to church leaders and leaders of civic or private agencies considering such programs.

Methods and Materials in Recreation Leadership *

Maryhelen Vannier. W. B. Saunders Company, West Washington Square, Philadelphia 5. Pp. 288. \$4.25.

Basically, this is a source book, of activities and their leadership, organized so that it can serve as a textbook for college students but be equally valuable to recreation leaders in community centers, churches, or other agencies. It could also be very helpful for in-service training programs.

The fact that it goes beyond the game or activity book in including theory, philosophy, and also introduces leadership techniques with the activities, makes it more basically important. It is a very good start. We hope Dr. Vannier will continue writing until she can give us a book that emphasizes and includes more individual and specific techniques of leadership—missing in so many otherwise fine activity books. The surface of this field of writing in our profession has scarcely been scratched. This book makes a beginning, although we should have liked to have had more emphasis

placed on motivation and analysis of values of specific activities.

Several interesting and useful features include a skill checklist for recreation leaders, an evaluation of recreation leaders, an interest finder, suggested reading for each chapter, the names and addresses of periodicals in recreation, and a list of classified, selected films, record sources and numbers whenever necessary. The sketches, by William Osburn, are clear and clever. *Definitely* a book to be added to your library.

Omnibus of Fun *

Helen and Larry Eisenberg. Association Press, 291 Broadway, New York 7. Pp. 625. \$7.95.

We have come to the conclusion that omnibus books can't be reviewed or judged like other books. Most recreation books are planned for a specific audience—for beginners in a craft, or for church leaders, or for coaches, or drama specialists, or parents, and so on. An omnibus has to cut across all such lines and try to offer something for everyone. Few people are more capable of doing this than the Eisenbergs, but even they can't satisfy all of us all of the time!

This book has a wealth of ideas and suggestions for all sorts of games, parties, mixers, contests, and so forth. In the wide area of social recreation, the Eisenbergs have had extensive experience and plenty of practice. Other sections, such as the chapters on planning service and money-raising projects, offer very little that is new, and lean too heavily upon church programs. The section on hobbies and crafts is very general, and the section on the handicapped seems just thrown in to make sure this group is not omitted. It is written, however, by Valerie Hunt, whose book, *Recreation for the Handicapped*, is well worth careful study.

Fortunately, these sections are a fairly minor part of this book, and are far outweighed by the very extensive sections on various forms of social recreation, including excellent material on folk songs and music, as well as a plethora of games, mixers, contests, quizzes.

This omnibus will be very useful to those many good folks who, from time to time, have to be in charge of a social program for their club, church or class. It is easy to read and to understand, and has so much breadth that its lack of depth is not too apparent. Its faults are mainly that it is an omnibus, and, like all such large collections, has to cover too much for too many too fast.

Writing such a book must have been a monumental task—to write one as good as this is an achievement, and it will give pleasure and confidence to many of its users.—VIRGINIA MUSSELMAN, *NRA Program Service*.

Volleyball Official Guide

U. S. Volleyball Association. Berne Witness Company, Box 109, Berne, Indiana. Paper \$0.75.

Do you know the exceptions to official volleyball rules when the game is played by coed teams? The height of the net for junior high school and younger players? Girls and women? The adaptations for beach play? The experimental recommendations for 1957? They're all in this edition of the *Guide*, so out with the old, in with the new!

Dramatics and Ceremonies for Girl Scouts

Girl Scouts of the U.S.A., 155 East 44th Street, New York 17. Pp. 206. Paper \$1.50.

This sound, intelligent paperback book contains a great deal of valuable material for recreation leaders in centers, churches, on playgrounds, and elsewhere. All of Part I, dealing with dramatics, is well done. Much of Part II, particularly material on flag eti-



Digitized by Microsoft

* Available through the NRA Recreation Book Center, 8 West Eighth Street, New York 11.

quette and flag ceremonies, and most of Part IV, dealing with community events, will apply to public recreation and camp programs.

Some of the actual ceremony and skit material, while developed specifically for Girl Scouts, can be adapted easily for use with other groups of girls. Activities are in good taste, of high quality, and deserve to be put into use by leaders of girls' groups.

The book contains an excellent, well-prepared and carefully selected bibliography.

Fun-Time Puppets *

Carrie Rasmussen and Caroline Storck. Childrens Press, Jackson Boulevard and Racine Avenue, Chicago 7. Pp. 41. \$1.25.

Like *Fun-Time Magic*, this booklet was written for children, but is excellent for playground leaders without much experience with puppets. Directions are clear and simple: illustrations are delightful. Use this with your junior leaders, too. It will teach them puppetry the fun way.

Quantity Cookery

Nola Treat and Lenore Richards. Little, Brown & Company, 34 Beacon Street, Boston 6. Pp. 628. \$4.95.

This looks excellent and certainly is fascinating to browse through. Actually it is a revised edition of a standard time-tested work. More than one hundred successful recipes have been added. The authors, both professionals and members of the board of directors of the National Restaurant Association, have drawn on their long experience to further perfect this dependable guide. It includes a large section on menu planning, lists to use for this purpose, recipes, budgeting. Anyone responsible for quantity cookery and not familiar with this should hasten to the nearest bookstore and give it a thorough examination in the light of his own needs.

The Lady of the Lighted Schoolhouses

Lela B. Stephens. Miss Dora Sharp, 2617 North 84th Street, Wauwatosa 13, Wisconsin. Pp. 32. Paper \$1.00, plus postage.

This delightful pamphlet about Dorothy Enderis (1880-1952) is a memorial to her contributions to recreation, particularly her many years as head of recreation in Milwaukee. Her last public address was given at the National Recreation Congress in New Orleans. She said of recreation, "During working hours a man makes a living; during his leisure hours he makes a life." She summed up her own life with, "I have an awfully good time at my job."

Free Diving

Dimitri Rebikoff. E. P. Dutton & Company, 300 Fourth Avenue, New York 10. Pp. 224. \$5.75.

There have been so many books on skin and scuba diving recently that we would hesitate to review another were it not for the fact that this latest one (published November 1956) by a French diving expert and free-diving pioneer contains so much last-minute, practical information—with charts and sketches of all up-to-date equipment, and descriptions of all maneuvers in handling it. There are chapters on un-

derwater adventures and their lessons, undersea exploration, underwater tour and hunting, photography (still and motion picture).

Step-by-step instructions tell how to dive with maximum efficiency and safety, and tables tell the number of minutes which must be allowed for decompression at various depths, before returning to the surface. The few color photographs are beautiful. The appendices list diving clubs state by state, as well as foreign ones, and gives a directory of diving equipment dealers, also state by state.

YOUR RECREATION BOOKSHELF

Here are some of those old friends that should be at your right hand daily . . . Basic books that have proven their value over the years . . . Do you have them in your personal library?

GAMES by Jessie Bancroft	RBC #331	\$8.50	LEISURE AND RECREATION by Martin H. and Esther S. Neumeyer	RBC #621	\$4.50*
INTRODUCTION TO COMMUNITY RECREATION by George Butler	RBC #203	\$6.00	THE THEORY OF PLAY by Elmer D. Mitchell and Bernard S. Mason	RBC #627	\$4.75*
THE ADMINISTRATION OF PUBLIC RECREATION by George Hjelt	RBC #535	\$5.50	ACTIVE GAMES AND CONTESTS by Bernard S. Mason and Elmer D. Mitchell	RBC #316	\$4.75*
PLAYGROUNDS: THEIR ADMINISTRATION AND OPERATION by George Butler	RBC #519	\$1.75	GAMES AND GAMES LEADERSHIP by Charles F. Smith	RBC #332	\$3.75

Prices subject to publisher's change.

* Not subject to NRA membership discount.

RECREATION BOOK CENTER—An NRA Service
8 West Eighth Street, New York 11, N.Y.

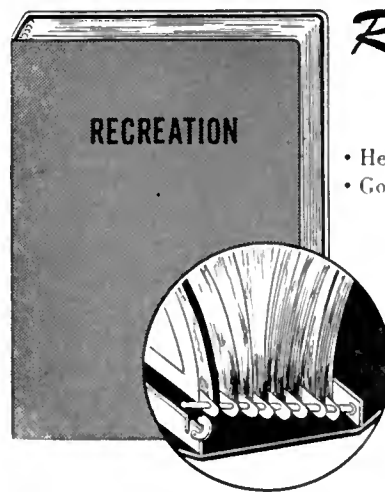

Recreation Magazine BINDER

- Heavy simulated leather
- Gold stamped
- Opens flat for changes
- Holds one year's issues

\$3.00

FOR quick and easy reference; to keep your magazines neatly, usably. The December issue always carries the complete subject index for the year. Keeping the magazines together in a binder gives you a volume on all phases of recreation.

MAIL
THIS
COUPON
NOW



RECREATION MAGAZINE	PLEASE FILL IN
8 West Eighth Street	Year Number of Copies
New York 11, N. Y.	1956.....
This is my order for.....copies	1957.....
of the RECREATION magazine binder.	Undated.....

Name.....

Address.....

City.....

Bill.....

.....; or Enclosed.....

Recreation Leadership Courses

Sponsored by the National Recreation Association
and
Local Recreation Agencies

January, February and March, 1957

HELEN M. DAUNCEY Social Recreation	Fayetteville, Arkansas March 11-14	Troy Hendricks, Head, Department of Health, Physical Education and Recreation, University of Arkansas.
RUTH G. EHLERS Social Recreation	*Morganton, North Carolina January 28-31	Jack Biggerstaff, Director of Recreation, State Hospital
ANNE LIVINGSTON Social Recreation	*Concord, North Carolina February 4-7	Jesse Taylor, Director of Recreation
	*Roanoke Rapids, North Carolina February 11-14	George Hudgins, Director of Recreation
GRACE WALKER Creative Recreation	Rockford, Illinois January 7-10	Mrs. Freeman Anderson, Training Committee, Rock River Valley Council of Girl Scouts and Hal Moyer, Executive Director, Ken-Rock Community Center
	San Antonio, Texas January 14-17	Mrs. Edith W. Dodds, Group Work and Recreation Section, Community Welfare Council, 114 Auditorium Circle
	Bozeman, Montana January 21-25	Miss Geraldine G. Fenn, Associate State 4-H Club Leader, Extension Service, Montana State College
	Des Moines, Iowa January 28-February 1	Miss Dee Maier, Director of Continued Education, Polk County Board of Education
FRANK A. STAPLES Arts and Crafts	Cicero, Illinois January 7-10	Alan B. Domer, Cicero Youth Commission, 5341 W. Cermak Road

* In cooperation with the North Carolina Recreation Commission, Raleigh

Miss Helen M. Dauncey of our training staff will be in the Pacific Southwest Area in January and February at the following air-bases: Edwards Air Force Base, March Air Force Base, Castle Air Force Base, Travis Air Force Base, and Fairchild Air Force Base. For further information, communicate with Linus L. Burk, Air Force Regional Representative, 1345 Lincoln Avenue, San Rafael, California.

Attendance at training courses conducted by National Recreation Association leaders is usually open to all who wish to attend. For details as to location of the institute, contents of the course, registration procedure, and the like, communicate with the sponsor of the course as listed above.

NRA 1957 DISTRICT CONFERENCE SCHEDULE

<i>District</i>	<i>Location</i>	<i>Dates</i>	<i>District Representatives</i>
CALIFORNIA STATE & PACIFIC SOUTHWEST	Senator Hotel Sacramento, California	February 24-27	John J. Collier
MIDDLE ATLANTIC	The Inn Buck Hill Falls, Pennsylvania	March 20-30	Richard S. Westgate
SOUTHEAST	Floridan Hotel Tallahassee, Florida	March 21-23	Ralph Van Fleet
SOUTHERN	Hotel Peahody Memphis, Tennessee	March 25-27	William M. Hay
SOUTHWEST	Texas Hotel Fort Worth, Texas	March 27-30	Harold Van Arsdale
PACIFIC NORTHWEST	Georgia Hotel Vancouver, British Columbia	April 7-10	Willard H. Shumard
GREAT LAKES	Hotel Sheraton-Gibson Cincinnati, Ohio	April 2-4	C. E. Brewer Robert L. Horney
MIDWEST	Jefferson Hotel St. Louis, Missouri	April 9-12	Harold W. Lathrop
NEW ENGLAND	Poland Spring House Poland Spring, Maine	May 26-29	Waldo R. Hainsworth



It's actually easy to save—when you buy Series E Savings Bonds through the Payroll Savings Plan. Once you've signed up at your pay office, your saving is done *for you*. The Bonds you receive pay good interest—3% a year, compounded half-yearly when held to maturity. And the longer you hold them, the better your return. Even after maturity, they go on earning 10 years more. So hold on to your Bonds! Join Payroll Savings today—or buy Bonds where you bank.

Safe as America— U.S. Savings Bonds



The U.S. Government does not pay for this advertisement. It is donated by this publication in cooperation with the Advertising Council and the Magazine Publishers of America.

Why the killer came to Powder Springs



THE SKINNY little Texan who drifted into Butch Cassidy's layout at Powder Springs one day in '97 had dead-level eyes, a droopy mustache, and two six-guns tied down for the fast draw. Called himself Carter. Said he was a killer on the run.

That's why Cassidy and the outlaws in his notorious Wild Bunch told him all about the big future plans for their train robbers' syndicate. They took him in.

And he took them in. He was a range detective whose real name was a legend in the West—Charlie Siringo. And the information he got before he quietly slipped away stopped the Wild Bunch for a long, long time.

Of course, Siringo knew all along that if Cassidy or the others had discovered the truth, they'd have killed him sure. But it just never worried him any.

You couldn't scare Charlie Siringo. Coolest of cool customers and rawhide tough, he had the go-it-alone courage it takes to build a peaceable nation out of wild frontier. That brand of courage is part of America and her people—part of the country's strength. And it's a big reason why one of the finest investments you can lay hands on is America's Savings Bonds. Because those Bonds are backed by the independence and courage of 165 million Americans. So buy U.S. Savings Bonds. Buy them confidently—regularly—and hold on to them!

Recreation

Henry Pfeiffer Library
MacMurray College
Jacksonville, Illinois

FEB - 7 1957

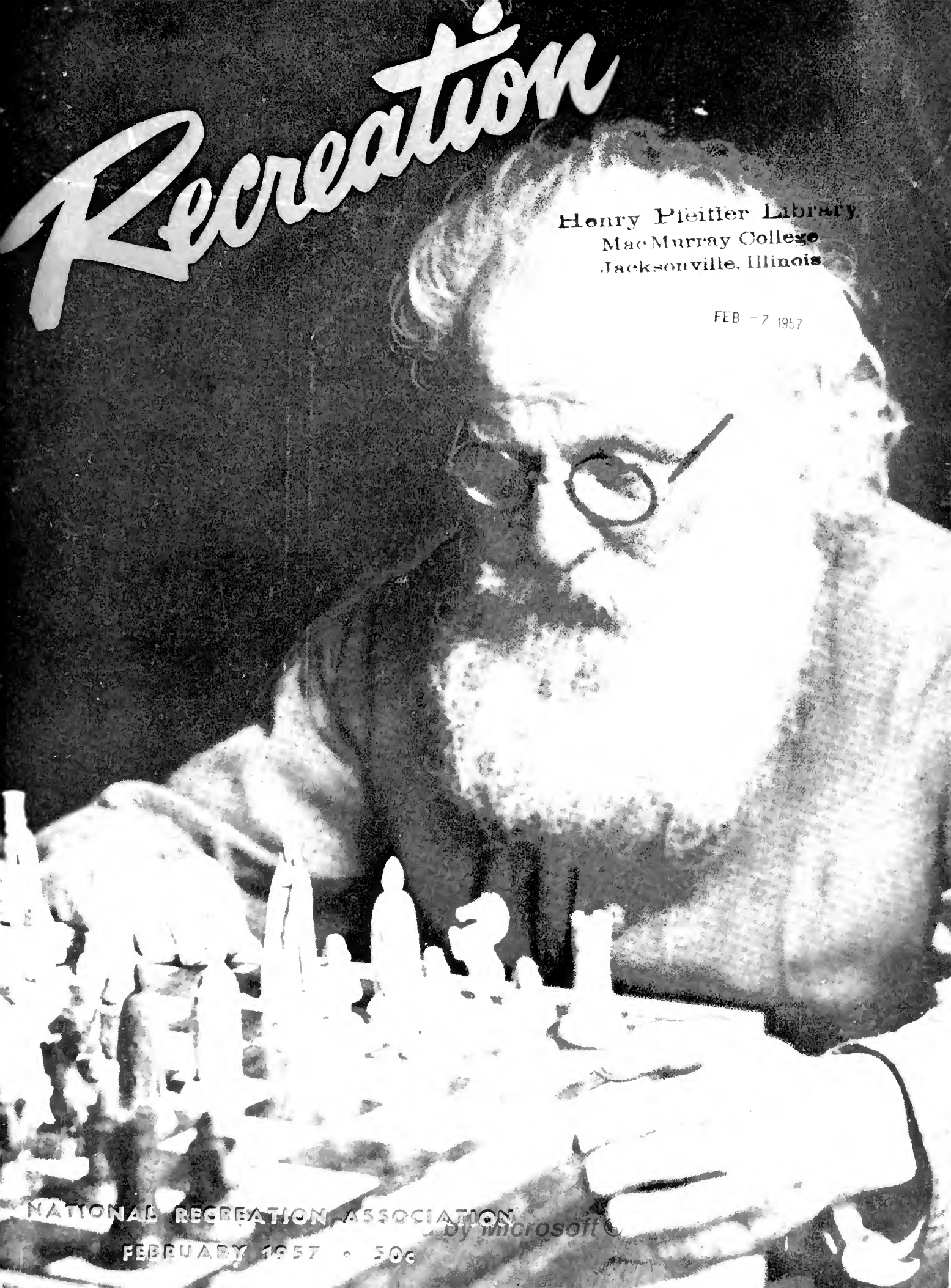

NATIONAL RECREATION ASSOCIATION
FEBRUARY 1957 • 50c

Selected RONALD Books

LEADERSHIP IN RECREATION

Gerald B. Fitzgerald, *University of Minnesota*. Emphasizing the principles, techniques, and tools of effective leadership, this book follows the premise that the recreation leader functions primarily in relation to people rather

than to activities. The book presents the methods used to develop and evaluate leadership ability, citing typical professional standards. Includes job descriptions, salary scales, requirements for public and private organizations.

304 pp. \$4

PLAYGROUNDS:

Their Administration and Operation

George D. Butler. This book discusses the enlarged function of the neighborhood playground; describes revised standards of playground space and leadership. In-

troduces new and up-to-date programs, and outlines current methods of dealing with a variety of playground problems.

Rev. Ed. 21 ills., 459 pp. \$4.75

ACTIVE GAMES AND CONTESTS

Bernard S. Mason; and Elmer D. Mitchell, *University of Michigan*. Presents well-known games together with newer approaches. Designed to acquaint student and

teacher with games of a vigorous nature, this book provides 1800 games and contests arranged in 5 major groups.

100 ills., tables, 600 pp. \$4.75

SOCIAL GAMES FOR RECREATION

Also by Bernard S. Mason and Elmer D. Mitchell. This book describes over 1200 games designed for social recreation and

general education play. A companion to *Active Games and Contests*, it classifies activities by type, age, and need.

86 ills., 421 pp. \$4.50

• *Ready in March*

TUMBLING TECHNIQUES ILLUSTRATED

Ted Burns. *Illustrations by Tyler Micoleau*. A thorough coverage, through text and illustrations, of the basic individual tumbling techniques. For both begin-

ners and advanced students the series of stunts appear in a logical progression. Book also includes basic exercises, learning assists, and lesson plans.

6½ x 10. 304 ills., 96 pp. \$3

Send for complete price list in *Sports, Physical Education, and Recreation*.

THE RONALD PRESS COMPANY • 15 East 26th Street
New York 10

MORE THAN

100,000

U.S. SCHOOLS AND COLLEGES EACH YEAR SPECIFY

America's Finest Sports Equipment by

VOIT

NEW YORK 11

DANVILLE, ILL. • LOS ANGELES 11

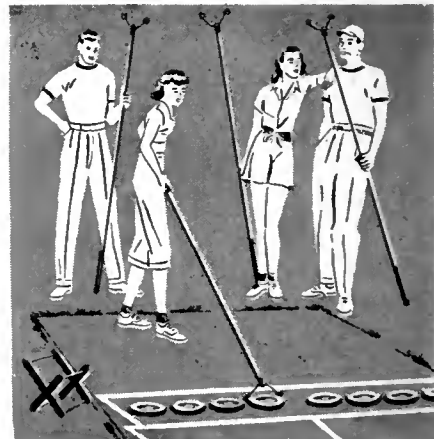

Shuffleboard

Fun For Everyone!

From 8 to 80 here is exciting recreation for all ages . . . keen enjoyment for players and spectators.

Rugged, Dimco FreeGlide Shuffleboard sets are available for both outdoor and indoor installation.

Easy to install . . . low in upkeep!

Write today for colorful folder, "Let's Play Shuffleboard," containing complete information on court layout and equipment.

DIMCO-GRAY COMPANY

205 EAST SIXTH STREET
DAYTON 2, OHIO

PARKS are the setting for many Recreation Programs.

PARK administration and know-how aid and complement your work.

The PARK and RECREATION picture is a dynamic, changing one.

Only one magazine leads in complete coverage of this field:

- from new products to new presidents of societies
- from how to put a bond issue across to the latest SWIMMING POOL data and design.

Join our family of over 14,000 readers who use PM as their working tool.

Send your purchase order to:

PARK MAINTENANCE

Dept. R

P. O. Box 409

Appleton, Wisconsin

One year—\$3.00 Three years—\$7.50

Groups of five or more, one year—

\$2.00 per person.

FREE to Your Group from
READER'S DIGEST
 a FULLY AUTOMATIC
COFFEE URN!



- FULLY AUTOMATIC... electric, portable
- choice of 30-, 50-, 80- and 120-cup sizes
- from cold water to superb coffee
- no installation... just plug in

Now... your organization can get a new, FULLY AUTOMATIC Coffee Urn by Tricolor... worth up to \$79.95 retail... FREE! It's easy. Just have members obtain as few as 33 Introductory Subscriptions at the special half-price rate of only \$1. for 8 issues. That's all there is to it! You'll reach your goal quickly because everybody knows, likes and wants The Reader's Digest for themselves, or as the perfect gift! Take advantage of this amazing offer—send for all details today!

ALLAN SCOTT, Dept. 29A
THE READER'S DIGEST
 PLEASANTVILLE, N. Y.



NEW AND IMPROVED

RYAN'S H. & R.

DRY LINE MARKERS

5 DIFFERENT MODELS

From 20# to 100# Capacity

Force Feed — Instant
 Shut-off — 50 lbs. capacity.

Shaker in Hepper for
 Constant Flow.

Adjustable Control on
 Handle.

**SAVES TIME AND
 MATERIAL**

Send to Dept. R for booklet on four other models
 H. & R. MFG. CO., LOS ANGELES 34, CALIF.

Burke
 BETTER-BUILT EQUIPMENT

... for
PLAYGROUND, RECREATION, SPORTS
 ... tops in
 Quality • Safety • Service

Heavy-duty Playground
 Equipment... and Park
 Benches • Picnic Tables •
 Portable Prefabricated All-
 Steel Platforms and Bleachers
 • Bicycle Racks • Offset Bas-
 ketball Backstops... and
 other recreational and sports
 equipment.

Use the Burke personalized
 planning and advisory service
 at no cost or obligation.
 Write for complete infor-
 mation about products and
 name of nearest dealer.

THE J. E. BURKE COMPANY
 NEW BRUNSWICK • N. J.
 FOND du LAC • WIS.

**PESCADORES ISLANDS
 ABORIGINES • ARROW HEADS**

3 RARE TRIBAL \$100
 PIECES p.pd.

DAGGER — 7" — \$3.95 p.pd.
 (Carved Sheath Included)

R. T. WATERS (Importer)
 1383 East 26th Street, Brooklyn 10, N. Y.

**START
 ROLLER
 SKATING**

for
 maximum gym use



Roller Skating is the one sport in which all your students can participate. It handles large groups of boys and girls quickly and easily, and does not require a change of clothes. The equipment is relatively inexpensive. Little supervision is needed. That's why more and more schools are making roller skating a definite part of their physical education and recreation programs.

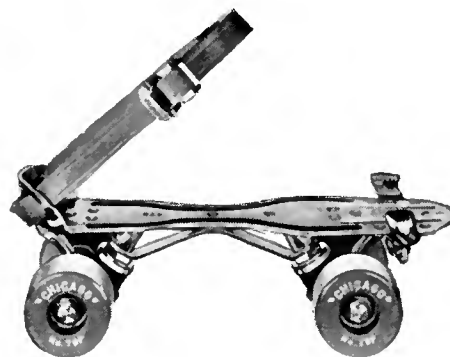

**NEW RUBBER-PLASTIC WHEELS ARE
 KIND TO GYM FLOORS**

These new Duryte rubber-plastic wheels outwear others and are guaranteed not to mar or scratch the floors. "Chicago" has a skate designed for any type of floor surface or finish. Write today for free details on roller skating programs and skating equipment.

"CHICAGO"

Roller Skates

4490-B West Lake, Chicago 24, Ill.

PLAY AREAS DO DOUBLE DUTY WITH

Superior

Folding Table Tennis Tables!

Superior tables can be stored compactly, can be opened for play in a jiffy... even rolled away on wheels by a youngster. Sturdy, rigid Superior MT1000 Table has edge-protecting METAL FRAME AND TUBULAR STEEL LEGS, HEAVY DOUBLE HARDWARE ON LEGS. Thousands used by playgrounds, camps, schools, military installations... wherever a heavy duty table is needed.

POPULARLY PRICED! APPROVED BY USSTA.

Write for literature showing complete line of institutional table tennis tables.



**NEW!
 Optional
 Feature!**

Roll-away casters make it easy to clear your floors.

Superior INDUSTRIES CORPORATION

565 Barry Street, New York 59, N. Y.

Editorially Speaking

Brotherhood Week

NO BETTER WORDS TO DESCRIBE "BROTHERHOOD"



Recreation has an important part to play in bringing about mutual understanding of the peoples of different nationalities, creeds and races. As Howard Braucher said: *Know you one another and thus you fulfill the law of peace. Share your songs, your music, your art, your sports, your 'heart's desire,' and you know you have shared what has greatest lasting value.*

Since 1940, the brotherhood of man has been pointed up, annually, by the observation of Brotherhood Week, sponsored by the National Conference of Christians and Jews. This year it is scheduled for February 17 - 24. What has your department planned as a special observation? Will you please write us about it?

It is interesting to note, by the way, the original of the seated figure of Lincoln (pictured above) in the great Lincoln Memorial in Washington. And symbol of brotherhood throughout the world, was sculptured in the old Whitney Museum—now the headquarters offices of the National Recreation Association.

Automation

As machines take over factory and office jobs, here are some of the changes being wrought. We will have:

- A world in which a smaller percentage of our labor force will work in factories;
- A world in which less monotonous and tedious work will require human effort;

- A world in which the workweek is greatly shortened;
- A world in which the pace of life slows down, in which leisure becomes the center of life, rather than the fringe.

Ultimately the most pressing problem is to educate individuals for a society in which leisure is the center of life rather than the fringe. Two hundred years ago, when it was necessary for many people to put in sixty or seventy hours a week in miserable factories, just in order to survive, the question of what to do with nonwork—with leisure—never presented itself. Today, with our forty-hour workweek, we are already facing the two-day weekend with something of a self-conscious attitude. It will become a perplexing problem when leisure time spills over from the weekend to Monday and Friday and when a man leaves his desk or station after six hours of work, still fresh and full of energy. — From "Automation Pilots a New Revolution" by John Diebold, *Challenge*, November 1956.

* * * *

"Our noses aren't as close to the grindstone as were those of our fathers and grandfathers, but enough of their attitude is left in our subconscious so that our new leisure isn't quite the wonderful part of our lives that it should be."—*Holiday*, March 1956.

* * * *

In 1931, Joseph Lee stated in an editorial. "Leisure for everybody, a condition which we are now approaching, is a new thing under the sun—the most revolutionary thing that ever happened . . . Here is our chance . . . We may choose the path of life or pass it by."

Are Your Parks Threatened Too?

City Recreation Director W. C. McHarris has sounded a timely warning about a possible threat to the city's parks in Kingsport, Tennessee. Why on earth even talk about chopping up a playground at a time when local juvenile delinquency appears to be on the rise?

The march of progress can become relentless, sometimes destroying everything of beauty in its path. Progress took over for commercial purposes the original park sites laid out by the city planners along Broad Street. Progress laid sweltering concrete over grassy parkways and chopped down the trees. Progress almost removed the Broad

Street Circle, one of the city's landmarks. And now, progress threatens the only place in the west end where children can play on public property. In past city elections, rumblings of discontent have come from the west end with cries of 'neglect' or 'underrepresentation.' Take away their park and these rumblings will grow into shouts of anger and Kingsport may well be forced into precincts for city elections." —*Kingsport News*, August 11, 1956.

An Editor Says:

Getting out this magazine is no picnic.

If we print jokes, people say we are silly.

If we don't, they say we are too serious.

If we stick close to the office all day, we ought to be around hunting material.

If we go out and try to hustle, we ought to be on the job in the office.

If we don't print contributions, we don't appreciate genius.

And if we *do* print them, the paper is full of junk!

If we edit the other fellow's stuff, we're too critical.

If we don't, we're asleep.

If we clip things from other magazines, we are too lazy to write them ourselves.

Now, like as not, some guy will say we copied this from some magazine. We did. — *Dwight News*, employee publication of Cone Mills Corporation, Dwight Division, Alabama City, Alabama.

Ever the Same

On Camping: "The use of the outdoors to a child is like the use of water to a fish, or almost so. . . . There is water to swim or wade in . . . there are trees to climb and fall out of . . . smells fraught with memory and association. . . ."

"He should also know the outdoors as a home, should build the wood fire and the camp and experience the endearing hospitality of mother earth.

"Nature is the source of wonder and imagination. . . . The sky and woods and fields speak with the thousand voices of winds and streams, of trees and flowers and animals. They are the child's book and laboratory, the world to which his mind and feelings are attuned, his counterpart in science and in art."—From "*The Use of the Outdoors*," *THE PLAYGROUND*, August 1927.

• See our special Camping Issue of *Recreation*, March 1957.—Ed.

Recreation*



Editor in Chief, JOSEPH PRENDERGAST
 Editor, DOROTHY DONALDSON
 Editorial Assistant, AMELIA HENLY
 Business Manager, ALFRED H. WILSON

ASSOCIATE EDITORS
 Recreation Administration, GEORGE BUTLER
 Program Activities, VIRGINIA MUSSELMAN

Vol. L Price 50 Cents No. 2

On the Cover

THE CHESSMASTER. This photograph, by Warrant Officer (JG) Henry D. Evans, won second prize in the Army's first World-Wide All-Service Amateur Photography Contest in 1949. Its subject was an eighty-three year old retired gardener of Karlsruhe, Germany. The chess set was handcarved in Heidelberg, Germany. Photo courtesy U. S. Army.

Next Month

The special Camping Issue of RECREATION in March, 1957, will carry an excellent selection of articles on camp leadership, administration, activities. A few of these are: "Camping for Tomorrow" by Rey Carlson; "Camp Selection, Layout and Development" by Lewis C. Reimann; "The Personal Touch in Day Camping" by Patrick J. Carolan; "Creativity in Camp Music"; "Nature Tools" by Bettye Breeser; "The Campfire" by S. Theodore Wool; "Guideposts for Safe Water Skiing" by Harold M. Gore. Among articles not on camping subjects are "Concession vs. Direct Operation" by Ralph M. Hileman; "Recreation at the South Pole" by Muriel E. McGann; "A Recreation Development" by William J. Duchaine.

Photo Credits

Page 41, 42, Bureau of Parks and Public Recreation, Portland, Oregon; 43, *The Detroit News*; 44, Jasper Nutter and Marshall LaCour, Long Beach, California; 46, 47, 48 (bottom), Division of Publicity, Frankfort, Kentucky; 48 (top), U.S. D.A. Extension Service photo by G. W. Ackerman.

RECREATION is published monthly except July and August by the National Recreation Association, a service organization supported by voluntary contributions, at 8 West Eighth Street, New York 11, New York, is on file in public libraries and is indexed in the *Readers' Guide*. Subscriptions \$4.00 a year. Canadian and foreign subscription rate \$4.50. Re-entered as second-class matter April 25, 1950, at the Post Office in New York, New York, under Act of March 3, 1879. Acceptance for mailing at special rate of postage provided for in Section 1103, Act of October 3, 1917, authorized May 1, 1924. Microfilms of current issues available University Microfilms, 313 N. First Street, Ann Arbor, Michigan.

Space Representatives: H. Thayer Heaton, 94 Garfield Place, Lynbrook, Long Island, New York; Mark Minahan, 168 North Michigan Avenue, Chicago, Illinois.

Copyright, 1957, by the National Recreation Association, Incorporated

Printed in the U.S.A.



* Trade mark registered in U. S. Patent Office.

THE MAGAZINE OF THE RECREATION MOVEMENT

CONTENTS

GENERAL FEATURES

- The "Why" of Recreation (Editorial) *Sherwood Gates* 40
- Adolescence Will be Like This *Helen Rapp* 41
- Activities in the Golden Years 43
- Operation Outdoors 54

ADMINISTRATION

- A Survey Leads to Action *Pat Perkinson* 53
- Recreation Space in Subdivisions 55
- Per Capita Expenditures for Recreation and Parks in 1955 *Muriel E. McGann* 57

PROGRAM

- Family Recreation—Foe of Juvenile Delinquency *Charles A. Bucher* 46
- An Irish Fair *Patrick J. Heneghan* 49
- Decorative Painting on Wood (How To Do It!) *Frank A. Staples* 50
- For Your February Parties 51
- Brighten That Dark Corner (Idea of the Month) 52
- Your Program Calendar 56

REGULAR FEATURES

- Editorially Speaking 34
- Letters 36
- Things You Should Know 38
- Reporter's Notebook 44
- Personnel—Recreation Personnel Review—1956 *W. C. Sutherland* 59
- How To Do It! Idea of Month See Program
- Market News 60
- Books and Pamphlets Received, Magazine Articles 62
- New Publications 63
- Index of Advertisers 64
- Recreation Leadership Training Courses Inside Back Cover

Popular
Dancing
Clown
Puppet
**ROCKY
ROLL-O**

Easy-to-Make
(paper rolls,
round boxes)



Directions
FREE . . .
when you
subscribe

to
PACK-O-FUN
Scrapcraft Magazine

USE
Order
Blank
Below

He's a panic! Children "roll with laughter" at his antics! To make this Rock 'n Roll Clown Puppet, use the cardboard tubes (from waxed paper, foil, toilet tissue) and containers (oatmeal or salt boxes, ice cream cartons) that collect around the home as readily as dust. So start your group collecting! Easily assembled, a few splashes of paint, crepe paper ruffling, yarn touches and Clown is ready to dance, act, siog, talk and make merry!

YOU Asked for These!



ALL 3 for \$1

So many PACK-O-FUN subscribers ask for back numbers, reprints or ideas for "more of the same," that we've compiled projects in 3 most requested categories into a Group of Booklets: Helping Hands for Busy Leaders.

Craft with Small Wooden Objects features a wonderful array of Toys, Games, Gifts, Favors, Ornaments using assorted small wooden "throw-aways." **Tin Can Projects**, especially for children . . . no soldering! Everything from bottle caps to large potato chip cans . . . with one chapter on simple cutting and shaping techniques. "There are never enough good skits," you wrote . . . so PACK-O-FUN'S new **Skit Book** came into being. Over a dozen original skits, pantomines, puppet plays, plus practical help for producing them.

**Subscribe Now
for PACK-O-FUN**

Like magic, turn "odds and ends" into useful items . . . gifts, toys, decorations, Holiday ideas, too, in every issue

Send **\$1.50** for **10** Big Issues Only



PACK-O-FUN

741 Devon Ave., Dept. 927
Park Ridge, Ill.

I enclose:

- \$1.50 for 1 year subscription to PACK-O-FUN.
- \$3.50 for 3-Year subscription plus FREE copy of "LAUGH AWHILE SKITS AND STUNTS," regular 50c value.
- \$1.00 for 3 PACK-O-FUN Helping Hand Booklets.

PLEASE PRINT

NAME _____
ADDRESS _____
CITY _____ STATE _____

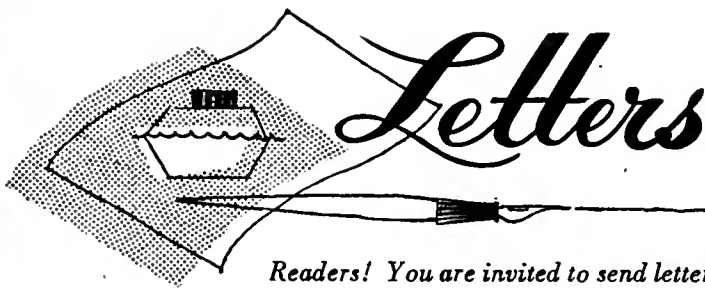

Readers! You are invited to send letters for this page to Editor, RECREATION, 8 West Eighth Street, New York 11—so that your ideas, opinions and attitudes may be exchanged with others on the wide range of subjects of concern to us all. Here is your chance to agree or disagree with the authors of our articles. Keep letters brief—not more than 250 words.

—The Editors.

Mr. Mallery

Sirs:

We have just learned of the unfortunate death of Otto T. Mallery in an automobile accident in Philadelphia.

Members of the Oakland Recreation Commission and our department staff extend sincere expressions of sympathy.

Mr. Mallery's long term leadership in the recreation field will be sorely missed by all of us who have known him over the years. We realize that this is a severe blow to the National Recreation Association, for he gave freely of his time and his wealth to the recreation cause.

JAY M. VER LEE, *Superintendent of Recreation, Oakland, California.*

Brotherhood in Recreation

Sirs:

We are extremely grateful that you devoted some space to Brotherhood Week (February 17 to 24) in the December edition of RECREATION.

Perhaps in no comparable way has the concept of brotherhood been so dramatically brought to life as it has in the field of recreation. Where children learn to play together, they also are learning to live together. Let us hope that our efforts in the future are more closely interwoven to make that dream more of a working reality.

Enclosed is a copy of a pamphlet you may find of interest. Perhaps those who work with youth groups on a continuing basis might find the concepts in this pamphlet of use.

SAAL D. LESSER, *Assistant Director, Commission on Community Organizations, The National Conference of Christians & Jews, New York City.*

• The pamphlet is "From Principle to Practice—A guide to human relations programming with youth," published by The National Conference of Christians and Jews, 43 West 57th Street, New York 19. Pp. 60. \$.25.—Ed.

A Mine of Information

Sirs:

The 1956 *Recreation and Park Yearbook*, with statistics as of December 31, 1955, has just been received and examined. This is a remarkable compendium of information on the growth of recreation facilities and the extent of use of such facilities by the public.

Collection and compiling of this information could only be accomplished by an organization with long experience and "know-how" in its particular field.

The "know-how" and insights into the meaning of the statistics also appear in clearly written descriptive matter.

This is a monumental work containing a mine of information basic to future progress.

GUY L. SHIPPS, *Consultant on Community Activities, The Dow Chemical Company, Midland, Michigan.*

• This publication (#208) is available from the NRA Recreation Book Center for \$2.00.—Ed.

Why Recreation?

Sirs:

Today I received my December issue of RECREATION, and read your "Why Recreation?" note on the "Editorially Speaking" page. I am sending you a few of my "whys."

Why did state and local governments spend more than \$464,000,000 for recreation last year? Why did voters approve over \$158,000,000 in recreation bonds in the last five years? Why this new profession, recreation?

These are questions that city officials, voters, and many others like myself are asking people today. A few weeks ago, I spoke to a very active women's club, which is starting a drive to build a greatly needed community center here. These ladies are making plans for a speaking tour of the ninety-odd civic clubs of our city, and I was asked to answer the "Why Recreation?" question. I used the following four points:

1. Basically, we are the same as our primitive ancestors, although we are living in a changed environment. We can no longer pick up a club and whack a person for stepping on our toes. We have to stand and take it—we go into an emotional strain—we have to find something to take the place of the cave-man's club. Sports programs offered by recreation departments provide the outlet that is needed by today's cave man.

2. We are living in the assembly-line age. Many people have jobs that are routine and require no thinking. Keeping in the mind the theory, "That which is not used will decay," recreation provides arts and crafts and other program activities giving participants a chance to use their creative abilities.

3. Today's labor unions, as well as mechanization, have helped to improve working conditions and to shorten the working day. Result: more leisure time than ever before. "An idle mind is the devil's workshop" is an old saying that is remembered by the recreation person as he promotes a full-time program of activities for the many people who don't know what to do with this ever-increasing leisure time.

4. Improvements in medical science are letting people live longer. Every year more and more people reach retirement age. These people, in many cases, are a problem to society. The recreation worker steps in and organizes them into golden-age clubs; and the clubs give them something to do and help to solve many of their problems. But most important, such a program lets them know they are not forgotten. This one reason alone could answer the "why" question.

These are only four of the many ways that recreation people are helping to answer it. We have got a job to do, and we must not settle for anything but the very best. We are in a new profession and every time we answer the "Why Recreation?" question, we are boosting our profession. It is up to you, its

members, to be its boosters—don't just belong.

W. G. BOYD, Superintendent, Parks and Recreation Department, Anniston, Alabama.

* * * * *

Leisure time is the source of life for most people. Eating, sleeping, working do not usually call for the utmost exertion of which we are capable. We can all do more at every level—physical, mental and spiritual. If the stimulus is great enough, we get second wind and tenth wind and live exuberantly all the while. But seldom are we so galvanized. This glowing, radiant life has to be sought for the most part during leisure hours in recreation.

Sadly enough, few can fuse all life into an incandescent delight through work; but recreation provides opportunity for living to the hilt in a self-chosen activity. And the sense of belonging to a group, the comfort of being loved and the satisfaction of accomplishing something worth while—all important for mental health and happiness—are almost inherent in the environment of these activities.

I think in America we can almost take for granted public desire for space, for sunlight, for children's play and playgrounds, perhaps even for broad opportunities for physical exercise. Almost anybody will agree to the value of playgrounds—that they help to prevent juvenile delinquency, to promote physical fitness, to build citizenship. But the thrilling reach of the movement is what grips many recreation leaders. They are fired on the chance to help build a nation of people, men and women who live nobly and happily, whose lives are all of a piece, who serve the Lord with thanksgiving and come into His presence with joy. These pour themselves out in service, paint pictures, cultivate gardens, study birds, play many parts on the stage, lift their hearts in song. There lies the path. Who would not

want to help in building a life like that for all men everywhere!

EDNA V. BRAUCHER, volunteer worker in the National Recreation Association and wife of the late Howard Braucher, president of the NRA.



Superior Design,
Construction and
PERFORMANCE

far greater
strength and
SAFETY!

AMERICAN
Approved

PLAYGROUND
AND SWIMMING
POOL EQUIPMENT

The wise choice of experienced
buyers for nearly half a century.

WRITE FOR LITERATURE



AMERICAN
PLAYGROUND DEVICE CO.
ANDERSON, INDIANA, U.S.A.

WORLD'S LARGEST MANUFACTURERS OF FINE
PARK, PICNIC, PLAYGROUND, SWIMMING
POOL AND LUNGING ROOM EQUIPMENT

SQUARE YOUR SETS PRESENTS
50 MUSICAL MIXERS

A book of 50 easy musical mixers and play-party games.
Only \$1.00 at your record store or direct from:

SQUARE YOUR SETS

3302—15th Str. A

Moline, Ill.

Write for a FREE sample copy of SQUARE YOUR SETS
magazine. Complete record mail order service—write
for catalogs.

WHAT to SAY ON 1001 OCCASIONS

Practical handbook for
the "amateur" speaker

Word-for-word
models you can
use for:

Now you need never again be at a loss for words when addressing your club or organization! WHAT TO SAY AND HOW TO SAY IT gives you tested models of speeches and letters that always win a hearty reception. David Belson—a prominent attorney active in community affairs for more than 25 years—not only tells you what to say but also shows you how to say it most effectively. Send No Money! Examine WHAT TO SAY AND HOW TO SAY IT for 10 Days FREE! See how much the book does for you. Then either remit \$3.50 plus a few cents postage or return the book and pay nothing. Write today to:

Nominations
Presentations
Appeals for Funds
Resolutions
Citations
Introductions
Installations
Tributes
Congratulatory
Dedications
Condolences
Awards
Speech Openings
Closing Remarks
Greetings
Etc., etc., etc.

Citadel Press, Dept. W-35, 222 Fourth Ave., N. Y. 3, N. Y.

A FENCING PROGRAM

For 2 or 200. Requires minimum space and simple inexpensive equipment. We design and manufacture the best and least expensive weapons and accessories for beginners and experts. Let us help you set up a fencing activity or develop the one you have. Consultations free.

Write Dept. R for
FREE CATALOG.



AMERICA'S OLDEST AND LARGEST IMPORTERS AND MANUFACTURERS OF

FENCING EQUIPMENT

30 EAST 10th STREET, N. Y. 3, N. Y. • GRamericy 7-5790

Things You Should Know . . .

▶ **PAN AMERICAN WEEK** is scheduled for April 8-14. This, and Pan American Day, April 14, will be used to point up and strengthen inter-American understanding. Writes José A. Mora, secretary general of the Pan American Union: "The next best thing to meeting our neighbors 'over the fence,' so to speak, is getting acquainted with them through their music, dances, art, and literature; to discover how they live, work and play, by means of books, photos, and films.

"It is my fondest hope that we may all join in a dynamic demonstration of inter-American unity and brotherhood in the schools, churches, clubs, trade unions, and community centers of America, not only during Pan American Week . . . but all year round."

Why not plan an over-the-fence program for that day or week? A 1957 Pan American Day packet is available from the Office of Public Relations, Pan American Union, Washington 16, D. C.

▶ **NEEDED: COVER PICTURES FOR RECREATION MAGAZINE!** Here is a chance to have a photo from your recreation department considered for cover display on a national magazine! Study the covers of RECREATION for the past year and note the type of pictures used, the amount of space needed for title and date line, and their placement, and that a vertical picture is necessary. Sometimes a horizontal picture is adaptable to strategic cropping—but not often. A picture must tell a story—of action, human interest, or inspiration. Photos of large groups do not, as a rule, lend themselves to this kind of use.

Written permission of parents or of the adults in the picture must accompany each, if it is to be considered for this purpose. Photos must also carry your name, credit to be given, and a line description of the activity or subject portrayed.

All submitted pictures that cannot be used on the cover will be held in our photograph pool. Proper credit will be given whenever one is published.

▶ **THE 1956 YOUTH RECREATION KIT**, which has been available for \$1.00 from

UNICEF, contains songs, games, crafts, customs and stories of other lands. It could, therefore, be useful in carrying out your special observance of Brotherhood Week, February 17 to 24. The manual of the 1955 kit, which also contains a wealth of material, is still available for \$.15.

▶ **SUMMER CAMPS IN AMERICA** became seventy-five years old with the closing of the camping season last fall, according to *Camping Magazine*. The earliest account of the first camp, written by Elizabeth Balch, appeared in the June 1886 issue of *St. Nicholas*, under the title "The Boys' Paradise."

▶ **THE NATION'S TWENTY-NINTH NATIONAL PARK** was opened recently in the Virgin Islands. A five-thousand-acre tract of hills and white beaches, the park was given to the federal government by Laurence S. Rockefeller, on behalf of Jackson Hole Preserve, Inc., a conservation organization sponsored by his family. The new park was authorized by Act of Congress, signed into law by President Eisenhower last August.

▶ **THE FIRST STATE PARK IN WESTCHESTER COUNTY**, New York, is to be started this year. Its eight hundred acres are beside the Taconic State Parkway at Yorktown. Robert Moses, chairman of the State Council of Parks, states that the new park not only will serve residents of other counties but will relieve Westchester's overcrowded parks restricted to local residents. Formal action awaits settlement of details.

▶ **NEW RECREATION ARTICLE COMING:** "Can Children Have the Fun They Need in Your Community?" by Ruth and Edward Brecher, in *Parents'* magazine in March. "Children at play," the article states, "are developing those physical, emotional and social qualities which will characterize them throughout life . . . just an hour on a well run playground will convince you that recreation is a necessity."

Cited as one example of a well-run municipal recreation program is the

suburban community of Leonia, New Jersey. A detailed description of the requirements of a good community recreation program is provided. Land, playgrounds, playfields, indoor facilities, professional leadership and finance standards are listed.

▶ **"EVERY THIRD DAY IS A PLAYDAY IN THE U.S.A."** is the theme of a new advertising promotion which the Aluminum Company of America is aiming at the expanding recreation market. (See "Automation," on page 34.) Purpose of the promotion is to call attention to the company's sporting goods and products for leisure living.

▶ **FEDERAL LEGISLATION** — Recreation agencies for a number of years have been unable to secure federal surplus property without cost because, under the terms of the present law, donable surplus may be secured only by schools, colleges, universities, hospitals, clinics, and so on. Public and private recreation agencies not a part of a recognized educational or health institution so far have not been eligible for surplus materials.

The National Recreation Association, through the National Social Welfare Assembly, has recently recommended to the United States Department of Health, Education and Welfare that the law be amended to include voluntary nonprofit recreation agencies and tax-supported recreation agencies.

The National Recreation Association and twenty-five other social and recreation agencies were represented at a congressional subcommittee hearing on possible revision of the federal excise tax law to exempt public and private agencies from the payment of federal excise taxes.

▶ **AN INSTITUTE ON RECREATION FOR THE PHYSICALLY HANDICAPPED**, under auspices of Recreation Center for the Handicapped, Inc.; the San Francisco Adult Education Division and Recreation and Park Department; and the California Recreation Commission, will be held March 24-30 at the Fleishacker Pool Building, San Francisco.

▶ **AN ARTICLE ON PLAYGROUNDS**, "A Playground Really Built for Kids" by Hank Ketcham, creator of "Dennis the Menace," appeared in the January 20 issue of *This Week*, Sunday magazine. He presents a new inexpensive kind of fun area, with such equipment as "The Thing," which is a different toy to each child; the "Flying Swing," which gives the rider an unbalanced spin; the "Umbrella Tree," a small rider's paradise; and so on.

Jamison PLAYGROUND EQUIPMENT

Be sure to check the many exclusive features of this rugged line. Write for free catalog of 254 items.

Jamison Manufacturing Co. Since 1925
 27-1 South Mettler Street
 Los Angeles 3, California

ORIENTAL BUTTERFLIES

12 RARE DIFFERENT \$1.95

EXQUISITE COLORS
 ALL SPECIMENS PRESSED OPEN,
 FOR IMMEDIATE MOUNTING

R. T. WATERS (DIRECT IMPORT)
 1383-95 E. 26 St., Brooklyn 10, N. Y.



Jayfro BASKETBALL STEEL CHAIN NETS

3 Years Guaranteed outdoors or indoors

Also featuring Jayfro's custom built

- ✓ ALUMINUM MULTI-PURPOSE STANDARDS
- ✓ SHUFFLEBOARD SETS WITH "RUBBER CUSHIONED" DISCS
- ✓ PADDLE TETHERBALL SETS

• Send for Free Catalog •

JAYFRO ATHLETIC SUPPLY CO.
 Dept. R, Box 1065, NEW LONDON, CONN.

IDEA BOOK ENAMEL ON COPPER



64 PAGES

Learn jewelry making; latest enameling processes and techniques from step-by-step illustrated instructions. Book lists many new copper items, complete supplies, tools & equipment. Send for your copy of this valuable reference book today! (It's FREE!)

THE COPPER SHOP

A Div. of Immerman & Sons • Dept. 154
 1812 East 13th • Cleveland 14, Ohio

NATIONAL BASES



PRECISION BUILT QUALITY GUARANTEED

Nationally Preferred

Write for our new Base Catalog.



370 N. MARQUETTE STREET
 Fond du Lac, Wisconsin

x-acto[®] lino tools...



• Sharpest, most accurate cutters made—available in 10 styles • All-Metal Handle (patented) features "vise-grip, non-slip" chuck • X-acto Cutters fit all standard handles—X-acto Handles take all standard cutters.

Complete line of X-acto Lino tools and brayers—economically priced—individually and in sets, 45c to \$2.95.



Send 25¢ for HANDICRAFT TOOL and PROJECT SELECTION GUIDE BOOK

48-99 Van Dam Street, L.I.C. 1, N.Y.



SPRING

is Just Around the Corner!
 (Brr-rrrr!)

That's what the Program Department tells us, anyway. It's making like a robin because—you guessed it!—the PLAYGROUND SUMMER NOTEBOOK is under way.

It's Top Secret—but the theme this year is Circles of Friendship—emphasis on cooperation between home, neighborhood, and playgrounds. Ideas for family nights, new craft projects, lots of games, new special events.

Twelve bulletins in the set . . . \$2.50 (NRA members \$2). Available May 1.

Order EARLY. Order enough copies. Last year the supply ran out. Don't let it happen to you, tra la!

National Recreation Association
 8 West Eighth Street, New York 11, N.Y.



"The Choice of Those Who Play The Game"

The MacGregor Co. • Cincinnati 32, Ohio
 FOOTBALL • BASEBALL • BASKETBALL • GOLF • TENNIS

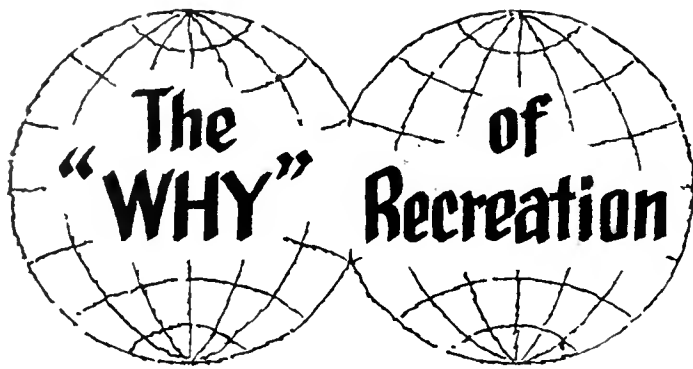

This challenging statement might well have been drafted for Brotherhood Week, February 17 to 24.*

Sherwood Gates, Director, Office of Community Services, U. S. Air Force

IT SEEMS to me that it is utterly essential that we of the free world come to know and to understand each other better—how the people of our countries work and play and live; what the cultural and spiritual interests are which sustain them; what their dreams are, and what hopes they nurture and cling to. It seems to me that recreation people are unavoidably challenged to make available and attractive, to more and more people, opportunities in their free time to engage in activities which promote the development of new and varied intellectual and cultural interests and pursuits, which stimulate intellectual curiosity, which accelerate the desire to learn. There are so very many things for all of us to learn about ourselves and our world neighbors if, as individuals in freedom-loving countries, we are to be more than pawns in this vast struggle against power and domination around the world. And, realizing that it is the quality of men's souls which is at stake, our recreation policy makers and leaders must create and offer to us, as never before, opportunities for free-time participation which will enhance the spirit and lift the tone and quality of our daily living beyond the level of boredom and despair, and above the level of commercialism and materialism.

Recreation leaders simply cannot conceal their own basic attitudes regarding life and values. Their prejudices, their likes and dislikes, their ambitions and motives, their own moral integrity or lack of integrity, the things in life which they hold in high esteem—inevitably these things are revealed to those whose activities they help direct. For example, does the recreation leader have a strong democratic respect for the personality of persons—all persons? If he does not hold to such a respect, those who associate with him will soon discover this anti-democratic attitude through his behavior, through the ways in which he deals with persons in his daily activities as a leader, regardless of what he may say in formal speech and writing.

I hope that I am wrong in fearing that all too often we place emphasis on the formal training and the skills of recreation leaders, to the neglect of an all-important emphasis on their quality as persons, on the depth and strength of

their democratic beliefs and convictions. I am not suggesting here that high requirements for skills are incompatible with an emphasis on quality of character; on the contrary, what I am urging is a balanced, a completed emphasis. Only those who are completely dedicated to the purposes and convictions and processes of democracy have a rightful place of leadership in the recreation movement of a free country.

Let us suppose that a group of people have come to this country from other countries to learn what we are really like, what our real wants and interests and desires are, what the things in life which we really value and prize are; what the motives and drives are which make us 'tick.' These visitors read our newspapers and magazines and books. They hear our speeches, listen to our radio programs, and see our television offerings. They observe us closely as we go about the business of earning a livelihood; but they watch us even more closely in our recreation and other free-time activities as we develop and express our inner lives. Just what, in our judgment, would these visitors conclude about our character as a people through their observation of us in our free time? Would they decide, for example, that we are a happy and satisfied people? Would they decide that we are a people of basic good will and of democratic neighborliness? A people of good taste and good manners? A people who enjoy social fellowship, who prize and reward good sportsmanship? A people who like and enjoy music, dramatics, and the creative arts, good literature, nature, and all forms of beauty? Would they decide that we prize the arts and the fruits of gracious, joyous living, and that our educational system, our homes, churches, and our recreation movement have all combined and concentrated successfully on teaching us how to live as free, responsible, moral, and happy citizens of a democracy? Or might they decide that, for all too many of us, our chief gods are machines, and full barns, and fast automobiles, and television sets, and indoor plumbing, and that as a people we have not yet learned how to use our leisure to our own best advantage and enjoyment, to the enrichment of the world's culture and spirit?

We in this country have free time in quantities far beyond the dreams of men in the days of my childhood; but we have far to go in developing a leisure-time culture which will be an asset to ourselves and to the nation and to a distraught world. The free world needs the wisdom and good will of all of us, for leisure time can be one of the greatest personal and national assets and strengths of our countries, or it can be a tragic personal and national liability. ■

* Excerpts from a talk, "Values of Recreation in a Democracy," given at a Cooperative Community Recreation Exchange Project session, National Recreation School, 1956.

“Teen-agers are, like Ivory soap, 99 44/100% pure,” says Miss Rapp, “and if you keep your sense of humor and your faith that they’ll turn out all right, you’ll also keep your sanity.” This material is from a talk delivered at the annual workshop for community center leaders at Fort Wayne, Indiana.



Adolescence Will Be Like This



Helen Rapp

PERHAPS there are some who do not know yet what a teen-ager goes through, what “being like this” means. What is it like—this period of adolescence?

As we know, it is a period of great physical change. While growth is uneven at all ages, the adolescent years are characterized by growth and development so uneven that leaders of teen-age groups would do well to recognize this as one of the most important factors in learning to understand and deal with these youngsters.

Normally, sometime between the ages of ten and sixteen or seventeen, each boy and girl passes through three stages. First there is likely to be a period of little change, called by some the plateau stage. For a period of six months or a year the child may make little or no gain in height or weight. Then suddenly he shoots up—perhaps four or five inches. This height spurt is usually followed by rapid gain in weight, sometimes as much as twenty or more pounds in less than a year.

Now, if all children in a given group went through these stages at the same time, no one would have to worry about

being the “Shrimp” or “Beanpole” or “Skinny” or “Fatso” of his gang. Unfortunately, however, these stages are likely to come anytime between ten and seventeen. We have the early growers and the late growers. And, just to make matters worse, girls are likely to have their spurt in height one and one-half to two years before the boys. Anyone who works with teen-age groups knows what a social problem that can cause. You know—the five-foot-six-inch girl trying to waltz gracefully with the five-foot boy under her arm, or the ninety-five-pound boy trying to swing his one-hundred-and-thirty-five-pound partner!

Not only do members of a group grow at different rates, but all parts of the same individual stubbornly refuse to develop simultaneously. Legs are likely to lengthen before the trunk. Sometimes these bones develop more rapidly than the muscles which control them. Sometimes muscles outstrip the bones. These irregularities make for awkwardness and embarrassment. Sometimes muscular strength increases so rapidly that the adolescent literally “doesn’t know his own strength”—and he is accused of undue roughness which actually is unintended. The heart and lungs develop more slowly than the body. Blood pressure may fall. Care must be taken that these adolescents do not get overtired. Rapid and un-

even growth may consume much of the child’s energy—and we accuse him of laziness. Paradoxically, these lazyspells may be punctuated by sudden bursts of frenzied activity. Conversely, the teen-ager may begin an activity with boundless energy and enthusiasm, only to peter out completely before the game is over or the task completed.

Biological changes during these years account for still other problems. Change in body contours and voice register, increase in hairy growth and new body functions cause both pride and self-consciousness. There’s a whole new self to get used to. Changes in blood chemistry may result in still another burden to be borne—acne, which can make a boy’s life miserable and be an utter calamity for a girl. Is it any wonder the child becomes different—and difficult?

Again, these biological changes come at different times to different people. The onset of puberty may come any time between nine or ten and sixteen or seventeen, with girls about one and one-half years ahead of the boys. Thus, even if a leader has in his group only boys and girls of a given chronological age, he may find many maturity levels represented. For example, in a typical group of twenty thirteen- or fourteen-year-olds—say ten girls and ten boys—a leader might rightfully expect to find

MISS RAPP has taught physical education and handled teen-agers for many years at Forest Park School, Fort Wayne, Indiana.

six boys and one girl who have not yet left childhood, three boys and four girls who have entered puberty, and one boy and five girls who have reached physical maturity.

Knowing what to expect at these various stages of physical and biological growth is the beginning of understanding the teen-ager.

There are numerous psychological changes too. With the maturing of the sex organs comes a deepening of feeling. These feelings sometimes surge over these adolescents, and they try to find outlets for their devotion—not always wisely, of course, because of their great inexperience. Crushes, cases, and falling in love are common. And they *do* fall in love—and usually out again, only to fall in once more. Wise is the leader who can help direct these feelings. Too often we tease and poke fun when friendly guidance is needed. Adolescents go overboard in their devotion to a cause, and no amount of service and sacrifice is too great. Again, a wise leader capitalizes on and tempers this feeling.

Teen-agers, as a result of the many changes in themselves, are likely to be a bundle of jangling nerves. Their emotions simply shoot up and down. Squabbles, cross words, and apologies follow in quick succession. The adolescent himself becomes impatient, and we adults become exasperated. If only we could remember that patience and time are needed for their systems to adjust to change!

These teen-agers are as changeable and unpredictable as April weather. One moment they agree sweetly to all suggestions, the next they object to everything. Their moods change from the extremes of hilarity to depths of depression, from painful self-consciousness to obnoxious strutting. They can be thoughtless and rude, or saccharinely courteous. They are often different persons in different places and with different people. They play for attention by giggling, wisecracking, talking loudly, flying into rages, sulking, or acting sophisticated or superior.

The adolescent period is characterized by growing independence. Much as we adults hate it, these adolescents are beginning to see us as we are. They are brutally frank and often downright

fresh. They want more privileges, but are sometimes unwilling to assume corresponding responsibility. They want to be independent, but yearn for dependence. This is in part responsible for the all-importance of the gang. Acceptance by their peers is important because, in the attempt to achieve independence from adults, they need the security of "belonging" to the teen-age crowd.

Here again we see the differences within the group. Those who are in the pre-adolescent maturity level prefer companions of their own sex, while adolescents are ready for mixed groups



and a different type of social activity.

Adolescents have, to an exaggerated degree, the social needs common to all people, the need for affection, the need for acceptance, and the need for achievement or recognition. Anything we can do to help satisfy these basic needs will help to build up security in these youngsters who, for all their surface cockiness, are terribly unsure of themselves.

Although the adolescent is in almost constant conflict with his parents, he yearns for their love, and needs their love and understanding more than at any other period in his life.

Belonging to the gang and being like the gang are *musts* to him. To be different, in even the most insignificant way, is stark tragedy to all but the most individualistic teen-ager. The adolescent whose parents, home, clothes, are not like the others is miserable indeed.

Teen-agers need to feel successful in at least some of the things they do and to be recognized for their achievements.

A teen-ager needs encouragement as a plant needs water. Perhaps we are too parsimonious with our praise. The good deeds and worthwhile accomplishments of the *many* adolescents are likely to be lost behind the adverse publicity given to the small number who commit offenses against society. Let's give the 99 44/100% their just due!

I've said very little so far about teen-age interests. Personally, I don't think it matters much *what* you offer them in the way of recreation as long as it's wholesome and *something they can do with the gang*. They go to the movies and don't know what picture is playing; they go to the ball game and don't know the score. They go because their friends are there. With one voice they squeal, shriek, groan, sigh, hoo, and cheer.

Teen-agers are interested first of all in themselves. Therefore there might well be a place in your program for some discussion groups on personal development and social growth.

Teen-agers are definitely interested in the opposite sex. Therefore, activities that boys and girls can do together should have a high priority rating. Dancing is an ever popular activity with both boys and girls.

For a group which includes both mature and immature youngsters, hikes, picnics, wiener roasts, roller skating, or ice skating provide fun for all. Sports of all kinds have great appeal for the majority of boys and girls. Hobby or interest groups, too, will please.

For the older teen-agers who are beginning to think more seriously and who want to do something more constructive, activities with a community service theme will meet with approval. Occasional parties may be shared with others less fortunate than they, or continuing community projects may be undertaken. In either case, group planning should precede and group work should carry on the activity, with adult guidance—but not adult domination.

Working with the teen-ager is not easy, but it is both challenging and rewarding. If your sense of humor and your faith in his future should occasionally fail you, you might try what always works for me. I do a little flashback—to when I was a sophomore in high school. It works like a charm! ■

Activities in the Golden Years

News of the Old Timers



Some one hundred citizens have the time of their lives, convinced that life is every bit as good at sixty or seventy as at twenty or thirty. Dearborn man picks flower for friend.



WHEN WORKING men and women retire on a pension at the age of sixty-five, it is possible that the best years of their lives lie ahead—when appreciation and enjoyment are heightened and leisure increased. George Bernard Shaw once said that it's a pity youth is wasted on young people. And yet, as we know, the golden years are *not* the good years for the many persons who have not prepared to enjoy them nor learned how to use their leisure time to enrich their daily lives. In this respect, municipal recreation departments are proving helpful—through introducing people to interests which can be carried over and providing facilities and leadership for social and other group activities after retirement.

The following are examples of the sort of thing that is being done by departments throughout the country.

Outing Groups

The Senior Citizens Club, in Dearborn, Michigan, is so large that it is divided into two groups. Members meet every Monday; and on alternate Mondays they go on outings. Traveling on a school bus, they visit such places as Bob-Lo, Belle Isle, the Detroit Zoo, state parks. They carry picnic lunches, go boating and wading, play cards, hold song fests, engage in brisk discussions. Sometimes they stop at parks or playgrounds to give the merry-go-round and slides a workout, or at an ice cream parlor for a treat.

In the winter months they see movies, write and enact their own plays, take a whirl at square dancing, stage parties and visit places of interest.

The program has been an unqualified success. This hardy group knows what the lyricist meant when he wrote of "the young at heart."—From *The Detroit News*, September 18, 1955.

Bridging the Years

At the Past Fifty Lounge of the recreation department in Beaver Falls, Pennsylvania, members renew friendships, once again find an interest in life, and become productive, creative members of a social group.

Their newest project is a real success. The young people of the recreation program have adopted grandmothers and grandfathers from the oldster group. They introduce themselves in calls to their homes, and stay to talk with them; they remember birthdays and special holidays. Past Fifty Club members are beginning now to respond and return this exchange of ideas, time—and even presents. They are finding they still can learn and still can be creative and interesting to age groups other than those of their own generation.

Both groups seem to be enjoying it immensely. There seems to be a bridge of understanding between them and both are profiting from the experience of being together.—NORMA HEINRICH, *Superintendent of Recreation, Beaver Falls, Pennsylvania.*

Special Events

A vigorous community center program should provide a series of high

and medium peaks of interest. These add zest to the life of the organization.

Ever on the alert for timely motivation of such events, George Seedhouse, chief of community centers and playgrounds for Cleveland, Ohio, noted that the Wilbur Wright Community Center had been functioning for twenty-five years. Seeing the possibilities of such a milestone, the idea of a Silver Anniversary Celebration developed. Committees were appointed, and each set to work planning some phase of the affair.

The evening seemed to divide itself into two parts, a civic dinner, followed by an old time dance. (Some charter members of the center's Old Time Dance Club had not missed a single session of old-time dancing in the quarter-century since the opening of the center.) The local newspapers agreed to run articles and announcements, and this publicity was supplemented by word-of-mouth. One week after announcement of the dinner, the two hundred possible reservations had been filled.

On the night of the silver anniversary, dinner was prepared by the day-school cafeteria staff, and served by the girls of the home economics class. After-dinner speeches were limited to one minute. The barbershop quartet of the center presented some close harmony; and charter members were given silver trophies for their contributions to the center.

Later, in the gymnasium, the dinner guests were joined by old friends. Between dances, while resting up from a vigorous "Red River Valley," or "Virginia Reel," they renewed acquaintances.

Now they are looking for other special events at Wilbur Wright! —MARJORIE WELCH, *former director of Wilbur Wright Community Center.* ■

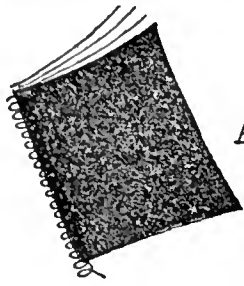

A REPORTER'S NOTEBOOK

Planning for 39th National Recreation Congress



Representatives of the five recreation organizations—National Recreation Association, American Recreation Society, California Recreation Society, Los Angeles County Park and Recreation Department, and Long Beach Recreation Commission—co-sponsoring the 1957 National Recreation Congress (see announcement in RECREATION, January 1957, page 6) are making history in the recreation field by setting a new high in cooperative planning.

A preliminary planning committee for the Congress (above), which met in Long Beach, California, on December 19, 1956, consisted of, left to right: Norman Johnson, director, Parks and Recreation, Los Angeles County; Sterling S. Winans, director, California Recreation Commission, Sacramento; Dorothy B. Taaffe, president-elect, ARS, Los Angeles; J. Earl Schlupp, president, ARS, Denver; Joseph Prendergast, executive director, NRA, New York; Howard B. Holman, president, CRS, Fresno; William Frederickson, president-elect, CRS, Los Angeles; John J. Collier, representative, NRA, Pacific Southwest District, Los Angeles; Walter L. Scott, director, Municipal and School Recreation, Long Beach.

Watch RECREATION Magazine for further news and announcements about exciting Congress plans.

Cited for Anti-Litter Leadership

Joseph Prendergast, executive director of the National Recreation Association, and David DuBois, NRA director of public information and education, were among the representatives of national civic and public service organizations who received a special citation at the close of 1956 from Donald J. Hardenbrook, president of Keep America Beautiful, Inc., for "volunteer service" in the war

on litterbugs.

Medallions bearing the official Keep America Beautiful symbol were presented "in recognition and appreciation of their leadership through the early developmental stages of the nationwide educational program to stimulate individual responsibility and pride in clean, safe, attractive surroundings."

Commending the NRA for its pioneer role in the KAB movement, Mr. Hardenbrook said: "This prominent national organization, together with other major public and private non-profit groups, is

concerned about the litter potentials that are inevitably linked with our expanding economy and our increasing use of outdoor recreational facilities. They are in the vanguard of one of the most important public service campaigns ever launched. We rely on accelerated participation, in the future, by these and other civic and youth agency leaders, for the achievement of our common goal."

NRA News Notes

National Recreation Association announces the following staff changes:

- Arthur W. Williams, assistant executive director of the NRA, is now associate executive director. He has been on the Association staff for forty-six years.
- Charles E. Reed, director of field services, and George D. Butler, director of research, have been appointed assistant executive directors of the NRA. Mr. Reed has been with the Association for forty years, Mr. Butler for thirty-eight.
- Richard (Wink) Tapply, former director of recreation in Bristol, New Hampshire, has joined the NRA staff as district representative in New Hampshire to assist Waldo Hainsworth, New England district representative, with field work in small communities.

Bob Gamble Goes to IRA



Robert R. Gamble has joined the staff of the International Recreation Association as director of the IRA Exchange of Persons projects and general assistant to

Thomas E. Rivers,

IRA director general. (See RECREATION, January 1957, page 12.)

Mr. Gamble was a member of the NRA staff for eighteen years, having joined the organization in 1938 with a background in law and public administration. He is well known to the recreation field through his work as assistant director of the NRA Field Department, assistant secretary of the National Recreation Congresses, and assistant director of the first Cooperative Community Recreation Exchange Program of last year. In his earlier years with the Association, he served in personnel and as assistant to Howard Braucher.

Basic Leadership Requirements for Today's World

The greatest hope for us in a confused and disordered civilization will be men and women who possess these qualities:

Receptive minds capable of critical self-analysis.

Ability to make wise decisions and formulate sound personal and social judgments.

Mature approaches to individual and social problems based on reason rather than emotion.

Mental flexibility, recognizing society as an evolving process in the dominion of new ideas, concepts, and behavior patterns.

Appreciation of their own people's heritage.

Intelligent understanding of the civilization and cultural patterns of other people and races.

Attitudes of fair play in the face of blind racial and religious prejudices.

Clear perceptions of the privileges and obligations of membership in a civilized society.

Balanced understanding of religious and moral values.

Serenity to accept the unchangeable, courage to change what should be modified, and wisdom to distinguish between the two.

—From an address by Dr. Gordon S. Watkins, provost of University of California. Reprinted from *California Recreation News-Previews*, September 1956.

About People

KEITH A. MACDONALD, executive director of the Greater Vallejo Recreation District, California, was awarded an honorary life membership in the Vallejo Council of Parent-Teacher Associations. The presentation program, honoring his "meritorious and outstanding service toward the education and welfare of children and youth," was in form of the well-known "This is Your Life" TV show.

HORACE B. GARMAN, Decatur, Illinois, attorney, who has served as the city's recreation board president for twenty years and has been active in local recreation activities for thirty years, retired as board president recently.

In Making a Better Citizen

Colonel Arthur W. Gustafson, Special Services Officer, Sixth Army, has this to say about recreation for service personnel:

"The Armed Forces Recreation Program actually came into its own after World War II when it became necessary to station American soldiers, sailors, airmen, marines and their families around the globe. This program, still in the process of development, has progressed to the point that it now encompasses a world-wide program utilizing the full-time services of approximately

four thousand professionally qualified recreation specialists.

"I believe the recreation program is the most effective antidote for boredom, maladjustment, and discontent. I believe our program is the commander's most effective tool in the development of stamina, team-work, and the will to win. We use all the resources at our disposal to make this program dynamic, attractive, and a satisfying experience for the young recruit, and, more important, as an essential contributing element in his difficult transition to a good soldier. No one activity is likely to meet the needs or serve the interests of all or even most of them. Each has an appeal, a strong appeal for some of them. For this reason our program is broad in scope, replete with a wide variety of activities. All are important, all are essential! Its worth or profits gained, if one cares to look at it in a cold businesslike manner, can only be measured by the degree of advancement in our society in making a better citizen of the individual servicemen and women."

Join the Safety Campaign

Back citizen action for an attack on traffic accidents! Join the long line of organizations, both national and local, cooperating in a campaign to promote

safety. Call upon other civic groups to help. Excellent suggestions are contained in a special "Back the Attack on Traffic Accidents" issue of *Public Safety* (Volume 49, Number 7), published by the National Safety Council, 425 North Michigan Avenue, Chicago 11.

Skating, Anyone?

The unusually frigid weather in the Middle Atlantic states has resulted in more ice skating than has been possible in that part of the country for several years—and in some special problems for recreation departments. Regular work goes undone while the entire staff answers telephone inquiries about the state of the ice on local ponds.

"Doesn't anyone remember what a red ball means?" asked one harassed staff member, after the hundredth query about the significance of this once-familiar symbol. "I'm going to tell the next person who asks that it means that a dangerous bull is loose!"

A particularly eager taxpayer called one recreation executive at his home at six A.M. to ask whether there was skating that morning. Taking a firm grip on his temper, he replied that the ice was pretty mushy.

"Will there be skating this afternoon?" she asked.

"Not unless the temperature drops."

"Will there be skating tomorrow morning?"

His patience exhausted, the executive snapped, "Madam, the only One Who can answer that question doesn't work for this department!"

Not to be put off, the caller persisted, "Well, what department does he work for?"—M.E.McG., NRA.

Social Welfare Today

Great untapped reservoirs of citizen interest in social welfare are just awaiting discovery in our American communities, declares Sidney Hollander, president of the National Social Welfare Assembly. Speaking at a panel discussion attended by representatives of health, welfare and recreation organizations from many parts of the country, Mr. Hollander said he believed most people were sincerely interested in "making their towns better places to live in," and that young people, older retired people, and employed people with volunteer time to give would be available if they knew where their efforts were really needed.

Two reports of community service projects among students were given: Forty Yale students, working under supervision of a professional social worker, provide all volunteer service for a boys' club in New Haven. At the Uni-

versity of Rochester, former hazing activities have given way to requirements of new fraternity members to give volunteer service in settlement houses.

Introducing the discussion of adapting social welfare program to social change, Ray Johns, general secretary of the Boston YMCA, said the chief characteristics of American life today are pressure for status, restlessness, "uncertainty about the world and the individual's place in it," greater sophistication, and a "tendency toward likeness." Adaptation of social welfare program, he said, involved relocation of bases of service, and changes in nature, auspices and structure of services.

"People think of social welfare as dealing only with economic need," said Mr. Johns. "The public does not realize . . . it is prepared to help people to live rather than just to help them to keep alive."

Family Recreation—

One means by which recreation leaders can help to alleviate a major problem — juvenile delinquency.

Charles A. Bucher



A family starts out across country in Kentucky. In this home good times and companionship happily take the place of parental indifference. The impulse toward youthful waywardness or crime can find no toehold here.

SIX GIRLS between the ages of fourteen and sixteen were arraigned before a juvenile court after having been picked up in a disreputable roadhouse in a large Eastern city recently. Called as a witness in the prosecution of the owner, one of the girls, when asked why she spent so much time in this place of ill-repute, caustically answered, "I wanted to dance, to have a good time, be with my friends. I can't have any fun at home. My mother and father always want me to get out of the house. Where else could I go?"

Juvenile delinquency begins at home. Children's Court Judge George W. Smyth says one-third of the children labeled "delinquent" are from homes disrupted by divorce, desertion or death. The remaining two-thirds are victims of parental indifference, drunkenness, low moral standards, and neurotic behavior. The facts point up the seriousness of this problem: forty-two per cent of the teen-agers would live away from home if the choice were

theirs; one out of every four marriages ends in divorce; three hundred thousand children are involved in divorces each year; there has been a fifty per cent increase in the number of babies born outside of marriage in the last decade; one-fourth of all married women who live with their husbands work to supplement the family income; one out of eight children are not living with both parents.

These home-wrecking statistics indicate the urgent need to re-create the family into a preventive force against youthful waywardness. J. Edgar Hoover feels, "Parents must awaken to the realization that the family is the first great training school in behavior or misbehavior. Children develop a sense of right and wrong—they are not born with it. The home becomes for them their first classroom and parents serve as their first teachers."

The church looks at the problem in much the same way as the law enforcement agency. A nationally famous religious leader blasts irresponsible parents as the chief cause of juvenile delinquency. He places in this classification those fathers too busy making a success of their business and mothers

too wrapped up in their social ambitions to have any time to be with their children. "But God pity those parents," he said, "who bequeath to their children only the memory of a long succession of baby sitters."

National leaders in all walks of life point to family unity as a weapon against delinquency. International opinion also concurs. The first United Nations Congress on Prevention of Crime declared: "Delinquency appears to have had an intimate relationship with the social and cultural changes that have operated through the family. . . . It is vital that prevention efforts be designed to produce closer family ties, to achieve greater affection, emotional security and control through the family. The child needs a sense of belonging."

A major contribution to the solution of the skyrocketing juvenile delinquency problem is clear. Parents must do everything possible to make the family strong, healthy, and happy. And, in order to have cohesiveness, Mom, Pop and the kids must do things as a group. Only as the entire family learns to spend some of their leisure time with each other, and have fun doing it, can family strength be built. In spite of

CHARLES A. BUCHER is professor of education, Department of Physical Education, Health and Recreation, School of Education, New York University.

Foe of Juvenile Delinquency



this, a national survey shows that an estimated fifty-nine per cent of young boys and girls say they never go to the movies, take a drive, or recreate with their families.

Families of American military and civilian personnel stationed abroad have proved the worth of spending some of their free time together. A "we" feeling exists among these fathers, mothers and their children, largely because they play, work and worship as a group. Such practices have resulted in more fun and happiness for all and, in addition, have reduced juvenile delinquency.

Ways to Start

We in America can strengthen the family by learning to do more things together. Try one of the following suggestions in order to get started:

1. Go on an old-fashioned picnic. Pack the hamper with cold chicken, jars of salad, pie and watermelon, bring a bat and ball—ask a neighbor's family to come too. Spend the day out-of-doors, playing, eating and getting better acquainted.

2. Get a block of tickets for the shows that are coming to town—the circus with its animals, clowns and aerial acts; the rodeo that is exciting and will please everyone. And almost every community has its annual Fourth of July

celebration, summer band concert, and Veterans' Day parade.

3. Take an educational tour together. In this historically rich land there's opportunity within easy reach of everyone to visit a famous landmark, historic battlefield, museum, birthplace or monument. Many communities also have art galleries, planetariums, aquariums and zoos. Such a trip will pay social as well as educational dividends.

4. The backyard often has ample space for a badminton court, croquet set, and a place to hang a basketball hoop. Mothers and fathers should get outside and play with their children. They'll probably lose, but the exercise will be good, to say nothing of acting as a spring tonic for family togetherness.

5. Invest in some sleeping bags and camp out overnight. Cook supper in the open, sing around the campfire, and take turns telling a few "spooky" tales. Such an experience will be exciting and long remembered.

6. Become a "do-it-yourself" family. Try such projects as refinishing a piece of furniture, building an outdoor barbecue, recovering a chair, or finishing off the basement playroom. The children may be in the way but they'll feel very proud of the finished project.

7. Take advantage of the many park and forest areas that local, state and national governments maintain. Many parents will be amazed at the number of places available.

8. Have a game night. Dust off the parchesi, checkers, monopoly, or scrabble board. Spend an evening around the dining-room table playing games. Top it off with a special refreshment treat.

9. Take advantage of any musical talent the family members may have. Form a band. Sing together. Even if not blessed with talent, everyone can

enjoy records. Music can do much to bring happiness and contentment.

These are only a few suggestions. There are many more to suit the needs and interests of all. Family recreation can become a regular habit in every home if mothers and fathers will take the initiative in planning. As they become enthusiastic, they will help to spread the family recreation idea throughout the community. Get everyone into the act. Be a pioneer in this great movement. Follow the many communities who are sponsoring family recreation programs. Their schools and recreation centers are opening their doors in the late afternoon, early evening, and on Saturday morning, so that Mom, Pop and all the children can play as a group. Youngsters and oldsters alike are delving into arts and crafts, hobbies, music, dancing, swimming, dramatics, and other activities.

At Levittown, New York, they have a program of "dancing for the family." Last year a "family fun with music" workshop was conducted at the New Rochelle, New York, Guidance Center. A Jewish center in New Jersey, a school of art in Minneapolis, the Michigan public schools, and a recreation center in Kansas City are among those that have either started or are making plans for family recreation programs. The recreation division of your village, town or city, as well as the schools, can motivate such activity and provide the necessary organization, equipment and facilities.

Suggestions to Recreation Departments

A Community or Neighborhood Family Council Organization. Organize as a first step in setting up the necessary machinery. Include mothers, fathers, boys, girls, in-laws, grandparents and



The home is the first great training school in human behavior. Family unity is a major weapon in the fight against juvenile delinquency.

representatives from school and recreation groups. Elect officers. Establish objectives. Inventory family interests, skills and abilities as a basis for planning a program. After studying the situation, take the initiative in starting community family recreation programs. Recommend good television programs, movies, literature, and render any other services which will help promote family fellowship.

Family Clubs. What could be more important for your community than family clubs? If you live in an average United States community, you have men's, boys', girls' and women's clubs. Except for church suppers and an occasional family picnic, these clubs operate for members only. Billy has his over-nite, Mom her afternoon tea, and Pop his clambake; but why not do some of these interesting and exciting things together? A club started by several families can develop much interest and enthusiasm.

Bring Programs to the Home. The family should not, of course, always be expected to use public recreation and school facilities. Recreation must exist in the home, especially where there are small children. Home recreation can be encouraged in many ways. For instance, a lending service, similar to libraries, can be established and a set of tools for leather work, photography equipment, game supplies and other materials made available on a loan basis. Mimeographed game and party bulletins could be distributed.

In bringing the program to the home the position of itinerant recreation leader could also be established. Such a person could spend his or her time visiting families and instructing in various recreation projects.

Promotion. Your community should take an active part in promoting the family program. Mothers and fathers need to be shown the importance and fun of participating. The mayor can proclaim a "Family Recreation Day." Parent-teacher associations, churches, schools and various social agencies can plan family events where everyone is welcome. Adult education classes can instill an interest in those activities that lend themselves to group participation. And why not recreation classes where a whole family can learn to paint, sew, dance, or sing?

School Participation. Schools can help to spearhead the drive for a planned family recreation program. They have teachers skilled in many activities, and facilities such as shops, swimming pools, gymnasiums, and auditoriums.

Facilities and Equipment. When these are planned for your community, the family should be kept in mind. For example, plans for a new swimming pool should include very shallow water for tots, shaded areas for baby's nap, picnic grounds for hungry children and other adequate facilities to make it possible for everyone to participate. When building a new school, plans should include facilities to accommodate neighborhood and family groups in the arts

and crafts shop and other areas of the building. In addition, don't forget the camping site that could be developed with accommodations for young and old.

Leadership. Qualified leadership is essential for a successful program. Recreation leaders should understand the importance of family recreation, the needs and interests of human beings at all ages, their capabilities and limitations, and the procedure for promoting and motivating participation.

Activities cannot be geared too near the adult level. A high degree of skill and perfection may have to be overlooked. Parents will have to be willing to learn to play again where small children are concerned. New experiences should be injected constantly into the program. Events should be scheduled at times when everyone can get together — in the late afternoon, early evening, weekends and holidays.

A gigantic national drive by parents and communities to make family recreation as common as baseball in America can do much to increase the strength of our nation. But, even more important, it will give the home and family a sturdy, solid foundation upon which to build a future.

Let's take our children away from the roadhouses, alleys, streetcorners, poolrooms, and bars and bring them back to the family hearth. Let's leave no question in their minds as to where they can play and have fun. ■

The young family spends the day in a state park. Fine picnic areas are now available in all states, often near at hand.



An IRISH Fair

Patrick J. Heneghan

Irish fun in observance of St. Patrick's Day, March 17.



Naturally, activities from Ireland always include tales peopled with fairies and leprechauns of the Emerald Isle. Above, storyteller James Newman enthralled members of the younger set with his Gaelic anecdotes.

A ONE-HOUR bandshell program grew into a three-day Irish Fair — one with twenty different activities — within a period of five years in Hollywood, Florida. This is a dramatic indication of the tremendous appeal of the St. Patrick theme to local citizens.

Last year's fair included a St. Patrick's Day Parade, a state-wide talent search, the choosing of an Irish Rose of Shannon Queen, an Irish Revue, a Shamrock Golf Tournament, Emerald Pageant, Golden Harp Swim Meet, Shamrock Tennis Tournament, Green Hat Regatta, Teen-Age Come-All-Ye, St. Patrick's Day Ball, a weight-lifting contest called Strong Men of Eire, a major league exhibition baseball game, and a beach pavilion dance.

Close to eight hundred children participated actively in the athletic events; and more than three thousand youngsters marched in the Children's St. Patrick's Day Parade. Police estimates placed the total spectator participation at forty-one thousand for the whole three days.

Because of the phenomenal growth of The Irish Fair, it can no longer be handled in an off-the-cuff, casual manner. The scheduling and timing of the events, selection of qualified judges and officials, handling of publicity, and final staging of events call for detailed precision planning.

The events are selected at least six months prior to the fair by recreation department personnel. Three active citizens, representing various civic and social organizations in the community, are selected as a committee for each of the twenty activities. It is the enthusiasm and ability of these sixty committee members that make a success of the individual activities, therefore they are selected carefully.

MR. HENEGHAN is the recreation director of Hollywood, Florida.

FEBRUARY 1957

When all committees have been formed, an organization meeting is held, where the objectives and purpose of the fair are outlined in detail. An effective innovation used last year was the printing of special Irish Fair stationery, which not only listed all the activities but mentioned all members on the committees. This official recognition of their work was an important morale factor.

After the over-all organization meeting, the committee for each activity received its own schedule for future meetings. Not until one week before the actual fair were all the members brought together for a final meeting. Breaking the fair down into units in this way not only expedited matters, but allowed the small recreation department staff to work more effectively and give professional guidance.

To coordinate all activities, two master control boards were set up in the recreation office. One listed the activities and, every week, showed what had been accomplished and what the objectives were for the coming week. It proved to be an effective way of keeping abreast of the twenty activities and was also a boon to reporters who could come in and pick their stories right off the wall. The other control board was a huge calendar with the actual time of each appointment, conference, meeting, and so on, posted in plain view.

In order to insure the largest participation, every school, civic and social organization in the entire county received a series of letters. The first letter told everyone that the Irish Day Fair was a youth program and stated, in general terms, the purpose of the fair and asked for support. The second, which followed within a few weeks, gave specific ways in which these organizations could participate. The last letter, sent six weeks prior to the actual fair, asked these groups for definite commitments.

As each commitment came in, it was mounted on the control board and released to the newspapers. The amount of fresh, readily available news that this device provided was one of the main reasons that the newspapers were so willing to cooperate and contribute news space to the fair. ■

Left, Kathleen, daughter of the author, reads an Irish story to Dale Allen. Right, Janis Dropkin and Patrick Cromley paste and tape a harp to be used in the fair.



How To Do It! by Frank A. Staples

DECORATIVE PAINTING ON WOOD

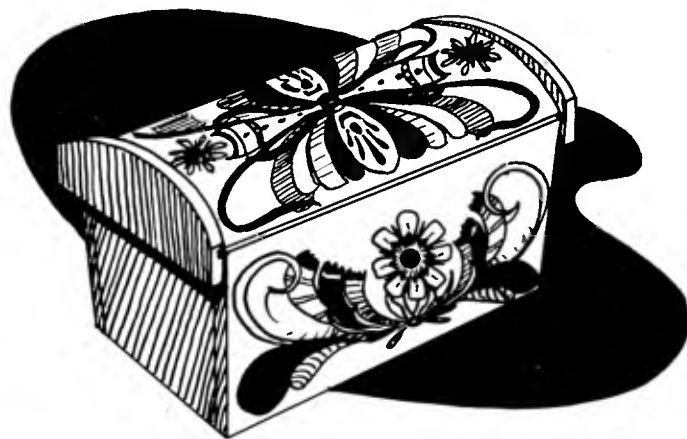

MATERIALS

Show Card Paint - Clear Lacquer - #7 Dupont Rubbing Compound - Johnson's Wax - Red Sable Brushes.

METHOD

1. Remove all paint, varnish, etc. from wood.
Sandpaper all surfaces smooth.
2. Draw design on paper and transfer to wood using carbon paper.
3. Paint design using show card paint.
Note: On softwood use very little water.
4. Cover painted design with coat of clear lacquer.
Note: Flow lacquer on - do not brush it.
Note: Only cover design with first coat.
5. Paint on second coat of clear lacquer.
Note: Cover entire surface.
6. After second coat of lacquer is dry (about 30 minutes) smooth it with #7 Dupont Rubbing Compound.
7. Another coat (or several coats) of clear lacquer may be applied if desirable.
Note: Rub down each lacquer coat to secure a smooth finish.
8. Polish surface with Johnson's wax to get velvety surface.

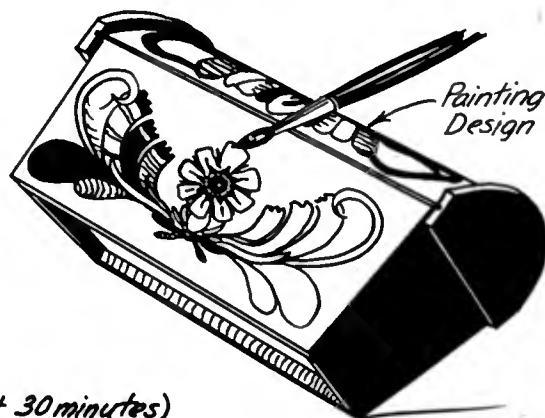
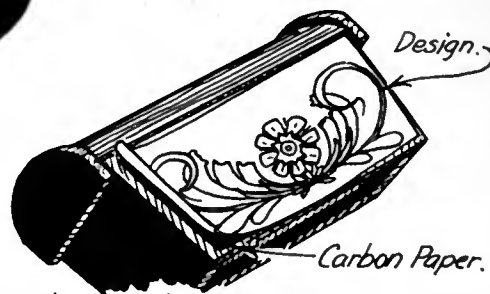

Note: This method of decorating can also be used on metal or glass. Instead of water color paint oil paint should be used. Thinner should be used - $\frac{1}{3}$ sunthickened oil, $\frac{1}{3}$ De Mar Varnish, $\frac{1}{3}$ Turpentine.

For Your February Parties

Saint Valentine, We Love You!

Parties? Of course! Look through back issues of RECREATION, check *Parties For Special Days of the Year* (NRA, 50¢) and the bulletin, *St. Valentine's Day* (MP 61, NRA, 35¢).

Dances? All you need is a theme. The teen-agers or adults can make their own program. How about:

- Buttons and Bows Bounce
- My Heart's On My Sleeve Dance
- Hale and Heart-y Hop
- Sugar Candy—Jim Dandy Dance

Something NEW? Have you tried any of these, either as separate programs or as part of your other plans? *A Share-Your-Heart Party*. An activity to be planned by a club, or class, or department, or troop, or other group for some less fortunate group, such as children in a hospital ward, or an orphanage, or home for the aged, or a detention school. It can include almost *anything*: a valentine for every guest, of course; special "acts" such as an exhibition dance, puppet show, tumbling act, an accordian, guitar or harmonica selec-

tion, an action song, a few simple games selected for the age-group, a solo or duet or trio number, ending with group singing; and, naturally, refreshments. *Valentines For Servicemen and Women*. If you're near any military installation, you surely will be inviting the servicemen and women to any of your special adult parties or dances. But could the youngsters in your department, class, or club "adopt" a corps or squadron, company or regiment, or the men in some isolated station? When they make their valentines, couldn't they choose the best of all to go to our armed forces?

A Community "Pop" Concert—frankly sentimental. Every club, every class, every organization in town votes on its favorite love song—and is responsible for presenting it as a solo, quartette, chorus, or instrumental number, whatever the group wishes at an evening community concert of such songs. Let the audience vote for its favorite by clapping.

A Comic Valentine Contest. Betcha the

newspapers would like this! Whatever happened to those comic valentines we used to see? Our guess is that they got too cruel and too suggestive—but really *amusing* ones are fun to do.

Announce the contest through the papers, and by posters, or keep it in the club or department if you prefer. Arrange a time and place where they can be made. Arrange a method of collecting them. Set a time limit. Get judges. Set *rules*: valentines must be funny, not cruel; must not portray any identifiable person; must be within specified maximum and minimum size limits; and so on.

Then plan an *exhibit* of them—displayed on a long clothesline across the walls of the lounge, or library, or club-room, or even in a downtown window. The judges mark the winners with BIG badges or ribbons—blue for first, white for second, red for third prize. The prizes could be just the ribbons and the honor, or heart-shaped boxes of candy, or very big, fancy valentines for sending to mother or the girl friend.



February 12—Birthdate of Abraham Lincoln

Here's a Bulletin Board idea for announcing your ABRAHAM LINCOLN PARTY.

()	()	()	()	()	()	()	()	()	()	()	()	()	()	()
1	2	3	4	5	6	7	8	9	10	11	12	13	14	
							()	()	()	()	()			
							15	16	17	18	19			

Write the proper letters in the spaces above the proper numbers.

1. If you ever saw a cow jump over the moon write "N" in spaces 1, 4, 6, 16. If not write "A."
2. If "X" comes before "H" in the alphabet write "Z" in space 19. If not write "Y."
3. If you like candy better than mosquitoes write "L" in spaces 8 and 13.
4. If you see double consult an oculist; if not put "R" in spaces 3 and 17.
5. If ten quarts make a pint draw an elephant in space 7, if not put in "M."
6. If summer is warmer than winter put a "B" in space 2.
7. If black and white are opposites, write "P" in space 15, "T" in space 18, and "O" in space 12.
8. If Shakespeare wrote "Twinkle, Twinkle, Little Star" put a "Q" in spaces 10 and 14. If not put in an "N."
9. If 31,467 is more than twelve dozen write "C" in space 11.
10. If "S" comes before "U" in the alphabet write "O" in space 12.
11. If you have ever walked from N.Y.C. to Chicago write the letter "T" in space 9, if not write in "L."
12. If you can run a mile in three minutes write the letter "A" in space 5, if not write in "H."
13. If you plan to come, sign below.



Brighten

That Dark Corner



Somewhere, in the gameroom, lounge, clubroom, office, or in the den at home, there's a dark corner that can be brightened up and made useful. With a little money, some elbow grease and almost no know-how, you can have space for reading, studying, table games, puzzles, sewing and other crafts, or for club meetings, cards, food serving, eating, or just plain conversations. Here's the idea as developed by Mary Frances Sargent, director of the service club at the Granite City Engineer Depot, Granite City, Illinois, for use in her service club. It will work just as well in a recreation building, teen center, golden-age club, church, private agency or home.



GIVEN: A dark corner of a room.

NEEDED: A bright corner that can be used for a writing nook, craft area or other purposes.

SOLUTION: A photomural, curtains to frame it, a long table with shelf space, and some lights.

RESULT: See photograph. Aren't you envious?

The Table

Two redwood boards, twenty inches wide, and eleven feet long. (Pine will cost less, but won't be as handsome or durable.) Two sets of twenty-two-inch wrought-iron legs for the lower board or shelf—handy for books, magazines,

supplies, and what have you. Two sets of six-inch wrought-iron legs for the top board, making it just right for desk or table height. These wrought-iron legs can be purchased at most lumber or hardware stores, and usually come furnished with screws.

Give the boards a good finish by sandpapering and using two coats of clear varnish to bring out the grain. Attach the legs as indicated in the photograph. Voila! A handsome table that will seat six comfortably.

The Wall Behind the Table

A commercial photomural. (A blown-up photograph of your own park in

summer or winter would be even better.) These murals come just like wall paper cut in strips. Anyone who can swing a pastebrush can hang them. This one is in full color, but they come in black and white at less cost.

The wood valance is pine, stained to match the redwood table. Two fluorescent tubes under the valance give indirect lighting for the table, and set off the mural. The drapes are "bargain basement," in white so as not to clash with the mural.

Look at the photograph again, the rush to that dark, wasted corner and get busy! ■

A Survey Leads to Action

Pat Perkinson



YOU'VE just completed an elaborate study of the recreation facilities and needs in your community. What becomes of it now? Is it to be placed importantly on a shelf to look impressive and gather dust? Or is it to find some more dynamic use?

The Richmond, Virginia, Department of Recreation and Parks recently completed such a study and chose the latter alternative in a most dramatic way.

The origin of Richmond's study goes back to one evening in 1952 when a group of teen-agers from North Richmond assembled with neighbors, church, recreation and civic group leaders to discuss their need for better recreation facilities. Out of this movement grew the North Richmond Neighborhood Council, which presented to the city council its studied considerations and recommendations and asked for extension of the recreation program in that section of the city.

Members of the city council were reluctant to take action until similar information on facilities, needs and desires had been obtained from all of the other sections of Richmond. And thus were born the five neighborhood councils—North, East, South, West and Central—to delve into problems of their own neighborhoods and come up with practical suggestions for improving their recreation programs.

To organize and direct these neighborhood councils the city could not have selected a person better qualified than Claire McCarthy, whose name has been synonymous with recreation in Richmond. Miss McCarthy, who serves as secretary to the neighborhood coun-

cils, dedicated herself to this tremendous project, meeting three or four nights weekly for two years with groups in the various sections. Ward Stalnaker, executive secretary of the Richmond Area Community Council at the time, served as consultant.

Through the cooperation of the schools, agencies and officials of the Richmond area, the councils sought information such as:

- Population statistics and pertinent social factors of Richmond.
- Facilities and programs available to Richmond through the recreation and group agencies, private and public, or those which might become available in the future.
- Recreation opportunities available through other sources: schools, churches, commercial enterprise, industry, parks, adult and other informal education, hobby groups.
- How school children use their leisure time, the degree to which they now engage in organized recreation activities, their interests, and their concept of desirable future recreation development.

While the study consultant compiled population and social data, all city students from the fourth grade through senior high school were polled as to their leisure-time activities. When the data had been summarized the study committees analyzed the facts available and visited existing recreation facilities in their respective districts. On the basis of these detailed studies, the various neighborhood councils then drew up recommendations for improvement of recreation programs in their sections.

Results of all five neighborhood studies were digested and presented in a very readable booklet by the department of recreation and parks. The one-hundred-page publication represented a monumental task. And that could

have been the end, were it not in the hands of ingeniously original persons who were anxious to put their story across to as many people as possible in as effective a manner as possible.

Their opportunity came a few months following the publication of the *Richmond Recreation Study*. The occasion was the annual meeting of the department of recreation and parks held in the base of the Carillon War Memorial in beautiful Byrd Park. After a "Dutch treat" luncheon, Richmond's study came to life with a graphic presentation of its highlights.

Among the one hundred and fifty who listened with great interest were not only the members of the neighborhood councils, but also representatives of private and public agencies concerned with recreation and city officials who are responsible for the wise spending of Richmond's funds.

Backdrop for the program was a tremendous outline map of the city surrounded by illustrations of recreation activities, displayed in a frame measuring six and a half by nine feet. Nearby were mounted cutout maps of each of the five sections. As each study committee chairman came forward to report on the facilities and needs of his area, he removed the section map from its board and placed it where it belonged on the outline map of the city. The jigsaw was complete when the five chairmen had completed their reports, and those in the audience could tell at a glance where the present and the proposed facilities are located by referring to a simple key.

To place recreation in its proper perspective, the city manager then discussed the "city dollar" and its division among the several agencies of the municipal government. It was seen that the department of recreation and parks

MRS. PERKINSON is information and communication secretary, Department of Recreation and Parks, Richmond, Virginia.



The audience knew what their city needed . . . Here, Lackey Martin, chairman of the joint neighborhood councils, and Mrs. A. V. Griggs, study chairman for North Richmond, set up master map which formed backdrop for department of recreation and parks '56 meeting in Byrd Park.

program. In addition there were donations of more than \$60,000 in materials and money.

In turn, Jesse A. Reynolds, director of the recreation and parks department, gave the volunteers and others present an idea of how the recreation department makes use of its share of the public funds. Richmond divides the recreation dollar as follows: 17.7 per cent for

receives the smallest allocation of any of the major departments, 3.6 per cent as compared with 22.9 for schools, 13.5 for health and welfare, 14.5 for debt service, 13.8 for safety, and 16.7 for other government operations.

City Manager Horace Edwards praised the work of Richmond's recreation volunteers and noted how it enabled the city to stretch the recreation dollar. He said that nearly 5,000 persons had contributed more than 100,000 man hours to the city's recreation

playgrounds and centers, 16.2 for cemeteries, 10.2 for trees, 8.7 for sports and athletics, 3.9 for city-wide service, 4.5 for administration, and 38.8 for maintenance.

The result of this well-planned and executed program was an inspired and informed audience who knew Richmond's needs in the way of recreation and were willing to do something to make the circles on the map which represented "proposed facilities" become actualities.

Within a few months after this impressive annual meeting at the carillon there occurred a shining example of what such a group can do to promote the cause of recreation in a city. Land adjacent to one of the most crowded playgrounds in a highly populous area of Richmond was put on the market. Even as prospective buyers were visualizing their office buildings on the valuable property, the city's neighborhood councils sprang into action.

Securing the land to extend the playground would mean that the community center so badly needed in North Richmond would temporarily lose its priority, but, by unanimous agreement, the neighborhood council committees rallied to the need of the West Richmond playground. They appeared before the city council, armed with convincing facts from their studies, and saved the land for the extension of the playground. Now they have received the go-ahead from the city council for the North Richmond center—a \$50,000 facility for teen-age activities.

This unified action demonstrates the value of an enlightened public, but it promises to be only the beginning. Richmond's recreation study has come out of the pages of its neat green binder and penetrated the hearts and minds of citizens from all sections of the city who will not rest until their recommendations become realities. ■

OPERATION OUTDOORS

Operation Outdoors, a plan to double camping and picnicking facilities in the national forests within the next five years, has just been announced by the U.S. Department of Agriculture. The five-year recreation plan was released following the President's budget message to Congress which recommended financial support of the project to start this year.

Recreation visits to the national forests will hit the sixty-six million mark by 1962. Forest Service officials predict. Their estimate is based on the past rate of rise in recreation-use of national forests, the growing population, increased time for leisure activities, and the upward swing in money spent for recreation.

Operation Outdoors is a double-barrelled program. First it aims at solving the problem of ever-increasing family outdoor activities such as picnicking and camping in the national forests; a second part will deal with improvement and management of wildlife habitat.

Some 2,150 new camping and picnicking grounds which will accommodate 40,500 additional families at a time are

called for in Operation Outdoors. Tables and fireplaces are to be repaired and sanitary facilities modernized on the 4,900 camp and picnic grounds which now can properly accommodate only 41,400 families. As in the past, it will be left to private capital to provide and operate resorts and other special facilities in the national forests.

"Operation Outdoors is geared not only to correct existing unsatisfactory conditions at national forest recreation areas but also to meet foreseeable use during the next five years," Richard E. McArdle, chief of the Forest Service, said.

Recreation visits to the national forests hit an all-time high of 45,500,000 million in 1955 as compared to 13,200,000 in 1946. About thirty-nine per cent of the people camped and picnicked outside improved areas because existing facilities, largely built by the Civilian Conservation Corps between 1933 and 1941, could not take care of them.

A copy of the report, Operation Outdoors, may be obtained upon request to the Forest Service, U.S. Department of Agriculture, Washington 25, D.C.

Recreation Space *in* Subdivisions

Elbow Room in Subdivisions *

Numerous California communities are feeling the impact of population increases caused by a steady flow of newcomers to the state, by the establishment of many new families, and by the rising birth rate. Thousands of homes are being built in new subdivisions within the cities, in suburban fringe areas, or in semi-isolated rural locations previously used for agriculture.

The public welfare is endangered because land areas are not being set aside for public use in subdivisions, especially for park and recreation purposes. In some instances public school sites, secured because school districts do have mandatory and tax power for educating children who live in the subdivisions, are deemed sufficient for recreation purposes.

This is a compromise which disregards the needs of children and adults for recreation other than the activities and sports which are appropriate to school athletic fields. Parks and green belts which people might use for family picnics, riding and hiking trails, day camping and nature exploration are lacking. Suitable sites in subdivisions are not being provided for community recreation buildings where youth and adults can participate in social activities, arts and crafts, drama and music, and club activities.

In 1949-50 the state recreation commission reported on the unusual approach to the problem of acquiring land for recreation and park areas by two cities, Claremont and Whittier. These cities require subdividers to pay a fee of \$30 per lot and \$50 dollars per acre, respectively. The fees are deposited in special funds to be used for the acquisition of park and recreation areas for the people of the subdivision.

In 1955, the commission learned that other communities are adopting similar methods. Anaheim, Arcadia, Azusa, Corona, Fullerton, Monterey Park, Orange and San Gabriel have passed or amended subdivision ordinances to include sections which require the subdivider to pay to the city a sum of \$25 per residence lot for like purpose.

* From the 1954-1955 *Annual Report of the California Recreation Commission.*

Fontana requires a \$10 fee per lot; La Verne requires a \$50 fee per lot. A \$100 fee per net acre (exclusive of streets and highways) is required in Modesto and in Torrance. Merced requires a \$100 fee per gross acre and Yuba City levies \$62.50 per acre. In Davis the subdivider pays \$12.50 per lot for recreation areas before the subdivision map is approved and \$12.50 per lot when the building permit is issued, and also for all new construction throughout the city. In multi-family development an additional \$10 is charged per unit. Santa Clara and Napa levy \$20 and \$15, respectively, for each residential unit.

In some instances the cities permit the subdivider to dedicate land to the city for recreation and park purposes in lieu of payment of money. Stockton requires that one acre or portion thereof be conveyed to the city by the subdivider for each one hundred families or portion thereof in the subdivision. In lieu of land, the subdivider must contribute the equivalent value to be used for acquisition of recreation and park areas. Land reservation for parks, playgrounds, school sites or other public uses required on a regional basis to serve an area greater than that encompassed by the subdivision must be reserved as such for a period of at least one year after approval of the subdivision map.

Livermore's subdivision ordinance requires that a sum of money equal to the aggregate total amount ascertained by multiplying the number of acres (exclusive of public streets and highways) by \$250 shall be paid to a city fund designated as the park and recreation facilities fund. Land may be dedicated in lieu of payment of fees.

A difficulty sometimes encountered when a subdivider offers land in lieu of cash is the unsuitability of the site for recreation and park purposes. In some instances areas offered were marginal in location, were on steep rocky terrain, or marked by deep gullies. The planning commission of Marin County has developed a formula for reservation of park and recreation sites in county subdivisions, wherein such land areas are increased proportionately in acreage in relation to the degree of grade in the hill sections.

Eureka, National City and Santa Barbara have been re-

vising their subdivision ordinances. Subdivision ordinances in Arcata, Lompoc, Oakland, Sacramento and San Luis Obispo carry clauses which provide that the planning commission may suggest to the subdivider the advisability of dedicating suitable areas for parks and recreation facilities, or that due consideration be given to the allocation of suitable areas for parks and playgrounds to be dedicated or reserved for public use.

Some ordinances provide that this allocation of land shall be in accordance with a city master plan. Officials in one city reported that these permissive clauses in ordinances had not been at all effective in establishing recreation areas and had not functioned as a force to create open space in the city. Another city reported that, in actual practice, there was no compliance with the clause.

Long Beach does not require dedication of areas for parks and playgrounds, but officials state that subdividers and community developers are usually requested to reserve for future purchase, or dedicate free of cost to the city, park and recreation areas substantially in accordance with the comprehensive plan for these facilities. Several park and recreation areas have been secured from developers without cost. In other instances, certain areas have been set aside for future acquisition by the city.

Importance of Providing Space

The importance of providing recreation space in connection with new residential neighborhoods is pointed out in *Control of Land Subdivision*, a booklet issued by the New York State Department of Commerce. Among the require-

ments for approval of plats by a planning board is one "that a park or parks suitably located and of reasonable size for playground and other recreation purposes be provided in the development layout."

A set of subdivision regulations contains the following provision under "General Requirements for the Subdivision of Land":

Areas for parks and playgrounds shall be of reasonable size for neighborhood playgrounds or other recreation uses. No arbitrary percentage of area shall be insisted upon by the board, but, in general, developers should set aside not less than ten per cent of the area for these purposes.

A sample set of "Subdivision Regulations for Planning Boards" includes, under "Design Standards":

1. Where a proposed park, playground, school or other public use shown in a master plan is located in whole or in part in a subdivision, the planning board may require the dedication or reservation of such area within the subdivision in those cases in which the planning board deems such requirements to be reasonable.

2. Where deemed essential by the planning board, upon consideration of the particular type of development proposed in the subdivision, especially in large-scale neighborhood unit developments not anticipated in the master plan, the planning board may require the dedication or reservation of such other areas or sites of a character, extent, and location suitable to the needs created by such development for schools, parks, and other neighborhood purposes.

County Planning Board Requires Bond

In a report on Burlington County, New Jersey, June 27, 1955, J. W. Faust reported a conference with George M. Rogers, executive of the county planning board. He states: "This board requires a bond from each developer and can hold up a development plan that is unsatisfactory. . . . In one instance they persuaded a developer, instead of filling in fifteen to twenty acres of low land and a lake, to leave the lake with five acres around it as a park and develop the rest."

Your Program Calendar

What ARE You Planning For THIS Month?

FEBRUARY

- 1 Victor Herbert's Birthday
- National Freedom Day
- 2 Ground Hog Day
- 6 - 12 Boy Scout Week
- 11 Thomas Edison's Birthday

FEBRUARY

- 12 - 22 National Defense Week
- 12 Abraham Lincoln's Birthday
- 14 Valentine's Day
- 17 - 24 Brotherhood Week
- 22 George Washington's Birthday



What CAN You Plan For NEXT Month?

MARCH

- 2 - 9 National 4-H Club Week
- 3 Alexander Graham Bell's Birthday
- 3 - 9 National Peanut Week
- 4 President's Day
- 4 - 9 National Smile Week
- 5 Mardi Gras (Shrove Tuesday)
- 10 - 16 Girl Scout Week

MARCH

- 15 Andrew Jackson's Birthday
- 15 - 22 Jewish Youth Week
- 17 St. Patrick's Day
- 17 - 23 National Wildlife Week
- 17 - 24 Camp Fire Girls Birthday Week
- 24 - 30 International Photography Week



Per Capita Expenditures for RECREATION and PARKS in 1955

Muriel E. McGann

THE RECENT publication of the 1956 *Recreation and Park Yearbook* makes possible, for the first time in five years, a study of the per capita recreation and park expenditures of the reporting cities. Since this is the second *Yearbook* in which all expenditures for recreation and parks are recorded, rather than those for recreation alone, it also is possible to compare the total expenditures figures with those recorded in 1950.

Only the cities reporting employment of full-time year-round recreation

leadership have been included in the tabulations. Figures are based on current operating expenses alone; money spent for capital items is not included. A few communities reporting full-time leadership could not be included because they did not report the amount of money spent in 1955, or because they are not incorporated municipalities and population figures could not be secured.

Population figures used in the study are local estimates (which usually tend to be high) except in the very few cases where a local census has been taken

since 1950, or where no population figures were given on the report form; in the latter case, 1950 census figures have been used. Many cities known to have more than one recreation or park agency were represented by only one agency in the *Yearbook*, in spite of repeated efforts to secure reports from the others; the expenditure figure recorded for such cities is, of course, less than the amount actually spent. Therefore, the per capita total expenditures figures shown in the following tables are undoubtedly low in some cases.

• TABLE I shows the range of per capita expenditures, by population groups, in the 908 cities included in the study. The average and median figures also are shown for each group; because it is less subject to distortion by a few very high or very low figures, the median probably is more truly representative of the group than the average. The average per capita for all 908 cities is \$2.58; the median is \$2.37.

The table shows a new trend toward higher expenditures in the larger cities; the three groups of cities with population of over 50,000 spent more per capita than the three groups between 5,000 and 50,000. It is also worthy of note that forty-six cities, five per cent of those reporting, spent six dollars or more per capita. (In the opinion of the National Recreation Association, any city wishing to provide adequate facilities

and program will find it necessary to spend this amount.)

The fact that 908 cities were included in the study, an increase of one hundred and twenty-five per cent over 1950, appears to indicate that although per capita spending is not, on the whole, keeping pace with population growth, many more cities are now employing full-time year-round recreation leadership.

Table I—TOTAL EXPENDITURES

Population Group	Number of Cities	Average Per Capita	Median	Number of Cities with Per Capita Expenditure of								
				Under \$0.50	\$0.50 to \$0.99	\$1.00 to \$1.49	\$1.50 to \$1.99	\$2.00 to \$2.99	\$3.00 to \$3.99	\$4.00 to \$4.99	\$5.00 to \$5.99	\$6.00 and Over
Under 5,000	49	\$5.18	\$3.09	—	2	5	5	11	7	3	3	13
5,000 - 9,999	96	\$2.79	\$2.09	3	7	15	21	22	10	8	3	7
10,000 - 24,999	296	\$2.24	\$1.91	7	45	56	49	81	32	13	6	7
25,000 - 49,999	216	\$2.07	\$1.71	11	36	36	43	54	20	11	1	4
50,000 - 99,999	136	\$2.69	\$2.74	5	16	17	22	32	19	9	8	8
100,000 - 249,999	70	\$2.88	\$2.75	3	5	7	8	17	12	10	4	4
250,000 and over	45	\$3.26	\$3.05	1	—	3	6	11	11	8	2	3
Total.....	908	\$2.58	\$2.37	30	111	139	154	228	111	62	27	46

• TABLE II shows per capita expenditures for leadership salaries and wages in the 787 cities which reported full-time year-round leadership, the amount

of money spent for leadership, and their population. Although many cities that employed leaders failed to respond to all requests for a *Yearbook* report, replies were received from virtually all the agencies employing leaders in these 787 cities; figures shown are therefore substantially correct for cities covered.

The growing recognition of the importance of leadership is emphasized in this table. In 1950, only seventeen per cent of the reporting cities spent \$1.00 or more per capita for leadership; in 1955, at least \$1.00 was spent by thirty-six per cent of the cities. The NRA standard of \$1.50 per capita was met

MRS. MCGANN, a member of the NRA staff, is associate editor of the 1956 *Yearbook*.

by 112 cities, fourteen per cent of those reporting.

Larger cities have stepped up their

expenditures for leadership, as well as their total expenditures. Five years ago, no city over fifty thousand reported

spending more than \$1.49 per capita for leadership; in 1955, sixteen cities over fifty thousand spent more.

Table II—LEADERSHIP EXPENDITURES

Population Group	Number of Cities	Average Per Capita	Median	Number of Cities with Per Capita Expenditure of						
				Under \$.25	\$.25 to \$.49	\$.50 to \$.74	\$.75 to \$.99	\$ 1.00 to \$ 1.49	\$ 1.50 to \$ 1.99	\$ 2.00 and Over
Under 5,000	38	\$2.65	\$1.80	1	—	—	5	8	7	17
5,000 - 9,999	77	\$1.10	\$1.16	1	3	10	13	26	12	12
10,000 - 24,999	253	\$.97	\$.88	4	37	54	61	63	20	14
25,000 - 49,999	189	\$.83	\$.72	5	36	55	44	35	8	6
50,000 - 99,999	123	\$.80	\$.59	8	29	28	24	25	6	3
100,000 - 249,999	63	\$.71	\$.62	6	16	15	14	8	3	1
250,000 and over	44	\$.73	\$.69	3	11	12	8	7	3	—
Total.....	787	\$1.00	\$.82	28	132	174	169	172	59	53

• TABLE III shows clearly that, while cities over fifty thousand in population have increased their per capita expenditures for recreation and parks substantially in the past five years, increases in recreation appropriations in the smaller cities have not been commensurate with population growth. The average total per capita expenditure for all the cities reporting full-time year-round leadership dropped from \$2.70 to \$2.58, a decrease of four per cent, in the five years between 1950 and 1955.

Leadership expenditures, on the other hand, increased more than thirty per cent in all population groups ex-

cept the 5,000 to 9,999 bracket. The average expenditure of \$1.00 per cap-

ita for leadership represents a net increase of forty-seven per cent.

Table III—PER CAPITA EXPENDITURES, 1950 AND 1955

Population Group	Average Total Expenditure			Average Leadership Expenditure		
	1950	1955	Per Cent of Change	1950	1955	Per Cent of Change
Under 5,000	\$6.30	\$5.18	-18	\$1.90	\$2.65	+39
5,000 - 9,999	\$3.37	\$2.79	-14	\$1.09	\$1.10	+1
10,000 - 24,999	\$2.78	\$2.24	-19	\$.74	\$.97	+31
25,000 - 49,999	\$2.19	\$2.07	-5	\$.63	\$.83	+32
50,000 - 99,999	\$2.34	\$2.69	+15	\$.55	\$.80	+45
100,000 - 249,999	\$2.40	\$2.88	+20	\$.48	\$.71	+48
250,000 and over	\$2.64	\$3.26	+23	\$.51	\$.73	+43
Total.....	\$2.70	\$2.58	-4	\$.68	\$1.00	+47

• TABLE IV shows a geographical breakdown of per capita expenditures for all current operating expenses and for leadership. The districts shown are NRA field service districts, and the states are apportioned as follows:

New England: Connecticut, Maine, Massachusetts, New Hampshire, Rhode Island, Vermont.

Middle Atlantic: Delaware, District of Columbia, Maryland, New Jersey, New York,

Pennsylvania.

Great Lakes: Illinois, Indiana, Michigan, Minnesota, Ohio, Wisconsin.

Midwest: Colorado, Iowa, Kansas, Missouri, Nebraska, North Dakota, South Dakota, Wyoming.

Southern: Alabama, Florida, Georgia, Kentucky, Mississippi, North Carolina, South Carolina, Tennessee, Virginia, West Virginia.

Southwest: Arkansas, Louisiana, New Mexico, Oklahoma, Texas.

Pacific Southwest: Arizona, California, Nevada, Utah.

Pacific Northwest: Idaho, Montana, Oregon,

Washington.

Average and median per capita expenditures for current operating expenses and for leadership were highest in the Pacific Southwest district. Sixteen, or twelve per cent, of the reporting cities in this district met the NRA total expenditures standard; twenty-nine, or twenty-seven per cent, the leadership standard. ■

Table IV—PER CAPITA EXPENDITURES, BY DISTRICTS

District	Total Expenditures			Leadership Salaries and Wages			Number of Cities Meeting NRA Standard	
	Number of Cities	Average Per Capita	Median	Number of Cities	Average Per Capita	Median	Total Expenditures	Leadership
New England	95	\$2.71	\$2.00	87	\$1.10	\$.82	5	14
Middle Atlantic	182	\$2.11	\$1.66	160	\$1.01	\$.86	4	20
Great Lakes	206	\$2.76	\$2.29	172	\$.93	\$.80	11	24
Midwest	61	\$2.53	\$2.58	59	\$.67	\$.60	—	1
Southern	172	\$2.45	\$1.85	145	\$1.04	\$.87	8	20
Southwest	41	\$1.44	\$1.62	32	\$.52	\$.48	—	—
Pacific Southwest	124	\$3.39	\$2.92	107	\$1.29	\$1.10	16	29
Pacific Northwest	27	\$2.48	\$2.18	25	\$.93	\$.75	2	4

P E R S O N N E L

Recreation Personnel Review—1956

W. C. Sutherland

Each year seems to bring increased activity and new developments in the field of recreation personnel. 1956 was no exception.

Placements in the various classifications remained strong, but were especially conspicuous at the executive level. One hundred and two positions for superintendents of recreation and/or parks were filled, the largest number in NRA history. The majority of these were in the Middle Atlantic and Great Lakes districts. However, the number of executive placements in the South, Midwest and Far West also increased.

As in former years, a high percentage of the executive placements were in medium-size and small communities. For instance, of the executive placements 37 per cent was in communities of 10,000 population and under, 49 per cent in cities of 15,000 and under; 58 per cent in cities of 25,000 and under, and 93 per cent in cities of 50,000 population or less. In other words, only seven per cent of the executive placement was in the larger communities of 50,000 population and over.

The salary range for the executive positions filled was \$4,000 to \$10,000, with a \$5,000 median.

The NRA National Internship Program began in 1956 with professional students in training in four municipal recreation departments: Philadelphia, Pennsylvania; Milwaukee, Wisconsin; Portland, Oregon; and Oakland, California. Additional interns are serving in state mental hospitals in Indiana.

The first Institute on Recreation Administration was conducted in conjunction with the International Recreation Congress in Philadelphia. Plans are under way for a second one at the 1957 Congress scheduled for Long Beach,

California. An institute for top-ranking executives seems destined to become a permanent Congress feature.

An NRA personnel study, *Personnel Standards in Community Recreation Leadership*,* which first appeared in 1930 and has undergone several revisions, has been brought up-to-date and made available once again with the assistance of the National Advisory Committee on Recruitment, Training and Placement. This committee is also assisting in the preparation of the September 1957 issue of the Academy of Political and Social Science *Annals*. This issue of *Annals*, devoted entirely to recreation, will be an 80,000-word volume edited by Dr. Paul F. Douglass.

The recreation movement continues to face a serious problem of personnel shortage. This is particularly true in respect to qualified workers for beginning positions. The demand for professional recreation personnel continues to increase while the number of qualified workers is by no means keeping pace.

Several additional states have appointed recruiting committees as a part of their state recreation society activities, and this new development should help. However, the terrific competition for the employment of college graduates is expected to continue, making it imperative that all recreation agencies, professional workers and friends of the recreation movement do everything possible to attract new prospects to the professional training centers and into the movement.

National and district conferences, and many of the state meetings, emphasized and featured personnel activities last year with much attention focused on recruiting. Much more can

and should be done as the recreation movement moves forward and as the recreation profession endeavors to make a respected place for itself among the great professions of our time.

Only great leadership can make a great profession, and a worthy goal for professional recreation workers and agencies should be to make great leadership the heritage and tradition of the recreation field.

Recruiting, wise selection, and the development of leaders should continue to receive the best efforts of all those presently concerned with recreation. We cannot escape the fact that whatever success or greatness recreation achieves will be in direct proportion to the extent that our leaders distinguish themselves as scholars, as masters in the skills of the profession, and in the art of leadership. ■

WANTED: ONE LANDSCAPE ARCHITECT.

Year-round position, will be paid \$345 per month and also will be permitted to do landscape work on the side. Write to A. C. Hamilton, Director of Parks & Recreation, City Hall, Lubbock, Texas.

CALIFORNIA offers you

attractive opportunities to participate in an expanding rehabilitation program in its State Mental Hospitals.

IMMEDIATE EMPLOYMENT

For

College trained Recreation Therapists
Registered Occupational Therapists
College trained Music Therapists

Salaries start at \$4,296; good promotional opportunities; 3 weeks' paid vacation annually; retirement annuities and other employee benefits.

Write State Personnel Board

801 Capitol Avenue, Sacramento, California

MR. SUTHERLAND is director of the NRA Recreation Personnel Service.

* Available from Recreation Book Center, 8 West Eighth Street, New York 11. (RBC #415A) \$2.00.

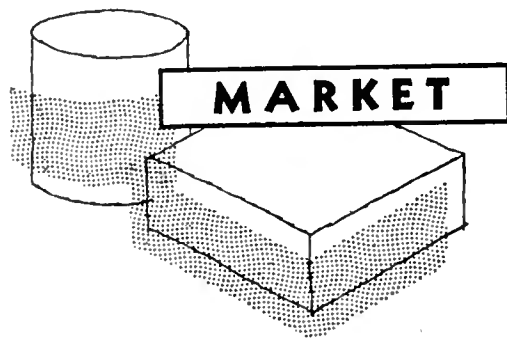

NEWS

If you are interested in any of these products, write directly to the manufacturer at the address given. PLEASE mention that you read about it on RECREATION magazine's Market News page.

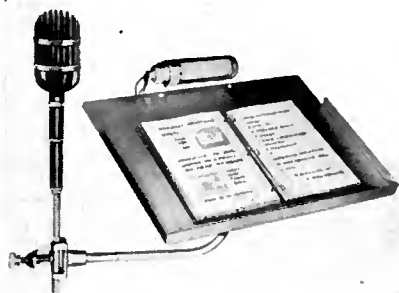

◆ A new, convenient portable speaker's stand called the Speakeasy is designed to fit any microphone stand. It is lightweight, all-aluminum and provides a complete, adaptable speaker's lectern. Double-page platform surface measures

nineteen by thirteen inches and is flanged at both sides and bottom to prevent speaker's notebooks or pages falling off. Platform is adjustable up or down, and swings in a 360-degree arc. Its counterbalanced construction eliminates any tipping hazard. George Reuter Organization, 450 East Ohio Street, Chicago 11.

◆ A new series of inexpensive Eraso posters and charts (with patented ERASO* "Write it on—Wipe it off" finish), designed for simple and economical planning, scheduling and promotion of all athletic and recreation activities are guaranteed reusable over one hundred and fifty times with normal care. The attractive promotion posters, fourteen by twenty-two inches, are available in combinations of five bright colors. Program planning and administration aids have been broadened by the addition of large (twenty-four by thirty-six inches) bulletin board, all-purpose and round-robin charts. The latter, available for either eight or twelve team tournaments, simplify a normally complicated and tedious job. They completely schedule teams, date, time, place, officials, in a matter of minutes.

A free colorful catalog, illustrating these and many other new program aids, may be obtained by writing the Program Aids Company, 550 Fifth Avenue, New York 36.

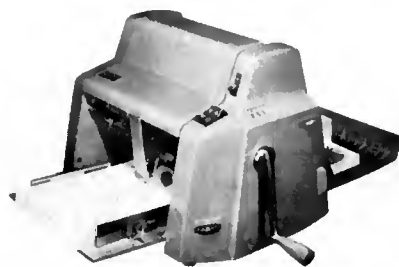

◆ A new mimeograph, the BDC Rex-Rotary M-4, operates as a printing press for stencils. The customary perforated drum and liquid ink have been replaced by two cylinders, an oscillating ink roller and heavy

printers ink. This basic new design eliminates leaking ink, clogged drums, ink pads, inking with a brush, blurry copies.

It is simple to operate and features three-minute color change, accurate registration, automatic cut-off counter, three-day copy adjustment, automatic feed for any weight

paper from tissue to cardboard, from post card to legal size. The M-4 is available in both electric and hand operated models. Bohn Duplicator Corporation, 444 Fourth Avenue, New York 16.

◆ Topl-Takl, developed from old English pub games, offers youngsters chance-and-skill table games based on such real sports as hockey and football. Of hardwood and finely finished, Topl-Takl games are sturdy, well-constructed, can take rough treatment. The W. D. Griffin Company, 5927 Euclid Avenue, Cleveland 3.



◆ With the new Lam Lantern String, effective lighting for outdoor living areas can now be put up with as little effort as a simple clothesline. The String is a three-lantern system, on thirty feet of rubber-covered cord, designed for all-weather

use. It features lantern shades formed from Eastman Tenite butyrate plastic, especially selected for its good weathering properties and impact strength. With its special hangers, the system can be attached quickly to trees, roofs or wires, then plugged to the nearest outlet. Translucent shades, eleven inches in diameter, shed soft, glareless light over a wide area.

When more than three lanterns are desired, two or more of the Lam Lantern Strings can be plugged together in a continuous chain. Lam Workshop Inc., 404 Main Street, Wakefield, Massachusetts.



◆ Vend-a-Frank, a new hot-dog dispensing machine, is a natural adjunct to soft-drink, ice-cream, and hot-coffee vendors. The machine is filled and operated much like a cigarette vendor, employs National slug-rejector and change maker. Upon insertion of coin, a hot dog is cooked electrically and served in its own sanitary box, all in twenty seconds. The Vend-a-Frank has a capacity of eighty-four frankfurters in vending position and seventy in storage position, both compartments under refrigeration at all times. United States Vending Machine Corporation, 4300 North Carlisle Street, Philadelphia 40.

TWO OUTSTANDING McGraw-Hill GUIDES

for

Recreation Leaders and Teachers

by

RICHARD KRAUS

Teachers College, Columbia University

1. A brief volume designed to help recreation workers with children from six to twelve . . .

PLAY ACTIVITIES FOR CHILDREN

A Guide for Teachers, Parents, and Recreation Leaders

- Ready for summertime use -

This new book of timely interest describes the underlying values of youthful play, and gives examples of successful play programs. It gives many specifically helpful suggestions and guides for working with groups of children as well as clearly-written directions for a wide variety of activities including active and inactive games; musical play and singing; folk and creative dancing; arts and crafts; and dramatics. Recent advances on play programs and up-to-date material on childhood growth and development are included. The book is unique in its variety and scope.

2. A distinctive text emphasizing leadership skills in social recreation . . .

RECREATION LEADER'S HANDBOOK

McGraw-Hill Series in Health Education, Physical Education, and Recreation

312 pages - \$5.75

This outstanding work provides a practical, down-to-earth discussion of social leadership objectives and techniques applied to the recreation needs of groups of all sizes and ages. It covers the background of social recreation in this country, the role of recreation in everyday life, leadership objectives and techniques in working with recreation groups, and a wide variety of time-tested acceptable materials. There is an extensive treatment of program planning to meet the needs of different types of groups.

USE THIS COUPON

COLLEGE DEPARTMENT, MCGRAW-HILL BOOK COMPANY, Inc.
330 West 42nd Street, New York 36, N.Y.

Please send me, on approval, a copy of the book(s) checked below. I agree to pay for the book(s) upon receipt of invoice or return the book(s) within 10 days.

- PLAY ACTIVITIES FOR CHILDREN (available in June, 1957)
 RECREATION LEADER'S HANDBOOK

Name.....
Address.....
City..... Zone..... State.....
Title.....
Affiliation..... R257

McGraw-Hill BOOK COMPANY, INC.

330 West 42nd Street, New York 36, N.Y.

Superior By Every Comparison!



So sensationally better are they on every count—design, construction, quality, durability and play-ability—that Rawlings HERCULITE Rubber-Covered Athletic Balls have established a new high standard. They're in a class by themselves—they're...

"The Finest In The Field!"

- VOLLEY BALLS • BASKETBALLS
- SOCCER BALLS • FOOTBALLS

RAWLINGS SPORTING GOODS CO. • St. Louis • Los Angeles • Dallas • Chicago

RECREATION DIRECTORS

MALE AND FEMALE

Needed by the

CITY OF LOS ANGELES

to organize and supervise activities at City recreation centers.

\$375 to \$464 Month

Interesting, challenging work for college graduates with major in Physical Education or Recreation.

SECURE CAREERS—ALL CIVIL SERVICE BENEFITS

Write Room 5, City Hall
Los Angeles 12

MI-5211

1956

RECREATION and PARK YEARBOOK

A Nation-wide Inventory of the Public Recreation and Park Services of Local, County, State and Federal Agencies for the Year Ending December 31, 1955.

\$2.00

National Recreation Association
8 West Eighth Street, New York 11, N.Y.

Books & Pamphlets Received

- ALL ABOUT BICYCLES, Dorothy Healey. Comet Press Books, 200 Varick Street, New York 14. Unpaged. \$2.00.
- AMERICAN MOUNTAIN SONGS, compiled by Ethel Park Richardson (edited and arranged by Sigmund Spaeth). Greenberg: Publisher, 201 East 57th Street, New York 22. Pp. 120. \$3.50.
- ARCHERY, Howard Wiseman and Fred Brundle. Dover Publications, 920 Broadway, New York 10. Pp. 112. \$.65.
- BABE RUTH LEAGUE RULES AND REGULATIONS—1957. Babe Ruth League, 524½ Hamilton Avenue, Trenton, New Jersey. Pp. 28. Free.
- CHILD WHO IS MENTALLY RETARDED, THE. Superintendent of Documents, U. S. Government Printing Office, Washington 25, D. C. Pp. 22. \$.10.
- COMMUNICATION THROUGH REPORTS, Paul Douglass. Prentice Hall, Englewood Cliffs, New Jersey. Pp. 410. \$5.95.
- COMPLEAT CRUISER, THE — The Art, Practice and Enjoyment of Boating. L. Francis Herreshoff. Sheridan House, 257 Fourth Avenue, New York 10. Pp. 372. \$5.00.
- COMPLETE BOOK OF PET CARE, THE, Howard J. Lewis. Random House, 457 Madison Avenue, New York 22. Pp. 144. \$2.95.
- COMPLETE GUIDE TO BETTER BOWLING, THE, Howard J. Lewis, Editor. Random House, 457 Madison Avenue, New York 22. Pp. 144. \$2.95.
- DINGHY SAILING FOR BOYS—OR GIRLS, Geoffrey Nightingale. John de Graff, 31 East 10th Street, New York 3. Pp. 120. \$2.50.
- DYNAMICS OF AGING, THE, Ethel Sabin Smith. W. W. Norton & Company, 55 Fifth Avenue, New York 3. Pp. 191. \$3.50.
- FOLK DANCE GUIDE (Seventh Annual Edition 1957), Paul Schwartz. Editor. P. O. Box 342, Cooper Station,

- New York 3. Pp. 26. Paper \$1.00.
- GOLFERS OWN BOOK, THE, Dave Stanley and George G. Ross, Editors. Lantern Press, 257 Fourth Avenue, New York 10. Pp. 342. \$4.95.
- HOW TO BUILD MODEL RAILROADS AND EQUIPMENT, Barton K. Davis. Crown Publishers, 419 Fourth Avenue, New York 16. Pp. 191. \$3.95.
- HOW TO TAKE BETTER HOME MOVIES, Peter Gowland. Fawcett Publications, Greenwich, Connecticut. Pp. 144. Paper \$.75 (plus \$.10 for mailing).
- LOCAL PLANNING AND ZONING. Department of Commerce, 112 State Street. Albany, New York. Pp. 89. Free.
- MATHEMATICS MAGIC AND MYSTERY, Martin Gardner. Dover Publications, 920 Broadway, New York 10. Pp. 176. Paper \$1.00.
- PEOPLE TAKE THE LEAD, THE. (A record of progress in civil rights, 1948 to 1957.) American Jewish Committee, 386 Fourth Avenue, New York 16. Pp. 38. \$15.
- PHYSICAL EDUCATION: STUDENT AND BEGINNING TEACHING, Clyde Knapp and Ann E. Jewett. McGraw-Hill Book Company, 330 West 42nd Street, New York 36. Pp. 303. \$4.75.
- PLANNING FACILITIES FOR HEALTH, PHYSICAL EDUCATION AND RECREATION (Revised Edition). The Athletic Institute, 209 South State Street, Chicago 4. Pp. 154. Paper \$2.50.
- PLAYBOOK FOR SMALL FRY, Marion Jollison. Hart Publishing Company, 74 Fifth Avenue, New York 11. Pp. 127. Paper \$1.00.
- PLAYMAKING WITH CHILDREN (Second Edition). Winifred Ward. Appleton-Century-Crofts, 35 West 32nd Street, New York 1, New York. Pp. 341. \$3.50.
- PLAYS FOR CHILDREN. Children's Theatre Press, Anchorage, Kentucky. Pp. 83. \$10.
- RECREATION AND THE LOCAL CHURCH, Frances Clemens, Robert Tully, Edward Crill, Editors. Brethren Publishing House, Elgin, Illinois. Pp. 191. \$2.75.
- RIDDLES OF MANY LANDS, Carl Withers and Sula Benet. Abelard-Schuman, Inc., 404 Fourth Avenue, New York 16. Pp. 160. \$2.75.
- SKIING ILLUSTRATED—A Guide for the Young Skier. John and Frankie O'Rear. A. S. Barnes and Company, 232 Madison Avenue, New York 16. Pp. 96. \$3.00.
- SOCIAL WELFARE FORUM, THE, 1956. Columbia University Press, 2960 Broadway, New York 27. Pp. 273. \$5.00.
- SPORTS ATLAS OF AMERICA, E. L. Jordan. C. S. Hammond & Company, Maplewood, New Jersey. Pp. 63. \$2.95.

- STUDY OF ADOLESCENT BOYS, A. National Council, Boy Scouts of America. New Brunswick, New Jersey. Pp. 183. Paper \$2.00.
- TEEN-AGERS AND ALCOHOL—A Handbook for the Educator, Raymond G. McCarthy. Yale Center of Alcohol Studies, 52 Hillhouse Avenue, New Haven, Connecticut. Pp. 188. \$4.00.
- THEATRE SCENECRAFT, Vern Adix. Children's Theatre Press, Anchorage, Kentucky. Pp. 309. \$6.50.
- THIS IS THE WAY WE WRAP OUR GIFTS. Dennison Manufacturing Company, Framingham, Massachusetts. Pp. 23. \$.25.
- WHAT MAKES A GOOD HOME, Anna W. M. Wolf and Margaret C. Dawson. Child Study Association of America, 132 East 74th Street, New York 21. Pp. 35. \$40.
- WIN AT CHECKERS, Millard Hopper. Dover Publications, 920 Broadway, New York 10. Pp. 109. \$1.00.

Magazine Articles

- CAMPING MAGAZINE, *December 1956*
Better Camping Through Better Administration. *Fred V. Rogers.*
Your Responsibilities in Training Camp Leaders. *Marvin Rife.*
- CHILD STUDY, *Winter 1956-57*
Books of the Year for Children.
- JOURNAL OF HEALTH, PHYSICAL EDUCATION, RECREATION, *December 1956*
Organizing Our Campus Recreation Program. *Doris A. Meek.*
Prepare for Retirement. *Ralph M. Grawunder.*
Take Care of Your Athletic Equipment. *Keneth G. Baldwin.*
- NEA JOURNAL, *December 1956*
A Child in Today's World. *Dorothy W. Baruch.*
—, *January 1957*
Books that Enchant. *Frances Clarke Sayers.*
The Child's the Thing. *Emily Hill.*
- PARKS & RECREATION, *November 1956*
City-School Cooperation Pays Off. *Walter J. Barrows.*
Day Camping—Door to the Out-of-Doors. *Bonita L. Voss.*
Put Your Winter Problems on Ice. *John A. Heinzelman.*
- SCHOOL ACTIVITIES, *October 1956*
Tape Recorded Plays. *Margaret K. Hanwell.*
- SKATING NEWS, *November 1956,*
December 1956
I Cover the Boot-Cover Story (Part I and Part II). *Margaret J. Sanders.*
- TODAY'S HEALTH, *January 1957*
When You Retire—Look Before You Migrate. *Senator Thomas C. Desmond.*

**Wear Your Golden Age Club Pin With
Pride Wherever You May Go**



Designed by representatives of over 100 Golden Age clubs and used nationally. Gold colored metal with evergreen tree in jewelers' enamel. Symbolic of long life, strength and perseverance. The words LOVE, PLAY, LEARN, SERVE (greatest values of club membership) enameled in black. The border is a laurel wreath for honor. Safety catch.

Available Only to Authentic Clubs.

50c each, minimum order 10 pins.

James Spencer & Co. 22 N. 6th Street
Philadelphia 6, Pa.

NEW

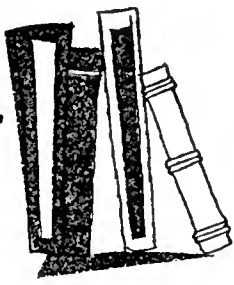

PUBLICATIONS

Covering the Leisure-time Field

The New Psychology for Leadership

Donald A. and Eleanor C. Laird. McGraw-Hill Book Company, 330 West 42nd Street, New York 36. Pp. 226. \$4.00.

In "Research in Today's Leadership," in the December issue of *RECREATION* (his Congress talk) Dr. Paul Douglass refers to a previous book by the Lairds, *The Technique of Handling People*, and quotes them several times. Now they have come forth with another publication "based on researches in group dynamics and human relations." This must be their seventh or eighth book on leadership psychology.

It presents techniques to improve personal leadership, and covers practical aspects of management relations. Visual aid "chartoons" and numerous case histories add interest and clarity to descriptions of the above subjects—and are amusing as well. This is an excellent, down-to-earth book of guidance not to be overlooked by supervisors who need to increase the efficiency of their methods!

Essentials of Social Group Work Skill

Helen U. Phillips. Association Press, 291 Broadway, New York 7.

This doctoral dissertation, which will be published early in May, gives evidence of a very wide coverage of material dealing with social group work skill. As might be suspected, the language is technical; however, the use of case studies enables those not saturated with the jargon of the social group work profession to grasp the basic points.

The thesis is "that between social group work purpose and skill is a reciprocal relation; defined purpose gives direction to the skill of the worker who is to approach the aims of group work; and skill, so directed, contributes to the fulfillment of the purpose."

Careful attention is given to specific areas of social group work skill; namely, "the use of agency function, communication, the present moment of time and group relations." Also well covered are methods by which the trained

worker uses these selected areas of the skill to accomplish the basic aims of group work: "individual growth of group members and development of the group as a whole for social usefulness."

Dr. Phillips succeeds in establishing her point of view, and, although it is not contended that this is the only effective way, the reader is deeply impressed with the functional way of working with groups toward social goals as described in this book. It belongs in the personal library of all group workers and recreation leaders on the activity level.—*James A. Madison, NRA Field Staff.*

A Pilot Study on Swimming for the Severely Mentally Retarded

Ontario Recreation Association, 100 Gibbs Street, Oshawa, Ontario, Canada. Pp. 72. Paper \$1.00.

This project was part of a research program on recreation for the severely mentally handicapped initiated by an Ontario Recreation Association committee on recreation for the retarded. It was the first pilot study, with three major objectives:

- To discover whether swimming would be an enjoyable recreation activity for severely mentally handicapped.
- To find out how well these children might progress in swimming skills.
- To see what success, in planning and administering such a project, could be achieved by a group of citizens with some experience in swimming but without previous contact with retarded children, assuming that they had advice from those working directly with such children.

Swimming was chosen as the first project because of the committee chairman's special interest in this area and because the physical benefits, such as relaxation and muscular development, seemed to be particularly desirable for the mentally handicapped.

This study is worth careful reading because it contains findings that can be put into immediate use in any swimming program during the coming months. It is also valuable because it adds considerably to the slowly increasing information now available on recre-

tion for the retarded. We look forward to other studies by this committee.

The Candle Book

Carli Laklan. M. Barrows and Company, 425 Fourth Avenue, New York 16. Pp. 190. \$3.50.

This book has personality! It is lively and entertaining, and you can tell that the author had fun writing it. You will enjoy the anecdotes, poems, and historical facts about candles as much as you enjoy working with the easy-to-follow instructions on candle making and decorating:

Neither do men light a candle, and put it under a bushel, but on a candlestick; and it giveth light unto all that are in the house.—Matthew 5:15.

Every step of the making, from start to finish, is described in detail. Information includes the kinds of wax available, sizes of wicks to use, how to color, how to make molds, how to decorate candles, how to use them as decoration, and where to buy equipment. Every page is full of ideas. The author's suggestions will serve as a springboard for your own imagination.

Did you know, for instance, that candles will burn with colored flames if wicks are treated with salts of copper, barium, strontium, or some such?

There are added features such as fresh and original designs for Christmas, birthdays, holidays and parties, how to use candles with flowers, and how to commercialize this craft. The illustrations are interesting and useful.

Whether you are interested in a satisfying hobby or an exciting money-making venture, you can be sure this book will provide plenty to work with.—*Shirley Silbert, instructor at New York University and the Y.W.C.A. Craft Students League, author of Craft Work Kit.*

monroe
FOLDING BANQUET TABLES

If you are on the Board of your Church, Lodge, Club, School, etc., you will be interested in this modern Folding Banquet Table.

AND
MONROE TRUCKS

Completely finished tops, resistant to most serving hazards. Used with or without table cloths.

Write for Table and Truck Catalog and special price discounts to institutions and organizations.
Monroe Co., 181 Church St., Colfax, Ia.

The New Complete Hoyle

Albert H. Morehead, Richard L. Frey and Geoffrey Mott-Smith. Garden City Books, Garden City, New York. Pp. 740. \$3.95.

This is the second, revised edition of this book, originally published in 1947. It is, of course, a standard book that should be available in any recreation library. In it are rules for over five hundred games of skill and chance—including canasta, samba, Bolivia, Scrabble, calypso, bridge, and other games played with cards, dice boards, counters, numbers and words. Chapters on juvenile card games, domino games, checkers, chess and their variations are all useful, not only in teaching games but in settling disputes and setting up official rules for tournaments or contests.

You'll recognize the authors. Mr. Morehead is editor of games for the *New York Times* and the *Encyclopaedia Britannica*. Mr. Mott-Smith is an expert on mathematical games, a bridge champion, and an official of the U. S. Chess Association. Mr. Frey is one of the world's best bridge players.—*Virginia Musselman, NRA Program Service.*

Rules of Games According To Hoyle

Richard L. Frey. Fawcett Publications, Fawcett Place, Greenwich, Connecticut. Pp. 256. \$.35.

This is a soft-cover, pocket-size book, with the official rules for more than two hundred popular games of skill and chance—canasta, chess, Michigan, cribbage, pinochle, rummy and many other card, dice, board, parlor and word games. It is not as inclusive as the *New Complete Hoyle*, but will be valuable for personal ownership and use.

How to Plan and Conduct Workshops and Conferences *

Richard Beckhard. Association Press, 291 Broadway, New York 7. Pp. 64. \$1.00.

Anyone who has ever helped run a conference, or who expects to, will approach this little manual with special interest—and find real stimulation and help. It presents clearly, concisely, and in logical order, the steps to be taken

* Available through the NRA Recreation Book Center, 8 West Eighth Street, New York 11.

in operating such a meeting, and should have particular interest for the recreation field, where these get-togethers are many.

Contents include initial planning, fact finding and evaluation, program development, conference preparation, planning conference operations, and reporting and follow-up action. Each contains detailed suggestions and checklists. Under "Planning the Conference Operations," for instance, come steering committee operation, organization and management, registration procedure, and conference communications planning.

The author is executive director of Conference Counselors, Incorporated. He writes authoritatively and effectively. As a bonus, this Leadership Library book is sized to fit in pocket or purse, so it can be read on the way.

Companion to this, for conference-goers, is the 1954 book of this same leadership series, *How to Attend a Conference*, by Dorothea F. Sullivan. Happier conferees, more productive conferences and workshops, could almost be guaranteed if all would apply these two authors' suggestions.—*Alfred B. Jensen, special assistant to the executive director, NRA.*

Use *Recreation* Classified Advertising

If you want to publicize information about
Help Wanted . . . Positions Wanted . . . Services Available
Workshops and Conferences . . . Educational Opportunities . . . Items for Exchange

HERE'S HOW:

1. Type—or clearly print—your message and the address to which you wish replies sent.
2. Underline any words you want to appear in boldface type.
3. Count the number of words in the message and the address: Count each group of numbers as one word (e.g., "856 East Fifth Street" or "Salary \$5,000 per year" would each count as four words).
Count boldface words separately.
4. Figure the cost of your ad: Words in regular type. . . \$.15 each
Words in boldface type. . . .25 each
Minimum ad accepted \$3.00
5. Mail your copy with your remittance to Recreation Classified Ads, 8 West Eighth Street, New York 11, New York. Copy must be received by the fifth of the month preceding the month of the issue in which ad is desired (e.g., April 5 to appear in the May issue).

SAMPLE ADS

HELP WANTED

Playground Director, man or woman, for town of 6,000. Salary \$380 to \$450 per month based on experience. Send complete resume of education and experience. James Smith, City Courthouse, Fuvville, Maine.

Cost: Boldface—2 words at \$.25 . . . \$.50
Regular—29 words at \$.15 . . . 4.35
Total cost of above ad would be \$4.85

WORKSHOPS & CONFERENCES

Square Dance Workshops. Weekly summer workshops for recreation leaders. Qualified instructors, sessions for beginners to advanced leaders. Write Director, Square Dance Camp, Riverview, Montana.

Cost: Boldface—3 words at \$.25 . . . \$.75
Regular—21 words at \$.15 . . . 3.15
Total cost of above ad would be \$3.90

POSITIONS WANTED

Crafts Instructor desires position with public recreation program in Midwest. Ten years experience in all phases of crafts, specializing in ceramics and weaving. Minimum salary \$4,500 per year. Jane Jones, 512 Orchard Street, Wide Falls, Michigan.

Cost: Boldface—2 words at \$.25 . . . \$.50
Regular—34 words at \$.15 . . . 5.10
Total cost of above ad would be \$5.60

ITEMS FOR EXCHANGE

Have Twelve Tennis Nets, good condition, to swap for softball bases or backstop. Recreation Department, Mill City, Maryland.

Cost: Boldface—3 words at \$.25 . . . \$.75
Regular—15 words at \$.15 . . . 2.25
Total cost of above ad would be \$3.00

INDEX OF ADVERTISERS

	PAGE
American Playground Device Company	37
The J. E. Burke Company	33
California State Personnel Board	59
Castello Fencing Equipment	37
Chicago Roller Skate Company	33
Citadel Press	37
The Copper Shop	39
Dimco-Gray Company	Inside Front Cover
H. & R. Manufacturing Company	33
A. C. Hamilton	59
Jamison Manufacturing Company	39
Jayfro Athletic Supply Company	39
Los Angeles City Civil Service Commission	61
The MacGregor Company	39
McGraw-Hill Book Company, Inc.	61
The Monroe Company	63
National Sports Company	39
Pack-O-Fun	36
Park Maintenance	Inside Front Cover
Rawlings Sporting Goods Company	61
The Ronald Press	Inside Front Cover
School Activities Publishing Company	Outside Back Cover
James Spencer & Company	62
Square Your Sets Enterprises	37
Superior Industries Corp.	33
Tricolalor Manufacturing Company	33
Voit Rubber Corporation	Inside Front Cover
R. T. Waters	33-39
X-acto, Inc.	39

Recreation Leadership Courses

Sponsored by the National Recreation Association

and

Local Recreation Agencies

February, March and April, 1957

HELEN M. DAUNCEY
Social Recreation

Fayetteville, Arkansas
March 11-14

Troy Hendricks, Head, Department of Health, Physical Education
and Recreation, University of Arkansas

Sherman, Texas
April 8-11

Mrs. Ralph Day, Assistant Professor of Physical Education, Austin
College

RUTH G. EHLERS
Social Recreation

*Morganton, North Carolina
January 28-31

Jack Biggerstaff, Director of Recreation, State Hospital

Greensboro, North Carolina
February 4-7

Miss Mabel Smith, Parks and Recreation Department

New York City
April 1

Miss Maxine Keith, Executive Director, Girls Clubs of America, Inc.,
130 Maple Street, Springfield, Massachusetts

ANNE LIVINGSTON
Social Recreation

*Concord, North Carolina
February 4-7

Jesse Taylor, Director of Recreation

*Roanoke Rapids,
North Carolina
February 11-14

George Hudgins, Director of Recreation

Aiken, South Carolina
March 25-28

Darrell Robinson, Jr., Superintendent, Aiken County Recreation
Commission, Box 2085

GRACE WALKER
Creative Recreation

Pocatello, Idaho
February 4-7

John L. Brenna, Recreation Director, Box 1489

* In cooperation with the North Carolina Recreation Commission, Raleigh

Attendance at training courses conducted by National Recreation Association leaders is usually open to all who wish to attend. For details as to location of the institute, contents of the course, registration procedure, and the like, communicate with the sponsor of the course as listed above.

Miss Dauncey will attend the Pacific Southwest District Recreation Conference in Sacramento, California, February 24-27.

Miss Walker will attend the Northland Recreation Leaders Laboratory in Minnesota April 24 through the end of the month.

Miss Dauncey will also be in the Pacific Southwest and Pacific Northwest Areas during February and through March 7 at the following air bases: Castle Air Force Base, Travis Air Force Base, Hamilton Air Force Base, Fairchild Air Force Base. For further information communicate with Linus L. Burk, Air Force Regional Representative, 1345 Lincoln Avenue, San Rafael, California. Beginning the week of March 18 through April 4 she will be in the Southwest Area conducting courses at air bases in that general area. For further information communicate with R. C. Morrison, Air Force Regional Representative, 248 Casa Blanca, Fort Worth, Texas.

Miss Dauncey will conduct recreation leadership training courses for the United States Air Force in Europe beginning April 22 through May 31.

Frank A. Staples will be conducting two week Arts and Crafts training workshops beginning February 4 through the end of the month in the Southern Area at the following air bases: Palm Beach Air Force Base, Orlando Air Force Base. For further information communicate with Fred E. Lengfeld, Recreation Consultant, Military Air Transport Service, Washington, D.C. Beginning March 4 through April 11 he will be conducting training courses in the Southwest Area. Contact R. C. Morrison, 248 Casa Blanca, Fort Worth, Texas, for further information. A two week period beginning April 15 will bring Mr. Staples into the Pacific Northwest Area. For further information communicate with Howard Beresford, 3055 Bellaire, Denver 7, Colorado.

"Every Issue is Full of Good Ideas"

—GERALD M. VAN POOL
Director of Student Activities
National Education Association

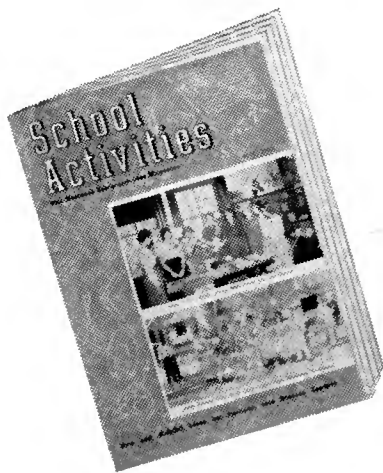

Gerald M. Van Pool, a leading figure on the national education scene, urges state Student Council secretaries to subscribe to SCHOOL ACTIVITIES Magazine because "every issue is full of good ideas to help us improve student councils."

Every student leader and faculty sponsor of an activity in your school will appreciate the down-to-earth ideas and suggestions in SCHOOL ACTIVITIES Magazine. In your school library, it will help you month after month in planning successful programs for assemblies, plays, clubs, athletics, debate, music, student publications, and student government.

SCHOOL ACTIVITIES is the *only* national magazine in the extracurricular field. Readers look to it for expert leadership and rely on it to help them solve their problems in any student activity program.

SUBSCRIBE NOW!

SCHOOL ACTIVITIES PUBLISHING CO.
1041 NEW HAMPSHIRE
LAWRENCE, KANSAS

Please enter my subscription to SCHOOL ACTIVITIES for
_____ years.

Name _____

Address _____

City _____ State _____

One Year, \$4.00

Two Years, 7.00



*Just clip and mail
the order form to:*

**SCHOOL ACTIVITIES
PUBLISHING COMPANY**

1041 New Hampshire
Lawrence, Kansas

Henry Pfeiffer Library
MacMurray College
Jacksonville, Illinois

Recreation

MAR 12 1957

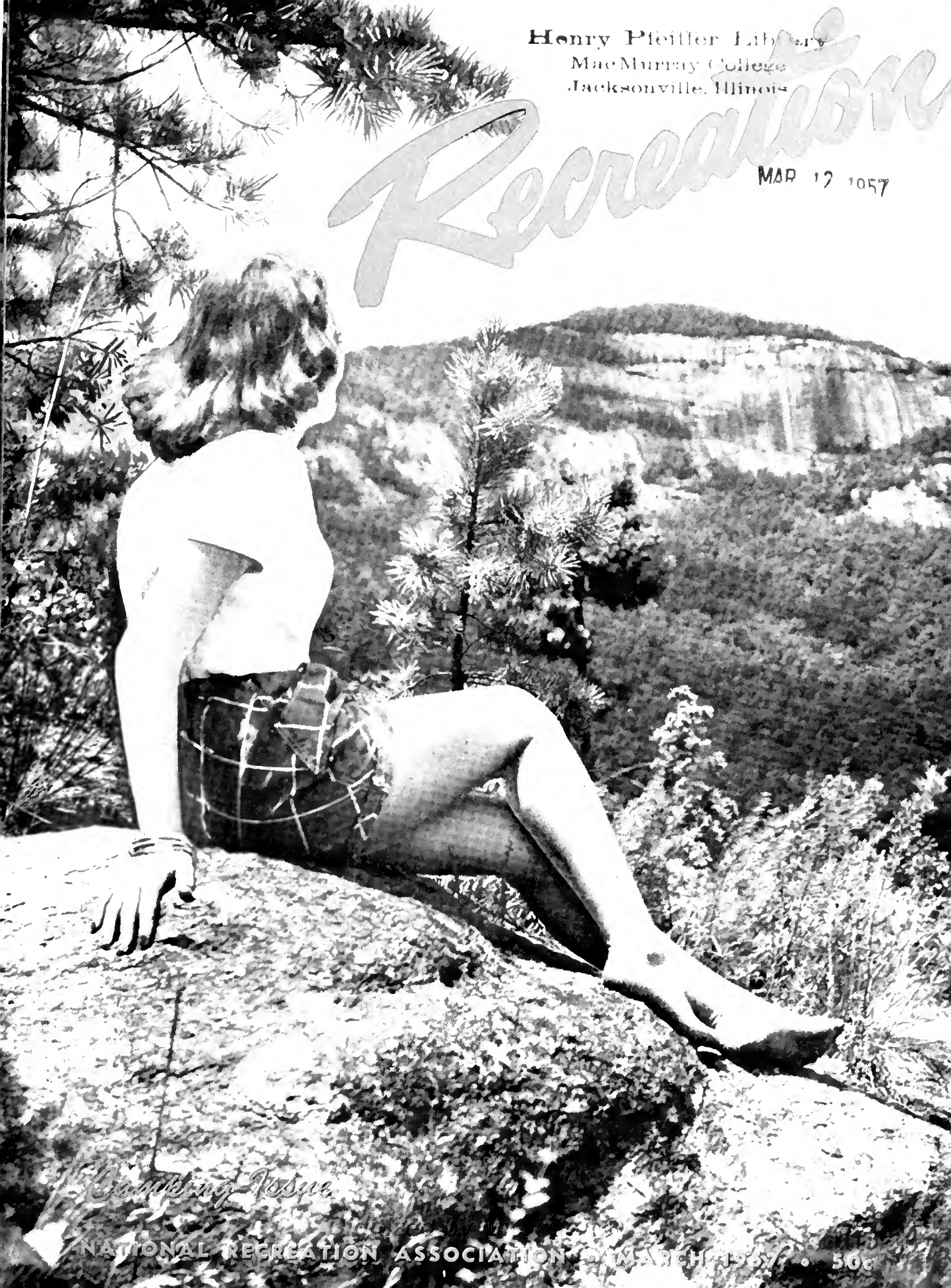

Camping Issue

LOUISVILLE SLUGGER BATS



THESE
FAMOUS NAMES
Testify
to its
PERFORMANCE



Look
for the famous
oval trade-mark
on the bat
you buy...

a Must . . .

for Catholic parents and all youth workers who are looking for

CATHOLIC CAMPS

The NATIONAL CATHOLIC CAMPING ASSOCIATION

announces the publication of its

1957 DIRECTORY OF CATHOLIC CAMPS

Here is information vital to all those seeking a summer camp for their youngsters. Our new directory contains complete, accurate, and up-to-date information on all active Catholic camps in America—nearly 300 in all.

This year plan to send your child to a Catholic camp—where God is foremost. Catholic camps are among the finest and most modern in the country.

The National Catholic Camping Association is an activity of the Youth Department, National Catholic Welfare Conference. Membership is open to anyone interested in camping. Members receive the annual *Directory of Catholic Camps and Trail Signs*, the official monthly magazine of Catholic camping.

MSGR. JOSEPH E. SCHIEDER, PH.D.
National Director

for your directory send \$1.00 to

NATIONAL CATHOLIC CAMPING ASSOCIATION

1312 Massachusetts Ave., N.W.

Washington 5, D. C.

Thinking of **REFINISHING** or **REMARKING** your

gym floor

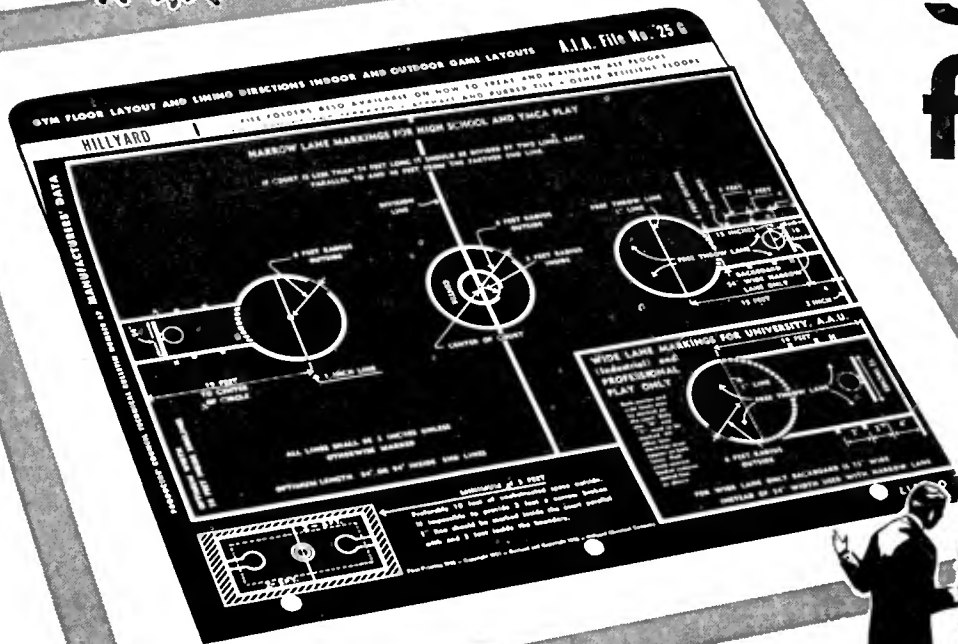

NEW!

REVISED HILLYARD FOLDER Gives You Valuable Suggestions, Can Save You Expensive Unnecessary Work

Complete instructions for laying out, marking, and finishing. It's up-to-date, with all rule changes, including new wide free throw lanes. Also gives lining instructions for other popular indoor sports. Every coach should have this Free Guide. If you're changing over to the wide lane, Hillyard can show you how to re-mark your court without re-finishing the entire floor!

Folder Also Tells How to Give Your Gym Floor TROPHY "Finish for Champions"

COACHES LIKE "TROPHY" FLOORS—for beautiful appearance which invites championship caliber play.

PLAYERS LIKE THEM—for sure-footed slip resistance.

SPECTATORS LIKE THEM—for no-glare, light color which helps them see plays clearly.

ADMINISTRATORS AND CUSTODIANS LIKE THEM—for extra long wear and ease of maintenance.

Now You Can Afford the Best! TROPHY outwears all other finishes by more than 2 to 1—cuts labor in finishing and maintenance by one-half!

ST. JOSEPH, MO.



San Jose, Calif. Passaic, N. J. Branches in Principal Cities

MAIL THIS COUPON TODAY!

HILLYARD St. Joseph Mo.

- Please send me new Coach's Folder on Gym Floor finishing, layout and marking.
- Please have your nearby Hillyard "Maintainer"®, trained floor expert, advise me the proper way to change my court over to new wide lane markings.

Name

Institution

Address

City..... State.....



NATIONAL RECREATION ASSOCIATION

A Service Organization Supported by Voluntary Contributions

JOSEPH PRENDERGAST, *Executive Director*



NATIONAL ADVISORY COUNCIL

The National Advisory Council is made up of the chairmen of the National and District Advisory Committees of the National Recreation Association, the president of the Federation of National Professional Organizations for Recreation, and a representative of the Annual Meeting of Presidents of Affiliated State Societies and Associations. The Council advises directly with the Board of Directors of the National Recreation Association.

ROBERT W. CRAWFORD—*Chairman*

National Advisory Committee on Recreation Administration

ARTHUR WILLIAMS—*Secretary*

National Recreation Association

ROBERT L. BLACK

National Advisory Committee on State Recreation

GERNON G. BROWN

Southwest District Advisory Committee

BERNARD B. CAMPBELL

New England District Advisory Committee

PAUL H. DOUGLASS

National Advisory Committee on the Recruitment, Training and Placement of Recreation Personnel

ARNOLD HALPERN

Pacific Northwest District Advisory Committee

RUSSELL JOHNSON

Great Lakes District Advisory Committee

DR. ROY LEILICH

Southern District Advisory Committee

DOROTHEA LENSCH

National Advisory Committee on Recreation Programs and Activities

STEWART MOYER

Middle Atlantic District Advisory Committee

J. A. REYNOLDS

National Advisory Committee on Recreation Research

DR. JULIAN W. SMITH

President, Federation of National Professional Organizations for Recreation

BEN H. THOMPSON

National Advisory Committee on Federal Recreation

H. B. TRENT

Pacific Southwest District Advisory Committee

JAY M. VER LEE

National Advisory Committee on Defense Related Services

FORREST W. WAKEFIELD

Midwest District Advisory Committee

AUSTIN WELCH

National Advisory Committee for the International Recreation Service of the National Recreation Association

AFFILIATED STATE SOCIETIES AND ASSOCIATIONS

ALABAMA RECREATION ASSOCIATION

ALABAMA RECREATION SOCIETY

ARIZONA RECREATION ASSOCIATION

CALIFORNIA RECREATION SOCIETY

COLORADO RECREATION SOCIETY

CONNECTICUT RECREATION SOCIETY

FLORIDA RECREATION ASSOCIATION

GEORGIA RECREATION SOCIETY

IDAHO RECREATION SOCIETY

ILLINOIS ASSOCIATION OF PARK DISTRICTS

ILLINOIS RECREATION ASSOCIATION

INDIANA PARK AND RECREATION ASSOCIATION

IOWA RECREATION SOCIETY

KANSAS RECREATION SOCIETY

KENTUCKY RECREATION SOCIETY

LOUISIANA RECREATION ASSOCIATION

MAINE STATE RECREATION SOCIETY

MARYLAND RECREATION SOCIETY

MASSACHUSETTS RECREATION ASSOCIATION

MICHIGAN RECREATION ASSOCIATION

MINNESOTA RECREATION ASSOCIATION

MISSISSIPPI RECREATION ASSOCIATION

MISSOURI COMMUNITY RECREATION AND PARK SOCIETY

WISCONSIN RECREATION ASSOCIATION

MISSOURI RECREATION ASSOCIATION

MONTANA RECREATION ASSOCIATION

NEVADA STATE RECREATION AND PARK SOCIETY

NEW HAMPSHIRE RECREATION SOCIETY

NEW JERSEY PARKS AND RECREATION ASSOCIATION

PUBLIC RECREATION ASSOCIATION OF NEW JERSEY

NEW MEXICO RECREATION ASSOCIATION

NEW YORK STATE RECREATION SOCIETY

NORTH CAROLINA RECREATION SOCIETY

NORTH DAKOTA RECREATION ASSOCIATION

OHIO RECREATION ASSOCIATION

OKLAHOMA RECREATION SOCIETY

OREGON RECREATION AND PARK ASSOCIATION

PENNSYLVANIA RECREATION SOCIETY

SOUTH CAROLINA RECREATION SOCIETY

SOUTH DAKOTA RECREATION AND PARK ASSOCIATION

TENNESSEE RECREATION SOCIETY

TEXAS RECREATION SOCIETY

UTAH RECREATION SOCIETY

VERMONT RECREATION SOCIETY

VIRGINIA RECREATION SOCIETY

WASHINGTON STATE RECREATION SOCIETY

WEST VIRGINIA RECREATION SOCIETY

Recreation*



THE MAGAZINE OF THE RECREATION MOVEMENT

CONTENTS

GENERAL FEATURES

- New Horizons for Camping (Editorial) *T. R. Alexander* 70
- Long Beach Beckons 71
- What Are Today's Campers Missing? *Eugene L. Swan, Jr.* 73
- The Personal Touch in Day Camping *Patrick J. Carolan* 74
- The Mentally Retarded at Camp *Roland Larson* 77
- Recreation at the South Pole *Muriel McGann* 81

ADMINISTRATION

- Camping for Tomorrow *Reynold E. Carlson* 83
- Campsite Selection, Layout and Development *Lewis C. Reimann* 85
- The Professional Role of the Camp Director *Hedley S. Dimock* 88
- A Recreation Development *William J. Duchaine* 90

PROGRAM

- Westward Ho! 82
- Nature Study in a Playground Day Camp 84
- Nature Tools *Bettye Breeser* 92
- Creativity in Camp Music 94
- Flag Ceremony 96
- The Campfire (Idea of the Month) *S. Theodore Wool* 97
- Woodfire and Candle-Light *Mary Edgar* 98
- Contests for a Woodsmen's Weekend 99
- Guideposts for Safe Water Skiing *Harold M. Gore* 100
- Bone Carving (How To Do It!) *Frank A. Staples* 102
- Inexpensive Nature Materials for Crafts 103
- Water Dramatics for Young Swimmers *Betty DuBois* 104
- Easter Idea Hunt 107

REGULAR FEATURES

- Letters 68
- Things You Should Know 72
- Reporter's Notebook 79
- How To Do It! Idea of Month See Program
- Personnel—Recruiting *Marilyn Jensen* 106
- Market News 108
- Hospital Capsules *Beatrice H. Hill* 109
- Books and Pamphlets Received, Magazine Articles 110
- Index of Advertisers 110
- New Publications 111
- Recreation Leadership Training Courses Inside Back Cover

Editor in Chief, JOSEPH PRENDERGAST
 Editor, DOROTHY DONALDSON
 Editorial Assistant, AMELIA HENLY
 Business Manager, ALFRED H. WILSON

ASSOCIATE EDITORS

Recreation Administration, GEORGE BUTLER
 Program Activities, VIRGINIA MUSSELMAN

Vol. L Price 50 Cents No. 3

On the Cover

THE CAMPER—1957. In camps, the young learn to love our mountains and forests, open spaces, lakes and the sea; they learn to know one another and to live together joyously during the summer, when our cities set them free. Photograph, courtesy of South Carolina State Commission of Forestry.

Next Month

The Playground Issue of RECREATION is usually published in April. This year it is a jackpot of playground ideas. Among the articles are "Playground Facts and Fun," "An Investment in Leadership," "Dennis the Menace Playground," "The Girl in the Blue Denim Skirt," "Try a New Idea," a suggested summer playground evaluation form, and many others. Those who are planning a special May Day observation will welcome the "Maypole Dance."

Photo Credits

Page 73, *Milwaukee Journal* Photo; 84 Earle's Photo Art Studio, Two Rivers, Wisconsin; 90 (upper right), American Playground Device Company, Anderson, Indiana, (others), Odell, Anderson, Indiana; 92, *Milwaukee Journal* Photo; 97, Dearborn (Michigan) Recreation Department; 104 (left), Paul R. Kasko, Greenbelt, Maryland, (right), *Waukesha Daily Freeman*.

RECREATION is published monthly except July and August by the National Recreation Association, a service organization supported by voluntary contributions, at 8 West Eighth Street, New York 11, New York, is on file in public libraries and is indexed in the *Readers' Guide*. Subscriptions \$4.00 a year. Canadian and foreign subscription rate \$4.50. Re-entered as second-class matter April 25, 1950, at the Post Office in New York, New York, under Act of March 3, 1879. Acceptance for mailing at special rate of postage provided for in Section 1103, Act of October 3, 1917, authorized May 1, 1924. Microfilms of current issues available University Microfilms, 313 N. First Street, Ann Arbor, Michigan.

Space Representatives: H. Thayer Heaton, 94 Garfield Place, Lynbrook, Long Island, New York; Mark Minahan, 168 North Michigan Avenue, Chicago, Illinois.

Copyright, 1957, by the
 National Recreation Association, Incorporated

Printed in the U.S.A.



* Trade mark registered in U. S. Patent Office.



Readers! You are invited to send letters for this page to Editor, RECREATION, 8 West Eighth Street, New York 11—so that your ideas, opinions and attitudes may be exchanged with others on the wide range of subjects of concern to us all. Here is your chance to agree or disagree with the authors of our articles. Keep letters brief—not more than 250 words.

—The Editors.

Hot Rods

Sirs:

In the December issue of RECREATION Magazine (page 463) you have an article pro and con on drag strips.

I think it would be a good idea for RECREATION to do two things. First, find out how many city recreation departments are involved in "hot rod" activities and, second, report the findings of the National Safety Council when they complete their survey on drag strips.

GEORGE T. SARGISSON, *Executive Director, Recreation Promotion and Service, Inc., Wilmington, Delaware.*

Members Speak

Sirs:

As an associate member of the National Recreation Association for over fifteen or twenty years I would like to present the following:

In the 1920's and 1930's the number of recreation departments, and the organization of future departments, was on a small scale compared to the present time. Members of the field service were able to visit the organized departments in their areas and give the necessary time for the promotion of recreation. I feel that this service was invaluable to the parties concerned, particularly to those of us who were beginning in administrative positions. I for one will never be able to thank your organization enough for the assistance given.

With the rapid growth of recreation nation-wide, I know the field service is more than overloaded. At the same time, I realize the sources from which your funds are secured for the operation of services given.

Each department in the nation operates on a budget just the same as your organization. Knowing you only have so much money which you may spend, I would like to propose the following so that more field personnel could be added to the staff, with each having a smaller area and therefore in better po-

sition to give the best service.

1. Increase the membership dues of associate members from \$5.00 to \$25.00 per year.

2. Increase affiliate memberships from \$10.00 to \$35.00 per year.

3. Contributors could continue as they have in the past.

This is no criticism of the National Recreation Association or its personnel, as I think that the organization is the best for the promotion of recreation. I believe that if the preliminary work was done prior to the next National Recreation Congress and a very frank analysis was placed before the body at that time, I am sure you would receive a very favorable reaction. It may possibly take two years to sell the idea, but I believe it would be worthwhile to all parties.

The average administrator, particularly in one-man departments, would favor this due to the valuable assistance that can be given by your field representatives—I know this from past personal experience.

We people in the field would benefit greatly, so why shouldn't we be glad to pay increased dues for this service? Salaries for all personnel in this business have certainly increased in the last twenty years, although National Recreation Association membership has not.

RALPH M. STUDEBAKER, *Town Recreation Director, Pulaski, Virginia.*

* * * *

Sirs:

I am sending you herewith Montgomery's annual dues of \$150.00. It has been very gratifying to me to see the continued interest on the part of our board toward the National Recreation Association. I do wish that something could be worked out where more cities would include this item in their annual budget, giving your organization more money and at the same time enabling you to give the cities more field help. I feel that Charlie Reed has done a wonderful job with limited finances and, as I

think back on our beginning here, I am sure that without the help of Marion Preece, Bill Hay, Helen Dauncey, Anne Livingston, J. W. Faust and many others we would have been unable to make the headway we have.

T. A. BELSER, *Superintendent of Parks and Recreation, Montgomery, Alabama.*

Otto T. Mallery

Sirs:

I was greatly surprised and saddened by the report in a recent Affiliate Membership Letter of the untimely death of Otto T. Mallery, a member of the National Recreation Association Board of Directors. [See RECREATION, January 1957, page 4.—Ed.] I had known Mr. Mallery since 1922 when I entered the recreation field and have been one of his great admirers. He had a magnificent personality and loved people. His sense of humor and his philosophy of recreation were always an inspiration to me at any National Recreation Congress.

It just seems impossible that I must lose this good friend after I had recently broken bread with him and talked with him several times during the International Recreation Congress in Philadelphia. The National Recreation Association has lost a great and outstanding friend.

THOMAS W. LANTZ, *Superintendent, Public Recreation, Tacoma, Washington.*

Thanks to John Faust*

Dear John:

I have read with interest and pleasure the article ("Lord of Leisure") written by you for the December issue of RECREATION.

It sounds exactly like the philosophy you have preached during all the years we were associated, and I know you are continuing this philosophy now that you are at liberty to "do as you please."

My main regret now is that you never seem to come my way to inspire me with your ideas and ideals. In consequence, I am floundering along as best I can, apparently to the annoyance of at least some of the ungodly in the community—by that I mean those who do not agree with me, whether right or wrong. Once upon a time you used to come in and adjudicate some of these questions, but now that I am entirely on my own, my victims have to take the consequences of your loss.

MAURICE DUPONT LEE, *President, Board of Park Commissioners, Wilmington, Delaware.*

* * * *

* Mr. Faust retired from NRA field service in 1955 after thirty-two years with the Association.

Dear J. W.:

Received your "Lord of Leisure" this morning. I have read it several times. It is of that caliber that can, and does, require many readings. It is, may I say, a masterpiece of brevity and content. I for one am proud of you, J. W., for producing for posterity such an excellent piece of religious literature.

As father and mother of such a piece of writing you must at times, as you read it, receive a warm glow of honest and gratifying pride. Keep your brain and heart children coming; we certainly need them at this time as we have never needed them before!

GRANT D. BRANDON, Lancaster, Pennsylvania.

Query to Mr. Prendergast

Dear Joe:

I am writing as an Active Associate Member of the NRA and a regular participant in the NRA Congresses.

No doubt you have read the article by Charles Price in the February 2, 1957 issue of *The Saturday Evening Post*. The subject is Joe Brown and his playground equipment designs.

I, and many other recreation people in this area, are quite concerned about the quote on page 92 attributed to an executive of the NRA, and particularly the phrase "entirely too high-brow for that mob."

I do not, of course, believe that this statement was made by an executive of the NRA and would appreciate your assurance on this point, because I wish to write to Price and to the editor to protest such a derogatory statement, which I believe Price fabricated. This statement, particularly in a national magazine which is read by so many laymen, certainly reflects no credit on the recre-

ation movement and on those who attend the Congress.

Any reactions you can give me to the points I have raised here will be sincerely appreciated.

G. B. FITZGERALD, Director of Recreation Training, University of Minnesota, Minneapolis.

Dear Fitz:

I can well appreciate your reaction to the unfortunate use of the expression "entirely too high-brow for that mob" by Charles Price in his article on Joe Brown and his playground equipment designs in a recent issue of *The Saturday Evening Post*. You are quite right, of course, that an executive of the National Recreation Association did not make such a statement.

Actually, what happened was that Mr. Price talked with our director of public relations, David J. DuBois, about Joe Brown and Mr. DuBois provided some of the background material which was woven into the article. Mr. DuBois did say that the speech as Mr. Brown had written it seemed to him to be extremely abstract and he had some questions about how enthusiastically it would be received at a general session of the Congress.

Mr. DuBois talked with Mr. Price this morning after I received your letter and Mr. Price apologized for the excessively free interpretation of Mr. DuBois' remarks and pointed out that he simply was attempting to illustrate that "Joe Brown has a tendency to get really involved in the subject."

Of course, a number of recreation people have told me that the over-all impact of the article is excellent for recreation. With the exception of this unfortunate error I do feel that Mr. Price did a very fine job. Even the most diligent reporters make errors and sometimes use an incorrect word here and there.

I think you will be pleased to know that *Parents'* magazine has an excellent article on the community recreation movement in its March issue. Also, the manuscript for a major article on encroachment of park and recreation lands has just been completed for publication in another national magazine, probably in June. This kind of national publicity, I am sure you will agree, is worthwhile for the recreation movement.

JOSEPH PRENDERGAST, Executive Director, National Recreation Association.

JUNE is
National Recreation Month

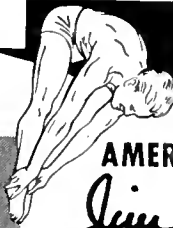

WRITE FOR LITERATURE

AMERICAN APPROVED

Jim Patterson

lifetime

ALUMINUM DIVING BOARD

World's Finest Official Board
Rugged Aircraft Girder Construction, Unequaled in Design, Durability and Performance by any board built today.
Exclusive International Distributors



AMERICAN
PLAYGROUND DEVICE CO.
ANDERSON, INDIANA, U. S. A.
WORLD'S LARGEST MANUFACTURERS OF FINE PARK, PICNIC, PLAYGROUND, SWIMMING POOL AND DRESSING ROOM EQUIPMENT



NEW! Jayfro Multi-Purpose ALUMINUM STANDARD
Use it 12 Ways!

Interchangeable Indoors and Outdoors for

- VOLLEY BALL • BADMINTON
- TENNIS • PADDLE TENNIS
- HIGH JUMP • TETHERBALL

- ✓ Official specifications
- ✓ Lightweight
- ✓ Easy to Install and move
- ✓ No maintenance
- ✓ Six different models



Jayfro BASKETBALL STEEL CHAIN NETS
3 Years Guarantee! outdoors or indoors

Also Featuring Jayfro's Custom Built
New and Improved!

- ✓ PADDLE TETHERBALL SETS
- Revolutionary and Exciting New!
- ✓ SHUFFLEBOARD SETS with "RUBBER CUSHIONED" DISCS

• Send for Free Catalog •

JAYFRO ATHLETIC SUPPLY CO.
Dept. RC, Box 1065, NEW LONDON, CONN.

CALIFORNIA STATE HOSPITALS

Offer

career opportunities in new Rehabilitation Service Program for

College Graduates with specialization in Recreation Therapy or Recreation

- STARTING SALARIES \$4,296
- FOURTEEN MODERN FACILITIES
- ATTRACTIVE EMPLOYEE BENEFITS

Medical Recruitment Unit

California State Personnel Board

801 Capitol Avenue

Sacramento

New Horizons

for Camping T. R. Alexander



THE HORIZON is as far as one can see in one direction. There are no new directions but there are distances that most of us have never seen or traveled. The ability to see new horizons is dependent upon moving up to higher ground or changing one's point of view.

The U. S. Office of Education reports that eleven million more children will be added to the present thirty-nine and a half million now attending United States schools in the next ten years. Communities already hard pressed to meet educational demands face, in the next decade, an unprecedented challenge with resources of money, personnel and facilities far from adequate to maintain even existing educational standards. Citizens must call upon public and voluntary agencies in recreation and camping to supplement their best efforts and deploy the total resources of the community in accordance with community needs and in the light of the functions each is best fitted to perform.

The crisis that appears on the horizon in the U. S. school system calls for professional educators, camping and recreation leaders to understand each other's points of view and programs, and to cooperate in programs of teaching and guided learning that will provide, in addition to knowledge, the development of a variety of interests, skills and appreciations in the major areas of human living.

Education, recreation and camping are not separate and unrelated movements or programs but rather interrelated parts of one common concern with the development of better human persons, which is, in turn, the chief concern of the whole organization of our society that we call democracy.

Education has been defined as "a continuing process whereby the individual is led on by interest from one experience to another in such a way that he acquires the knowledge, skill, habits and appreciations which will mean the greatest enrichment of his life."

Out of seventy-five years experience organized camping has many contributions to make. Resident camping, which involves living together for twenty-four hours a day, seven days a week, provides a unique opportunity to teach the techniques of democratic community living, to learn the self-disciplines that come with taking care of one's self in a wilderness environment. There are the values that come with the development of hobby interests, crafts, sports, woodcraft, health and physical fitness, and the understanding of nature where the camp situation provides a superior setting.

Persons come to accept value out of the experiences of life, not because someone tells them how fine they are, but through discovery in their own everyday relationships with others. The controlled, wholesome, democratic, creative setting of a modern camp affords, as few experiences outside the home can, many opportunities for relationships with others which call forth these values.

The postwar years have brought expanding camping horizons in many directions. The number, enrollment and kinds of resident camps have shown a marked increase until, today, more than five million children are enrolled in the nearly thirteen thousand camps in our country.

Extension of camping was for many years a concern of the voluntary welfare agency and the private entrepreneur. An increasing number of parents, many of them campers themselves during their youth, educators and citizens generally are solicitous concerning the extension of camping opportunities to more and more young people.

Beginning in the early days of World War II, public schools evidenced an interest in making camping a part of every child's educational experience, and each succeeding year has seen the development of new *school camping* programs. Interest in school camping is widespread and considerable planning and experimentation is under way.

Church-sponsored camps represent one of the fastest growing areas of camping, with national leaders of all faiths recognizing the obligations and opportunities to strengthen their distinctive programs through camping.

MR. ALEXANDER is president of the American Camping Association, Martinsville, Indiana.

Family camping is a third rapidly developing phase of camping that gives father, mother and children the experience of outdoor living in an organized resident camp, planned specifically for that purpose or adapted for family use before or after the children's camp season.

Camping for handicapped children and camping for older persons has increased many fold during the past ten years.

Day camping presents still another fast growing trend in camping. With an emerging differentiation between play groups and building-centered summer-fun clubs, day camping places a primary emphasis on taking advantage of an outdoor setting and camping skills. This phenomenal growth of day camping has received great stimulus in suburban communities where parents, schools, churches and public auspices have accelerated opportunities for younger children to enjoy an introduction to a camping experience.

Another expanding horizon in camping has been the increased *year-round use of camping facilities*. Camping is no longer limited to an eight-week summer vacation period, as new facilities are designed for use throughout the year, over weekends, and during vacation periods, with programs built around winter sports, conservation, hunting, fishing and other seasonal activities.

In the early 1930's, a systematic and cooperative effort to formulate and apply standards to every aspect of camping began. Under leadership of the American Camping Association, standards for both resident and day camps have been established. They deal with personnel, program, site, facilities, equipment, health, sanitation and safety. The *raising of camp standards* marks another expanding horizon in better camping. Sectional leadership-training workshops and improved pre-camp and in-service training programs have implemented higher camp leadership standards to produce older, more mature and better trained camp leadership.

A final expanding horizon in camping can be found in the increasing acceptance of a philosophy that camp life must be developed around the personal welfare and growth of the individual camper and that a real camping experience can be lost in a mass of overplanned schedules, activities imported from school and playground, and the requirements of an intensive competitive and award system.

Camping, at its best, is a children's world, a world of fun and adventure with those of his kind, a simple environment in which he expresses himself naturally. Led by high interest he moves from experience to experience, acquiring knowledge, skills, experience in a community of intimate fellowship and shared living, enriched through the guidance of understanding leadership. ■



.

Long Beach Beckons →

SEPT. 30 - OCT. 4

1957 NATIONAL RECREATION CONGRESS

The invitation is extended and the welcome mat is being readied as Long Beach, California, gets set for the 1957 National Recreation Congress.

This year the Congress is being sponsored by the National Recreation Association, American Recreation Society, California Recreation Society, County of Los Angeles Department of Parks and Recreation, and Long Beach Recreation Commission—with the cooperation of the College Recreation Association, Council for the Advancement of Hospital Recreation, and Federation of National Professional Organizations for Recreation, and the assistance of the State of California Recreation Commission. Certainly, with all these top organizations working together to make the Congress program the major event of the year in the recreation field, attendance is a "must" on the agenda of all those sincerely concerned about recreation.

Members of the Congress Executive Committee are: Joseph Prendergast, chairman; J. Earl Schlupp, vice-chairman; William Frederickson, Jr.; Norman S. Johnson; Wal-

ter L. Scott; Dorothy B. Taaffe; and Robert W. Crawford. (See RECREATION, February 1957, page 44.)

Headquarters hotels will be The Lafayette and The Wilton, both within walking distance of the Long Beach Municipal Auditorium, which will be the focal point of the Congress for registration, exhibits, and meetings. This fabulous building is located in a fourteen-acre park which juts out into a lagoon enclosed by famed Rainbow Pier—and surrounded by the blue Pacific Ocean and miles of sandy beach.

To combine pleasure with business, there are many renowned places of interest all *within* an hour's journey from Long Beach—high spots such as Hollywood and Los Angeles; Disneyland, Marineland, and Laguna Beach; Knott's Berry Farm; the Griffith Park Observatory; Pasadena Rose Bowl and Santa Anita Race Track, the Mission at Capistrano; plus many others. Banquets, tours and social activities will be, as usual, features of the Congress program.

Check the dates—SEPTEMBER 30—OCTOBER 4—on your calendar NOW . . . and watch RECREATION for additional Congress news each month. ■

Things You Should Know . .

▶ **LATEST DEVELOPMENTS IN ENCROACHMENT.** The dilemma caused by projected federal highways as well as by high-pressure building locally, and other problems regarding land for recreation or parks today—which are affecting every community—will be discussed in the June issue of RECREATION.

▶ **100% AFFILIATION!** With the recent affiliation of the North Carolina Recreation Society, every existing state recreation society or association is now affiliated with the NRA. Forty-three states currently have local organizations and we hope to see groups organized in the remaining states which do not as yet live their own professional societies.

▶ **A BOOKLET OF MAPS, *Camping Maps, USA*,** indicates major camping areas in each of the forty-eight states. It can be obtained through National Campers and Hikers Association, or from the authors, Glenn and Dale Rhodes, Box 162, Upper Montclair, New Jersey.

▶ **IF YOU WANT TO SET UP A WEATHER STATION** in your camp, you might like to look over the pamphlet, *Something About the Weather*. It is compiled by and available from James E. O'Brien, Western Pennsylvania Section, American Camping Association, 200 Ross Street, Pittsburgh 19, for fifteen cents.

▶ **ELEVEN THOUSAND JOB REFERRALS** were made by the National Recreation Association during 1956. The number of recreation executive positions reached a new high of one hundred and eight. Salaries ranged from \$4,000 to \$10,000, with a median of \$5,000.

▶ **FOR CHILDREN'S BOOK WEEK**, this year, November 17-23, the slogan will be one which was winner in a recent contest—"Explore with Books." It is interesting that for 1956 Book Week in the Netherlands, the theme was "Indians," and American children's books on Indians—in translation—were featured. Many children's libraries were transformed into teepees and wigwams.

▶ **NATIONAL WILDLIFE WEEK**, March 17 to 23, is sponsored annually by the National Wildlife Federation and its state affiliates. Purpose: to gain public appreciation of the fact that, to "Keep America Beautiful," we must protect and manage wisely our national resources—our waters, forests, soils and wildlife.

This year, Wildlife Week emphasizes the importance of providing adequate living places for animals, always such an important part of our American scene and an addition to the beauty and enjoyment of our outdoor areas. The tens of millions of people who enjoy hunting and fishing and visits to our parks, forests and wildlife refuges cannot help but be interested in this subject.

▶ **A STUDENT GROUP HEALTH STUDY PLAN** is announced by the American Medical Association magazine, *Today's Health*. A free set of monthly discussion topic questions, prepared by well-known educators, has been prepared for each issue. Further details can be obtained by writing to *Today's Health*, American Medical Association, 535 North Dearborn Street, Chicago 10.

▶ **SONG SLIDES AVAILABLE.** National Studios, 145 West 45th Street, New York 19, one of the few remaining sources for song slides, is discontinuing this service. The over ten thousand song slides in stock will be sold at ten cents each—less than cost. If you use or need slides for your community sings, here's a chance. Order direct from the company and specify size, either 2 by 2 inches or 3½ by 4 inches.

▶ **THERE IS A GREAT DEAL OF CONTROVERSY** as to whether or not operators of power boats should be licensed, in view of today's great increase in the number of small pleasure craft and the congestion in many waters. If the answer is "Yes," what qualifications should be required for a license? Since July 1956, the Committee on Merchant Marine and Fisheries of the U. S. House of Representatives has been conducting a nation-

wide study of recreational boating under the chairmanship of Representative Herbert C. Bonner of North Carolina. It is giving serious consideration to this matter and to what legislation should be in order.

▶ **DO YOU CONDUCT A RIFLERY PROGRAM?** If so, please let us know about it. We would like to carry a "what's doing" article on this subject in our September issue, if possible. Send us about two hundred words and a picture that we can share with others!

▶ **THE 84TH ANNUAL FORUM** of the National Conference on Social Welfare will be held in Philadelphia May 19-24. Some one hundred and twenty-five meetings of separate welfare organizations will be included. For further information, write to National Conference on Social Welfare, 22 West Gay Street, Columbus 15, Ohio.

▶ **REMEMBER JUNE IS NATIONAL RECREATION MONTH!** Watch your NRA Membership Letters for program ideas!

▶ **APRIL IS USO MONTH**, and is so designated as a reminder to the American people of the need for continued appreciation and support for our youth in the armed services. As it has from the beginning, USO continues to bring to the serviceman that important home-away-from-home, and the same sort of social, religious, recreation and education programs available to him in his own hometown.

The Drag Strip Check

The check on hot rods, conducted by the National Safety Council, as mentioned on page 463 of the December 1956 issue of RECREATION, is completed. Nearly four hundred replies were submitted from forty-eight states. Based upon this the council has made the following recommendations on hot-rod-ding and drag racing:

The National Safety Council opposes speed contests. Since speed violations are so often involved in traffic accidents, the National Safety Council cannot condone speeding even in the name of competition.

The Council feels that public interest would be better served if the energy and enthusiasm now devoted to drag racing were channelled into more constructive activities. Economy runs, driver clinics and leadership in traffic safety programs are examples of desirable outlets for interest in automobiles and driver ability.

Although clubs known by the general term "hot rod" often engage in many worthwhile activities it is apparent that the chief purpose of such organizations is promotion of racing events.

The National Safety Council therefore recommends that traffic authorities and safety organizations refrain from endorsing, supporting, or participating in speed events. ■

What are Today's Campers *Missing?*

Eugene L. Swan, Jr.

IT WILL BE easier this summer to find a camp that teaches a child French, dancing, or spelling than one where he will experience the irreplaceable lessons of the wilderness. Baseball, which can be played in the midst of a roaring city, will occupy ten thousand more hours than forest travel, and miles of motion picture film (most of it second-rate) will come between campers and the real thing around the campfire. By summer's end only a comparative handful will have slept in the open for more than a few nights or experienced any more campfire cookery than that suburban treat, the cook-out.

Well, what of it? Our camps teach many things and teach them well: swimming and sports, sailing and tennis, riflery, nature, crafts, and horse-back riding. What more can be asked? It is the child's vacation and the decision is left up to him. If he wants movies, radio, and the mechanical and competitive amusements of our times, why deny him?

But we *do* deny him! We deny him something of inestimable value, something a camp can do better than anything else.

George Washington grew up a long time ago in a world very different from ours, but he possessed qualities we still value, that we hope to see blossom in our children: serenity in the face of disaster; courage with modesty; utmost self-reliance joined with utmost respect for others; unshakeable determination and practical idealism.

Where did this great leader get his character? Samuel Eliot Morison, historian and author of a penetrating essay, "The Young Man Washington," writes: "He had the advantage of a discipline that few of us can get today. We are born in crowded cities and attend crowded schools and colleges. We take our pleasure along crowded highways and in crowded places of amusement. . . . What our New England forebears

learned from the sea. . . . Washington learned from the wilderness."

It is true, of course, that the opportunity to learn in the trackless classrooms of the "University of the Woods" is gone forever. But we still have a school with vast resources that can teach us if we will allow it to. Even today in populated New England, alone, there are more than twenty-one million acres of forest all within a day's drive of our back doors. Not only are these millions of acres a great natural resource, but also a spiritual one which is ready to teach whoever goes to these forests in the right frame of mind. The lessons will be the same as those once taught Washington, and which for over a hundred years were the birthright of every American.

But we must go into the woods to find ourselves, not to escape ourselves. More Americans are spending more time in outdoor recreation than ever before. We go skiing on crowded slopes, allowing ourselves to be hauled up by machine. We fish restlessly from place to place. We hunt so carelessly that we only maim the game and sometimes kill each other. We foul picnic spots and lake shores with refuse and broken bottles. We set up public-address systems in our campsites.

Who is at fault? No one — and everyone. All of us — parents, camp leaders, children — have let ourselves lose our way in a jungle of competitive skills. Too many have lost the know-how of woodcraft, and interest in it.

What can we do? The first thing is courageously to get rid of many things we consider necessary. It would be foolish, of course, to rip out a lighting system, and, yet, let us consider that without it we are more apt to go to bed earlier, enjoy more sunrises. Without it we are not tempted to fall back on radio and motion pictures for recreation, and are thus led to discover forgotten inner sources of creativity.



To explore the world of nature and its secrets, know the fields and hills, is the birthright of every American boy.

The remedy lies always on the side of simplification, of less equipment, not more, of tightening standards and lessening competition as an end in itself. And it has already proved itself.

The state of Maine, for example, has a program for boys and girls that has been in operation, without fanfare, for several years. In it, children as young as fourteen may take an annual three-day field trial in woodcraft. Their judges are skilled woodsmen and guides; and those who pass the tests receive a certificate as a "Junior Guide" from the governor of the state. More than one boy or girl has come out of this experience, whether certified or not, with a visible growth in character.

Another New England camp has taken on the exacting responsibility of maintaining a part of that remarkable cooperative venture, the Appalachian Trail, a footpath which runs for two thousand miles from Maine to Georgia, and is the work of volunteers.

Parents must be willing to take a stand for honest values against showy equipment and programs, lazy, beach-club months of idleness, and get-rich-quick summer jobs. Directors and governing boards must reassess the purposes for which their camps are run, and even government itself must recognize what we are missing. ■

Condensed and reprinted with permission from "George Washington Learned Here," *The Educational Register*, 1955-1956. MR. SWAN is director of Pine Island Camp, Belgrade Lakes, Maine.



Campers are offered experiences that parallel, in many ways, those of resident camps. The program is planned to meet their needs.

The Personal Touch in Day Camping

Patrick J. Carolan

Is this possible with large groups, in a non-resident setting? This is the story of an unusual private day camp.

THE personal touch—evidenced by a genuine interest in and concern for the growth and happiness of a given boy or girl—is assumed to be an integral part of the philosophy of well-organized resident camps. The overnight camp setting provides round-the-clock opportunities for realizing this goal. Twenty-four hour responsibility makes for closer personal contact between the administrator, staff, and camper. However, the day camp can also offer warm personal contacts.

In the child's eye, the professional staff person represents his parents, teacher, or favorite uncle during camp. Rare is the counselor who has not felt the warmth and devotion of a child's response to an interested approach. No experience can ethically be overlooked, therefore, which might benefit the child physically, emotionally, mentally and socially.

This is consistent with the social purpose inherent in the modern concept of camp administration. Hedley S. Dimock states, "This sense of public duty and social responsibility takes priority over personal interest (of administration) or economic gain . . . This means that he (the camp director) will not enroll any camper unless there is a reasonable ex-

pectation that the camp is equipped to meet the camper's needs."*

The discriminating parent is becoming increasingly aware of his child's need for individual attention and opportunity for growth, above and beyond a balanced diet, adequate physical facilities and equipment, and careful group programming.

Is it feasible, then, for the administrators and owners of large *day camps* to work toward the attainment of this worthy goal? Their situation is very different. Practical limitations in terms of concentrated time, continuity of contact, and other factors distinguishing the typical day camp from the overnight experience, make the problem a difficult one. The challenge is sufficient to tax the ingenuity of the most conscientious day camp owner. In view of this, it is unusual and unique to find the "personal touch" as the guiding theme motivating the administration of a large and thriving day camp.

Camp Baumann, with sites at Oceanside and Merrick, Long Island, New York, is a private co-educational day camp exemplifying this approach. A personal interest in each camper permeates the atmosphere of the camp. Beginning with the initial inquiry by an interested parent, the permanent personnel dedicate themselves before, during, and after the season to knowing the camper as an individual personality. This attitude is transmitted to the summer

* From *Administration of the Modern Camp*. Hedley S. Dimock, Editor. Association Press, 1948, page 269. \$4.00.

Camp Baumann operates day camps on two sites, Oceanside and Merrick, Long Island, New York. Total area encompasses twenty-three acres. Camp enrollment for 1956 totaled one thousand boys and girls ranging in age from three to twelve years. Facilities are excellent. The children are transported to and from camp daily by bus. The camp day is from 9:00 A.M. to 4:15 P.M.

DR. CAROLAN is a member of the department of health and physical education at Brooklyn College, Brooklyn, New York, and an assistant supervisor at Camp Baumann, Merrick, New York.

staff with the ultimate aim of providing the best possible communal experience for the boys and girls in a pack or group best suited to their mutual needs.

Nor are efforts to secure the personal touch limited to the eight-week summer camping period. In this respect, there is perhaps an advantage lacking in the resident camps, in that extra-season visitation is convenient. The central location and accessibility of the camp in relation to clientele makes possible a year-round, open-door policy for renewal of acquaintances, pleasant reminiscing, dissemination of information, tours of the grounds, discussion relative to policy, plans, or improvements, and the all-important parent-child-administrative evaluation of the individual camper in relation to the total experience. The camp's offices are open all year and the permanent staff (secretaries, program director, owners) is available full time throughout the year for the above purposes.

An individualized program requires serious, continual thought, perpetual evaluation, and purposeful planning. Specifically, many things are done in a conscious effort to implement the personalized approach. We, at Camp Bau-mann, feel that our efforts are very much worthwhile. The results are obvious where they really count—the needs of children are being met; they have fun.

Here are some of our ways of approaching this idea:

Year-Round Efforts (Off-Season)

1. Birthday cards with camp motif are sent to each camper.
2. The camp newspaper is sent four times a year—keeping campers and parents up-to-date on camp developments, counselor doings, and so on.
3. An annual camp reunion is held. In 1956, during Christmas holidays, a roller-skating party was held in a local skating arena.
4. It's a small world. In suburban communities chance meetings, just about anywhere, are an occasion for "camp talk."

Enrollment Procedures

1. Each new camper is met *personally*.
2. Invitations are extended to visit the camp several times prior to the opening of the season to become familiar with the camp environment and meet permanent staff.
3. An individualized file card is maintained for each camper. All pertinent data is noted for referral and guidance.

Pre-Camp Preparation

1. At staff orientation sessions, the need for giving individual attention to each child is explained and stressed.

2. A handbook containing details of camp operation and philosophy is given to each staff member as a self-study guide.

Homogenous Grouping

1. Children are grouped according to age and maturation level. Age differences within groups amount to a three-to-four-month maximum.
2. Youngest groups (three to five years) are mixed. Groups ranging from five through twelve are separated according to sex.
3. Groups number from ten to twelve children.
4. Shortly after beginning of camp, groups are revised to better meet needs of certain children.
5. Each group is assigned a counselor who remains with that group for the duration of the camp experience.
6. A supervisor is in charge of every seven to eight groups. As a matter of policy he, too, keeps a record of individual notes pertaining to children within his jurisdiction and follows through upon recommendations.

Individualized Health Practices

1. Medical examination of each camper plus a doctor's certificate of health is a must.
2. A camper absent three or more days must furnish a doctor's statement of health before readmittance to camp.
3. Each camper has a cumulative medical file upon which all pertinent data is listed. Heights and weights are checked at the end of camp to note progress made.
4. Individual diets or modifications of regular meals are adhered to if at all possible. The nurse assumes responsibility for this in cooperation with the dietician. ➡

Camp projects call for initiative, stir the imagination. What child can resist a tree house?

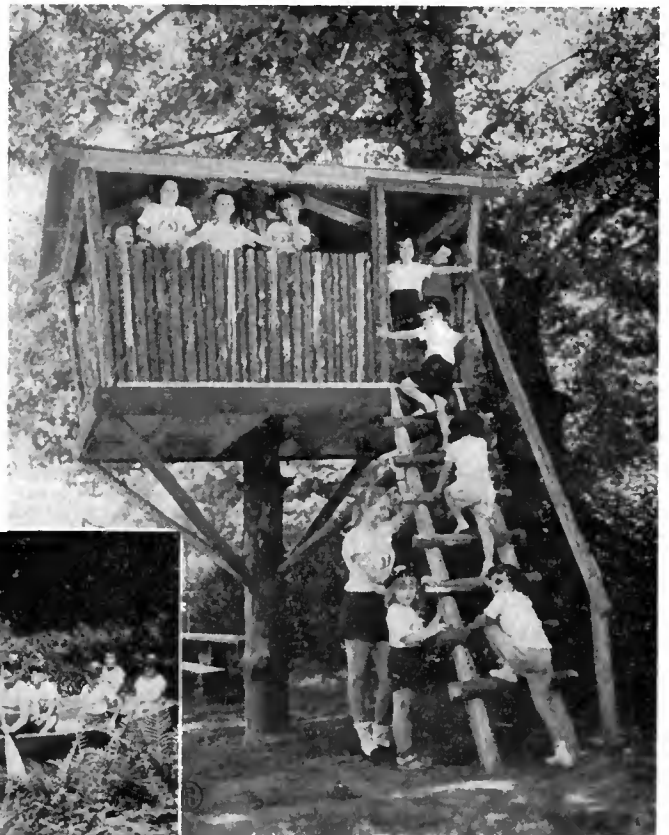

Adventures can be found via the water — be it on pond, lake or stream. Boating enables the camp to take off for magic lands.





Although in a heavily populated area, camp's physical facilities offer plenty of space and a rustic atmosphere for many lively youngsters, ages from three to twelve.

5. As a matter of policy, the camp nurse follows up all cases coming to her attention. Parents are kept informed by phone or by the bus counselor. Parents are queried regarding any camper absent three or more days. Owners personally check through on all prolonged absentees.

Camp Operation (Individualized)

1. Program is planned to meet the interests and capacities of various age groups. Similar groups participate together. Adjustments are made to accommodate younger groups and, at same time, fulfill their desire to emulate older children—batting off a tee in baseball, using lower baskets in basketball, separate and appropriate facilities for youngest groups, and so on. Instructors teach all organized activities, enabling counselors to concentrate upon *individual* progress and growth through the medium of the physical or cultural activity. Observation of the child's reaction to varied activities helps the counselor to understand competencies possessed or needed by members of his group.

2. Facilities and equipment in general are geared to meet the needs of age groups involved.

Personal Guidance (Adjustment Problems)

1. Although tuition refund insurance is available, every effort is made to discourage "dropouts." This policy provides one of the most fertile areas for exercising the "personal touch." Problem cases, involving temporary adjustment difficulties, in some school and camp situations, are often handled via the path of least resistance. Dropping a child seldom solves the problem. We make every effort to work out a solution acceptable to all—particularly the camper. It is not unusual for the owners, director, supervisor, counselor, and nurse to confer with a given child at a time of difficulty. Patient investigation, firmness when required, and a variety of approaches by trained adults are sufficient a great majority of the time. Occasionally, parent-owner conferences are advisable. In some instances consultation with professional people in the community (school psychologist, family doctor, and others) is arranged for the purpose of gaining insight into the most effective approach toward adjustment. Characteristically, those children with

adjustment difficulties become our staunchest friends when the problem is ironed out.

2. Each counselor receives a pocket-size book within which he records all significant information relative to each child within his group. This includes daily progress reports, parental instruction, health notes, and so on. These reports are checked periodically by supervisors. Problem cases are discussed.

3. Birthday parties are held during camp hours (at snack time) for each camper whose birthday occurs during the season.

4. All staff members are addressed as "Uncle" or "Aunt." This creates a "one big happy family" atmosphere. Children respond enthusiastically to this approach. It carries over beyond camp many times. Chance meetings during the off-season begin with a "Hi, Uncle John" greeting—with nary a relative in sight!

5. Rosalind G. and Robert E. Baumann, owners of Camp Baumann, attribute the unique success of their venture to the "personal touch." They know that a child in a camp must have fun, a parent must know that the child's best interests are being served. Camp ownership becomes a rewarding vocation, in fact akin to an avocation, when "people" come first and genuine fun prevails. They make it a point to know the campers. An attempt is made to talk to each child individually and informally during the season, and on the last day of camp as part of "teepee talks." They often take part in swim sessions during the day, ride horseback with groups, and engage in impromptu challenge matches in the various activities.

6. The boys and girls are given numerous opportunities to exercise initiative and imagination in camp projects—the newspaper, camper shows, special trips, designing of teepees, planning of non-scheduled hours are examples of special events involving counselor-camper planning.

The permanent staff gives much thought to the various practices enumerated above. Evaluation is continuous, as it should be. The search for new insights, better ways of getting closer to the ideal approach is constant. One thing appears certain: complacency can never be the order of the day for day camping. ■

Baseball diamond. Daily instruction and practice is carried on in some thirty-one athletic, social, creative, manual and nature activities with many special events.



The Mentally Retarded at Camp

*Community teamwork
is vital . . .*

Roland Larson

young adult; Fraser School, a private school for retarded children in Minneapolis; the state institutions at Cambridge, Faribault, and Owatonna; and public school special classes in Minneapolis. Their chronological ages ran from eleven to fifty-one. The youngest group, from the public schools, ranged from eleven to fifteen. The other groups were almost entirely in their late teens and early adulthood. Intelligence level ranged roughly from IQ scores in the forties to approximately eighty. There were no so-called "custodial cases."

One of the first tasks was to provide a feeling of security for each camper in his new surroundings. Rather detailed orientation to the camp, the staff, and to the other campers was an important part of this process. Five simple basic camp rules were explained in detail and repeated until thoroughly understood. Also basic in the establishment of a secure environment were the staff members' attitudes toward the campers. Pressures and tensions were at a minimum.

The camping periods in 1956 ran for a total of about one month. Three

six aluminum boats. Learning to swim or row can be a real thrill and is part of the process of becoming a good camper.

Silver Lake Camp for the Mentally Retarded came into being as the result of the hopes, dreams and concrete plans of a number of people and organizations keenly interested in the total problem of the mentally retarded. The Salvation Army provided the initial interest and offered to donate the campsite with its many fine facilities, and furnished all the food and the services of a cook. A camp committee was organized. Opportunity Workshop of Minneapolis, Hennepin County Welfare, the Salvation Army, and the Minneapolis Association for Retarded Children were represented. Through a series of meetings many problems were discussed and solved—camp fees, transportation, staffing, program.

Money was received from various sources to meet expenses. Camp fees were set at ten dollars per camper per session for those able to pay. Those from institutions were invited on a non-paying basis. Some children whose parents could not pay were sponsored by business concerns or individuals. The local association for the mentally retarded made a substantial contribution, as did the PTA group of a local private school for the retarded.

Campers came from Opportunity Workshop, Inc., a training center and workshop for the retarded youth and



Silver Lake Camp is an island camp, reached by a bridge, and therefore provides ample opportunity for boating and many waterfront activities.

SILVER LAKE CAMP for the Mentally Retarded is in Minnesota's lake country, near Minneapolis. Its five nicely wooded acres are completely surrounded by water, for this is an island camp. It is here that mentally retarded children and adults come together to work, play, and grow into better individuals. Here they become real campers.

Come across the bridge from the mainland and take a closer look at the island. You will see five cabins, three on one finger of the island and two on the other finger — providing a natural geographic separation of the sexes. Each cabin has running water and toilet facilities. There are additional accommodations for staff members. A dining hall seats forty-two, and a main lodge offers ample space for inside activities.

A play area for softball, basketball, volleyball, badminton, croquet, also equipped with swings and a trapeze bar, is located between the cabins. In the recreation hall are table games, a piano, and craft supplies.

Waterfront facilities on the mainland make swimming and boating two of the more popular activities. At the camp's disposal are a splendid sandy beach with a dock, diving boards, and

MR. LARSON is a school counselor, a certified psychologist, and has been director of Silver Lake Camp for the past two years.

groups of from twenty-three to twenty-eight campers attended. The youngest group stayed four days, while older groups had a ten-day session. The younger children from the public schools were a constant challenge because of their vitality, lack of experience, and desire to do things. In contrast, the older campers from the state institutions settled right down. Their program was planned so there was ample time for chatting, fishing, singing around the piano, and relaxing in other ways.

A daily rest period after lunch was felt to be necessary. Most campers required a great deal of sleep, particularly when the day included much physical activity.

Waterfront activities, simple games and crafts were greatly enjoyed. Evening programs put on by the campers included piano, harmonies, dance, vocal numbers, and other entertainment. The amount and degree of talent was quite surprising, and the camper's joy of performing for the group was strongly evident. The demand for more evening programs was ever present.

Group singing was encouraged, and a number of camp-type songs were repeated frequently enough to be learned by all. Songs with hand motions proved to be most popular. Singing was spontaneous and occurred after almost every meal and at all informal get-togethers of the group. Songs could often be heard while boating, walking to the beach, or getting ready for bed at night.

With the younger children stories before bedtime were popular. After a day packed with activity, these helped prepare the children for restful sleep. Most of the stories were at the lower elementary level.

Some of the older boys and men participated in their first overnight camping trip. They took real pride in cooking their own meals and pitching their tents on nearby Turtle Island.

Because Silver Lake Camp is an island camp, it provides for either separation or integration, in terms of programs and activities, with an adjacent mainland camp for normal children. Many times we wanted our group to be by itself. On the other hand, a number of daily activities were carried on with campers from the mainland camp —

such as flag raising, canteen, and numerous evening programs. This flexibility gave the retarded groups ample camping experiences with normal groups, while spending most of their time in a program specifically designed for their own needs.

Since the retarded were so often involved in activities with normal groups from the mainland camp, it was important that the staff from this other camp be oriented to the island group. Under Mrs. Herbert Martin, this orientation was accomplished in such a way that relationships between island and mainland campers were smooth and natural.

The ratio of campers to staff was about four to one. This favorable ratio gave counselors adequate time to work with individuals in specific situations. Close supervision was often necessary for the physical safety of the campers. Someone had to see that those under medication received their pills regularly; campers subject to seizures often had to be watched closely, especially while boating and when in or near the water. Close supervision also was necessary to preserve the unity and good feeling of the group, particularly with the younger campers. Scraps would arise at the slightest provocation, partly because of the poor judgment and lack of control which characterized so many younger campers. Having ample staff to enable campers to verbalize their difficulties proved to be a valuable facet of our camp setup.

The training and experience of the six staff members was quite diverse. One counselor was a teacher of the mentally retarded in the Minneapolis public school system and a second-year counselor at the camp; another was from the field of social work, with experience in group work, nursery school, and homebound teaching; a third had worked as a nurses' aid and a camp counselor with the retarded for a year; and so on. This variety in staff background often gave fresh and interesting insight into the multitude of problem situations which arose.

The dynamics of group activity were always interesting. What was happening to the individual camper as a member of the group was one of our greatest concerns. Nightly staff meetings helped each staff member grow in sensitivity to individual needs. Observations and ideas were exchanged constantly. Much information on individual campers was obtained from camp application blanks and medical examination records.

We know that lifelong patterns could not be changed in a few days, but we did find that progress was made when concentrated attention was given to a particular camper's problems. It was a real thrill to watch certain individuals progress in behavior, attitudes, skills, and self-confidence as they achieved new things.

An individual evaluation was made of each camper's experiences and growth at camp. The areas evaluated included social, physical and personal adjustment, work habits, and progress in art, music and crafts. All members of the staff took part in these ratings, thereby giving a more composite picture than any one person would be able to do. Two copies of each evaluation were made, one sent to the institution, school, or social worker in charge of the retarded person, the other copy retained for the camp files.

For communities wishing to initiate a similar program it should be pointed out that there are many potential workers whose energy and enthusiasm may be tapped to get such a project started. Community teamwork is vital. It has been the key to the camping sessions for the mentally retarded at Silver Lake. ■



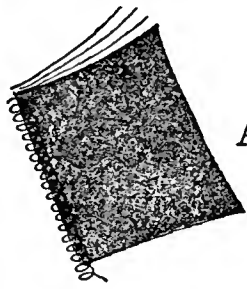

A REPORTER'S NOTEBOOK

NRA Welcomes and Bids Farewell

Anne L. New and Frank J. Rowe have recently joined the National Recreation Association headquarters staff. Miss New, formerly coordinator of Public Information Services for the Girl Scouts of the U.S.A., is replacing David J. DuBois as director of NRA Public Information and Education. Mr. DuBois is on leave of absence for an assignment as public affairs officer for the United States Information Service at an overseas post. Mr. Rowe, previously with the circulation department of the Crowell-Collier Publishing Company, replaces Alfred B. Jensen as head of the NRA Recreation Book Center. Mr. Jensen is joining the staff of Doug Johnson Associates, a public relations and advertising agency in Syracuse, New York, as general manager.

All-America Cities Awards

Forward strides in recreation brought awards for five of the eleven municipalities winning honors in the 1956 All-America Cities Contest, sponsored by the National Municipal League and *Look* magazine. The five cited for recreation progress were:

Anchorage, Alaska, where expanding military bases have helped triple the local population (11,254 in 1950) in the last six years. Among the expanded municipal facilities are new parks, a municipal auditorium, a library and a YMCA.

Zanesville, Ohio, where a campaign against civic apathy led to opening of a new city park and a clean-up drive that won it the title of "Cleanest Town in America" in a nation-wide contest.

Brattleboro, Vermont, where virtually every civic organization helped achieve a new park financed by a war memorial fund and \$115,000 bond issue. The local women's club developed such an excel-

lent picnic area for the park it won an award in a Community Achievement Contest sponsored by the National Federation of Women's Clubs and Sears Roebuck Foundation.

Torrance, California, where model planning is meeting the needs of a population (31,834 in 1950) that has quadrupled in the last six years. Among other developments it is vigorously building new parks. (Torrance's solution to the problem of recruiting needed recreation personnel for its population influx is explained on page 106 of this issue.)

Oakland, California, where an extensive urban renewal program has greatly expanded park and recreation facilities.

Never a Corner so Remote . . .

Recreation is a basic need of even the most primitive society in the most remote corner of the globe. This is proven by the dance, drama, religious, arts and crafts activities presented during an extremely popular lecture-demonstration course, impressively entitled "Cross-Cultural Study of the Leisure Hours of Man in Remote Regions of the World," now being given by the Museum of Natural History, New York City.

This year the focus is on surviving aspects of ancient Oriental civilizations and continuing forms of primitive cultures. Ethnic dance specialists will perform dances from Japan and India as

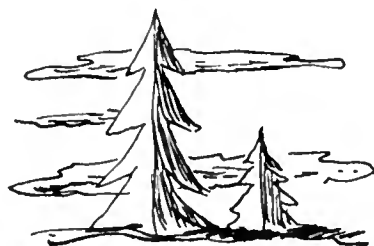

well as Caribbean dances of African origin. Special museum films will show life and recreation in the remote reaches of the Amazon and among the Australian aborigines.

The course is conducted by C. Bruce Hunter, superintendent of the museum's adult program, with the help of many guest specialists during the fifteen two-hour sessions.

Wilderness Adventuring

Two private camp organizations offer unusual wilderness camping opportunities for youth:

A camping experience which thoroughly explores the wilderness sectors of America and offers opportunity for travel camping, sailing, mountaineering, hiking, pack trips, skiing and canoeing is the program offered each summer to boys and girls of high-school age by the Explorers' Caravan Trips. For further information write to: Dr. Richard E. Stultz, Director, Explorers' Caravan, 965 Lancaster Avenue, Syracuse 10, New York.

Rugged adventures into untouched areas are offered by The Trailsmen trips for boys of eleven through sixteen. In addition to trail journeys, these campers visit government projects, fire-towers, processing plants and similar agencies to learn more about the ways nature and civilization work together today. For further information write to: George Thompson, Trip Director, The Trailsmen, 2600 Willowbrook Drive, Cincinnati 37, Ohio.

To Fill the Gap

Oddly enough, an economic setback will mean increased recreation development in the Finger Lakes region of upper New York State. Forced to develop new resources and stimulate business because of loss created by drastic cutbacks at Sampson Air Force Base on Seneca Lake, officials of the area are studying a blueprint to develop the area as the "playground" of all New York State. The state commerce commissioner has called on business and civic groups in the area to help expand park facilities, clean up pollution in the lakes, improve the area's already superb fishing and preserve the beautiful old trees in the cities and villages and along highways. ➡

IBM in Recreation

The results of a new project initiated by the Springfield (Ohio) City Council will be interesting to watch. The names and addresses of participants in nineteen programs sponsored by the city recreation department were tabulated on IBM cards and a list of over 4,700 names and addresses was compiled. A letter to adults and parents of participating children will be sent . . . to make citizens more aware of the year-round recreation program. . . . People will be invited to offer their suggestions, criticisms and comments on the present program and future activities.

The alphabetical listing of names will give the recreation department the first complete check on the total number of different people who are reached by its recreation program. In addition to names and addresses, the IBM listing gives a code number designating the program in which that particular individual took part. As new persons join activities, these will be added to the present file. — From *Sounding Board*, Ohio Recreation Association.

High School Photo Contest

Both quantity and quality of entries received so far in this year's National High School Photographic Awards indicate that students are showing an increasing interest in photography. This year's contest, the twelfth such annual affair, will run through March 31, 1957. Any student attending daily a public, private, or parochial school (grades nine through twelve) is eligible to submit photographs. Judging will be done in four classes: (1) school activities; (2) people (outside of school); (3) pictorials; and (4) animals and pets.

As in previous years, a selection of winning photos will again be collected into a traveling exhibit available to schools on loan without charge.

School Building Expenditures

Building expenditures for new public schools will jump fifty-six per cent by 1966 predicts the building magazine *Architectural Forum* in its December issue. Current construction expenditures of \$2,500,000,000 will rise over the next ten years to an annual rate of \$3,900,000,000 in 1966, at which time "schools will probably just be starting

on another round of expansion."

Projections are based on a 1966 population estimate of 197,000,000 people, and a projected gross national product in the year of \$575,000,000,000 (in 1956 dollars).

In a Children's Hospital

A highly developed recreation program is carried on at the Children's Hospital in Cincinnati, Ohio. Staffed by six full-time workers, this program offers morning, afternoon and evening activities. In addition to three people trained in child development, two in elementary and art education, and a trained nurse-aid, some forty volunteers do two or three hours' work twice a week. A full-time librarian is in charge of the children's library, which has nearly 3,500 books.—*Child Study*, Winter 1956-57.



Bicycle Safety Plan

Three out of every four American youngsters between the ages of six and fifteen ride a bicycle; every nineteen minutes one of these youngsters is injured—and at least once a day one is killed—in collisions with automobiles.

To protect these youthful users of public streets and highways, the Association of Casualty and Surety Companies, at the request of state and municipal government officials throughout the nation, has announced the completion of a model plan for the organization and operation of a bicycle safety program—proper education, training and testing of bicycle riders and the inspection of bicycles to detect unsafe conditions—on a community level.

The plan is explained in a booklet entitled *A Community Bicycle Safety Program* for use in establishing community programs. Single copies are available

free of charge from the Accident Prevention Department, Association of Casualty and Surety Companies, 60 John Street, New York 38.

45,000 New Swimming Pools

An interesting recent *New York Times* news note stated: "The swimming pool industry expects to build 45,000 new units this year, a gain of thirty-six per cent over the 33,000 pools constructed in 1956.

"This prediction was made by Robert M. Hoffman, president of the National Swimming Pool Institute. He said that sales this year would rise to \$500,000,000 from the total of \$325,000,000 in 1956. The figure is based on construction of new pools, plus equipment for new and old pools.

"Almost two-thirds of the prospective 45,000 pools will be of the back-yard variety. . . ."

Bremerton Boating Facilities

Boating enthusiasts in Bremerton, Washington, (population 30,200) have a total of sixteen public boat launching areas on salt and fresh water within a twenty-mile radius of the heart of the city. This extensive network of public boating facilities is the result of cooperation between state and city governments, with the assistance of the Bremerton Boating Club and marine trade groups.

Pima Squares Off

More than 20,000 children and adults have learned square dancing during the past six years through Arizona's Pima County Parks and Recreation Department, which has cooperated with the Pima County Square Dance Committee in holding classes for beginners and intermediate devotees of this activity. Twelve Monday evening classes are held each fall, and another twelve-week course in the spring, for a total of twenty-four evenings of instruction each year. Since its inception in 1950, volunteer instructors have given a combined total of 6,912 hours of teaching. "Family Night" square dances, as well as instruction periods for children and adults, are also held year-round at several centers.—From the *Pima County Parks and Recreation Department General Report for 1956*. ■

Recreation at the South Pole



Are these things on *your* program for young adults, or service people?

Muriel McGann

OPERATION DEEPFREEZE is the Navy's name for the expedition now preparing to spend a winter in the Antarctic. The seven hundred men in Deepfreeze will be divided into seven groups, with some fourteen to two hundred men in each group. Once they have established their bases and the winter weather has closed in, each group will be completely isolated; no supplies can reach them and their only communication with each other will be via radio.

Morale—keeping the men at each base interested, alert and operating as a harmonious team—will be vitally important to the success of the expedition as a whole. The virus of boredom may be as potentially dangerous as virus pneumonia.

Since a task force wintering over in the Antarctic usually has an abundance of leisure time, the Navy Bureau of Personnel asked for suggestions from veterans of previous expeditions, as well as from the volunteers for Deepfreeze. What recreation materials should be included in the expedition's list of supplies and equipment? The resulting compilation has many interesting features. (It should be remembered that these were not the supplies actually approved for shipment, but the items requested by the members of the expedition or mentioned as worthy of consideration by others.)

Perhaps most noteworthy is the heavy emphasis on music. More than

one thousand albums and single records were requested by number and title, almost evenly divided between classical and popular selections, with a slight majority asking for popular and jazz numbers. Selections ranged from Caruso to Elvis Presley, and from *Götterdämmerung* to *My Fair Lady*. Also requested were recorded plays by Shakespeare, T. S. Eliot and Noel Coward, such reconstructions of history as *I Can Hear It Now*, and Bible readings, with those by Charles Laughton being mentioned specifically. Tape recordings were listed and the selections mentioned followed the same pattern of classical and popular music, songs associated with colleges or with religious worship, poetry and Bible readings.

The interest in music was by no means entirely passive. Fourteen instruments and lesson books to accompany them were listed, including drums, harmonica, accordion and electric organ.

Appreciation of the opportunity for learning was also apparent in the book list. Textbooks predominated, virtually all the books needed to offer a fairly comprehensive academic, business or vocational high school or college course being included. Among the texts mentioned were books on journalism and news reporting; psychology, sociology and criminology; languages, Japanese, Chinese, Russian and Portuguese; agriculture; auto mechanics and aeronautics; carpentry, masonry and welding; foremanship and supervision; salesmanship and advertising.

More than one hundred and fifty

books were specifically requested by title. They included adventure, detective and crime stories, biography, history, philosophy, and a wide variety of other interest areas. English and foreign language dictionaries were listed, as were an atlas, an almanac, the *Encyclopaedia Britannica*, a complete Shakespeare, and the Douay and Revised Standard Versions of the Bible. Comic books were requested, as well as books containing arrangements of music for male quartets and male choruses.

Periodicals were an important part of this reading list for long winter evenings. Sunday newspapers from New York, Los Angeles and New Orleans were mentioned, in addition to popular weeklies and monthlies such as *The Saturday Evening Post*, *The New Yorker*, *Reader's Digest*, and *National Geographic Magazine*; religious, sports and hobby magazines; service journals; how-to-do-it and crossword-puzzle magazines. The list also included the Sears Roebuck catalogue—although delivery service might pose a serious problem, even for Sears Roebuck!

Movies are too firmly entrenched in American life to be omitted, regardless of the distance to the nearest drive-in. More than one hundred and forty pictures were asked for by name. The majority were recent productions but the following movie classics also were mentioned: Lon Chaney in *The Phantom of the Opera*, Rudolph Valentino in *The Son of the Sheik*, as well as *Gone with the Wind*, *The Shape of Things to Come*, *Ninotchka* and *It Happened One Night*. Animated cartoons

MRS. MCGANN is a member of the NRA research staff.

rounded out the usual movie program.

Since the Antarctic continent is somewhat beyond the range of any existing television station, some of the group evidently hoped to keep up with their favorite programs by reviewing past episodes. Films of Sergeant Bilko programs, *Dragnet*, *Robert Montgomery Presents*, *The Way* and Christopher Movement productions were listed, among others.

Hobbies will flourish at the Deep-freeze bases if even a small percentage of the requested supplies can be transported to them. Among the types of equipment mentioned were: leatherworking and lapidary kits; metal and woodworking tools; equipment for building and operating model planes, cars, boats and trains, including transformers and gas or electric motors; materials for oil and watercolor painting, and carving; equipment and instruction manuals for ham radio stations;

equipment for gunsmithing, fly tying and horticulture (the latter to consist of one cubic yard of sterile dirt per gardener, Vigoro, sun-lamp bulbs, a watering can, and lettuce, carrot and radish seed).

Less solitary forms of recreation also have a place in the ideal Antarctic program. Thirty-one games for two or more players were named—card games, carroms, dominoes, mah-jongg and Monopoly; and more active games, such as badminton, darts and Ping-pong. Pool and shuffleboard tables were mentioned, and the devotees of Lady Luck hoped to woo her with poker chips, dice, roulette wheels and pinball machines.

The amount of space to be made available for active sports at the bases was not specified, but some of the volunteers apparently had high hopes, for they requested equipment for archery,

baseball, football, golf, softball, and target shooting, in addition to boxing, handball, horseshoes, medicine ball, volleyball, weightlifting and wrestling.

Holidays were not forgotten. Supplies for Christmas and New Year's were listed, firecrackers and sparklers for July Fourth, and enough candles to decorate a cake for each man's birthday.

The average recreation director will never be faced with a supply problem in which an omission is irrevocable, but he may still be able to learn something from this list. If music, hobbies, sports, the acquisition of knowledge, and the other activities recommended or requested for Operation Deepfreeze could make life tolerable—perhaps even pleasant—in the desolate Antarctic winter, surely they should be part of the basic program in every recreation department. ■



Westward Ho!

"Westward Ho!" will be the cry in your camp this summer if you want some good fun and adventure in your program. We provided it by thinking up a covered-wagon trip.

Twenty dollars bought an unused hay wagon from a local farm. Our eleven- and twelve-year-olds cut saplings and soaked them in water to make them pliable. The nine- and ten-year-old group

cut saplings with forks in them to attach on the wagon to carry pots and pans. Our teen-agers went at the assembling with gusto. They lashed saplings to the wagon, cut up an old tent and covered the wagon. The wheels were removed and greased for action.

A nearby farm provided the horse, who promptly became a camp character. The excitement, when the trip started,

was tremendous. The wagon carried the supplies and sleeping bags, and the campers took turns riding in the wagon and hiking along behind it, pioneer style. The route was planned by staff members to take advantage of dirt and little used roads, and the campsite was close enough so the horse could be returned to the farmer until the group was ready for the return journey.

This trip was the first of several using the wagon, as each group became fascinated with the idea of a covered-wagon trek.

Though our camp program offers many kinds of trips, this one was unique in that it was carried out in our own neighborhood. Needless to say, it stimulated arts and crafts projects by the score, an interest in folk songs, an awareness of the camp's environment, and hours of preparatory program.

We dismantled the wagon at the end of the summer and plan to reassemble it with this year's campers. It will provide new adventures. Try it for yourself!—HARVEY G. SEGAL, program director, Camp Weekeela, Hartford, Maine. Alan Krigman, an MIT student, one of the counselors on the covered-wagon trip, took the photograph. ■

Camping for Tomorrow

PARENTS AND EDUCATORS today recognize the values of camping for children, and it is now an integral part of the programs of most youth-serving, education, and recreation agencies. This recognition is based, at least in part, on a belief that "the good camp can be one of the most significant of educational experiences—an experience that may profoundly effect the physical, mental, and emotional outlook of the child."

Needs for the Future

Acceptance of the values of camping imposes upon camping leaders the moral responsibility for continuing high standards of service and providing camping experience for the future in accordance with needs as they may develop.

Some of the needs for tomorrow's camps will not differ from those of today. Children will continue to need love, adventure, recognition, a sense of "belonging," achievement, self-expression, and physical activity—unchanging needs which are a part of the very core of life. Camps are ideally designed to meet these needs through their small groups, their favorable camper-counselor relationships, their twenty-four-hour-a-day and seven-day-a-week programs, their basic relationship to the out-of-doors, and their infinite variety of activities. Meeting these needs of children must always be their first responsibility.

Camping needs through the coming years will be affected, however, by external aspects of our changing world. One of the most important of these is the tremendous growth in population.

Experts are now predicting a population in America by 1975 of two hundred to two hundred and ten million persons. In recent years, camp attendance has been growing at a faster rate than has the population. We now have camp facilities and programs to provide for eleven or twelve per cent of our child population between the ages of eight and fourteen. Because of the growing place of camping in the life of youth, we may well need to provide camping for fifteen or twenty per cent of this age group by 1975. Considering this possibility in the face of the rising population, there is reason to believe that summer camps will need to expand by thirty or forty per cent during the next eighteen years.

Scarcity of Campsites. As population expands, it becomes

increasingly difficult to find desirable campsites which provide the acreage, isolation, and program possibilities needed in camp. Camp agencies will encounter increased competition for land from those who seek private vacation sites, from resort promoters, and from commercial enterprises of various kinds. Therefore camps anticipating expansion should secure land as soon as possible. Man's ingenuity cannot manufacture more of this basic resource.

One acre out of every ten in the United States today is under the auspices of government agencies. Camping authorities may have to depend increasingly on these public land-holding agencies for the use of park-forest land which they may lease for long or short-term camping.

Outdoor Education and Camping. Outdoor education is recognized as a problem of education to help people to learn to use outdoor resources wisely, to understand biological principles, and to act as intelligent citizens in determining policies on resource use. In the schools it may take the form of classes, experiences in camps, or it may involve use of the out-of-doors on field trips in science and conservation courses as a laboratory of instruction.

This will undoubtedly have an impact on organized camping. More children will, as a result of outdoor education, be interested in camping and better prepared for it; camping programs can be more easily oriented toward outdoor living and learning; leaders with outdoor-related skills will be more numerous; and the understanding of camping values will be more widespread.

Increased Regulations. For many years voluntary agencies and the American Camping Association have been in the process of developing and implementing camping standards. This has done much to improve camping practices. A recent grant from the Kellogg Foundation to the American Camping Association will make possible the improvement of the standards implementation program on a national basis.

State agencies, particularly boards of health, have in recent years greatly tightened regulations governing camp operations. About twenty-eight states now have regulations governing summer camps, and several states have a licensing system. There is every reason to believe, as years go by, that the regulation of camping by state agencies will be increased, and that parents will learn to evaluate camps in terms of their ability to meet standards.

Community Planning. Many communities are now exam-

MR. CARLSON is professor of recreation at the University of Indiana, Bloomington, Indiana.

ing their total camping picture in terms of facilities, costs, and community responsibility for providing camping services. Each should attempt to upgrade its camping program in the light of present standards.

In any community study, the adequacy of present camping services should be considered in terms of present usage. Facilities and areas should be analyzed in terms of the size of the camp population, the extent to which they meet health and safety standards, the program, the leadership, and the inclusion of all social segments of the community.

Camp population trends as well as trends in the community's child population should serve as a basis for determining future needs. Many communities and camping agencies will need to secure land and develop master plans even though actual facility development is postponed for many years. Consideration should be given to the increased interest of schools in outdoor education and to the phenomenal advances in the day camp field. Agencies holding public land, such as parks and forests, should be studied in terms of the extent to which they can be developed to serve camping needs.

Leadership. A major problem during recent years has been the difficulty in securing a sufficient number of mature, qualified leaders. It arises in part from the various other summer opportunities for students and teachers. Many

college students who would like to go to camp cannot afford to pass by other opportunities which offer higher incomes. The number of college courses in camping and the number of students taking such courses have increased vastly during recent years.

The New Leisure. Vacations, shorter working hours, high incomes, and mobility have changed the leisure-time pattern of the American people. The millions who now use our public and private lands attest to this fact. This leisure imposes a responsibility on camping leaders to teach the arts of leisure that are outdoor-related. Eighty-five per cent of our people are not producers of food and fibre but are consumers and users of the outdoor areas. Learning to use the outdoors wisely and to conserve our forests and wildlife unimpaired for future generations is a paramount concern.

Camps must prepare to offer experiences to children that will train them for leisure, particularly leisure related to the use and understanding of the out-of-doors. Nowhere else but in the good home do we find the favorable combination of circumstances for helping youth grow that we find in camp. Every child should have the opportunity—at least once—of attending a good camp. The competition of other activities for a child's time should never be allowed to crowd out the unique experience of camping. ■

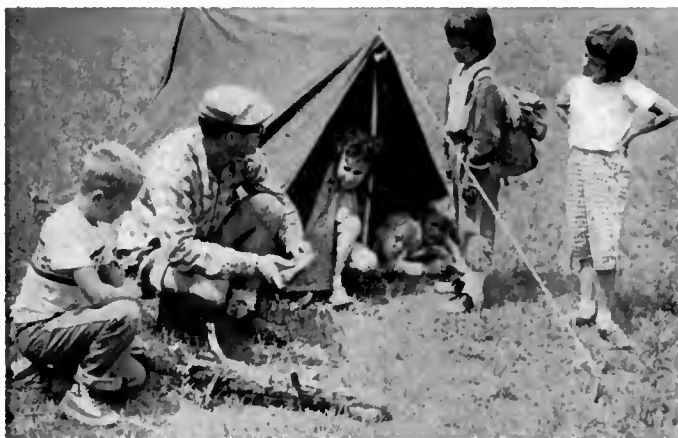

CHILDREN LEARN tent pitching early, also how to use knife and hatchet, in Two Rivers, Wisconsin. Above, a group listens to Eugene Ertman, campcraft specialist. This is a part of a day-camp program inaugurated last year by Fred H. Reich, former local director of recreation who is now teaching recreation at Wisconsin State College at LaCrosse. "The primary aim of day camping," says Mr. Reich, "should be toward group experiences in which children live and learn together by playing and creating with the simple tools at hand and the natural gifts of God in the out-of-doors."

The highly successful program in the Two Rivers day camp at Point Beach State Forest stimulates nature appreci-

Nature Study

in a

Playground Day Camp

ation through a knowledge of and familiarity with many of its parts—trees, birds, insects, plant life, minerals, and so on. (Aids for such a program are available from the National Audubon Society, 1130 Fifth Avenue, New York 28.) Among specialists conducting last year's program were an ornithologist, nature and conservation authority; a geologist, and arts and crafts instructor; a campcraft, soils and conservation specialist; and a compass and nature games instructor.

The camp is under the leadership of the municipal recreation department, and each Thursday a different playground in Two Rivers takes more than seventy-five children to the camp by bus. Throughout the day, the children learn by seeing, finding, smelling, hearing, and feeling the handwork of nature. They may continue these interests on the playgrounds and in the recreation center under supervised leadership throughout the year. ■

Campsite Selection, Layout and Development



Three-story lodge, Camp Crystallaire, Michigan. The lodge may include areas for recreation and dining, kitchen, food storage, lavatories, and space for offices.

Lewis C. Reimann

ONE of the most rapidly growing recreation - educational movements today is that of organized camping. Approximately thirteen thousand organized resident camps in the United States—and an almost countless number of day camps—cater to over four million children during the spring, summer and fall months. School camps which utilize some of these camp facilities during the school year, and are rapidly growing in number, add thousands more.

On the other hand, new campsites, in the more populated areas of our country, are becoming fewer and fewer as well as more costly.

Selection of Campsites

This is dependent upon many factors — geographical location, type of program to be conducted, centralized or decentralized, type of organization

MR. REIMANN has had extensive camp experience and is now a professional camp consultant. He is the author of *Successful Camp Administration* (now out of print) and *The Success Camp*, which will be published soon by the University of Michigan Press.

or agency using it, number of campers to be housed, nearness of the site to the base of the agency and the area from which the majority of campers are drawn. Terrain in various areas of the country will vary. Price of the land is a factor. Certain basic needs must be considered.

The American Camping Association standards suggest one acre of land (owned or available) per camper. This is the ideal, although less than that amount of land is actually used. Large acreage makes for seclusion, a feeling of space, and protects the camp from intrusion by the public, and from the cottages, resorts and social hazards, such as taverns and commercial amusement places as may be nearby.

Long-range planning, including possible increase in size of the camp or division into two or more camp units, is urged. With lake, stream, ocean and mountain sites being rapidly pre-empted by summer homes and resorts, it is advisable to secure large enough acreage initially for any possible future development or expansion. To buy a small site with the hope or expectation of purchasing additional adjacent land at a later time when money is

available or the need arises, is often too costly or impossible.

A rolling terrain, with some level ground for recreation, a safe lake bottom and a wooded area make for a desirable site. The soil and land slope should ensure good drainage after rain, and adequate sewage disposal. An excess of light, sandy soil is undesirable, particularly on sloping ground. Hard clay soil results in mud after rain and poor seepage for sewage disposal. The ideal is a firm, sandy-clay mixture which will soak up moisture and grow grass for firm footing for the thousands of feet which will walk over it during the season.

Swampy or boggy areas near the center of the camp site should be avoided. Such wet places are breeding places for mosquitoes. Although swamps and bogs are often a rich source of insect and water life, leading to opportunities for nature study and collections, they should not be close to living quarters. With modern earth-moving equipment, swales, swamps and bogs can be filled easily, hillsides leveled, and dikes and dams thrown up, to alter the face of the camp and add usable ground at comparatively

small cost.

The presence of a forest tract on the campsite is desirable for shade, nature trails, tree identification, cover for wildlife and for beauty. Scattered clumps of bushes and trees add to the site's beauty and utility. Some directors prefer to let shrubbery and trees grow naturally and wild without attempting to prune or cut them. Others plan landscaping; nature trails; tree, flower, and shrub identification labeling; reforestation; and soil erosion prevention.

Sometimes prevailing winds are factors to be considered in the location of the camp site. A deep "pocket" in a valley or in a heavily wooded area can mean uncomfortable conditions in hot or humid weather. If possible, a location where prevailing winds will pass over and through the camp should be selected. Such winds will also help to reduce insect life such as mosquitoes.

A realistic appraisal of a possible campsite should be made, item by item, and considered in the final decision for purchase or rejection. The campsite appraisal form used by the Girl Scouts of America is very practical and may be obtained at local Girl Scout offices.

Laying Out the Campsite

The camp layout must provide for several buildings and recreation areas. The central area provides for the lodge which may include the dining hall, kitchen, food storage, toilet and lavatory facilities for the kitchen staff and dietician's office. The lodge may also include headquarters of the director, program director, business manager and camp secretary, unless a separate building can be provided. It should be in easy access to all parts of camp.

The location of sleeping quarters for campers, cabins or tents, should be on high ground—to afford good drainage—and preferably with a view of the lake, stream or an over-all view of the camp or countryside. Some shade for the sleeping quarters should be considered, but densely wooded areas should be avoided. The sun should reach the cabin or tent at some time during the day. Underbrush should be cleared away from the cabin several feet on all sides, to reduce mosquito population.

In a decentralized camp, sleeping accommodations are usually placed in several groups, for different ages, separate from each other, yet not too distant from the center of the camp, to enable campers, particularly younger ones, to walk to the dining hall and activity areas within a few minutes. Good drainage is also important in the placing of these units. Nearby swamps and swales should be avoided or filled.

an isolated spot on the camp grounds, away from dust, noise and traffic, with good drainage and a good view.

An administration building to accommodate the business and program staff and camp headquarters should be placed where easily accessible to members of the staff and visitors as they come into camp, yet far enough from the sleeping quarters to avoid noises which might disturb the campers at



Dining hall and kitchen, Brownlee type. Location of a wooded area in or nearby the camp provides natural beauty, nature trails, wildlife cover.

Careful attention must be given to the drainage of the total site, particularly where the major activities are carried on. Tile and drainage ditches to take off rain water quickly should be installed where low areas exist. Sandy soil will absorb moisture readily but a heavy clay soil requires well planned drainage. The advice of local or district health officials is often available for this purpose. No standing water should remain on the grounds for a long period of time.

Physical hazards, such as poisonous weeds, sharp drop-offs of terrain, roots, holes, pits, pools, and the like should be eliminated before the camp is used. Poison ivy and irritating weeds can be eradicated with modern chemical sprays. Overhanging dead limbs and decayed trees should be removed. Old rusty fences, cans, bottles and trash present hazards. Negligence on the part of the camp operator in regard to removable hazards can result in damage suits if campers or members of the public are injured.

The infirmary should be placed in

night. This building may include a room as a gathering place for counselors during time-off and free evening hours. This room should be restricted to staff members only to give them privacy from campers.

Program and activity areas are of great importance. All program facilities are dependent upon the type of camp operated. In camps which emphasize games and sports, recreation fields on flat grounds can include space for softball, volleyball, basketball, field games, tennis courts and other facilities such as those for horseshoes, box hockey, and tether tennis. They should occupy, if possible, a place in the camp layout, easily accessible for formal, informal and "pickup" games.

If handcraft is a major activity, a spacious, well-equipped building is required. This structure can provide mere shelter with open sides; but in areas where there is considerable change of temperature or rain, the building should be enclosed. Separate tables and benches for different kinds of crafts are desirable. Pottery mak-

ing, ceramics and lapidary should have a separate room or separate space. A room where materials are stored and dispensed should be partitioned from the main craft shop. Good lighting by means of large and numerous windows is necessary.

In a camp which emphasizes nature collections, a museum building, open on the sides or completely enclosed, is a valuable asset. This building is placed in the shade, in a spot at the edge of or just off the central camp area.

A central recreation building can provide space for dramatics, all-camp meetings, worship services and other large gatherings. (A raised stage with side entrances adds much to the interest in and good production of plays, stunts and music programs.) In the absence of a recreation building the dining room can be used for these activities.

Since swimming is one of the most important and popular activities and skills taught in summer camps, be it in a lake, stream or swimming pool, special attention should be paid to this facility. The swimming area should

caying matter, and have a gradual slope to deeper water, with no sudden drop-off. The beach adjacent to the swimming area should be cleared of brush, weeds, grass and other hazards.

While isolation from resorts and built-up areas is essential, the roads to the camp proper should be such that the camp can be reached easily by car. Some camps depend upon bus service to bring the campers into camp, or to a spot nearby from which they can be picked up and transported to the camp.

The entrance road to the camp should be carefully planned and maintained. There should be only one such road, and that plainly marked with signs directing visitors where to park. A parking area should be provided, with parking rules strictly enforced to keep cars and trucks from cutting up the grounds. It should not encroach upon the campgrounds proper and preferably should be somewhat removed from them but not so distant that visitors will have far to walk.

Only one road should lead to the rear service entrance of the lodge or kitchen

or shrubbery.

Should a caretaker's residence be provided, it should be a winterized building, located at or near the entrance road to enable the caretaker to control ingress or egress of visitors.

If the camp acreage is ample, outpost campsites for day trips or overnight camping on the camp property can be provided. These should be carefully planned to afford safety, comfort and sanitary facilities. Small wooded areas should be cleared of trees or brush for pitching of tents or erection of shelters, sleeping space, cooking and campfires in a shaded or semi-shaded spot. Such outpost sites should avoid large trees which can be a hazard because of falling branches, windfalls and lightning. The number of such outposts needed depends upon the number of campers and the degree of emphasis on outpost camping.

Should the acreage of the camp property be too small for such outpost sites, it is usually possible to provide for them on adjacent property or distant places, either on lakes, streams or other desirable spots. Such locations can be found by exploring the country around and making arrangements with the property owners by means of verbal agreements or leases at a nominal cost. With more and more emphasis being placed upon overnight and out-of-camp trips, outpost campsites should be provided early in the camp planning.

Once a desirable campsite with the above layout possibilities is found, the next problem is to arrange for purchase and financing. Since good campsites are becoming harder and harder to find, because suitable property has been largely pre-empted by summer cottage and resort expansion, financing the purchase of a site and erection of camp buildings plus adequate camping equipment remains the most difficult problem for both agency and private camp operators.

In the search for a desirable campsite the assistance of real estate agents, county agricultural agents and conservation officials may be helpful. The agency or private operator should spend considerable time in searching out such properties and comparing them, using the above yardsticks to appraise them in terms of camp use. ■



Cabins and dining hall, Camp Tanuga, Michigan, have picturesque lakeside location. Site provides plenty of level ground for outdoor recreation.

provide for safety, sanitary conditions, ample and separate areas for beginners, advanced swimmers, and for special instruction. The use of public beaches and areas adjacent to cottages and resorts should be avoided. Special attention to possible water pollution from streams and adjacent property should assure proper sanitary conditions. The lake or stream bottom should be clear of mud, muck and de-

and dining room where food and supplies are delivered. An ample turnaround, well gravelled, should be provided and plainly marked. No roads should cross the camp area.

If the camp is provided with a garage, repair shop and storage buildings, these should be off the immediate camp area, preferably near the road entrance. These buildings are best placed in a wooded section or masked off by trees

The Professional Role of the Camp Director

Hedley S. Dimock

THE CAMP DIRECTOR as chief executive or administrator of the camp enterprise carries a three-dimensional function—that of educator, administrator, and community organizer. Stated more directly, the camp director is an administrator of an educational enterprise that consists of a camp community. In this three-dimensional role he must possess, in balance, the philosophy and the arts of education, of administration, and of community organization. This balance is required between the philosophy and the arts or skills lest his conception of the “why” outrun his skill in performance or lest his techniques be unguided by sound principles and purpose. Since it can hardly be expected that this perfect blend is to be found in man or woman, it is the part of wisdom for the camp director to be aware of his own limitations in the light of the total functions to be performed and, in selecting his staff, to keep in mind the necessity of supplementing his knowledge and skill at certain points.

Personality

The personality of the administrator—and of the supervisor—significantly affects these processes in many ways. Stated in negative terms, it means that the processes of democracy in the camp are blocked if the camp director is authoritarian in his attitudes, regardless of what his philosophy may be; or the initiative and growth of the staff members are stymied if authority is too highly centralized in one person who satisfies his emotional needs by keeping others dependent upon him; or the camp community can hardly be free from tension and relaxed if the chief administrator is continuously under pressure and tension.

Perhaps the most basic personality qualification essential in the camp director is the ability to understand himself.

Administrative Skills

Among the more concrete elements of specialized knowledge and skill required by the camp director are the understanding and administering of the camp as a community of learning. Several of the important qualifications for this are: a skill in analyzing and directing the important factors in the camp community; an ability to deal with tensions and conflicts; an ability to provide experiences in camp that give an opportunity for initiative, creativeness, originality, resourcefulness, persistence, cooperation, dependability, honesty, leadership, and acceptance of responsibility.

Condensation of Chapter 16 of *Administration of the Modern Camp* by Hedley S. Dimock. Association Press, 291 Broadway, New York 7. 1948. Pp. 283. \$4.00. Reprinted with permission.

In the selection, training and supervision of staff the camp director must have the ability to: develop effective procedures for selecting and recruiting competent program personnel; plan and conduct pre-service training programs for program staff; plan and utilize in-service training and supervisory methods with staff; plan adequate ways for giving status and recognition to program staff as individuals and collectively; facilitate participation of staff in policy and program-making; prepare job analysis for each staff member, indicating responsibilities and relationships; provide for the personal and recreation needs of staff.

General Camp Administration

In performing his functions as general camp administrator, the camp director must know how to:

- Build an effective organizational structure to achieve basic purposes.
- Select personnel who can achieve basic camp purposes.
- Develop personnel policies that will develop loyal, efficient, and cooperative staff members.
- Develop a supervisory organization and program that will yield maximum results from all personnel.
- Recruit and select campers who can benefit from the camp experience.
- Interpret camping and his camp to the public.
- Evaluate the desirability of various campsites.
- Evaluate the desirability of various camp structures in view of need, costs, durability, and so on.
- Evaluate equipment needs and economic procurement.
- Administer the business operations of the camp, including the operation of a business office, a camper's bank, a store, and purchasing activities.
- Set up a record and reporting system — financial, program, health, personnel, and so on—and to devise a system of securing, organizing, and utilizing records and reports.
- Evaluate all aspects of camp operations to insure the achievement of camp objectives in as efficient and economical a manner as possible.

And he must also have knowledge of:

- The care of equipment, the most effective means of storage during the off season, and the making of inventories.
- How to construct a budget and secure conformity to it.
- Usual camp hazards and the most effective means for gaining protection through an effective yet economical insurance program.
- Organizations interested in camping and a skill in relating himself cooperatively with them.
- Legal aspects of camp operations and procedures for complying with legal requirements, including taxation, laws affecting workers, health, liability, licensing, and so on. ■



JUST OFF THE PRESS

1957 EDITION

CAMP DIRECTORY

INFORMATION on 2500 camps—location; name and address of owner or operating organization; number, age and sex of campers; fees; facilities; program features.

OF INTEREST and value to Recreation Workers, Youth Leaders, Students, Parents.

PRICED TO SELL AT COST
ONLY **50¢** PER COPY

American Camping Association
Bradford Woods
Martinsville, Indiana

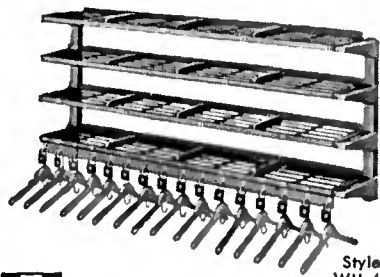

Checker
WALL MOUNTED RACK

Hold More Wraps in Less Space. Standard in checkrooms. Also widely used as self-service racks in coffee shops, restaurants, meeting rooms—wherever people gather. Mount on any available wall space, even over floor obstructions, accommodate 4 or 5 persons per running foot. Provides each with a coat hanger and individual hat space. Keeps wraps aired, dry, "in-press." Come with or without numbers and checks. Strongly built of reinforced heavy gauge steel. Finished in baked enamel. 3'2", 4'2", 5'2" lengths. Mount independently or interlock to make continuous racks of any length.

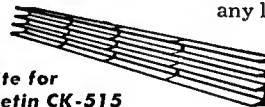

Write for
Bulletin CK-515

VOGEL-PETERSON CO.
1127 West 37th Street • Chicago 9, Illinois

SPECIAL BONUS for Early Birds!



Place your summer order for at least \$25 . . . before April 1st, 1957 and get in on this special offer of:

SPECIAL MOX

Cowhide with rubber innersoles, soft soles, assorted colors

Sizes: small 9-13
medium 1-3
large 4-6

\$7.93
DOZ.

(Sample "SPECIAL MOX" \$1.00 ea. pr.)

This offer expires March 31, 1957. Sorry, we can not afford to have our regular freight allowance . . . as specified in our 1957 catalog . . . apply to this special offer of moccasins.

All orders for Special Moccasins post dated after March 31, 1957 will be sold at the regular price of \$1.25 ea. or \$10.00 per doz.

Write For **FREE 1957 CATALOG** of HANDICRAFT SUPPLIES

CLEVELAND CRAFTS CO.

4705 Euclid Ave. CLEVELAND 3, OHIO
34 Elmwood Parkway (Elmwood Park)
CHICAGO 35, ILL.

HONOR YOUR PARTNER

Couple Dances

Square Dances

Play-Party Singing-Games Folk Dances

Rhythms

GUARANTEED NOT TO BREAK
○
CHIP OR CRACK

Ed Durlacher's "Talk-Through; Walk-Through" System of Simplified Progressive Instruction, followed by the Complete Dance.

SQUARE DANCE ASSOCIATES
P.O. Box 644, Freeport, N. Y.

Mail coupon for FREE brochure on all Honor Your Partner Teaching Aids
SQUARE DANCE ASSOCIATES P.O. Box 644, Freeport, N. Y.

Gentlemen: Please send me free brochure of Honor Your Partner Teaching Aids,

Name _____

Address _____

City _____ Zone _____ State _____

A Recreation Development

William J. Duchaine

A 213-acre farm is converted into a recreation area for industrial employees.



At top, small tots swing in absolute safety in nursery chair-type swing seats; below, pony rides are popular.

INDUSTRIAL recreation has assumed greater meaning for General Motors employees and their families in Anderson and Muncie, Indiana. Last July, the new 213-acre Killbuck Park was formally opened for the enjoyment of workers of the Delco-Remy and Guide Lamp Divisions. This picnic and recreation area marks a big step forward in the extensive, year-round activities program provided.

Originally purchased by the Delco-Remy Welfare Association in 1955, the century-old Gola Childes' Bethany Acres farm was renamed for the Killbuck Creek that flows diagonally through its scenic woods and fields. Killbuck Park fills a long-felt need. For years, employees often have had difficulty in finding suitable spots for plant and department picnics. Some had to be held at considerable distance from their homes. In contrast, the new park is only five and a half miles northeast of Anderson and sixteen miles west of Muncie.

Development of the park was begun under supervision of Purdue graduate J. A. Williams, plant maintenance engineer. Winding roads were built through the picturesque area. A thirty-eight-acre hardwood grove was cleared of thorn bushes and thicket to make an attractive site for picnic tables, grills, benches and children's playground equipment. A small pool was created near the entrance.

MR. DUCHAINE is public relations director of the American Playground Device Company, Anderson, Indiana.



Killbuck Park concessions-service building nears completion.

A seventy by twenty-two-foot building, for concessions, restrooms and first-aid services, was erected at the edge of the picnic grove. In the former pasture area, on the other side of the building, are located softball diamonds, basketball courts, and other recreation facilities. The farm barn quarters ponies for the ride concession; and just back of the barn, an old gravel pit is converted into a rifle range.

An Anderson, Indiana, manufacturing firm* supplied and installed one-hundred streamlined picnic tables, fifty park benches and thirty-five picnic grills for the picnic area, and laid out two playground apparatus areas—one for pre-school and primary-age youngsters, the other for older children. The area for younger children has swings, equipped with chair-type nursery seats to give maximum security to the small tots, an all-steel slide with a twelve-foot chute, a merry-go-round capable of carrying twenty-five youngsters, a larger swing equipped with safety rubber seats, and a double primary castle tower, a very popular climbing structure. The area for the older children is equipped with two all-steel slides with twenty-foot chutes, a heavy-duty steel swing with belt-type safety seats, a deluxe merry-go-round capable of carrying forty children, a senior wave stride and a senior castle tower.

The games and sports area near the concessions building is equipped with official regulation basketball backstop units, horseshoe, volleyball, and table tennis facilities.

Shortly before Killbuck Park was formally opened, the Guide Lamp Division joined Delco-Remy in the family recreation venture. All employees and their families are eligible to use the new facility. Membership cards have been issued to all the workers and retired employees.

Physical development of the park is continuing under the direction of Mr. Williams. Recreation programs in the park have been assigned to Dale Shaffer, supervisor of recreation, who visualizes Killbuck's development as a community center for General Motors employees. "There are limitless possibilities in Killbuck Park," he says. "It's just the thing to bring employees and their families out to enjoy outdoor life together."

Employees have been quick to take advantage of Killbuck Park. In the first two months of operation, more than forty thousand men, women and children turned out to enjoy themselves in the cool wooded areas. ■

*The American Playground Device Company.

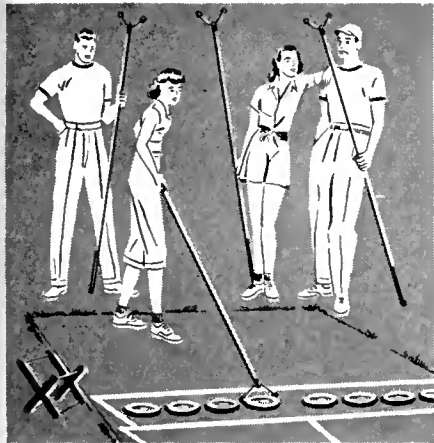

Shuffleboard Fun For Everyone!

From 8 to 80 here is exciting recreation for all ages . . . keen enjoyment for players and spectators.

Rugged, Dimco FreeGlide Shuffleboard sets are available for both outdoor and indoor installation.

Easy to install . . . low in upkeep!

Write today for colorful folder, "Let's Play Shuffleboard," containing complete information on court layout and equipment.

DIMCO-GRAY COMPANY

205 EAST SIXTH STREET
DAYTON 2, OHIO

FREE!



THIS BIG ILLUSTRATED LEATHERCRAFT CATALOG

There is no finer source of materials for Leathercraft projects of all kinds . . . easy-to-assemble kits to enable beginners to make billfolds, gloves, purses, belts and other attractive items . . . top quality tooling and carving leathers for advanced craftsmen. Also complete line of Leathercraft tools, accessories, supplies and instruction books.

ATTENTION METALCRAFT HOBBYISTS

Here is a comprehensive illustrated catalog from which you can make your selection of aluminum and copper in sheets and shapes for many projects; copper, aluminum and brass foil for metal tooling; kilns, colors and kits for metal enameling; instruction books, tools and accessories for metalcraft of all kinds.

SEND TODAY FOR EITHER OR BOTH FREE CATALOGS

J. C. LARSON CO.
820 S. TRIPP AVE., DEPT. 6305
CHICAGO 24, ILLINOIS

x-acto® helps students develop skills . . . **FAST!**

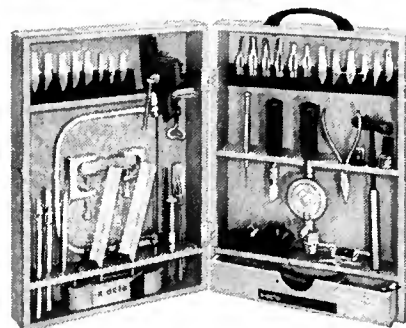

Above is the RECREATION DIRECTOR'S favorite "49'er" Hobby Chest containing full assortment of tools, knives and blades. Just a sample of the hundreds of handicraft kits, knives and tools illustrated in X-acto's Buying Guide. Only 25¢ a copy.

LATEST "HOW-TO" PROJECT BOOKS

Hobby Tools and How to Use Them . . . 75c*
Indian Beadcraft . . . 25c
Sull Wire Art . . . 25c
Wood Whitening Projects. 25c
Braiding and Weaving with PLEXON Plastic Lacing . . . 25c

*FREE with "49'er" chest.



X-ACTO, INC.
48-99 Von Dom Street
Long Island City 1, N. Y.

LOOP TENNIS CHAMPION OF PLAYGROUND GAMES

It's tops in popularity among all ages!

Biggest value for your money because of low cost, constant use, small space required, no hazards, tremendous appeal to skilled and unskilled alike, and both social and organic values.

ORDER YOUR SET TODAY!

D. R. M. LOOP TENNIS COMPANY, INC.

P. O. Box 481

Tallahassee, Florida

MORE THAN

100,000

U. S. SCHOOLS AND COLLEGES EACH YEAR SPECIFY

America's Finest Sports Equipment by

VOIT

NEW YORK 11

DANVILLE, ILL. • LOS ANGELES 11

Program in the Doldrums?

Everybody loves to play wholesome, action-packed

POOL

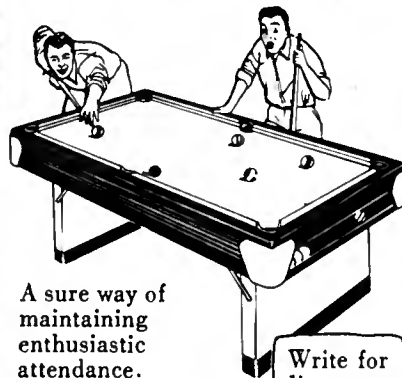

A sure way of maintaining enthusiastic attendance.

(9 sizes up to 3½ x 7 ft.)

Write for literature today.

SUPERIOR FOLDING POOL TABLES

Superior INDUSTRIES CORPORATION

565 Barry Street • New York 59, N. Y.

Nature Tools

Introduction to nature the easy way and the fun way can lead to love of nature and more intensified study in later years.

Betty Breeser

The first crawfish! Critter life in any stream is unpredictable and exciting. Catching "firsts," damming water to make pools for small fish or just wading are thrilling activities.

NATURE is one of the easiest subjects to present to campers, for it is all around them. However, directors are constantly faced with the problem of getting a good nature counselor who can inspire and interest youngsters. Rather than having one specialist in the field, it is better that all counselors, from the water-front instructor to the camp nurse, be aware of the never-ending challenge of on-the-spot nature.

One man, hired by a camp, presented an excellent unscheduled nature session to some happy campers when he discovered a small rabbit family while mowing a field. The children's delight in making their own bigger nest for imaginary play highlighted worthwhile creative activities as well as wildlife conservation.

Campers who dub a maple the "nose tree" are being exposed to good nature study, for their fun in wearing a split seed flyer on their nose is a fine first-hand experience in observation, and they will long remember the maple in this connection. Perhaps the name "crying tree" is a little far-fetched, but lucky are the youngsters with the counselor who points out the beechnut's teardrop shape. Long ago joys of youth in-

MRS. BREESER is a member of the Pennsylvania section of the American Camping Association, and was chairman of the Downingtown Area In-Camp Nature Institute, 1956, a Comstock Society executive board member, and past president of the Professional Writers Club of Philadelphia. She has had twenty years camping experience, with eight years as a camp director.

cluded such things as shooting a narrow-leaf plantain top and being able to blow a blade of grass. Children today, in spite of a life geared to television, radio and movies, are still happy to blow a dandelion's white top and test their chins with a buttercup to see if they like butter.

Conservation must start early with youth, for too many years have already passed with people destroying rather than enjoying nature. Diking a camp stream to make pools for small fish during dry spells has a two-way advantage: the preservation of flippers and an excellent water program for the campers. It's easy for children to dam a stream, and mud oozing up between the toes is an elixir unrivaled. Critter life in any stream is unpredictable and exciting, and there's an inexplicable thrill in catching the first frog, turtle, salamander or crawfish.

The common jewelweed or touch-me-not crowds many of our camp streams, but how many campers are ever told that the plant usually has bright red "toes" (roots), and that the leaves when submerged turn silver? How about the reed worms in those browning grass stalks when they want to fish? Digging worms isn't always easy, but there's bait under rocks and in the reeds for those who explore.

The young whittler who craves to carve his name on the nearest tree can be encouraged to do a bit of conservation with his knife. Replanting eroded stream banks with freshly cut willow shoots is an excellent nature program.

Encouraging children to see at all three levels is wise, for there's just as

much to enjoy in the vastness of the sky as on the ant level. To lie down in a field is to open up a new world to a camper. These minutes of viewing will offer a world of fantasy as the child sees cloud witches, animals, castles and imaginary characters floating above. There's still joy in pulling off the petals of the daisy to see if "he loves me, he loves me not," and a daisy wreath still tops the list of childhood crafts.

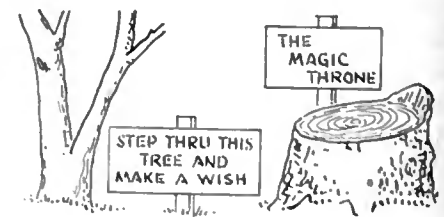

By a stretch of the imagination, a grove of trees can well become a camp's "castle." Through the shaded paths boys and girls can create a simple yet worthwhile enchanted trail. The counselor who stimulates this project by offering some cleverly posted signs is well on his way to a good nature project. "Step through this tree and make a wish!" can spark the first lap of such a trail, followed by a note on a stump that reads, "The magic throne—sit on it and your wish will come true!"

"This is the birds' opera house—listen!" will encourage silence near a thicket, with a notice further on suggesting that "The mitten tree (sassafras) grows close by—can you find any left-handed ones?" An arched grove of locust trees might suggest the "tunnel of the giants," and a tangle of honeysuckle the "home of the wicked witch!" All this is nature interwoven with crea-

tive play and offers any camp leader unending possibilities.

Assorted burrs that grow along wooded trails can be used for clever table decorations. With the addition of two small green leaves they assume shapes of insects to top ferns or flowers in a bouquet. The common May apple, arranged with twigs, can become a coy duck, peacock, or camp "happy bird."



Plays and stories dealing with nature are vital in a camp setting. Young actors are naturals when they are performing on a soft, wooded stage, and lessons learned are long remembered. The child who makes a helmet of red oak leaves will know the spine tips of the tree. He will long remember the music of the stream as he said his brief part in a play and the scent of the freshly cut spicebush as the backdrop.

Creative writing is a valuable tool for nature. Stories written about a tree, flower, shrub, or animal found in camp can well evolve into pantomime dramatics. Children are not always deft with the mechanics of writing, but a wise counselor jots down their thinking and catches their vivid imagination as stories are told.

The reflection of blue sky on a Virginia creeper leaf may suggest the sky's looking glass to some campers, while a story of the magic umbrellas may come from knowing the May apple. Galls are intriguing, and some child may chance to write a story on how the elves place tiny "fried eggs" on maple leaves.

Counting age rings on a tree could

well suggest a story on the imaginary history of the tree. Did Indians ever camp beneath its shade, and what years suffered drought? The widest rings usually appear on the north side, or dampest portion of the tree, which brings into focus the subject of finding direction without a compass.

The trek from bunk to dining hall can well be a source of art supplies. Weed blossoms, grasses, old wood, earth and common berries are ideal for camp art work. Using a toothed paper, the children simply rub the colors from their findings to produce clever pictures from nature. This craft highlights ingenuity and stimulates observation.

All grasses are not the same. Why not make a booklet of the collection in camp? The graceful specimens, mounted on black construction paper and covered with a clear plastic film are long-lasting and educational. Dancing dolls from long-needled pines will keep many a young miss happy for hours. Pretty stones, mounted in plaster of Paris are unique paperweights to be taken home as a souvenir.

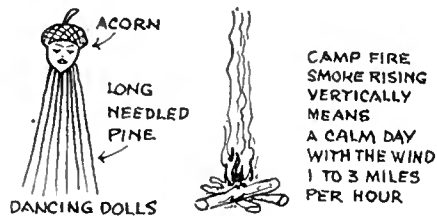

Campfires are also nature, for the direction of the smoke can well forecast the expected weather. By just listening, too, campers can tell if rain is due by the distant whistles. Their sense of smell is keen and the wise counselor is ever on the alert to recognize the ozone after a rain, the freshness of a woods in the morning and the fragrance of new mown hay.

The cracking of twigs and dry leaves

on a southern slope should be pointed out to campers to compare with the quiet spongy footing they experience on a northern hillside. Country children for decades have found pleasure in chewing sourgrass (wood sorrel), mint, spicebush, sassafras and the like, and there's still a big thrill in catching the large drop of nectar from the top of a honeysuckle blossom.

All campers should know the slippery inner bark of a willow twig, for whistle making was a craft of our forefathers. Dandelion stems make excellent curls when split and dropped in water. Violets and many other wild flowers explode their pods when ripe. Are these the "sharpshooters" of the woods? Nature materials are found in almost all camp settings, even in city parks. The "throw-aways" of nature, such as pods, seeds, shedding bark and leaves, are nature-craft materials to the counselor with imagination.

Campers should have time to watch the bees in a hollyhock and see the backward flight of a hummingbird as he leaves a blossom. They should catch fireflies and watch ants at work in their mounds. The feel of moist grass at sun-up should be theirs and their eyes should marvel at the panorama of color at sunset.

They should see their own reflection in a stream and the mirrored leaves overhead. The softness of moss should not be strange to young feet nor the powdery dust of a camp lane. Their hands should be stained with the juice of wild strawberries, and they should know the milky fluid that seeps from the stem of the milkweed. This is nature the easy way. Intensified study and identification will come in later years after appreciation and love of the outdoors has been well rooted in camp. ■

Know About These?

ON FILM:

- *Adventuring in the Handcrafts* (16mm, sound, color). Rental: \$4.25 for first day, half price for second. Girl Scouts of U.S.A., 155 East 44th Street, New York 17. Send request for loan of this film well in advance, give alternate dates. It's booked heavily.
- *Work Camp Slides* (43 slides, 35mm, color, titled *Work Learn Serve*). \$7.00 to buy; \$2.00 to rent, plus return postage and insurance. Send purchase orders to Miss Frances Malda, World Council of Churches Youth Department, 156 Fifth Avenue, New York 10. Send rental orders to United Student Christian Council, Ecumenical Voluntary Service Projects, 156 Fifth Avenue, New York 10.

IN PRINT:

- *Water Skiing For All* by Walter Prince. Greenberg; Publisher, 201 East 57th Street, New York 22. \$3.50. Covers fundamentals and points

out methods of improving the skiing ability of those already riding the slats.

- *Plans for a Medium-Sized Ramp*. Douglas Fir Plywood Association, 1119 A Street, Tacoma 2, Washington. Free. Interested in building your own jump ramp? These plans give full construction details, number and size of bolts and screws, size and specifications of the lumber, and so on.
- *How to Forecast the Weather*. Louis D. Rubin, Box 8615, Richmond 26, Virginia. \$.10. It's in color, and so inexpensive that every camper can have his own copy.
- *The Camp Nurse*. American Camping Association, Bradford Woods, Martinsville, Indiana. \$.50. A statement on qualifications, duties, responsibilities and value of the nurse in the camping program.

Order from sources given.

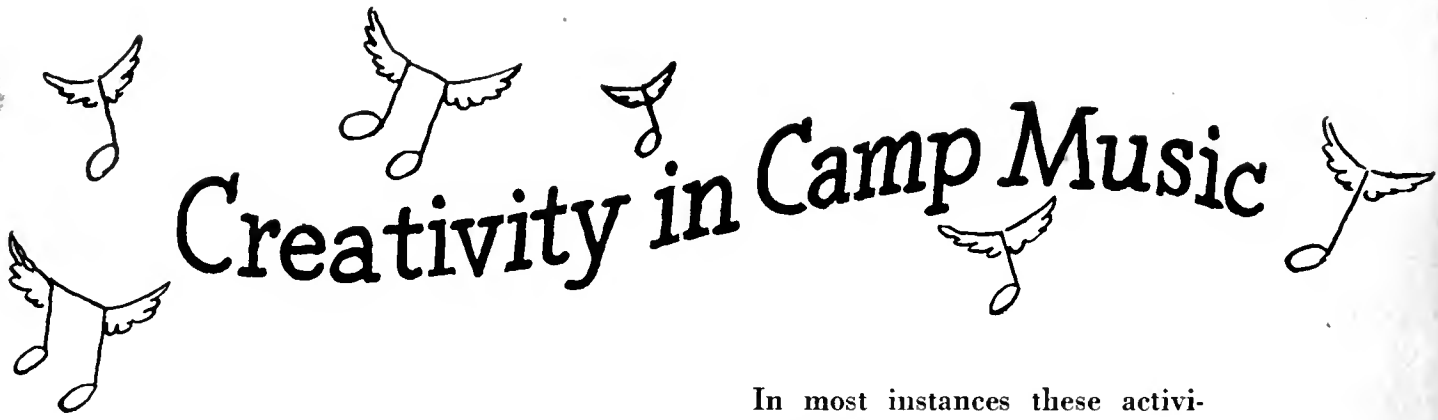

Creativity in Camp Music

In most instances these activities originate informally and are followed through to their creative aspects by discerning leaders.

THE very nature of music as a rhythmic art makes it a natural outlet for creative expression. To a high degree music shares many characteristics in common with speech. Melody, as a succession of regulated sounds in time and pitch, readily expresses thoughts and feelings. In singing, music is combined with speech. Thus, like conversation, it can be shared spontaneously with others within a group. At the same time, in various ways music can release creative forces for well being within the individual. As a "universal language," it provides a natural starting point toward creativity in the camp. In all phases of the program, music can continue in its creative function. It combines easily with other activities and can provide a pleasant means of transition from one part of the camp program to another. At all times, music can function informally as a vital, creative contact among groups and individuals.

Objectives

In creative music the following objectives should be sought: to gain confidence through self-expression, develop appreciation of good music, encourage development of musical ability, experience a feeling of oneness within a group, develop appreciation of the heritage of people through their folk music, and provide resources for creative use of leisure.

Two Areas of Creative Music Activities

Two important areas in music which can be used effectively in creative experience are: the actual composing of music, making and playing of instruments, interpreting music through dance and other original forms, playing or singing of music already composed.

In all situations involving music, the most important consideration is the creative opportunity presented to the camper—how he may be freed from tensions or inhibitions to express himself freely. In the creation of original music, the quality of the music is secondary to what happens to the individual. Wherever possible, however, campers should be encouraged to appreciate music of good quality primarily

through the selection of good song material. This creative experience should be integrated whenever possible with appropriate phases of the camp program.

Use of Music to Stimulate Creativeness

The following projects in the musical program of a camp are offered as examples and not necessarily as patterns to follow. Note that in most of these instances the activity originated very informally and was carried out successfully because the leader recognized the potential creative aspect of the idea.

Songs that depict memorable events or highlights of program.—A group of girls composed the music for a log they had kept of a three-day primitive hike, and then presented it to the whole camp as a history of their experiences. They had actually composed a folk song of such high quality that it proved worthy of inclusion in the camp's folk-song library.

Songs composed as "take-offs" on situations or staff members.—Under careful guidance these songs may result in good use of satirical music. The director of a camp often makes a good subject.

This article is part of the findings of a workshop on creative activities held at Bradford Woods, Martinsville, Indiana, October 22-24, 1956, under the direction of A. Cooper Ballentine, chairman of the American Camping Association Committee on Program Services to Camps. Walter F. Anderson, director of music at Antioch College, was leader of the music group, and John A. Ledlie was coordinator of the three groups—creative music, creative drama and creative arts and crafts. The report is not generally available. It will be expanded and refined at seven regional workshops in 1957, and may then be published by American Camping Association. This section is used by permission.

Rearranging camp songs.—Descants to one-part songs may be written. Harmony may be developed for small portions of songs. Changes in tempo are another form of experimentation.

In one case, one line of a song was sung differently, but in harmony, by a group of older girls. Not only did their rearrangement become standard, but other groups began adding their own improvisations to other standard songs.

Composition of "club" songs.—In a camp organized on a "club" basis, composing of club songs (although group spirit or group unity was their primary purpose) provided a creative experience. After completing the words of a song, one club had difficulty in composing the music. The counselor finally gave each camper one of the lines and asked him to provide a melody for that line only. Since it was difficult for the entire club to learn all of these melodies within a limited time, the group decided to present the song with each boy singing his own line.

Composing music for ceremony or pageant purposes.—The closing ceremony of one camp has become traditionally a program which tells the history of the council fire. Only the basic theme is traditional; songs and skits are planned anew each year by campers.

Construction by campers of their own musical instruments.

Pantomime to portray the message or meaning of songs.—When they realized that the "donkey" in the song "Donkey Riding" was erroneously thought of as an animal, some campers divided themselves into two groups, one singing the song, the other pantomiming the real meaning of the donkey—a small engine used to pull boats through a canal.

Use of the autoharp for background music for melodramatic skits. Any chord or chords may be played and will sound musically satisfying.

A favorite evening program—an across-the-lake-sing.—A girls' unit invites a boys' unit to participate. The girls locate themselves across the lake from the boys. Both groups build fires and exchange songs. This provides a good situation for the presentation of original songs.

Camp worship services—a wonderful opportunity for creativity.—An all-camper choir sang a selection in which the original words, written by a camper, were set to the music of a favorite hymn. Campers composed words for choral readings. Expressing the meanings effectively was also a creative experience.

Dramatization of the poem "Creation," by James Weldon Johnson, through dance, with a background of music selected by the campers, proved a stimulating experience for both participants and audience.

Music for vesper services was selected by campers to express their feelings. In a vesper service, crayons and paper were given to campers as they came into the chapel. As music was played to convey a feeling, the campers, if stimulated, expressed their interpretation by drawings. In another vesper service the campers expressed through song the history of the camp area as told to them by an old native.

Providing security for the individual through creative

leisure relaxation.—An attractive listening corner was set aside where individuals or groups could come and use records at their leisure.

Opportunities have been provided for individuals and small groups to use their special musical talents before the entire camp during meals or as part of special programs.

When community singing is used as a creative activity, much depends upon the leader and his goals for the group. Moods can be set through singing the proper songs at the proper time. Standards of music can be raised and a spirit of fun maintained when singing starts at an existing level of appreciation and progresses gradually to a better type of folk and other music.

Groups of older campers may sing with or without accompaniment while strolling among camp units after taps. Instrumental music alone may be used in this same way. The same idea can be used in the morning as the group wakes up. In some camps, if it seems best, a recording of the proper type of music may be used in these same types of situations.

Encouraging campers to interpret music in dance and to originate dances based on their own experience.—Indian dances may be improvised.

Mexican rhythms were interpreted by campers, each in costume, forming a circle, facing out. They sat with knees up and heads down in typically Mexican fashion. Each had a small instrument such as a gourd and sandpaper block. The leader at the side had a large drum which he beat in a steady, four-beat meter. Each camper in turn played a rhythm on his instrument, then got up and interpreted his own rhythm in a dance movement.

Creating dances to folk tunes may include interpreting tunes in the form of square dances. Begin by using simple tunes, such as "Turkey in the Straw" and "Pop Goes the Weasel."

The same procedures used in modern dance may also be used in synchronized swimming, horseback riding, games, and field events.

Realization of potentialities for spontaneity.—Singing may be encouraged while campers are watching the sunset or sunrise, working on craft projects, cleaning the dining hall, relaxing during interim or gap periods. These occasions also provide unique learning situations since spontaneity in learning appeals to youth and is an important phase in the creative aspects of music.

Training the Staff

Use of a tape recorder to record examples of the foregoing types of programs is of great value in staff training, both in developing proper climate and evaluating creative programming.

Stimulation of Creativity

Creative experiences like those already mentioned will take place only if a climate (mood or atmosphere) conducive to such experiences is established and maintained. These are some of the factors that make such a climate possible: 

- The camp director must accept the concept that the creative process is more important than the level of performance.
- Because of the informality of the creative process, the camp director needs to develop specific goals of creativity in music which he or she keeps continually emphasizing with the staff in pre-camp training and in all training sessions during the entire camp season.
- A counselor must have some grasp of the individual characteristics of each camper in his group and a sympathetic rapport with each one if at any given moment he is to influence spontaneous expression.
- Whether leadership in music is provided by a specialist or by resources within the general staff, such direction should be expressed in setting a mood rather than by giving authoritative direction.
- The counselor in charge of the music program needs to know how to work through the staff, since this method is more likely to be conducive to and productive of a creative response than the direct approach of a specialist.
- Special abilities of both campers and staff need to be recognized as the potential stimulus for an informal music situation.
- In order to stimulate spontaneity, a counselor must have an appreciation not only of a "proper climate" (including program flexibility) but also an appreciation of the role that "readiness" plays in the motivation of campers. ■

Next Month!

Recreation
Magazine

ANNUAL
PLAYGROUND
ISSUE



"The Choice of Those Who Play The Game"

The MacGregor Co. • Cincinnati 32, Ohio
FOOTBALL • BASEBALL • BASKETBALL • GOLF • TENNIS



FLAG CEREMONY

Flag ceremonies are always an impressive part of the camp program; and at least one ceremony—either colors or retreat—should be held every day in camp. The responsibility for these ceremonies should be rotated among camp units.

The unit in charge of the ceremony selects five campers to serve as color guard. One camper is designated as color bearer and wears a red sash over the right shoulder, tied with a square knot under the left arm. The color guards wear red sashes around their waists, tied at the left side. If the flag is unusually large, six or even eight campers may make up the color guard.

The entire camp proceeds in a single line and forms a horseshoe around the flagpole. The color bearer and guards then proceed through the open end of the horseshoe to a position in front of the flagpole and remain facing the pole throughout the ceremony. There is absolute silence from the time the group begins to move forward into the horseshoe until it returns to the starting point. Since the color guards are the official custodians of the flag while they are wearing sashes they do not sing, speak, salute, or take part in the program.

The ceremony itself takes place while the flag is at the top of the pole. During a color ceremony the flag is raised first and then the program takes place; during retreat the opposite is true—the program is first and the flag lowering is last. The program may be varied according to the wishes of the group planning it, but it should consist of the Pledge of Allegiance, some patriotic thought in poetry, or song, and group singing.

The color guards salute during the color ceremony immediately after they have raised the flag into position and the bearer has returned to his original position in front of the pole. At retreat the group making up the guard salutes the flag after taking position and before the flag is lowered. The camp group in the horseshoe salutes the colors from the time the first snap is fastened until the flag reaches the top of the pole. At retreat the group holds its salute from the time the flag starts its descent until the final snap has been loosened.

In the process of raising or lowering the flag, the color bearer steps forward first, followed by the two color guards immediately behind him. These two guards take their places to the right and left of the bearer and are responsible for seeing that the flag flies free on raising and never touches the ground when being lowered. One guard may assist the bearer in fastening or loosening the snaps on the rope.

In folding the flag the guard folds it lengthwise in half; then lengthwise again in half. The blue field is folded underneath toward the outside and nearest the flagpole. The last couple (farthest from the pole) begins folding the flag with triangle folds; the other two guards place their hands under the flag to steady it.

After the flag has been folded, one of the forward guards takes the flag and places it in the outstretched arms of the bearer, with the point toward the bearer. After this guard has resumed position, all guards take one step outward and turn to face the center. The color bearer does an about-face, walks between the aisle of facing guards. The first couple then turns and follows the bearer, the second follows, until all have left formation. The entire horseshoe then turns and leaves the circle.—IRENE R. KIRCHNER, *Rochester, Pennsylvania, Girl Scout camp leader.*

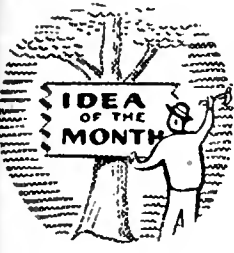

Programs should be carefully planned, for what happens in the glow of the evening campfire makes a deep, lasting impression on young minds.

The Campfire

S. Theodore Woal

Probably the two programs most enjoyed and longest remembered by campers are the aquatic and the campfire programs. The former are usually under the care of a carefully selected waterfront staff. The latter is everybody's business.

The combination of a fire and the darkness of night is irresistible, but when a well-planned campfire program is added, the event becomes one of the most valuable assets to the camp—and to the camper. This outline covers the major points in planning. Each camp leader will, of course, fill it in to suit the needs and the interests of his camp group or unit.

CAMPERS always look forward to campfire programs with enthusiasm. They are real adventures — something different and exciting, with a certain primitive atmosphere of feeling safe and protected by fire and companions from the dangers of the night.

Campfire programs may be of many types and used on many occasions. Usually they fall into three major types: the weekly campfire, each one planned around a different theme; the ceremonial campfire; and the social events campfire.

The function of the counselor in the planning, development and execution of a campfire is to guide camper planning along constructive lines and to coordinate camper suggestions and and thought into a cohesive experience in group living.

In planning a campfire program, the following aspects must be considered:

1. The objectives.
2. Developing the program of events and activities.

MR. WOAL teaches at the John Paul Jones Junior High School in Philadelphia. His article is based on his experiences at Camp Airy, Thurmont, Maryland.

3. Preparing the campfire site.
4. Obtaining properties and supplies.
5. Organizing the participants.
6. Notifying and briefing the audience.
7. Evaluating the effectiveness of the experience.

The Objectives—The leader must analyze these, both for the campers as individuals and the campers as a collective unit. What is the desirable outcome of the campfire experience? What type of theme will fit best into the objectives?

Developing the Program of Events and Activities—The leader must provide for the selection of the type of campfire program. Is it one of a weekly series, a ceremonial, a program mainly for fun and sociability? The selection should be by democratic action on the part of the bunk, unit or other group of campers. They should have ample time and opportunity to suggest and develop ideas, with final approval given by the majority.

In working with campers, the leader should keep in mind, for discussion when necessary, such questions as:

- Does the type of campfire program lend itself to camper participation in its development and execution?

- Can materials and supplies required be obtained, constructed or assembled?
- Does the final decision represent the will of the majority?
- Who is going to do the required chores?
- Can the proposed program be prepared adequately in the time available?

The selection and development of events and activities for the campfire should be a cooperative project. The function of the counselor is to guide campers in developing each phase of the program and to coordinate their efforts (offer suggestions and assist). Perhaps a program committee should be selected and specifically charged with development of the program; or, the program may be agreed upon after full camper discussion and assignments then made by the camper selected to “head up” the campfire. Give the campers plenty of opportunity to voice opinions, make suggestions and, in general, participate in selection and building of the program.

Once the general theme and the types of events and activities have been decided upon, the campers should work out a written outline. The next step is to select specific games, skits, stunts, and so forth, and to develop them, constructing any necessary props or equipment. They should then request assistance from many other departments or specialists, such as music or dramatics, asking for such help sufficiently in advance. They are then ready for tryouts, coaching and rehearsals, if necessary.

Preparing the Campfire Site — The campers, or their chosen representa-

tive, should select the site of the campfire, investigate its location, decide on its suitability and check with the camp administration as to its availability for the time and use decided upon. They should also select an alternate site to be used in case of inclement weather and also check its availability with administration.

The chosen area must be cleaned and arranged for the program. Campers should be responsible for the wood, fireplace, matches, seating space, water to extinguish the fire, and for clean-up after the program. Campers should be chosen for these responsibilities by the group and should be briefed by the leader.

Obtaining Properties and Supplies—The campers should choose a committee responsible for such jobs as making or borrowing any necessary props or equipment, such as wigs, drums, costumes; requisitioning refreshments at least forty-eight hours in advance; selecting and providing any awards or prizes, if required. The committee should accomplish these chores through the accepted camp channels.

Organizing the Participants — The campers should “run the show.” The

leader’s job is to guide and advise. A well-planned program can be a flop if not well-organized and adequately rehearsed. All props and supplies should be on hand and the participants given a last-minute briefing just previous to the campfire.

Notifying and Briefing the Audience—The “audience,” whether all or part of the camp, should be notified in advance by announcements, posters, runners, or other means just when and where to assemble; what to wear (sweater, if cold, raincoat if damp); and special costume required by the type of campfire program, such as face mask or other adornment; directions for entering the area; directions for seating and for dismissal; instructions for applause if any special type is required by the theme; and instructions for the distribution of refreshments. Leaders should be on hand to assist in seating the campers, and participate as part of the audience.

Evaluating the Effectiveness of the Experience—The campers, after the campfire is over and before details are forgotten, should discuss the event, raising such questions as:

Did the program provide something

of interest to everyone? Was it too long? Too short? What went over best? Why? Anything “flopped”? Why? If it could be done over, what changes should be made?

The leaders, in evaluating the program should consider such questions as: Did the program represent a truly democratic project? Did it develop any new skills? Did all the participants accept their responsibilities? What did they learn in the way of planning and organizing? Was the program content fresh and imaginative? Anything go wrong? Why? What could have been done better? What techniques might have been used to better advantage?

The leaders should always make a full, written report of such events, giving an outline of the program, types of activities, resources, and comments. These not only help in future planning, but also may prevent future duplication.

POSSIBLE THEMES FOR CAMPFIRES:

Cowboy, Indian, Old Timers, Pirate, Outer Space, Circus, Song Fest, Hobo, Patriotic, International, Gypsy, Camp Birthday, Magic, Worship, Tall Tales, Camp Life. Any one of these is capable of many variations and can include a wide variety of activities. ■

Woodfire and Candle-Light

Selections for the campfire or vesper ceremony*

RESOURCES

Be thankful for the task too great for you,
The plan that seems too large for you alone,
The need demanding better than your best
Which draws you humbly to the Father's
throne.

For there the finite meets the Infinite
And human limitations melt away.
God's great reserve of kindling, conquering
power
Is ours to draw from for the hardest day.

WHEN YOU LEAVE CAMP

The friendly little paths I know
Will miss your glad young feet;
The hillsides and the forests
The sound of laughter sweet;
The dancing waves upon the lake
Will miss canoe and sail;
All silent in the shadowed woods
Will be your well-worn trail

The singing birds will miss your songs,
The stars your wondering eyes;
The ever-changing sunsets
Your look of hushed surprise.
You leave behind the beauty
Of all the hills you trod,
But in your heart you take away
More lasting gifts of God.

A LEGACY TO A CAMPER

If I had power to make this will
I would bequeath to you
The child-like sense of wonder
To last the long years through.

Wonder—the gift of magic sight,
To see with eager eyes
Each miracle of beauty
In forest, lake and skies;

The scarlet flames of autumn,
The tender shades of spring,
The lunar moth unfolding
Her gossamer green wings;

The clear call of the hermit thrush,
The crescent moon swung low,
The sunset from a hilltop,
The firelight's ruddy glow.

A legacy of wonder!
Could you but guess its worth!
No other precious dower
Would so transform the earth.

Wonder enough to squander
On every glad surprise,
For every golden morning,
For every new emprise

* From Mary Edgar's book, *Woodfire and Candle-Light*, (now out of print). Reprinted with Miss Edgar's permission from *Canadian Camping*, December 1955.

If I had power to make this will,
I would bequeath to you
The child-like sense of wonder
To last the long years through.

Contests

for a

Woodsmen's Weekend

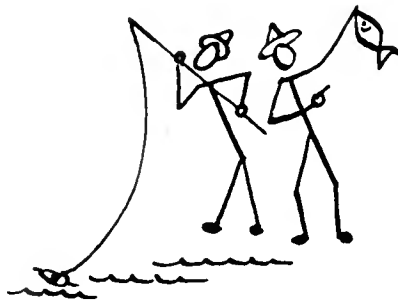

THESE SUGGESTIONS for outdoor activities for campers, whether weekend or longer, could form the basis of a fine active program for teen-agers and young adults. They assume a certain amount of training and experience in outdoor skills and could therefore be used as a climax to an outdoor camping program or trip into the woods. They were prepared by C. Ross McKenney, woodcraft advisor of the Dartmouth Outing Club, Hanover, New Hampshire for the *Outing Club Handbook* edited by Gunnar Peterson, George Williams College, Chicago, and are used with permission.

Fire Building

Simple Fire Building Technique. Contestants start with the same kind of wood, or wood they have chosen from the woodpile. At the signal they start kindling the fire in any way they wish as long as they use only wood, no paper. Each contestant has a can of soapy water and this is hung over fire wherever he wishes to place it. The one that boils over first wins.

Preparation of a Menu. Contestants choose wood from the woodpile. They can arrange the fireplace as they desire. At the signal the fire is lighted and a specified menu is prepared and served to the judges. The food must be cooked to satisfy them. Time decides the winner, providing the food is cooked properly.

Burning a String. At the signal contestants build a fire large enough to burn off a string stretched a given height above the fire.

Log Sawing

Logs especially prepared for the contest must be sawed in two. Both cross-cut and bucksaws may be used. First to saw through the log wins.

Fly and Bait Casting

Bait Casting. Standard bait casting rods are used with a silk casting line and one-ounce plugs. Events on water can be for distance and accuracy (casting into rings). Land events can be casting through rings thrown into the air, and at targets with bradded plugs.

Fly Casting. Events in distance and accuracy on water. Rods to weigh not over five and one-half ounces, nine feet in length. Line shall not be heavier than size C (American) backer line and shall not be spliced on any nearer than seventy feet from the end. No larger than size 6 hook shall be used and the leader must be no shorter than six feet.

Fly Tying. This event will be judged for quality alone. Contestants are permitted to use their own equipment and employ any method they desire.

Canoe Races

Single Canoe Race. One person to each canoe and he can take any position he desires (standing, sitting or kneeling). Contestants start at the signal, paddle around buoy and back to the starting point or finish line. Deliberate fouling disqualifies contestant. Points awarded for the best times turned in.

Double Race. Two persons to each canoe, taking any position they desire. Start at signal, paddle around buoy and back to finish line. Deliberate fouling disqualifies any contestant.

Four-Man Race. Four persons to each canoe. Any position desired. Start at signal, paddle around buoy and back to finish line.

Rescue Race. Two persons in each canoe. Start at signal. Somewhere along the course the signal is given at which time the contestant in the bow of each canoe has to jump clear of the canoe and then climb back into

it. Contestants then continue on to the finish line.

Exchange Race. Two persons in each canoe. Start at signal. Somewhere on the course a signal is given at which time both contestants in each canoe jump clear of canoe and into a pre-determined opponent's canoe. Race is then continued to the finish line. Upsetting of canoes disqualifies contestants.

Portage Race. One person to each canoe. Start at signal and paddle to pre-determined point on shore, jump out, shoulder canoe and carry back to starting point. Place canoe in water again and paddle around buoy and back to finish line.

Canoe Tilting. Two persons in each canoe. Person in stern of each canoe may take any position desired but person in bow must stand on the gunwales of the canoe. Person in bow has a long pole with an appropriate rubber fixture attached to one end. Object of the contest is to force opponent into the water. Falling into the canoe is legal. Canoes should remain at least six feet apart.

Rescuing Canoe from Water. One person to each canoe. Upset canoes to be retrieved are placed by judges at certain locations on the lake or pond. At the signal, contestants paddle out to a specified canoe, place upset canoe across theirs and return to the finish line.

Miscellaneous

Archery. Deciding factors will be accuracy and distance.

Loading and Carrying Packboard. At the signal a specified load for all packboards must be lashed on securely. Contestant then carries it approximately two hundred yards with the one reaching the finish line first with his load still securely tied being the winner.

Knapsack Race. A loaded knapsack is picked up and shoulder straps adjusted in place at the signal. Contestant then carries it approximately two hundred yards.

Note: In all events the judges' decisions will be final in regard to poor sportsmanship, rowdiness, fouling and scoring. ■



One of the fastest growing sports today, water skiing is high on the list of the activities recommended for developing physical fitness and muscular coordination.

Guideposts for

Important information about one of today's most thrilling and popular sports—in camp or out.

Harold M. Gore

WATER SKIING is believed to have had its origin twenty-five years ago among French ski troops who developed this new type of recreation by turning their snow ski abilities to the water. Now more and more snow skiers are following the same process of evolution. At first the sport was reserved for those who owned a speedboat with a powerful inboard motor. In recent years the low-cost outboard motor has all but wiped out financial barriers and brought water skiing within easy reach of the average income. Since so many youngsters are turning to the thrills of skinning across the water on a pair of wooden boards, we should plan to include this new sport in the aquatic program.

Water skiing is not difficult and does not require exceptional athletic ability. Almost anyone can learn to do it well enough to have fun. The fundamentals can be learned in a matter of hours.

HAROLD M. GORE is a member of the National Committee on Health and Safety, Boy Scouts of America, and director of Camp Najerog, Wilmington, Vermont. His article is reprinted from the bulletin Health and Safety, and used by permission of the Boy Scouts of America.

In many camps, waterfront leaders can readily set up a safe water skiing program if the methods are carefully explained to them. Here are the basic standards for this activity.

Two Types of Training Needed

Training a boy to ski is only half the training problem. Water skiing is tied in with and dependent upon outboard boating, and a program of outboard boatmanship must be offered in addition to training in skiing. This should include practice in safe boat handling, training in rules of the water road, and practice in courtesy afloat.

Water skiing should conform to all regular waterfront requirements. Every skier should be a strong swimmer and should be at home in, on, and under the water.

Boats and Motors

Two very important safety factors enter the picture at this point: (1) the selection of the proper boat and motor and (2) the teamwork developed between a trained outboard motorboat operator and the water skier.

An ideal outboard hull is probably a fourteen-foot runabout with a wide transom, about fifty-four inches. Water skiers can skim along behind such a

boat powered with a seven-and-a-half-to ten-horsepower motor and work up a speed of from fifteen to twenty or more miles per hour. A wide stern is necessary. Towing a skier around a sharp turn can make steering difficult and boat balance unstable if the stern is narrow.

It is important to match boats and motors for best performance. If the motor is too small, it won't pull the skier up out of the water. Even worse, if the motor is too large for the hull, the boat will be overpowered. That means danger and plenty of trouble afloat. Boats certified by the Outboard Boating Club of America carry a plate stating the recommended maximum horsepower.

Proper towrope attachments are important. Lifting handles and motor clamps should not be used. Towropes should be attached to eyebolts installed on the transom.

Many boats have capsized when towing a skier in a tight turn. There should be at least one life jacket or cushion for every person on board. Other essentials in the boat include oars or paddles, ample lines, whistle or horn, first-aid kit, a knife, fire extinguisher, extra shear pins for motor, extra plugs, and a tool kit.

Safe Water Skiing

A Good Boatman

The water skier's partner in good skiing teamwork is the boat driver. We go along with those folks who feel that the boat driver is ninety per cent of safe skiing! The water skier's safety may depend on how well the boat is handled.

There should always be two men in the boat: a driver to operate the boat and look ahead so that he can steer the boat and skier away from possible danger spots and an observer to watch the skier and give orders to the driver.

The Skier's Equipment

The equipment for water skiing includes skis, binding, and towrope. The outboard-style ski is recommended for beginners. These are usually about six feet long and seven inches wide. Bindings are usually made of a flexible material like gum rubber, so that they will give way in case of a fall and prevent ankle injuries. Towropes are from sixty to seventy-five feet and have a towbar attached.

The use of life vests or jackets is recommended for beginning skiers and is advisable for skiing on larger bodies of water or under unusual conditions such as cold water or rough weather.

Getting Started

Basic skiing can be learned in a very few lessons. It's important to get started correctly and not develop any bad habits in form. Points to remember: keep the knees bent, arms straight, and have the weight balanced directly over the feet, while in a half-crouch position.

Start off with a little practice ashore. Dry-land exercise is used to teach proper position and balance and to get the "feel." Then try actual starts in the water.

When the skier is in the water and ready, the towboat starts at idling speed until the towrope is extended to its full length. The driver doesn't "hit it" (apply full throttle) until the rope is taut, he can see the skier's tips, and the skier

has indicated that he is ready to go. It's a real partnership between the skier and driver!

When the skier is "up" on the water, power should be eased off as signaled by the skier—"thumbs up" meaning more speed, "thumbs down," less speed. Wide-arc turns are preferable. If a short turn is necessary, the driver should be sure the skier is not going to be on the inside of the turn. If the skier is outside the wake on the left (port) side, don't turn left too sharply until he has returned to the wake. If he is on the inside he will sink because of lack of speed and, unless he lets go, will have the towrope pulled from his hands when the line finally straightens out.

The boat driver must steer the skier away from all objects such as docks and sea walls and give other boats and obstacles a wide berth. He must avoid swimmers.

When recovering a fallen skier, cut speed immediately to determine if he is entangled in rope, then return quickly, coming up at idling speed, and make a half circle around him. This will bring the towline directly into his hands. Kill the motor when taking a skier into the boat, as he may slip and get hit by the prop. An idling boat in neutral is not safe.

In the take-off the skier puts on his skis in about two or three feet of water, grabs the towbar, and then raises the tips of his skis above the water as a signal to the driver to start the boat. When the boat starts to pull, the skier should allow it to pull him up slowly to a standing position. It's important that the driver give the skier a fast but steady pull. The skier does not pull up with his arms! Keep the arms straight at the take-off and let the boat do the pulling.

Code of the Safe Water Skier

- Learn to be a strong swimmer before attempting to water ski.

- Equipment should always be tested before skiing.

- When starting, don't yell "hit it" until your ski tips are up and the rope is taut.

- Stay away from docks, sea walls, boats, and swimmers. Skiers seldom get hurt from hitting the water, but usually from striking solid objects.

- Watch the water ahead. Skier must not depend on driver to keep him from dangerous objects.

- Be thoughtful of the rights of swimmers, boatmen, and fishermen.

- On falling: Recover skis, as they will keep you afloat.

Raise hand quickly to signal boat driver.

If in a congested area raise a ski so other boats can see you.

Release the handle when falling backwards.

Avoid falling forward into the rope.

- Never wrap the towrope around the body.

- Be very careful with the rope. Getting it tangled on take-off, or pulling up on it so that you have slack while skiing, could lead to trouble.

- When landing, run parallel to shore, come in slowly, and release towbar a safe distance from shore. Do not land in swimming areas.

- Don't ski in shallow water. Avoid excessive speed. Ski progressively—the skier should never try stunts for which he does not have the basic skill. ■

Training begins on land. Early steps include ways of putting on skis, holding the tow handle, weight balance, the starting position and kinds of take-offs.

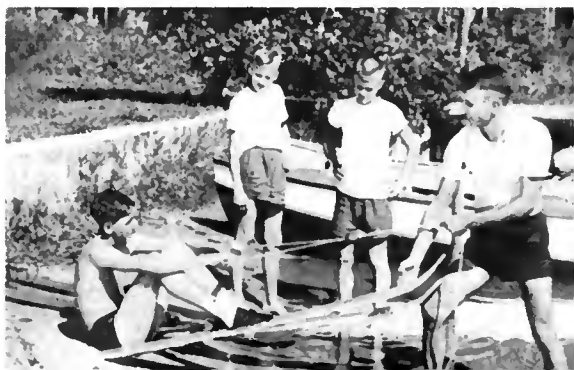

BONE CARVING

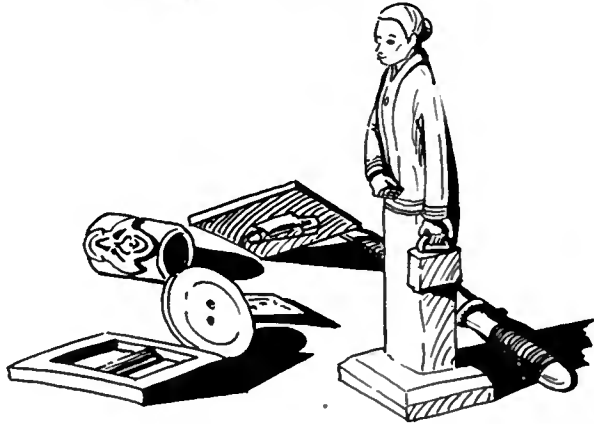

MATERIALS

Shin Bone of Beef or any other solid bone~
Files; round, half-round, flat and triangular~
Hack Saw, Coping Saw and Pumice.

METHOD

1. Boil bone to remove all foreign matter ~ Dry thoroughly.
Note: Hanging bone in sunshine for a few days helps to bleach it.
2. Make drawing of object (*actual size*) ~ Paste on bone.
3. Cut out shape using hacksaw or coping saw.

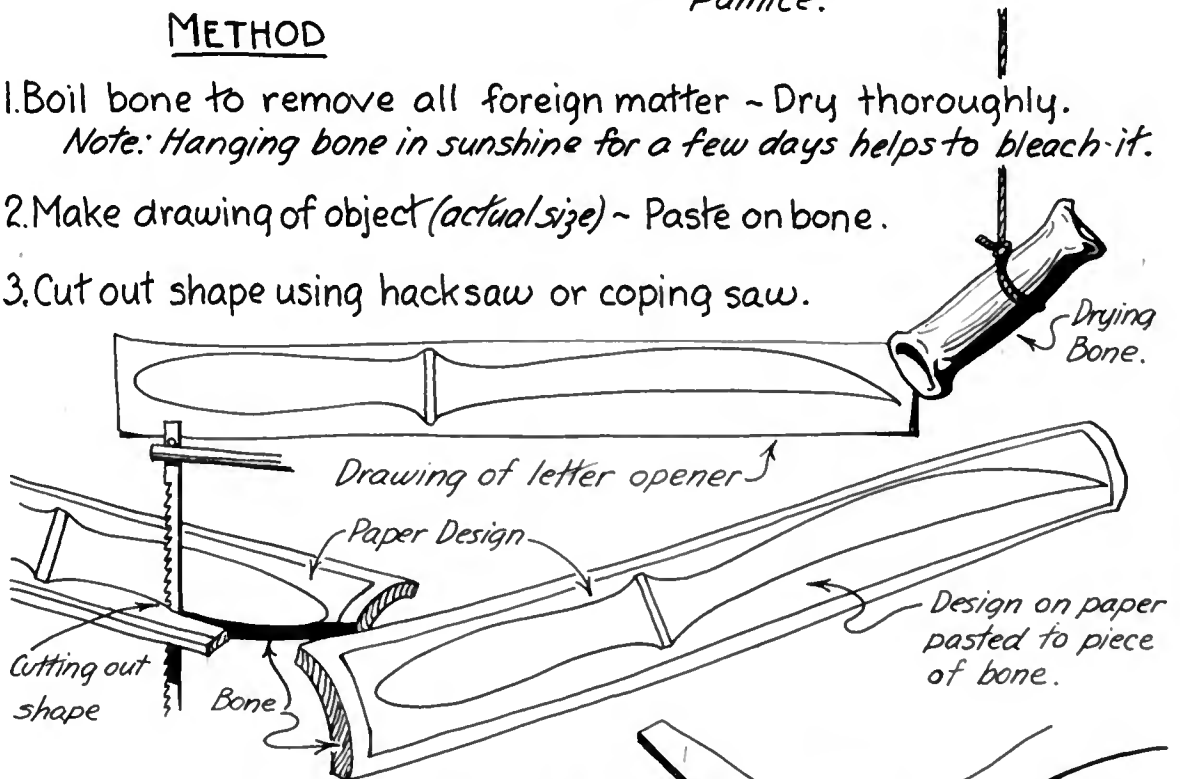

4. File bone to form shapes and details.
5. Polish bone with pumice and water.

Note: Buttons, buckles, pins, paper knives, tie slides, dress ornaments, etc. can be made.

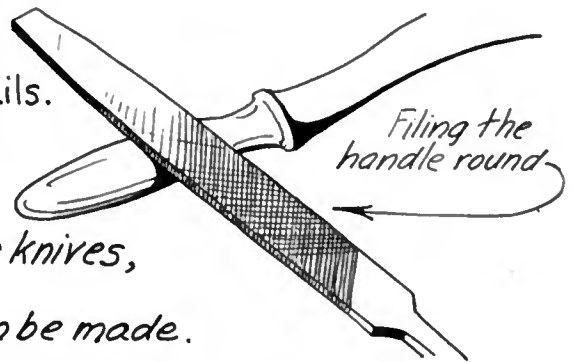

INEXPENSIVE NATURE MATERIALS FOR CRAFTS

Material	Treatment	Projects
Corn Husks	Allow to dry, moisten as used, may be dyed.	Braids for mats, sandals, dolls, flowers, belts, stuffing for pillows, hooked mats.
Cattails	Gather in fall, allow to dry, moisten as used.	Weaving of mats, trays, dolls, toy ducks.
Rushes	Gather when full grown, allow to dry, moisten as used.	Woven mats, baskets.
Cattail Fluff	Gather when the heads begin to blow apart.	Stuffing for toys, good insulation.
Grasses	Allow to dry, moisten before using in weaving.	Woven mats, filling for mats, stuffing for toys, baskets.
Nuts	Gather when ripe, may be cut with a saw.	Neckerchief holders, pins, belts, bracelets, place cards, novelty items.
Shells	Clean thoroughly but gently, may be drilled.	Spoons, belts, bracelets, pins, earrings, novelty items.
Willow	For whistles, cut in spring.	Whistles, baskets, trays, framework for other weaving.
Clay	Amount of washing will depend upon purity, wash, allow to settle, remove water, may be fired and glazed.	All types of pottery items, figurines.
Twigs	Sort for size.	Necklaces, belts, bracelets.

Superior By Every Comparison!



So sensationally better are they on every count—design, construction, quality, durability and play-ability—that Rawlings HERCULITE Rubber-Covered Athletic Balls have established a new high standard. They're in a class by themselves—they're...

"The Finest In The Field!"

- VOLLEY BALLS
- BASKETBALLS
- SOCCER BALLS
- FOOTBALLS

RAWLINGS SPORTING GOODS CO. • St. Louis • Las Angeles • Dallas • Chicago

Send for these 275 NEW activities!

Rollicking folk fun for everyone

SINGING GAMES AND DANCES

DAVID S. McINTOSH

56 delightful singing games and singing dances, each with words, music, and instructions clear enough for beginners. Chosen for their gay simplicity and originality from the author's vast collection of Midwest Americana, and adapted for modern use. Special index suggests child and adult age groups for each activity. \$3.00

For camps, playgrounds, all outdoor places

CREATIVE CRAFTS FOR CAMPERS

CATHERINE T. HAMMETT
and CAROL M. HORROCKS

175 arts and crafts projects using forms and materials found outdoors to make articles correlating with other outdoor activities. Lucid text and numerous illustrations detail 100 of the projects step by step. Among the varied techniques included are:

- | | |
|-----------------------|---|
| Braiding and knotting | Weaving |
| Basketry | Sketching and painting |
| Ceramics | Printing and stenciling |
| Leatherwork | Whittling, woodcarving, and woodworking |
| Metalwork | |

A special section tells how to relate these crafts projects to other activities: dramatics, music, nature study, games, sports, campcraft, bulletins, exhibits, favors and decorations for special events, etc. All projects are arranged progressively, and encourage handcrafters to explore and experiment. \$7.95

For pre-teen story time

TREASURY OF AMERICAN INDIAN TALES

THEODORE WHITSON RESSLER

44 authentic, traditional and original stories from 27 tribes in all parts of the country. Each story "child-tested" for reading to ages 6 to 12. Character building Indian traits of courage, honesty and close family ties are stressed unobtrusively. \$3.95

CHECK BOOKS ABOVE—CLIP AD—WRITE NAME AND ADDRESS IN MARGIN AND MAIL TO

ASSOCIATION PRESS - 291 Broadway, New York 7, N. Y.



Preparation for water dramatics includes fun of learning, adds self-confidence in the water, ties in well with swimming instruction.



It's fun to share joy of water play; children love group activities.

Water Dramatics for Young Swimmers

Betsy DuBois

CHILDREN like to share their joy in swimming; and it is good public relations for any camp or playground leader to let them do so, with an audience. The problem is to put on a production that both performers and watchers will enjoy — without taking too many hours away from regular swim instruction.

Water dramatics can be the answer, either as a full-fledged production or to simplify an already traditional synchronized swimming display.

For example of the latter, a lively recorded number, such as a cowboy song, might be played while a dozen boys, ages seven and up, walk through shallow water with the rocking motion of a canter. In circle formation, they suddenly whip out water pistols and shoot up a fountain effect, or race off in a free-style cowboy-Indian chase in which the villains, once subdued, turn

over and scull meekly out of the area.

Even this brief sketch includes many elements of water-show dramatics—an action situation, appropriate music, gestures, and properties. In addition, the complete number may require costumes, even if just feather headbands for the Indians, or it may need scenery, preferably based around the natural features of the swimming area. How about an Indian lookout atop the life-guard tower, a life-ring lasso, or a tepee set by the water?

Certainly, this treatment slights the traditional grace and skill of water ballet; but how many girls below junior high school age can easily master a bent-knee dolphin, and how many boys even care to try? Yet they all like make-believe. If the program requires fewer rehearsals than a synchronized swimming program, it is so much the better.

Drama appeals to the audience, whether parents, townspeople, a neighborhood group, or your own camp or playground population. Only a fraction of those watching understand the

skill needed for a Catalina, a submarine, or even a precision crawl of ten swimmers in unison; but they like gestures and costumes — the obvious things.

They may know that a ballet kick is impressive, but they don't know the sculling practice needed to keep afloat those who execute it. Therefore, many programs have found the answer: eliminate the difficult, keep the obvious, and make up the difference with imagination!

Dependence more upon imagination than upon individual skills presents several advantages. First, it allows more participants. Large groups are impossible for complicated stroke patterns, but a recreation program in New Bremen, Ohio, incorporated a group of one hundred and twenty children in mass numbers. The show spotlighted what the children represented, not what they were doing. Second, rehearsal time is cut, leaving more time for swimming instruction. In a Marshall, Missouri, show, for instance, nobody had to practice arm movements. Each was

Miss DuBois is former waterfront director of Camp Manitou, Central Valley, New York. Her article is based on experience.

holding on to one of two strips of red cloth arranged to form a cross.

Practice is easier when the choreography follows the "story" on the record. The instructor needn't say, "Start your flutter kicks twenty-four counts after the music begins." He merely says, "Wait 'til the record sings 'I get a kick out of you.'"

A good tie-in with swimming instruction is a third advantage. Many skills of synchronized swimming are beyond and apart from those needed to pass Red Cross or other tests. Water dramatics makes simple learning fun. The handstand bow to the water-show king trains heads-down beginning divers. And a frog number, even legs only, can advance lessons on the breast stroke. There's no harm in letting the young tadpoles hold the side of the pool or even keep their hands on the bottom of the lake for a whole number.

In planning a water show,* the group can help out. First, choose a good story. "Theme" shows, with each number a different circus number or a different month, lack the suspense of narratives. The audience can keep abreast of a plot through a narrator, by mimeographed programs, or by its own knowledge of a familiar story. Recent or old musical plays, reduced to simple narration, have their own records. Fairy tales or Mother Goose rhymes appeal to younger groups; and folk tales make a novel program.

The theme may help in selecting records. For example, Camp Nicolet, Eagle River, Wisconsin, swam a Pinocchio number to "I've Got No Strings." But records are only one possibility. Participants can swim to singing, drumbeats, clapping, or the rhythm of a poem read over the microphone. The singers or clappers can easily blend into the number. Just put them in dryland versions of the swimmers' costumes; or include them in the action during entrances or exits.

The swimmers and their choreography highlight the show. Here water dramatics differs from ballet, in that song lyrics and theme guide its gestures. For example: sailor-dives for seamen; one salute per sidestroke for soldiers; a

pawing front crawl for horses; a straight-arm back crawl for windmills; and, in formations, a circular clock with two swimmers as moving "hands," or a circle expanding as someone outside it "blows up the balloon."

For special interest, fit regular water ballet stunts into your theme. Swimmers at Camp Manitou, Central Valley, New York, mastered a barrel roll; then a line of them rolled alternately left and right to form an inchworm.

Camp Talako, also in New York, built a whole number on a fisherman and mermaid story** of lovers separated because he cannot follow her under water. The two swam together throughout, but for every stunt (dolphin, surface dive, and so on) in which she went under water, he did a shallow version of the same thing, keeping his face above the surface.

The principle applies to even the loveliest numbers, as tried at Camp Hagan, Shawnee - on - Delaware, Pennsylvania. Swimmers duplicated the whirling motion of falling autumn leaves with a simple twisting foot-first surface dive.

Costumes perk up a water drama, as they do any other type; but for the easiest swimming, accessories are the limit. Bracelets can be wide tinfoil strips for an African slave, strings of bells for a reindeer, or gauze for a doctor. Headdresses can range from the oilcloth hairbows of Little Bo Peep to the pipe-cleaner curls of the heroine in an all-boy show. Anything is fine as long as it is waterproof, simple, and stays on.

Scenery is too rare in water shows, but it's one of the best ways to involve the craft shop in the water program, and it makes performers feel practically professional. Most groups let one set tie together the whole show, since scene changes are just too much trouble. They use equipment at hand by wiring tree boughs to the top of pool ladders, leaning a cardboard storybook against the lifeguard tower, or setting at the water's edge, a canoe decorated as a pirate ship. To help vary choreography, the canoe moves right into the swimming area as

** There are many legends and versions of romance between a fisherman and a mermaid. One of the best known is Oscar Wilde's "Fisherman and His Soul" in his *Happy Prince and Other Fairy Tales*, published by G. P. Putnam's Sons, 210 Madison Avenue, New York 16. \$2.50.

floating scenery. Other pieces, from merry-go-round to sleigh, can bob on rubber life rings or boats. A float centers the action, and helps swimmers get a second wind inconspicuously.

"Props" make variety even easier. Hens pause to tread water, and move away leaving ping-pong ball eggs. Society ladies carry tin teacups, fling water from them, and toss them away; or a basketball team takes real shooting practice through the joined arms of a circle formation.

With stress on props especially, but using several elements of dramatics, one camp made the story of Hans Christian Andersen a top show. A group of beginners, feathers taped on their bathing caps, stood in shallow water. Elbows bent, they "flapped" their hands like good little swans; then they splashed a poor ugly duckling, grotesquely wrapped in an old Indian headdress of feathers. But the change came—he ducked under water and took off the ugly feathers. Weighting them on the bottom with a rock, he emerged a lovely swan. No trouble at all—since he'd earned the role by winning a breath-holding contest.

Thumbelina came next; and—as Hans painted a face on his thumb—the craft shop painted faces on the backs of white, inexpensive bathing caps. When Thumbelina grew to nine feet tall in the lyrics, so did the swimmers, by climbing backwards up ladders out of the water.

The finale? Water show drama at its height! Hans courted his girl, won her, and swam with her to the water's edge—between rows of well-wishers showing the happy couple with popcorn. ■

CREATIVE CRAFTS FOR CAMPERS

by
Catherine T. Hammett
and
Carol M. Horrocks

A fine crafts manual—plus correlation with dramatics, music, nature, campcraft—plus Indian and pioneer crafts, map-making, photography, camp newspaper, and many other practical sections.

448 pages \$7.95

Order now from:

RECREATION BOOK CENTER

8 West Eighth Street, New York 11, N. Y.

NRA membership discounts will apply.

P E R S O N N E L

RECRUITING

Marilyn Jensen

One town's solution of a serious shortage of trained recreation personnel.

Recruiting competent recreation personnel has ceased to be a serious problem in Torrance, California. After viewing methods used in industry and business, we decided to apply the same techniques to solve our own recruiting problem. With the influx of population locally, we have greatly needed more trained leaders to keep up with the rapid expansion of the recreation department.

Our Solution

In January 1956, recreation director Harry B. Van Bellehem discussed a leadership training program with school district officials. After several months, the recreation department came up with a plan that has proved very workable.

The answer has been to incorporate our leadership training program into an accredited high-school class during the summer session. I was given the assignment of preparing the course outline and supervising the training program. The outline was then studied and approved by the school board—the students to receive pay from the recreation department and credit from the school district during the sixty-hour training period.

Realizing that the end result would depend largely upon the instructor, the selection of this person was left to the discretion of the recreation department. The school board stipulated that the person selected must have a valid teaching certificate and that the final choice be agreeable to the school district.

The selection of students began as soon as the recreation department determined the approximate number of positions that could be filled by graduates of such a program. The schools

performed an invaluable service in the selection of possible participants. Through the high school counseling offices, students were screened on the basis of leadership activities, ability to work well with others, definite plans to enter college in the fall, and particular interest in recreation or related fields. The names of fifteen students from each school were then submitted to the recreation department, and they were encouraged to apply for a summer recreation position.

Twenty-six of the thirty students recommended by the schools applied for jobs. The recreation department then selected fifty per cent of this group by means of a final interview conducted by recreation personnel.

Course Outline. The main objective was to provide training in the techniques and activities involved in recreation leadership. The material covered included: a general perspective of the field of recreation; common playground problems and possible solutions; policies and practices in Torrance; characteristics of different age groups; leadership techniques including posture, use of a whistle, and vocabulary; games of low organization; types of tournaments; use of dramatics in the program.

The class periods served a dual purpose by providing a practical laboratory for experimenting with activities unfamiliar to class members, and discussion of on-the-job problems.

During the summer program, the school areas were staffed with an area director and one or two student leaders. These students assisted the directors in all phases of the program. They were not placed in complete responsibility.

Result. For the most part, our student leaders were excellent. They even surpassed, in many instances, some of our adult leaders who had been in the program for a number of years. The wealth

of knowledge these students had gained in class was so apparent to the older staff members that they requested such training classes for themselves. The caliber of the program was better, and the esprit de corps of the entire recreation leadership staff was so improved that there was little comparison with previous years. Half of the students employed during the summer continued as part-time winter employees.

The Future

This plan allows for future advancement as the personnel gain experience. Annual salary increases have been set up to enable the student leaders to progress systematically from a payrate of \$1.10 an hour as an entering college freshman to \$1.72 as a graduate.

The system of upgrading through promotion with attendant pay increases obligates the recreation department to select the most competent leaders. Release of others creates a constant demand for new trainees each year. As the program grows, additional classes for advanced student leaders will be included. School officials have been very favorably impressed with the program, and have indicated that they wish to see it expand. The program has not been a financial burden to the recreation department. The school district pays the salary of the instructor, and the small salary that the department has had to pay the leaders while attending classes has been more than justified by the improved program and staff morale.

We are proud of the work done with our high school graduates. The program is reaching our natural leaders—the ones who can be successful in recreation—and allows them to test a career in this field. When they make vocational decisions, there is a better than average chance that they will seriously consider recreation as a career. ■

MISS JENSEN is supervisor of women's and girls' activities for the Torrance, California, Recreation Department.



Easter IDEA Hunt

Many of the following Easter customs from other countries will suggest games, crafts, contests, and special events. Fit them into your Easter celebrations, use them as poster ideas and as springboards for your own imagination.

BULGARIA: The people come to the town squares at midnight. Each person brings a candle and at the stroke of midnight lights it. These Easter candles are taken back home and are kept throughout the year as protection against disease, storms, and so on. *Program adaptation:* A lovely outdoor ceremony.

GERMANY: Special little "rabbit gardens" are built by the children so the Easter bunny has a place to leave the eggs. *Program adaptations:* Pre-Easter egg hunt idea for children's craft projects; egg nest exhibit.

FINLAND: Boys and girls spank one another with pussywillows. The child spanked must give up an Easter egg. *Program adaptation:* Scene or tableau for a festival or pageant.

HOLLAND: Boys and girls on Easter Eve go about the streets with lanterns attached to long poles. Folk songs are sung as they parade through the streets. (Homes in Holland are often above shops, on the second floor. The poles are used so that the lanterns may be seen by the people upstairs!) *Program adaptation:* A new and interesting special event.

NORWAY: Children hide eggs for the adults to hunt. *Program adaptation:* A good switch from the usual pattern—why not try it?

PORTUGAL: People exchange colored paper cornucopias which are filled with almonds. *Program adaptation:* Idea for favors and decorations!

SWEDEN: Eggs are decorated with comical rhymes! *Program adaptation:* This will be fun! Give special decorated egg to the one with the funniest rhyme. Put the eggs on display. ■

NRA Program Aids, March-April 1956.

100% ALUMINUM TABLE TENNIS TABLE

FOR OUTDOOR AND INDOOR USE

Here at last is the Heavy-Duty Aluminum Table Tennis Table featuring Durability and Economy. Sturdily Constructed to Withstand Extreme Abuse from Play and Weather. Built to Last a Life-time.

- REGULATION BOUNCE AND CONSTRUCTION.
- ATTRACTIVELY FINISHED WITH GREEN ANODIZED NON-GLARE SURFACE.
- IN 2 SECTIONS—4 LEGS EACH SECTION. EASILY SEPARATED INTO 2 TABLES.
- WHEN SEPARATED HAS MANY USES.
- NO MAINTENANCE OR REPLACEMENT PROBLEMS.
- OUTLASTS WOODEN TABLES BY MANY YEARS.
- A TREMENDOUS SUCCESS IN COLLEGES, SCHOOLS, CAMPS, ETC.

ESPECIALLY DESIGNED & CONSTRUCTED FOR HEAVY-DUTY USE IN:

Outdoor and Indoor Recreation Centers, Playgrounds, Resorts, Clubs, Camps, Ocean-going Vessels, Etc.

FOR FULL DETAILS, WRITE:

ALL-METAL TENNIS TABLE CO. 760 GEORGE ST. — TEANECK, N. J.

COMMUNITY ORGANIZATION For RECREATION

GERALD B. FITZGERALD, University of Minnesota

Book discusses community recreation organization and program plans on the local, state, and national levels. Shows how community benefits by having responsible public recreation au-

thority in charge of recreation services. Emphasizes the importance of effective association between lay and professional leaders, outlining basic principles for all concerned. 352 pp. \$4.

RECREATION THROUGH MUSIC

CHARLES LEONHARD, University of Illinois

This practical book provides specific material for recreation and song leaders in the conduct of their singing, listening, and playing programs. Includes stimulating discussions on the various components of music, types

of compositions, and different musical styles. Helpful lists of recommended recordings, song books, and special recordings and songs for children.

30 ills., 160 pp. \$3.25

• Popular books on the dance . . .

The Li'l Abner Official Square Dance Handbook

FRED LEIFER

Invaluable to recreation leaders and dance teachers this useful guide provides all necessary information on organizing a square dance. Presents basic steps and figures, calls, and mu-

sic scores for 26 dances. Selections of classified songs and country games including an annotated bibliography of 45 dance books. 157 ills., 127 pp. \$2.25

Walk Your Way to Better Dancing

LAWRENCE A. HOSTETLER

This profusely illustrated book presents a complete and logical method for teaching and learning ballroom dancing. Shows the many advantages of correct dancing and provides a visual picture of each step and com-

bination the student is learning. Presents the basic principles of leading and following and describes in detail the various dance rhythms. Rev. Ed.,

130 ills., 295 pp. \$4.25

THE FOLK DANCE LIBRARY

Ann Schley Duggan, Texas State College for Women; Jeannette Schlottmann, Bernard College; Abble Rutledge, Perdue University

Folk Dances of European Countries 31 ills., 3 maps, 27 musical scores, 106 pp.

The Teaching of Folk Dance 5 ills., 116 pp.

Folk Dances of the British Isles 26 ills., 1 map, 12 musical scores, 110 pp.

Folk Dances of Scandinavia 32 ills., 1 map, 21 musical scores, 118 pp.

Folk Dances of the United States and Mexico 43 ills., 2 maps, 21 musical scores, 159 pp.
Each 8½ x 11. \$3.50

Send for complete price list in Sports, Physical Education, and Recreation

The Ronald Press Company • 15 E. 26th St., New York 10

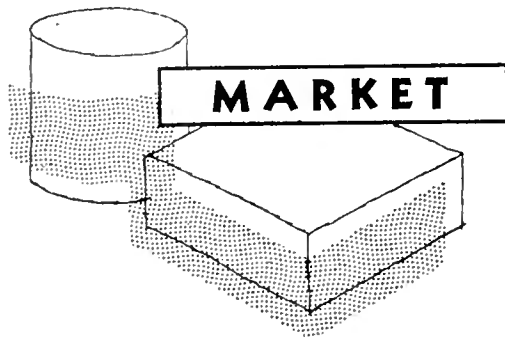

NEWS

If you are interested in any of these products, write directly to the manufacturer at the address given. PLEASE mention that you read about it on RECREATION magazine's Market News page



◆ Tennis Wink is a variation of tiddlywinks played on a 15"x24" green felt court over a plastic net. The net clamps on to the court, and the serve-wink is attached to a nylon string at the center to prevent it from getting lost. Scoring is the same as in regulation tennis, singles and doubles. Transogram Com-

pany, 200 Fifth Avenue, New York 10.

◆ A new aluminum tee and yardage marker for golf, shotput, discus and javelin throwing is made of rugged, weatherproof cast aluminum with stenciled numerals. The markers have an integral spike and convenient finger grip for quick placement or removal from the ground and are well suited for use as markers wherever yardage is measured. Ball and Hale, 1526 Greenmount Avenue, Pittsburgh 16, Pennsylvania.



◆ A new water ski-tow rope, of irradiated polyethylene plastic, offers the advantage of greater strength, minimum stretch, and excellent floating quality, as well as being forever waterproof and longer lasting than other ropes. It should be useful to both beginners and professionals in water skiing. The ski-tow is seventy-five feet long, completely assembled with a secure splice and fastened to a splinter-free birch handle with "walled crown" non-slip knots. Those who make their own water ski-tows can purchase the rope without handle in eighty-foot length. Thomas Jackson and Son Company, Reading Pennsylvania.



◆ Space-Kite, a new high-flying cloth kite, is a controllable three-dimensional aeronautical flyer made entirely of tear-proof acetate cloth, precision sewed in red, yellow and blue. It is flown easily and can be made to climb, glide and

and zoom at will and will fly for hours on end. It requires no tail for stability. Earlier models have been used in U. S. weather research.

Two sizes are available: a 28"-high kite without string

and a 35"-high kite with 250 feet of kite cord. Extra cord is available in 250-foot balls. Alan-Whitney Company, 413 Chapel Street, New Haven 2, Connecticut.

◆ Squeezeo is a felt-point marker that controls the flow of ink with a squeeze bottle which holds three-quarter ounce of water-color ink available in eight colors. The new water-color ink is for porous surface marking and does not strike through even the cheapest grade newsprint chart paper. It makes multiple-color art work easy and inexpensive. In tests with three- to six-year-olds it was found they could do much better coloring because the point stayed sharp (the ink comes off hands and clothes with a little soap and water). Marsh Stencil Machine Company, Felt-Point Pen Division, Belleville, Illinois.



◆ A new plastic float line, consisting of 1 3/4"x4 3/4" tubular floats strung continuously on a one-eighth-inch monel cable, is furnished complete with hook, spring, tension hook and other required fittings. Hemispherical soft plastic spacers are positioned between each float to provide extra flexibility and greater attractiveness. This continuous type line reduces turbulence and provides a high degree of safety because of great visibility and exceptional buoyancy. In addition, bare cable is not exposed at any point. The line is particularly suited for marking water recreation areas of all types, especially at camps.

The plastic floats are virtually indestructible, are unaffected by chlorine or salt water, will not swell or distort and will not accumulate algae. The color is part of the plastic itself, eliminating chipping or peeling and consequent re-finishing. The monel cable will last indefinitely. J. H. Shepherd Son and Company, 1820 East Avenue, Elyria, Ohio.

◆ Fishermen can now apply shot to their lines in a twinkling with a new Shot-A-Matic dispenser. This handy little device holds a supply of 3/0 split-shot and all the fisherman has to do is dial a shot into position in a feeder slot, insert line in slot, press plunger—and presto, the job is done. The Shot-A-Matic is molded of transparent Eastman Tenite butyrate plastic and won't rust or shatter. Varco Products Company, 1015 Juniper Avenue, Boulder, Colorado.



Hospital Capsules

Beatrice H. Hill

• The Westchester County Recreation Commission, New York, and the National Recreation Association co-sponsored a one-day institute in White Plains, on February 5, on "Recreation for the Aged, Ill and Handicapped" (primarily those in nursing homes). Westchester County is working very progressively towards a closer relationship between the nursing home owner and the local recreation commission. The outcome will be a carefully formulated recreation plan, with trained volunteers under supervision of personnel indoctrinated in recreation.

• The National Association of Recreational Therapists will hold their annual hospital meeting in Chicago at the Hotel LaSalle, March 20-21. The topic will be "Recreational Care for the Mentally Ill and Mentally Retarded." There will be tours of Chicago hospitals, some very fine addresses by psychiatrists, panels on music, sports, games, clubs, parties, dancing, and special workshops in rhythm band and folk dancing.

• April 28-30, the Third Southern Regional Institute in Hospital Recreation will be held at the University of North Carolina in Chapel Hill. Conferences with doctors, workshops on supervision leadership, adaptation of activities and interpretation will be featured. For further information, write Harold V. Meyer, Box 1139, University of North Carolina, Chapel Hill.

• Teachers College, Columbia University, and the National Recreation Association are planning a conference in June, to consist of two two-week sessions, with or without a two-point credit each, for a University fee of fifty dollars. Preliminary plans indicate an intensive in-service course of training for those hospital recreation professionals who feel a need of expanding and improving the recreation services in their institutions. Emphasis will also be placed on methods and techniques of

the professional worker and of the potential college graduate.

There will be daily class lectures and demonstrations at the college as well as field work in an institution which matches the needs and interests of the student. Further information will be announced in this column at a later date.

• I wonder how many recreation leaders read the very fine article in the January 3 issue of *Life*, "The Age of Psychology in the U. S.," the first of a series by Ernest Hairmann? I call attention to it because it contains an upsetting aspect . . . a picture of the hospital team that treats a mental patient, with practically every department mentioned with the *exception of recreation*. Recreation in a mental hospital, as we know, is very important in the patient's daily care; and yet, in a national publication like this, we are still so little recognized professionally that we are not mentioned along with the other members of the hospital team.

• Another interesting article, in *The New York Times*, January 13, by Dr. Howard A. Rusk, in his regular Sunday column, tells us that today there are more general hospital beds than ever before; and since the Hill-Burton Hospital Survey and Construction Program started in 1948, the nation has gained 253,000 acceptable new ones . . . "In contrast to this improving picture in numbers and distribution of general hospital beds, the availability of chronic hospital, nursing home and rehabilitation beds has worsened. Studies . . . show we have only about half the nursing home beds needed and almost half of those we do have are not acceptable by state standards of health and safety. Hill-Burton inventories in mid-1956 showed an over-all need for 395,000 nursing home beds. There are now 218,000 such beds, of which 103,000 were not acceptable."

He also notes that, in the entire country, there are only twenty-eight comprehensive rehabilitation centers. He closes by commenting that, as the life-span continues to lengthen, the number of persons affected by chronic disease and physical disability will continue to mount. Thus, dynamic action must be taken for the care of this increasing hospital population. ■

MRS. HILL is the NRA consultant on hospital recreation.

NATIONAL BASES



PRECISION BUILT QUALITY GUARANTEED

Nationally Preferred

Write for our new Base Catalog.

NATIONAL

Sports Company

370 N. MARQUETTE STREET
Fond du Lac, Wisconsin

Wear Your Golden Age Club Pin With Pride Wherever You May Go



EXACT SIZE

Designed by representatives of over 100 Golden Age clubs and used nationally. Gold colored metal with evergreen tree in jewelers' enamel. Symbolic of long life, strength and perseverance. The words LOVE, PLAY, LEARN, SERVE (greatest values of club membership) enameled in black. The border is a laurel wreath for honor. Safety catch.

Available Only to Authentic Clubs.

50c each, minimum order 10 pins.

James Spencer & Co. 22 N. 6th Street
Philadelphia 6, Pa.

IDEA BOOK ENAMEL ON COPPER



64 PAGES

Learn jewelry making; latest enameling processes and techniques from step-by-step illustrated instructions. Book lists many new copper items, complete supplies, tools & equipment. Send for your copy of this valuable reference book today! (It's FREE!)

THE COPPER SHOP

A Div. of Immerman & Sons • Dept. 170
2185 EAST 14th • CLEVELAND 15, OHIO

monroe FOLDING BANQUET TABLES



If you are on the Board of your Church, Lodge, Club, School, etc., you will be interested in this modern Folding Banquet Table.

Completely finished tops, resistant to most serving hazards. Used with or without table cloths.

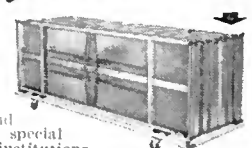

Write for Table and Truck Catalog and special price discounts to institutions and organizations.

Monroe Co., 181 Church St., Colfax, Ia.

Jamison PLAYGROUND EQUIPMENT

Be sure to check the many exclusive features of this rugged line. Write for free catalog of 254 items.

Jamison Manufacturing Co.
3781 South Muttler Street
Los Angeles 3, California

Since 1925

Books & Pamphlets Received

- ACT IT OUT, Bernice Wells Carlson. Abingdon Press, 810 Broadway, Nashville 2. Pp. 160. \$2.00.
- AND ON THE RIGHT (Guide to New York City). Jack Horn, 262 West End Avenue, New York 23. Pp. 140. Paper \$1.00.
- CREATIVE ART (Elementary Grades). Fran Trucksess. Fran Trucksess, P. O. Box 412, Boulder, Colorado. Pp. 105. Paper \$3.00.
- DANCE PRODUCTION, Gertrude Lippincott, Editor. American Association for Health, Physical Education and Recreation, 1201 Sixteenth Street, N.W., Washington 6, D.C. Pp. 102. Paper \$1.50.
- EASY WAYS TO EXPERT WOODWORKING, Robert Scharff. McGraw-Hill, 330 West 42nd Street, New York 36. Pp. 185. \$3.95.

INDEX OF ADVERTISERS

	PAGE
All-Metal Tennis Table Company	107
American Camping Association	89
American Playground Device Company	69
Association Press	103
Audio Equipment Company	Outside Back Cover
California State Personnel Board	69
Cleveland Crafts Company	89
The Copper Shop	109
D. M. R. Loop Tennis Company	91
Dimco-Gray Company	91
H. & R. Manufacturing Company	110
Hillerich & Bradsby	Inside Front Cover
Hillyard	65
Jamison Manufacturing Company	109
Jayfro Athletic Supply Company	69
J. C. Larson Company	91
The MacGregor Company	96
The Monroe Company	109
National Catholic Camping Association	Inside Front Cover
National Sports Company	109
Rawlings Sporting Goods Company	103
The Ronald Press	107
James Spencer & Company	109
Square Dance Associates	89
Superior Industries Corp.	91
Vogel-Peterson Company	89
Voit Rubber Corporation	91
X-acto, Inc.	91

FLOWER SHOW THEMES AND ARRANGEMENT CLASSES FOR DEVELOPING THEM, Dorothy Biddle. Hearthside Press, 118 East 28th Street, New York 16. Pp. 64. \$1.95.

LEADERSHIP AND ROLE EXPECTATIONS, Ralph M. Stogdill, Ellis L. Scott, William E. Jaynes. Bureau of Business Research, Ohio State University, Columbus 10. Pp. 168. Paper \$2.00.

LEARN CHESS FROM THE MASTERS, Fred Reinfeld. Dover Publications, 920 Broadway, New York 10. Pp. 144. Paper \$1.00.

LET'S GIVE A SHOW, Bill and Sue Severn. Alfred A. Knopf, 501 Madison Avenue, New York 22. Pp. 178. \$2.50.

LIVING SAFELY, Roy Stewart. Burgess Publishing Company, 426 South Sixth Street, Minneapolis 15. Pp. 101. Paper \$3.00.

PSYCHOLOGY FOR LIVING, Eugene H. Sloane. Owl Press, Bay Ridge, Annapolis, Maryland. Pp. 136. \$3.00.

PUBLIC RELATIONS FOR SOCIAL AGENCIES, Harold P. Levy. Harper & Brothers, 49 East 33rd Street, New York 16. Pp. 208. \$3.50.

READING WITHOUT BOUNDARIES, Frances Lander Spain, Editor. New York Public Library, 42nd Street and Fifth Avenue, New York 36. Pp. 104. Paper \$1.00.

SCHOOL-COMMUNITY LEADERSHIP, Dorman G. Stout. William C. Brown Company, 215 West Ninth Street, Dubuque, Iowa. Pp. 141. Paper \$2.75.

SCHOOLS FOR THE NEW NEEDS: EDUCATIONAL, SOCIAL, ECONOMIC. F. W. Dodge Corporation, 119 West 40th Street, New York 18. Pp. 312. \$9.75.

SHORT SKIN DIVING COURSE, Joe Micek and Sherman Poska. Jewish Community Center, 101 North 20th Street, Omaha, Nebraska. Pp. 11. Free (enclose self-addressed 11"x8½" envelope with six cents postage).

SOCIAL WORK YEAR BOOK—1957, Russell H. Kurtz, Editor. National Association of Social Workers, One Park Avenue, New York 16. Pp. 752. \$7.50.

URANIUM PROSPECTING, Hubert Lloyd Barnes. Dover Publications, 920 Broadway, New York 10. Pp. 117. Paper \$1.00.

WHY NOT WRITE? William Redgrave, Editor. Harian Publications 12 Broadway, Greenlawn, New York. Pp. 56. Paper \$1.00.

YOU AND MUSIC. Channing L. Bete Company, Box 506, Greenfield, Massachusetts. Pp. 15. \$1.50.

WHAT'S HAPPENING IN SCHOOL INTEGRATION? (#244), Harold C. Fleming and John Constable. Public Affairs Pamphlets 22 East 38th Street, New York 16. Pp. 20. \$25.

Magazine Articles

ADULT LEADERSHIP, *January 1957*
Music in Adult Life, *Max Kaplan.*
The Development of Mature Individuals, *John C. Whitehorn.*

—, *February 1957*
The Mature Attitude, *Edgar Z. Friedenberg.*

CAMPING MAGAZINE, *January 1957*
Camper-Centered Program, *Thomas S. Cohn.*

Counselor-Camper Relationships, *A. T. Leonard and Fred van Hartesveldt.*

The Value of Art in Camp, *Dorothea R. Flood.*
—, *February 1957*

Choosing Your Camp Naturalist, *Alfred L. Hawkes.*
The Story Teller at Camp, *Arthur Lewis Zapel.*

The Value of Co-Ed Camping, *C. Owen and Catherine G. Greene.*

JOURNAL OF HEALTH, PHYSICAL EDUCATION, RECREATION, *January 1957*
A Play-Way to Fitness. *George Van Bibber.*

Role Playing Vitalizes Pre-Camp Training, *J. Bertram Kessel.*

PARK MAINTENANCE, *January 1957*
Workreation.

THE SATURDAY EVENING POST, *February 2, 1957*
He's Tough on Kids, *Charles Price.*

UNDERSTANDING THE CHILD, *January 1957*
Values and Dangers of the Sociogram, *Arthur R. DeLong.*

NEW AND IMPROVED RYAN'S H. & R.

DRY LINE MARKERS

5 DIFFERENT MODELS
From 20# to 100# Capacity

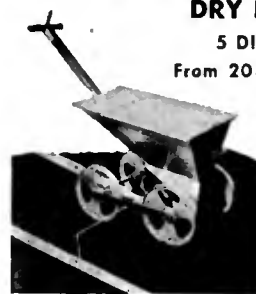

Force Feed — Instant Shutoff — 50 lbs. capacity.

Shaker in Hopper for Constant Flow.

Adjustable Control on Handle.

SAVES TIME AND MATERIAL

Send to Dept. R for booklet on four other models
H. & R. MFG. CO., LOS ANGELES 34, CALIF.

JUNE
is
National Recreation Month

NEW



PUBLICATIONS

Covering the Leisure-time Field

So You're Gonna Ride a Bus

A Bus Program for the Day Camp

Jerry Witkovsky and Mort Schrag.

Jewish Community Center Division, National Jewish Welfare Board, 145 East 32nd Street, New York 16. Pp. 19. \$.50.

This is a nineteen-page pamphlet, so unusual and so excellent that we felt it worth including here. Transportation to and from a day camp (or any other location), or during a trip or tour can be a headache; or it can be an integral, planned part of the recreation program. This pamphlet is filled with practical, imaginative ways of making the bus trip not only orderly and fun, but a valuable part of the child's experience.

Include it in your pre-camp, or pre-playground training courses. See that any leader who will be in charge of a bus full of youngsters, whether they're going to the day camp, the beach, the zoo, or what have you, gets a copy of this pamphlet. It's an excellent piece of work—and much needed.

The Ship of Peace

Elsie Denean Hunt. Pageant Press, 101 Fifth Avenue, New York 3. Pp. 178. \$3.00.

This is an entertaining personal account of family vacationing in a modern "covered wagon"—or trailer—which makes it possible for its owners to stop wherever they wish. The title refers to the peace of mind and relief from daily problems which can accompany such trips. There are incidents of humor and adventure mixed with philosophical observations.

Recreation and the Local Church*

Frances Clemens, Robert Tully, Edward Crill, Editors. Brethren Publishing House, Elgin, Illinois. Pp. 191. \$2.75.

Many books have been published in recent years about recreation, its administration, program activities, leadership, and so on; but few have been dedicated specifically to church recreation and its guiding principles. Now, the three editors of this book attempt to put the Christian faith and recreation together in such a way that each supplements the other. It is interesting that

this is still a needed service and that we must continually fortify ourselves against the taboos of our Puritan ancestors—who held that play is a sin.

This book was actually written by a recreation workshop group, sponsored by the Church of the Brethren in 1954, with the "editors" acting as its editorial committee. It presents a philosophy of church recreation and techniques of leadership practical for the church setting. It can act as guide and counsel to pastors as well as to group leaders. Specific program suggestions include ways to discover and develop better lay leaders, the place and use of recreation in all phases of the church-program, a developmental chart, and suggestions for age groups to guide leaders in the use of recreation, guidance and help on church buildings and facilities needed for fellowship and recreation purposes.

The Proof of the Pudding: What Children Read

Phyllis Fenner. John Day Company, 62 West 45th Street, New York 36. Pp. 246. \$3.95.

If you are interested in why and what children read, which books have withstood the test of years and meet children's interest, even in this age of television and other distractions, you'll smile over and thoroughly enjoy this book. The warmth of the author glows through every page. Her long experience as librarian in the Manhasset, New York, public schools has given her an insight into books that please youngsters. Her experiences and suggestions will be of great service to those personally or professionally interested in stimulating better reading habits among today's children. If you are ever in doubt as to what book to buy for what child, consult this book. When you do, however, you won't be able to put it down because it's such fun to read.

Water Skiing for All

Walter N. Prince. Greenberg: Publisher, 201 East 57th Street, New York 22. Pp. 205. \$3.50.

After you have read the article on water skiing in this issue (page 100),

* Available through the NRA Recreation Book Center, 8 West Eighth Street, New York 11.

you'll want to order this book. The author has been associated with ski schools from California to Florida and has instructed students from six to sixty years old.

This book is well-organized, well-illustrated, easy to read, and covers all phases of water skiing. Its method of organization lends itself to use as an instruction manual. Recreation departments and other youth-serving agencies will find the chapters on schools and tournaments very helpful in setting up such services.

How to Make Good Tape Recordings

C. J. LeBel. Audio Devices, Inc., 444 Madison Avenue, New York 22. Pp. 159. Paper \$1.50; cloth \$2.50.

This manual with its up-to-date information should be very helpful to anyone interested in making tape recordings; the authors of all sections are specialists. It is non-technical and easy to read, the text being made additionally clear by the use of diagrams.

Subjects such as how to select tape recorders, how to edit recordings, acoustically treat studios, and put together shows are covered by experienced people. The many uses of a tape recorder—such as making commentaries for movies, recording musical programs, teaching, improving staff speaking techniques, recording board or committee meetings, making sound effects, taking down commentaries by interested citizens for radio use, taping church services, and so on—are discussed.

In fact, the use of a recorder is as broad as the thinking of the individual using it.

It would be hard to get along without a tape recorder after one is in the habit of using it.—R. B. McClintock, Superintendent, Parks and Recreation, Omaha, Nebraska.

The Golfers Own Book

Dave Stanley and George G. Ross, Editors. Lantern Press, 257 Fourth Avenue, New York 10. Pp. 342. \$4.95.

This aptly titled book is, indeed, a jack pot of golf information. It includes, for instance, tips from experts on playing techniques, discussions of equipment and its care, information about places to play, clothes to wear, off-beat data, and a glossary of golf terms. It even devotes a section to golf fiction and humor. Among the experts who have contributed are: Bobby Jones, "On Stance and Swing"; the late Mildred (Babe) Zaharias, "Tee and Fairway Woods"; Cary Middlecoff, "The Swing"; Lealand Gustavson, "You and Your Caddy"; Joe Novak on "Putting and Approach Shots"; and others. ➡

Outdoor Horizons

Lawrence M. Brings, Editor. T. S. Denison & Company, 321 Fifth Avenue South, Minneapolis 15. Pp. 231. \$7.50.

This book covers all phases of wild-life and wilderness experiences and sport, with how-to-do-it information on hunting and fishing and interesting and important sidelights by experts and organizations such as the Audubon Society, National Wildlife Federation, U. S. Fish and Wildlife Service. It is illustrated with sketches, black and white photographs, and color reproductions of photos and paintings including a series by Roger E. Preuss.

American Mountain Songs

Compiled by Ethel Park Richardson, edited and arranged by Sigmund Spaeth. Greenberg: Publisher, 201 East 57th Street, New York 22. Pp. 120. \$3.50.

Everyone who loves folksongs will enjoy this collection. Many people have collected the English songs that are still found intact in our Southern moun-

tains, but this collection includes those originated in the American highlands.

The book is divided into four sections: ballads, lonesome and love tunes, spirituals, and nonsense songs. Very probably somewhere in it you'll find the song your grandmother sang when she rocked you to sleep.

Add this book to your collection of folksongs. You'll find songs that your choruses will enjoy and their audiences love.

Camp Reference and Buying Guide—1957

Galloway Publishing Company, 120 West Seventh Street, Plainfield, New Jersey. \$2.00.

Almost anyone who expects to have anything to do with operating or working in a camp will find value in the tenth anniversary edition of the *Camp Reference and Buying Guide* just out. Its more than one hundred and fifty pages are crammed with a wide variety of factual answers to questions likely to come up during a camping season.

The book is divided into sections on

business management, food and food service, health and safety, maintenance and development, and program. Each section is further subdivided to cover a wide range of activities. For example, the program section contains information on more than two hundred different craft projects, graded by age of camper, with a list of required materials. Also covered under program are photography, boat mooring methods, dimensions and diagrams of fields and courts for most popular camp sports, a checklist of sports supplies, riflery pointers, graded tests of camping skills, equipment for out-of-camp trips, camp movies, and so on. Other sections are similarly comprehensively covered.

Included also is a bibliography of over three hundred books in the field of camping; section on the American Camping Association, of which the *Camp Reference and Buying Guide* is an official publication; and the buying guide which lists hundreds of sources.

Flower Show Themes and Classes

Dorothy Biddle. Hearthstone Press, 118 East 28th Street, New York 16. Pp. 64. \$1.95.

Anyone who has visited a flower show, taken a course in flower arrangement or who hopes to promote flower shows and flower-arranging classes will find a tremendous amount of new, interesting and lovely ideas in this little 64-page book. It has ideas for table settings, arrangements and themes for holidays and anniversaries, and (most helpfully) ideas for themes suitable for juniors—those lucky children who are encouraged to become interested in flower arranging.

The author, as any garden club member can tell you, has been a leader in this field for twenty years. She is now garden club editor of *Popular Gardening* magazine, and co-author, with her daughter, of nine books.

True-To-Life Stories for Campers

Have you seen the attractive little "True-To-Life Series" of stories by R. W. Eschmeyer, published by Fisherman Press, Oxford, Ohio? They're attractive, well-written, accurate, and inexpensive. The following titles are available from the publisher: *Al Alligator*, *Billy Bass*, *Bobby Bluegill*, *Charley Cottontail*, *Freddy Fox Squirrel*, *Mac Mallard*, *Tommy Trout*, *Bob White*, *Willie Whitetail*, and *Woody Woodcock*.

Each has been checked by experts. Campers will love them, and learn from them. Hard cover edition, \$1.00 each; paperback, \$.50. Use the former for the camp library, the latter for personal copies for campers.

Use *Recreation* Magazine CLASSIFIED ADVERTISING

If you want to publicize information about . . . HELP WANTED . . . POSITIONS WANTED . . . SERVICES AVAILABLE . . . WORKSHOPS AND CONFERENCES . . . EDUCATIONAL OPPORTUNITIES . . . ITEMS FOR EXCHANGE

HERE'S HOW:

1. Type—or clearly print—your message and the address to which you wish replies sent.
2. Underline any words you want to appear in boldface type.
3. Count the number of words in the message and the address: Count each group of numbers as one word (e.g., "856 East Fifth Street" or "Salary \$5,000 per year" would each count as four words).
Count boldface words separately.
4. Figure the cost of your ad: Words in regular type . . . \$15 each
Words in boldface type . . . 25 each
Minimum ad accepted \$3.00
5. Mail your copy with your remittance to Recreation Classified Ads, 8 West Eighth Street, New York 11, New York. Copy must be received by the fifth of the month preceding the month of the issue in which ad is desired (e.g., April 5 to appear in the May issue).

SAMPLE ADS

HELP WANTED

Playground Director, man or woman, for town of 6,000. Salary \$380 to \$450 per month based on experience. Send complete resume of education and experience. James Smith, City Courthouse, Funville, Maine.

Cost: Boldface—2 words at \$.25 . . . \$.50
Regular—29 words at \$.15 . . . 4.35
Total cost of above ad would be \$4.85

WORKSHOPS & CONFERENCES

Square Dance Workshops. Weekly summer workshops for recreation leaders. Qualified instructors, sessions for beginners to advanced leaders. Write Director, Square Dance Camp, Riverview, Montana.

Cost: Boldface—3 words at \$.25 . . . \$.75
Regular—21 words at \$.15 . . . 3.15
Total cost of above ad would be \$3.90

POSITIONS WANTED

Crafts Instructor desires position with public recreation program in Midwest. Ten years experience in all phases of crafts, specializing in ceramics and weaving. Minimum salary \$4,500 per year. Jane Jones, 512 Orchard Street, Wide Falls, Michigan.

Cost: Boldface—2 words at \$.25 . . . \$.50
Regular—34 words at \$.15 . . . 5.10
Total cost of above ad would be \$5.60

ITEMS FOR EXCHANGE

Have Twelve Tennis Nets, good condition, to swap for softball bases or backstop. Recreation Department, Mill City, Maryland.

Cost: Boldface—3 words at \$.25 . . . \$.75
Regular—15 words at \$.15 . . . 2.25
Total cost of above ad would be \$3.00

IMPORTANT: REMITTANCE MUST ACCOMPANY ORDER!

Recreation Leadership Courses

Sponsored by the National Recreation Association

and

Local Recreation Agencies

March, April and May, 1957

HELEN M. DAUNCEY Social Recreation	Fayetteville, Arkansas March 11-14	Troy N. Hendricks, Head, Department of Health, Physical Education and Recreation, University of Arkansas
	Sherman, Texas April 8-11	Mrs. Ralph Day, Assistant Professor of Physical Education, Austin College
RUTH G. EHLERS Social Recreation	New York City April 1	Miss Maxine Keith, Executive Director, Girls Clubs of America, Inc., 130 Maple Street, Springfield, Massachusetts
	State of Vermont May 6-16	Mrs. A. O. Brungardt, Vermont Director of Recreation, State House, Montpelier
ANNE LIVINGSTON Social Recreation	Aiken, South Carolina March 25-28	Darrell Robinson, Jr., Superintendent, Aiken County Recreation Commission, Box 2085
GRACE WALKER Creative Recreation	Association for Childhood Education Convention Youngstown, Ohio May 18	Miss Sally Davis, 1202 East Indianola Avenue

Attendance at training courses conducted by National Recreation Association leaders is usually open to all who wish to attend. For details as to location of the institute, contents of the course, registration procedure, and the like, communicate with the sponsor of the course as listed above.

Miss Walker will attend the Northland Recreation Leaders Laboratory in Minnesota, April 24 through May 2.

Miss Dauncey will be in the Pacific Northwest Area during the week of March 4, conducting a leadership course at Fairchild Air Force Base, Spokane, Washington. For further information communicate directly with Linus L. Burk, Air Force Regional Representative, 1345 Lincoln Avenue, San Rafael, California.

Miss Dauncey will be in the Southwest Area the weeks of March 18 and 25 and April 1 at the following air bases: Little Rock Air Force Base, Arkansas; Barksdale Air Force Base, Shreveport, Louisiana; and Kelley Air Force Base, San Antonio, Texas. For further details concerning the above three courses write to R. C. Morrison, Air Force Regional Representative, 248 Casa Blanca, Fort Worth, Texas.

Miss Dauncey will conduct recreation leadership training courses for the United States Air Force in Europe April 22 through May 31.

Frank A. Staples will be conducting two-week arts and crafts training workshops March 11 through April 18 in the Southwest Area at the following air bases: Lake Charles Air Force Base, Louisiana; Bergstrom Air Force Base, Austin, Texas; Reese Air Force Base, Lubbock, Texas. For further information, R. C. Morrison, at address above.

Mr. Staples will be in the Pacific Northwest Area from April 22 through 26. For further information, Howard Beresford, 3055 Bellaire, Denver 7, Colorado.

Mr. Staples will be in the Pacific Northwest and Pacific Southwest Areas April 29 through May 10. For information, Linus L. Burk at address above.

Mr. Staples will be in the Midwest Area at the following air bases for two-week periods beginning May 13: Mt. Home Air Force Base, Idaho; Offutt Air Force Base, Omaha, Nebraska. For information, Howard Beresford at address above.



Make yourself HEARD!
— without KILLING your voice.

Now you can **speak** — directly — to individuals or groups — throughout your park, playground, beach or pool. With Audio Hailer, you can talk in a normal voice . . . and make yourself understood up to half-a-mile away. You'll use your Hailer dozens of times every day . . . for announcements and paging, for aquatic sports and all wide-area games, for beach and pool supervision. Indispensable, in case of storms, lost persons, other emergencies. Audio Hailer is the **ONLY** electronic megaphone with a genuine vacuum-tube amplifier. Yet it is completely self-contained, operates on dry batteries, weighs **only 5½ lbs.!** For more details or demonstration, just clip coupon below to your letterhead. Audio Equipment Co., Inc., Great Neck, N. Y.



AUDIO
HAILER®

COMPLETELY SELF-CONTAINED
 ELECTRONIC MEGAPHONE
Amplifies your voice 1000 times!

Digitized by M

AUDIO EQUIPMENT CO., INC., Great Neck, N. Y.
 I would like brochure demonstration of Audio Hailer

NAME _____
 TITLE _____
 AUTHORITY _____
 ST & NO _____
 CITY OR TOWN _____

ZONE _____ STATE _____
 (if any)

Recreation

Henry Pfeiffer Library
MacMurray College
Jacksonville, Illinois

APR 17 1957



Playground Issue

Digitized by NATIONAL RECREATION ASSOCIATION

APRIL 1957 C 50c

FOR SUPERIOR DESIGN, CONSTRUCTION
AND PERFORMANCE... FAR GREATER
STRENGTH... UNEQUALLED SAFETY...



AMERICAN

Approved

PLAYGROUND SWIMMING POOL and DRESSING ROOM EQUIPMENT

Since 1911 the finest equipment built,
backed by lifetime guarantee against
defective materials and construction
... specified by leading recreational
authorities for almost half a century.

Send for New Catalog

Write for Folder
On AMERICAN'S
JIM PATTERSON
LIFETIME
Aluminum
DIVING
BOARD
WORLD'S FINEST
OFFICIAL BOARD



If you are planning the construction of an
Ice Skating Facility in the near future consult
a firm that has designed and engineered 17
ice skating rinks and arenas in the past year

**INDOOR • OUTDOOR
PERMANENT • PORTABLE**

Take advantage of our invaluable knowledge and
experience of ice rink feasibility, planning and
construction.

**COSTS
REVENUE
FINANCE
ENGINEERING**

**OPERATION
PROMOTION
EQUIPMENT
SITE PLANNING**

We now are designing 23 rinks and arenas for the
1957 season, and have just completed the design
of 5 outdoor rinks for the City of Buffalo.

Peter Carver Associates

70 EAST 45th STREET
NEW YORK 17, NEW YORK

Phone: LExington 2-1520

OUR REFERENCES AND EXPERIENCE ARE YOUR GUARANTEE



"The Choice of Those Who Play The Game"

The MacGregor Co. • Cincinnati 32, Ohio
FOOTBALL • BASEBALL • BASKETBALL • GOLF • TENNIS



Work with people
new, creative applications...

SOCIAL GROWTH THROUGH PLAY PRODUCTION

by JACK SIMOS Executive Director,
Children's Aid Society of Indiana

How to help older adolescents and
adults grow to social maturity
through direct participation in for-
mal and traditional dramas.

Practical step-by-step processes
enable the individual to discover
rich and lasting values by acting
in plays carefully selected for max-
imum learning potential and men-
tal stimulation.

Concrete examples taken from
many diversified settings (commu-
nity centers, colleges, treatment
centers) reveal how individuals, in
therapy or for normal growth
guidance, attain lasting benefits
from this unique use of the dra-
matic arts. \$3.75

PARTIAL CONTENTS —

Drama and Human Rela-
tions—A Creative Approach
— How to Do It (Rehears-
als in detail, performances,
evaluation) — The Use of
Play Production in a Resi-
dential Treatment Center—
Techniques and Methods of
Direction — Significance to
the Participants—The Play-
er and the Part—Benefits of
Participation in Play Pro-
duction — Features of the
Program Medium Favorable
to Personal and Social
Growth—Selecting the Play
—Who Should Do It.

ASSOCIATION PRESS

291 Broadway
New York 7, N. Y.

The Finest FEATURE FILMS

GIVE THE BEST IN *Entertainment* THIS SUMMER



FROM THE STUDIOS OF
M-G-M, WARNER BROS.
20th CENTURY-FOX, WALT DISNEY



KIM—Errol Flynn, Dean Stockwell.
Color and Black and White.

including **CINEMASCOPE** in 16mm!

NOW IS THE TIME for programming movies for your playground or recreation area; for setting up playdates, for getting booking confirmations. It's time to think of movie nights, recreation afternoons . . . to plan ahead for rainy day entertainment. Order now to assure best choice of films. Send us your list of showing dates and let us arrange a tentative schedule at no cost or obligation. Fill out the coupon below and send it to the Films Incorporated exchange nearest to you.



THE WINNING TEAM - Doris Day, Ronald Reagan. Black and White.

Special **PAY as you PLAY** offer!

- For you who do not customarily use features, Films Incorporated as an introductory offer, will deposit at your center an entertaining special feature film for that rainy day or as a treat for special occasions. Show the film and you pay, but if you don't use it, simply return it to your Films Inc. exchange. No obligation, of course!

B&W Rentals
From **\$7.50**
To **\$11.00**

To FILMS INCORPORATED R-457

Gentlemen: Please send me your latest catalog of films

My film showing dates are: _____

Please submit for me a schedule of your recommended features for the above dates

I am interested in B/W only ; in color only ; both B/W and color

NAME _____ LOCATION _____

BUSINESS ADDRESS _____

CITY _____ STATE _____



NEW YORK
202 East 44th Street

HOLLYWOOD
5625 Hollywood Blvd.

WILMETTE, ILLINOIS
1144 Wilmette Ave.

ATLANTA
277 Pharr Road, N. E.

DALLAS
1414 Dragon Street

PORTLAND, OREGON
2129 N. E. Broadway

Things You Should Know . .

▶ **THE FIFTH ANNUAL CONFERENCE** of State Inter-Agency Committees for Recreation will be held May 6-8 in colorful Roaring River State Park at Cassville in the Missouri Ozarks, with the Missouri State Inter-Agency Committee for Recreation acting as host. Total charge to delegates, everything included, will be twenty dollars. For further information write Robert L. Black, P.O. Box 207, Jefferson City, Missouri.

▶ **THE RECENT APPOINTMENT** of Ott Romney as assistant executive director of President Eisenhower's Youth Fitness Council is interesting news to recreation people. Ott has chalked up a distinguished career in the recreation field. Most recently he was recreation consultant for the Federal Housing Administration, and before that he was in charge of the recreation program for the U. S. Army in the Far East.

▶ **WHEN INDUSTRY LOCATES NEW PLANT SITES**, local recreation, "controlled or influenced by local government," is one of the factors which determines the final decision, according to Alex C. Boisseau, general manager of the Hickory Transformer Plant of the General Electric Company, in the January issue of *The Municipality*. He maintains that while recreation facilities do not insure outstanding industrial personnel, they are an indication of the stability of the individuals and their pride in their community. "These facilities are important," says Mr. Boisseau, "since to some extent they determine the desire of the community to combat juvenile delinquency and to provide good clean relaxation for the adults."

▶ **THE HOBBY FIELD** is playing an important part in the People-to-People international friendship activities program initiated by President Eisenhower last fall. PPP information kits, sent to hundreds of hobby groups, have stimu-

lated articles in hobby columns, magazines, speeches at hobby meetings, beginnings of overseas projects. Leading figures from all walks of life are joining a vast committee set-up, with subcommittees for each major hobby. Substantiating the claim that hobbies provide a natural avenue for people-to-people exchanges, contacts are already begun with persons overseas. Incidentally, the People-to-People Foundation, Inc., with President Eisenhower as honorary chairman, became a privately financed, privately directed, permanent organization in February, 1957.

▶ **THE ADOPTION OF A TEEN-AGE CONDUCT CODE** is being considered by many states, as an answer to reports of increasing juvenile delinquency. The last state considering such a code, which we have heard from, is Missouri.

▶ **DON'T FORGET MUSIC WEEK**, May 5 to 12. In a message received from the White House, President Eisenhower says, "During this week, as you encourage the performance of folk music of all nations, the opportunity is provided for a significant advance in international understanding. At the same time, it is fitting to promote present-day American music and to further the knowledge and appreciation of our own modern artists."

All-time favorite SONG SLIDES

Special close-out sale on 3 1/4" x 4" glass slides—10c per slide while available
(Regular price 50c)

~~~~~  
2" x 2" glass slides also in stock—50c per slide

Write for catalog

### NATIONAL STUDIOS

42 West 48th Street  
New York 36, N. Y.

▶ **THE FIRST NATION-WIDE OBSERVANCE** of Senior Citizen Month will take place during May 1957, under sponsorship of Senior Citizens of America, according to an announcement by Joy Elmer Morgan, president of SCA. Purpose of the observance is to focus attention on the new developments that have resulted from the gift of increased life expectancy.

▶ **TODAY'S DEMAND FOR ADVANCED TRAINING** in administrative managerial jobs has resulted in a "great hunt for educated talent," according to the president of the Carnegie Corporation. John W. Gardner, in the January 1957 issue of *Harper's*. "College graduates are taking over every central and significant activity in our society," he writes. "There is not the slightest question that business and industry now recruit their top leaders from the ranks of highly educated men."

▶ **FAMILIES UNABLE TO CONTROL THEIR DELINQUENT CHILDREN** will be ousted from public housing, according to a recent announcement by the New York Housing Authority. The new program, designed to protect decent families and the housing property, requires managers of the projects to report *all* incidents of hoodlumism or vandalism involving tenants, instead of following their own judgment on incidents they report as was done previously. Warren Moscow, executive director of the housing authority, said the reports will provide a complete file on families guilty of continued lawlessness, thus making possible speedier eviction of repeated offenders.

▶ **PARENTS WHO PERSIST** in conduct that contributes to a child's delinquency will be liable to prosecution for contempt of court under a new New York State law which became effective last July. Under the new law a judge may issue an order specifying conduct "such as would reasonably prevent delinquency or neglect." The order would remain in effect a year and would lapse if not renewed.

The maximum penalty is set at twenty-five dollars fine and thirty days in jail. Governor Harriman stressed in a memorandum that the new law does not make parents financially responsible for children's misdeeds. He vetoed a bill that would have done this.

▶ **ERRATA:** The song slides mentioned in this column last month are available for ten cents each *only* in the 3 1/4" x 4" size. ■

# Recreation\*



THE MAGAZINE OF THE RECREATION MOVEMENT

*Editor in Chief*, JOSEPH PRENDERGAST  
*Editor*, DOROTHY DONALDSON  
*Editorial Assistant*, AMELIA HENLY  
*Business Manager*, ALFRED H. WILSON

## CONTENTS

### GENERAL FEATURES

|                                                        |                     |
|--------------------------------------------------------|---------------------|
| Now We Are Fifty .....                                 | 116                 |
| The Fiftieth Candle .....                              | 117                 |
| Letters on Our Birthday .....                          | 118                 |
| Congress-by-the-Sea .....                              | 120                 |
| Playground Facts and Fun .....                         | 124                 |
| The Playground for Mentally Handicapped Children ..... | Harold W. Perry 128 |
| The Influence of Rural Environment on Children .....   | Anne S. Hoppock 129 |
| The Weeping Willow .....                               | Jane Gitelman 130   |
| A Town Meeting with Delinquents .....                  | Robert L. Smith 131 |
| Playgrounds on Parade .....                            | John Meehan 134     |

### ADMINISTRATION

|                                            |                      |
|--------------------------------------------|----------------------|
| "Dennis the Menace" Playground .....       | 136                  |
| Evaluation in Recreation-Playgrounds ..... | 149                  |
| Safety Program Recommendations .....       | 149                  |
| Concession vs Direction Operations .....   | Ralph M. Hileman 150 |
| Playgrounds for Creative Play .....        | Liselott Diem 151    |
| Notes for the Administrator .....          | 152                  |

### PROGRAM

|                                                        |                          |
|--------------------------------------------------------|--------------------------|
| The Girl in the Blue Denim Skirt .....                 | Connie Bloomquist 139    |
| The Maypole Dance .....                                | Olga Kulbitsky 140       |
| Try a New Idea .....                                   | 142                      |
| Notes on a Summer Experiment (Idea of the Month) ..... | Betty Yuriua Keat 143    |
| A Dump and a Dollar .....                              | Michael Solomon 145      |
| Storytelling on the Playground .....                   | Gladys Conklin 146       |
| Christopher Cheesemore (A Story) .....                 | Ruth H. Norris 147       |
| Lively Ideas for the Summer Play .....                 | Pamela Prince Walker 148 |

### REGULAR FEATURES

|                                                       |                      |
|-------------------------------------------------------|----------------------|
| Things You Should Know .....                          | 114                  |
| Letters .....                                         | See General Features |
| Editorially Speaking .....                            | 122                  |
| Reporter's Notebook .....                             | 132                  |
| Personnel—Join Forces for Better Training .....       | William H. Radke 156 |
| Classified Advertising .....                          | 157                  |
| Idea of the Month .....                               | See Program          |
| Books and Pamphlets Received, Magazine Articles ..... | 158                  |
| Index of Advertisers .....                            | 158                  |
| New Publications .....                                | 160                  |
| Recreation Leadership Training Courses .....          | Inside Back Cover    |

Vol. L Price 50 Cents No. 4

### On the Cover

WHERE YOU CAN TOUCH THE SKY! Climbing is one of the things that children do; it is adventure, and a part of the process of growing. Playground equipment especially built for this purpose is safer than the limbs of the old tree in the backyard. Photo courtesy of American Playground Device Company, Anderson, Indiana.

### Next Month

Norman Garbo, art teacher and author of the syndicated column for artists, *Pull Up an Easel*, takes the Sunday sketcher or summer hiker out-of-doors with art in "Pick Up Your Sketch Book"; and Mickey McConnell, director of training for Little League baseball gives some tips for other groups in "Teaching Baseball to Beginners." Three articles on swimming pools will be of interest to executives and swimming instructors. "A May Party on Rubber Wheels" was planned and put on in the Recreation Center for the Handicapped, San Francisco, and the story about it can serve as a pattern for, and inspiration to, other handicapped groups. Other articles cover a variety of program or general subjects.

### Photo Credits

Page 120, Harry Merriek; 124, E. L. Trenchard; 125, Ralph Winn, *Peoria Star*; 134-35, *Courier-Journal and Louisville Times*; 140, Mrs. Laura Motion; outside back cover, European.

RECREATION is published monthly except July and August by the National Recreation Association, a service organization supported by voluntary contributions, at 8 West Eighth Street, New York 11, New York, is on file in public libraries and is indexed in the *Readers' Guide*. Subscriptions \$4.00 a year. Canadian and foreign subscription rate \$4.50. Re-entered as second-class matter April 25, 1950, at the Post Office in New York, New York, under Act of March 3, 1879. Acceptance for mailing at special rate of postage provided for in Section 1103, Act of October 3, 1917, authorized May 1, 1924. Microfilms of current issues available University Microfilms, 315 N. First Street, Ann Arbor, Michigan.

Space Representatives: H. Thayer Heaton, 141 East 44th Street, New York 17, New York; Mark Minahan, 168 North Michigan Avenue, Chicago, Illinois.

Copyright, 1956, by the National Recreation Association, Incorporated

Printed in the U.S.A.



\* Trade mark registered in U. S. Patent Office.

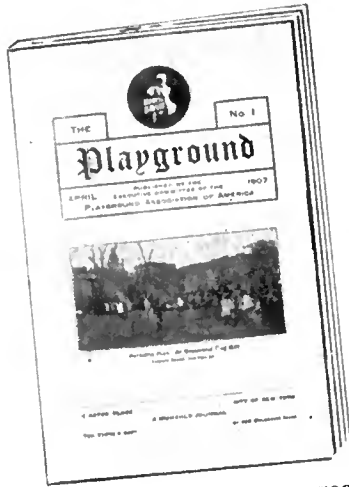

1907. At our birth, the new recreation movement was already meeting the problems created by the expanding leisure.

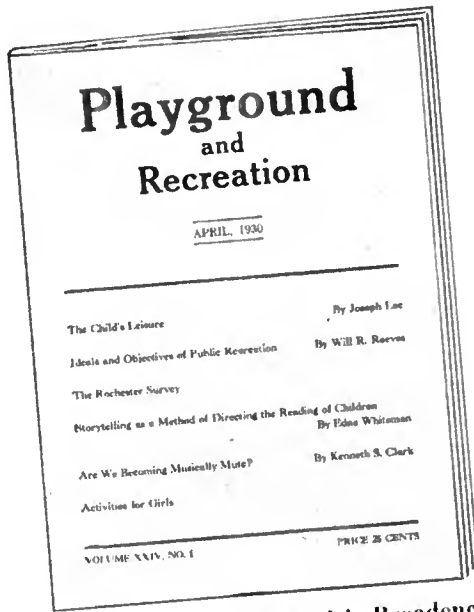

1930. Now a young adult! Broadened name is indication of the Association's concern with services to all age groups.



1948. We get more modern look! Interior format has also been changed and average issue now has forty-eight pages.



1949. New trends keep us busy! In addition to annual Playground Issue other special issues devoted to specific fields.



1908. One year old! Special issue covers banquet honoring Mrs. Humphrey Ward for services to English playgrounds.

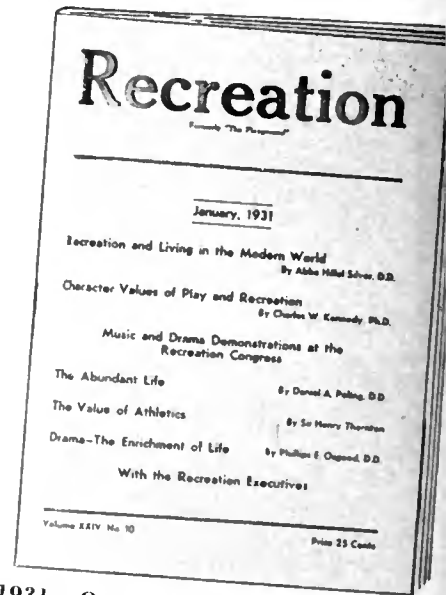

1931. Our new blue cover was to be introduced in April. Recreation had outgrown its early playground beginnings.



Today. As always, our contents are determined by the wishes and needs of our readers from all branches of recreation.

# Now We Are FIFTY

It makes us sad to think how few can  
recollect the time  
When we were called THE PLAYGROUND  
—and we only cost a dime.  
We wrote up each new play-space as a  
major news event,  
And when our field men traveled, we  
announced just where they went.  
For everyone and everything we always  
found a place —  
The tiny field of recreation didn't need  
much space!  
But now it's hard to fit in towns with  
brand-new swimming pools  
Or leaders who have doctorates from  
several top-flight schools.  
To cover all the news we'd need six  
columns to a page —  
Since leisure time has grown so much,  
we really feel our age.  
And since we've followed all this growth  
for forty years and ten.  
We think we've earned the reverence  
due a senior citizen!

—MMCG



1907

*Neither do men light a candle,  
and put it under a bushel, but  
on a candle stick; and it giveth  
light unto all that are in the  
house.—Matthew 5:15*

1957

# . . . The Fiftieth Candle . . . . .



**T**HIS MONTH, April 1957, RECREATION Magazine lights its fiftieth birthday candle—a candle which, like its forty-nine predecessors, is specifically designed to lend its light to the many matters of concern to all of us in the field of recreation. This month, these, fittingly enough, are matters pertaining to playgrounds; last month, they were matters pertaining to the coming camping season; always they are matters nearest to our hearts, our needs, or most immediate in our thoughts as workers and leaders.

The last fifty years have brought growth and change to the publication and to its readers as well. Time marches on; people are different; and as needs become different, ways of meeting them have to be different; means of communication in 1957 are not those of 1907.

The Playground Association of America has grown into the National Recreation Association, to serve the recreation needs of persons of every age; its magazine, now RECREATION, has adapted itself accordingly, and grown in its own right. Science and technology have presented us with a different world, and economic, industrial and social changes confront the recreation worker with the challenge of "the new leisure." Our field of interest and endeavor has become one which is of enormous importance to everybody.

RECREATION has mirrored, inevitably, the changes in both professional and popular thinking about play and recreation, although the basic philosophies of the early leaders of the Association still form its foundations. It was about 1906 when an appropriation for playgrounds in the District of Columbia was being discussed on the floor of Congress and one congressman, who probably reflected typical opinion of the time, is reported to have said, "What, teach children how to play? You might as well teach a fish to swim!" Today, we know that recreation has an important connection with individual health—mental and physical. We know that good family relations, good community relations, good human relations require adequate opportunities for outlet and expression through recreation. And we know, for instance, one of the most profound reasons for recreation is that through recreation activities people are able to experience adventure, find creative expression and achieve the finest human aspirations.

The trend toward a shorter working week—toward more

leisure for everyone—has been related to the recreation movement from the very beginning of the organization of the National Recreation Association. When Howard Braucher accepted the position as secretary of the organization in 1909, he wrote: "I believe with you that, with our child labor movement and the movement of the labor unions for a shorter working day, the recreation problem is one of the most vital problems we have yet to face at all adequately." Twenty-one years later, the National Recreation Association celebrated its twenty-fifth anniversary in a meeting at the White House. At that time Joseph Lee, who was president of the Association, said: "Leisure for everybody, a condition that we in America are now approaching is a new thing under the sun—the most revolutionary thing that ever happened. It means the coming of something unheard of in all history—the opportunity for every man to live. . . ."

Joseph Lee's prediction has come true; and this, then, is the world in which the magazine has its being today. As in the beginning, it is dedicated to bringing inspiration and help to recreation workers and to interpreting the field of recreation to the general public.

From our hearts we thank our readers, who are our contributors and our co-workers, for the interest and support which have made The Magazine of the Recreation Movement possible and which keep it flourishing even in these modern years with so many conflicting demands. It is upon such interest, on the part of such persons, that the recreation movement has been built.

We are grateful, too, for the opportunity of these fifty years of service by means of the printed word. We wish for our magazine many more years of steady growth—with more and more people supporting it and using it, so its light may continue to shine forth as an ever-stronger illumination and support in the job that lies ahead.

*Executive Director, National Recreation Association*

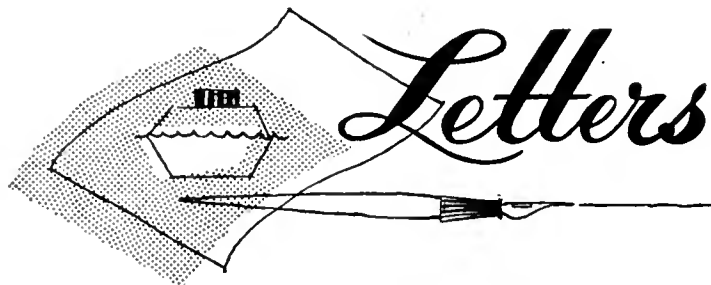

## On Our Birthday

*Our magazine is fifty years old this month! On these pages some old friends send us greetings and share our rejoicing.*

### A Salute, and Thanks . . .

Sirs:

The fiftieth birthday of RECREATION Magazine is an event which should not go unnoticed. For a half century, your excellent publication has been a powerful, positive force for recreation in our country and throughout the world.

We in the field salute you, congratulate you, and thank you. We salute you for the high standards you have maintained. We congratulate you on the wide range of coverage you have always managed. We thank you for the tremendous help you have been to us.

As you move into your second half-century, may the accomplishments of the past serve as a firm foundation for the challenges of the future.

HARLEIGH B. TRECKER, *Dean, University of Connecticut School of Social Work, Hartford.*

### A Dog-Eared Member . . .

Sirs:

Fifty years—half a century—cover two silver anniversaries! When stated this way it seems a long, long time, and yet when one compares the fifty years of the recreation movement, of which RECREATION Magazine is closely identified and somewhat symbolic, one must realize it is a brief, brief time in the span of civilization.

How does one measure the conversion from words to action that has resulted in the thousands, perhaps, millions, of people who have reviewed this most worthwhile publication in these fifty years? We recently checked our department library on RECREATION and found it the most "dog-eared" member of our educational, recreational, referral stack. Probably no publication to date can occupy the same shelf as RECREATION when weighted on its contribution to the good life. This includes research, practical articles in programing, pictures demonstrating thousands of words unwritten, ad infinitum.

The golden anniversary of RECREATION Magazine certainly shines untarnished in the eyes of the profession.

J. EARL SCHLUPP, *President, American Recreation Society.*

### The Universal Approach . . .

Sirs:

The growing acceptance of recreation, not only in the Army but throughout America, can be attributable to the high caliber and dedication of the individuals who have pioneered and spearheaded the struggle for the recognition of recreation as a profession and as a movement devoted to the development and utilization of a concept of a rich, satisfying and constructive leisure for all citizens. The universal approach of RECREATION, its guidance to the profession, its leadership in defining principles and its broad yet essentially human exposition of the objective and techniques of recreation have done much to foster the education of the public and government in this fine and traditionally American movement.

Please accept the greetings and felicitations of Army Special Services—may RECREATION continue in the future to meet the challenge with the same high spirit and record of accomplishment.

L. W. JACKSON, *Colonel, AGC, Chief, Special Services Division, Department of the Army, Washington, D.C.*

### A Major Force . . .

Sirs:

For fifty years the National Recreation Association and RECREATION Magazine have provided the solid foundation upon which the American recreation movement has been built.

RECREATION Magazine, particularly, has been a major force in this movement. It helped start the recreation movement in the United States fifty years ago. It promoted its growth, aided its development, and is now guiding its sound expansion.

The yardstick that measures a magazine's effectiveness cannot be scaled to one big event. Rather, it is the month-by-month, year-by-year service that a publication extends to its readers which is the true measure of a magazine's effectiveness. RECREATION Magazine has provided an invaluable service to the workers and leaders in American recreation during every month of its fifty-year existence.

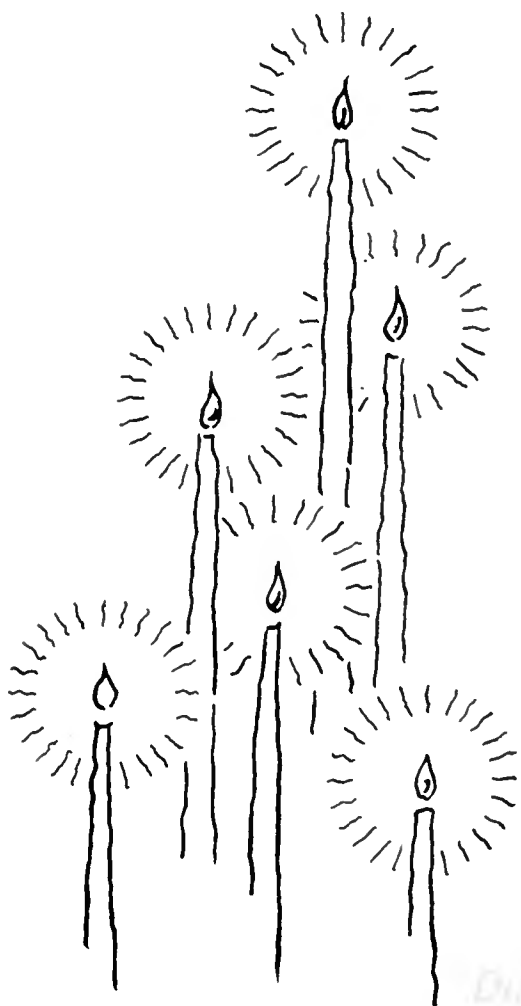

I want to congratulate RECREATION Magazine upon its golden anniversary for its outstanding service to America.

THEODORE P. BANK, *The Athletic Institute, Chicago, Illinois.*

### Resource for Volunteers . . .

Sirs:

May I take this opportunity to say "Happy Birthday" to RECREATION Magazine as it celebrates its fiftieth anniversary! The contribution made through the words printed in your magazine this past half-century has been notable, and we, too, want to wish you continued success!

You will be interested to know that last year our Junior League members filled 5,289 volunteer places in the field of recreation in their 187 communities. They too, have noted needs in the recreation facilities and opportunities for all age groups and have actively participated in programs which rectify these scarcities when they exist. In many instances the National Recreation Association has assisted them in these projects, and in many instances RECREATION Magazine has been used as a fine resource of information for these volunteers.

We join your many friends in wishing you many more half-centuries as a spokesman for the recreation movement!

MRS. MARGARET G. TWYMAN, *Administrator, Association of the Junior Leagues of America, Inc., New York City.*

### An Immeasurable Influence . . .

Sirs:

I would like to take this opportunity to congratulate the National Recreation Association on the celebration of the fiftieth birthday of RECREATION Magazine.

Since its inception, this fine magazine has been a positive force in helping to guide the growing recreation movement. Thus it has had an immeasurable influence on the work of recreation leaders, administrators, students, teachers, social workers, civic-minded citizens, and others interested in recreation.

I hope RECREATION's influence will continue to grow in the years ahead and that the pleasant relationships between the National Recreation Association and our own association will grow stronger as we work together in serving the recreation profession.

CARL A. TROESTER, JR., *Executive Secretary, American Association for Health, Physical Education, and Recreation, Washington, D. C.*

### Of Help to Leaders . . .

Sirs:

Congratulations on the fiftieth birthday of RECREATION Magazine.

The magazine has been of much help to many leaders in the various types of organizations that have a responsibility for recreation. One of the fine features of the magazine has been its broad coverage of activities and the practical suggestions that are made for program activities.

I found the magazine very helpful personally for many years, and hope that it may continue to be such a fine resource in recreation.

JULIAN W. SMITH, *Director, Outdoor Education Project, Michigan State University, East Lansing, Michigan.*

### Happy Birthday . . .

Sirs:

On behalf of the recreation directors of American and Canadian industry, I wish to extend heartiest congratulations to RECREATION on the occasion of its fiftieth anniversary.

Personally, I thank God for RECREATION—it saved the day for me time and time again as a recreation student; it was an invaluable asset in my municipal recreation work; and today our National Industrial Recreation Association recognizes it as the outstanding publication in the field.

Happy Birthday!

DON L. NEER, *Executive Secretary, National Industrial Recreation Association, Chicago, Illinois.*

### When One Ponders . . .

Sirs:

Warm greetings and congratulations on the fiftieth birthday of RECREATION Magazine! May the next half-century of life of the magazine of the recreation movement be characterized by achievements and contributions even more magnificent and helpful than those of the past, and by a growing volume of appreciation and support from an ever broadening range of readers and users.

When one ponders the amount of quality thinking and planning, the imaginative adventuring required of recreation leaders during the next decade or two, he is awed by the bigness of the task. Of course, it would not be such a big task were it not such a vitally important undertaking.

Ten years ago our population was 141,000,000; today it is around 170,000,000; and the estimate is that by 1975 we will be a nation of around 221,000,000 people! Our recreation planners and administrators can get from their educational friends something of a clue as to what is ahead of them. In

spite of all the frantic building of schools in recent years, the crop of youngsters outruns it. It is estimated that in 1965 (only eight short years away), we will have thirty per cent more children of elementary school age, and fifty per cent more children of high school age. We are warned that, *just to catch up*, spending for schools may have to be doubled!

Larger families, more young children, more youth, more older people, more vehicles of transportation, population flowing toward the cities, more leisure time, rising costs, shrinking tax and philanthropic dollars, et cetera, ad infinitum—what posers for recreation leadership! What a challenge and task for the magazine of the recreation movement to help recreation leaders look and plan and dream and adventure ahead!

SHERWOOD GATES, *Director, Office of Community Services, Department of the Air Force, Washington, D. C.*

### A Function and a Mission . . .

Sirs:

We in the Navy have a function and mission similar to the National Recreation Association in that we, too, are providing a program so that each of our personnel will have an opportunity for the best and most satisfying use of his off-duty or leisure time.

May I take this opportunity to thank the National Recreation Association and each of you at headquarters for your personal and official interest in the recreation needs of our personnel. Your cooperation with us in furthering our missions has been outstanding.

We wish for you continued success in your unselfish devotion to the field of recreation. I hope I am around for your diamond jubilee.

E. M. WALLER, *Head, Recreation and Physical Fitness Branch, Special Services Division, Department of the Navy, Washington, D. C.*

### Half a Century of Service . . .

Sirs:

As the National Recreation Association and RECREATION Magazine celebrate their fiftieth anniversary, we cannot say that you have come of age . . . that happened long ago, nor can we think that you have reached the peak, for there is no peak to the work you are doing.

We do look back on your solid half-century of service to the profession and join with you in the good feeling of your accomplishments.

ALFRED B. LAGASSE, *Executive Secretary, American Institute of Park Executives, Inc. and Managing Editor, Parks and Recreation Magazine.*

## Closely Related . . .

Sirs:

The American Camping Association is happy to join with hundreds of other friends, individual readers and organizations, as RECREATION Magazine celebrates its fiftieth birthday.

Because the fields of camping and recreation are so closely related, we know that many of the directors of the more than thirteen thousand organized camps in the country have regularly looked to RECREATION for not only practical program ideas but for those learnings and philosophies that could be adapted to a camp setting.

We feel greatly indebted to RECREA-

TION. Best wishes for a continuing success in an increasingly important area of our American life.

T. R. ALEXANDER, *President, American Camping Association, Bradford Woods, Martinsville, Indiana.*

## A "Must" for Students . . .

Sirs:

The College Recreation Association is indeed proud to convey its congratulations to the National Recreation Association for its outstanding service to the recreation movement through RECREATION Magazine.

Those of us involved in the professional preparation of recreation leaders

are cognizant of the tremendous value RECREATION Magazine has in our educative process. It should be a "must" for all students majoring in recreation. In most colleges and universities, RECREATION is used as an important resource for many of the recreation classes.

We are looking forward to the next fifty years with high hopes that RECREATION will continue "to enlighten" our profession as ably as it has in the past.

THEODORE DEPPE, *President, College Recreation Association, Indiana University, Bloomington, Indiana.*

# Congress-by-the-Sea . . . . .

## The 38th National Recreation Congress

Long Beach, California

September 30 — October 4, 1957

OUR NATIONAL RECREATION CONGRESS will be on the West Coast this year and, at the end of September, delegates from north, south, east and west will be heading for Long Beach, California, land of sunshine, blue ocean, and—movie stars. Glamorous Hollywood, incidentally, is about a forty-minute drive from Long Beach. Watch future issues of RECREATION for things to see and do in this section of California.

## New Congress Secretary

It is with pleasure that the National Recreation Association announces the appointment of Willard B. Stone to its staff, as of April first. Mr. Stone, well known to many in the recreation field for his activities as recreation director for the New York State Youth Commission, will serve as secretary of this year's Congress. He previously has been recreation consultant for the New York State War Council and the New York State Department of Education, and assistant camp director of the Westchester County Recreation Commission. A graduate of Denison and Harvard Universities, he studied also at New York University and taught there and at City College of New York.

As Congress secretary, he will work with the co-sponsoring agencies and Congress program and executive committees in



Registration, exhibits and meetings will be held in the Long Beach Municipal Auditorium (arrow) which looks out over the lovely Pacific—and the sea breezes are expected to cool any heated discussion sessions. Headquarters hotels are nearby.

the planning and management. He will be assisted by John Collier, NRA Pacific Southwest District representative, with headquarters Room 1009, 606 South Hill Street, Los Angeles 14. Mr. Stone can be reached at Association headquarters, 8 West Eighth Street, New York 11.

## Shaping Up

- Exhibit space is being allotted to all sponsoring, cooperating and assisting organizations this year. It is hoped that there also can be educational exhibits from other local cities—if further corridor space is available.
- Special interest program sessions are being planned as suggestions come in. (Send them to the Congress Program Chairman, National Recreation Association.)
- Ideas for speakers at general sessions can be sent to the secretary who will refer them to the proper committees for consideration. ■



# again...

major U.S.A. Basketball  
championships are  
decided on  
**HILLYARD**  
FINISHED FLOORS

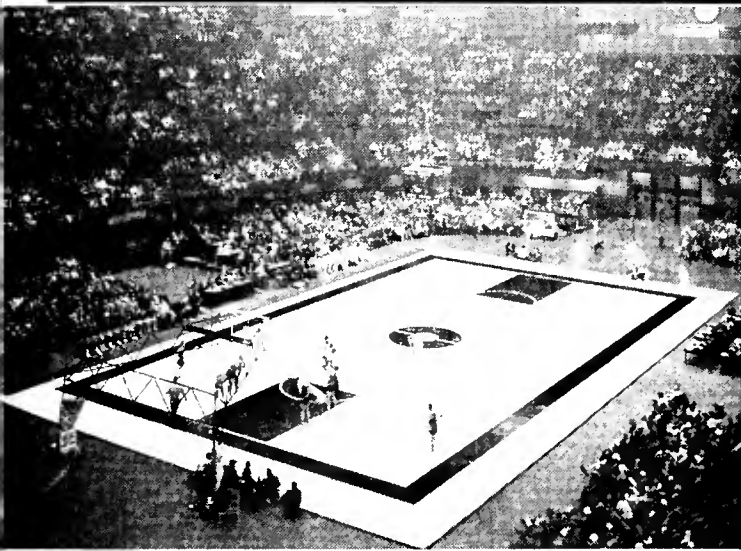

# 1956-57

*and every year since 1952*

**NCAA NATIONAL**

**NAIA NATIONAL**

**NIT NATIONAL**

**U.S.A. OLYMPIC TRYOUT FINALS**

**NCAA EASTERN REGIONALS**

**NCAA WESTERN REGIONALS**

**NCAA FAR WEST REGIONALS**

# HILLYARD



## "finish for champions"

- **LIGHT**, natural, no-glare finish enables players and spectators alike to see all plays clearly (live or televised!)
- **NON-SLIP** underfoot, for faster, safer big-time play.
- **OUTWEARS** any other gym floor finish by more than 2 to 1.
- **SIMPLIFIES** maintenance, slashes maintenance costs.



100 Years of Progress



Best wishes to the members of The American Institute of Architects, Inc. on the occasion of the 100th CENTENNIAL CELEBRATION CONVENTION, Washington, D. C., May 18-22, 1957.



CONSULT AN ARCHITECT • USE QUALITY PRODUCTS

*Mail this Coupon Today!*

**HILLYARD St. Joseph, Mo.**

Please have the local Hillyard "Maintaineer®" show me how easily I can have a TROPHY Championship Floor next season.

Name.....

Institution.....

Address.....

City, State.....



**ST. JOSEPH, MO.** Passaic, N. J.

Dept. P-6

San Jose, Calif.

## The Season of Renewal

RECREATION Magazine reaches its half-century mark, fittingly enough, in the spring of the year—for the months of spring bring renewal of life and promise of things to come. As the showers of yesterday will be the flowers of tomorrow, so the problems and experience of RECREATION's first fifty years are bound to be a strength in the years ahead.

## THOUGHTS OF EASTER



Here, while heaven and earth rejoices,  
Each his Easter tribute bring—  
Work of fingers, chant of voices,  
Like the birds who build and sing.

—Charles Kingsley

✻ An ancient legend tells that where ever the risen Savior walked, white lilies sprang in his footprints. Thus the origin of the Easter lily. The egg symbolizes the rebirth of spring. The cross of flowers is a survival of the days when early Christians, worshipping in secret, drew crosses on the walls of catacombs to testify that the spirit of Christ dwelt there. Because real eggs, originally exchanged at Easter-time, seldom survived unbroken in the mails, the people of Northern Europe, about 1850, began sending pictures of painted eggs. Thus, Easter cards came into being.

## An Easter Greeting

When I was a little tot,  
I liked Easter 'cause it brought:  
An Easter basket gay and bright  
With colored straw which overnight  
Was filled with eggs of ev'ry hue  
And one big chocolate bunny too,  
Who sat so stiff with ears up straight,  
The guardian of his sweet estate.  
And now of all the special seasons,  
I like Easter for these reasons:  
Because it never fails to bring  
The joy that comes with ev'ry Spring,  
A verdant hill once white with snow,  
The daffodil's own golden glow,  
A sense of life, of boundless love  
That's lavished on us from above.  
May that same sense, that joy divine,  
Be also yours this Eastertime!  
HAPPY EASTER!

—Robert E. Kresge, Superintendent of  
Recreation, Charleston, West Virginia.

## A Necessary Utility

"The need for youth centers is usually underestimated by our communities. . . . A good youth center in a community, designed to give youth high interests in their off-hours is the most important organization outside the family. Any community with the interest of its young people truly at heart can much less afford to be without a youth center than it can afford to be without paved streets or a municipal water supply.

"A youth center is in the nature of a necessary public utility which only the municipality can provide."—DR. JOHN A. SCHINDLER in *How to Live 365 Days a Year (Prentice-Hall)*.

## Challenge to the Nation

"The adult, and the youth to a lesser extent, during the fifty-year history of the National Recreation Association has not had the psychological freedom for recreation that the child has had for his play. The reason, of course, is that a work morality has been necessary to help the adult put in long hours of physical and mental labor in order to support himself and his family. . . . One must always have an excuse for merely living, for playing. The thought of a grown man, in the present, having the nerve just to live, just to do things because he wants to—violates all our established American habits. . . .

"Now, however, we are in the midst of tremendous changes in our whole way of life. One of the most far reaching of these is the freeing of most adults from long and arduous labor. This is a necessary first step to developing a philosophy which permits adults to enjoy their leisure time."—JOSEPH PRENDERGAST in an address given at the *NRA Great Lakes District Conference, 1956*.

\* \* \* \*

"The nation faces a tremendous job to convert the increased leisure coming

with automation into an asset instead of a liability."

This contention was voiced recently by Olga Madar, of Detroit, International United Auto Workers recreation director, at a Michigan State University conference. She declared that state and federal governments, communities, labor unions and individual families must place new emphasis upon providing worth-while recreation activities in this era of automation.

More than two hundred and fifty leaders of UAW locals conferred at Kellogg Center on the development of more effective community-wide and union-sponsored recreation programs.

Miss Madar and Douglas Fraser, administrative assistant to UAW President Walter Reuther, pointed out three implications with the coming of automation: more leisure time each day, each week; long vacation periods; earlier retirement.

Union members and all citizens, Miss Madar said, face two challenges in approaching the problem: (1) to study the over-all leisure needs in terms of facilities, leadership, activities, participation; and (2) to look at the costs and be prepared to sell the need for adequate financing for the desired program. To insure that this increased leisure will be an asset and not a liability, we must face squarely the alarming developments of:

- Too much "spectatoritis."
- Children watching too much TV.
- Shortages of parks and facilities.
- Lack of trained recreation leaders.
- The failure of recreation to rate its proper place in city, state and federal government.
- The lack of opportunity for the people to have a real-felt voice in recreational programs.

The two-day conference also featured many workshop sessions on such topics as family camping, gun safety, outdoor recreation programs for retired workers. MSU specialists, state officials and union leaders were utilized as workshop personnel.—HERBERT A. AUER, editor, *Information Services, Continuation Education Service, Michigan State University, East Lansing.* ■

**IDEA BOOK 64 PAGES!**



**ENAMEL-ON-COPPER**

Learn jewelry making; latest enameling processes and techniques from step-by-step illustrated instructions. Book lists many new copper items, complete supplies, tools & equipment. Send for your copy of this valuable reference book today! Rush 25c to:

**THE COPPER SHOP**  
A Div. of Immerman & Sons • Dept. 180  
2185 East 14th • Cleveland 15, Ohio

**CALIFORNIA STATE HOSPITALS**

offer

career opportunities in new Rehabilitation Service Program

for

College Graduates with specialization in Recreation Therapy or Recreation.

- Starting salaries \$4,296
- Fourteen modern facilities
- Attractive employee benefits

Medical Recruitment Unit

**CALIFORNIA STATE PERSONNEL BOARD**

801 Capital Avenue, Sacramento

**DAYTON STEEL RACQUETS**

tennis, badminton, squash and paddle tennis.

*Faster play...longer life.*

For years DAYTON Steel Racquets have been the favorite of professionals and beginners alike. Thousands are now playing an improved game—with more speed and accuracy than ever before.

Daytons are practically indestructible—ideal for schools and playgrounds. Steel strings and tubular steel frames are not affected by climatic changes. No covers or presses are needed to protect them. They won't warp, splinter, rot or sag.

It will pay you to investigate now. See them at your local dealer's or write direct to factory for more information.

**DAYTON RACQUET COMPANY**  
747 Albright St. Arcanum, Ohio

**Dayton STEEL RACQUETS**

**FREE**

Rules and court layouts for badminton or tennis are yours for the asking.

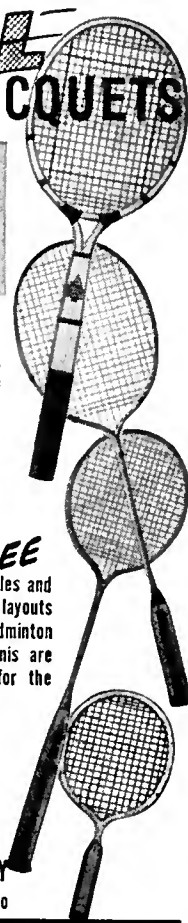

**Colonial Antique Kits**

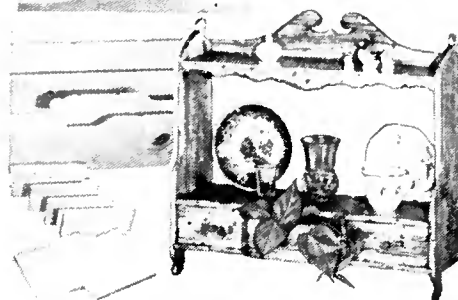

Complete "assemble-it-yourself" kits for making full size reproductions of Colonial Antique Masterpieces!

Everything included...precise pre-cut wood sections with pre-marked nail holes, knife for antiquing, rub-on stain, nails, sandpaper, steel wool, gauze wipe, and simple directions. 6 kits from \$2.95 to \$8.95.

**x-acto**



**FREE!** Full color Brochure of all six X-acto Colonialials.

**X-ACTO, INC.**  
48-99 Van Dam Street  
Lang Island City 1, N. Y.

**EVERYBODY PARTICIPATES IN TRAMPOLINING**

Trampolining is one part of your physical education program in which everyone can participate. Students don't need any special athletic skill to have fun on a Trampoline. And it's a great help in developing coordination and body control. Almost anyone can teach trampolining. By simply sending in the coupon below, Nissen will send you, free of charge, 12 lesson plans.

The Nissen Trampoline Model 77A shown here, is the one recommended for schools. It's big, sturdy — takes a lot of pounding. It's easy to set up — and folds and rolls away for out-of-the-way storage.

Mail the coupon today for more information on the Nissen Trampoline and 12 free lesson plans.

if it isn't a **NISSEN** it isn't a trampoline

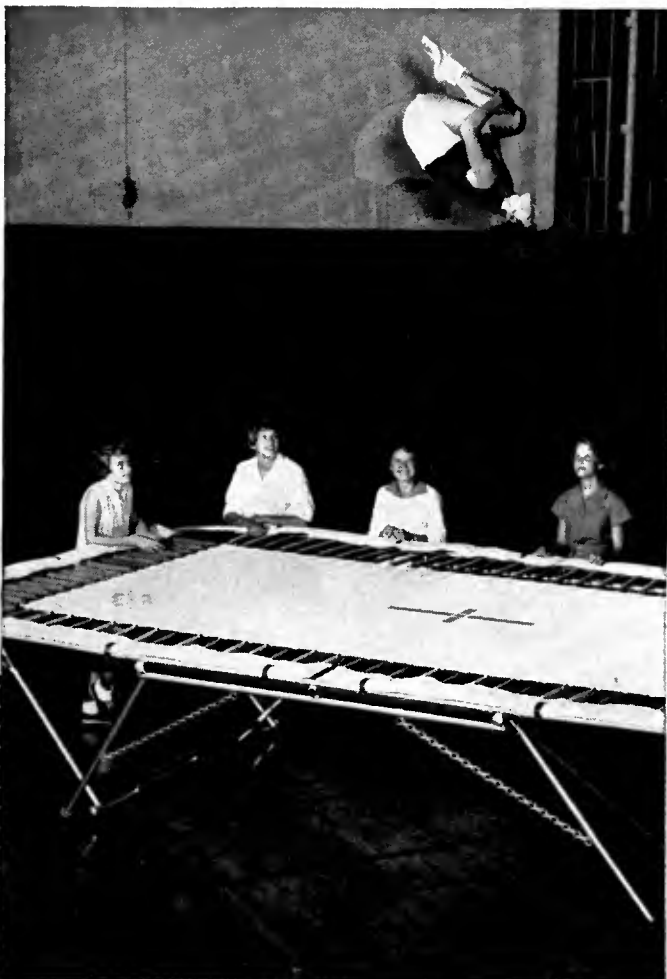

**NISSEN TRAMPOLINE CO.**  
205 A Avenue, N.W., Cedar Rapids, Iowa, U.S.A.

Gentlemen:  
Please send me the 12 free Trampoline lesson plans and further information on the Nissen Trampoline.

NAME OF SCHOOL \_\_\_\_\_

CITY \_\_\_\_\_ ZONE \_\_\_\_\_ STATE \_\_\_\_\_

BY \_\_\_\_\_ TITLE \_\_\_\_\_

NISSEN Trampoline Company  
Cedar Rapids, Iowa

Nissen Trampoline Co., Ltd.  
Hainault Works, London, England



The idea of a child with his dog seems to be of interest to everybody; so the Norfolk, Virginia, playgrounds stage an old standby, a city-wide "Kids' Dog Show."

SINCE THE BEGINNING of the recreation movement, the playground has been the chief center of recreation activity in most communities. Once considered a play area for children only, today the well-developed neighborhood playground attracts people of all ages. The fact that playgrounds under leadership outnumber all other types of centers or facilities—18,224 in 1,956 cities are reported for 1955—attests to their growing importance. In fact, practically every community providing some form of recreation service operates one or more playgrounds. A majority of the playgrounds still are open under leadership during the summer only, but a marked increase is noted over 1950 in the number operated the year round, most of them in the larger cities:

PLAYGROUNDS UNDER LEADERSHIP, 1910-1955 \*

| Year | Total  | Full-Time, Year-Round |
|------|--------|-----------------------|
| 1910 | 1,244  | .....                 |
| 1920 | 4,293  | 807                   |
| 1930 | 7,677  | 1,399                 |
| 1940 | 9,921  | 3,050                 |
| 1950 | 14,747 | 3,790                 |
| 1955 | 18,224 | 5,123                 |

*Yesterday* \*\*

The playground concerns of yesterday, as communicated through the first issue of THE PLAYGROUND, were in many instances the same as those of today:

April 1907

City streets are unsatisfactory playgrounds for children,

\* From 1956 Recreation and Park Yearbook, National Recreation Association. \$2.00.

\*\*Quoted from articles in THE PLAYGROUND, forerunner of today's RECREATION Magazine.

# Playground

because of the danger, because most good games are against the law, because they are too hot in summer, and because in crowded sections of the city they are apt to be schools of crime. . . . In view of these facts, cities should secure available spaces at once, so that they may not need to demolish blocks of buildings in order to make playgrounds, as New York has had to do, at a cost of nearly \$1,000,000 an acre.—THEODORE ROOSEVELT, Washington, D. C.

A fundamental condition for the permanent development of a free people is that they shall in childhood learn to govern themselves. Self-government is to be learned as an experience, rather than taught as a theory. Hence in a permanent democracy, adequate playgrounds for all the children are a necessity.—LUTHER H. GULICK, *President, Playground Association of America.*

November 1907

I first played Prisoners' Base thirty-seven years ago, and the last series of games of it that I have played so far was last summer. I have played the game with three on one side and two on the other, and I have played it with as many as fifteen on a side. I have played it against opponents ranging from the then captain of a university football team to children four years old. I have played it in the city, in the country, and on the beach. I think I may say that I have had at least a long and varied, and I think I may add, an intimate acquaintance with the game; and I believe it to be one of the very best games there are. . . . I think it is an admirable game for all ages and both sexes, and for almost any time of the year. But its special importance is in filling in, for boys and girls who need some good strenu-

Creative dramatics has become part of the regular playground program in Tacoma, Washington. It is one of the activities that tend to stimulate creative play.





# Facts and Fun

ous game for the sake of their moral and intellectual development, those interstices of time that come between the seasons ruled over mightily by the great national games.—JOSEPH LEE.

## July 1910

### THE DAILY PROGRAM

#### *New York Vacation Playground*

- 1:00 to 1:30—Assembly: Marching, Singing, Salute of the Flag, Talk by the Principal.
- 1:30 to 2:30—Organized Games: Kindergarten, Gymnastic.
- 2:30 to 3:00—Organized Free Play.
- 3:00 to 4:00—Drills: Gymnastic, Military.  
Folk Dancing, Apparatus Work.  
Occupation Work: Raffia, Clay Modeling, Scrap Books.
- 4:00 to 4:45—Organized Games: Kindergarten, Gymnastic.
- 4:45 to 5:15—Basketball, Athletics, Good Citizens' Club.
- 5:15 to 5:30—Dismissal: Marching, Singing.

## Today

Trying to find new ways, methods, and activities for a summer playground program is something that ever concerns the alert leader. There are, of course, the standard routine activities of all playground programs—such as crafts, storytelling, sports, quiet and active games, dramatics, music, and others. Presenting these in a new fashion is a goal all of us are striving to attain.

### Playground Midways

In Tacoma, Washington, one year we used this as the

Each of the playgrounds was responsible for one of the booths under the big tent in Tacoma's playground carnival, climax of season's special events program.



Planned fishing derbies are a part of the summer's fun for playgrounders in many communities. Here young fishermen in Peoria, Illinois, admire abundant catch.

theme for the playground summer program. Each week had a title fitting into the above, general theme. The names of the weeks were as follows: Along the Midway: Greatest Show On Earth; Sensational Thrills; Merry-Go-Round; Midway Varieties: Laugh, Clown, Laugh; Splashing Daredevils: Come On and Hear; Fun House Jamboree; and Under the Big Top.

During these weeks, the program of regular routine activities as well as that of special events was planned in keeping with the theme of the week. Leaders were encouraged to use their own initiative and imagination in selecting, and publicizing events.

Frontier Week is a gala event in Jeannette, Pennsylvania. It includes a tepee village and a big powwow. Even the leaders dress up as Indians or as pioneers.





A Detroit playground-on-wheels tours from one congested area to another where play space is limited. Other equipment is set up outside the "Playmobile."

Of course, it was important that all leaders also promote and cooperate thoroughly in other, city-wide events as well; but the program all summer was aimed toward making the final week, "Under the Big Top," a great success. All playgrounds closed at 5:00 P.M. during the final week. A big-top tent was open from 7:00 to 11:00 P.M. Each playground could set up a booth of some kind to earn money for the playground; and these booths could present a demonstration of talent or a display. Each leader worked in close cooperation with the supervisor as to the nature of the booth. All honors, prizes for champions and the like were presented on the final night of the Big Top.

A standard merit system for junior volunteer leaders was set up for all playgrounds. Those children earning the designated number of merits for helping on the grounds were given play money which could be used during the final week at the booths or for rides in the amusement park, through the cooperation of the park.—MARY ANN TRUITT, former supervisor of playgrounds and recreation centers, Tacoma Parks and School Districts.

### Diversify Your Program

All kids aren't athletes, so diversify your program! Children have varying interests. They are basically individualists in the selection of recreation activities; and, if it is expected to serve all youth in the community, the program must include a wide variety of activities. For each activity added to the program additional youngsters can be attracted.—From *Making Playgrounds Succeed*, New York State Youth Commission, Albany, New York.

### The Portable Playground

A gaily decorated playground on wheels solves the need for additional summer recreation facilities for children in Detroit, Michigan. Five days a week, all summer long, the parks and recreation department's "Playmobile" stops twice a day in congested areas where play space is limited.

"The Playmobile is the answer for these kids," declares John J. Considine, superintendent of the department. "There's just no other way for them to get a chance to play."

It is used by the sixty thousand children who live in the seventeen-square mile area inside Grand Boulevard for summer fun near their home. At each location, the driver rings a large bell to signal the children, but this is merely a formality for usually about two hundred of them are already waiting.

The roving playground was purchased by the Detroit Lions Club and presented to the parks and recreation department in 1951. It is a tractor-drawn trailer that, when its sides are up, can be hauled from street to street. When its sides are open, it spews forth all sorts of wonderful playground equipment—sliding board, basketball hoops, volleyball standards, teeter-totters, tables, sandbox, swings and smaller playthings, such as jumping ropes, horseshoes, and so on. Only the swings and sandbox are fixed to the trailer; the other equipment is set up outside.

Under the direction of trained leaders the children enjoy two and a half hours of recreation. The climax of their play period comes when the supervisors open the nearest fire hydrant for a street shower.

The vehicle covers ten locations, setting up at two of them each day. It arrives at the same location once a week, always at the same time and on the same day.

### An Old Standby

The idea of a child and his dog always seems to interest people everywhere; so for the past two years the Norfolk, Virginia, Recreation Bureau has started its summer playground city-wide activities program with a highly successful special event, a Kids Dog Show.

Staged in cooperation with the Ken-L-Ration Company, the bureau first holds preliminary dog shows at each individual playground in various neighborhoods throughout the city. Youngsters between the ages of six through fourteen enter their canine charges to compete for ribbons in eight classes. The dogs need not be pedigreed, and many fine mongrels walk away with prizes.

The eight classifications are as follows: best costumed dog, best cared for dog owned by a boy, best cared for dog owned by a girl, largest dog, smallest dog, dog with the shortest tail, and best trick dog. Playground leaders have found that many teen-agers take a genuine interest and make excellent judges or are a big help in registering the dogs. Each young owner receives from the Ken-L-Ration Company a dog booklet, a balloon and a lollypop. Four ribbons are awarded in each classification.

Blue-ribbon winners in all eight classifications from each playground are then eligible to compete in the two final grand shows usually held on the following night at one of our larger parks. Organization of these final events is similar to that of the large professional dog shows. Judges have been veterinarians, S.P.C.A. members, or other adults who love dogs and are keenly aware of the feeling children have for their pets.

Preceding the show the Hampton Roads Obedience Training Club puts on an exhibition—to show that trained dogs make better companions—which serves as an inspiration for young dog owners.—YOLANDA GRANT, playground leader, Norfolk, Virginia. ■

# Burke

BETTER-BUILT EQUIPMENT

... for  
PLAYGROUND, RECREATION, SPORTS  
... tops in  
Quality • Safety • Service

Heavy-duty Playground  
Equipment . . . and Park  
Benches • Picnic Tables •  
Portable Prefabricated All-  
Steel Platforms and Bleachers  
• Bicycle Racks • Offset Bas-  
ketball Backstops . . . and  
other recreational and sports  
equipment.

Use the Burke personalized  
planning and advisory service  
at no cost or obligation.  
Write for complete infor-  
mation about products and  
name of nearest dealer.

THE J. E. BURKE COMPANY  
NEW BRUNSWICK • N. J.  
FOND du LAC • WIS.

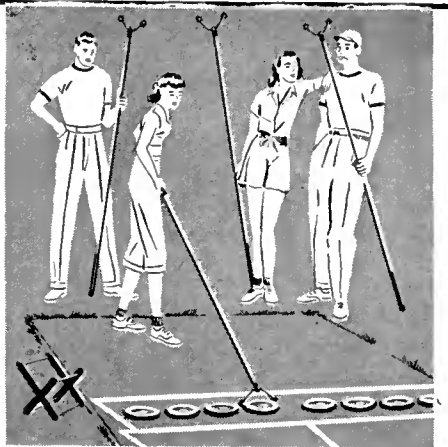

## Shuffleboard Fun For Everyone!

From 8 to 80 here is exciting recreation for all ages . . . keen enjoyment for players and spectators.

Rugged, Dimco FreeGlide Shuffleboard sets are available for both outdoor and indoor installation.

Easy to install . . . low in upkeep!

Write today for colorful folder, "Let's Play Shuffleboard," containing complete information on court layout and equipment.

**DIMCO-GRAY COMPANY**  
205 EAST SIXTH STREET  
DAYTON 2, OHIO

## New Table Tennis Tables

100% Aluminum  
EXTRA HEAVY DUTY

ESPECIALLY DESIGNED FOR HEAVY DUTY USE  
Indoors or Outdoors

Official Regulation SIZE and BALL BOUNCE

MADE IN 2 SECTIONS 4 LEGS TO EACH SECTION

Nationally recognized and used by the ARMED FORCES, COLLEGES, MUNICIPALITIES, RECREATION CENTERS, SCHOOLS, CLUBS, PARKS, etc.

- No Maintenance or Replacement Problems.
- Sturdy Lifetime Construction.
- Heavy Duty Anodized Aluminum throughout.
- SECURELY INSTALLED HEAVY GAUGE ALUMINUM CENTER NET—ALSO AVAILABLE.

For FULL DETAILS WRITE **ALL METAL TENNIS TABLE CO.**  
P. O. BOX 142, TEANECK, N. J.

# New York University School of Education

Leadership Education  
in  
Recreation and Camping

Courses lead to B.S., M.A., Ph.D.,  
and Ed.D. Degree

At Washington Square

Interession—June 3 - 28  
Summer Session—July 1 - August 9  
Post Session—August 12 - September 6

At Lake Sebago Camp

Interession—June 1 - 20  
Courses for Undergraduate  
Men and Women  
Summer Session—July 1 - August 9  
Courses for Graduate Students

Write for further information to:

DR. MILTON A. GABRIELSEN  
School of Education  
New York University  
WASHINGTON SQUARE  
NEW YORK 3, NEW YORK

## HONOR YOUR PARTNER

# Instructional Records

GUARANTEED NOT TO BREAK  
CHIP OR CRACK

Couple Dances  
Rhythms  
Square Dances  
Play-Party  
Singing-Games  
Folk Dances

Ed Durlacher's "Talk-Through; Walk-Through" System of Simplified Progressive Instruction, followed by the Complete Dance.

**SQUARE DANCE ASSOCIATES**  
P.O. Box 644, Freeport, N. Y.

Mail coupon for FREE brochure on all Honor Your Partner Teaching Aids  
**SQUARE DANCE ASSOCIATES** P.O. Box 644, Freeport, N. Y.

Gentlemen: Please send me free brochure of Honor Your Partner Teaching Aids,

Name \_\_\_\_\_  
Address \_\_\_\_\_  
City \_\_\_\_\_ Zone \_\_\_\_\_ State \_\_\_\_\_

# The Playground *for Mentally Handicapped Children*

Harold W. Perry

**T**HIRTY-FIVE CHILDREN—aged from seven to nineteen with mental ages varying from approximately three and a half to eight years—participated when, on June 25, 1956, the recreation department of the Memphis Park Commission sponsored its first park recreation program for mentally handicapped children. The children represented the various types of mental retardation found in the day school programs for trainable severely mentally handicapped children.

Two attendants for the playground were employed by the department for this special program, one a regular classroom teacher in the local city school system, assigned to the severely mentally retarded program. In addition, two sixteen-year-old boys, both in advanced educable mentally handicapped groups in the city schools, were engaged as assistants to the attendants. The author served as an advisor and consultant.

The physical facilities of the Lenox Elementary School, a local public school, was chosen, largely because it was located near the center of the city and a portion of the playground was adequately fenced. Also, a large auditorium with removable seats was available, with toilet facilities adjoining it.

The playground was operated three days per week—Monday, Wednesday, and Thursday, from 1:00 to 4:00 P.M. for a total of twenty-seven days of operation. These hours worked very well as they gave parents opportunity to give their children their noon meal before arriving at the playground and to pick them up from the playground before the evening traffic rush.

Prior to the actual opening on June 25, a tentative program included crafts, games, folk dancing, rhythm

band, group singing. As was to be expected, the program was under constant evaluation and revision as the apparent need and demand arose.

The first session was devoted to familiarizing children and parents with the proposed program and available physical facilities. Following a period of orientation, during which an attempt was made to determine each child's needs and abilities, the children were grouped for the various activities. The hyperactive children were assigned to those where only a minimum of stimulation was provided in accordance with the children's perceptual and emotional limitations; while an attempt was made to provide an abundance of stimulation and motivation for the others.

All conceivable athletic equipment was issued to the playground and we tried to utilize each piece of equipment. Physical activities that require gross coordination met with more success than those calling for a more minute or intricate dexteriousness. These, such as "playing catch" with a volleyball or basketball, box hockey, and a somewhat modified version of softball were well received and beneficial to many of the children. One child, a girl of fourteen, who was both mentally and physically handicapped and who could not stand without the aid of crutches, learned to catch a basketball although seated in a chair. This learning situation not only improved her eye-hand coordination, but gave her a definite sense of accomplishment and self-confidence.

Craft activities were many and somewhat varied, as an attempt was made to provide the children with every opportunity to develop not only a leisure-time activity or activities, but to increase their ability to follow directions, to improve coordination and self-confidence, and, most of all, the ability to work together in groups of various sizes. Such activities as simple weaving, working with plaster of Paris, spatter painting, as well as opportunity to work

with finger paint, water paint, crayons, and clay, were provided.

One of the local civic organizations provided milk daily for the children, as well as cots for those of low vitality who needed to lie down and rest during the recreation period.

At the summer's end, an "open house" was held, during which the children's craft projects were displayed, the children presented for parents and friends a program of group singing, rhythm band playing, and several individual performances, and awards were given for perfect attendance, good sportsmanship, good conduct, and best all around playground participation.

Without a doubt, the playground was a success, if only for the above reasons—but it also afforded parents, especially mothers, a "break," and gave them an opportunity to see what their children were capable of accomplishing in a controlled environment.

The plan for the summer of 1957 is to continue this program, increasing it from three to four days a week, with perhaps an increase in the number of hours (from three to four) per day. It is felt that it will be expedient to continue to use advanced educable mentally handicapped youngsters as assistants to the playground attendants, in the event that additional playgrounds of like nature are established in the near future. In this case, these youngsters would be most beneficial to the successful operation of the playground in many respects, as they served very well in all ways last summer.

Perhaps the most gratifying factor was that more people not only are becoming interested in, but actually are attempting to provide services for, mentally handicapped children. This was evident in the sincere interest, cooperation and enthusiasm demonstrated by the superintendent of the Memphis Recreation Department, Marion Hale, and his entire staff. ■

---

MR. PERRY is supervisor of exceptional children for the Board of Education, Memphis, Tennessee.



# The Influence of Rural Environment on CHILDREN

•  
Anne S. Hoppock

**Much in this article should be of significance to the recreation leader.**

**T**WO CHILDREN I know illustrate the first point I want to make in discussing the impact of rural environment on children. These two ten-year-old girls are cousins. Their families live in neighboring farm houses. The fathers rent their fields to nearby farmers and make a living as mechanics. A garden, a cow, and hens add to the family resources. Both sets of parents are high school graduates. They live fairly comfortably but with few luxuries. They spend a good bit of time together. The children walk a mile to the little school in the village.

Jane lives zestfully. She has a dog which she cares for faithfully, and with it roams the countryside. She is writing a book and consults gravely regarding her writing problems with a young teacher who lives in the neighborhood. She is intensely interested in plant and animal life and has a number of collections including several live items. She collects rocks and Indian artifacts. She is an inveterate researcher into the meanings of her out-of-door experience. In pursuing her various interests, she exhausts available printed material at home and school, asks questions of everyone who might have information, and writes to the county agricultural agency. Jane swims, picnics, and sings in the children's choir in the church.

---

*Condensed and reprinted with permission from Rural Education—A Forward Look, Yearbook 1955, National Education Association. MISS HOPPOCK is assistant in elementary education, New Jersey State Department of Education.*

Jane's cousin Carol, also ten, is quite different in her interests and her approach to living. She is an avid comic book reader. She is interested in clothing and is beginning to experiment with cosmetics. She makes half-hearted attempts to keep up with Jane's pace, but seldom follows through on projects they start cooperatively. She evidences little curiosity. She putters around the house, spends more time indoors than she does out.

It is dangerous to generalize about the influence of the rural environment on child development. Jane and Carol seemingly live in the same rural environment, go to the same school, roam the same fields and woods and streams under the same sky. But even this superficial description indicates the two children are learning different values and interests. Their lives are taking different directions. I cannot accurately account for this since I have not studied the children intensively.

This we do know, however. The appropriations a country child makes from the experiences available in his environment and how these appropriations affect his growth and development depend upon several factors. One of these is innate capacity. Another is his family—its climate and relationships, its values and attitudes, its guidance and example. Another is his physical status and condition, how much energy he has to give to the business of living.

A second reason why it is impossible to generalize regarding the influence of the rural environment on child development is because not only do individual

children and their families differ but so do rural environments.

I would like to point up two somewhat common characteristics of rural environments and raise questions regarding the potential effects, positive and negative, on children:

*First, we can assume that rural children have unique opportunities for responsible participation in the enterprises of family living. How can we assess the effects of these on development?*

A child's responsibilities may vary, from none at all to care of pets and young children, domestic work, weeding the garden, carrying wood, doing chores around the barn, possibly even helping in the planting, cultivating, and harvesting of crops.

We have to ask about any child: Does he work too hard and too long for his physical well-being? Many rural children do. Does work deprive him of time for other experiences essential to wholesome development? Does he have a share in planning and choosing his work and can he use some ingenuity in carrying it out? Or does he do the same jobs over and over, following adult directions, until he is little better than a puppet? What is the family climate in which he works?

*Second, what is the effect on growth and development of the country child's closeness to nature and natural phenomena?*

The freedom of most rural children to range widely in the out-of-doors makes available many vigorous physical activities. The best nursery schools

and kindergartens would be hard put to duplicate the opportunities for running and climbing, jumping and crawling and throwing, for "messaging around" with natural materials such as sand, mud, water, and snow. Depending upon the locality, there are opportunities for swimming, fishing, hiking, camping, skiing, coasting, and adventurous exploring. It may be assumed that these vigorous, happy pursuits contribute to physical and emotional development.

Rural educators point out, too, that rural children's closeness to nature makes available to them vivid first-hand experiences which may contribute to emotional stability and acquisition of spiritual values.

In his explorations of his environment, the rural child is at best very much in tune with his universe. He may be grubby and tousled of hair but he has distance in his eyes, wings on his feet, and stardust in his hair.

Dr. Fannie Dunn, in her book, *The Child in the Rural Environment*, describes the scientific and aesthetic experiences of a young rural child in one kind of natural setting. These excerpts show him busy absorbing with eyes and nose and ears and hands—indeed with his whole self:

"Springtime brings sheets of purple violets for a child to pick as much as

his hands can hold. Golden buttercups held under his chin reveal if he likes butter. . . . Catkins on the alders and aspens scatter clouds of pollen when the wind tosses them. Honeybees and bumblebees buzz from blossom to blossom with big balls of pollen on their legs. Apple, cherry, peach and plum blossoms scatter and the newly formed fruit can be seen at their base. . . ."

And later in her description: "He wades in clear tumbling brooks, picks his way through swampy meadows to gather wild iris, fishes for minnows along winding streams, skates or sails his homemade boats on shallow ponds, or rides in rowboats on lakes or rivers. He climbs hills and descends into valleys in search of wild flowers, berries, or nuts. . . . He gathers rocks which attract him because of the sparkle of mica, the shining streaks of quartz or the red of iron. . . . There may be clean white sand for his handling or some malleable clay or blue marl full of shell fossils."

How can we say what it means to the development of a child to live in the open country where there is space to roam and active, fascinating exploring of the natural world to do? It is a temptation to assume that the potential values are realized, but experience tells us that this is not necessarily so.

Lack of time is not the only reason

why some country children cannot benefit from happy experiences in the out-of-doors. It is unhappily true that some country children do not have the skills and the awareness to enjoy these pursuits. One has only to drive through the countryside on a Sunday afternoon to see children alone or in small groups, just "hanging around," bored, lonely.

I know well an area where vegetables are grown in the rich, black muckland. It was formed when the glacier dammed a small river. The fossil remains of a mastodon was found in it. The fields are rimmed with high blue hills, fun to climb, where the fire-marked rocks of Indian rock shelters may be found. . . . This is an environment rich in aesthetic, scientific, and historical meanings, but the children's interactions with it were pitifully limited when I first knew them—limited by too much work in the fields, by barren homes, by lack of adult guidance which would help to lift their lives above the dull level of existence.

Whether a child sees or is blind to the marvels about him, whether he hears or is deaf to its deep meanings, whether his curiosity is deadened by frustration or remains a voice that impels him to keep looking beneath the surface of things—*these depend to a great extent on the adults who influence his life.* ■

## *The Weeping Willow* -----

**A sixteen-year-old girl sees the "country becoming a city."**

I live in the country. I am only a child and I love the country. I love its coziness. The soft snow makes the troubled, uneven grounds one; the icy cold makes the turbulent, uneasy streams one. All the country sleeps together while it has beautiful dreams of children enjoying its blanket.

I love the smells of the country. The crisp smell of the leaves in autumn burning; the biting smell of the winter air. And the smells of spring! The air that makes you yell, "Good Morning!" to the world and empowers you to awaken the world.

I love the country. I can roll down and around its grassy hillside; I can glide over its ground in winter, and leap over it in the spring; I can climb its trees, which are bridges to the sky. I am the country because I'm free.

But the city isn't free. People are tight machines. They are restricted by the clock. They are always rushing, but they never leap. They can't leap because they wear tight suits, so tight they can't bend down and become insignificant, letting nature envelop them.

I have a weeping willow tree by my house, and a babbling brook beside it. I sit under the branches of the weeping willow tree, and become lost in its foliage so that no one can tell I'm there, thinking, and throwing pebbles into the brook, watching the never-ending circles.

I wish the country would be here forever, but I know it will not. I have seen the soft, dirt paths being torn up and concrete highways built in their stead. All the unevenness of the path is taken out so the new roads will be smooth routes on which to travel. But all the rolling, gliding and leaping countryside is taken away too; and there is rushing traffic; and the country becomes a city. I'm afraid for this to happen, but my mother tells me not to fear. She tells me that the city is beautiful, that it can be more beautiful than the country. She tells me that you can stretch in the city; that you can expand in so many more ways; that the constant building is the bridge to the sky. The skyscrapers are the tallest weeping willows in the world. Then, I guess I won't need my weeping willow tree, but I will always hold it in my memory. And not forget. Many adults do.—JANE GITELMAN, *Merrick, New York.* ■

# A Town Meeting with Delinquents

Robert L. Smith

**M**EMBERS of the planning committee for the Oakland (California) Town Meeting wanted their meeting on delinquency to be different. They felt that in too many such meetings only the attitudes, ideas, and opinions of "good boys and girls" are presented.

On February 27, 1956, therefore, the California Youth Authority, in cooperation with the Alameda County Probation Department, selected a panel of four delinquents to discuss delinquency and the problems facing Oakland youth. The group consisted of two Anglo-Saxon youths, one fourteen and one sixteen; a nineteen-year-old Negro boy; and a nineteen-year-old boy of Greek-Spanish extraction. Two were parolees under the supervision of the California Youth Authority, and two were being supervised by the Alameda County Probation Department. The offenses which had brought these young men into conflict with society ranged from battery to auto theft.

The session was tape recorded; but the fidelity of the recording, when completed, was not sufficiently high to permit reproduction of the discussions. In an effort to utilize material that appeared interesting and important, excerpts were taken from this recording for future training uses. In preparing the training material, direct quotes were used. A few of these follow:

*Moderator:* What about public recreation provided by the city? Do boys in trouble avoid these kinds of places?

*Pete:* No. When I was a kid I used to box at St. Mary's, but they closed down the club. I didn't have anything I wanted to do, so I used to go down to the English Pie Shop to steal pies. One of the times we went down, we accidentally got into the men's locker room and decided since we were there, we would take the wallets and money in the pants hanging around the room. We didn't go there to steal the money, but because of our accidentally getting into this room, we did steal it. . . . I think if kids had jobs to earn money, it would keep a lot of them out of trouble.

*Dick:* One of the things that takes lots of money for a boy, if he's fifteen or sixteen and has a car—well, he has to have money for gasoline and money to take his girl out. If the parents are in debt—they would like to be able to

give the boy money but they aren't able to. If you have no job, you don't know where to turn—you may get money by stealing. You don't have to steal but it is pretty hard to do without things that other kids have.

*Norman:* In the summertime, there aren't always too many things to do and when it rains there aren't too many things to do at public recreation places. You can't play outside and if you play inside you have to wait your turn to play Ping-pong or pool. Maybe you would have to wait an hour or two hours to get your turn. Kids need more programs in the wintertime.

*Moderator:* I would like to review what ideas I think I have heard thus far. The idea of a job, a source of income to let young people do some of the things they would like to do, is important to young men. Norman mentioned better recreation during the winter, when it was raining and there weren't too many things to do elsewhere. He expressed the desire for a greater variety of activities. Do you have any other ideas about what might get kids into trouble?

*Joe:* I think the reason some kids don't get into trouble is that they have hobbies, they have something to do, they have a responsibility, they have a good home, and they are interested in their neighbors and their community and people like them and they are a part of the community.

*Joe:* Churches and adults think they understand what kids want but actually they don't.

*Norman:* The recreation facilities have to be fixed up and they need someone around to help you out and to teach you the rules for the games.

*Moderator:* You would speak for more facilities for youth on weekends when schools are closed. You also ask the recreation people for more people to help you with the recreation programs.

*Dick:* In our neighborhood we used to go to the neighborhood movie on Friday nights, and all the kids used to just know to be there on Friday nights. But they closed down the theater and it is a long way downtown, so some of us got into trouble because we started hanging around on the streets, after our movie closed down.

(NOTE: Here Dick seemed to be pointing out the importance of community recreation at the neighborhood level and emphasizing the fact that the simple act of closing down a neighborhood theater may result in increased delinquency for that neighborhood.)

*Pete:* I think where neighborhoods are bad, they are just bad. In the bad parts of town there just isn't any recreation that is good. It is too far to go to parks or recreation centers that are out of these areas.

(NOTE: Here Pete seemed to draw a much narrower picture of what constitutes a neighborhood for a youngster as compared with the neighborhoods defined by civic organizations.)

I think that recreation people should ask the kids more about what kind of recreation they want and there should be a greater variety. I think they should build up little centers for the mothers and fathers. Parents can cause delinquency, and they need help like kids in trouble. They need to be taught how to deal with kids and how to help them. ■ osoil ®

*Condensed and reprinted with permission from Youth Authority Quarterly, Sacramento, California. MR. SMITH is a field representative for the Division of Field Services, California Youth Authority.*

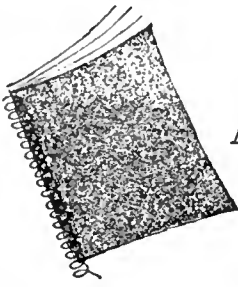

## A REPORTER'S NOTEBOOK

### People in the News

JAMES E. MADISON, NRA field representative, is now in Europe for a two month period of service with the United States Air Force. He will visit bases in Germany, France, England, Morocco, Libya, Turkey, Greece, Italy and Spain, for the purpose of assisting with the improvement of organizations, management and operation of facilities and personnel.

Following this assignment, Mr. Madison will take a three-month leave of absence from the Association to serve as a recreation specialist in Pakistan under the International Educational Exchange Service of the U. S. State Department.

L. C. WILSEY retired as director of recreation of the Essex County, New Jersey, Park Commission on April 1. He is succeeded by Harold J. Van Cott.

JAMES C. DITTMAR, recreation director in Williamsport, Pennsylvania, was named one of the city's two outstanding "Young Men of 1956" by the local Junior Chamber of Commerce. He was cited for his work in developing

new neighborhood playground associations, additional ice-skating facilities, stimulating planning for municipal swimming, furthering the development of the city-owned golf course, organizing and promoting a golden-age club. His twin brother, John, is recreation director in State College, Pennsylvania.

OLGA M. MADAR, recreation director of the United Auto Workers since 1948, is the first woman to be appointed to the seven-member board of commissioners of the Huron-Clinton Metropolitan Authority, Michigan. The authority is responsible for recreation programs and areas in the five counties surrounding Detroit.

MARION HALE, superintendent of recreation in Memphis, Tennessee, won the 1956 Newspaper Guild of Memphis Citizenship Award. He was chosen for his "record of continuous effort to improve recreation facilities for children and adults." He became superintendent of recreation in 1949, and since that time the total of Memphis playgrounds has risen from twenty-nine to seventy-nine. He joined the recreation department as a basketball referee after school at twenty-five cents an hour.

JOSEPHINE D. RANDALL, former superintendent of recreation in San Francisco, California, has started a year's tour of Europe as goodwill ambassador representing the California Recreation Society. Before her departure she attended the twentieth anniversary of the Josephine D. Randall Junior Museum which she helped establish February 13, 1937.

LAWRENCE P. (PETE) MOSER, executive director of the recreation department in Kalamazoo, Michigan, has been elected president of the Babe Ruth League youth baseball program for 1957. Some 75,000 boys participated in Babe Ruth baseball in 1956.

### "To Talk, Hover and Poke"

An eight-month festival, from April through November, marks the 350th anniversary of the founding of Jamestown, Virginia, by a small band of English colonists on May 13, 1607. Festival focus point will be the state's new \$1,500,000 Jamestown Festival Park.

The festival will mark not only a milestone in the history of Jamestown and America but also a milestone in the history of RECREATION Magazine, for in its very first issue, April 1907, it noted plans for a playground exhibition at the Jamestown Exposition of that year, sponsored by the Playground Association of America (now the National Recreation Association). This exhibition, directed by Howard Bradstreet, was divided into two parts, indoor and outdoor.

The indoor exhibit was in the "Social Economy Building," Jamestown being "the first exposition to devote an entire building to the work of the finer, less material side of the world's activities grouped under the head 'Social Economy.'" In addition to photographs and examples of playground equipment and crafts, this indoor show contained a model of a playground in operation, illustrating possibilities of inexpensive equipment, which made people, "talk, hover and poke." The outdoor section consisted of an actual playground with apparatus, mainly of a type similar to gymnasium equipment.

In 1936, Jamestown Island and the ruins of the ancient "cittie" became part of the 7,229-acre Colonial National Historical Park along with historic Yorktown. Between Yorktown and Jamestown lies Rockefeller-restored Williamsburg, where the capital of the colony was moved from Jamestown in 1699. For the first time, all three of these sites are linked by the scenic, limited-access Colonial Parkway, recently completed by the Park Service.

### New Waterland

An extensive tri-state recreation and sports area has become available for public use with the completion of the mile-long, \$64,000,000, Jim Woodruff Dam at Chattahoochee, Florida. On the Georgia-Florida boundary, not far from the southwest tip of Alabama, the dam





## LET'S ALL PLAY BALL WEEK

April 6-13



and its big reservoir will provide a new water area of 37,000 acres and shoreline of 243 miles. State, county and municipal agencies in the three states, as well as the federal government, are developing park and recreation areas around the dam site, at the junction of the Chattahoochee and Flint Rivers, which meet to form the Apalachicola River.

Areas now licensed or planned for public use total some three thousand acres, of which 1,250 are being developed by state agencies, 1,300 by counties and 450 by municipalities.

### Salute to Youth

New York City held its first "Salute to Youth Week" in March to focus attention on the fact that "the overwhelming majority of youth in New York City are decent law-abiding citizens making valuable contributions to the general welfare of the community." In connection with the observance, "Youth Credo" pledges were circulated among public and parochial school teen-age pupils, affirming the students' commitment to the ideals of good citizenship and behavior for youth week "and the whole year through."

Six hundred "Certificates of Merit," signed by Mayor Robert Wagner, were awarded to teen-agers who were leaders of outstanding projects for the bene-



fit of their schools and the community. Bronze medals went to thirty students for exceptional school-community contributions.

### Softball Recommendations

A survey on youth softball conducted by the Junior Softball Committee of the Amateur Softball Association resulted in a number of recommendations adopted by the Association at its annual meeting in Mesa, Arizona, earlier this year. It also adopted a complete set of rules for slow-pitch softball and accepted a complete recodification of official softball rules, effective for the 1958 season.

For the coming year the ASA recommends that youth softball teams be formed using the following age-group classifications: nine to twelve, thirteen to fifteen and sixteen to eighteen years of age. For tournament play the ASA program for boys and girls will include city-wide tournaments (age-groups: nine to twelve, thirteen to fifteen, sixteen to eighteen), county-wide tournaments (age-groups: thirteen to fifteen and sixteen to eighteen), with state competition in the sixteen to eighteen group only. No area or national competition will be sanctioned.

Diamond specifications recommended were forty-five foot baselines and thirty-five foot pitching distance for the nine to twelve age-group and regular softball baseline (sixty feet) and pitching distance (forty-six feet) for the older groups. No changes in present regulation equipment were made.

A national slow-pitch softball tournament will be held in Toledo, Ohio, in September. The game is very popular with persons over twenty-five and is growing rapidly in business and industrial concerns, recreation leagues and independent leagues here and abroad.

### Fairway in the Desert

In Nevada, sage and sand have given way to the lush fairways of an eighteen-hole golf course because residents of two small desert towns and servicemen stationed nearby combined their money and energy to begin the course. The project involves residents of Babbitt (2,464) and Hawthorne (1,861) and servicemen stationed at Babbitt Naval Ammunition Depot. The needed water

comes from Walker Lake, an artificial dam and reservoir adjacent to the course.

### Three Thousand a Day

A recent appropriation of \$500,000 from the Ford Foundation will enable the National Committee on the Aging to set up an information and consultation service to assist organizations and community groups "engaging in or wishing to provide or expand services to older people in such fields as employment, housing, health and recreation." G. Warfield Hobbs, committee chairman, points out, "The increase of approximately three thousand persons every day in the group aged sixty-five and over in our country presents a new challenge to American social and economic policy." This is the first grant the Ford Foundation has made for service to senior citizens.

The National Committee on the Aging is holding its 1957 spring meeting in Detroit, April 17 and 18. The meeting's over-all subject is "Older people and the Industrial Community."

### Danger Spots

One of the "principal danger spots" for senior citizens is the lack of adequate community programs and services for them, according to B'nai B'rith, a major American Jewish organization. At a recent meeting in New York City, Philip M. Klutznick, president of B'nai B'rith, urged "cooperative action" by federal and local government and community organizations "to ameliorate the threats to our aged and aging population."

### 1956 Playground Issues

The 1956 RECREATION Magazine Playground Issue is still available. Order copies you want immediately—fifty cents a copy.

APRIL IS



USO



MONTH





Winning entry was towed to the field by a truck but was pulled in parade by twenty youngsters. It showed various activities.

# Playgrounds

A story in which one program is used to stimulate interest in another.

**M**ORE THAN ONE THOUSAND children marched in the latest Louisville, Kentucky, Playgrounds on Parade program—one answer to the problem of getting everyone interested in summer projects that may have become routine through annual use.

The general program supervisor for the city division of recreation, Mrs. Vivian Collins, began the Louisville parade to obtain maximum interest in the city-wide playground track and field meet which is a traditional part of its summer program. Interest in the meet itself has always been high enough to attract a lot of entrants each year. However, spectator attendance and interest on the part of non-competing children was often spotty before the parade idea was started.

The first parade was held in 1955, and the lessons learned from that experience paid off in nearly one hundred per cent participation in 1956. "Playgrounds on Parade has boosted attendance and participation," Mrs. Collins says, "and interested many children in athletics for the first time. It also gave each child who helped with the floats a sense of accomplishment."

What is the Playgrounds on Parade? It is an old-fashioned, fancy-float parade strictly for children on the playgrounds. They make all of the floats, and thus receive valuable handcraft experience. Those who participate in the track meet get a lift from having a rooting section and a colorful float from their playground supporting them. Non-competing children come to parade, then stay to watch the track meet. Playground leaders report a sharp increase in interest in track and field activities during the weeks that follow.

## How It Was Done

At a playground leader staff meeting six weeks before

MR. MEEHAN is publicity supervisor for the Louisville Division of Recreation and is a senior at the University of Louisville.

the event, the parade-track meet was discussed. The event was already outlined in a staff manual given each playground worker at the beginning of the summer season.

Very few restrictions were placed upon type of floats that could be entered, in order to give playground workers and children a chance to use their imaginations. The main idea was to stimulate a pageant spirit, to promote interest in the event among the children—and the workers.

The only strict rule was that the floats entered in the parade had to be pulled by hand, by children from the playground entering the float. This many-little-hands-pulling policy kept the size of the floats within reasonable limits.

It was also suggested that members of each playground's track team follow the float in the parade. This gave a big-time, near-Olympic flavor to the event and the children seemed to feel the whole thing was something special.

After the initial staff meeting announcement, recreation supervisors touring the city's playgrounds continually mentioned the program and offered help. Some of the ideas worked out made float building seem like a pretty simple task after all.

One supervisor suggested, and tested successfully, the idea of joining two bicycles together with two-by-fours and U-bolts. In this way a light platform could be built onto two bicycles for an effective float base. Other suggestions adopted included pushcart float beds and light auto trailers for float beds. Still other floats were made with odd sets of wagon wheels and scrap lumber.

Workers found that getting the base of a float is the most difficult part of the job. Once a base is built, chicken wire, scrap wood, cardboard, paper napkins, tissue paper and other odds and ends can be used for the "show part" of the float. Some float-building ideas were obtained from the recreation library and the public library.

With everybody working, the parade idea caught on so well that fifty-three of Louisville's sixty playgrounds entered floats. The seven playgrounds not represented with floats

# on Parade

John Meehan



A young Chinese-American girl served as the inspiration for one of the colorful floats which was transported rickshaw style.

were smaller playgrounds; but even they got into the act with groups marching in home-made costumes.

Parents of the playground children also caught the float fever, and helped to secure wood, chicken wire, paper and other items that could not be provided from city stocks. They also provided transportation for many children to the parade site and helped interest other adults in the projects.

Only children and playground leaders actually worked on the floats. Parent participation was diplomatically channeled to prevent the parade from becoming a "show-off" race between adult groups in different neighborhoods.

Adult-child interest was shown on track meet day when over one thousand children showed up to participate in the parade. These children brought parents and friends who made up a spectator section of about two thousand—more than attend many high school and college track meets.

The track meet and parade was held in a Louisville park—thus eliminating the special policing required for a street parade. The park locale also made it possible for many families to turn the event into a picnic outing.

The parade received a further "big league" touch when civic leaders were asked to serve as parade judges, including Charles Farnsley, a former mayor of Louisville.

Awards given for the winning floats were merely token cups and ribbons. Awards do not have to be large or expensive for children to get full benefit from the event.

## Benefits of Parade-Track Meet

Here's how the parade-track meet combination helped the recreation program in Louisville and might benefit other cities. It:

- Gave children on all playgrounds a feeling of being part of a big event.
- Interested parents in this and other recreation activities.
- Encouraged non-competing children to investigate track and field sports.

- Brought people into a city park and encouraged them to use it.
- Proved to be a wonderful morale booster for a mid-summer event.
- Taught many children arts and crafts skills, let them plan and execute a "big" project from start to finish.
- Helped, through its "natural" publicity value, to call attention to several phases of the recreation program.

## Suggestions

Here are suggestions for those planning a similar event:

- Be specific in limiting size of floats. In future programs Louisville will have a big float and a little float class to give playgrounds of all sizes an equal chance.
- If desirable for the event you are planning, establish a float theme. Louisville may have an athletic theme for the next program. However, the general, or pageant, idea seems to work well.
- Let parents gather materials and help with transportation, but let the children build the floats. Grown-up competition (in this instance) can go too far.
- Give everyone plenty of notice. Floats take time to build. It takes time to generate interest.
- The parade does not have to be part of a track meet. It will pep up any traditional summer event.
- Although well satisfied with the crowd at Louisville's parade, officials felt that the event could be made bigger if desirable. Louisville's parade was held on a weekday—a week-end parade should attract more off-from-work fathers.
- Louisville played down advance publicity to keep the event a playground project. Advance publicity efforts could, of course, build spectator attendance.

While things still remain to be done in this two-year-old program, the parade provides an excellent way to stimulate additional interest in any activity that has become a standard part of a community's summer recreation schedule. ■

# "Dennis the Menace"

## PLAYGROUND

Here is unique playground equipment. What do recreation superintendents think of it? We will be interested in receiving your opinion.



The material on these pages was prepared from information provided by Charles F. Warren, assistant city manager, Monterey, California, and by Hank Ketcham and This Week Magazine. Picture captions and cartoons are adapted with permission from article by Barbara Duniway and F. Leland Elam, in The Town Journal, February 1957.

THIS IS THE DAY of experimentation in playground equipment—in a search for a type which will be the safest, the most attractive, and which will truly stimulate creative and educative play. "Creative equipment," so labelled, is being turned out by several manufacturing companies; and the inventions of Joe Brown of Princeton University (see RECREATION, December 1954, page 576) have been widely discussed and installed in some instances.

Some playground directors, superintendents and leaders are watching, and some are participating, in cooperation with expert builders, architects, educators, in trying out new ideas. Interesting developments are reported along these lines, as an ever-widening assortment of people be-

come involved in these projects. It goes without saying, of course, that parents are always interested in anything that affects their children, and a number of talented mothers and fathers have made suggestions or contributions.

Such has happened in the case of the unique "Dennis the Menace" playground in Monterey, California, which today is attracting attention throughout the nation.

Hank Ketcham—who designed it and constructed it from a dump, at the request of the Junior Chamber of Commerce—is the creator of the loved cartoon, "Dennis the Menace." He is, naturally, a father, or he would never have thought of Dennis in the first place. Anyway, he and Arch Garner, an artist-sculptor friend, took the Jaycees up on their offer to let them design an original playground and went to work. The city planning commission had designated one and a third formerly useless acres as a site, and agreed to provide necessary landscaping and installation of equipment if the Jaycees raised money for the equipment.

**THE LITTLE RIVER.** Below, this wandering stream was designed specifically for the sailing of tiny boats or the launching of leaves and twigs which become rafts, pirate ships and huge ocean liners in wondrous world of childhood fantasy.



**BALANCING BRIDGE.** If your heart skips a beat every time junior balances precariously on a high fence, you would appreciate this safe and successful equipment that gives him a chance to satisfy the urge to perform some balancing feats.



**THE UMBRELLA TREE.** Left, this climbing device is Hank Ketcham's answer to that impish yen to squirm, wriggle, clamber and jump. It is welded smooth at the joints to avoid sharp edges, has a protective coating of gay plastic. Soft sand cushions any fall. It encourages the child to work off some of that excess exuberant energy that may make him seem just like a little demon when he is around the house.



"He and the other miniature citizens are loaded with energy, enthusiasm and curiosity. Too old for crib, too young for school, they demand either breathless pursuit or breathtaking play.

"Second-guessing a child is a precarious procedure. Elaborate toys are often cast aside for some device like an eggbeater. A trip to the zoo sounds fun, but, more often than not, the child's fun is swinging on the railing in front of the cages instead of looking at what they contain.

"What we wanted was a playground with a maximum of *do's* and a minimum of *don't's*. We wanted a project that was not large, not expensive and not exclusive—one that others could copy and improve upon.

"But here are things that children do!



run



slide



jump



wade



balance



dig



swing



pretend



crawl



hang



dodge



hide



sit



climb



roll



throw

"There is only one crossed off: *Throw*—for obvious reasons. On the other hand, there's one we worked overtime: *Pretend*. Children love to pretend. Take that appa-

Community interest was stirred and considerable support was forthcoming, not only in the form of fund-raising events but through donations of labor as well; and Monterey got its playground on a comparative shoestring—for, at best, the equipment was not expensive. The whole thing cost around \$30,000. (You can do it, too! Just write the Monterey Jaycees, for they are making the plans available upon request.)

Now open, the play area is built on soft white sand and filled with gaily colored and highly original apparatus, which to date, has excited the imagination of children and experts alike. Of course, its practicability is just being tried out, and isn't known yet, but record-breaking attendance of both children and parents is reported.

The planning of the equipment makes an interesting story, and Hank tells it in a recent issue of *This Week Magazine*. He says\* in part:

"I have found myself hopelessly enmeshed, concerned and dependent upon the daily activity of a four-and-half-year-old towheaded independent named 'Dennis the Menace.' Dennis lives not more than thirty-six inches above the ground—or the piano, chair, box or wherever he happens to stand at the moment. You can't appreciate Dennis unless you spend a part of each day on your knees. You will be amazed at the change in scenery from there . . . The cookie jar so far away, and why don't they build window sills lower?"

\*Quoted by permission from "A Playground Really Built for Kids," by Hank Ketcham, *This Week*, January 26, 1957. Copyright 1957 by the United Newspapers Magazine Corporation.

**TRICYCLE COURSE.** Leave it to the small fry to find an additional use for this concrete path for tricycle or roller skates—running a crooked mile. That's the beauty of this playground: it stimulates youngsters to use their imaginations.





THE WADING POOL. Playing in this, and riding on the raft that floats freely in four inches of water, beats making mudpies. The raft is of styrofoam and wood; colored plastic forms of fish and marine life, as found on the local beaches, have been imbedded in the bottom of the pool which measures fifteen by forty feet. Equipment does not have to be stereotyped to be safe.



Actual construction began in September 1955, when the playground area was graded. Drainage and sprinkling facilities were installed by the city's own forces. A welder employed by the Jaycees utilized city facilities to fabricate the equipment pieces under Mr. Garner's direction. As soon as each piece of equipment was completed and judged safe, it was moved to the playground and mounted on a foundation within an area of pure white sand, eighteen inches deep. Each was studied carefully to see if it was really safe to play on, was strong enough to stand up under the treatment the children would give it, and if they really liked it.

After these three conditions were satisfied, the items were ready for a protective covering for their outdoor use. Again, more experimentation was necessary to meet the problems of overcoming the deteriorating effects of local salt air and heavy usage. Finally, a uniform product was selected—Polyester Resin—which appears to have the desired qualities and also adaptability for color.

The playground is open to the public from eight A.M. until dusk with no admission charge.

Mr. Warren says, in an article to be published in *The American City*: "The project is well on its way to proving the validity of several recreation theories: Children seem never to tire of something which provides both exercise and an outlet for imagination; parents will bring their children to an 'out-of-the-neighborhood' playground and stay with them to provide parental supervision; and playground equipment does not need to be stereotyped in order to be safe, practical and within a reasonable financial range.

"The city of Monterey has only one problem in connection with the facility—there is need for about three more like it." ■

THE THING. This apparatus does not seem like anything that an adult could use, but it sure is wonderful for playing "Let's Pretend." To one child it may be a space ship, to another it is a plane or a castle, but to all it offers opportunities to slide, hide, crawl, jump and climb. This free-form piece, of steel rods and expanded metal, is forty feet long and eight feet high.

ratus we put together, 'The Thing.' It does not look like anything any adult would use, but to one child it is a space ship; to another, a huge fish; to two girls, a castle; and to all of them, it is rampant with opportunities to slide, hide, crawl, jump, climb—and pretend."

Mr. Ketcham, in exerting his obvious flair for color and design, also added, among other, the following pieces which are proving magnetic to young and old alike:

*Giant Swing Ride.* This crane-like device is designed for a long, sweeping ride. Constructed of steel and covered with plastic, it is so delicately balanced as to enable a rider to propel it merely by shifting the weight of his body.

*Umbrella Tree.* This "ideal climbing tree" measures eighteen feet in height and seventeen feet in diameter. Its limbs are steel rods so spaced that no handhold is ever out of reach of the little climbers. A platform makes a fine look-out, and the supporting poles make excellent sliding for "firemen."

*The Play Mountain.* The surface of a giant mound of earth is covered with miniature roads, tunnels and houses for toy car traffic.

*Maze.* The tricycle course leads into an intriguing maze of colored plastic-covered telephone poles, which have been carefully sanded smooth. There is a carved totem pole in the center.

*Spring Gym.* A twelve-foot high spiral, constructed of stainless steel pipe, achieves a very "springy" climbing apparatus.

*Lion Drinking Fountain.* A friendly lion six feet high, made of fiberglass, offers a drinking fountain to thirsty children. The water-valve mechanism is designed to permit even the very "small fry" the opportunity to have a drink, although they may have to climb up onto the lion's haunches.

*Old Number 1285.* A steam switch engine built in 1924, weighing 155,000 pounds, with a fifty-thousand-pound tender, was donated by the Southern Pacific Company. Old Number 1285 was moved from the railroad siding through the cooperation of Company C of the 84th Engineering Battalion, U.S. Army, Fort Ord, California. The fire doors are welded shut, two stairways lead to the cab, and safety handrails have been welded on. It brings one touch of realism to the playground.

# The Girl in the Blue Denim Skirt, or I was a Supervisor for the WBPR

*This unique melodrama (which every playground leader will recognize as autobiographical) was lived through by Connie Bloomquist, who submitted it with her playground report to the Board of Parks and Recreation, Winnipeg, Canada.*



**T**IME: July and August 1956 about two o'clock.

SCENE: St. James Park, Winnipeg, Canada.

CAST: Connie Bloomquist, supervisor, and the children of St. James Park.

## CURTAIN

Supervisor enters, walking bicycle, is greeted by a mob of bright eager faces.

"What are we going to do today, Connie? Hey? What are we going to do?"

"You'll see. Just let me park my bike."

"What time is it, Connie?"

"Two o'clock. Let's play dodgeball!"

"Can I be captain?"

"Can I be captain?"

"I've never been captain."

"Please . . ."

"Please . . ."

"Ray and Garth can be captains. They can yell the loudest."

"I can yell, honest." (Demonstration.)

"Ray and Garth are captains. Every body else line up against the fence to be picked."

"What time is it, Connie?"

"Eight after two."

"What are we going to do after this, Connie?"

"You'll see . . ."

Scene changes, showing supervisor sitting under a tree watching a rousing dodgeball game. One by one stragglers are placed on the teams, and the crowd soon grows to about forty. After each team has worked off its sadistic tendencies by clobbering their pals with the dodgeball, a game of Red Rover is organized.

Supervisor begins counting heads,

"Ten, eleven, twelve, thirteen, fourteen. . ."

"What time is it, Connie?"

"Two-thirty . . . fifteen, sixteen, seventeen, eighteen, nineteen. . ."

"Red Rover, Red Rover, we call Kenny over."

"He's too little. You guys always call the little guys."

Hot and puffing, the children finish their game. The supervisor speaks, "Let's sit under the tree and cool off with a sitting-down game! I'll tell Janey a message, and she'll pass it to Bill, and so on around the circle. It doesn't matter if it sounds silly, pass it on anyway. Okay?" Whispers, "It is hot today."

Janey: "Pardon?"

Con: "Pass it on."

Janey: "Isishottaday?"

Bill: "Isisishottada?"

Anne: "I didn't hear him."

Group: "Come on, pass it on."

Anne: "I don't remember it!"

Group: "Come on, stupid, pass it on!"

Anne (in tears): "I don't remember."

Con: "Oh well, everyone looks cool now anyway. Let's read a story. How about Paul Bunyan?"

Ages 7-10: "Yah!!"

Ages 10-13: "Can we take out the croquet set?"

Ages 5-7: "I wanna sit beside Connie."

"What time is it, Connie?"

"Three fifteen, and don't ask me again!"

So goes the afternoon, until 3:45 when the big moment arrives—"Time for crafts." (Cheers and general hulla-baloo, while tables are being dragged out, and so on.)

The craft project is paper-bag masks. The supervisor explains in detail, gives out the paper bags and waits for the deluge.

"Cut out my eyes, Connie. . ."

"Can I have some green ears?"

"Do one for my little brother."

"Fred won't give me the scissors."

"Please, Connie, fix mine for me?"

"Please. . ."

Children mill around the supervisor waving bags, ears, hair and pasty fingers. But the supervisor seems pre-occupied. She speaks:

"Forty-two, forty-three, forty-four, forty-five. . ."

"Do mine. . ."

"Forty-six, forty-seven. . ."

"What time is it, Connie?"

"Four forty-five."

At last the crafts are cleared away, and activity begins to taper off. A group gathers to sing:

"There's a hole in the bottom of the sea.

There's a hole in the bottom of the sea.

There's a ho-o-o-o-o-le. . ."

"Is it five o'clock yet, Connie?"

"Five past."

"Yikes! I'll miss Rin-Tin-Tin!"

He leaps up and tears home, followed by half the other songsters, all members of Rin-Tin-Tin Fan Club Number 6483.

The last hour passes uneventfully, except for a few minor scrimmages in the croquet game, and a violent game of swing tag, which has to be called on humanitarian grounds.

As the sun sinks slowly in the west, we wave farewell to shady St. James Park. The "Girl in the Blue Denim Skirt" climbs aboard her bicycle and turns toward the setting sun.

(Voices fade in the distance) "What time is it, Connie?"

(Jubilantly) "Six o'clock!" ■





Throughout history, May Dancing has had great peaks of popularity. Here, May Day, as conducted in Havana, Cuba, is a gala affair—thanks to the fine work of the Mothers' Club. Boys and girls, from tiny tots in sunbonnets to teen-agers in court costume, dance the traditional May Day dances—Bean-Setting; Looby Loo; Oats, Peas, Beans; and Virginia Reel.

# The Maypole Dance

•  
Springtime's  
"Spectacular"

Olga Kulbitsky

**T**HE MAYPOLE DANCE is a survival of an ancient fertility rite. In its oldest form, it was a circle dance around a tree. Today, the tree has been replaced by a gaily festooned pole which has become a symbol of spring. The Maypole Dance is the high point of May Day festivals.

Throughout history, May Day dancing has had great peaks of interest and popularity. Although the Maypole was banned by Cromwell, it came back with the Restoration. In the early part of this century, Maypole Dance competitions were still quite the vogue in England. Figures danced in these competitions are incorporated in the dance described here.

This dance is easily adjusted to requirements of the occasion. With children's groups, it may be advisable to omit the more complex figures. For a more elaborate presentation, a very effective, spectacular entrance may be danced to the *Festival Processional* (Folkraft Record #1179). *Sellenger's Round* has been a traditional favorite at May Day ceremonies since the thirteenth century. If time permits, this entire dance (found on Folkraft Record #1174) may be used instead of the part used here.

### The Maypole

For those who wish to build their own Maypole, the standard dimensions are: nine to thirteen feet in height; three inches square or three inches in diameter; secured firmly in a solid stand. The pole may have one fixed ring on top with ribbons tied in pairs or two rings on top, the lower one fixed and the upper one free to revolve. The boys' ribbons are attached to the upper ring, their partners'

---

MISS KULBITSKY is an assistant professor in the department of physical education, Hunter College, New York City. Our readers will remember the excellent demonstration and workshop on graded dances for recreation leaders she presented at the International Recreation Congress in Philadelphia last year, in cooperation with Frank Kaltman of Folkraft Records.

ribbons tied in the proper place on the lower ring.

Ribbons should be approximately three feet longer than the pole, with a loop at the end for hand to slip through. Longer ribbons allow for free dancing but require more skill in managing. Strips should be one - and - a - quarter inches wide if wool is used, wider strips are necessary if cotton is used because it shrivels. To secure the ribbons in place on the ground, clothespins are practical. Two colors may be used alternately in pairs. Boys may have white ribbons and their partners colored ones or boys' ribbons may be a darker shade than their partners.

### THE MAYPOLE DANCE

RECORD: *Maypole Dance* (Folkraft #1178).

FORMATION: A column of couples, numbered off in two. Any number of couples divisible by four may participate. Twelve couples is the recommended number for most groups. Column may be divided into two sections for entrance from opposite sides.

STARTING POSITION: Girl on partner's right, inside hands joined.

#### Entrance

*Measures: 1-32*— Couples enter from same side, or in two columns from opposite sides, and encircle pole, skipping or running counterclockwise. On reaching their place, couples continue to skip or run in place, or join both hands with partner and swing clockwise, ending with a bow or curtsey.

#### Sellenger's Round

RECORD: *Sellenger's Round* (Folkraft #1174).

FORMATION: All join hands in a single circle, facing center, with girl on partner's right, left foot free.

MUSIC A: *Measures: 1-4*—Circle left with eight slides side-ward. *5-8*—Circle right to place with eight slides.

#### Chorus

MUSIC B: *Measures: 1-2*—Two balance steps forward (right, left) toward center. *3-4*—four running steps back-



**Every Spring the NRA Program Department receives requests for a Maypole Dance. Miss Olga Kulbitsky, a specialist in folk dancing, has prepared this material, and Folkraft Record #1178, Maypole Dance, has been made specifically for the routine Miss Kulbitsky designed. Index this article for future use in your spring festivals!**

ward, starting with right foot; finishing facing partner. 5-8—partners balance (right, left) then turn singly; partners facing, balance to the right and to the left, then each turns once clockwise, in place with four running steps; all finish facing center. 9-16—repeat pattern of measures 1-8, ending with a bow or curtsy.

#### Boys Present Ribbons

*Measures: 1-4*—Boys walk forward, kneel on one knee, and unfasten two ribbons (pegs used to secure ribbons should then be tossed close to pole, at a safe distance, away from the dancing area). 5-8—boys return with one ribbon in each hand and present ribbon to partner, girls curtsy as they receive their ribbons. (The distance from the circle to the ribbons will determine the number of steps and whether two or four steps are taken to a measure.)

#### Simple Weaving

**WIND:** Face partner. Girls hold loop of ribbon in left hand, boys hold loop in right. Use free hand to assist in managing ribbon by slipping free hand as high up the ribbon as convenient. *Measures: 1-4*—Girls weave under boys' ribbons, progressing one place clockwise with eight skips, moving out to new position in circle, greeting new partner with a curtsy. 5-8—Boys weave under girls' ribbons, progressing one place counterclockwise, with eight skips, moving out to new position in circle, bowing to new partner. 1-32—Entire pattern of measures 1-8 done four times, boys ending the "wind."  
**UNWIND:** Face in opposite direction and transfer ribbon to other hand. *Measures: 1-32*—Boys start the "unwind." Repeat the "simple weaving" pattern, unwinding the ribbons, ending with a bow or curtsy to partner when girls complete the "unwind," returning to place. (Older groups, or experienced Maypole dancers, may prefer to make twice the number of changes, progressing to each new place with only four skips. This may be more spectacular but it does not allow for the friendly salutations possible with the eight count changes.)

**CIRCLING:** All slip right hands through loop in ribbon and

join hands in a single circle, facing center, left foot free. *Measures: 1-8*—Circle left with sixteen slides sideward. 9-16—Circle right to place with sixteen slides.

#### Double Weaving

**WIND:** Number One couples turn to face Number Two couples, boys in inner circle, nearest pole. Boys hold both ribbons in hand nearest pole and link other arm with partner, or each holds own ribbon in hand nearest pole and joins other hand with partner. *Measures: 1-4*—"Ones" dance four slides in, toward pole, weaving under "Twos" ribbons; then four slides out to circle, progressing one place clockwise. 5-8—"Twos" dance four slides in, toward pole, weaving under "Ones'" ribbons; then four slides out to circle, progressing one place counterclockwise. 1-32—Entire pattern of measures 1-8 done four times, one couple active at a time, "Twos" ending the "wind."

**UNWIND:** All face in opposite direction, boys remaining in inner circle, nearest pole, and transfer ribbons to other hand. *Measures: 1-32*—"Twos" start the unwind. Repeat the "double weaving" pattern, unwinding the ribbons, ending with a boy or curtsy to opposite couple when "Ones" complete the "unwind," returning to place.

#### Barber's Pole

**WIND:** Partners face girls in inner circle, facing clockwise; boys in outer circle, facing counterclockwise. All hold ribbon in hand nearest the pole. *Measures: 1-8*—Circle in opposite directions with sixteen skips, winding ribbons around the pole. The girls' ribbons will twist around the pole while the boys' ribbons will rotate the revolving top or wind above the ribbons of the inner circle.

**UNWIND:** All face about and transfer ribbon to other hand. *Measures: 1-8*—Reverse direction, circling in opposite directions with sixteen skips, unwinding the ribbons and returning to place.

#### Single Weaving and Finale

**SINGLE WEAVING:** Partners face. All hold ribbons in right hands. *Measures: 1-64*—All weave simultaneously, as in "Grand Chain" or "Grand Right and Left" without joining hands, passing partner on right, next one on left, and continue to weave around circle, girls skipping clockwise, starting to weave "over and under," while boys skip counterclockwise, weaving "under and over."

Activities of the program will determine the finale and exit of the Maypole Dance. If the program is to continue around the decorated pole, plait as long as possible, then release ribbons and end dance in a single circle with bow or curtsy to partner.

If an exit is necessary, plait as long as desired, allowing enough music for participants to leave dancing area.

#### Exit

The dancers may start the exit figure on signal from a leader, or after plaiting for a specified number of measures, or after partners have met a specified number of times.

The exit may be a gay, informal one, with everyone skipping off in all directions, or a repetition of the entrance, skipping off in the same order in one or two columns or a "serpentine," with one person leading the group with all hands joined in a single line. ■

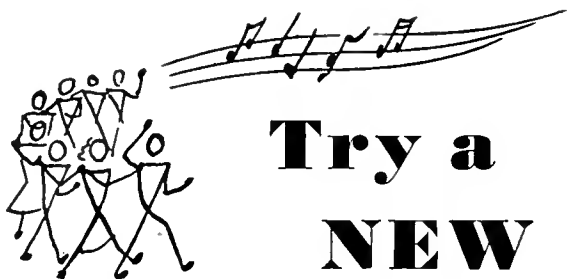

# Try a NEW IDEA

## Playground Songaree

We all know the value of music in our programs, but we also know how difficult it is to do much with it on a playground, except in those few areas where the leader has real musical talent. Charleston, West Virginia, had a good experience last summer which it is pleased to pass on.

For several years we have encouraged each playground to have its own playground song. As is usually the case, some had one and some did not. Generally the words were original, the tune a popular one. Invariably the best playgrounds, those with the most spirit, had a song and used it.

During the past summer, toward the end of the season, a supervisor suggested we hold a city-wide event with each playground presenting its own song. Something we should always encourage, community singing, could also be on the program. The name "Songaree" was a natural.

The results were excellent. Any playground without a song got one. Playground spirit climbed. Rules were distributed, suggesting that the chorus from each area wear some distinctive attire, such as a sash, hat, bow-tie, or similar identification.

These following two songs are typical:

### TUNE: *Memories*

Tiskelwah, Tiskelwah, the place we love to play,  
Children come to have some fun and stay the livelong day;  
Run and swing, dance and sing, grownups and the small,  
We play fair and square, out in the fresh air,  
At our wonderful Tiskelwah.

### TUNE: *April Showers*

Though summer showers may make us blue,  
We always manage to see them through,  
And when the sun shines, you'll see us smile  
Because we know that we'll be having fun  
In just a little while,  
We play such good games all through the day,  
We try to be sports in all our play,  
So if you want to see the playspot  
Where joy and fun abound  
Come up and visit Chandler's Drive Playground.

A good master of ceremonies and song leader guaranteed a smooth performance when the night of the "Songaree" arrived. Everybody had a good time because everybody participated. There was no competition and no awards.

A recreation department can get good publicity from such an event—it catches the public fancy. Such was the case with us; weeks later people were still commenting on it.

Our hope is that we can build the "Songaree" into an all-age community affair. Singing is good for the soul and singing together builds good playground and community

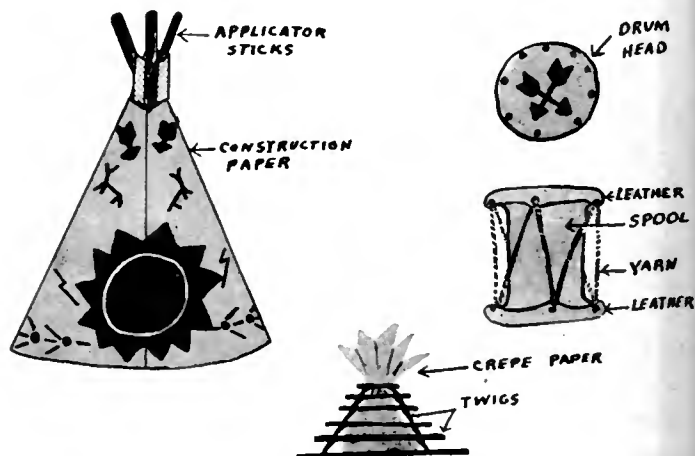
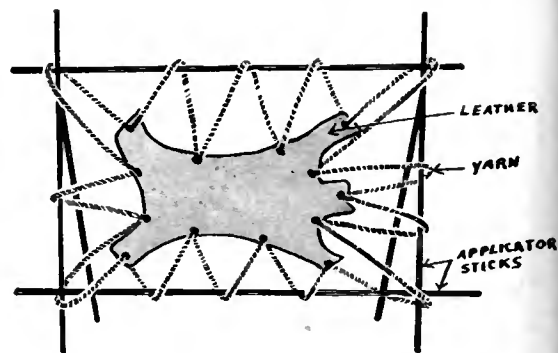

spirit.—BOB KRESGE, *superintendent, Parks and Recreation Commission, Charleston, West Virginia.*

## A Playground Indian Village

The recreation department in Santa Rosa, California, has come up with a new wrinkle in the way of a successful craft project using all scrap or inexpensive materials: a miniature Indian village complete with tepees, drums, stretched skins, council fire, and, of course, Indians.

The whole village is mounted on a large piece of plywood as a permanent fixture. The tepees are made of construction paper, painted with water colors. Tent poles are simply applicator sticks (the type used in a first-aid kit) glued to the inside of the tepee—very authentic looking.

The drums are constructed from empty spools, scrap leather, and discarded yarn. The stretched skins are made of scrap leather cut to resemble animal skins. These are tied to a stretching frame made of applicator sticks. The council fire consists of twigs glued together with a glowing flame of red crepe paper. Small stones make the council ring.

Indians are made by folding cloth scraps and cementing the folds together. A small piece of cork is added for a head and braided yarn for hair. Small pieces of feathers from broken arrows serve as an Indian headdress. All the items except the Indians and drums are cemented to a base, forming a permanent campsite for our tribe. In making the base, a board is coated with rubber cement and then sprinkled with sand or gravel. The sand can be sprayed with green paint to add a little color to the scene. The children in Santa Rosa use the Indian Village to play cowboys and Indians to their hearts' content. ■

## Notes on a

# Summer Experiment

*This simple, factual statement of the problems of a playground staff in using a new methodology is very thought provoking. We believe you will find it stimulating. It is a type of program that has been generally accepted in many camps and day camps. Playgrounds offer a more complex set-up because there is no "captive audience." This article is a factual report of an experiment in a group-centered, rather than activity-centered, program on a New York City playground. Have you tried it? Did it work? We'd like your comments.*

Betty Yurina Keat

OUR ASSEMBLED group stirred restlessly in the muggy warmth of early July. We were vacation playground leaders from one district of the New York City Board of Education's summer vacation playground schedule. This preliminary conference was being held to orient the staff. Our supervisor soon introduced the crucial point of the orientation—administration had decided on a new policy for the summer program. As part of an experiment in recreation methodology, our district would participate in a "group-centered" project. It was the first of many times that the phrase "group-centered" fell on our ears.

At the season's end, we evaluated our accomplishments; and we want to share with those of you in recreation our program notes on a summer experiment:

We found that the basic difference between a group-centered program and an activity-centered program was the unit of program organization; all other differences evolved from this initial fact. In a group-centered program you consider the "girls eight-to-ten." In an activity program you are concerned with "arts and crafts." Our center had until this summer, operated an activity program; we were about to experiment.

Our first problem was reorientation of both staff and participants. The

---

MRS. KEAT, now a resident of Baltimore, has been active in recreation with the New York City Department of Parks and Board of Education, and has also observed recreation and social education in India (see RECREATION, October 1956, page 373).

staff had to re-examine the old activity program, analyze its recreation features and see how these parts fitted into the new method—whether there were any to be discarded. How will arts and crafts appear in the new arrangement? Largely as a responsibility of the individual group leader, we found. Does the dance festival, an established tradition of summer program, fit into the new plan? Shall we hold on to it? Can it be shelved this year? How do you readjust children to the fact that they now "belong" with a specific leader and group and can't go to Mr.—for arts and crafts now, just because they feel like it. These were among the many early problems we had to solve.

Later problems were more complex, and, because of their complexity, have not all been resolved. Group-centered activity necessitates a more personal relationship between group and leader than exists under an activity-centered program. The leader must know his group members intimately so the summer can be fully planned and so each day's "decision-making" and fulfilling can be as valuable as possible to the whole summer. This kind of personal knowledge is not available to the recreation leader because there are no files of information except those which experience yields. The summer season is short. The staff is a summer staff with no prior association with the children. The leader's ability to coordinate recreation with the known needs of the individual group members is therefore greatly handicapped.

As knowledge of the group members increased, however, our leaders soon found themselves faced with new demands. No longer activity specialists,

they had to equip themselves with versatility in many fields, and be ready, willing and able to acquire new skills as need for them arose through the expressed desires of the group. Many recreation leaders can handle basketry as an activity. Not nearly as many are familiar with the sewing machine. Our youngsters have not handled reed this summer; they showed no interest and could not be motivated. On the other hand, not a scrap of percale hides in the supply bin. If the leader had been "on the spot," willingness to learn new skills quickly would have been of top priority. However, not only versatility in one field of activities is important, but also dance leadership, swim leadership, outdoor and indoor games. In short, since the group-centered program is based on the relationship between one group and one leader, all day long, every day, the leader must be able to share all the interests of the group or to acquire facility, with a priority on speed.

Associated with increased leadership versatility, but a program in itself, is composition of a group. What kind of group do you want and need—and why? Other considerations become important when these questions are raised. How many group members constitute an ideal group? On the other hand, how many children must the center serve and with how many staff members? What criteria do you use in forming groups?

We formed four groups, based on age and sex. They were not ideal considerations, we found out. Some of the groups were overlarge in terms of the twelve-to-twenty "ideal." Others did not share the same interests, an *a priori*

assumption. However, in terms of other considerations—recreation needs of the community which we were to serve—we felt these decisions to be best.

A crucial question within a functioning group was the integration of the needs of the "special individual." We did not want the below-norm or superior child to suffer by the "average," but the resolution of these special needs with those of a large and demanding group is not simple. Sandra for her age and her group had an extraordinary gift and interest in interpretive dance. Her group preferred simple folk dance. When should Sandra be allowed to influence group choice and to what extent? How should her special gift be preserved and developed? Jean is slow and below normal in intellect. How does the activity prevent her from feeling frustrated and discouraged in a group enterprise, and having "fun"?

On the group side, should the group "wait" for Jean, how long and how often? What is the recreation leader's role in assisting and guiding the group in its decisions on these and like matters? How are these matters relevant to the essential element of recreation—voluntary participation? How can the recreation leader in this situation reconcile the divergent levels of group needs, individual growth capacity, and total recreation? We must remember that the recreation leader is not in a classroom situation with its tendency to compulsive discipline.

These have been among the problems either directly caused by a change in the unit of program organization or indirectly influencing the recreation situation. The attempt to solve them undoubtedly resulted in increased versatility and adaptability of our recreation leaders.

We have found it necessary to re-evaluate the essential assets and liabilities of both the activity-centered program and the group-centered program as media for effective community recreation. We hope the solutions we tried resulted in growth of the members of the group. We can't be sure it did; or, if it did, how *much* growth and what *kind* of growth. There are as yet no accurate measurements of the contribution which recreation techniques effect on the physical, mental and emotional growth of the child. Neither are there any criteria by which we can discover how well the techniques of recreation coordinate and cooperate with those of group method. So, as a result, we can present no conclusions—just more problems with which the profession of recreation must soon contend and resolve—with these program notes on a summer experiment. ■

**Jamison PLAYGROUND EQUIPMENT**  
 Be sure to check the many exclusive features of this rugged line. Write for free catalog of 254 items.  
 Jamison Manufacturing Co. Since 1925  
 6781 South Mettler Street  
 Los Angeles 3, California

**Wear Your Golden Age Club Pin With Pride Wherever You May Go**



Designed by representatives of over 100 Golden Age clubs and used nationally.  
 Gold colored metal with evergreen tree in jewelers' enamel. Symbolic of long life, strength and perseverance.  
**EXACT SIZE**  
 The words LOVE, PLAY, LEARN, SERVE (greatest values of club membership) enameled in black. The border is a laurel wreath for honor. Safety catch.  
*Available Only to Authentic Clubs.*  
 50c each, minimum order 10 pins.  
**James Spencer & Co.** 22 N. 6th Street Philadelphia 6, Pa.



**Jayfro BASKETBALL STEEL CHAIN NETS**  
 3 Years Guarantee outdoors or indoors

Also featuring Jayfro's custom built  
 ✓ ALUMINUM MULTI-PURPOSE STANDARDS  
 ✓ SHUFFLEBOARD SETS WITH "RUBBER CUSHIONED" DISCS  
 ✓ PADDLE TETHERBALL SETS  
 • Send for Free Catalog •  
**JAYFRO ATHLETIC SUPPLY CO.**  
 Dept. R, Box 1065, NEW LONDON, CONN.

**JUNE is National Recreation Month**

**PLAY AREAS DO DOUBLE DUTY WITH Superior Folding Table Tennis Tables!**



**NEED MORE SPACE?**

Superior tables can be stored compactly, can be opened for play in a jiffy . . . even rolled away on wheels by a youngster. Sturdy, rigid Superior MT1000 Table has edge-protecting METAL FRAME AND TUBULAR STEEL LEGS, HEAVY DOUBLE HARDWARE ON LEGS. Thousands used by playgrounds, camps, schools, military installations . . . wherever a heavy duty table is needed.

**NEW! Optional Feature!** Roll-away casters make it easy to clear your floors.

**POPULARLY PRICED! APPROVED BY USTTA.**  
 Write for literature showing complete line of institutional table tennis tables.

**Superior INDUSTRIES CORPORATION**  
 565 Barry Street, New York 59, N.Y.

**monroe FOLDING BANQUET TABLES AND MONROE TRUCKS**



If you are on the Board of your Church, Lodge, Club, School, etc., you will be interested in this modern Folding Banquet Table.

Completely finished tops, resistant to most serving hazards. Used with or without table cloths.

Write for Table and Truck Catalog and special price discounts to institutions and organizations.  
**Monroe Co., 181 Church St., Colfax, Ia.**

# A Dump and a Dollar . . . . .

*A search for the right summer project.*

Michael Solomon

A STORY BY Maurice Maeterlinck tells of two young children who went all over the world looking for the blue-bird of happiness. They searched everywhere, but could not find it. Finally, discouraged, they came back home, and lo, there perched in a tree in their own backyard was the blue-bird. This same experience happened to us in Dayton, Ohio.

Last spring, when we were planning our summer recreation program, and were debating what should be the grand finale of the season, we considered all the usual activities: pageants, tableaux, circuses, variety shows. In past years we had done many of the standard things, such as fairy tales, the discovery of America, colonial times, pioneer days, and so forth. Two years ago we produced a sesquicentennial pageant, celebrating Ohio's 150th anniversary, which, of course, was also done by many other communities at the same time.

Now we wanted to do something different, and we started searching—if only we could find an interesting theme, something either off the beaten track, or unique to our community. Unique to our community, or—right in our own backyard. Bomberger Park—that was it!

This community center, in continuous operation since 1907, has been generally recognized as the oldest public recreation facility in Ohio. Last year the old building, which had long outlived its usefulness, was torn down, to be replaced by a modern recreation structure. Why not take the story of recreation in Dayton, as represented by Bomberger Park, and make it the theme of the summer grand finale?

Someone recalled that our first superintendent of parks, William Madden, had played a major role in the development of Dayton's parks and playgrounds in the early years of this century. Bill Madden originally traveled from one park to another on a bicycle. He once said, "Give me a dump and a dollar, and I'll build you a park." Many of us who remembered him also remembered what he had said.

So we took the character of Bill Madden and the story of recreation in Dayton as it had unfolded and developed at Bomberger Park as the theme of our big playground event. We called it "Playground Frolics: The Story of a Dump and a Dollar."

There were forty-five playgrounds in operation, and every one of them was represented in one way or other in the production. Over five hundred children participated.

The story opened with Bill Madden riding on stage on his bicycle. The scene was a dump, with ragged children playing desultorily with tin cans, sticks, and stones. The story

line, throughout the show, was developed by a narrator. Accompanied by mood music, the narrator began:

"This is a story of ambition and foresight; the story of a man, a dream, and a city. It is a story of Bill Madden. . . . He looked about him and saw the children of Dayton. He saw them playing in alleys and gravel pits, in city streets and empty lots, abandoned buildings and dumps. He looked about him and sighed. . . . This, then, is the story of Bill Madden's dream, out of which grew the city's parks and playgrounds. . . ."

The setting then changed to Bomberger Park, where children, in costumes of the Early Twenties, were rolling hoops, playing volleyball, marbles and other games. The story line then developed one scene or sketch after another, including a choral group, fashion show, movie flickers, square dancing, "Casey at the Bat," and the grand finale, "Playgrounds On Parade." In the final scene, with more than five hundred children and their directors massed on stage, Bill Madden again appeared, pushing his bicycle, as the narrator said:

"And these are the children of a dream come true. Dreams like that of Bill Madden aren't fulfilled by wishing. To bring them to life takes years of work—and imagination. Countless others have contributed to this dream and its fulfillment. It continues, and will continue, for generations to come. We thank all who have helped Dayton's park and recreation program, and we hope never to forget Bill Madden, who planted the first seed—who one day long ago saw children playing in an empty lot and spoke the words of his dream: "Give me a dump and a dollar, and I'll build you a park."

The production was put on at our Island Park bandshell, before an audience of twenty-five hundred. Thirty-three of our forty-five playgrounds had children in special parts; all forty-five appeared in the final scene. Each playground represented, with signs and costumes, a different activity: softball, tennis, storytelling, crafts, drama, dancing, and so on.

One result we especially liked was the part played by our leaders. In addition to organizing and rehearsing the various scenes on their playground, helping with makeup, stage crews, and general organization, a number of them got right in with the children to play various roles in the production. This helped to hold the more difficult scenes together.

The most delightful sketches of the entire production were of the oldtime flicker movies—one of the popular features in Bomberger's weekly program of long ago.

Not the least remarkable thing about this most successful show was that it was directed by a freshman student from the University of Dayton, Shirley Bernier, assisted by Jerry Martin, another UD student whose sure sense of theatre comedy insured the success of the various acts. ■

MR. SOLOMON is supervisor of special activities for the Bureau of Recreation in Dayton, Ohio.

# Story Telling on the Playground . . .



Gladys Conklin

"Sitting in the shade of a tree is pleasant." Storytelling in Richmond, Virginia.

**S**TORYTELLING on the playground requires a few special techniques because of the outdoor location with its uncontrolled surroundings. The playground storyteller is a close kin of the original folk storyteller who gathered a crowd around him at crossroads because he had an urge to share a tale that had moved him deeply. A successful storyteller chooses a story he feels will be fun to share with his audience.

The goal of the storyteller is to arouse emotions, such as wonder, laughter, joy, amazement, or surprise. A good story also captures the imagination. To do these things, it must have a direct or interesting beginning, a bit of suspense, a climax and a happy or hilarious ending. A child puts himself in the hero's place, and he needs a feeling of accomplishment or satisfaction when the story has ended.

For all storytelling, folk tales are by far the easiest to learn and tell. The folk tale is simple and strong and has a universal appeal. There are as many kinds of folk tales as there are storytellers, and the teller can choose the type that appeals to him. A story should be told as though the teller saw or experienced the event himself. If he tells

it with zest and thoroughly enjoys the story, the audience will enjoy it. Storytelling is more than sharing a story, it is also a sharing of heart and spirit.

In telling a story, a low voice is pleasing but on the playground one needs volume. Even in a quiet corner, the voice should be louder at the start and drop as the children become interested; and it should vary with the story's tempo. Some of the hero tales march rapidly from beginning to end; others go slowly, even clumsily, in keeping with their chief characters. The teller must learn to recognize the value of a pause, the need for hesitation, that holding of suspense that quickens the pulse of the listener.

For storytelling, a shady nook or sheltered corner of the playground is ideal. Sitting in the shade of a tree is pleasant, but many playgrounds have neither shady nooks nor leafy trees. It may be necessary to gather the children around you out in the open. In this case, be sure they sit with their backs to the sun. Always see that your audience is comfortable; and for your own comfort, learn to separate noisy twosomes.

You may stand or sit during the telling, but be where you can easily watch the faces of all the children. Eye contact between teller and audience is important. Also, watching changing expressions on the children's faces is a

rewarding pleasure for the teller.

The ideal time of day for playground storytelling is mid-afternoon — about three o'clock. The children are beginning to get tired, but it is too early to go home. They are ready for a rest period and will welcome the opportunity to settle down and listen to "Once there was a king who had seven sons. . . ." or almost any story that starts with "Once upon a time. . . ."

## A Few Aids for the Storyteller

Look for these in your public library: *The Five Chinese Brothers*, Claire H. Bishop (Coward); *Three Golden Oranges and Other Spanish Folk Tales*, R. S. Bogge and M. G. Davis (Longmans); *Best Stories to Tell to Children*, Sara Cone Bryant (Houghton); *The Shoemaker's Apron*, Parker Fillmore (Harcourt); *Household Stories*, Grimm Brothers (Macmillan); *A Wonder Book*, Nathaniel Hawthorne (many editions); *English Fairy Tales*, Joseph Jacobs (Putnam); *Blue Fairy Book*, Andrew Lang (Longmans); *The Way of the Storyteller*, Ruth Sawyer (Viking); *East o' the Sun and West o' the Moon*, Gudron Thorne-Thomsen (Row, Peterson); *Twenty-Four Unusual Stories*, Anna Cogswell Tyler (Harcourt); *Tales of Laughter*, Kate Douglas Wiggin and Nora Archibald Smith (Doubleday). ■

---

MRS. CONKLIN is storyteller and children's librarian at the Hayward City Library, Hayward, California.

MR. CHRISTOPHER Charlemagne Cheesemore was six years old. He was in a hurry. Mr. Christopher Charlemagne Cheesemore was always in a hurry. If he went upstairs, he ran. If he came downstairs, he ran. Mr. Christopher Charlemagne Cheesemore hurried all of the time.

Christopher's mother would say, "Christopher Charlemagne Cheesemore, you hurry too much." But Christopher would only laugh and think that his mother was very silly. Christopher Charlamagne Cheesemore often went to the store for his mother and she always said, "Christopher, don't run so hard. Stop and watch the traffic and be sure there are no cars coming."

Christopher would say, "Surely, Mother," and then he would scurry away.

Now, one day, as was his custom, Mr. Christopher went scampering off to the store for his mother.

When Mr. Christopher Cheesemore reached Main Street, did he look north?

No! He did not.

Did he look south?

This little story, written by a mother, was designed to be read aloud with dramatic touches in voice inflection, and facial expression. It would lend itself beautifully to response-participation on the part of the youngsters. Can't you hear them call out, "No, Dr. Sprout."? Or wouldn't it be fun for the youngsters to pantomime it, or use it as a puppet show?

No! He did not.

Did he look east?

No! He did not.

Did he look west?

No! He did not.

Mr. Christopher Charlemagne Cheesemore was in such a hurry that he didn't look where he was going, and he ran right across Main Street.

Reprinted with permission from Safety Education, November 1956. MRS. NORRIS is a resident of Chatham, New Jersey.

# Christopher Cheesemore

Ruth H. Norris



## A Story

All of a sudden, scurrying Mr. Christopher Charlemagne Cheesemore heard *Screech, Screech, Screech!*

And there lay Mr. Christopher Charlemagne Cheesemore!

Poor old Mr. Croggins, the milkman, was out of his car in a hurry.

Dear Mrs. Nicodemus excitedly called to Tommy Squire, the patrolman, who told Mr. Quiggs, the groceryman, who called Dr. Sprout, who told his nurse to follow him. And there around Christopher Charlemagne Cheesemore were Mr. Croggins, Mrs. Nicodemus, Tommy Squire, Mr. Quiggs, Dr. Sprout and his nurse.

Mr. Christopher Charlemagne Cheesemore opened one eye.

Mr. Christopher Charlemagne Cheesemore opened the other eye.

*He could see!*

Mr. Christopher Charlemagne Cheesemore raised one leg.

Mr. Christopher Charlemagne Cheesemore raised the other leg.

*He could move his legs!*

Mr. Christopher Charlemagne Cheesemore moved one arm.

Mr. Christopher Charlemagne Cheesemore moved the other arm.

*He could move his arms!*

Mr. Christopher Charlemagne Cheesemore turned his head right.

Mr. Christopher Charlemagne Cheesemore turned his head left.

Mr. Christopher Charlemagne Cheesemore raised his head.

*His head would turn!*

Kindly Dr. Sprout said, "Mr. Christo-

pher Charlemagne Cheesemore, did you look east?

"No, Dr. Sprout."

"Mr. Christopher Charlemagne Cheesemore, did you look west?"

"No, Dr. Sprout."

"Mr. Christopher Charlemagne Cheesemore, did you look north?"

"No, Dr. Sprout."

"Mr. Christopher Charlemagne Cheesemore, did you look south?"

"No, Dr. Sprout."

"Well, Mr. Cheesemore, will you look east the next time?"

"Yes, Dr. Sprout."

"Will you look west next time?"

"Yes, Dr. Sprout."

"Will you look north and south?"

"Oh yes, Dr. Sprout. Yes, I will."

"You are a very lucky boy," said Mr. Croggins, the milkman.

"You are a very lucky boy," said Mrs. Nicodemus.

"You are a very lucky boy," said young Tommy Squire, the patrolman.

"You are a very lucky boy," said Mr. Quiggs, the groceryman.

"You are a very lucky boy," said Dr. Sprout's nurse.

"Now," said Dr. Sprout, "get up, and I will take you home, but stop hurrying all the time. Don't ever run across a street, *never, never, never*, and always look before you cross. Look east; look west; look north; look south—and then walk across."

"Yes sir, Dr. Sprout. Yes sir, forever and ever," said Mr. Christopher Charlemagne Cheesemore. ■

# Lively Ideas for the Summer Play

Ways to add color and excitement to  
your playground dramatic program.

. . . . . Pamela Prince Walker

FIRST, choose your play for simplicity. The children have joined your dramatic group with visions of gay rehearsals and laughter. They did not count on long hours of homework or forgoing their favorite evening television shows. Besides, it is summertime, carefree time! *A pantomime, read by a talented teen-ager while the children act, is best.* On the Fourth of July, *Paul Revere's Ride*, with little boys in red coats with toy drums staging a lively battle with the Yankees, is an excellent choice. Later in the summer, try one of the A. A. Milne poems from *When We Were Very Young*. "The King's Breakfast" and "The Four Friends" are whimsical narrative poems from this selection.

For young children, *The Gingerbread Boy*, *The Three Bears* and *The Little Red Hen* are all simple enough. Boys will like *Three Goats Gruff* and *The Wolf and the Seven Goats*; and *Snow White*, *Rumpelstilzkin* and *Sleeping Beauty* are old favorites. Mother Goose rhymes are fun, and a good start. For a really breathless final production, *The Emperor's New Clothes* and *The Pied Piper* can be as simple or as elaborate as needed.

Pantomime collections from play publishers sometimes offer unique ideas, or perhaps someone you know with a talent for writing could compose a humorous narrative from an old fairy tale:

"There once was a lass named Snow Whitey,  
Who went all about in her nightie. . . ."

(Snow White appears in a nightgown, holding a candle.)

or

"There once was a maiden named Cindy,  
Who cut-rug to a very cool Lindy. . . ."

(Cinderella enters, jitterbugging.)

Folk tales, folk songs, ballads and narrative poems are all possible sources for pantomimes. Songs and poems are simplest because they can be used "as is"; stories may have to be cut and simplified.

Now that you have your pantomime and are rehearsing each day (ten forty-five minute rehearsals should easily suffice—if not, you have chosen something too difficult), try this for an original advertising stunt:

A few days before your production, plan to have some of your cast in costume drawn onto the playground in a wagon

or wheelbarrow, announcing the play over a megaphone as they come. Decorate the vehicle with bright crepe paper streamers and let the rest of the cast (also in costume) follow behind, ringing bells and tooting trumpets. Stage their entrance at your busiest time during the day, and they will cause quite a sensation. From the wheelbarrow they might sell tickets for a pebble or a pin.

To add spice to rehearsal days how about staging a big scavenger hunt to collect the necessary properties for the play? While the children are enjoying all the fun of such an event, you are collecting your properties without effort, and advertising the production to homes nearby.

Let the excitement flow right into your arts and crafts classes. The craft leader is always on the lookout for new ideas, and when the children have been weaving baskets and belts for several weeks it will be a welcome change to make paper hats, wands or crowns. Some may prefer to paint big, splashy posters to hang about the playground.

When rehearsals hit that mid-way lull, pep them up with a nature hike into the woods to find sticks for wands or leafy boughs for stage decorations. Each child can bring his own box supper, and after the picnic you can suggest a quick rehearsal before you start home. Keep all your rehearsals short, snappy and full of fun.

Now comes the day of the play. Anticipation hangs in the air. The hillside, tennis court or other area is rapidly turning into a glamorous stage with the help of crepe paper and a pair of scissors. Children are rushing to you for last-minute instructions about costumes. The little boy who was to play

---

Editor's Note: The NRA Program Department reports it has a few extra copies of several pantomimes and plays that can be used with playground youngsters, which appeared in back issues of *Recreation Program Aids*. Available: "The Vanity of the Rat" (pantomime); "The Princess in the Tower" (narrative plus choral reading); "Down from a Cloud" (pantomime); "The Boy Who Stayed Up Late" (play). Each \$.25—first come, first served!

---

the leading role has just informed you that he is going to the beach with his family, and you hurriedly prepare another child for the part. This might have meant cancelling the play if you had chosen a performance with lines, and you are more than relieved that you decided upon a pantomime.

In the buzz of excitement it will be hard to find time to make refreshments for a party after the play. Ask one of the mothers to help. Perhaps she will agree to give a few of the girls a baking lesson right in her kitchen. This is much more fun than having refreshments supplied.

Curtain time! You finally sit back and relax. As you watch the beaming faces about you, you begin to think about the future. It seems too bad to let the enthusiasm you engendered during the last two weeks simply fade away. Why not plan a summer repertory theater? A pantomime once every two weeks should be easy—not like a series of plays with lines. Why not? As the curtains open and you see the happy pride and assurance upon the faces of your cast, your mind is made up. Drama *does* belong on the playground! Simplified, of course, but with the same old foot-light magic of make-believe. ■

---

MRS. WALKER, a specialist in creative dramatics, is a member of the recreation department in Charlottesville, Virginia.



# Evaluation in Recreation-Playgrounds

WHEN THE SUMMER playground season draws to a close, it is evaluation time. As a part of the evaluation process, many directors and/or administrators have found it valuable to have the play leaders appraise the summer's results. The following form, made up for this purpose by the Kansas Recreation Association, was published in the August 1956 issue of its bi-monthly *Newsletter*, and is reprinted here by permission. It is a composite list of items covered in forms received from Topeka, Emporia and Pittsburg.

### I. Training and supervision:

- Do you feel that the pre-season training was worthwhile? If not, what areas would you like to see improved?
- Were staff meetings helpful? Suggestions for additional items to be covered in staff meetings.
- Were supervisory visits helpful?
- How can the recreation department be of more assistance to you in the planning and execution of your program?

### II. Location:

- Was the playground located correctly in this area for maximum use?
- Is there a real need for a playground in this neighborhood?
- How could the enrollment be increased?
- Please list names of adults in neighborhood who were helpful to you.

### III. Facilities and improvements to area:

- What improvements do you think are needed most at this location?
- What facilities are most needed?
- Do you have any suggestions as to layout that you think would contribute to the successful operation of the unit?

### IV. Equipment:

- List in order of popularity the equipment used this year.
- Did you have enough equipment to do a good job? What should be added?

- Was equipment storage satisfactory?

### V. Program:

- Were the weekly tournaments of value?
- What events would you like to have next year?
- Would you like competition between playgrounds? In what activities?
- Do the hours of operation fit your neighborhood? Explain.
- Do you have any suggestions concerning the crafts program?
- What has been the general reaction to our roving storyteller? Suggestions.
- What suggestion do you have for rainy day programs at your site?
- Do you have any program suggestions for attracting more teen-agers to the playground?

### VI. Miscellaneous:

- What rules and regulations do you suggest that we add, change or eliminate from our workers' handbook?
- What, in your opinion, can we do to strengthen our public relations program?
- List any other suggestions you have for improving our playgrounds.
- Would you like to work on the playgrounds next summer?
- What would be your thinking in regard to uniforms for leaders (T-shirts for men and wash dresses for women)?

Name of playground.....  
 Name of leader.....

Additional information on evaluation of playgrounds may be found in two National Recreation Association publications: *Playground Leaders, Their Selection and Training* by R. T. Forsberg (RBC 417—\$.85) and *Summer Playground Evaluation—a Check List* (P165—\$.25). Both are available from the NRA, 8 West Eighth Street, New York 11. ■

## SAFETY PROGRAM RECOMMENDATIONS

**Playground Safety Patrol.** The initiation of a playground safety patrol will greatly help in the reduction of accidents. More supervision is one of the biggest single factors in reducing accidents. However, it is difficult to supervise an activity and the grounds and apparatus at the same time; it would be the primary duty of the safety patrol to keep a watchful eye on the apparatus and grounds to see that they are used properly and safely. If an infraction of rules is noticed, the playground leader would be informed.

**TV Time.** Get as much TV time as possible. Costumes should be made up in the winter, and a routine worked out to prepare for the playground season. The routine should be both educational and entertaining, showing the proper way to use apparatus.

**Supervision.** Playground leaders should adopt a "get tough" policy in regard to infractions of rules on the playgrounds. Too many children are told day after day to, "sit in the swings" and, "no climbing up the slide," and so on. The children know the rules by this time and steps should be taken to enforce them.

**Playground Signs.** Steps should be taken to see what arrangements can be made to provide signs warning motorists they are approaching a play area.

**Accident Reports.** Playground accident reports should be revised to include space for recommendations from playground leaders; they might have some excellent ideas on preventing the same types of accidents from recurring. We should also insist on a more thorough report from leaders on accidents reported. — JAMES E. BONAHOOM, Director of Safety, Fort Wayne Park Board, Indiana. ■



Refreshment stand equipment in this Baton Rouge unit is valued at \$6,500.

## Concession *vs* Direct Operations

Compiled by Ralph M. Hileman

**L**IKE ALL TOO MANY public administrative procedures, there is no generally accepted policy for formulating procedures for the management of refectories or refreshment stands. In East Baton Rouge Parish we have, from the inception of our recreation and park program, operated our own refreshment facilities in the belief that public funds made the facilities available and the public should receive all benefits derived from their operation.

Regulations governing operation of the facilities are based upon a city-parish ordinance, adopted in 1953, which gives the recreation and park commission exclusive right to vend, sell or otherwise dispose of goods, merchandise, or any article of tangible personal property on and within properties under its jurisdiction.

At present we employ a full-time concession manager who, with a summer assistant, supervises the department's seven full-time and eleven part-time units. Operators are employed to handle the respective units, also vendors for the major baseball and football stadiums. Unit operators, except at the football and baseball stadiums, receive ten per cent of the gross stand sales, from which they pay for whatever assistants they may need. At the two stadiums the unit operator receives twenty per cent of the gross, from which he pays his help. Vendors receive eighteen per cent of their gross sales, which are kept separate from stand sales, with two per cent going to the person in charge of vendors.

During the past ten years, gross receipts increased from \$12,633 in 1946 to \$63,139 in 1955; net profits from \$2,891 to \$13,849.

MR. HILEMAN, superintendent of recreation and parks, East Baton Rouge Parish, Baton Rouge, Louisiana, was chairman of a subcommittee on concessions of the NRA National Advisory Committee on Recreation Administration. This article is based on information gathered by his subcommittee.

In 1955 a verbal offer of \$10,000 a year was made by a local concessionaire for the right to operate the commission's facilities. In order to determine whether its method of operation was most advantageous financially, the commission decided that the right to operate them should be advertised, in order to determine whether or not a greater amount could be secured by leasing them than by direct operation. Specifications for bids on the concessions called for a one-year contract, included prices, quantity, quality, and types of goods and services to be offered, listed the places at which goods were to be sold and the services that should be provided without cost. They also covered such items as maintenance of equipment, liability insurance, concession records and the commission's right to cancel the contract.

When prospective bidders learned they would be required to operate certain units, as we were doing, even though it might result in a loss, that they would not be permitted to increase the prices of merchandise or to change the weight or size of packages sold, and that they would have to rent the equipment already owned by the commission and provide a performance bond, they lost interest and not a single bid was received.

With expansion of our program and facilities, it is believed that the gross income from food and drink operations will surpass the \$100,000 mark within the next three years, thus assuring us a net profit of \$25,000 to \$30,000 annually, which will be invested in additional recreation programs.

Any city where refectories are to be handled on a concession basis would do well to consider the following criteria suggested by Howard B. Holman, director of the Fresno, California, Joint Recreation Board. If followed, these criteria would protect the public interest:

1. Make a careful and exact determination of what is to be done.

2. Outline goals, procedures, restrictions, activities, payment, method of payment, and other details in the contract.

3. Discuss the matter at hand, with members of the staff, and city attorney's staff, before attempting to write the contract.

Mr. Holman supplements the above criteria by the following specific suggestions:

1. Detail precise uses or activities to be permitted and, if possible, those which are forbidden.

2. State exact dates of beginning and termination of contract.

3. State means, if any, for extending the contract.

4. Outline a specific and precise termination procedure.

5. Put down exact method to be followed in surrendering the facility.

6. Include detailed disaster escape clause governing responsibilities of both parties.

7. Establish and outline standards of operation, maintenance (cleanliness), and behavior.

8. Insert specific amounts of money and the means of payment. If percentage payment is used, specify book-keeping and auditing procedures to be followed.

9. Establish responsibility for repairs and alterations—who will make them and what approvals are required.

10. Reserve right of entry and inspection at any time.

11. Define party responsible for utilities, installation, service and payment, such as telephone, gas, electricity, water and sewage.

12. Set standard for personnel to be employed and approvals required, including dismissal procedure for un-

satisfactory employees.

13. If any sales are to be made on the premises, set the standard of prices and means of control of such prices.

14. Specify amounts of insurance to be carried and necessary bonds, particularly performance bonds.

15. Define responsibility for payment of taxes.

16. Establish responsibility for advertising and set general standards for such advertising with whatever approvals are required.

17. Define the latitude permitted for assigning or circulating the basic contract or portion of it and the procedure necessary to be followed.

18. Establish dates for performance and penalties for non-performance.

Where park or recreation authorities lease food and drink facilities on a concession basis they usually receive ten to fifteen per cent of gross sales. Departments operating these services directly, on the other hand, can expect to make twenty to thirty per cent of gross sales, depending upon:

1. Ability of, and effort put forth by, the concession manager.

2. Extent of service provided to low volume operations.

3. Method of depreciating, maintaining, replacing or purchasing new equipment.

4. Volume of business handled in relation to personnel employed.

5. Manner of employment of manager and concession employees.

6. Efficiency and sanitary conditions.

7. Quality merchandise handled and prices charged.

## —Playgrounds for Creative Play—

Facilities and activities as suggested by a German leader at the 1956 International Recreation Congress.

### Liselott Diem

In Germany today we have the same cultural problems as you do. Automation is making fast progress and the natural, physical activities of man are hindered more and more. Commercial entertainment is growing up and enticing us—especially the young people—into passive experiences and "spectatoritis"! Therefore, a demand for the "playground around the corner" (as we say in Germany) has developed in recent years—for a playground easily accessible to everyone, offering something for every age, used all during the year and for any kind of creative play.

What does a creative play area need?

*MRS. DIEM is a leader of Germany's recreation movement, and was a delegate at the International Recreation Congress in Philadelphia last year.*

There are three basic requirements:

1. Because the playground must replace the natural environment lost in cities, it should contain bushes, trees and some water facilities—not just be leveled and cemented. On a hill a natural slide can be constructed, providing a place where the children can run up and slide down; beams for balancing can be laid across ditches, where children can jump in or climb out at will.

One corner of the playground should be saved for self-activated play of eight- to twelve-year-old children.

2. Only apparatus which stimulates creative play, with no complicated mechanism, should be used. Equipment, such as large slides, mechanical swings, a merry-go-round which can be used by only two or three children, while the others passively sit or stand by, is not creative. Also, giraffes or elephants are creative for the architect, but not for

the children! To be creative the child needs simple apparatus, which develops self-activity and stimulates fancy; for example, on simple bars at different heights, perhaps in a corner among the trees, the child can hang and swing around forward and backward, and try to find new variations.

3. Balls, ropes, sticks and other small moving apparatus should be given out free of charge in order to further creative play on the playground. In Berlin, for example, we count on the distribution of small apparatus to develop play-education. The child who returns his small apparatus in good condition, after using it for daily play for some weeks, may receive it as a gift. This is not always possible but it is a good idea.

These three requirements, then, provide an education on the playground—education of the senses—for physical fitness and for moral strength. ■

# NOTES *for the Administrator*

## Teen-Agers at Work

The employment of teen-agers for maintenance work in park and recreation areas during the summer months \* has proved highly satisfactory in Rockville, Maryland, according to the city manager. Taking issue with industry's reluctance to hire teen-agers for summer employment, the city instituted a work program. Among the tasks to which the young people were assigned were the correcting of soil erosion in recreation areas, the clearing of land for new recreation sites, and various other clean-up jobs in the parks. The boys were placed on the regular payroll and paid \$1.00 per hour. The program met with enthusiastic support from the parents, school authorities, and the park department. It not only afforded a means of releasing the excess energy of the young people, but proved of constructive benefit to the city by freeing more experienced men for work demanding higher wages.

## Officials Exceed Authority

In its September 1956 issue, *Minnesota Municipalities* cites a court decision under the following head: "City Held Not Estopped to Claim Land Conveyed to It for Park and Recreational Purposes." Some years ago two tracts of land in Fergus Falls were conveyed to the city with the following restrictions: "It is expressly understood and agreed that the above premises shall be used only for park and for recreational purposes and that they shall not be used for commercial purposes."

In May 1947 a businessman was permitted by the city to move his shop to a site on the tract in question. In fact, city officials gave him a moving permit, supervised the moving of the building, and designated the boundaries of the property he was to occupy. Some time later he began to erect a new structure. After he learned that the land was subject to the limiting condition, he secured from the grantor to the city a quitclaim deed which stated that it was given to release this portion of the tract from the restrictions. When this deed was recorded, this part of the tract was placed on the tax rolls and the businessman subsequently paid taxes on the property.

The city later brought action to recover the property and the state supreme court in 1956 held that the defendant had acquired no rights and the city could maintain its action. "The court followed a well-established rule that estoppel as applied to a municipal corporation cannot grow out of deals with city officials who exceed their authority."

\* Such employment is being tried out in an increasing number of communities. The "workrecreation" program in Berkeley, California, is a case in point.

## Half-Mile Radius

National standards have long suggested that a neighborhood playground should be located within one-quarter to one-half mile of the homes of the people it is intended to serve. A recreation survey of the Rockford, Illinois, Park District in 1955 indicated that children in the Rockford area will not travel further than a half-mile to reach a playground even if leadership service is not given in the area outside a half-mile radius. The study revealed that ninety-five per cent of over three thousand children participating in twelve of the city's supervised playgrounds resided within a half-mile of the playground they attended and approximately seventy-five per cent of them lived within quarter-mile of the playground they attended regularly.

## Multiple-Use Area



Multiple-use area in Dallas, Texas. Note semi-circular paved area outside of backstop, with basketball goal.

The multiple-use area installed in a number of Dallas, Texas, parks is of tennis-court size and partially enclosed. At the four corner posts, lights have been installed for general play (not tennis). At each end, outside the end fence, semicircular paved areas have been provided with a basketball goal erected on the outside of the fence. This permits one-goal basketball play at either end of the area without interfering with tennis or group games.

## Magic Square "120"

Ferndale, Michigan, is promoting the use of a hard-topped area for recreation on the playground which, according to its brochure, offers "recreational and community activities for *all* groups and ages close to . . . home!" This involves a smooth, quick-drying, hard-surface play area, 120 feet square, which permits an uninterrupted planned program of activities throughout the year. It is marked off into a series of courts which can serve for: badminton, basketball, box hockey, dancing, hopscotch, ice skating, kid showers, paddle tennis, roller skating, shuffleboard, tennis or volleyball, and can also be used year-round for day and night concerts, contests and shows.

For full particulars, write to the Ferndale Recreation Advisory Committee, 130 East Nine Mile Road, Ferndale 20, Michigan.

## Liability

According to the Washington State Recreation Society's *Bulletin* for June 1956, the state supreme court ruled that

(Continued on page 154.)

MORE THAN

100,000

U. S. SCHOOLS AND COLLEGES EACH YEAR SPECIFY

America's Finest Sports Equipment by

VOIT®

NEW YORK 11

DANVILLE, ILL. · LOS ANGELES 11

**JUST PUBLISHED!**

**FOLK DANCING—2nd Edition**

**Grace I. Fox and Kathleen Gruppe Merrill.** American square dances and dances of foreign lands widely different in type, geographic distribution, and styles of performance. Colorful new book describes the fundamental steps, presents the step pattern for each measure of the musical score, and details the figures of each call of the square dance. Book gives appropriate musical scores in easy-to-play arrangements and also provides a list of suitable recordings. 25 ills., 20 musical scores. 8½ x 11. **\$3.50**

**ALSO NEW!**

**BOWLING FOR ALL—3rd Edition**

**Joe Falcaro and Murray Goodman.** All the rules and skills of duck pin and tenpin bowling. Discusses in detail: selecting and holding the ball, stance, footwork, approach and deliveries. Relates aim, control, speed, and knowledge of alley conditions to accuracy in hitting pins. Gives full information on the organization and conduct of leagues, teams, tournaments, as well as current official rules and regulations. 59 photos, drawings. 6½ x 10. **\$3**

**From the Ronald Sports List:**

**Baseball Techniques Illustrated**

**Ethan Allen and Tyler Micoleau.** Top-notch coaching advice and numerous action drawings cover every position and play of America's favorite game. 150 ills. **\$1.95**

**Tennis Techniques Illustrated**

**Wynn Mace and Tyler Micoleau.** Describes and graphically illustrates how to play a winning tennis game. Covers fundamentals and strategy of both singles and doubles. 126 drawings. **\$1.95**

**Winning Badminton**

**Kenneth R. Davidson and Lealand R. Gustavson.** Fully details the fundamentals and advanced tactics of badminton. Facts for group instruction, club organization. 146 ills. and photos. 6½ x 10. **\$3**

**Softball for Girls**

**A. Viola Mitchell.** Covers offensive and defensive softball through text, photos, and diagrams. Includes special notes for umpires, simple method of scoring, and suggestions for teaching. 3rd Ed. 55 ills. **\$1.95**

At bookstores or from:

**The Ronald Press Company • 15 E. 26th St., New York 10**

for every  
**RECREATION  
ACTIVITY**

**HI-FI**

sound  
at low cost



**NEWCOMB**

- transcription player
- public address system

For every sound reproduction application in recreation halls, gyms, auditoriums, or summer camps, the Newcomb R-16CV does the job better, yet weighs less than 22 pounds. A separate microphone and phonograph volume control permits mixing recorded music with the microphone presentation. Variable speed control allows variable tempo and pitch (from any basic speed setting). A quality heat and humidity resistant high fidelity ceramic pickup is encased in a professional-type tone arm. Balanced-design amplifier with inverse feedback in combination with a fine ten-inch extended range speaker give quality you'd never expect at its price. Newcomb is the "sound of quality since 1937"... recognized by leading school authorities from coast to coast.



**NEWCOMB VARIABLE SPEED**

Exclusive Newcomb design gives dependable continuously variable control at all 3 speeds.

**FREE CATALOG**

**NEWCOMB**  
Audio Products Co., Dept. Z-4  
6824 Lexington Av., Hollywood 38, Calif.

- Send free catalog of Newcomb portable sound equipment.
- Send name of our nearest Newcomb distributor.

Name \_\_\_\_\_  
Address \_\_\_\_\_  
City \_\_\_\_\_

the city of Seattle was not liable for a fatal skating accident that occurred in a street set aside for winter sledding. In a unanimous five-judge opinion, the court reversed a jury award to the father of two boys, one of whom was killed and the other injured when a sled on which they were riding struck an automobile parked in an area designated for sledding.

The plaintiff contended that the city negligently failed to keep its streets free of obstruction and permitted a nuisance on a public street. Speaking for the court, the judge said, "In the ownership, control and supervision of its streets a municipality acts in its governmental and not in its proprietary capacity and for negligence in the performance of such a function it is immune from liability. There is no statutory duty in this state imposed upon a municipality to keep its streets free from nuisance."

\* \* \* \*

The September 1956 issue of the Wisconsin Recreation Association *Bulletin* includes an oral decision handed down in the circuit court of Manitowoc County, Wisconsin. The case involved an accident which occurred to an individual who was injured by falling near the outrun of a toboggan slide operated by the city of Manitowoc. After the case had been argued at length, the counsel for the city made a

**Watch for —**

the June issue of *Recreation*

with its special emphasis on the problems of encroachment on recreation and park land.

## Handweaver & Craftsman



*New Ideas*  
**PRACTICAL  
PROJECTS**  
for  
**WEAVERS**  
*Of All Ages*  
**IN  
EVERY  
ISSUE**

Single Copies \$1.00

**Published Quarterly — 64 Informative Pages**

*Write today for brochure and prices on back issues.*

A subscription to *Handweaver & Craftsman* and a complete file of back issues will provide you with a live weaving library.

**Handweaver & Craftsman**

DEPT. R, 246 FIFTH AVENUE, NEW YORK 1

Single copy \$1, 1 yr. \$4, 2 yrs. \$7.50, 3 yrs. \$10, 5 yrs. \$15

*Canadian postage 50c year extra, Pan American and foreign \$1*

motion for a nonsuit on the grounds that the "safe place statute" did not apply in the case. After hearing the arguments on the motion, the court held that, inasmuch as the slide was not a public building as defined in the statute and that the slide could not be considered a structure and that the person was not actually injured on the slide itself, the motion for a nonsuit was granted and the complaint was dismissed.

### Recent Experimentation

*Wading Pools.* Recent park developments in Grand Rapids, Michigan, are described by Frederick C. See, superintendent of parks, in the December 1956 issue of *The American City*. Of special interest is the description of the city's wading pools, which explains its experimentation and development of a wading pool that provides safe water without requiring costly recirculation equipment. The Michigan State Health Department and city health department have studied the operation of these pools and, on the basis of daily water analysis reports, have considered the water to be completely safe.

"Here is how our design works," he writes. "First, we adjust the inlet and overflows of the city's seventeen wading pools to completely replenish the water every eight hours. Second, we have developed a special system of applying chlorine to the water which is safe, easy, and does not require skilled help.

"We have designed a small stainless steel box which is set below the water level under the inlet pipe. In this box we place sodium hypochlorite tablets, the number of which has been empirically determined for each pool and which ranges from one hundred to two hundred tablets three times a day. (Grand Rapids' wading pools have capacities that vary from seven thousand to twenty thousand gallons.) When the temperature is below seventy degrees, the application can be cut in half. We supply each park caretaker or attendant with a small inexpensive comparator to use several times a day to see that the chlorine residual does not drop below one part or go over three parts per million. The operation is practically routine, does not require any judgment on the part of the attendant, and has proved to be extremely successful.

"Finally, to reduce ground dirt from being carried into the pools, we have fenced the pools off from surrounding areas, and then within the fenced portions have surrounded them with an eight-foot concrete deck. Furthermore, approaches to the fenced areas are paved with asphaltic concrete."

*Surfacing.* Mr. See also points out that Grand Rapids normally surfaces its apparatus areas by covering six to eight inches of crushed rock or gravel with eight inches of coarse sawdust. Scarcity of tanbark and availability of sawdust has resulted in the use of the latter material. Their experience after four years of constant use of sawdust has been that it causes little, if any trouble. The area dries quickly, weeds do not grow in it and coarse sawdust does not adhere readily to the children's clothing. It provides a resilient surface that requires daily raking and occasionally some replacement. ■

PARKS are the setting for many Recreation Programs.

PARK administration and know-how aid and complement your work.

The PARK and RECREATION picture is a dynamic, changing one.

Only one magazine leads in complete coverage of this field:

- from new products to new presidents of societies
- from how to put a bond issue across to the latest SWIMMING POOL data and design.

Join our family of over 14,000 readers who use PM as their working tool.

Send your purchase order to:

**PARK MAINTENANCE**

Dept. R

P. O. Box 409

Appleton, Wisconsin

One year—\$3.00 Three years—\$7.50

Groups of five or more, one year—  
\$2.00 per person.

# GOOD CRAFTS

## Make Better RECREATION Programs

Build your recreational programs around Cleveland Crafts projects. Every order is given immediate attention and prices are exceedingly low . . . especially on quantity orders. Freight allowances are made on all orders over \$50.

Write For Your Free Catalog of Handicraft Supplies

CATALOG ILLUSTRATES AND DESCRIBES HUNDREDS OF CRAFT PROJECTS, HARD TO RESIST, FOR YOUR RECREATIONAL PROGRAMS.

## CLEVELAND CRAFTS COMPANY

4705 EUCLID AVE.  
CLEVELAND 3, OHIO

34 ELMWOOD PARKWAY  
(ELMWOOD PARK) CHICAGO 35, ILL.

# LOOP TENNIS

## CHAMPION OF PLAYGROUND GAMES

It's tops in popularity among all ages!

Biggest value for your money because of low cost, constant use, small space required, no hazards, tremendous appeal to skilled and unskilled alike, and both social and organic values.

ORDER YOUR SET TODAY!

D. R. M. LOOP TENNIS COMPANY, INC.

P. O. Box 481

Tallahassee, Florida

THESE  
FAMOUS NAMES  
*Testify*  
to its  
PERFORMANCE



## LOUISVILLE SLUGGER BATS

Gus Bell "Seip" Rosen  
Mickey Vernon  
Mickey Mantle

George "Babe" Ruth  
Rochie Calkburn  
Ed "Duke" Sinden  
Al Schoendienst

GENUINE  
Mickey Mantle  
LOUISVILLE SLUGGER

Yogi Berra

Ted Williams  
Ted Lenzowski

Ernie Banks

**Look**  
for the famous  
oval trade-mark  
on the bat  
you buy...

Bobby Avila

Jackie Robinson

Stan Hack  
Al Kaline  
"Pee Wee" Reese

Nelson Fox  
Ed Mathews  
Harvey Kuenn

## Join Forces for Better Training

William H. Radke

*How a group of suburban recreation directors cooperated in preparing for their playground seasons.*

WHEN SEVERAL heads get together many things can happen—some of them good! For example, an interesting training idea was born in January 1956 at a meeting of the Chicago West Suburban Recreation Directors Group, which represents seven suburbs with a year-round recreation program. Members discovered that each community director was planning a pre-summer training program for his summer staff. It was suggested, therefore, that they combine their training efforts. They unanimously



The group is addressed by Ray Duffy of American Red Cross on safety.

agreed, and decided to invite Gunnar Peterson, assistant professor of camping and recreation at George Williams College, in Chicago, to the next meeting for a discussion of such a training program and to determine what outside help he might be able to provide. Lilly Ruth Hansen, director at Oak Park, Illinois, gave an on-the-spot invitation to hold the training sessions in one of her playground shelters.

In February, Professor Peterson attended the West Suburban meeting, primed with suggestions. In forty-five minutes the suburbanites had laid out a rough but complete schedule. Professor Peterson promised to polish it and offer

MR. RADKE is recreation superintendent in Brookfield, Illinois.

suggestions. During the following month and many ideas later, the group reconvened and drafted the final versions of a playground leaders' workshop that never could have been possible in any one community.

It was all done for a dollar a day! Two-and-a-half days of training for a \$2.50 fee from each registrant provided the budget, and the recreation departments picked up the tabs. In fact, some trainees were on a pay basis while attending. Leadership for the sessions was drawn from the department heads of the various communities who covered specialized phases of the training program, and from the police and Red Cross. College personnel also proved invaluable in the various sessions. About half of the seventy-five persons attending were doing recreation work for the first time. Information from the session speakers, plus the chance to talk among themselves, proved heartening and stimulating to the beginners. To the old hands it was an excellent review coupled with many new ideas and theories.

Professor Peterson chaired the conference on a non-lagging basis. Workshopers brought their lunches each day to insure time for bull-session discussions without leaving the area. Staff members from some communities utilized the generous lunch periods for meetings.

Training content covered a wide variety of subjects, touching only the highlights to be sure, but with ample time for general questions. Among topics were: "Simple Games for Use as Ice-Breakers"; "Objectives and Philosophy that Undergird Our Work Together"; "Playground Equipment and Safety Rules"; "Relations with Police"; "Public Relations"; "Stories and Creative Dramatics"; "Rainy and Hot Weather

Programs"; "Get Acquainted Programs"; "Registration and Attendance Forms"; "Business Records and Program Records Individual Community Programs"; "What are We Trying to Accomplish through Our Crafts Program?"; "Nature Lore, Campcraft Outdoor Living"; "Age Groupings and Developmental Levels, Including the Teen-Agers"; "Interplayground Competition"; and others.

The value of this type of training session will be recognized by almost any



Professor Peterson gives a cooking demonstration on homemade grill

professional recreation person; but, in addition, the fact that this was a cooperative venture brought to it a richness of experience and of program not always possible in the smaller meetings. It enlarges local thinking, as well as acquainting workers with problems to be anticipated and how to deal with them.

"How can I use this? We are not a suburban community!" That's what you're asking, isn't it? Without exception, the members of the Chicago West Suburban Recreation Directors Group feel that the training value would justify a fifty-mile trip—in each direction if necessary. This sort of training aid, and that's what it is, can be used anywhere in the country. With one town as a hub it can branch fifty miles in every direction; that's a circle with a hundred miles



diameter. In almost any such circle can be found at least four, or more, communities with recreation programs. Check your map.

Nearby schools and colleges will be glad to help. The National Recreation Association will help, too. We owe it to our communities and our profession to put on the best program we know how. These cooperative training sessions will iron out many rough spots and provide a vast contribution to the morale and self-assurance of the recreation workers in your area. Why don't you try it? ■

### ANNUAL CAREER DAY

The Seventeenth Annual Career Day at the Marlboro, Massachusetts, High School was devoted to "Careers and Leisure Time Activities." The keynote address, "Careers and Opportunities in Recreation," was given by John P. Cronin, director of recreation in Providence, Rhode Island. The basic theme of the program was "recreation" and covered fields of social service, artistic interests, personality, entertainment, hobbies, outdoor activities, music, sports, therapy, physical fitness for

both men and women, boating, sailing and water sports.

Other recreation personnel taking part were: Richard E. Ready, director of recreation, Norwood; William F. Ryan, director of recreation, Quincy; and Sally Randall, supervisor of girls and women's activities, Arlington, all Massachusetts. The program was under direction of Dr. Robert A. Dolan, director of guidance in the Marlboro public school and Louis F. Ghiloni, director of recreation, Marlboro.

## Playground Summer Notebook for 1957

CIRCLES OF FRIENDSHIP



NEIGHBORHOOD • HOME • PLAYGROUND

Twelve bulletins, full of new ways to build bridges between home, neighborhood and playground. Order from the National Recreation Association, 8 West Eighth Street, New York 11, New York. \$2.50 (\$2.00 for NRA members). Available May 1.

## ENGRAVING FREE!

On All Trophies Purchased From

*National*

SAVINGS OF

**20% to 40%**



TROPHIES • MEDALS • PLAQUES FOR ALL SPORTS AND EVENTS

FREE CATALOG

*National* TROPHY SALES, INC.

75 W. Van Buren St.

Chicago, Illinois

HELP WANTED • POSITIONS WANTED • SERVICES AVAILABLE • WORKSHOPS & CONFERENCES • EDUCATIONAL OPPORTUNITIES • ITEMS FOR EXCHANGE

## .....CLASSIFIED ADVERTISING.....

RATES: Words in regular type \$.15 each  
Words in boldface type \$.25 each  
Minimum ad accepted ... \$3.00

COPY: Type — or clearly print — your message and the address to which you wish replies sent. Underline any words you want to appear in boldface type.

DEADLINES: Copy must be received by the fifth of the month preceding date of the issue in which ad is desired.

Send copy with remittance to:

RECREATION Classified Advertising, 8 West Eighth Street, New York 11, New York.

### HELP WANTED

Group Workers. Master's Degrees in group work, education, recreation preferred. Will train promising B.S. graduates. National organization serving teen-age youth. Starting salary range \$4500 to \$5500 depending upon training and experience. Send complete resume to B'nai B'rith Youth Organization, 29 Vermont Avenue, Washington 9, D. C.

Counselors, men and women. Openings at N. Y. State private co-educational camp for general and specialty counselors. 8-week season from July 1. Salary dependent upon qualifications, plus room and board. Write for application, Camp To-Le-Do, 102-18 64th Avenue, Forest Hills, N. Y.

Teachers Wanted. Physical Education. Experienced start to \$6000. Beginners to \$4450. No registration fee. Write for application. City Suburban Agency, 550 Fifth Avenue, N. Y. C.

Black Hills Boys' Ranch. Counselors and camp agents for small western camp. W. E. Derr, Director, Piedmont, South Dakota.

Overseas Tour Leader or Camp Crafts Counselor. Summer or longer. Experienced with teen-agers and emotionally disturbed children; creative crafts, mental therapy. Ida Fisch, 1902 East 18th Street, Brooklyn 29, New York.

### EDUCATIONAL OPPORTUNITIES

Handweaving instruction now, all crafts during summer. Open House—April 27th and 28th. Black Creek Crafts School, Sussex, N. J., R. D. #2.

### POSITIONS WANTED

Recreation Director & Golf Coach desires position in Westchester nearby Connecticut. Ten years experience in all phases of recreation. Will accept summer position as Golf Coach. Write to Director, 597 Fairfield Avenue, Stamford, Conn.

### WORKSHOPS & CONFERENCES

NRA New England District Recreation Conference—May 26-29—at Poland Spring House, Poland Spring, Maine. For information, write: Waldo Hainsworth, District Representative, Fowler Road, Northbridge, Mass.

IMPORTANT: REMITTANCE MUST ACCOMPANY ORDER.

# Books & Pamphlets Received

ART OF OFFICIATING SPORTS, THE (Second Edition). John W. Bunn. Prentice-Hall, Englewood Cliffs, New Jersey. Pp. 388. \$6.35.

BIRD BIOGRAPHIES OF JOHN JAMES AUDUBON, THE, Alice Ford, Editor. The Macmillan Company, 60 Fifth Avenue, New York 11. Pp. 282. \$10.00.

BLUE-RIBBON PLAYS FOR GRADUATION (One-act royalty-free plays), Sylvia E. Kamerman, Editor. Plays, Inc., 8 Arlington Street, Boston 16. Pp. 202. \$3.50.

COMMUNITY EDUCATION IN WORLD AFFAIRS, William C. Rogers. University of Minnesota Press, Minneapolis 14. Pp. 86. Paper \$1.25 each; (five or more, \$.75 each, plus postage.)

CONTRACT BRIDGE: HOW TO PLAY IT, Ewart Kempson. Emerson Books, 251 West 19th Street, New York 11. Pp. 164. \$2.50.

DIRECTORY OF CAMPS, 1957. American Camping Association, Bradford Woods, Martinsville, Indiana. Pp. 249. \$.50.

EDUCATORS GUIDE TO FREE TAPES, SCRIPTS, AND TRANSCRIPTIONS, 1957. Educators Progress Service, Randolph, Wisconsin. Pp. 184. Paper \$5.75.

FIRST AID AND CARE OF SMALL ANIMALS, Ernest P. Walker. Animal Welfare Institute, 22 East 17th Street, New York 3. Pp. 45. \$.25.

FOUR-STAR PLAYS FOR BOYS (Fifteen royalty-free, one-act plays for all-boy casts), A. S. Burack, Editor. Plays, Inc., 8 Arlington Street, Boston 16. Pp. 237. \$3.50.

GROUP GAMES FOR GIRLS AND WOMEN. American Association for Health, Physical Education, and Recreation. 1201 Sixteenth Street, N.W., Washington 6, D. C. Pp. 32. \$.50.

HANDBOOK FOR LEADERS OF ORGANIZATIONS, compiled by Elizabeth T. Halsey. Carrie Chapman Catt Memorial Fund, 461 Fourth Avenue, New York 16. Pp. 64. \$.25.

HANDWEAVER'S WORKBOOK, A, Heather G. Thorpe. The Macmillan Company, 60 Fifth Avenue, New York 11. Pp. 179. \$4.50.

SPORTS FILM GUIDE. The Athletic Institute, 209 South State Street, Chicago 4. Pp. 76. Paper \$1.00.

TIPS FROM THE TOP (Book 2: 52 More Golf Lessons by the Country's Leading Pros from *Sports Illustrated*), compiled by Herbert Warren Wind. Prentice-Hall, Englewood Cliffs, New Jersey. Pp. 105. \$3.95.

TREASURY OF AMERICAN INDIAN TALES, Theodore Whitson Ressler. Association Press, 291 Broadway, New York 7. Pp. 310. \$3.95.

UNDERWATER WORLD, THE, John Tassos. Prentice-Hall, Englewood Cliffs, New Jersey. Pp. 242. \$4.95.

WE LIVE FOR HIM (An Easter Service for the church school), Effie Sandstrom Jorgenson. Augustana Press, Rock Island, Illinois. Pp. 16. \$1.00 each; \$1.00 per dozen.

YEAR OF YOUNG PEOPLE'S PROGRAMS, A (For church groups), Wally and Esther Howard. Moody Press, 820 North La Salle Street, Chicago 10. Pp. 64. Paper \$.75.

## INDEX OF ADVERTISERS

|                                         | PAGE               |
|-----------------------------------------|--------------------|
| All Metal Tennis Table Company          | 127                |
| American Playground Device Company      | Inside Front Cover |
| Association Press                       | Inside Front Cover |
| The J. E. Burke Company                 | 127                |
| California State Personnel Board        | 123                |
| Peter Carver Associates                 | Inside Front Cover |
| Cleveland Crafts Company                | 155                |
| The Copper Shop                         | 123                |
| D. R. M. Loop Tennis                    | 155                |
| Dayton Racquet Company                  | 123                |
| Dimco-Gray Company                      | 127                |
| Films, Inc.                             | 113                |
| Handweaver & Craftsman                  | 154                |
| Hillerich & Bradsby                     | 155                |
| Hillyard                                | 121                |
| Hoppy Taw Corporation                   | 159                |
| Jamison Manufacturing Company           | 144                |
| Jaytro Athletic Supply Company          | 144                |
| The MacGregor Company                   | Inside Front Cover |
| McGraw-Hill Book Company                | 159                |
| Monroe Company                          | 144                |
| National Studios                        | 114                |
| National Trophy Sales                   | 157                |
| Newcomb Audio Products Company          | 153                |
| New York University School of Education | 127                |
| Nissen Trampoline Company               | 123                |
| Park Maintenance                        | 155                |
| Rawlings Sporting Goods Company         | 159                |
| The Ronald Press Company                | 153                |
| James Spencer & Company                 | 144                |
| Square Dance Associates                 | 127                |
| Superior Industries Corporation         | 144                |
| Voit                                    | 153                |
| X-acto, Inc.                            | 123                |

HI-FI EQUIPMENT YEARBOOK, 1957. Sanford M. Herman. Editor. Herman and Stephens, 200 East 37th Street, New York 16. Pp. 127. Paper \$1.95; cloth \$2.75.

HOME AQUARIUM HANDBOOK, Griffith and Lillian Borgeson. Arco Publishing Company, 480 Lexington Avenue, New York 17. Pp. 143. \$2.00.

HOUSE FOR MARVIN, A (One-act play about discrimination in housing), Darius Leander Swann. Friendship Press, 257 Fourth Avenue, New York 10. Pp. 40. \$.50.

HOW TO MAKE MONEY WITH CARNIVAL GAMES, Theron Fox. Rosicrucian Press, 50 Notre Dame Avenue, San Jose 6, California. Pp. 143. Paper \$2.00; cloth \$3.00.

HOW TO SURVIVE ON LAND AND SEA (Second Revised Edition). U. S. Naval Institute, Annapolis, Maryland. Pp. 368. \$4.00.

PLANNING THE GOLF CLUBHOUSE, Harold J. Cliffer. National Golf Foundation, 407 S. Dearborn Street, Chicago 5. Pp. 96. \$9.00.

ROUND-THE-YEAR PLAYS FOR CHILDREN (Thirty-five royalty-free plays for all occasions), Alice Very. Plays, Inc., 8 Arlington Street, Boston 16. Pp. 279. \$3.50.

SING TOGETHER—A Girl Scout Songbook (1957 Edition), Girl Scouts of the U.S.A., 155 East 44th Street, New York 17. Pp. 127. \$.50.

## Magazine Articles

ADULT LEADERSHIP, *March 1957*  
Adult Education and Intergroup Relations, *Martin P. Chworowsky* and *Hans B. C. Spiegel*.

Hints on How to Attend a Conference, *Blue Carstenson*.

ARTS AND ACTIVITIES, *February 1957*  
Paper Sculpture That Sells, *Lucille H. Jenkins*.

GIRL SCOUT LEADER, *March 1957*  
Campsite Crafts, *Corinne M. Murphy*.  
Conservation in Camps, *Sue Hammack*.

INDUSTRIAL SPORTS AND RECREATION, *November 1956*  
Boys and Girls Together, *Oskar Frowein*.

—, *December 1956*  
Having Fun After Sixty, *Robert Peterson*.

—, *January 1957*  
Recreation Goes Downhill—On Ski Slopes, That Is, *Oskar Frowein*.

JOURNAL OF HEALTH, PHYSICAL EDUCATION, RECREATION, *February 1957*  
Highlights of the Conference on Professional Preparation of Recreation Personnel, *John L. Hutchinson*.

Suburban School-Community Recreation, *Thomas S. Yukie*.

PARK MAINTENANCE, *February 1957*  
Annual Swimming Pool Issue.

SWIMMING POOL AGE, *February 1957*  
Improved Business Procedures for the Municipally Operated Pool.

★ **Outstanding**   
**McGRAW-HILL Books**  
**in Recreation**

**INDUSTRIAL RECREATION**  
*A Guide to Its Organization and Administration*  
 By **JACKSON M. ANDERSON**, American Association of Health, Physical Education and Recreation, National Industrial Recreation Association.  
*McGraw-Hill Series in Health Education, Physical Education, and Recreation.*  
**304 pages, \$5.00**

The first complete book on the increasingly important subject of industrial recreation. It is intended as a guide to recreation directors in administering employee recreation programs, and for those who wish to study the organization and administration of such a program. In addition to specific recommendations on planning and initiating a program, its activities, leadership and financing, there is a thorough discussion of the history of employee recreation and its benefits to industrial relations.

**INTRODUCTION TO COMMUNITY RECREATION**  
 By **GEORGE D. BUTLER**  
*McGraw-Hill Series in Sociology and Anthropology.*  
**Second Edition • 548 pages, \$6.00**

The second edition of this popular book deals with those forms of recreation which require a large degree of organization and leadership, and in which participation plays an important part. Recreation is considered as a function of local government. All aspects and phases of community recreation are presented, with recent developments included. Recreation is analyzed and a comprehensive bibliography is offered to facilitate reference work. It is a well-organized text, without a peer in the field of community recreation.

**USE THIS COUPON**

COLLEGE DEPARTMENT, McGRAW-HILL BOOK COMPANY, Inc.  
 330 West 42nd Street, New York 36, N.Y.

Please send me, on approval, a copy of the book(s) checked below. I agree to pay for the book(s) upon receipt of invoice or return the book(s) within 10 days.

INDUSTRIAL RECREATION  
 INTRODUCTION TO COMMUNITY RECREATION

Name.....  
 Address.....  
 City..... Zone..... State.....  
 Title.....  
 Affiliation..... R457

**McGraw-Hill BOOK COMPANY, INC.**  
 330 West 42nd Street, New York 36, N.Y.

*Superior By Every Comparison!*



So sensationally better are they on every count—design, construction, quality, durability and play-ability—that Rawlings HERCULITE Rubber-Covered Athletic Balls have established a new high standard. They're in a class by themselves—they're...

*"The Finest In The Field!"*

• VOLLEY BALLS • BASKETBALLS  
 • SOCCER BALLS • FOOTBALLS

RAWLINGS SPORTING GOODS CO. • St. Louis • Los Angeles • Dallas • Chicago

*Hop-Hop-Hop your way to Hoppy Taw Day*  
**AUG. 17TH**

*National HOPSCOTCH TOURNAMENT*

*Winner receives*

- 1 10 day free trip to HOLLYWOOD
- 2 Appearance with Art Linkletter
- 3 A tour of DISNEYLAND
- 4 A ride in a HELICOPTER
- 5 Round trip flight on DC-7 by United Airlines

**BE ON TV with ART LINKLETTER**

*Contest Rules*

- Must be under 14 years of age and attend public school or recreation center
- Must be the winner of local Hoppy Taw tournament
- Must send one Hoppy Taw card with full name and address —plus name and address of school or recreational center, and name of instructor or teacher

For complete details write to:  
 TOURNAMENT DEPARTMENT, HOPPY TAW CORPORATION  
 927 South State Street, Salt Lake City, Utah

# NEW

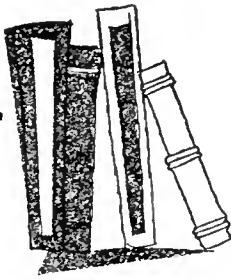

# PUBLICATIONS

*Covering the Leisure-time Field*

## Theatre Scenecraft \*

Vern Adix. Children's Theatre Press, Anchorage, Kentucky. Pp. 309. \$6.50.

*Theatre Scenecraft* isn't an "easy" book because stagecraft isn't easy. However, a novice could, with this book in hand, build, light and dress a set. Vern Adix has put it all down. He tells you where to find a special nail that may not be in every hardware store. He tells you how to get the color you want in a sure fashion without resorting to "pour in a little black to make it darker." He has added to each page clear sketches that illuminate the text. If you must work without the supervision of one trained to stagecraft, this book will see you through.—*Mary Ellen Hilliard, Adelphi College Children's Theatre, Garden City, New York.*

## Creative Crafts For Campers \*

Catherine T. Hammett and Carol M. Horrocks. Association Press, 291 Broadway, New York 7. Pp. 432. \$7.95.

Expensive? Not when you get around a hundred and seventy-five suggestions for arts and crafts, a hundred of which have detailed, step-by-step directions explained clearly in words and sketches.

This is no "off-the-top-of-the-head" book. Every project has been chosen carefully for its value and suitability for use in modern camp programs. These are crafts to round out and fulfill the objectives of camping.

The organization of this book follows the pattern of *The Camp Program Book*, which Miss Hammett co-authored with this reviewer. The first section is short, giving an over-all picture of the place and importance of arts and crafts in the camp setting, the objectives, leadership required and facilities needed.

From there on, the book becomes an instruction book. Section Two deals with the major art and crafts areas, with full, detailed text and illustrations. Section Three deals with arts and crafts projects specifically related to other camp activities and providing opportunities for correlation in the program.

For added value, each chapter is followed by a carefully selected list of

references, and the book contains not only a most detailed table of contents but also an index.

Those who know Miss Hammett (and who in the field of camping does not?) will find here her direct, uncluttered approach, each technique explored thoroughly and developed not only to give the best possible experiences to the campers, but also to maintain the highest possible camp program standards.

Carol Horrocks brings her rich experience as art teacher in Providence, Rhode Island, and as handcraft counselor at Camp Hoffman, Rhode Island, for the past seven years, to make the detailed sketches and instructions accurate, attractive and usable.

This book is an absolute *must* for all camp libraries. Recreation departments and craft leaders at playgrounds or indoor centers will also find it a very valuable addition to their resource library.—*Virginia Musselman, NRA Program Service.*

## How to Make Shapes in Space

Toni Hughes. E. P. Dutton & Company, 300 Fourth Avenue, New York 10. Pp. 217. \$4.95.

The author of this fascinating book, designed for parents, teachers, recreation leaders, art students and display designers, tells us that "no idea is as good from the point of view of fun as the one that you make up yourself."

With this assurance to inspire you, and very simple technical instructions as well as explicit diagrams and photographs to guide you, start with the book's seven basic methods, and eventually you will produce variations of your own. Learn to transform flat materials into three-dimensional party decorations, masks, greeting cards, holiday ornaments and favors, animals, toys, posters, mobiles and abstract constructions.

The book has an irresistible quality that will captivate you, so prepare your scissors, hole puncher, hand stapler and an assortment of papers—news-paper, brown paper, magazine covers,

\* Available from NRA Recreation Book Center, 8 West Eighth Street, New York 11, N. Y.

old sheet music, last year's Christmas wrappings, wallpaper, and so on and start right in. Learn the seven departing points called by the author: the pleat, strip, one continuous cut, related cuts, take away, add to, and slits—then follow all the variations in the book. Later you can exercise endless ingenuity in the variety of materials you utilize and ideas you create.

The author's experiences with displays for children's exhibitions, department store windows and specialty houses are well illustrated. Sources are given for purchasing materials and tools other than those which you can salvage.—*Shirley Silbert, instructor in arts and crafts, Extension Division, City College, New York City, and author of Craft Workit.*

• Note from Program Editor: Miss Silbert is a craft specialist and knows what she's talking about. As a layman whose scissor work never got much beyond the paper-doll stage, may I add, however, that this book is so fascinating I bought myself a personal copy, even though we have the book in the NRA library.

## Singing Games and Dances \*

David S. McIntosh, Editor. Association Press, 291 Broadway, New York 7. Pp. 110. \$3.00.

Leaders of children and young people would do well to include in their repertoire some of the traditional games and dances which are part of our heritage.

Although such activity might not have been labeled "social recreation" many years ago, it was truly social in nature with drama, humor and opportunities to "shine." The material was collected mainly from Southern Illinois, but the book is not too regional, and would be enjoyed by young people anywhere.

The author has arranged his material according to formations; for example, single circle games, contra or longways, double circle, square sets and triple circles. He has also indicated the age group for which each game or dance is best suited. The descriptions are clear, and none are too complicated or difficult.

It is particularly useful for leaders who do not have a piano or record player as standard equipment, because the tunes can be sung as the game or dance is performed. Playground leaders, especially, should have this book, for we need more dancing and singing in our summer programs. Almost all the material is new; you will not find it in other books.—*Helen M. Dauncey, Katherine F. Barker Memorial Secretary for Women and Girls, NRA.* ■

# Recreation Leadership Courses

Sponsored by the National Recreation Association  
and  
Local Recreation Agencies

April, May and June, 1957

|                                                                       |                                                                    |                                                                                                                  |
|-----------------------------------------------------------------------|--------------------------------------------------------------------|------------------------------------------------------------------------------------------------------------------|
| HELEN M. DAUNCEY<br>Social Recreation<br>and<br>Playground Recreation | Sherman, Texas<br>April 8-11                                       | Mrs. Ralph Day, Assistant Professor of Physical Education, Austin College                                        |
|                                                                       | York, Pennsylvania<br>June 17-18                                   | Mrs. Sylvia C. Newcombe, York Recreation Commission, 32 W. King                                                  |
|                                                                       | Lancaster, Pennsylvania<br>June 19 and 20                          | Albert E. Reese, Director of Recreation, 135 N. Lime                                                             |
|                                                                       | University of New Hampshire<br>Durham, New Hampshire<br>June 24-27 | Miss Patricia L. Olkkonen, Recreation Specialist                                                                 |
| RUTH G. EHLERS<br>Social Recreation<br>and<br>Playground Recreation   | New York City<br>April 1                                           | Miss Maxine Keith, Executive Director, Girls Club of America, Inc., 130 Maple Street, Springfield, Massachusetts |
|                                                                       | State of Vermont<br>May 6-16                                       | Mrs. A. O. Brungardt, Vermont Director of Recreation, Montpelier                                                 |
|                                                                       | Kingsport, Tennessee<br>May 20-23                                  | W. C. McHarris, Director of Recreation                                                                           |
|                                                                       | Reading, Pennsylvania<br>June 5-7                                  | John W. Wise, Director, Recreation Board of Berks County, Court House                                            |
| GRACE WALKER<br>Creative Recreation                                   | Toledo, Ohio<br>June 10-13                                         | Arthur G. Morse, Division of Recreation, 214-18 Safety Building                                                  |
|                                                                       | Pittsfield, Massachusetts<br>June 17-20                            | Vincent J. Hebert, Superintendent, Department of Parks and Recreation, 874 North Street                          |
|                                                                       | Fort Wayne, Indiana<br>April 4 and 5                               | Mrs. Anne B. Hogan, Consultant, Psychiatric Social Work, United Chest-Council, 202½ W. Wayne Street              |
|                                                                       | Youngstown, Ohio<br>May 18                                         | Miss Sally Davis, 1202 East Indianola Avenue                                                                     |
|                                                                       | Montgomery, Alabama<br>June 4-8                                    | William L. Brannon, 1001 Tuscaloosa Street                                                                       |
| FRANK A. STAPLES<br>Arts and Crafts                                   | Great Falls, Montana<br>June 10-23                                 | Miss Margaret Bucher, Director of Education, Montana Farmers Union, Box 2089                                     |
|                                                                       | Toledo, Ohio<br>June 10-13                                         | Arthur G. Morse, Division of Recreation, 214-18 Safety Building                                                  |
|                                                                       | Altoona, Pennsylvania<br>June 15                                   | Stuart E. Nolan, Assistant Superintendent of Recreation, Park and Recreation Board                               |

Attendance at training courses conducted by National Recreation Association leaders is usually open to all who wish to attend. For details as to location of the institute, contents of the course, registration procedure, and the like, communicate with the sponsor of the course as listed above.

Miss Dauncey will conduct recreation leadership courses for the United States Air Force in Europe April 22 through May 31.

Miss Walker will attend the Northland Recreation Leaders Laboratory in Minnesota, April 24 through May 2.

Mr. Staples will conduct arts and crafts courses at air bases in the following areas beginning April 1st. For further information write directly to the Air Force Regional Representatives listed:

|                |                        |                                                            |
|----------------|------------------------|------------------------------------------------------------|
| April 1-18     | Southwest Area         | Raymond C. Morrison, 248 Casa Blanca, Fort Worth, Texas    |
| April 22-26    | Pacific Northwest Area | Howard Beresford, 3055 Bellaire, Denver 7, Colorado        |
| April 29-May 9 | Pacific Southwest Area | Linus L. Burk, 1345 Lincoln Avenue, San Rafael, California |
| May 13-June 6  | Midwest Area           | Howard Beresford, 3055 Bellaire, Denver 7, Colorado        |

# June is National Recreation Month

*for everybody*

Tell your community about it  
Hold open house at parks and centers  
Offer new adventures in recreation

L  
I  
V  
E  
  
A  
L  
L  
  
Y  
O  
U  
R  
  
L  
I  
F  
E



*For suggestions write*

**NATIONAL RECREATION ASSOCIATION**

8 West 8th Street, N. Y. 11, N. Y.

# Recreation

Henry A. Fisher Library  
MacMurray College  
Jacksonville, Illinois

MAY 16 1957

NATIONAL RECREATION ASSOCIATION

MAY 1957 • 50c

Printed by Illinois State

**CHOOSE  
THE BATS**

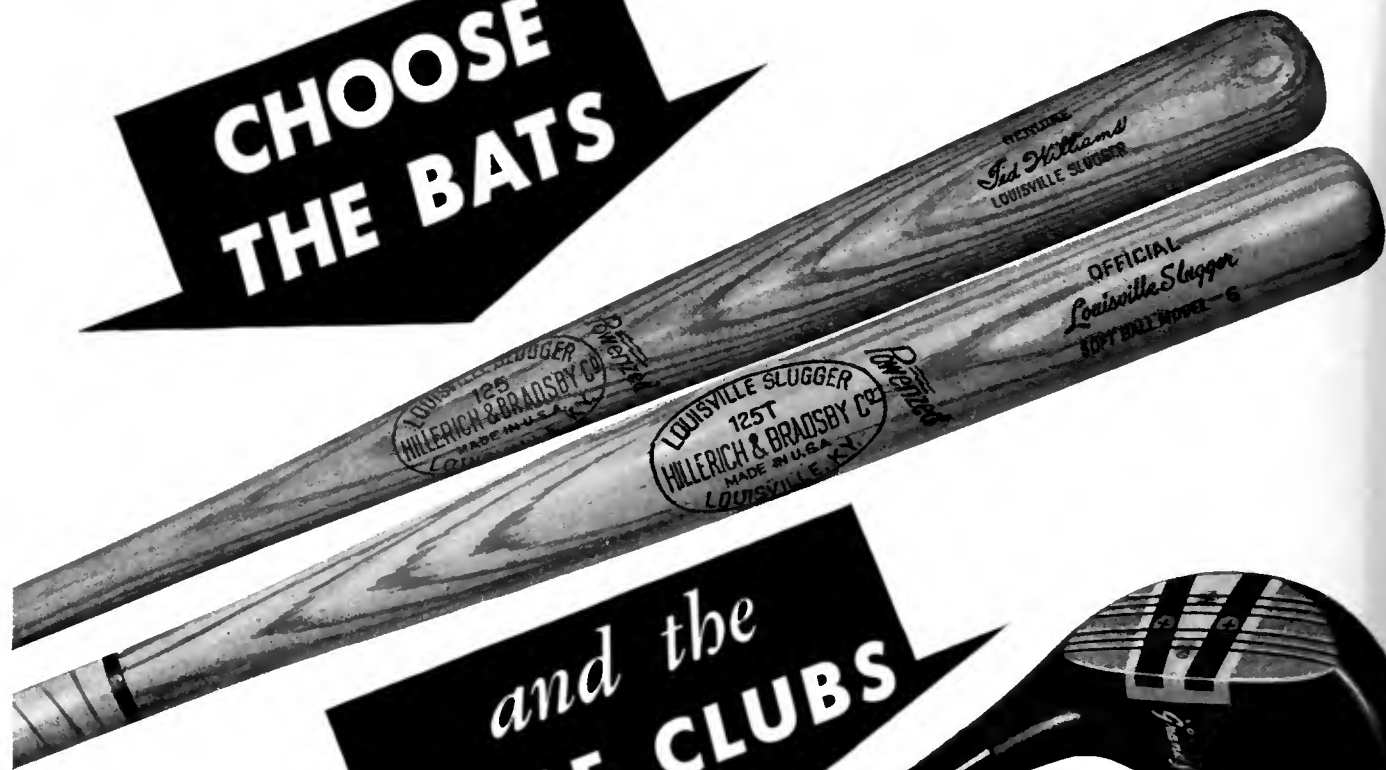

*and the*  
**GOLF CLUBS**



**THAT PACK  
THE POWER**

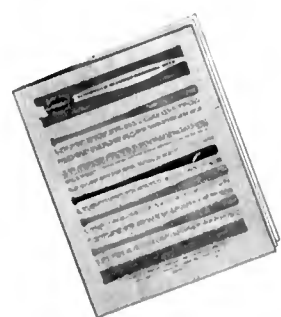

**LOUISVILLE SLUGGER  
BATS  
HILLERICH & BRADSBY CO.  
— — —  
LOUISVILLE, KY.**

**Louisville  
GRAND SLAM  
Golf Clubs**

*We will be glad to send you copies of the 1957 Louisville Slugger Bat and Grand Slam Golf Club Catalogs for your ready reference in ordering from your dealer. Address Hillerich & Bradsby Company, Dept. R-7.*

**HILLERICH & BRADSBY CO., INC., Louisville 2, Ky.**



**check!**

before you make  
the move to.....

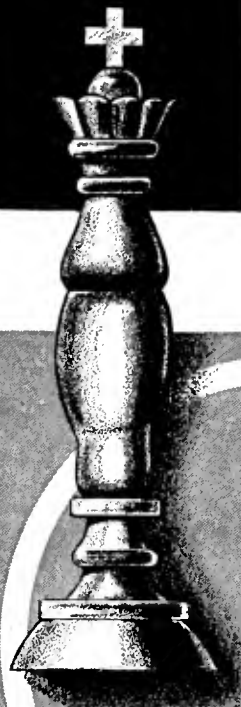

# wide lanes\*



Hillyard has a complete plan for changing over from narrow lane to wide lane markings economically, without re-finishing the entire floor. If you are going to re-mark or re-finish your floor, get Hillyard expert advice and step-by-step plans before you start—they make your job much simpler and easier, cut the cost materially.

There are national rules governing the marking of the broken arcs of the free throw circles. Hillyard has developed a new Lining Template which makes it easy for you to lay out perfect free throw circles as required by the new official rules.

Without this handy tool, it's next to impossible to compute exact distances around the circle for the line and space segments of the dotted lines.

*Free*

**FROM YOUR HILLYARD "MAINTAINER®"**

THESE HILLYARD HELPS, ALL FREELY AVAILABLE:

**NEW HILLYARD E-Z MARKER** for marking broken line of circle. Makes Wide Lane Markings Easy. Complete instructions for use printed on the back.

**UP-TO-DATE Gym Blueprint Folder**, with complete, detailed instructions for laying out, marking, finishing and maintaining a "Basketball Floor for Champions".

**POPULAR "How to Plan Your Gym" Folder**, for sports other than basketball.



**MAIL THIS COUPON TODAY**  
**HILLYARD St. Joseph, Mo.**

- I'm going to re-mark my floor. Please have the Hillyard Maintainer give me a FREE Lining Template.
- I'm going to re-finish my floor. Please send me FREE Blueprint and "How to Plan" Folders.

Name.....  
Institution.....  
Address.....  
City.....State.....



**ST. JOSEPH, MO.**  
**SAN JOSE, CALIF.**  
**PASSAIC, N. J.**

Branches in Principal Cities



DEPT. P-6

# NATIONAL RECREATION ASSOCIATION

*A Service Organization Supported by Voluntary Contributions*

JOSEPH PRENDERGAST, *Executive Director*



## OFFICERS

|                    |                       |
|--------------------|-----------------------|
| PAUL MOORE, JR.    | First Vice-President  |
| SUSAN M. LEE       | Second Vice-President |
| GRANT TITWORTH     | Third Vice-President  |
| ADRIAN M. MARRIE   | Treasurer             |
| JOSEPH PRENDERGAST | Secretary             |

## BOARD OF DIRECTORS

|                         |                      |                        |                     |
|-------------------------|----------------------|------------------------|---------------------|
| F. W. H. ADAMS          | New York, N. Y.      | MRS. NORMAN HARROWER   | Fitchburg, Mass.    |
| F. GRECC BEMIS          | Boston, Mass.        | MRS. CHARLES V. HICROX | Michigan City, Ind. |
| MRS. ROBERT WOODS BLISS | Washington, D. C.    | SUSAN M. LEE           | New York, N. Y.     |
| MRS. ROLLIN BROWN       | Los Angeles, Calif.  | FREDRIC R. MANN        | Philadelphia, Pa.   |
| HOWARD H. CALLAWAY      | Hamilton, Ga.        | HENRY W. MEARS         | Chicago, Ill.       |
| HODDING CARTER          | Greenville, Miss.    | WILLIAM C. MENNINGER   | Topoka, Kan.        |
| MRS. ARTHUR G. CUMMER   | Jacksonville, Fla.   | CARL F. MILLIEN        | Anguata, Me.        |
| HARRY P. DAVISON        | New York, N. Y.      | PAUL MOORE, JR.        | Jersey City, N. J.  |
| GAYLORD DONNELLY        | Chicago, Ill.        | MRS. RUTH E. PEKLEN    | Seattle, Wash.      |
| ANTHONY DAZZEL DUKE     | Locust Valley, N. Y. | JOSEPH PRENDERGAST     | New York, N. Y.     |
| RICHARD A. FARNSWORTH   | Houston, Tex.        | MRS. RICHARD E. RIEGEL | Montchanin, Del.    |
| MRS. HOWARD A. FRAMM    | Los Altos, Calif.    | WILLIAM S. SIMPSON     | Bridgeport, Conn.   |
| MRS. PAUL GALLAGHER     | Omaha, Nebr.         | GRANT TITWORTH         | Norolton, Conn.     |
| ROBERT GARRETT          | Baltimore, Md.       | MRS. WM. L. VAN ALLEN  | Edgemont, Pa.       |
| FREDERICK M. WARGURG    | New York, N. Y.      |                        |                     |

## HEADQUARTERS STAFF

|                                                                                                          |                                                                                                     |                                                                                                                     |
|----------------------------------------------------------------------------------------------------------|-----------------------------------------------------------------------------------------------------|---------------------------------------------------------------------------------------------------------------------|
| <b>Executive Director's Office</b><br>ARTHUR WILLIAMS    ALFRED H. WILSON                                | <b>Personnel Service</b><br>WILLARD C. SUTHERLAND    MARY GUESNAT                                   | <b>Area and Facilities Planning and Surveys</b><br>G. LESLIE LYNCH                                                  |
| <b>Field Department</b><br>CHARLES E. BEED    WILLARD B. STONE<br>JAMES A. MADISON                       | <b>Program Service</b><br>VIRGINIA MUSSELMAN                                                        | <b>Katherine F. Rarker Memorial Secretary for Women and Girls</b><br>HELEN M. DAUNCEY                               |
| <b>Research Department</b><br>GEORGE D. BUTLER    MUBIRL E. MCGANN<br>WHITNEY N. MORGAN                  | <b>Recreation Magazine</b><br>DOROTHY DONALDSON    AMELIA HENLY                                     | <b>Recreation Leadership Training Courses</b><br>RUTH EHLENS    ANNE LIVINGSTON<br>FRANK A. STAPLES    GRACE WALKER |
| <b>Service to Federal and State Agencies</b><br>GEORGE E. DICKIE                                         | <b>Special Publications</b><br>ROSE JAY SCHWARTZ    FRANK J. ROWE<br>MARY E. HOLMES                 | <b>Hospital Recreation Consultant Service</b><br>BEATRICE H. HILL                                                   |
| <b>Correspondence and Consultation Service and International Recreation Service</b><br>GEORGE A. NESBITT | <b>Work with Volunteers</b><br>MARY QUIRK    MARGARET DANKWORTH<br>ELIZABETH SHINE    HAROLD WILCOE | <b>Public Information and Education</b><br>ANNE L. NEW    BETTY BUNN<br>DAVID J. DUBOIS                             |

## DISTRICT REPRESENTATIVES

|                                                                                                             |                                                                                               |                                                                           |
|-------------------------------------------------------------------------------------------------------------|-----------------------------------------------------------------------------------------------|---------------------------------------------------------------------------|
| <b>New England District</b><br>WALDO R. HAINSWORTH, Northbridge, Mass.<br>RICHARD A. TAPPEY, Bristol, N. H. | <b>Southern District</b><br>WILLIAM M. HAY, Decatur, Ga.<br>RALPH VAN FLEET, Clearwater, Fla. | <b>Southwest District</b><br>HAROLD VAN ARSDALE, Dallas, Tex.             |
| <b>Middle Atlantic District</b><br>RICHARD S. WESTGATE, Temple, Pa.                                         | <b>Midwest District</b><br>ARTHUR TODD, Kansas City, Mo.<br>HAROLD W. LATHROP, Denver, Col.   | <b>Pacific Northwest District</b><br>WILLARD H. SHUMARD, Seattle, Wash.   |
| <b>Great Lakes District</b><br>C. E. BREWER, Toledo, Ohio<br>ROBERT L. HORNEY, Madison, Wis.                |                                                                                               | <b>Pacific Southwest District</b><br>JOHN J. COLLIER, Los Angeles, Calif. |

### Affiliate Membership

Affiliate membership in the National Recreation Association is open to all non-profit private and public organizations whose function is wholly or primarily the provision or promotion of recreation services or which include recreation as an important part of their total program and whose cooperation in the work of the association would in the opinion of the association's Board of Directors, further the ends of the national recreation movement.

### Active Associate Membership

Active associate membership in the National Recreation Association is open to all individuals who are actively engaged on a full-time or part-time employed basis or as volunteers in a nonprofit private or public recreation organization and whose cooperation in the work of the association would, in the opinion of the association's Board of Directors, further the ends of the national recreation movement.

### Contributors

The continuation of the work of the National Recreation Association from year to year is made possible by the splendid cooperation of several hundred volunteer sponsors throughout the country, and the generous contributions of thousands of supporters of this movement to bring health, happiness and creative living to the boys and girls and the men and women of America. If you would like to join in the support of this movement, you may send your contribution direct to the association.

The National Recreation Association is a nationwide, nonprofit, nonpolitical and nonsectarian civic organization, established in 1906 and supported by voluntary contributions, and dedicated to the service of all recreation executives, leaders and agen-

cies, public and private, to the end that every child in America shall have a place to play in safety and that every person in America, young and old, shall have an opportunity for the best and most satisfying use of his expanding leisure time.

*For further information regarding the association's services and membership, please write to the Executive Director, National Recreation Association, 8 West Eighth Street, New York 11, New York.*

# Recreation\*



## THE MAGAZINE OF THE RECREATION MOVEMENT

*Editor in Chief*, JOSEPH PRENDERCAST  
*Editor*, DOROTHY DONALDSON  
*Editorial Assistant*, AMELIA HENLY  
*Business Manager*, ALFRED H. WILSON

ASSOCIATE EDITORS  
*Recreation Administration*, GEORGE BUTLER  
*Program Activities*, VIRGINIA MUSSELMAN

## CONTENTS

### GENERAL FEATURES

*My Philosophy of Recreation (Editorial)*  
 ..... *Charles F. Weckwerth* 153

*Junior Gardeners* ..... *Ann Albert* 169

*Teen-Agers Adopt Conduct Guide* ..... 170

*Going to Long Beach?* ..... 175

### ADMINISTRATION

*Here and There with Swimming Pools*  
 ..... *Compiled by George Butler* 176

*Topeka's New Pool Pays Its Way* ..... *Muriel E. McGann* 178

*Business Procedures in Pool Operation* ..... *C. P. L. Nicholls* 180

### PROGRAM

*Pick Up Your Sketch Book* ..... *Norman Garbo* 172

*Teaching Baseball to Beginners* ..... *Mickey McConnell* 173

*Carving with Plaster of Paris (How To Do It!)*  
 ..... *Frank A. Staples* 182

*A May Party on Rubber Wheels* ..... *Lucy Muir* 183

*The Able-Disabled (Idea of the Month)* ..... *Patricia Morris* 186

*Boys, Bikes—and Safety* ..... *S. Preston Douglas* 188

### REGULAR FEATURES

*Letters* ..... 166

*Things You Should Know* ..... 168

*How To Do It! Idea of the Month* ..... *See Program*

*Market News* ..... 190

*Books and Pamphlets Received* ..... 191

*Index of Advertisers* ..... 191

*New Publications* ..... 192

*Recreation Leadership Training Courses* ..... *Inside Back Cover*

Vol. L Price 50 Cents No. 5

### On the Cover

**BEGINNING OF SUMMER.** Blossoms now turn their faces to the sun. This photo, a prize winner in the first World-Wide All-Service Amateur Contest—by Sgt. Joseph Clarke Templeton, Jr.—is reproduced through the courtesy of U. S. Army. Its official title is "The Three Suns."

### Next Month

Emphasis on the encroachment of recreation and park lands, with details of the land grab by highways or building interests—and suggestions as to what can be done about it. Walter H. Blucher, consultant to American Society of Planning Officials, has written a fighting editorial, "The Need for Recreation Lands." There will be more information about the National Recreation Congress, of course, and an article on "What to Do and See in Long Beach." The pros and cons of hot rodding and drag racing will be presented in, "Drag Strips vs No Drag Strips." Among program articles, you won't want to miss the up-to-date ideas in such articles as "Brainstorming in Recreation," by Mary Sargent, "For Successful Nature Hikes," by William R. Overlease, or "The Heap Big Day Camp," by Mary E. L. Sawyer. For those who will be building or operating swimming pools this summer, George Butler has collected "Court Decisions Affecting Swimming Pools."

### Photo Credits

Page 170, Recreation Department, Pensacola, Florida; 171, Waterloo Recreation Commission, Waterloo, Iowa; 178, Wolfe's Commercial Photos, Inc., Topeka, Kansas.

RECREATION is published monthly except July and August by the National Recreation Association, a service organization supported by voluntary contributions, at 8 West Eighth Street, New York 11, New York, is on file in public libraries and is indexed in the *Readers' Guide*. Subscriptions \$4.00 a year. Canadian and foreign subscription rate \$4.50. Re-entered as second-class matter April 25, 1950, at the Post Office in New York, New York, under Act of March 3, 1879. Acceptance for mailing at special rate of postage provided for in Section 1103, Act of October 3, 1917, authorized May 1, 1924. Microfilms of current issues available University Microfilms, 313 N. First Street, Ann Arbor, Michigan.

*Space Representatives:* H. Thayer Heaton, 141 East 44th Street, New York 17, New York; Mark Minahan, 168 North Michigan Avenue, Chicago, Illinois.

Copyright, 1957, by the

National Recreation Association, Incorporated

Printed in the U.S.A.



\* Trade mark registered in U. S. Patent Office.

# My Philosophy of Recreation

Charles F. Weckwerth



SINCE THE TURN of the century, recreation has been offered and provided by many public and private agencies to meet the daily needs of our average population. Today, such service is ever increasing, and is being provided for our handicapped, as well.

One of the landmarks in the growth of recreation services to all people was the 1946 Los Angeles survey, *Recreation for Everybody*. This survey recommended the following four basic principles upon which opportunities and services for recreation could be established: people desire and need places to go for their recreation; people need and wish a program of activities in which to participate; people need and gravitate to a variety of group relationships while engaging in recreation; and people who are handicapped desire and need recreation opportunities and services.

What does recreation mean to the average person of any community? What does the behavior of each of the following persons indicate regarding the meaning of recreation to him: a businessman in his fifties; a youngster in his teens; an oldster in the seventies; professional persons, such as a doctor, a lawyer, a teacher, a librarian? What about the chorus girl, the person in military uniform on first liberty or leave, the young wife with no children, an older woman with many children, a steel worker?

What do the experts say about the meaning of recreation? There appear, among many views, to be at least five schools of thought: recreation is a matter of attitudes; recreation is a matter of activities; recreation is a matter of experience—a way of life; recreation is a matter of land areas, buildings, facilities and equipment; recreation is a field of professional leadership.

*Recreation as attitude* reveals such views as physical fitness for military needs or for one's cultural development. Recreation as attitude would include religious dogma and doctrine as illustrated in America by the blue laws of Puritanism.

*Recreation as activity* is perhaps our most common view, and includes those activities which we enjoy in our leisure time—physical, mental, cultural, active or passive, in groups or as individuals.

*Recreation as experience* is perhaps the most basic or valid conception since both attitude and activity produce experience. Experience reveals recreation as being an individual and essential human need. Recreation as experience results in a variety of forms of human expression yielding individual and social values.

*Recreation as the provision of land areas, facilities and entertainment* is too often a conscious goal of agencies and their members, civil services and the taxpayers. In essence, such locations should provide opportunities and show concern for community recreation. Profit motive provides recreation services, resulting in "commercial recreation" as one of the forms of community recreation. Community recreation, then, in essence, includes many persons, places and purposes and, as such, becomes a collective matter.

It is evident that recreation as a broad concept, has a meaning which includes each and all of these schools of thought. Basically, it is a human need. Recreation, to different persons, is most often an abstraction like many of the other common words in our vocabulary—education, love, brotherhood, religion, happiness, satisfaction, and it represents both individual and diverse meanings. It includes a rich variety of activity forms, ranging from athletics and sports on one extreme, through cultural activities on the other. It is a basic social attitude, and through activity yields personal satisfaction, relaxation, and the renewal of spirit. Professional leadership, in addition to location, facilities and equipment, must be provided so that opportunities and services for recreation experience and expression becomes possible.

In brief, recreation is an individual matter of experience determined by choice in one's behavior, not in words. It belongs to no one organization, public or private, but rather to all organizations concerned with the value of experience of, for, and by people. All people need and want it. Recreation can be an important means, as well as an important and necessary end, in and for human experience and expression. ■

*From material prepared for a recreation seminar at a national meeting of the National Society for Crippled Children and Adults. MR. WECKWERTH is director of youth leadership, recreation, and community services, Springfield College, Springfield, Massachusetts.*

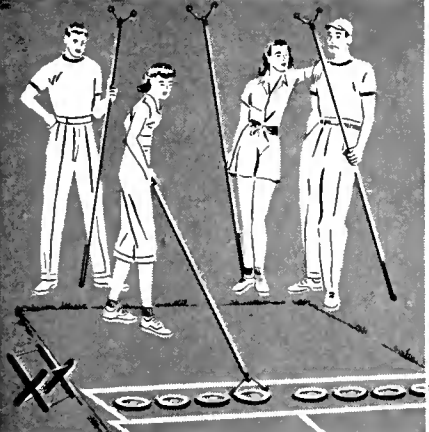

## Shuffleboard Fun For Everyone!

From 8 to 80 here is exciting recreation for all ages . . . keen enjoyment for players and spectators.

Rugged, Dimco FreeGlide Shuffleboard sets are available for both outdoor and indoor installation.

Easy to install . . . low in upkeep!

Write today for colorful folder, "Let's Play Shuffleboard," containing complete information on court layout and equipment.

**DIMCO-GRAY COMPANY**  
205 EAST SIXTH STREET  
DAYTON 2, OHIO

**ARKANSAS STATE HOSPITAL**  
Recreational Therapists:  
Salary from \$280 to \$324

Beginning salaries commensurate with training and experience. Paid vacation and sick leave, Social Security and State Retirement benefits.

Write or Call  
**Dr. Granville L. Jones, M.D.**  
Superintendent,  
Arkansas State Hospital,  
Little Rock, Arkansas

All-time favorite  
**SONG SLIDES**

Special close-out sale on 3 1/4" x 4" glass slides—10c per slide while available (Regular price 50c)

2"x2" glass slides also in stock—50c per slide

Write for catalog  
**NATIONAL STUDIOS**  
42 West 48th Street  
New York 36, N. Y.



## American Approved

*Jim Patterson's*  
**Lifetime**  
ALUMINUM Diving Board

## World's Finest Official Regulation Board

*Lifetime Construction, Unequaled Performance and Safety*

**RADICALLY DIFFERENT** in design and construction, unequaled in performance by any other board you've seen.

**BUILT LIKE AN AIRPLANE WING**—Aircraft structural design combined with spring-leaf principle and heat-tempered, specially alloyed aluminum are joined in an assembly of great strength, uniform flexibility and incomparable springing qualities.

**PRACTICALLY UNBREAKABLE**—Many times stronger than actual load requirements—will withstand severest use day after day, yet continue to give unmatched performance and maximum springing action year after year, free of repairs or replacement.

**SPRING-LEAF CONSTRUCTION** gives much greater strength at fulcrum where needed, and lightness at tip.

**EFFORTLESS TAKE-OFFS, MORE HEIGHT WITH LESS EFFORT**—No other board has such buoyant springing qualities or is so stable underfoot. Built-in resilience lasts as long as the board.

**SAFEST DIVING BOARD EVER DESIGNED**—Aircraft structure eliminates torque (twisting action) at tip of the board. Battleship Safety Tread, 18" wide, safest non-slip covering known.

**WEIGHS LESS** than conventional wood or coated wood boards, easier to install or remove. The only board that fits *any* regulation diving standard.

**ENDS BROKEN BOARD PROBLEM**—eliminates repair and replacement expense indefinitely, pays for itself in a few years. The entire board is anodized for permanent protection against salt water and all corrosion.

No. APL-14 Lifetime Aluminum Board  
14' long, weight 130 lbs. . . . **\$329.50**

No. APL-16 Lifetime Aluminum Board  
16' long, weight 140 lbs. . . . **\$349.50**

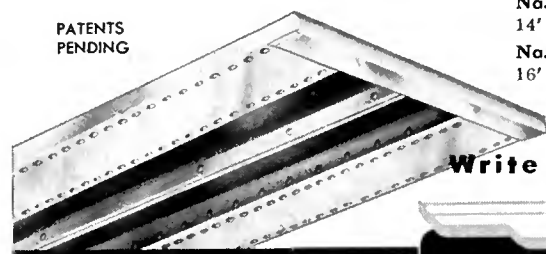

PATENTS  
PENDING

Write for Literature

**EXCLUSIVE DISTRIBUTORS**

WORLD'S LARGEST MANUFACTURERS OF FINE  
PARK, PICNIC, PLAYGROUND, SWIMMING  
POOL AND DRESSING ROOM EQUIPMENT

**AMERICAN**  
PLAYGROUND DEVICE CO.  
ANDERSON, INDIANA, U.S.A.

**FREE!**

**THIS BIG ILLUSTRATED LEATHERCRAFT CATALOG**

There is no finer source of materials for Leathercraft projects of all kinds . . . easy-to-assemble kits to enable beginners to make billfolds, gloves, purses, belts and other attractive items . . . top quality tooling and carving leathers for advanced craftsmen. Also complete line of Leathercraft tools, accessories, supplies and instruction books.

**ATTENTION METALCRAFT HOBBYISTS**

Here is a comprehensive illustrated catalog from which you can make your selection of aluminum and copper in sheets and shapes for many projects; copper, aluminum and brass foil for metal tooling; kilns, colors and kits for metal enameling; instruction books, tools and accessories for metalcraft of all kinds.

**SEND TODAY FOR EITHER OR BOTH FREE CATALOGS**

**J. C. LARSON CO.**  
820 S. TRIP AVE., DEPT. 7005  
CHICAGO 24, ILLINOIS

for every

RECREATION  
ACTIVITY

HI-FI

sound  
at low cost

R-16CV



NEWCOMB

- transcription player
- public address system

For every sound reproduction application in recreation halls, gyms, auditoriums, or summer camps, the Newcomb R-16CV does the job better, yet weighs less than 22 pounds. A separate microphone and phonograph volume control permits mixing recorded music with the microphone presentation. *Variable speed control* allows variable tempo and pitch (from any basic speed setting). A quality heat and humidity resistant high fidelity ceramic pickup is encased in a professional-type tone arm. Balanced-design amplifier with inverse feedback in combination with a fine ten-inch extended range speaker give quality you'd never expect at its price. Newcomb is the "sound of quality since 1937"... recognized by leading school authorities from coast to coast.



**NEWCOMB VARIABLE SPEED**

Exclusive Newcomb design gives dependable continuously variable control at all 3 speeds.

FREE CATALOG

**NEWCOMB**

Audio Products Co., Dept. Z-5  
6824 Lexington Av., Hollywood 38, Calif.

- Send free catalog of Newcomb portable sound equipment.
- Send name of our nearest Newcomb distributor.

Name \_\_\_\_\_  
Address \_\_\_\_\_  
City \_\_\_\_\_



Readers! You are invited to send letters for this page to Editor, RECREATION, 8 West Eighth Street, New York 11—so that your ideas, opinions and attitudes may be exchanged with others on the wide range of subjects of concern to us all. Here is your chance to agree or disagree with the authors of our articles. Keep letters brief—not more than 250 words.

—The Editors.

**Price of Camping Maps**

Sirs:

Thank you for mentioning our book *Camping Maps USA* in the March issue. We have had quite a number of inquiries regarding the price and wonder if you would be kind enough to list this as \$1.95, postpaid.

GLENN AND DALE RHODES. *Camping Maps, USA, Upper Montclair, New Jersey.*

**Foe of Delinquency**

Sirs:

Your provocative article, "Family Recreation—Foe of Juvenile Delinquency" (February issue), shows very clearly the necessity for close family life to reduce juvenile delinquency. Family life is our first school, upon which our future life depends so much.

I have felt that "we" feeling of close family life, and I can tell how wonderful it is to enjoy our parents, learn from them, and feel that great affection and emotional security that produces close family ties.

Your article made me realize that we must work together for the achievement of this noble purpose—family unity.

LUCRECIA PIZARRO, *College of Saint Teresa, Winona, Minnesota.*

**Adolescence**

Sirs:

I am most enthusiastic about the article in your February issue by Miss Helen Rapp ("Adolescence Will Be Like This," pages 41 and 42). May we have permission to reprint parts of this article in *The Camp Fire Girl* magazine? I think Miss Rapp's essay is one of the most readable I have ever read on this subject. She has such a nice conversational style and I think her words would be helpful to our Horizon Club advisors.

JOAN ROWLAND, *Editor, The Camp Fire Girl, Department of Program, New York City.*

**Appreciation**

Sirs:

I appreciate receiving the page from the November issue of RECREATION, on which mention is made of our brochure and manual relating to recreation for the aging. The three publications that grew out of this study are certainly being well received throughout the nation and countries over the world. The material is now in its third printing.

Again, thanks for mentioning it and congratulations to you on RECREATION—it is a splendid magazine and we all look to it for continued expressions of value for our work and our philosophy of interest.

HAROLD D. MEYER, *Consultant, North Carolina Recreation Commission, Raleigh, North Carolina.*

**For Administrators**

Sirs:

Some time ago I enjoyed very much the poem in RECREATION, December, 1956, "The Administrator's Dilemmas," by Robert S. Herman, reprinted from *Public Administration Review*.

I take this opportunity to congratulate you.

**NATIONAL BASES**



PRECISION BUILT

QUALITY GUARANTEED

*Nationally Preferred*

Write for our new Base Catalog.

**NATIONAL**

Sports Company

370 N. MARQUETTE STREET  
Fond du Lac, Wisconsin

# BOOK MANUSCRIPTS

**CONSIDERED**  
by cooperative publisher who offers authors early publication, higher royalty, national distribution, and beautifully designed books. All subjects welcomed. Write, or send your manuscript directly.  
**GREENWICH BOOK PUBLISHERS**  
Attn. Mr. Hitchcock 489 Fifth Avenue  
New York 17, N. Y.

For Concrete Playing Surfaces  
and Highly Polished  
Floors . . .



**SUPERIOR**  
"LIFETIME"  
**SHUFFLEBOARD**  
**PUSHER**

Superior's new non-friction shuffleboard pusher has rolling fibre wheels—a real floating head! Permits the player to approach from any angle without lifting disc. Fibre wheels guaranteed not to wear out. Each set of 4 pushers packed with 8 unbreakable plastic discs in carton with instruction book. Write for literature today.

**Superior**  
INDUSTRIES CORP.  
565 Barry Street • New York 59, N. Y.

Pool and Table Tennis Tables  
Poker Tables • Bumper Pool  
Paddle Tennis Paddles

# Jamison PLAYGROUND EQUIPMENT

Be sure to check the many exclusive features of this rugged line. Write for free catalog of 254 items.  
Jamison Manufacturing Co. Since 1925  
3711 South Mettler Street  
Los Angeles 3, California

late the editors of RECREATION for producing such an interesting magazine which is a great source of information and contains many useful suggestions to its readers. Its presentation is also one of the best in the magazine field.

J. ALPHONSE DULUDE, *President.*  
*Parks and Recreation Association of Canada.*

## The Finest Poem

Sirs:

I want to tell you how much I enjoyed the very inspirational poem in the December 1956 issue of your magazine written by J. W. Faust.

It was the finest poem of its kind on the subject that I have ever seen.

I am sure that your magazine readers would appreciate more fine specimens from this writer.

JOHN CREW TYLER, *Minister, Central Brick Presbyterian Church, East Orange, New Jersey.*

## Letter to "J. W." Faust

Dear "J.W."

That was a right magnificent prayer you had in RECREATION, December 1956. Your facility with words is beautiful in its warmth and depth. Please write some more for all of us. I mean that. I do hope that during the next several years you will open up your head and heart in a number of writing-pieces.

SHERWOOD GATES, *Director, Office of Community Services, Department of the Air Force, Washington, D. C.*

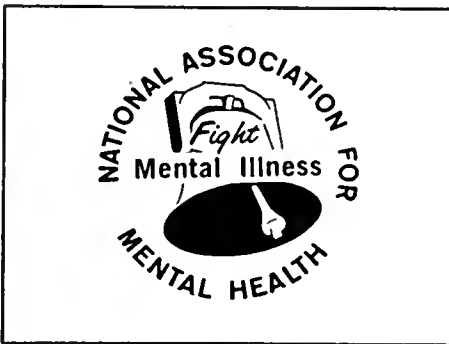

# IMMEDIATE DELIVERY ON . . . . . C-R-A-F-T-S

FROM YOUR CHOICE OF **2** HANDY, CONVENIENT LOCATIONS

Hurry . . . place your order with us now for your Summer craft programs. Our two locations offer immediate delivery service and a variety of crafts at low quantity prices. All orders over \$50 will be shipped freight prepaid as stipulated in our 1957 catalog.

Write For FREE Catalog of Handicraft Supplies!

# CLEVELAND CRAFTS CO.

4707 EUCLID AVENUE  
CLEVELAND 3, OHIO  
34 ELMWOOD PARKWAY  
(Elmwood Park)  
CHICAGO 35, ILL.

**R** For  
Perfect  
Summer Movie  
Programming!

Sign Up Now For



## Free Film Plan

Receive a complete, exciting sponsored film program each week all summer—for FREE-LOAN (postage only).

Hold each program for a full week—use as often as you like! The answer to your Movie Night or rainy day needs.

Sports, travel, science, recreation films—most in full color—all outstanding!

## MAIL THE COUPON BELOW

Send for your Free copy of our new Catalog of Free-Loan and Feature Films.

Flavor your program with

## A - DASH - OF - DISNEY!

A complete selection of Walt Disney Technicolor Classics—Cartoons, Features, True-Life Adventures—available for RENTAL.

Enroll my group in MOVIE-A-WEEK:  
Starting (date) .....and  
ending date) .....  
Each program should run .....minutes.  
For  Boys  Girls—Ages .....to.....  
Name.....  
Organization.....  
Address.....  
City.....Zone.....State.....

Please send Free Catalog

## ASSOCIATION FILMS, INC.



347 Madison Ave., N.Y. 17, N.Y.  
Branches:  
Ridgely, N. J. • La Grange, Ill.  
San Francisco, Calif. • Dallas, Tex.

•  
•  
•  
•  
•

## Things You Should Know . .

•  
•  
•

▶ **JUNE IS NATIONAL RECREATION MONTH!** Why not use it for making your community recreation-land conscious? Inform citizens of action needed to halt specific land-grab instances. (Watch for articles on land encroachment in the June issue of RECREATION.) As a recreation promotion and interpretation device, National Recreation Month was a huge success in communities across the country last year. (See "A New Pattern for Recreation," page 382, RECREATION, October 1956.)

▶ **THE APPOINTMENT OF HOWARD JEFFREY** as the first executive director of the American Recreation Society has just been announced by the society's president, J. Earl Schlupp. Mr. Jeffrey will take office on July first, and his headquarters will be at 1129 Vermont Avenue, N.W., Washington 5, D. C. He leaves a position as assistant professor of recreation at West Virginia University to assume his new post. He has had broad experience in the field of recreation.

▶ **THE 16TH ANNUAL CONFERENCE** of the National Industrial Recreation Association will be held at the Hotel Sherman in Chicago, June 2-5, 1957.

▶ **THIS YEAR MARKS THE 100TH BIRTHDAY** of the National Education Association. Its Centennial Convention, June 30 to July 5, will be held in Philadelphia, where forty-three educators from twelve states started the National Teachers' Association in 1857. It is estimated that this year's meeting will draw 15,000 to 20,000 teachers.

▶ **NEW NATIONAL HEADQUARTERS** of the American Institute of Park Executives in Wheeling, West Virginia, will be located in beautiful Oglebay Park. The move from Aurora, Illinois, took place in April.

▶ **TAKING PIANO LESSONS FROM FILMS**, even without a piano, is made possible for individuals or groups, through a new thirteen-week series of fifteen-minute film programs, "Recreational Piano." The films are 16mm, black and white, featuring George C. Stout, professor of music education at the University of Houston, whose live TV piano lessons were described in RECREATION, May 1956, page 220. The new series, based upon these telecasts, is produced by educational TV Station KUHT of the university, in cooperation with the education division of the National Association of Music Merchants. It is available free to both educational and commercial TV stations, and to other agencies for a small charge. In place of a piano, a beginner's book and cardboard keyboard are all that are needed. They are obtainable for a little over one dollar. For further information write Mr. Larry Baker, The Philip Lesly Company, 424 Madison Avenue, New York 17.

▶ **UNICEF'S 1957 HI NEIGHBOR PROGRAM KIT** is now ready. Around-the-world fun is explored in forty pages of activities from other lands. Cost is one dollar per kit, with a twenty per cent discount for tax-exempt agencies. Wholesale price allows a discount of twenty per cent on five or more copies; forty per cent on one hundred or more. Also available is a new LP record for dancing, with dance instructions, priced at \$3.00, and a filmstrip of thirty-four frames, priced at \$1.00.

▶ **A DIRECTORY OF INTERGROUP AGENCIES IN THE USA** will be published soon by the National Association of Intergroup Relations Officials (NAIRO), 1106 Water Board Building, Detroit 26, to whom orders and inquiries may be sent. When issued, the directory may be acquired by your public library (if you ask for it).

▶ **TWO THOUSAND DOLLARS IN PRIZES** are being offered again this year for the best fifteen-minute radio programs produced and broadcast by a community organization on the subject of "Action for Peace in Our Town."

In the first year of competition, programs were entered by such organizations as the Girl Scouts, League of Women Voters, American Association for the United Nations, and others.

This year two special awards are offered to student groups and college-supported and -operated stations. Additional information may be secured from the Institute for International Order, 11 West 42nd Street, New York 36.

▶ **CORRECTION:** Lewis C. Reimann who wrote "Campsite Selection, Layout and Development," in our March issue, is the author of *The Successful Camp*, to be published by the University of Michigan Press, and of *The Lake Poinsett Story, A Venture in Faith*, distributed by the Lake Poinsett Methodist Camp. He did not write *Successful Camp Administration*.

### Bargain Hunting?

Planning your summer program? Interested in completing sets of RECREATION Magazine? The following back issues are reduced in price *for a limited time only* (to July first):

1955 Issues—4 for \$1.00

All months except March

1953 Issues—5 for \$1.00

April (Playground Issue)

May

October

November

1952 Issues—5 for \$1.00

All months except January, October

Place your order promptly before stock is exhausted.

### Raymond E. Hoyt

It is with deep regret that we announce the death of Raymond E. Hoyt in Long Beach, California on March 25. In January 1957 Mr. Hoyt was appointed chief of the Pacific Coast Seashore Survey, and he was in Southern California in connection with that position when his death occurred. He was a graduate engineer who became interested in recreation early in his career. His position before the last appointment was as assistant chief of the National Park Service Division of Cooperative Activities. He has been a devoted friend of the National Recreation Association through the years; and last year he acted as West Coast host for the first National Recreation Association-United States State Department Foreign Exchange Program. ■



*The month of May, with its fragrance of flowers and thoughts of growing things, is a good time for awakening interest in a gardeners' club.*

**A** JUNIOR GARDENER CLUB has been active in Santa Ana, California, for more than five years, because a community-minded citizen, Mrs. Weston Walker, past president of California Garden Clubs, came to the recreation department with the idea.

The group meets once a month at the community center clubhouse, and has an average of thirty-three youngsters and eight parents at each meeting. It is co-sponsored by the Santa Ana Recreation Department, the Year 'Round Garden Club and the Santa Ana Garden Section of the Ebell Club. The department provides a meeting place, the necessary paper work, help with publicity, and the active interest of a recreation staff member. Meetings are planned and conducted by counselors who are women interested in gardening and children, and who often are garden club members.

Many subjects in the gardening and nature field have been covered by these children at their meetings. They have learned about Luther Burbank, Johnny Appleseed, Audubon and other famous naturalists; spring, summer and fall bulbs and how to grow them; how to start plants from cuttings; how to grow from seed; how to mix soil and make compost; how to recognize and control pests; how to weed and water correctly; how to mulch to conserve water; how to plant to control erosion. They have learned how to arrange flowers and foliage, dry weeds, fruits and vegetables; how to plant dish-gardens. They have learned about birds and wild flowers, forestry and conservation, state and national parks.

During handcraft periods—a part of every meeting—they have made ceramics, Christmas ornaments and party favors, woven mats of eucalyptus bark, decorated flowerpots, made gardening scrapbooks, leis, corsages. They have had the thrill of appearing on television, entering the Orange County Fair and other flower shows.

In the field of community service these young people have beautified two city lots with lovely flower plots and have raised vegetables. They have furnished many fresh-flower bouquets for the children's wards of the county hospital and presented planters to children in the tuberculosis ward, planted trees for Arbor Day, provided fresh flowers for the tables in a school cafeteria. Each year they undertake a different scrapbook project, having studied trees one year, birds the next, and they are currently working on insect and bug books.

Organizing a junior club is really very simple. One or more leaders meet with five or more children, explaining the sort of fun they will be having and the fascinating things they will learn. A name should be selected at one of the first meetings. Some clubs meet weekly, some every two weeks and some once a month. Members should elect officers and decide whether to have dues. Most clubs of this

The housewife knows that spring has arrived at last when the junior gardeners come around to offer plant clippings and garden literature.



Trimming a "herb tree" for group's forthcoming plant sale. The children have undertaken a variety of interesting nature activities.

sort, the Santa Ana Club included, do not have any.

Record keeping is important. There may be calls for statistical information, clippings and snapshots of civic projects, newspaper publicity and other data. If the children are not old enough to accept this responsibility, it should be done by the adult leader or an assistant.

Club members may be affiliated with the Audubon Junior Club, by payment of twenty-five cents each and receive bird membership pins. (Write National Audubon Society, 654 North Durfee Avenue, El Monte, California, for details.) Most clubs adopt the Junior Gardeners' Pledge.

Programs vary from club to club but usually include the aforementioned activities. There might also be talks by outside speakers, short talks on the flower or bird of the month, and chances for members to tell of interesting plants seen on a trip, a beautiful garden visited, and to show blooms from their own gardens and shell or rock collections. Often there is distribution of plant material to members at the close of meetings, something to take home and plant—perhaps excess from gardens of adult leaders, garden club members, or nurserymen who will donate flats of unsold bedding plants or bulbs. Program planning help is available, too, from your state junior gardening chairman, your local library, nurseries, farm advisor's office, 4-H office, Audubon club, and forestry department.

The children in our garden clubs are the future better citizens of our country—the ones who will realize the importance of conservation, who will maintain their homes and grounds, who will respect our public parks, forests and roadsides. Even as youngsters they will have higher morals, for outdoor life and juvenile delinquency seldom mix. ■

MRS. ALBERT is supervisor of women's and girls' activities in Santa Ana, California.



Teen-agers enthusiastically endorse Minnesota Code, a guide to see parents and offspring through growing-up years.

# TEEN-AGERS ADOPT CONDUCT GUIDE

**I**N MINNESOTA a governor's council on youth recently proposed that communities prepare and adopt advisory guides for conduct. Acting on this proposal, a special committee of adults and young persons, sponsored by the Women's Institute of St. Paul, developed a "Social Code" for the guidance of parents and their teen-age youngsters.\* One of the interesting points in the code is that parents have an *obligation* to assist in community projects for young people. Throughout, the obligations of teen-agers and parents to each other are clearly defined, and the need for cooperation and sharing of responsibilities is emphasized. The code, which appears here in its entirety, has been distributed to schools, parent-teacher groups, and student council bodies in St. Paul and vicinity. Meanwhile, other Minnesota communities are responding to the challenge. Teen-agers are as enthusiastic as are the adults—the conduct code works!

## St. Paul Social Code\*

### COMMUNITY RESPONSIBILITY:

1. Parents should set an example of community responsibility.
2. Parents have the responsibility to provide within the community wholesome recreation.
3. Young people should be encouraged to develop their own creative activities.
4. Parents have an obligation to assist in community projects for young people, whether sponsored by the school, church, or volunteer agencies. Parents have an added obligation to serve as chaperones and provide transportation for the younger children.
5. Parents should be aware of the laws and explain the laws that govern their children.
6. Parents and young people should feel a moral responsibility for the care of public property.

### FAMILY COOPERATION:

1. Sincerity, forthrightness and open-mindedness are essential in a discussion concerning friends and activities.

\* Reprinted with permission of the Women's Institute of St. Paul, Minnesota.

Family meetings are a good way of solving new situations within the family.

2. Financial matters and management of money should be discussed by parents and teen-agers.

3. Parents and young people should jointly assume responsibility for the discussion and solution of problems which relate to teen-age social behavior.

4. Young people should be encouraged to assume as much responsibility for planning and carrying out their social affairs as possible.

5. Young people should be encouraged to bring friends into the home and parents should welcome the opportunity to meet their children's companions.

6. Parents should be constantly aware of the growing-up process of their children physically, psychologically and socially. Parents must continue to learn, thereby becoming more understanding adults. Opportunities for so doing are afforded in the home, school, church and social agencies.

7. Parents should make young people feel that they can bring their problems, mistakes and aspirations to them.

### DATING:

1. Young people and parents have a responsibility to come to an agreement about dating.

2. Parents have a responsibility to know the young persons their children date.

3. Parents should be at home when young persons are being entertained and should make their presence known. Home activities for groups of older youths with dates is desirable as a way of date entertainment for young people.

4. Courtesy and consideration should govern the financial aspects of all dating and parents should be careful to educate their young people in such matters.

5. It is more desirable to have group activities than individual dates for those persons below high school level.

6. Parents should know where and with whom their sons and daughters are going on a date and have an understanding about the time of return.

### TIME TO GET HOME:

1. All parties should terminate at a reasonable hour and

young people should return home within a reasonable time.

2. Young people have the responsibility to call home if they are to be out later than agreed upon.

3. Parties or open houses after functions which terminate at a later hour should be discouraged.

4. The suggested hour for senior high school parties to end is twelve o'clock. For junior high school parties, curfew law should be observed.

**DRINKING:**

1. It is the joint responsibility of parents and teenagers to honor and observe the stipulations of the law governing the use of alcoholic beverages.

2. The law states: "It is unlawful for any parents to furnish intoxicating liquor to their children. It is unlawful for any person to furnish intoxicating liquor to anyone under twenty-one years of age."

3. The law states: "It shall be unlawful for any person under the age of twenty-one years to have in his or her possession any intoxicating liquor."

**TRANSPORTATION:**

1. The use of public transportation facilities, regular or special, requires common rules of courtesy, respect for the rights of others, and obedience to the law.

2. The same principles apply to privately owned vehicles including motorcycles and motorbikes. Driving a car or vehicle of any kind is a privilege, not a right. Parents should see that children have proper instructions in driving and an understanding and appreciation of the letter and spirit of the law.



The code covers highly controversial subjects such as smoking, drinking, the hour to come home from dates. It includes how to dress and social conduct.

Riders have a share in the responsibility for safe driving.

All drivers must take the responsibility of being in good physical and mental condition and in full control of the car. Drivers have a moral responsibility to their passengers. Young people should be encouraged to reject the offer of rides in any car if the driver of the car is not properly qualified. Young people should be encouraged and feel free to call upon parents to secure transportation when the driver of the car involved becomes incompetent for one reason or another to drive a vehicle in safety. ■

**NEW! jayfro**  
Multi-Purpose  
**ALUMINUM STANDARD**  
Use it  
*12 Ways!*

Interchangeable  
Indoors and Outdoors for

- VOLLEY BALL • SAOIMINTON
- TENNIS • PADDLE TENNIS
- HIGH JUMP • TETHERBALL

- ✓ Official specifications
- ✓ Lightweight
- ✓ Easy to Install and move
- ✓ No maintenance
- ✓ Six different models

**jayfro**  
**BASKETBALL STEEL CHAIN NETS**  
3 Years Guarantee! outdoors or indoors

*Also Featuring Jayfro's Custom Built  
New and Improved!*

✓ **PADDLE TETHERBALL SETS**  
*Revolutionary and Exciting New!*

✓ **SHUFFLEBOARD SETS**  
with "RUBBER CUSHIONED" DISCS

• Send for Free Catalog •

**JAYFRO ATHLETIC SUPPLY CO.**  
Dept. RC, Box 1065, NEW LONDON, CONN.

**HONOR YOUR PARTNER**

Couple Dances

Square Dances

Play-Party  
Singing-Games  
Folk Dances

**Instructional**

GUARANTEED NOT TO BREAK  
○  
CHIP OR CRACK

**Records**

Available on  
78 RPM or  
LP (33 1/3  
RPM)

Rhythms

Ed Durlacher's "Talk-Through;  
Walk-Through" System of Sim-  
plified Progressive Instruction,  
followed by the Complete Dance.

**SQUARE DANCE ASSOCIATES**  
P.O. Box 644, Freeport, N. Y.

Mail coupon for FREE brochure on all Honor Your Partner Teaching Aids  
**SQUARE DANCE ASSOCIATES** P.O. Box 644, Freeport, N. Y.

Gentlemen: Please send me free brochure of Honor Your Partner Teaching Aids,

Name \_\_\_\_\_

Address \_\_\_\_\_

City \_\_\_\_\_ Zone \_\_\_\_\_ State \_\_\_\_\_

# Pick Up Your *Sketch Book*

Norman Garbo

*Spring weather is here, and now "you can get out of the house!" On hikes and picnics slip a pad and pencil into your pocket for that quick sketch which can catch a mood or preserve a memory.*



Figure 1

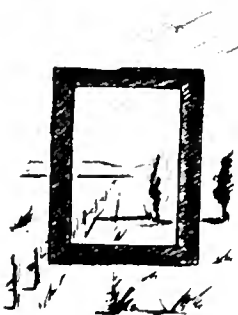

Figure 2



Figure 3

Condensed and reprinted with permission from *Pull Up An Easel* by Norman Garbo. Copyright 1955, A. S. Barnes and Company, Inc. MR. GARBO'S syndicated column for artists has appeared in newspapers throughout the nation.

THE TIME is ripe to try and revive a greater interest in one of art's simplest and most fundamental tools—the lead pencil. Because of the beauty and glamour in oil painting, a great many beginners and amateur artists have never worked with a pencil at all. Although the pencil can hardly compete with oils as a medium of artistic expression, it nevertheless offers some advantages that certainly shouldn't be ignored. Let's look at a few:

1. It's darn cheap.
2. It will lend itself just as well to a quick sketch as to a finished drawing. Most artists are aware of the pencil's use for a quick preliminary drawing, but few have fully explored its great potential as an attractive medium in itself.
3. It's always accessible and easily carried. As long as you own a pocket, the pencil can be ever handy.
4. It can be corrected and erased with a minimum of trouble.
5. It can be used with speed when speed is necessary, or can be adapted to great detail and texture.
6. All of us are familiar with the pencil, so that it feels quite comfortable and natural when we hold it.
7. It's not messy to work with, and the drawings, when completed, require no special care for preservation.
8. It will readily respond to almost any demand. If you need a fine line, a sharp point will produce it. If you want the soft touch for a mass of shading, a blunt edge may be used almost like a brush. It will also produce any tone from light to dark.

\* \* \* \*

One of the most popular misconceptions floating about is the idea that all still life is limited to indoor possessions.

This was brought home to me most strikingly when I stopped to see a friend who had but recently heard the "call to art."

It was a beautiful spring Sunday afternoon and I found him in a gloomy basement studio, painting some tired looking grapes and apples. Taking him by the horns I whisked him into his sunny back yard and expounded a few personal theories on artists and the outdoors; to wit:

First, we should take advantage of all good spring, summer and fall weather by working outdoors whenever possible. A paintbrush, some sunshine and a few gulps of fresh air can make a pretty enjoyable combination.

Second, if you are still limiting yourself to still life as subject matter, there exists a superabundance of material in "outdoor still life." We have only to know what to look for and we will find it all about us.

Incidentally, please don't confuse "outdoor still life" with a few objects from *indoors* set up *outdoors*. The term "outdoor still life" refers specifically to those objects normally found outdoors, such as, a rural mailbox in its natural setting, a bird house with some ivy entwined about it, an interesting corner of a chimney and a slanting roof, a few garden tools and gloves lying on the ground, a rain barrel standing beneath a drain pipe, any piece of lawn furniture that strikes your fancy, an especially picturesque fence; or, if you're near the water, all sorts of fishing gear, for example, lobster pots, oars, nets and boat-hooks.

Bear in mind that all of these objects represent the main theme of your composition. They should, therefore, be in the central foreground and drawn large

enough so they are given importance. Figures 1 and 3 are examples of how some of these things may be treated.

At this point you're probably quite eager to try a full-fledged landscape drawing. Perhaps you've already sneaked in a few attempts with good, bad or indifferent results. In any case, let's take a look at things from the grass up.

One of the most exciting, yet confusing and frustrating days in the life of the art student is "life day." This is the day when you, as an embryonic Rembrandt, gather up pad, pencils and, of course, eraser, and venture forth to draw nature where it lives.

Whether you travel fifty yards or fifty miles from your hearth, your first reaction is bound to be the same. You look about you in awe at the seemingly endless expanse of land and sky and murmur respectively, "Lord, it's a mighty large thing you've created here."

After that profound statement you proceed to draw, on a twelve-by-sixteen-inch sheet of paper, everything you can see within a radius of twenty miles.

After a few hours of wading through a swamp of confusion, you look at the mess on your pad and decide you should have stuck to golf.

Believe me, you're doing things the hard way. Drawing can be relaxing as well as fun, but not like this. You can't fight this thing because, as you see, it's bigger than you; so take a few hints from an "old pro":

1. Set yourself up in the shade. The shadow of a tree, a barn, a building or a hill will do. If you're going to be difficult and insist upon drawing with no visible shade, turn your pad with its back to the sun. Sunlight playing across your working surface will only distort your tones and give you a headache.

2. Cut out in advance and take with you a small cardboard frame about two by three inches in size.

3. Close one eye, and holding the cardboard cutout before the other eye, circle slowly about until you see, framed within the opening, the composition you would like to draw. It will appear through the cardboard frame as in Fig-

ure 2, delimiting the area for you.

4. Be most careful of the composition you choose. The temptation will be great, but don't try to draw everything in sight.

Choose one main object in the foreground as your center of interest—a tree, a rock or a shrub. Place it off center on your pad and fill in with a background of clouds, hills, a body of water.

In Figure 1 I've chosen a tree silhouetted against the sky. I've made everything in the foreground dark for emphasis, which is something to bear in mind. Always try to exaggerate darks and lights, particularly when working in black and white.

In drawing from nature, remember to avoid very straight, ruled-looking lines. Not only is it completely unnecessary to draw a straight line to create a work of art, but it is important that you do *not* do so. Regularity has always been the keynote of man-made objects, while nature in any form is typified by irregularity. No two things that God has created have ever been exactly the same. ■

## Teaching Baseball to Beginners

This teaching program, as used by the training director in Little League, offers some pointers for instructors of other baseball groups.

Mickey McConnell



The best way to instruct and develop young players is through actual game participation. Above, an umpire is judging a base runner in Oceanside, New York.

**E**ACH LEAGUE has a new crop of beginners every spring, and a special teaching program is desirable for them. This is particularly true for the youngsters who have had little or no opportunity to play baseball, or who have not developed sufficiently to participate in a program with older, more experienced players.

Extensive experiments with youngsters in this category—mostly nine- and ten-year olds—has led us to believe that the best way to instruct and develop them is through a program of teaching through game participation.

Depending on the number of boys, they are divided into squads of about fourteen to eighteen players each. The player agent can balance the squads after several tryout sessions, and then regular games can be scheduled; but no effort should be made to keep standings, averages or records.

*Demonstrations.* You must keep in mind that the interest span of players at this level of age and experience is very

MR. MCCONNELL is director of training, Little League Baseball, Williamsport, Pennsylvania.

short, so drills should be varied and brief. Start each session with a brief talk and demonstration of some fundamental of play—base-running, sliding, proper running form, coaches directing base-runners, bunting, batting, tagging runners, the stretch from the base on a force-out play, backing up plays, cutoffs, fielding the ground ball, catching flies, throwing double plays, rundown plays, and so on.

### Fielding Workouts

After this demonstration, the two teams scheduled to play then play catch until their arms are warmed up; after which, the visiting players go to their defensive positions. Start off by tossing a fly ball and a ground ball to each outfielder and have the fielders throw to the second baseman. For the first two or three weeks throw from the vicinity of second base, then from the pitcher's mound and finally from homeplate as their fielding improves.

Next toss a ground ball to each infielder and have each throw to the first baseman, with the first baseman throwing to the shortstop at second base when it is his turn to field a grounder. Roll the ball to the pitcher to field and throw to first and then roll the ball in front of the catcher for him to field and throw to first. Give each player two fielding chances.

As with the outfielders, toss the ball to the infielders during the first two or three weeks and then begin to bat fun-goes to them as they show improvement. Be sure all your players can catch fly and ground balls before you bat the ball to them. You can build their confidence by making the chances easy for them—you risk injury when you rush them too fast.

Then have the home team take its fielding drill. (As the players become more proficient in fielding, you can alternate double-play drills, cutoff plays, and defensive plays against bunts and situation drills from game to game.)

When the home team has completed its fielding drill, it goes in to bat while the visiting team goes into the field. In the batting drill, each player attempts to hunt twice and takes two swings, batting in the regular order with an adult serving as pitcher and throwing at half speed.

After each player has batted, the teams switch, with the home team moving into the field and the visiting team taking batting practice. Then a game is played with the batters hitting off a batting tee, set in front of home plate, for two innings. The home team stays in the field as the game begins with its pitcher on the mound to field that territory even though he doesn't pitch the ball.

In playing off the batting tee, the batter must hit the ball as far as the pitcher's mound for it to be called a fair ball. Batted balls which don't travel that far in fair territory are counted as fouls. If a boy swings and misses three times, or hits two fouls and then misses on a third swing he is out.



Base-runners are retired in the same manner as in regular Little League Baseball. When batter and base-runners have advanced as far as possible without being put out, or have been retired, the umpire calls "time out" and the ball is thrown in to the catcher, who places it on the tee. As soon as all players are in their regular positions, the umpire calls "time in," and the next batter takes his turn. Base-runners must stay on their bases until the ball is batted off the tee. If each team has as many as eleven players present, two extra boys can be used on each side, one playing in the outfield behind third base and the other in the outfield behind first base. Instead of using three outs to determine a half inning, the team stays at bat until all of the eleven players have batted. All of the extra players should be given a chance to play during the second inning.

At the conclusion of these two innings, one inning is played with the pitcher pitching to the batters. Again the half inning is concluded when all the players on the visiting team have batted around. (If the team has more than eleven players the extra players are given a chance to bat, too. If there are more players on one squad than the other at that game, the extra players are permitted to bat although any runs scored as a result of their being at bat do not count in the score of the game. This is done to give all the players experience in facing pitchers, without penalizing the teams because they don't have the same number of players present.) The home team takes its turn at bat against the regular pitcher even though it is ahead at the end of three and a half innings and it remains at bat until each player has batted once.

Do not hesitate to halt a game, when a boy makes a mistake to explain what he should have done in that situation. Announce to the boys that they are all learning, that they will face new situations frequently, and that you will hold up play to show them the proper way to make a play when something new develops. If this is done in a friendly way, without criticism of a player who may have made a mistake, you should be able to do a constructive job of teaching at a time when it makes an impression on the players.

Precaution should be taken to teach the boys to hit without throwing their bats. Beginners have a tendency to let the bat fly after hitting the ball, and injuries are invited by this procedure. Start by teaching the boy to complete his swing and drop his bat beside him before running. You may have to let a boy sit out a game occasionally to get him to stop this tossing habit.

Another danger can be avoided by having your catcher take up his position an arm's length behind the batter, and then stretching a tape or string on the ground to remind him to stay that far back until the batter swings. Otherwise some eager young catcher may be hit with a swinging bat.

Since the interest span of these youngsters is so short, it seems desirable from a standpoint of safety, as well as development, that "minor league" practice sessions and games have a time limit. Experience indicates these sessions should not exceed two hours.

We are convinced the boys improve faster and have more fun doing so under this program. ■

# Going to Long Beach?

For the 39th  
National Recreation Congress  
September 30—October 4, 1957



While semi-tropical Long Beach is on the ocean, mountains and desert are just a short drive off. You may enjoy three completely varying climates in the same day! Above, lemon and orange groves, with San Gabriel Mountains in the background. Right, world-famous Hollywood Bowl is about thirty-five miles away.



**C**OMBINE business with pleasure and go to California! Easterners, make the most of this exceptional opportunity to see our country! Plan an interesting trip, and be one of the lucky people who are expected in Southern California in September. You can be sure of a cordial reception—what with four California organizations making ready to welcome you and see that you have a good time: California Recreation Society, Long Beach Recreation Commission, Los Angeles County Department of Parks and Recreation, and the State of California Recreation Commission. *Be sure to save a few days of your vacation for Long Beach and environs.*

## Accommodations

The Municipal Auditorium, overlooking the Pacific, will be Congress headquarters; and the two Congress hotels—the Wilton and the Lafayette—are nearby. The Wilton is adjacent to the auditorium, the Lafayette, just four short blocks away. All reservations should be made through the Convention and Visitors Bureau, Inc., c/o Municipal Auditorium, Long Beach 2, California.

### Average Hotel Rates:

|                | Doubles        | Twins           |
|----------------|----------------|-----------------|
| Wilton .....   | \$9.00—\$13.00 | \$10.00—\$14.00 |
| Lafayette .... | \$9.50—\$12.00 | \$10.00—\$16.00 |

Other excellent hotels and motels provide accommodations for every pocket-book. Motel charges are around \$5.00 and \$6.00 for doubles, \$6.00 and \$7.00 for twins.

*Make your hotel reservations early!*

## Travel

Long Beach, California's "convention city," is easily reached from every part of the country by plane, train, boat, bus or car. The local airport is not far from the center of the city.

## Meetings

National Recreation Association advisory committees and committees of the American Recreation Society are busily engaged in planning the program. Suggestions for discussion topics are still being gratefully received.

The Institute in Recreation Administration for on-the-job executives will be held again this year. There also will be a whole series of special interest meetings, activities workshops and demonstrations, and, of course, general sessions. Meetings will again be held on state and federal recreation, industrial, hospital, college recreation, and recreation for the armed services. There will be no duplication of meetings this year, because the Congress will be a venture in cooperative planning and co-sponsorship.

## Thoughts on the Conference of Today

As you prepare to attend the annual National Recreation Congress, you will be aware that your organization is sending you as its representative and liaison

person. It will expect you to carry information and experience to the Congress and to return laden with new ideas to share. In order to give the most to and get the most out of the big meeting, some pre-planning is in order.

\* \* \* \*

Conference patterns have been changing during the last few years, according to Thomas R. Carskadon, chief of The Twentieth Century Fund Education Department. Writing on "The Conference of the Future,"\* he says that "the good conference of today—the better conference of tomorrow—is switching from a *listening* pattern to a *working* pattern." In answer to a questionnaire, he quotes E. C. Coffey, of the United Automobile Workers, as mentioning "buzz sessions following orientation in full assembly; plenary sessions then allow time for reports from each buzz group—role playing—quiz presentations—workshops."

\* \* \* \*

**PREPARATION FOR A CONVENTION:** Become familiar with all preconvention literature, particularly the agenda. Study the maps of the area, especially the location of the rooms in which your meetings are scheduled.

Ask your local group what *they* want you to bring back to them, as well as what they expect you to take with you.

Many convention-goers make dates well ahead of the opening. It will be hard to track down individuals once you get there.

The more time and thought you put into preconference planning, the freer and more efficient you will be once you arrive on the scene.—From *How to Attend a Conference* by Dorothea F. Sullivan, Association Press, New York. ■

\* *Adult Leadership*, May 1953.

## Fences

- Bayside, Wisconsin, has adopted an ordinance requiring the fencing of private swimming pools within the village.
- In Los Angeles, California, a new municipal law requires every body of water more than eighteen inches deep, including swimming pools, wading pools, fish ponds or lakes and ponds on private and industrial property to be enclosed by a fence at least four and a half feet high. The city council adopted the law after the drownings of several children in the last two years. Failure to comply with this law is a misdemeanor and carries a maximum fine of \$500 and a six-month jail sentence.

## Cutting Corners

- The May, 1956 issue of the Tennessee Division of State Parks *Newsletter*, tells of a "cheap" swimming pool in a Midwestern city, which turned out to be a poor investment. No tax money was used in building the pool, as labor and materials were donated by local residents; so state health department approval of the plan was neither sought nor required by law. Once the pool was in operation, however, the state health department was obliged to assume supervision. The very first test revealed that, because of improper design, the pool could not be operated safely, and bacteria in the first two water samples taken were too numerous to count. This experience illustrates the folly of cutting corners in planning and constructing a facility, such as a swimming pool, where health and safety are involved.
- Another recent account of a community which built, largely with the use of volunteer labor and materials, a blacktop fill-and-draw type pool, raises questions as to the wisdom of this type of installation.



T-shaped pool, Albany, Georgia. Note bathhouse and ample sundeck. Diving area is separated from swimmers by a float line. A Charles M. Graves design.

## Random Notes

- In Grants Pass, Oregon, the usefulness of an outdoor pool has been considerably extended and the unit cost of operation appreciably reduced through a cooperative arrangement with local schools. The pool is open from May first to October first or later, and during the period the schools are in session it is used regularly by the schools, which meet the full cost of operation during this time. It

MR. BUTLER is director of the NRA Research Department.

# Here and There with

is located adjacent to the high school and near the junior high school, on land donated to the city by the schools, and is open to the general public only during the summer months when the schools are not in session.

- The renting of caps to individuals using the municipal swimming pool has proved profitable in Klamath Falls, Oregon. One hundred dollars worth of caps are rented at ten cents per use and have yielded a profit of approximately \$1,200 a season. Caps are not rented in most pools around the country.
- The first instance of a fan- or wedge-shaped indoor pool that has come to our attention is in Ephraim, Utah, and is thirty feet to fifty feet by seventy-five feet.

## Sandsifter is a Boon

Successful operation of a new type of beach sandsifter by the Chicago Park District has led to a recommendation to purchase a second machine of this type, according to the American Public Works Association.

Basically, the device is a revolving drum, eight feet wide, housed under an enclosing metal cover. As it is dragged over a beach by a gas-powered tractor, scoops on the outer circumference of the drum dig into the sand to a depth of five inches. The scooped-up sand is tossed onto vibrating screens with a one-half-inch mesh and sifted back onto the beach, while debris moves along into two metal baskets which are removed and emptied as required. The tractor hauling the machine has a bucket on its front end for picking up the dumped debris, which is then emptied into a truck for removal.

Formerly, beach clean-up in Chicago was done by crews of men with rakes. To operate the new power-driven outfit, three men are needed, one to drive the tractor, the others to handle the baskets at the rear. Although exact figures were not available, there is a considerable saving in manpower with the new method.

## Staff Responsibilities

The success of any recreation program depends upon the high caliber of its staff. Swimming, a major factor in most recreation programs, is no exception. Consequently, the most valuable asset on pool or waterfront is a good life-guard staff.

It is unfortunate that cartoonists have lampooned guards to such a degree that the public has a tendency to think of them as beautiful hunks of men with no particular duties. Such is not the case, however. A lifeguard is on duty for the express purpose of protecting bathers and maintaining order. The importance of pre-service lifeguard training cannot be over-emphasized.



# Swimming Pools

Compiled by George Butler

*Basic requirements for a lifeguard are:*

1. Successful completion of a recognized life-saving course.
2. Satisfactory completion of an accredited first-aid course.
3. Good physical condition, a sense of responsibility and mental alertness.

*The primary duties of the lifeguard are:*

1. Standing watch or patrolling.
2. Giving aid to a bather in distress and the immediate administration of first aid when necessary.
3. Restricting swimmers to the boundary line of the swimming area.
4. Warning bathers of unseen hazards.
5. Daily inspection of life-saving equipment and effecting necessary repairs.
6. Maintaining order and enforcing established rules.

When patrolling or standing watch, a lifeguard must not permit his eyes to be diverted from the water. A child could drown in the length of time it takes to answer a question. A good lifeguard can handle many interruptions without turning his eyes from the water. Once a guard has been assigned his post he should leave it only to effect a rescue. Even then, he should by some prearranged signal notify other guards that his area will be unsupervised.

Since it is the duty of the lifeguard to prevent an incident as well as correct it, establishment of boundary lines for the swimming area on waterfronts other than pools is essential. This enables the guard to keep all bathers under constant surveillance and within easy reach in event of an emergency. No one, regardless of swimming ability, should be permitted to swim beyond the lines.

It is also the lifeguard's duty to warn all swimmers of unforeseen hazards. Many times even a good swimmer will become panicky should he step into a drop-off or get caught in a sub-surface current.

A good lifeguard assumes personal responsibility for everyone. He is constantly alert. He protects the bathers, not only from possible hazards of the water, but from themselves and each other. He practices life-saving skills regularly. He develops a pattern of teamwork with the other guards and lives up to his duties and responsibilities.

These factors make for good preventive *lifeguarding* and help to eliminate the need for unnecessary *lifesaving*. It's a good lifeguard who makes the difference.—*John W. MacEnroe, Recreation Consultant, New York State Youth Commission, in Swimming Pool Age, May 1956.*

## Elimination of Tax

At a recent hearing before the Subcommittee on Excise

Taxes of the House Committee on Ways and Means, Irving J. Rotkin, acting chairman of the Community Pools Association of Montgomery County, Maryland, strongly urged elimination of a twenty per cent tax now imposed on the initiation fees and annual dues of nonprofit community swimming pools.

Pointing out that these voluntary community groups were, in fact, carrying out a desperately needed function usually undertaken by government agencies, he asked for removal of what has proven to be a harsh burden upon citizens of moderate means. This was stated to be necessary to enable construction of even more community pools throughout the mushrooming suburban areas.

The demonstrated benefit to the community, on every level, was declared to be immeasurable in the area of wholesome family recreation and as "providing a healthy and constructive outlet for youthful energies during the summer months while away from the guidance and restraints of school (a most important factor in the juvenile delinquency problem)."

Mr. Rotkin stated, "Here is one of the all too rare instances where a group of citizens, having recognized a community need, did not raise a clamor for state or federal funds. On the contrary, they have and will continue to employ self-help in a truly democratic fashion." All that was asked was the removal of a punitive roadblock which served to hamper and discourage activity.

## Tulsa Swim Suit Campaign

This annual campaign, conducted for years, concerns the collection of old, outmoded, outgrown suits for distribution to children unable to buy suits for themselves. Mrs. Harry Rankin, president of the Hillcrest Medical Center Women's Auxiliary in Tulsa, Oklahoma, in charge of the campaign, writes: "Our radio station announces the campaign several times a day for three weeks preceding July 4. The slogan is 'Make a child happy for the Fourth of July.' Our large downtown stores, as well as outlying stores, place boxes in their lobbies or by the elevator for collection of the suits.



This bathhouse of modern design serves sixth outdoor municipal swimming pool in Oakland, California. The pool was put in operation in the spring of 1954.

A member of park department picks them up, and they are distributed to the various city parks. One of our largest laundries renovated the suits for years and is still willing to do so, but our park department has taken this over for the past few years. Publicity stresses the fact that having a suit of his own to use at the pool keeps a child from the old 'swimmin' hole' where there is so much danger of losing his life or becoming ill from contaminated waters. Also, a child with his own suit can join the recreation program offered by the park department." ■



Twenty-eight underwater lights, plus overhead lights and incandescent floods, make night swimming a real pleasure.

IT IS USUALLY true in municipal recreation," according to R. Foster Blaisdell, superintendent of recreation in Topeka, Kansas, "that when an adequate modern facility is provided for an activity—whether it be a playground, community center or athletic field—the increased operation cost, if any, is very small in proportion to the tremendous increase in the activity." Mr. Blaisdell offers figures to prove his point in his *1956 Swimming Pool Summary Report*, which shows how Topeka met the challenge of too many swimmers for its out-of-date pools.

In 1954, when the recreation commission took over operation of all the city's swimming pools, a program of swimming classes, synchronized and competitive swimming was inaugurated. During the 1955-1956 season, in addition to the summer program, the Washburn University pool was used on Saturdays, from November to May, for the training program for the paid and volunteer staff, as well as for general instruction and a synchronized swimming clinic under the direction of Theresa Anderson, vice-chairman of the National AAU Synchronized Swimming Committee. The training program for instructors produced eight water-safety instructors, two senior lifesavers and twenty-three water-safety aides. Each of

# Topeka's New Pool PAYS ITS WAY

Muriel E. McGann

the aides gave approximately fifty hours of volunteer teaching service during the next summer swimming season.

The enthusiastic response on the part of Topeka's citizens is shown by the increase in total attendance figures at all municipal pools over the past four years:

| 1953   | 1954    | 1955    | 1956    |
|--------|---------|---------|---------|
| 65,333 | 139,682 | 162,905 | 208,333 |

(Pools were operated by the recreation commission 1954-56.)

This tidal wave of swimmers gradually swamped the city's facilities. It became increasingly expensive to operate the superannuated pools and two actually had to be closed because it was impossible to maintain them at a proper standard of sanitation. One neighborhood pool was closed in 1954, another in 1955, and a third was reduced to half-day operation in 1956—and still the swimmers multiplied!

The most serious problem was Gage Park Pool, with its total area of nearly one and a half acres and 61,000 square

feet of water surface. This monster originally had been a muddy natural pond; its concrete lining was crumbling, its gravity sand filter was totally inadequate, and continuous superchlorination was waging a losing battle against the rising bacteria count. Old Gage was finally retired from service at the end of the 1955 season.

## New Pool

Fortunately, the long-range plan for Topeka, developed by the National Recreation Association, was already in operation, and a new Gage Park Pool was ready for customers on June 5, 1956. The pool is rectangular, measures 50 meters (164.04 feet) by 75 feet; depth ranges from 3 to 11.5 feet; capacity is 540,000 gallons and there are 14,450 square feet of deck surface and 12,300 square feet of water surface. The Sparkler diatomite filter has a capacity of 1,500 gallons per minute and a six-hour turnover. The Wallace-Tiernan A-626 (MSV) semi-automatic chlorinator is rated at 150 pounds in a twenty-

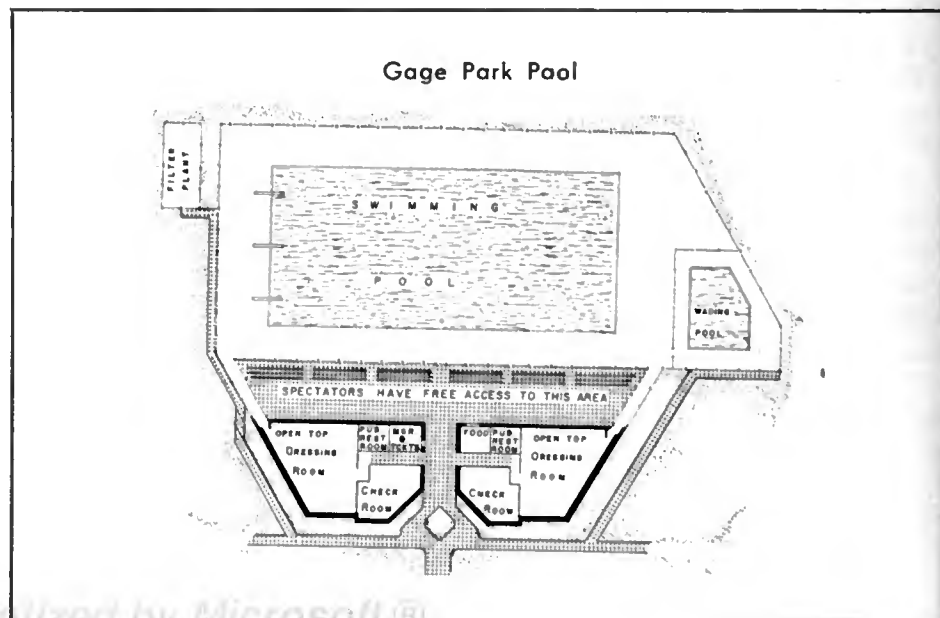

MRS. MCGANN is a member of the NRA research staff.

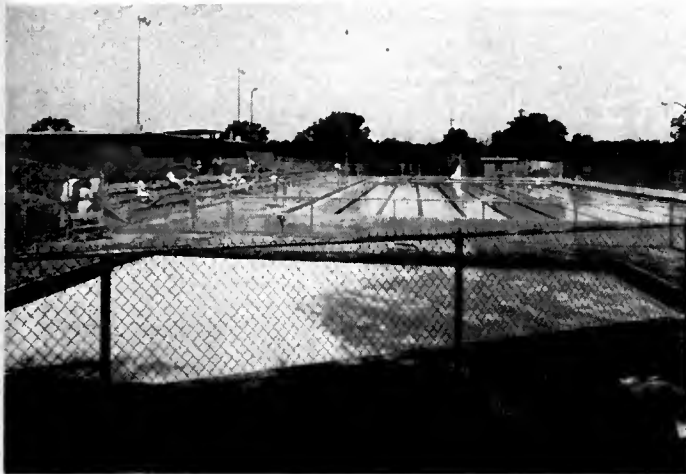

**Gage Park Pool, showing bathhouse, deck arrangements, kiddie pool. The pool is 164.04 feet (50 meters) by 75 feet. New pool helped put Topeka swimming program in black.**



**An average day park crowd. Permanent concrete bleachers, right, accommodate 350 spectators. A parking lot for 400 cars is behind the pool's open-air dressing rooms.**

four-hour period. Special features of the \$264,338 pool include a separate wading pool, permanent concrete bleachers for 350 spectators, open-air dressing rooms and a parking lot for four hundred cars. Twenty-eight underwater lights, in addition to overhead mercury vapor lights and incandescent floods, make night swimming a pleasure for both participants and spectators.

Mr. Blaisdell included in his report a special operating cost breakdown on the new pool, which was used for ninety-one days in 1956. Major items were: approximately \$15,000 for salaries and wages, nearly \$2,000 for chemicals, and \$1,000 for lights. The recreation commission has a special arrangement with the park department covering the use of water for the pools. Since they are not metered separately, the park department furnishes water without charge and in return receives the revenue from all concessions. Total operating cost to the commission was under \$20,000 for the first season; revenue amounted to nearly \$30,000 and concessions netted

more than \$3,000. The operation thus yielded a profit despite the fact that landscaping was not completed prior to the opening and several storms deposited silt in the pool, increasing cost of filtration and labor. Special expenses incurred in connection with the trial run also are included in this budget.

Admission fees at both the Gage and Garfield pools were thirty cents for adults and fifteen cents for children under twelve; no admission was charged at the three neighborhood pools. In 1956, for the first time, a registration fee of \$1.00 for Topeka residents and \$2.25 for non-residents was charged for the swimming instruction program. This resulted in a drop in registration, but the number qualifying for Red Cross certificates increased. The increase probably is attributable partly to the better teaching facilities at the new pool and partly to the fact that people are more likely to complete a paid course than a free one. No admission fees are charged during instruction periods.

Attendance at the old Gage Pool in 1955 was 65,423; the new pool accommodated 138,532 swimmers during the 1956 season—yet it cost only ten per cent more to run than its predecessor, while revenue doubled. Furthermore, the new pool was the major factor in putting the whole swimming program in the black, since there was a net gain of more than \$3,000 on the over-all pool operation, whereas the 1955 season showed a net loss of nearly \$11,000. As more of the old pools, which are so expensive to run, are replaced by the five new neighborhood pools specified in the long-range plan, it is reasonable to suppose that an even greater number of people will benefit from the swimming program.

Mr. Blaisdell seems to have proved his contention, for Topeka at least, that adequate modern recreation facilities are a sound community investment. Most important of all, the people of the city can learn to swim and enjoy the fruits of their learning in safe and pleasant surroundings at minimum cost. ■

**Wear Your Golden Age Club Pin With Pride Wherever You May Go**

Designed by representatives of over 100 Golden Age clubs and used nationally.

Gold colored metal with evergreen tree in jewelers' enamel. Symbolic of long life, strength and perseverance. The words LOVE, PLAY, LEARN, SERVE (greatest values of club membership) enameled in black. The border is a laurel wreath for honor. Safety catch.

*Available Only to Authentic Clubs.*

**50c each, minimum order 10 pins.**

**James Spencer & Co.** 22 N. 6th Street Philadelphia 6, Pa.

**MORE THAN**

**100,000**

**U. S. SCHOOLS AND COLLEGES EACH YEAR SPECIFY**

America's Finest Sports Equipment by

NEW YORK 11 DANVILLE, ILL. • LOS ANGELES 11

# Business Procedures in Pool Operation

C. P. L. Nicholls

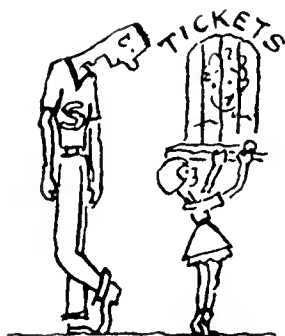

## Fees and Charges

The theory of municipal swimming pool charges in most American cities is built upon the payment, by the users, of the extra cost per unit of attendance over and above the average cost per unit of playground and recreation facilities. It is believed that taxpayers pay for their public recreation as a government function, along with other functions of government. There is a tendency, too often followed by administrative heads in charge of recreation and park departments, to feel that swimming pools, because of their popularity, should pay their way and even furnish additional revenue to the department. The inclination to raise swimming pool charges higher and higher is all too common. A sound basis for charges should be built, setting the fees at a sufficiently high figure to meet the extra cost per unit to the swimmer and which is average in any playground or park. For example, if the total cost of an area to the department, divided among the number of people using the facilities is fifteen cents per unit of attendance, and the cost of providing a swim per unit is thirty cents per unit of attendance, then a charge for the average of fifteen cents to the swimmer using the swimming pool is justified. The swimmer would thus be paying for the *extra cost only* because he chooses swimming as his activity, and the cost of swimming pool operation is high.

## Ticket Systems

The best ticket system is none at all, since the machinery for such a system is costly to provide, costly to collect, and is considered absolutely unessential to the good operation of the swimming pool. Any amounts of money lost through change-making, or otherwise, would not begin to add up to the cost of any ticket system that could be installed. A cashier making change and ringing up on the cash register is by far the best scheme of accounting for cash.

However, when ticket systems are installed, the electric ticket machine, together with the change-maker, is by far the best system known. This system is the same as that used in well-operated theaters. Two or even three cashiers may be necessary during rush periods. We believe shifts are unnecessary and cause unnecessary inconvenience to patrons, creating long waiting lines at the entrance gate.

---

MR. NICHOLLS is supervisor of aquatics in Los Angeles. This material was used in a paper especially prepared for a recreation conference (1953) in Long Beach.

## Reporting Within Department

The entire swimming pool operating staff should report directly to the supervisor of aquatics, or the superintendent of recreation in the smaller cities. However, the cashiers should be the direct line responsibility of the chief accounting officer, city treasurer, or person to whom the funds are directly accountable, and not of the superintendent of recreation or other recreation staff person.

*Daily Accounting.* Since the accounting for all cash register tapes and tickets and safety of the funds—through a bank or by operation of a safe—is the responsibility of people skilled in handling funds, it is not felt that this is a recreation responsibility involved in the direct operation of program and the handling of personnel and staff at the pool. For all duties, other than that of line responsibility affecting cash and accounting, cashiers should be responsible to the swimming pool manager for such items as registration for lessons, handing out information of events and schedules, maintaining order in the lobby and other details of operation. All control of money, the accounting and audits, is therefore made by the people who are held responsible.

## Checking Methods

*Valuables.* Checking all valuables should be done at the counter and by the person and at the place where fees are collected. As a sample system: a sealed envelope is handed the person whose valuables are to be checked; the patron thus places his own valuables in the envelope and signs his name on the envelope. It is then filed by the attendant in the proper cubbyhole or drawer set aside for the letter of the alphabet which is the patron's initial. When he calls again for his valuables, he signs a slip which is compared with the



signature on the checking envelope. After he departs, the envelope is retained by the cashier until the end of the day when *all* valuables are checked out. As an additional precaution these checking envelopes may be given a serial number with a tear-off coupon to serve as a receipt for the patron. The patron later on redeems his valuables by signing his coupon, and thus not only must the signature check, but the serial number as well. In Los Angeles we have found it unnecessary to employ the latter method. However, the clerk or cashier must never leave her compartment containing valu-

ables or cash unattended at any time.

**Clothing.** The most sanitary and space-saving method, and that best adapted to municipal swimming pools, is the plastic bag checking scheme. Los Angeles has, down through the years, tried all possible clothes-checking arrangements, including undressing booths, with the clothes checked therein and a key retained by the patron; steel lockers; wooden lockers; canvas checking bags; wire mesh baskets; and plastic checking bags. The latter method is now considered to be the most economical, sanitary, and desirable method.

**Rental Practices**

**Suits.** Some bathhouses still rent suits and towels. The experience with suits and towels in Los Angeles, over a period of years, has been that fifteen to twenty-five per cent of the towels were lost or stolen each year, making the cost of such service exceptionally high. When bathing trunks and swimming suits were rented it was found that in a very short number of years the style was completely outmoded and patrons became loath to wear them. Therefore, we have stopped the renting of any suits or towels entirely, encouraging the patron to furnish his own. We thus eliminate the laundry problem, cost of lost towels and suits, and capital expenditures for them. We feel that there is no argument in favor of furnishing suits and towels to municipal swimming pool

patrons. There can be no need from a sanitary standpoint, since the chlorinated water amply handles this problem, according to our experience and experiments.

**Swim Fins and Masks.** Swim fins can be issued free or rented, if desired. Face masks should not be allowed at the pool because of the danger of breaking glass and also the tendency of their use by perverts.

**Concessions**

It is common practice at European pools, and at many pools in private clubs in America, to have quick lunch restaurants or mechanical vendors to furnish a large variety of edibles and drinks, anything from a full meal to popcorn, soft drinks and cones. Coin-in-the-slot hair dryers, combs, and sanitary pads also are services normally provided at municipal swimming pools. One fact is sure: when people swim their appetite is stimulated. The degree to which municipal pools should go into the refreshment business, and whether they should run it themselves or let it out to concessionaires is a matter of policy for the operating agency to decide. The normal percentage of the gross revenue to the operating agency from various concessions and vending machines is from twenty-five to thirty per cent. Such revenue is always welcome, and the service is desired by the public using the pools. ■

*Hop-Hop-Hop your way  
to Hoppy Taw Day  
AUG. 17TH*



**National  
HOPSCOTCH  
TOURNAMENT**



**Winner receives**

- 1 10 day free trip to HOLLYWOOD
- 2 Appearance with Art Linkletter
- 3 A tour of DISNEYLAND
- 4 A ride in a HELICOPTER
- 5 Round trip flight on DC-7 by United Airlines

**BE ON TV  
with  
ART  
LINKLETTER**

**Contest Rules**

- Must be under 14 years of age and attend public school or recreation center
- Must be the winner of local Hoppy Taw tournament
- Must send one Hoppy Taw card with full name and address —plus name and address of school or recreational center, and name of instructor or teacher

For complete details write to:  
TOURNAMENT DEPARTMENT, HOPPY TAW CORPORATION  
927 South State Street, Salt Lake City, Utah

*Superior By Every Comparison!*



Rawlings  
V73V  
Official



**HERCULITE**

Rubber-Covered  
ATHLETIC BALLS



Rawlings  
358  
Official

So sensationally better are they on every count—design, construction, quality, durability and play-ability—that Rawlings HERCULITE Rubber-Covered Athletic Balls have established a new high standard. They're in a class by themselves—they're...

**"The Finest In The Field!"**

- VOLLEY BALLS
- BASKETBALLS
- SOCCER BALLS
- FOOTBALLS

RAWLINGS SPORTING GOODS CO. • St. Louis • Los Angeles • Dallas • Chicago

## CARVING WITH PLASTER OF PARIS

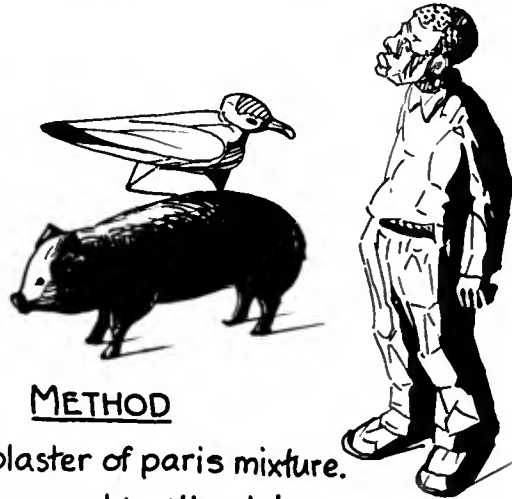

### METHOD

1. Make plaster of paris mixture.
2. Fill paper mold with mixture.

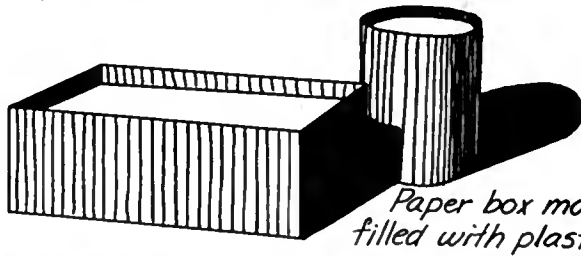

*Paper box molds filled with plaster.*

3. Remove paper mold after plaster of paris is hard.
4. Draw side view of object on side of plaster block.
5. Cut out two dimensional silhouette with coping saw.
6. Draw front view of object on front side of block.
7. Cut out two dimensional front view.
8. Shape big mass forms.
9. Cut out small forms and details.



*Two Dimensional Front View.*



*Side View.*

*Front View.*

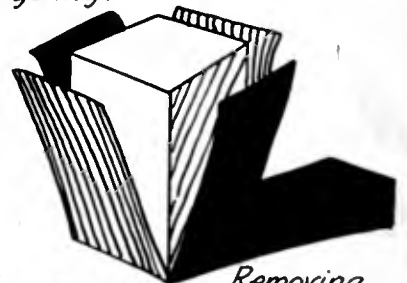

*Removing mold.*



*Two Dimensional Silhouette.*

### MATERIALS

Plaster of Paris ~ Knife ~ Paper Box ~ Mixing Bowl ~ Mixing Stick or Spoon.

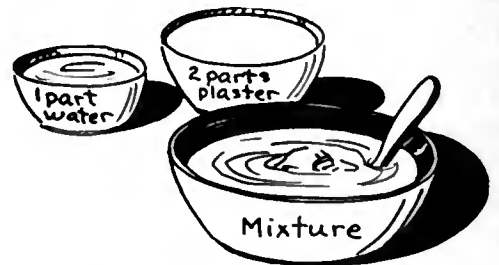

*Sift plaster of paris into water ~ Stir gently.*

# A May Party ~ on Rubber Wheels



Lucy Muir

COME ALONG with me and I'll show you happy people—people who are really enjoying their activities!

Laughter and friendly chit-chat will greet your ears. You may have to dodge a flying ball. You'll pass a room where teen-agers are shaking the walls with the latest hop steps; you'll see a journalism class where young adults with pencils behind their ears are putting a newspaper to bed; and, on the stage, actors stumbling through their lines. Mobiles dangle from the ceiling and original watercolors paper the wall.

The scene is familiar—a recreation center; but it is not the usual kind. This center, in San Francisco's Fleishhacker Pool Building, is for the handicapped. Here, crutches help a boy to pursue a ball; pottery is molded with toes by someone who cannot use his hands. Voices rise in song—out of tune, maybe, but, nonetheless, in song.

The Tuesday Young Adults whom we are about to meet, recently gave a May Day party. It all began the day the members returned from summer vacation. Wheelchairs, crutches and wheeled cots transported them to the discussion table as program planning got under way.

"Let's have a party planning class," someone said. The suggestion was noted on the program chart and the center's founder and director, Janet Pomeroy, consented to be instructor.

---

MRS. MUIR, who has been confined to a wheelchair for ten years with arthritis, joined the center in 1955. She is now studying creative writing at San Francisco State College, writes a "chatty" column for her local newspaper, is deputy registrar for her home community of Linda Mar, and does furniture refinishing as her main hobby.

A young member of this ingenious group of handicapped at the Recreation Center for the Handicapped, San Francisco, tells the story of their party—which could be put on by other groups of handicapped persons.

Sketches by Zyta Laky

By the end of six months, the class had given three parties—a Valentine party, a make-believe party and, the biggest and most challenging, a May Day party.



## Planning the Party

At the planning session for the May party, ideas flew back and forth enthusiastically. After boisterous nominating and voting, "Shower of Flowers" was selected as a theme. Committees were appointed—invitation, program, decoration, publicity, finance, food, and clean-up—and the work began.

Although the Tuesday program group is a small one, members made up a list of other young adults at the center and from the San Francisco Guild for Crippled Children and San Francisco State College, volunteer drivers and staff members, whom they might invite to the party. Also, each member was asked to bring one guest.

Assignments were given out, with each member's abilities and limitations in mind. Although each person was assigned to a committee, no hard and fast rules were adhered to as to what committee a person might help on if he had the time and was needed. Thus committees that had to await reports from others, such as finance, or had a limited sphere of activity, such as publicity, were able to assist with other major responsibilities in relation to program, decoration and food.

## Invitations

Those on the invitation committee gathered at the work table, in assembly-line order, with each doing his part, large or small. They cut the invitation stencil and laboriously turned the hand-operated mimeograph machine; folded the mimeographed sheets and decorated the front covers with crepe-paper and glitter umbrellas. The completed invitations were finally signed, sealed, and sent out RSVP to one hundred friends.

## Decorations

One of the girls deftly twisted crepe-paper and wood-fiber flowers onto plastic headbands to make crowns for the May queen and her attendants. Another rounded up a large square of canvas and paint and turned out a "Shower of Flowers" entrance sign. Others made crepe-paper flowers to be placed in colored-paper cornucopias for the wall decor. Large tree branches, painted green, were sprinkled liberally with flowers.



An old umbrella was re-covered to make a spring parasol to decorate the refreshment table. First the cloth was stripped from the frame; then twine was stretched from spoke to spoke, all the way around. Pink net was caught up in a pom-pom at the umbrella tip, draped over the twine, and sewed in place. The handle was covered with white poster paint and, while still wet, sprinkled with silver sparkles. Suspended over one end

P  
R  
O  
G  
R  
A  
M

of the refreshment table by invisible threads taped to the ceiling, the parasol added a gay spring touch to the decorations.



Two of the boys pooled their talents and built a wishing well—a large hoop of chicken wire covered with “paper rocks.” For days everyone saved their lunch sacks to be used in making artificial rocks. The bags were crumpled to give rock-like texture, cut open and spread flat, then colored with red, brown and green chalk. The four corners of each bag were gathered and stapled, squeezed into the shape of a rock and affixed to the wire frame with masking tape. The arch over the well was made from a piece of three-eighth-inch wood, curved and fastened to the wire frame. Crepe-paper flowers decorated the arch and a small can was suspended from it as a bucket. A pan of water was placed in the bottom of the well to catch the coins thrown in by people making a wish.

Three Maypoles for the Maypole Dance were made of one-and-three-eighths-inch dowling. The tops of the poles were drilled and wires run through the holes and attached to the ceiling light fixtures. The bottoms of the poles were secured to the floor with strips of masking tape. Eight streamers—strips of pastel crepe-paper one and a half inches wide—were fastened to the top of each pole.

### Finances

The total cost of the party was \$23.20—for food, \$15; decorations, \$3.70; invitations, \$2.50; program \$2.00.

### The Big Day Arrives

On the day of the party, the kitchen hummed with activity as the cooking class made cupcakes and chopped fruit for the strawberry punch. The party room was also a beehive of activity—

what with furniture moving, the decorating of the screen to serve as a background for the queen’s throne, and sundry other final preparations.

At seven o’clock, as a spotlight beamed on the wishing well and the Maypole streamers waved invitingly from their stately heights, the guests began to arrive. Each one was greeted cordially and presented with a corsage. The party activities were under way.

### Program

In the first game—an ice-breaker—an advertisement, cut from a popular magazine, was pinned on the back of each guest. He was asked to guess what he was advertising and had to go around asking other guests questions, such as, “Do I eat it?” and so on.

When the ice was well broken and all the guests acquainted, the three candidates for queen were introduced. A vote was taken and the newly elected queen was crowned and enthroned to reign over the Maypole Dance.



In the dance, four men and four women were assigned to each of the three poles. Dancers in wheelchairs were maneuvered by others who could push without use of their crutches. The men went in one direction and the women in the other. As a man met the first woman, he lifted his streamer over hers, then under the next one’s streamer, and so on, until the poles were wound to the bottom. Strauss waltzes were played all during the dance, and those who didn’t join enjoyed watching.

Next came a “Name That Flower” quiz. Players were asked to name the flower suggested by the following definitions, with three points given for each correct name:

1. Unattached-male fasteners.
2. Head coverings of a certain color.
3. Dawn in all its splendor.
4. Dripping organ of the body.



Even a traffic jam can be fun—when it’s accompanied by a lively Strauss waltz!

5. A domestic animal; a piece of tree.
6. Anger; the verb “to be.”
7. A sugary vegetable.
8. Gongs of color.
9. A container; a dairy product.
10. A proper noun; nil; lack of memory.
11. Be short of; a falsehood.
12. A body of water; period of time.
13. To mix; a beast of burden.
14. A green vegetable; a parent.
15. Give permission; a test tube.
16. A seasoning; insane.
17. A country; a conveyance.
18. A piece of wearing apparel; female.
19. A sweet substance; to nurse.
20. A wild feline; a flashy dresser.
21. Part of the face; a number.
22. A tot; a metal.
23. A flower that is precise.
24. Fabulous serpents; to break short.
25. Short for brother in color.
26. A bar that is lustrous.
27. Incite to action; a frolic.
28. A body of water; a container.
29. A type of wood; a girl’s nickname.
30. Miss one’s foothold; a bovine.
31. A joint; festive decorations.
32. To curse; to boast in triumph.
33. A luminous body of light in blossom.
34. A type of music that belongs to you.
35. To warm; a pronoun.
36. A cereal; a blossom.

### Answers

- |                        |                  |
|------------------------|------------------|
| 1. Bachelor’s-buttons. | 19. Honeysuckle. |
| 2. Bluebonnets.        | 20. Dandelion.   |
| 3. Morning-glory.      | 21. Tulip.       |
| 4. Bleeding heart.     | 22. Orchid.      |
| 5. Dogwood.            | 23. Primrose.    |
| 6. Iris.               | 24. Snapdragon.  |
| 7. Sweetpea.           | 25. Redbud.      |
| 8. Bluebell.           | 26. Goldenrod.   |
| 9. Buttercup.          | 27. Larkspur.    |
| 10. Forget-me-not.     | 28. Pansy.       |
| 11. Lilac.             | 29. Lupine.      |
| 12. Daisy.             | 30. Cowslip.     |
| 13. Aster.             | 31. Hollyhock.   |
| 14. Poppy.             | 32. Crocus.      |
| 15. Violet.            | 33. Sunflower.   |
| 16. Daffodil.          | 34. Jasmine.     |
| 17. Carnation.         | 35. Heather.     |
| 18. Ladyslipper.       | 36. Strawflower. |

The last activity of the evening was a situation game in which one group made up questions while the other group made up the answers without knowing what the questions would be. This game evoked lots of laughter and ended the party on a gay note. ■



## \* Bowling for All

Joe Falcaro and Murray Goodman. All the rules and skills of duck pin and tenpin bowling. A champion's tips on selecting and holding the ball, stance, footwork, approach, and deliveries. Relates aim, control, speed, and knowledge of alley conditions to accuracy in hitting pins. Gives full information on the organization and conduct of leagues, teams, tournaments, as well as current official rules and regulations. 3rd Ed. 59 action photos, sketches. 6½ x 10. Just published. \$3.

## \* Tumbling Techniques Illustrated

Ted Burns. Illustrations by Tyler Micoeau. For beginners and advanced students—a thorough coverage through text and illustrations, of the basic individual tumbling techniques. The series of stunts appear in a logical progression; book includes basic exercises, learning assists, and lesson plans. 304 practical ill. 6½ x 10. Just published. \$3.

## \* Handball

### Its Play and Management

B. E. Phillips. This new book identifies, explains, and illustrates fundamental handball skills: use of hands, proper footwork and body control, basic strokes, and good serving techniques. Detailed instructions on both one- and four-wall game. Also information on tournaments, scoring, court construction. 50 photos, diagrams. 6½ x 10. May. \$3.

★ All New additions in the Barnes Sports Library

The Ronald Press Company • 15 E. 26th St., N. Y. 10

years around-the world around...

**MacGregor**  
Sports  
Equipment

"The Choice of Those Who Play The Game"

The MacGregor Co. • Cincinnati 32, Ohio  
FOOTBALL • BASEBALL • BASKETBALL • GOLF • TENNIS

## Brand New! TITE-ROPER

UNIQUE • UNUSUAL • FOR  
TIGHTROPE WALKING FUN  
KIDS LOVE IT!

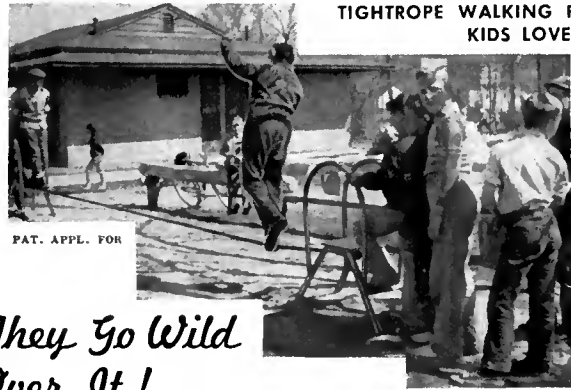

*They Go Wild  
Over It!*

COMPLETELY SAFE . . . . ONLY 16" ABOVE THE GROUND

Are you at your wits' end for something new and different in the playground? The sensational new Tite-Roper, the tight rope walking unit that holds the attention of youngsters for hours at a time, may be your answer. It's a natural because of children's inherent instinct to try to balance themselves. The Tite-Roper is a definite challenge to test their balance and equilibrium. Present users say it's the greatest thing since the sliding board. Appeals to all youngsters . . . both sexes, all ages. Will furnish entertainment for any number of youngsters at the same time. No specific skill or knowledge necessary. ¾" steel cable, 20' long, suspended from two ruggedly constructed platforms. No maintenance required. Write today for further details and prices.

**WISE ENGINEERING CO.** 165 DELANCY STREET  
NEWARK 5, N. J.

Designers and manufacturers of unusual playground  
and recreational equipment

**JUNE**

**NATIONAL  
RECREATION  
MONTH**

**LIVE ALL YOUR LIFE**



**ENGRAVING FREE!**

On All Trophies Purchased From

*National*

SAVINGS OF

**20% to 40%**

TROPHIES - MEDALS - PLAQUES

FREE CATALOG

*National* TROPHY SALES, INC.

75 W. Van Buren St. Dept. C-4 Chicago, Illinois



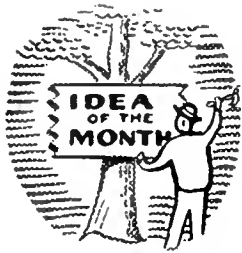

# The *ABLE-* *Disabled*

*We like the philosophy that ability and disability can go hand in hand. We like the independence of this club in working out its own program and its basic acceptance of civic responsibility. For those leaders or executives who have not yet included the handicapped in their programs, or who have worked only with handicapped children, this story of the Able-Disabled Club in Lima, Ohio, may serve as a model and incentive.*

**Patricia Morris**

**A** HANDFUL of physically handicapped persons responded to invitations from the recreation department in Lima, Ohio, to attend the first meeting of the "Able-Disabled Club" one year ago. Interest snowballed after that, and in a few months active membership included thirty persons.

A mailing list had been compiled and the recreation department had sent a mimeographed letter describing the proposed venture to all handicapped persons in the community. Reply cards indicating interest in such a club were returned by nearly all of those who had received them.

## **Organization**

Since that first meeting in January 1956, meetings have been held each month in the multi-purpose room of one of Lima's elementary schools. A one-step entry at the school makes the room easily accessible to those on crutches and in wheelchairs. Almost as important are the piano and adjoining kitchen facilities.

The group voted to name their organization the "Able-Disabled Club," a name which expressed their belief that ability and disability can go hand in hand. Officers have been elected—president, vice-president, secretary-treasurer, and historian—committees have been appointed, and a constitution and

---

PATRICIA MORRIS is general recreation supervisor in the Lima, Ohio, Department of Recreation. Anyone interested in the constitution of the Able-Disabled Club may write to her.

by-laws drawn up and adopted since that initial get-together. The object of the Able-Disabled Club, as stated in its constitution, is to "strive to promote the social, economic, and moral welfare of physically handicapped persons in general and of its members in particular."

Four classes of membership are provided—active, associate, junior, and honorary. Active membership is restricted to physically handicapped persons sixteen years of age and older. Because it was felt that there might be physically handicapped individuals in the community, eligible for membership but unable to attend meetings in person, who would like to be a part of the venture, provision was made for associate membership. While membership is primarily adult, since active membership is restricted to the physically handicapped aged sixteen or older, junior memberships are granted those under sixteen who, in the estimation of the membership committee, would benefit by membership and be an asset to the club. Honorary membership has been bestowed upon several non-handicapped individuals who have worked hard to make the club successful. Associate, junior, and honorary members have all the rights and duties of active membership except the right to hold office and to vote.

Concerned that no person should feel he could not afford to belong to the Able-Disabled Club, members agreed that no regular dues should be exacted. Instead, a voluntary collection is taken at each meeting.

Permanent committees are membership, program and finance. The membership committee, composed of five active members, makes inquiry concerning applicants for membership, determines their eligibility, and reports approved applications to the club. Although the set-up for the program committee is a unique arrangement, it has worked well. For each meeting a different member is in charge of the program and works with the recreation department supervisor in planning activities for the evening. Thus there are twelve program chairmen in the course of a year, and these twelve members comprise the program committee. The finance committee, headed by the treasurer, is charged with the duty of raising funds for club purposes.

Answering roll call at meetings of the Able-Disabled Club are persons disabled by disease, injury, and congenital problems. Cerebral palsy, polio, muscular dystrophy, blindness, and spinal injury are among the causes of disability represented.

## **Activities**

The Able-Disabled Club is fortunate in having in its membership several musicians who are generous with their talents. Members always enjoy gathering around the piano to sing familiar songs accompanied by one of the blind members who teaches piano and organ. There are some fine voices in the club. Another lively blind couple bring down the house when they sing folk songs and play their "revved-up" guitar. Another member plays the harmonica.

At one meeting a "games night" was planned. Tables were set up and such table games as checkers, Scrabble, Sorry and cards were played. At another meeting, members experimented with square dancing, wheelchairs, canes and all, under the direction of the recreation department supervisor. "We're lucky we escaped with our lives!" was one comment. But it was fun, and it proved and confirmed the suspicion that members were game to try practically anything. Films have been a popular source of entertainment, particularly as illustration for a speaker's text.

During the summer months a number of outdoor events have been enjoyed. A potluck picnic was attended also by members from two of the Indiana handicapped organizations, the Fort Wayne Samaritans and the Bluffton On-Our-Own Club.

The October program, a combination Hallowe'en and birthday party engineered by two of the club members, was a high point of the year, an aim for subsequent program chairmen. The party was held in a recreation hall in a near-by community. Decorated with witches astride broomsticks, a life-size skeleton, and orange and black crepe paper streamers, the hall looked a fit abode for goblins and masqueraders. Stretching diagonally across the hall, decorated to present the birthday theme, was a long table, sectioned off by months, where members were seated in their birth-month sections. Refreshments included the traditional birthday cake and ice cream.

Turkey sandwiches, pumpkin pie, coffee and hot chocolate made up the Thanksgiving menu for the November meeting. A word game devised by the program committee was played.

In December, the Christmas story was read aloud from a braille Bible; Christmas carols were sung; and there was an exchange of fifty-cent gifts. The Christmas menu was a potpourri of Christmas cookies, caramel corn, homemade candies, with each member contributing something, plus coffee.

Such interesting and different programs as the showing of a sound film on vocational rehabilitation by the local Goodwill Industries director, a musical comedy skit by a member of the Bluffton Club (a wheelchair-er with muscular dystrophy) and two associates will add significance and spice to future meetings of the Able-Disabled Club.

The Able-Disabled Club in its first year has become a potent and worthwhile part of the Lima community. Cooperation among members and their families is phenomenal. Come club night, members pool their cars in a share-the-ride network that greatly alleviates the ever-present transportation problem. After the meetings the boys fold and put away the chairs, while others make certain the kitchen is in apple-pie order. "You don't leave me much to do," the school custodian remarked after a recent club meeting. Refreshments for the first three meetings were provided by the Helping Hand Club, a local women's service club; but now that the club is on its feet, so to speak, each month's program chairman is responsible for preparing and serving light refreshments, paid for by the club, and here the mothers have done yeoman service.

When the club voted to sponsor a square dance to raise money for club purposes, virtually none of the members knew anything about sponsoring such an event; but each joined wholeheartedly in making posters, selling tickets, and all the other chores on which the success or failure of the affair hinged. The recreation department provided a large pavilion in one of the city parks, and a local square-dance band and caller furnished the music. Proceeds fattened the club treasury by some eighty dollars.

To those who have watched the Able-

Disabled Club grow, it seems impossible to overestimate its value. Recreation is essential to every individual and particularly to physically handicapped persons. The camaraderie of the monthly get-togethers, the parties and other activities fulfill the normal human need for a social life. Through the club, members have had greater opportunity to participate in community affairs and have demonstrated their community spirit by endorsing a bond issue for a new public library, before the last election, and making a gift of an assortment of books to the patients of a tuberculosis hospital.

Prior to joining the club, many members had ventured outside their homes only rarely; now they find themselves speaking up during business meetings and taking part in various club projects. While the Able-Disabled Club is sponsored and supervised by the recreation department, members have been encouraged to take the initiative. Thus membership in the Able-Disabled Club proves a valuable as well as an enjoyable experience. ■

**monroe**  
**FOLDING BANQUET TABLES**

If you are on the Board of your Church, Lodge, Club, School, etc., you will be interested in this modern Folding Banquet Table.

AND  
**MONROE TRUCKS**

Completely finished tops, resistant to most serving hazards. Used with or without table cloths.

Write for Table and Truck Catalog and special price discounts to institutions and organizations.  
Monroe Co., 181 Church St., Colfax, Ia.

**x-acto tools**  
**give hands added skill in ceramics**

**No. 63 CERAMIC SET**  
For sgraffito, slabwork, template making, incising, shaping, trimming and modeling. Contains 2 handles, 6 asst'd. scraper points, 2 knife blades. \$2.75

X-acto precision-made craft tools have always been preferred by both professional and amateur ceramists. Scraper points and blades are instantly interchangeable and can be purchased separately or in sets... wherever hobbies or ceramic supplies are sold.

**x-acto**

New HANDICRAFT Buying Guide .....25¢  
Wealth of ideas on hobbies and crafts.

**X-ACTO, INC.**  
48-99 Van Dam Street  
Long Island City 1, N. Y.

# Boys, Bikes - and Safety

S. Preston Douglas



Bicycle rodeos are a popular means of learning safety rules and proper control. This boy in Salinas, California, recreation department, is engaged in steering his bike along narrow line.

**F**OR THE past eight years, a happy youngster has won a beautifully-equipped bicycle—"grand prize" in the annual month-long Newport News (Virginia) Bicycle Safety Campaign.

The campaign begins the first of each May, with some five thousand school children taking part. During the month, youngsters amass points for excellence in four separate safety events. On the thirtieth of May, a colorful bicycle rodeo is held. In the grand parade, points are given for the best decorated bike, and for "win, place, show, or participating," in each of four field-day events. Top scorer for the month wins a new bicycle; reconditioned bikes go to second and third place winners.

This campaign to prevent bicycle

---

MR. DOUGLAS is chairman of the International Committee on Boys and Girls Work, Kiwanis International.

traffic accidents among school children is jointly sponsored by the Newport News Boys Club and the local Kiwanis Club with the cooperation of the board of education, recreation department and police department. Some such program was needed because of the tremendous increase of automobiles on the streets and the simultaneous increase of youngsters riding bicycles to school. This dangerous traffic situation was the result of the large increase in population during and after World War II.

Participation in the earliest bicycle safety campaigns was disappointingly small, but today they not only attract the large number of youngsters, but also garner considerable regional attention.

The campaign is divided into two parts or contests. The first, operating throughout all but the last day, includes the granting of points for the best safety scrapbooks, for tickets given by Newport News police to safe bike riders, for the best safety slogans submitted, and for the best answers to questions on bicycle safety. There are first, second, third, and participating prize winners for each of these. In addition to points, successful entrants in the preliminary contests also win merchandise prizes.

The other part of the campaign takes place during the final bicycle rodeo. Before a large crowd of students and parents, successful rodeo contestants win first, second and third prizes—and points toward the grand prize.

About a week after the rodeo, when the final scores have been compiled, an award ceremony is held, often in a major downtown auditorium. Here, grand and lesser prizes are presented.

The safety scrapbook competition is relatively new, but it has proved popular and is, according to Harry Shoff, the Boys Club program director, scheduled for permanent inclusion in the bicycle safety program. Entrants are encour-

aged to keep clippings of safety program publicity pictures of bicycles in action which are observing safety rules and to write essays on safety.

The competition which sees the granting of points for receiving a "safety ticket" from a member of the Newport News police force is really a passive competition. The youngster doesn't have to enter. He is in the contest automatically if he rides a bicycle in a Newport News school area.

Every day during the campaign, traffic policemen, in patrol cars, cruise areas around selected school grounds. When an officer sees a youngster obeying traffic regulations as he rides down the street—such as rendering proper arm signals and stopping at octagonal signs—he drives up to the rider, siren screaming and red light flashing. He pulls the youngster over to the curb (always in full view of his schoolmates) and soberly writes out a "safety ticket."

This ticket, in reality an acknowledgment by the police force that the youngster is a safe bike rider, may be redeemed for two passes to a local movie theater. The safety ticket is also good for twenty-five points toward the grand prize, but only one such point award is given to any one contestant. Newport News police have been enthusiastic about this dramatic type of safety training, and the youngsters love it.

The safety slogan contest is also good for points toward the grand prize and for individual awards. Youngsters participating are required to submit a ten-word slogan on bicycle safety to Newport News Boys Club headquarters. The best slogan wins forty points toward the grand prize; the second best, thirty points; third place, twenty points; and participation brings ten points.

Last of the pre-rodeo events is the forty-question safety quiz which entrants fill and send to Boys Club head-

quarters. Questions are the "yes" or "no" variety. They are not "catch questions," but test the boys thoroughly on their knowledge of the operation of the bicycle and the laws which govern its use. Boys who answer thirty or more of the questions correctly receive a handsome certificate suitable for framing, signed by the president of the Newport News Kiwanis Club and the local chief of police. Youngsters correctly answering all the questions receive, in addition, thirty-five points toward the grand prize.

Most colorful feature of the campaign is, of course, the bicycle rodeo. It begins with a parade of gaily-decorated bikes which pass in review before crowded stands. Young contestants spare no effort to make their bikes the best in the parade. Success pays off handsomely. The winner of the contest receives fifty points toward the grand prize; second-place winner, thirty-five points; third place winner, twenty-five points; and participants, fifteen points each.

Contestants wheel around the track to band music piped in through a public address system. A recent winner of the contest rode a bicycle decorated to resemble a Shetland pony and wore the colorful costume of a Mexican cowboy.

Skill events of the rodeo are designed to exhibit ability to handle bikes in the many difficult situations which occur in riding on city streets. In the "slow race," for example, the boys attempt to ride down a three-foot-wide lane, seventy-five yards in length. They are not permitted to touch either sideline. The youngster who finishes *last* is the winner. The event is designed to teach balance and ability to ride slowly in moving traffic. As in the other events, points are given.

In the "zig-zag race," the boys are taught coordination of mind and muscle. Contestants ride down a three-foot lane in the center of which quart-sized oil cans have been placed at six-foot intervals. Riders must stay inside the lane and zig-zag between the cans.

The "plank ride" is considered the toughest of all the skill-riding contests. In preparation for the event, a number of wooden planks, four inches wide and a quarter-inch thick, are laid end to end on the pavement. Contestants must ride down this narrow strip of wood-track without permitting either wheel to slip off onto the pavement.

The most popular race, at least the one which attracts the greatest number of entrants, is the "speed race." Originally, it was decided to eliminate this type of competition; but the youngsters—perhaps, naturally—were so anxious to participate in it, that it was finally allowed to remain in the schedule of events. Today, it is a permanent fixture.

With so many youngsters participating in the safety campaign, the number of grand prize points which must be catalogued and tallied is staggering. It would be a fitting climax to the bicycle rodeo if the three grand prizes and the many subordinate awards could be made immediately following the contests of skill. Unfortunately, the enormous job of counting points makes this an impossibility; so the award ceremony is held about a week later. This seeming liability has been turned into an advantage because it prolongs the

period to emphasise "safety," and it adds an element of suspense to the prize awarding.

The award ceremony takes place before a large crowd of Newport News students, parents and spectators. The Kiwanis Club supplies all prizes, making this donation a permanent part of their annual community service program. They also assist in publicizing the campaign and lend manpower, know-how, and technical assistance whenever called upon.

The bicycle safety campaign is now a permanent part of the Newport News scene. It also has been adopted completely or in part by other cities throughout the country, where a bicycle safety problem exists. One such community is Oswego, New York, where the campaign goes a step further and includes inspection and registration of bicycles as a qualification for entry in its various contests. ■

*[We're sure the boys enjoy this program—but don't Norfolk girls ride bicycles, too?—Ed]*

## NOW! 3 new duo-kilns

FOR ENAMELING  
& CERAMICS  
Chamber Sizes:  
8"x 9"x4½"  
11"x11"x6½"  
13"x13"x6½"

**Greatest Kiln Values Available!**

**A Model To Suit Every School,  
Studio or Hobby Need!**

Controlled heat, quick recovery Duo-Kilns range from only \$29.95 to \$107.50. They offer performance, dependability and price advantages far in excess of any other kiln group on the market! Before buying, get the Duo-Kiln facts and compare!

**WRITE TODAY!** We will rush our new kiln literature by return mail. A-1005

**DUO-KILN MFG. CO.**

2185 East 14th Street, Dept. 188  
Cleveland 15, Ohio

## THE PEDESTAL STOVE WITH THE ROOMY TOP!



## THE HANCOCK PARKMASTER

*Check These Exclusive Features:*

- Extra large cooking surface
- Wide dropshelves for utensils
- Means for padlocking on post
- Quick removal of ashes
- Low installation cost
- Positive draft control

Send for Complete Specifications and Prices

**HANCOCK IRON WORKS**

56 W. Pike Street, Pontiac, Mich.

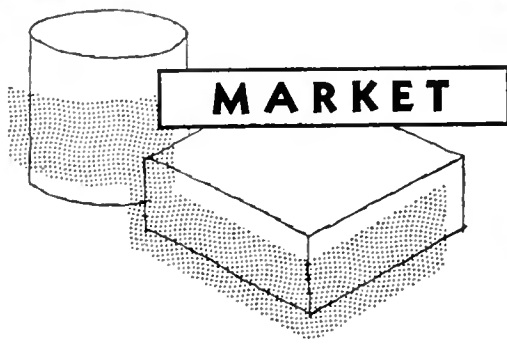

## NEWS

If you are interested in any of these products, write directly to the manufacturer at the address given. PLEASE mention that you read about it on RECREATION magazine's Market News page.

◆ The Hoppy Taw Party Kit provides five indoor games, good for rainy-day activities. It includes miniature hopscotch, a dartboard, figuring board, a horseshoe game and a new memory game called "21—or Bust." The company also puts out a hopscotch rulebook. Hoppy Taw Corporation, 927 South State Street, Salt Lake City, Utah.

◆ The new Hopkins swimming pool vacuum cleaner incorporates several new features, permits speedy and thorough cleaning of swimming pools, and comes equipped with a new-style wire-reinforced plastic hose—lighter and more easily handled than old-style reinforced rubber hose. Flexible plastic floats for the hose are indestructible.

The vacuum head, thirteen inches wide, with non-marking rubber bumpers and wheels and long-lasting brush, is of heavy cast aluminum (also available in brass). Adapters for handles and hose connection are of heavy brass. Screw-on handles are of one-and-a-quarter-inch aluminum in six-foot lengths. Pool owners desiring to operate vacuum units independent of filters may secure a complete portable unit: high-capacity motor, pump, and hair-trap mounted on a lightweight metal pushcart. Hopkins Equipment Company, Hatfield, Pennsylvania.

◆ A new Space Saucer which soars through the air more than one hundred feet to make a soft, three-point landing, is made of lightweight, durable plastic, ten inches in diameter. The bright-colored saucers are controllable, provide games for one, two or team play and develop skill and coordination. Space Saucer Company, Etna, New Hampshire.

◆ Table tennis bats faced with sponge rubber were first introduced by Japanese champions at the Table Tennis World Championships held in Tokyo. The sponge rubber facing adds greatly to the twists and spins which a player can put on the ball in serving and returning. Bats are available in both smooth or corrugated facing from Harvard Table Tennis Company, 60 State Street, Boston 9, Massachusetts.

◆ Leaves or other debris won't clog a new swimming pool cleaner, called the De-Bree Swimming Pool Vacuum Cleaning Unit, which features a self-priming pump with exclusive developments that enable it to pump all types of foreign matter without clogging. The powerful suction takes out algae, sediment and organic matter, keeping the pool clean without periodic draining. It is mounted on a two-wheeled cart for easy transporting. H & H Manufacturing Company, Inc., Department 51, Clifton Heights, Pennsylvania.

◆ A power saw, called the Moto-Jig, is designed especially for youth and adult handicraft programs. It weighs only twelve pounds and can be moved about easily. Rubber feet permit setting up shop practically anywhere; it requires no permanent mounting. A unique blade guard provides complete protection and it can even be operated by handicapped children. Its built-in rotary motor (not a vibrator) cuts up

to one-and-three-quarter-inch wood and has no exposed belts or pulleys. The Dreimel Manufacturing Company, Department C, Racine, Wisconsin.

◆ A rubberized compound, Saf-Pla, specially designed for playground surfacing, provides a resilient topping which cuts down on cuts, bumps and bruises when children fall. It is durable, weather resistant and can be applied to black-top, concrete or smooth penetration paving. U. S. Rubber Reclaiming Company, Inc., P. O. Box 365, Buffalo 5, New York.

◆ Jayfro shuffleboard sets with rubber-cushioned discs and lightweight aluminum cues are available in regulation and junior sizes, in deluxe or standard models. The reversible discs have a solid band of rubber permanently grooved around the edge to minimize breakage and noise. The cues are sturdily built with removable hardwood heads and plastic molded handles with finger-shaped grip. Jayfro Athletic Supply Company, P.O. Box 1065, New London, Connecticut.

◆ To keep up-to-date on recreation equipment and products send for free catalogues, charts and other materials offered by manufacturers. Do you have these?

• *Big Top of Tents* (Catalog 56-TI) includes all popular models of tents including concession tents, as well as various types of canvas covers and camping equipment. Hoosier Tarpaulin & Canvas Goods Company, P.O. Box 574, 1302-10 West Washington Street, Indianapolis 6.

• An illustrated catalogue on floodlighting covers cast aluminum vapor-tight pendant, ceiling and wall fixtures; wiring troughs, splice boxes and outdoor fittings; and sealed-beam floodlight lampholders. Stonco Electric Products Company, Kenilworth, New Jersey.

• A new color catalogue includes complete information on all types of soap dispensers and offers returnable samples. Bobrick Dispensers, Inc., Department R, 1214 Nostrand Avenue, Brooklyn 25, New York.

• New field and court dimension charts which include all the latest official dimensions are available in two sizes: 28" x 21½" and 17" x 11". The Advertising Department, The MacGregor Company, 4861 Spring Grove Avenue, Cincinnati 32, Ohio.

• A colorful catalogue (1957 edition) of swimming pool equipment and supplies includes many new items. Ocean Pool Supply Company, Inc., 155 West 23rd Street, New York City 11.

• The 1957 editions of the *Famous Slugger Year Book* and *Official Softball Rules* issued by Hillerich and Bradsby, Louisville 2, Kentucky, are now available from the company (include ten cents each to cover mailing) or from local sports dealers.

# ..... CLASSIFIED ADVERTISING .....

**RATES:** Words in regular type \$.15 each  
Words in boldface type \$.25 each  
Minimum ad accepted ... \$3.00

**COPY:** Type—or clearly print—your message and the address to which you wish replies sent. Underline any words you want to appear in boldface type.

**DEADLINES:** Copy must be received by the fifth of the month preceding date of the issue in which ad is desired.

Send copy with remittance to: RECREATION Classified Advertising, 8 West Eighth Street, New York 11, New York.

## HELP WANTED

**Teachers Wanted.** Physical Education. Experienced start to \$6000. Beginners to \$4450. No registration fee. Write for application. City Suburban Agency, 550 Fifth Avenue, N. Y. C.

**Group Workers,** men or women, race im-materal, for neighborhood centers. Salary \$3,800 to \$5,000 based on education, experience. Apply Neighborhood Settlement Association, 2123 East Ninth Street, Cleveland 15, Ohio.

## WORKSHOPS & CONFERENCES

**NRA New England District Recreation Conference—May 26-29—**at Poland Spring House, Poland Spring, Maine. For information, write: Waldo Hainsworth, District Representative, Fowler Road, Northbridge, Mass.

HELP WANTED • • POSITIONS WANTED • • SERVICES AVAILABLE • • WORKSHOPS & CONFERENCES • • EDUCATIONAL OPPORTUNITIES • • ITEMS FOR EXCHANGE

## Books & Pamphlets Received

**ABINGDON SONG KIT,** James F. Leisy. Abingdon Press, Nashville 2. Pp. 64. \$.50.

**EASY STEPS TO SAFE SWIMMING.** Art-craft Press, Cortland, New York. Pp. 60. Paper \$1.25.

**HOW TO TEMPT A FISH,** C. Robert Bil-brey, Editor. Popular Mechanics Press, 200 East Ontario Street, Chi-cago 11. Pp. 144. \$2.50.

**LOW COST TRIPS FOR THE WHOLE FAM-ILY** (Eastern U.S. and Canada), Rob-ert Meyer, Jr. Greenberg: Publisher 201 East 57th Street, New York 22. Pp. 220. Paper \$2.75.

**PARTNERS WITH YOUTH,** Dorothy M. Roberts. Association Press, 291 Broadway, New York 7. Pp. 175. \$3.50.

**SOFTBALL: OFFICIAL GUIDE AND RULE BOOK 1957.** Amateur Softball Assoc-iation, 11 Hill Street, Newark 2. New Jersey. Pp. 144. Paper \$.75.

**STAGE CREW HANDBOOK, A** (Revised Edition), Sol Cornberg and Emanuel L. Gebauer. Harper & Brothers, 49 East 33rd Street, New York 16. Pp. 291. \$4.50.

**STATE LAWS FOR PARKS AND RECREA-TION,** Betty van der Smissen. Ameri-can Institute of Park Executives, Og-lebay Park, Wheeling, West Virginia. Pp. 35. \$2.00.

**TAKE THE GUESSWORK OUT OF POOL PLANNING** (Revised 1957). Hoffman-

Harris, Inc., 425 Fourth Avenue, New York 16. Pp. 78. Paper \$5.00.

**TRAVELER IN THE WILDERNESS** (Eggert-Hatch River Expedition), Cid Rick-etts Sumner. Harper & Brothers, 49 East 33rd Street, New York 16. Pp. 248. \$3.50.

**VACATION CAMPGROUNDS** (Southeastern Edition), Charles and Kay Hultquist. Vacation Campgrounds, Box 265, Maryville, Tennessee. Pp. 126. Paper \$.75.

**WILDERNESS TRAILS.** Boy Scouts of America, New Brunswick, New Jer-sey. Pp. 59. Paper \$.75.

**PARKS** are the setting for many Recreation Programs.

**PARK** administration and know-how aid and complement *your* work.

The **PARK** and **RECREATION** pic-ture is a dynamic, changing one.

Only one magazine leads in com-plete coverage of this field:

- from new products to new presidents of societies
- from how to put a bond issue across to the latest **SWIMMING POOL** data and design.

Join our family of over 14,000 readers who use PM as their working tool.

Send your purchase order to:

## PARK MAINTENANCE

Dept. R

P. O. Box 409

Appleton, Wisconsin

One year—\$3.00 Three years—\$7.50

Groups of five or more, one year—  
\$2.00 per person.

## IDEA BOOK 64 PAGES!



### ENAMEL-ON-COPPER

Learn jewelry making; latest enam-eling processes and techniques from step-by-step illustrated instruc-tions. Book lists many new copper items, complete supplies, tools & equipment. Send for your copy of this valuable reference book today! It's FREE

**THE COPPER SHOP**  
A Div. of Immerman & Sons • Dept. 194  
2185 East 14th • Cleveland 15, Ohio

## INDEX OF ADVERTISERS

|                                          | PAGE               |
|------------------------------------------|--------------------|
| American Playground Device Company ..... | 165                |
| Arkansas State Hospital .....            | 165                |
| Association Films .....                  | 167                |
| Beltz Engineering Laboratories .....     | 191                |
| Cleveland Crafts Company .....           | 167                |
| The Copper Shop .....                    | 191                |
| Dimco-Gray Company .....                 | 165                |
| Duo-Kiln Manufacturing Company .....     | 189                |
| Greenwich Book Publishers .....          | 167                |
| H. & R. Manufacturing Company .....      | 192                |
| Hancock Iron Works .....                 | 189                |
| Hillerich & Bradsby .....                | Inside Front Cover |
| Hillyard .....                           | 161                |
| Hoppy Taw Corporation .....              | 181                |
| Jamison Manufacturing Company .....      | 167                |
| Jayfro Athletic Supply Company .....     | 171                |
| J. C. Larson Company .....               | 165                |
| The MacGregor Company .....              | 185                |
| Monroe Company .....                     | 187                |
| National Sports Company .....            | 166                |
| National Studios .....                   | 165                |
| National Trophy Sales .....              | 185                |
| Newcomb Audio Products Company .....     | 166                |
| Park Maintenance .....                   | 191                |
| Rawlings Sporting Goods Company .....    | 181                |
| The Ronald Press Company .....           | 185                |
| James Spencer & Company .....            | 179                |
| Square Dance Associates .....            | 171                |
| Superior Industries Corporation .....    | 167                |
| Voit .....                               | 179                |
| Wise Engineering Company .....           | 185                |
| X-acto, Inc. ....                        | 187                |

## ICE WHEN YOU WANT IT

with  
**BELTEMP**

artificial ice skating rinks by  
**BELTZ ENGINEERING LABORATORIES**  
11021 Whittier Avenue  
Detroit 24, Michigan. Venice 9-1811

# NEW

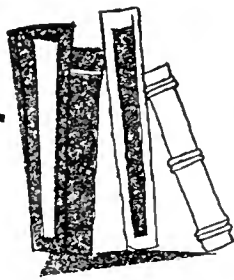

## PUBLICATIONS

*Covering the Leisure-time Field*

### Illustrated Games, Rhythms and Stunts for Children

(Upper Elementary Grades)

Frank H. Geri. Prentice-Hall, Englewood Cliffs, New Jersey. Pp. 304. \$2.95.

Even if we didn't know that Frank Geri is director of playgrounds in Bellingham, Washington, we'd still know that someone with direct and personal experience on playgrounds had written this book. The chapter on safety, for example, is a dead giveaway. What person unfamiliar with playground situations, or how children behave on apparatus, could have included, "Guard against the use of wax paper bread wrappers to make the slide slick"?

The lively illustrations, on which several artists collaborated, not only clearly explain the games and game formations, but depict as diverting a set of young hellions as any playground leader has ever seen. Those illustrations are worth the cost of the book!

Mr. Geri's preface and opening chapter are short but successfully explain his purpose. The book deals primarily with that nine-to-twelve-year-old group that is nature's best answer to perpetual motion. He emphasizes the importance of games in teaching body skills, and the need for proper instruction so that, at home or at unsupervised periods, the youngster not only knows what to play, but how to play, in order to get the most satisfaction from the activity.

The book is divided into a number of game categories: tag, circle, nature, limited area, relays, hardtop, and goal

games, an excellent section on rhythms, including very sound suggestions for teaching simple folk and square dancing. It also includes rules for jacks, rope jumping, hopscotch and other traditional, seasonal games, as well as basic techniques for instruction in the high-organized games of soccer, baseball and softball, as well as lead-up games in these.

This is not "just another game book." Its good natural, realistic approach, clear explanations and emphasis on having *reasons* for games makes it particularly effective for a new staff, or for a staff that has become "settled" in its game program. — *Virginia Musselman, NRA Program Service.*

### Home Play for the Preschool Child

June Johnson. Harper & Brothers, 49 East 33rd Street, New York 16. Pp. 140. \$2.95.

This is a book for parents. It is also a book for recreation leaders and departments to use in giving workshops on home play, or to answer the mothers who ask, "What should I do for recreation for my child at home?"

The soundness of its information and philosophy is testified to by the fact that Dr. Frances L. Ilg, director of the famed Gesell Institute of Child Development, has written the introduction, and says, "This is the very type of book we have wanted to recommend to parents. To have all of these ideas and suggestions under one cover will be a wonderful help for both parents and teachers."

### Parade and Float Guide

L. F. Vaughn. T. S. Denison and Company, Minneapolis 15. Pp. 162. \$5.00.

This is a most unusual and fascinating book by a famous float and parade expert. While it will not be particularly useful for simple little playground parades or floats, it should be a boon for the large, community-wide, splendid affairs. In addition to many diagrams, suggestions for building and decorating, plans for organization, it contains interesting chapters on parades through the ages. Photographs, prints and drawings add to the usefulness of this book.

### Home Aquarium Handbook

Griffith and Lillian Borgeson. Arco Publishing Company, 480 Lexington Avenue, New York 17. Pp. 143. \$2.00.

If you have, or wish to have, an aquarium of tropical fish, this how-to book is one to pore over like a garden catalogue in winter. It tells how to get started, and what to buy or make. It lists and describes varieties of tropical fish and their habits. More than three hundred illustrations and photographs will keep you busy for hours—and perhaps lead you to an interesting new hobby.

### Seed on the Wind

Bill Geagan. Coward-McCann, 210 Madison Avenue, New York 16. Pp. 192. \$3.00.

Bill Geagan, known for his radio, television and newspaper work, as well as for several books on the out-of-doors, has written a simple heart-warming book designed to emphasize to fathers (and leaders, we hope!) the importance of outdoor experiences to their boys. The author's experiences, with his own motherless nephew and with other boys, good and bad, in the Maine woods, are full of humor, pathos and interesting nature lore.

His definition of a boy will please every dad: "A boy is one of the great wonders and one of the most valuable things in our world. He is the future with a freckled face and skinned elbows—the future straining with tremendous energy in a fierce, bewildering tangle of wonder, hero-worship, enthusiasm, imagination, appetite, and mild mischief."

### The Bird Biographies of John James Audubon

Selected and edited by Alice Ford. Macmillan Company, 60 Fifth Avenue, New York 11. Pp. 282. \$10.00.

Most bird lovers are familiar with Audubon's great folio, *The Birds of America*. Not so many, however, have read the volumes written by Audubon as text to the folio. First published in five volumes between 1831 and 1839, they not only tell about the birds and their habits, but also represent a real piece of Americana.

Miss Ford, an outstanding Audubon authority, has gone back to the original volumes, and has followed Audubon's wish for "a pleasing book as well as an instructive one."

The illustrations, excellently reproduced, are from Audubon's original watercolor and chalk drawings, not the familiar engravings, and will be a delight to those who add this book to their personal nature library. It is indeed a book to treasure.

NEW AND IMPROVED

## RYAN'S H. & R.

### DRY LINE MARKERS

5 DIFFERENT MODELS

From 20# to 100# Capacity

Fargo Feed — Instant Shut-off — 50 lbs. capacity.

Shaker in Hopper for Constant Flow.

Adjustable Control on Handle.

**SAVES TIME AND MATERIAL**

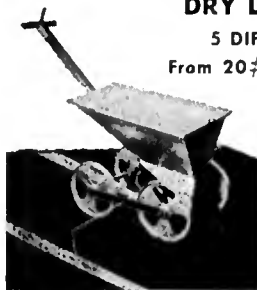

Send to Dept. R for booklet on four other models  
H. & R. MFG. CO., LOS ANGELES 34, CALIF.



# Recreation Leadership Courses

Sponsored by the National Recreation Association

and

Local Recreation Agencies

May, June and July, 1957

|                                                                       |                                         |                                                                                                  |
|-----------------------------------------------------------------------|-----------------------------------------|--------------------------------------------------------------------------------------------------|
| HELEN M. DAUNCEY<br>Social Recreation<br>and<br>Playground Recreation | Youngstown, Ohio<br>June 13-14          | O. S. Ellis, Director-Treasurer, The Youngstown Playground Association, 2218 Ohio Avenue         |
|                                                                       | York, Pennsylvania<br>June 17-18        | Mrs. Sylvia C. Newcombe, York Recreation Commission, 32 W. King                                  |
|                                                                       | Lancaster, Pennsylvania<br>June 19-20   | Albert E. Reese, Director of Recreation, 135 N. Lime Street                                      |
|                                                                       | Durham, New Hampshire<br>June 24-27     | Miss Patricia L. Olkkonen, Recreation Specialist, University of New Hampshire                    |
| ANNA S. PHERIGO<br>Playground Recreation                              | Whitinsville, Massachusetts<br>July 1-2 | Roscoe M. Marker, Supervising Director, Town of Northbridge Playground and Recreation Commission |
|                                                                       | Toledo, Ohio<br>June 10-13              | Arthur G. Morse, Division of Recreation, 214-18 Safety Building                                  |
|                                                                       | Youngstown, Ohio<br>May 18              | Miss Sally Davis, 1202 East Indianola Avenue                                                     |
| GRACE WALKER<br>Creative Recreation                                   | Montgomery, Alabama<br>June 4-8         | William L. Brannon, 1001 Tuscaloosa                                                              |
|                                                                       | Great Falls, Montana<br>June 10-23      | Miss Margaret Bucher, Director of Education, Montana Farmers Union, Box 2089                     |
|                                                                       | Toledo, Ohio<br>June 10-13              | Arthur G. Morse, Division of Recreation, 214-18 Safety Building                                  |
| FRANK A. STAPLES<br>Arts and Crafts                                   | Altoona, Pennsylvania<br>June 15        | Stuart E. Nolan, Assistant Superintendent of Recreation, Lexington Avenue and Tenth Street       |

---

Attendance at training courses conducted by National Recreation Association leaders is usually open to all who wish to attend. For details as to location of the institute, contents of the course, registration procedure, and the like, communicate with the sponsor of the course as listed above.

---

Miss Dauncey will conduct recreation leadership courses for the United States Air Force in Europe May 1-31

---

Mr. Staples will conduct arts and crafts courses at air bases in the following areas; for further information write directly to the Air Force Regional Representatives listed:

|                |                        |                                                            |
|----------------|------------------------|------------------------------------------------------------|
| April 29-May 9 | Pacific Southwest Area | Linus L. Burk, 1345 Lincoln Avenue, San Rafael, California |
| May 13-June 6  | Midwest Area           | Howard Beresford, 3055 Bellaire, Denver 7, Colorado        |

# Send for Complete Details Now!

## Baseball - Softball Team Accident Insurance for Affiliate Member Agencies of NRA

Underwritten by  
American Casualty Company  
of Reading, Pennsylvania

---

NATIONAL RECREATION ASSOCIATION  
8 WEST 8TH STREET,  
NEW YORK 11, NEW YORK

Gentlemen: Rush me details about the 1957 NRA Baseball-Softball Team Accident Insurance.

Name .....

Address .....

City..... State.....

Name of Team .....

Henry Pfister Library  
MacMurray College  
Jacksonville, Illinois

JUN 17 1957

# Recreation



NATIONAL RECREATION ASSOCIATION

JUNE 1957 • 50c

**CHOOSE  
THE BATS**



*and the*  
**GOLF CLUBS**



**THAT PACK  
THE POWER**

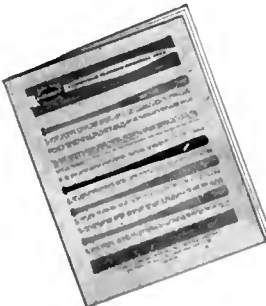

**LOUISVILLE SLUGGER  
BATS  
HILLERICH & BRADSBY CO.  
LOUISVILLE, KY.**

**Louisville  
GRAND SLAM  
Golf Clubs**

*We will be glad to send you copies of the 1957 Louisville Slugger Bat and Grand Slam Golf Club Catalogs for your ready reference in ordering from your dealer. Address Hillerich & Bradsby Company, Dept. R-7.*

**HILLERICH & BRADSBY CO., INC., Louisville 2, Ky.**

When writing to our advertisers please mention RECREATION.

# New Table Tennis Tables

**100% Aluminum**  
EXTRA HEAVY DUTY

ESPECIALLY DESIGNED FOR HEAVY DUTY USE  
*Indoors or Outdoors*

Official Regulation SIZE and BALL BOUNCE

MADE IN 2 SECTIONS      4 LEGS TO EACH SECTION

Nationally recognized and used by the ARMED FORCES, COLLEGES, MUNICIPALITIES, RECREATION CENTERS, SCHOOLS, CLUBS, PARKS, etc.

- No Maintenance or Replacement Problems.
- Sturdy Lifetime Construction.
- Heavy Duty Anodized Aluminum throughout.
- SECURELY INSTALLED HEAVY GAUGE ALUMINUM CENTER NET—ALSO AVAILABLE.

For FULL DETAILS WRITE  
**ALL METAL TENNIS TABLE CO.**  
P.O. BOX 142, TEANECK, N.J.

**Wear Your Golden Age Club Pin With Pride Wherever You May Go**

Designed by representatives of over 100 Golden Age clubs and used nationally.

Gold colored metal with evergreen tree in jewelers' enamel. Symbolic of long life, strength and perseverance.

EXACT SIZE      The words LOVE, PLAY, LEARN, SERVE (greatest values of club membership) enameled in black. The border is a laurel wreath for honor. Safety catch.

Available Only to Authentic Clubs.  
50c each, minimum order 10 pins.

**James Spencer & Co.**      22 N. 6th Street  
Philadelphia 6, Pa.

**BOOK MANUSCRIPTS**  
CONSIDERED

by cooperative publisher who offers authors early publication, higher royalty, national distribution, and beautifully designed books. All subjects welcomed. Write, or send your manuscript directly.

**GREENWICH BOOK PUBLISHERS**  
Attn. Mr. Hitchcock      489 Fifth Avenue  
New York 17, N. Y.

**ICE WHEN YOU WANT IT**  
with  
**BELTEMP**

artificial ice skating rinks by  
**BELTZ ENGINEERING LABORATORIES**  
11021 Whittier Avenue  
Detroit 24, Michigan.      Venice 9-1811

*designed by a champion for championship performance*

**American Approved**

*Jim Patterson's*  
**lifetime**  
**ALUMINUM Diving Board**

**World's Finest Official Regulation Board**  
*Lifetime Construction, Unequaled Performance and Safety*

**RADICALLY DIFFERENT** in design and construction, unequaled in performance by any other board you've seen.

**BUILT LIKE AN AIRPLANE WING**—Aircraft structural design combined with spring-leaf principle and heat-tempered, specially alloyed aluminum are joined in an assembly of great strength, uniform flexibility and incomparable springing qualities.

**PRACTICALLY UNBREAKABLE**—Many times stronger than actual load requirements—will withstand severest use day after day, yet continue to give unmatched performance and maximum springing action year after year, free of repairs or replacement.

**SPRING-LEAF CONSTRUCTION** gives much greater strength at fulcrum where needed, and lightness at tip.

**EFFORTLESS TAKE-OFFS, MORE HEIGHT WITH LESS EFFORT**—No other board has such buoyant springing qualities or is so stable underfoot. Built-in resilience lasts as long as the board.

**SAFEST DIVING BOARD EVER DESIGNED**—Aircraft structure eliminates torque (twisting action) at tip of the board. Battleship Safety Tread, 18" wide, safest non-slip covering known.

**WEIGHS LESS** than conventional wood or coated wood boards, easier to install or remove. The only board that fits *any* regulation diving standard.

**ENDS BROKEN BOARD PROBLEM**—eliminates repair and replacement expense indefinitely, pays for itself in a few years. The entire board is anodized for permanent protection against salt water and all corrosion.

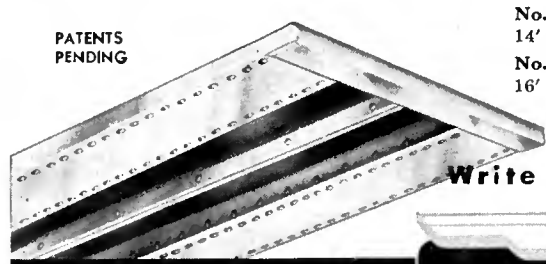

No. APL-14 Lifetime Aluminum Board  
14' long, weight 130 lbs. . . . **\$329.50**

No. APL-16 Lifetime Aluminum Board  
16' long, weight 140 lbs. . . . **\$349.50**

**Write for Literature**

**EXCLUSIVE DISTRIBUTORS**

WORLD'S LARGEST MANUFACTURERS OF FINE  
PARK, PICNIC, PLAYGROUND, SWIMMING  
POOL AND DRESSING ROOM EQUIPMENT

**AMERICAN**  
PLAYGROUND DEVICE CO.  
ANDERSON, INDIANA, U.S.A.

**NOW!**  
**3 new duo-kilns**

FOR ENAMELING & CERAMICS  
Chamber Sizes:  
8" x 9" x 4 1/2"  
11" x 11" x 6 1/2"  
13" x 13" x 6 1/2"

**Greatest Kiln Values Available!**  
**A Model To Suit Every School, Studio or Hobby Need!**

Controlled heat, quick recovery Duo-Kilns range from only \$29.95 to \$107.50. They offer performance, dependability and price advantages far in excess of any other kiln group on the market! Before buying, get the Duo-Kiln facts and compare!

**WRITE TODAY!** We will rush our new kiln literature by return mail.      A-1005

**DUO-KILN MFG. CO.**  
2185 East 14th Street, Dept. 211  
Cleveland 15, Ohio

**FREE!**



# THIS BIG ILLUSTRATED LEATHERCRAFT CATALOG

There is no finer source of materials for Leathercraft projects of all kinds . . . easy-to-assemble kits to enable beginners to make billfolds, gloves, purses, belts and other attractive items . . . top quality tooling and carving leathers for advanced craftsmen. Also complete line of Leathercraft tools, accessories, supplies and instruction books.

## ATTENTION METALCRAFT HOBBYISTS

Here is a comprehensive illustrated catalog from which you can make your selection of aluminum and copper in sheets and shapes for many projects; copper, aluminum and brass foil for metal tooling; kilns, colors and kits for metal enameling; instruction books, tools and accessories for metalcraft of all kinds.

SEND TODAY FOR EITHER  
OR BOTH FREE CATALOGS

### J. C. LARSON CO.

820 S. TRIP AVE., DEPT. 7105  
CHICAGO 24, ILLINOIS

PARKS are the setting for many  
Recreation Programs.

PARK administration and know-  
how aid and complement your  
work.

The PARK and RECREATION pic-  
ture is a dynamic, changing  
one.

Only one magazine leads in com-  
plete coverage of this field:

- from new products to new presidents of societies
- from how to put a bond issue across to the latest SWIMMING POOL data and design.

Join our family of over 14,000  
readers who use PM as their  
working tool.

Send your purchase order to:

### PARK MAINTENANCE

Dept. R  
P. O. Box 409  
Appleton, Wisconsin

One year—\$3.00    Three years—\$7.50  
Groups of five or more, one year—  
\$2.00 per person.

new  
completely  
revised  
edition!

# "PLANNING FACILITIES"



## Ideas, Plans, and Suggestions

For Every Type of Modern  
Indoor and Outdoor Facility

- Athletic Fields • General Plant Features
- Park-School Facilities • Resident Camps
- Stadiums • Field Houses • Gymnasiums
- Recreation Buildings • Swimming Pools
- Health Suites • Service Areas

Written by the foremost  
experts in the united states

Here are the latest recommenda-  
tions and ideas presented by Amer-  
ica's leading facilities specialists.  
City planners, architects, landscape  
architects, schoolhouse construc-  
tion consultants, and engineers  
joined with outstanding athletic,  
recreation, physical and health  
education leaders in producing this  
indispensable facilities plan-book.  
It's their handbook for planning  
indoor and outdoor facilities . . .  
make it yours, too!

**\$2<sup>50</sup>** POSTPAID  
No C.O.D.'s

Send orders to:  
**THE ATHLETIC INSTITUTE**  
209 So. State St.  
Chicago 4, Illinois

**HONOR YOUR PARTNER**

**Instructional Records**

GUARANTEED NOT TO BREAK  
CHIP OR CRACK

Available on 78 RPM or LP (33 1/3 RPM)

Ed Durlacher's "Talk-Through; Walk-Through" System of Simplified Progressive Instruction, followed by the Complete Dance.

SQUARE DANCE ASSOCIATES  
P. O. Box 644, Freeport, N. Y.

Mail coupon for FREE brochure on all Honor Your Partner Teaching Aids  
SQUARE DANCE ASSOCIATES P. O. Box 644, Freeport, N. Y.

Gentlemen: Please send me free brochure of Honor Your Partner Teaching Aids,

Name \_\_\_\_\_

Address \_\_\_\_\_

City \_\_\_\_\_ Zone \_\_\_\_\_ State \_\_\_\_\_

# Recreation\*



THE MAGAZINE OF THE RECREATION MOVEMENT

*Editor in Chief, JOSEPH PRENDERGAST*  
*Editor, DOROTHY DONALDSON*  
*Editorial Assistant, AMELIA HENLY*  
*Business Manager, ALFRED H. WILSON*

ASSOCIATE EDITORS  
*Recreation Administration, GEORGE BUTLER*  
*Program Activities, VIRGINIA MUSSELMAN*

Vol L. Price 50 Cents No. 6

**On the Cover**

TEDDY THE HERMIT spins a yarn filled with the magic of the sea. Remember the beaches when you were a boy—the shells, driftwood and other mysteries hidden in the clean white sand? Why, some of these things might have been washed all the way from China! (Let us make our shorelines available for the enjoyment of all people.)

Teddy lived as a squatter in the Florida state parks until his death about two years ago. Photo courtesy C. H. Schaeffer, Florida Board of Parks.

**Next Issue**

September RECREATION will be our next issue. This is the Congress issue of the magazine, and will carry an article on the recreation facilities in Long Beach, which delegates will have the opportunity of seeing during Congress time—as well as last-minute Congress information on meetings, speakers, arrangements. Among the other contents will be a symposium on “What’s Doing in Riflery Programs” in different parts of the country; a summary of the new Girl Scout survey of adolescent girls; an article on publicity and decorating for parties by a Service Club director; and possibly “New Vistas in Recreation Through the Use of Tranquilizing Drugs.” This last is a digest of the excellent talk given by Dr. Maurice E. Linden at Philadelphia.

**Photo Credits**

Page 202 (cartoon). courtesy The Hall Syndicate, Inc., New York City; 204, courtesy Massie, Missouri Resources Division; 205, William A. Garnett, Altadena, California; 217 (upper right), Sante Fe Railway; 222, William Z. Harmon, Sarasota, Florida.

**CONTENTS**

**GENERAL FEATURES**

Let’s Save Our Recreation Lands (Editorial) *Walter S. Blucher* 197  
 New Dimensions in Recreation.....*Joseph Prendergast* 199  
 The Loss of Local Park Lands to Highway Planning  
 .....*D. Donaldson* 201  
 The Land Grah for Building Purposes.....*George D. Butler* 204  
 What You Can Do About Encroachment..... 206  
 How Golden Gate Park Was Saved..... 208  
 Drag Strips vs No Drag Strips..... 210  
 Recreation Developments in 1956.....*Charles S. Reed* 212  
 What To Do and See in Long Beach..... 216

**ADMINISTRATION**

The Importance of Land..... 226  
 Park Acreage to Population..... 228  
 Notes for the Administrator..... 230  
 Court Decisions Affecting Swimming Pools..... 232

**PROGRAM**

Brainstorming in Recreation (Idea of the Month)  
 .....*Mary Frances Sargent* 218  
 Softball Is Dead? Not in Saginaw!.....*Malcolm Elliott* 220  
 Young Citizens Improve Recreation Areas.....*B. D. Mott* 221  
 For Successful Nature Hikes.....*William R. Overlease* 222  
 How To Do It! Make A Banjo.....*Frank A. Staples* 224

**REGULAR FEATURES**

Letters..... 196  
 Things You Should Know..... 198  
 Editorially Speaking..... 200  
 Reporter’s Notebook..... 213  
 Hospital Capsules.....*Beatrice H. Hill* 225  
 How To Do It! Idea of the Month.....See Program  
 Personnel—Second National Institute for Recreation  
 Executives.....*W. C. Sutherland* 234  
 Market News..... 236  
 Books and Pamphlets Received, Magazine Articles..... 238  
 Classified Advertising..... 238  
 New Publications..... 239  
 Advertisers Index..... 240

RECREATION is published monthly except July and August by the National Recreation Association, a service organization supported by voluntary contributions, at 8 West Eighth Street, New York 11, New York, is on file in public libraries and is indexed in the *Readers’ Guide*. Subscriptions \$4.00 a year. Canadian and foreign subscription rate \$4.50. Re-entered as second-class matter April 25, 1950, at the Post Office in New York, New York, under Act of March 3, 1879. Acceptance for mailing at special rate of postage provided for in Section 1103, Act of October 3, 1917, authorized May 1, 1924. Microfilms of current issues available University Microfilms, 313 N. First Street, Ann Arbor, Michigan.

Space Representatives: Mark Minahan, 168 North Michigan Avenue, Chicago, Illinois.

Copyright, 1957, by the National Recreation Association, Incorporated

Printed in the U.S.A.



\* Trade mark registered in U. S. Patent Office.

**R** For  
Perfect  
Summer Movie  
Programming!

Sign Up Now For

**"MOVIE  
A  
WEEK"**

**Free Film Plan**

Receive a complete, exciting sponsored film program each week all summer—for FREE-LOAN (postage only).

Hold each program for a full week—use as often as you like! The answer to your Movie Night or rainy day needs.

Sports, travel, science, recreation films—most in full color—all outstanding!

**MAIL THE COUPON BELOW**

Send for your Free copy of our new Catalog of Free-Loan and Feature Films.

Flavor your program with

**A - DASH - OF - DISNEY!**

A complete selection of Walt Disney Technicolor Classics—Cartoons, Features, True-Life Adventures—available for RENTAL.

Enroll my group in MOVIE-A-WEEK:  
 Starting (date) ..... and ending date) .....  
 Each program should run ..... minutes.  
 For  Boys  Girls—Ages ..... to .....  
 Name .....  
 Organization .....  
 Address .....  
 City ..... Zone ..... State .....

Please send Free Catalog

**ASSOCIATION FILMS, INC.**



347 Madison Ave., N.Y. 17, N.Y.  
 Branches:  
 Ridgfield, N. J. • La Grange, Ill.  
 San Francisco, Calif. • Dallas, Tex.



Readers! You are invited to send letters for this page to Editor, RECREATION, 8 West Eighth Street, New York 11—so that your ideas, opinions and attitudes may be exchanged with others on the wide range of subjects of concern to us all. Here is your chance to agree or disagree with the authors of our articles. Keep letters brief—not more than 250 words.  
 —The Editors.

**Camping Issue**

Sirs:  
 It was indeed a pleasant surprise to see the better part of the March issue devoted to camping. The broad coverage, with its variety of approaches to camping, should prove very helpful to the field as a whole.

The stress on what campers are missing and the concern about the handicapped—in this instance the retarded—are especially noteworthy. It is to be hoped that this interest in camping will not be a one-month affair, but will continue to be spread throughout the year in your widely read magazine.

IDA OPPENHEIMER, *Executive Director, Jewish Vacation Association, Inc., New York City.*

**Check Your Old Files**

Sirs:  
 In going through my old files of RECREATION magazines, I happened across the March 1955 issue. After skimming through it, I felt a letter was in order. This issue was so chock full of timely and useful program and administrative material that it seemed a shame that I had left it in my file so long. Water recreation, creative arts, swimming pool construction and a training program for secretaries were just a few of the wonderful items in this particular issue.

I believe this is just another example of the richness of your publication, and a confirmation of the fact that we in recreation owe a tremendous debt to you for the excellence of your publication over the years.

JOSEPH E. CURTIS, *Director of Recreation, Oceanside Public Schools, Oceanside, New York.*

**"Dennis the Menace"**

Sirs:  
 Congratulations on your fine story

about our playground. ("Dennis the Menace" Playground," April 1957.)

HANK KETCHAM, *Carmel Valley, California.*

\* \* \* \*

Sirs:  
 I have read the story in your April issue about the "Dennis the Menace" playground and I congratulate you on its excellence.

IRA EMERICH, *Executive Vice President, The Hall Syndicate, Inc., New York City.*

\* \* \* \*

Sirs:  
 The article on our "Dennis the Menace" playground in the April issue of your magazine was very well done. . . . a splendid job. . . . we have had several inquiries about the playground from people who mentioned reading your article.

CHARLES F. WARREN, *Assistant City Manager, Monterey, California.*

**Would Like to Hear**

Sirs:  
 I am writing a book on improvised athletic and recreation equipment and would like to hear from your readers about items they have made and ideas they have. Any article that can be made by the average mechanically minded person in a recreation department's maintenance shop or in a school shop is of interest to me.

I'm collecting plans for items that have been made and successfully used into a manual which others may use to build the same things. I feel that the book will be a benefit to the profession by helping us stretch our often meager budgets, so I am asking your assistance and the contributions of your readers.

JOEL W. CARTER, *Ensign, USNR., Box 109, Fort Amador, Canal Zone.*



# Let's Save Our Recreation Lands

Walter H. Blucher

**F**EW COMMUNITIES in this country can boast that they have adequate land for parks and recreation purposes. Few can boast that they meet the rule-of-thumb standard of ten acres per thousand persons, for many years considered the minimum requirement. The tragedy is that we are less likely than ever to acquire this minimum standard when we view the way land is being butchered in the suburbs of our metropolitan areas. A trip across this land of ours, a visit to any community, large or small, discloses a common pattern: Residential development is taking place in the outskirts of the community or outside its limits; the thirty-five-foot lot fortunately has been increased to the sixty-foot lot in many instances—but school sites are either non-existent or hopelessly inadequate in size, parks have been almost entirely forgotten, and the playground is the exception rather than the rule.

It is hard to believe that, in these days of enlightenment, large developments are taking place with no provision for recreation areas. While subdivision regulations now commonly require installation of sewers, water mains, pavements, sidewalks and other similar public services, statutes and regulations are hopelessly weak in requirements for school sites and recreation areas. Developers and home purchasers still do not realize that these are as essential to a proper community as the heating plant in the house.

One would hope that communities might learn from experience. There are so many cases of communities that have waited to acquire recreation areas until all available land was built up and then, of course, "the land was too expensive to acquire as a playground." One of the disheartening signs of the times is our failure to learn anything from the past and to save enough land for recreation purposes. Throughout the nation, lands suitable for parks are being used for choice residential sites. Little is being done to retain such potential parks. There is failure to recognize that the community would be far more desirable if the potential site became a park, that it would further the well-being of the community.

Does anybody believe the often-expressed theory that we will have much more leisure time in the near future? We are nearing the four-day week—and what will we do with our new leisure? I doubt if all of it will be spent building bookcases or working in the backyard. A grim prediction in *The New York Times* (April 22, 1957) warns that, if present

MR. BLUCHER is consultant to American Society of Planning Officials, and is one of the top planners of the country.

trends in metropolitan areas continue, we will need a day to travel over congested highways to the shore or a lake twenty miles away and another day to return. Thus, the three-day weekend will be occupied. Won't people want to use some of the time for leisure and recreation activities? Where will they find space except at a distance from their homes? Then there is the competition for existing park and recreation sites. Has the community agreed that it will build a new armory? What is more logical than to put it into an existing park? Or if the need is for a museum or an auditorium and the community doesn't have enough money for a site—why not get one free by taking over part of a playground or park? Need a site for a university? Take over a park. Need a new school or to expand an existing school adjacent to a playground? Move into the playground. After all, the schools are short of money—why not save the cost of the site? Short of money, yes. Short of intelligence, understanding and foresight? Also, yes. On rare occasions there might be some logic in substitution of sites, but how frequently is there an offer of replacement, in land or money for a site taken away?

Many cities are engaged in redevelopment programs; and the one major fact we have learned is that proper redevelopment or rehabilitation requires more open space than has heretofore been available in congested residential areas. In fact, the success of redevelopment or rehabilitation in many instances depends entirely upon our ability to provide open space. We must make the central city as desirable (actually) as the escaping city-dweller dreams the suburb to be. What a shattering of dreams for many suburban dwellers who have found that there are fewer large parks in the suburbs than in the central city they left; that the new suburb cannot afford a community building for recreation purposes or a swimming pool. And so the children trek back into town to the "Y" for swimming!

It is time we awakened to the fact that recreation is essential to the well-being of the people and of the community, and if we do not acquire park and recreation land now, there will be none left to acquire in the future. ■

## Stop, Look, Listen—Then Act!

Unless an informed public aggressively insists on its right to adequate park and other recreation areas, the vanishing wilderness and the vanishing frontier will be joined by a vanishing opportunity for outdoor recreation.—JOSEPH PRENDERGAST.

## Things You Should Know . .

▶ A \$39,500,000 RECREATION AND PARK BOND ISSUE has just been approved by voters in Los Angeles, California, by a three to one majority. This is a great victory for public recreation.

▶ THE JUNE ISSUE OF *Redbook* carries an excellent article on encroachment, "How to Save Your Community Play Land," by Beatrice Schapper. Background information for this story was supplied by the National Recreation Association. The April issue of *Redbook* also carried an encroachment article on roadbuilding, "They Took Our Homes."

▶ HOSPITAL RECREATION WORKERS, your membership in the National Recreation Association or subscription to RECREATION Magazine would enable us, financially, to add pages to the magazine and give us space urgently needed for the regular publication of hospital recreation information. If you want the magazine to include such materials, don't wait. Sign up today!

▶ A 140-PAGE LIST OF SELECTED REFERENCES, *Community Facilities*, has just been published by the National Association of Home Builders, 1625 L Street, N.W., Washington 6, D.C. The "Recreation Facilities" section carries a number of titles from RECREATION Magazine. Among other heads in this publication, are "Community Growth and Problems"; "Governmental Relations"; "Financing Community Facilities"; "Zoning"; and "Subdivision Control." A limited number of copies are obtainable free from the National Housing Center Library, at the above address.

▶ STATE PARK DEVELOPMENT plans to take care of Washington's needs for the next quarter-century were announced recently by the Washington State Parks and Recreation Commission, according to the *W.S.R.S. Bulletin*. The report, presenting conclusions reached after an exhaustive planning study, has been

more than a year and a half in preparation.

Acquisition of many new park sites, enlargement and development of existing sites, and the disposal of a number of presently unused or unneeded sites are proposed.

▶ A PROCLAMATION NAMING JUNE AS NATIONAL RECREATION MONTH IN NEW YORK CITY, was presented by Mayor Robert F. Wagner, at City Hall on May 29, to Betty Jo Mandlin and Joseph Prendergast, as representative of the NRA. Betty Jo, six years old, has been selected as "Miss Playground" by the New York City Park Department.

Last minute reports on other proclamations of June as National Recreation Month indicate that so far about half of the governors in the United States have taken such action. Others are scheduled to follow suit soon.

▶ PRESIDENT DWIGHT EISENHOWER, in a message to the National Recreation Association, also citing June as National Recreation Month, says:

"It is my hope that our citizens will use some of their hard-earned free hours to enjoy the unparalleled recreational facilities of our land. In so doing, they will enrich their daily lives and contribute to the health of the national community."

▶ SUGGESTIONS OF LITTER-PREVENTION ACTIVITIES FOR PLAYGROUNDS have been supplied to playground leaders who are members of the National Recreation Association by Keep America Beautiful, Inc. These were drawn up at the request of the Association. Additional material or information may be obtained from KAB headquarters at 99 Park Avenue, New York 16.

▶ ANOTHER USE FOR NRA YEARBOOK FIGURES, and the importance of cooperating with the Association in the collecting of such figures, is illustrated by the fact that the National Recreation Association has been asked to work with the U. S. Census Bureau in providing rec-

reation information on a national basis. The Association is supplying the bureau with information based on local recreation developments since the early days of the Association, to be included in the revision of a bureau publication entitled, *Historical Statistics of the United States*. The data is being compiled from yearbooks and park studies conducted by the Association through the years.

▶ NOW AVAILABLE: *Research in Recreation Completed in 1956*. This is a list of 205 reports. Order from NRA. \$1.00.

▶ COMING IN SEPTEMBER: The new edition of *A Guide to Books on Recreation* (AGBOR to you) is coming off the press soon and will again be mailed to all RECREATION subscribers as Part II of the September issue. New titles bring the list up to more than 850 books, from 125 cooperating publishers. These books will be displayed at the National Recreation Congress in Long Beach, California, in September.

▶ ATTENTION, DELEGATES AND ADVERTISERS: The September issue of RECREATION is also the National Recreation Congress issue—carrying last minute Congress information and announcements of exhibitors. Don't miss it!

▶ THE JUNE ISSUE OF *Cosmopolitan* is entirely devoted to today's new leisure. One of the lead articles will quote the executive director of the National Recreation Association, Joseph Prendergast.

▶ THUMBS DOWN MEANS DON'T CLOWN. This slogan, endorsed by the Outboard Boating Club of America, is to be used in promoting boating safety this summer. Use the "Thumbs Down" warning signal whenever you see any boat going through dangerous antics, and please help publicize this sign and slogan. "Thumbs Down" to the clown!

▶ A NEW BLANKET ACTIVITIES INSURANCE PLAN is now available to all affiliate members of the National Recreation Association. Previously, member organizations could get low cost baseball-softball team coverage through their affiliate membership with the National Recreation Association. Now, the new plan has been developed to offer insurance coverage to all participants, age nineteen and under, in a supervised recreation activity. The contact sports of tackle football, ice hockey, lacrosse and boxing are excluded. Write to NRA for a free descriptive brochure.

# New Dimensions in Recreation

*"Space means to a man that which he has experienced for himself. . . ."*

Joseph Prendergast

**I**N SEPTEMBER, 1945, Howard Braucher expressed the relationship between atomic power and recreation in these words: "Making use of the power of the atom is a great achievement in the physical world. We cannot tell where this may lead. An equally great discovery of our times is the power there is in recreation, in making it possible and easy for all people to live richly, deeply, vitally each day."

I would like to carry this relationship between recreation and the new discoveries of science a step further. The phrase "new dimensions" has, for most people, the connotation of dimensions in relation to space; and space nowadays—that is since Einstein brought out his theory of relativity—is all mixed up with time and speed.

It has intrigued me to note that "new dimensions" in terms of space, time and speed also means "new dimensions" in terms of recreation and physical education. This is so because of the paradoxes inherent in the very concepts of space, time and speed.

For example, the paradox of space is the simple fact that as space expands, it contracts. We look around this room and say to ourselves, this is a good size room, but then we think of the space immediately outside this building and the space in this room seems smaller. We think of the size of the United States or of the world and this community and the state itself shrink in size.

Today one talks of spacemen, with earth satellites already under construction—and of a perpetually expanding universe. Yet space for the individual human being is contracting and will continue to contract—not just figuratively or relatively, but realistically and actually—way below the normal needs

not only of the American frontiersman of yesteryear but of the average American today, if something is not done soon to preserve our present parks and recreation areas and remaining open spaces.

Most of us, in our own lifetime, have experienced for ourselves this space contraction. Where, for example, are the vacant lots in the built-up areas where once we played our baseball? Where are the open fields at the edge of town? Where are the old swimming holes within walking distance of Main Street? Where are the empty beaches, the open road, the silent woods?

Open spaces are disappearing with great rapidity because of the tremendous growth of our population and its growing concentration in our metropolitan areas. The urbanization or rather, to speak more accurately, the suburbanization of America is wiping out potential parks and other recreation areas even before the need for them is felt. Today there are over 170,000,000 people in America. By 1975, there will be at least 225,000,000 people in the United States alone.

What is even more tragic, we are not even hanging on to the pitiful little parks and recreation areas which we were able to acquire in past years. Hardly a month or week goes by that the National Recreation Association does not receive a desperate call from a community to help save a park or playground from being given over to housing developments, commercial exploitation, firehouses.

School buildings and highways—wonderful things in and of themselves—are terrible things to contemplate in their possible ruthless destruction of a community's parks and open spaces. Hospital construction and public housing were had enough, but just wait until the highwaymen come riding along with their millions of dollars to spend.

What good, I ask you, is 1,300,000,000 times 6,000,000 miles or more of space if a boy can't find enough space in which to throw a ball, or a girl to skip a rope, or old people to sun and gossip?

There is also a paradox of time and it, too, has meaning for recreation. Today we are destroying time and yet creating it at the same moment.

We have been gnawing away at time for centuries and now, suddenly, we have succeeded in destroying it completely. It no longer even exists under certain circumstances. We can fly from New York and reach California before we've left New York. Just recently a transport plane flew across the continent in less than four hours. It was officially announced some time ago that a jet plane with a human pilot had traveled more than 1,900 miles an hour.

Automation and all that automation means in time saving, or rather in time creating, goes on.

Whether we're talking about working men and women, youth with its longer periods of educational preparation, farmers and housewives with their time-saving equipment and gadgets, or the older folks with their earlier retirement and their longer lives, the most conspicuous result of the atomic age is time—leisure time, free time, time for man to do with as he will.

More and more people with more and more time for recreation but less and less space in which to use it. What does that mean for park and recreation people? For physical educators and all others who must teach our children?

It means first and last that, if we are to keep up with the American dream of perennial opportunity, we must see visions and plan big. This age of new dimensions demands new dimensions in all the plans we make, and particularly for our plans for recreation. ■

MR. PRENDERGAST is executive director of the National Recreation Association.

# Editorially Speaking



Drawing by Dedini,  
© 1957, The New Yorker Magazine, Inc.

## No Longer Separate Entities

"Parks and recreation are bound together in a common function. Let us hope that the day has passed when these agencies considered themselves separate entities. Any recreation agency worth its salt must recognize the intrinsic recreative values of parks. All visitors to parks come seeking a kind of satisfaction, be it a "supreme emotional experience" in one of the great national parks, rest and relaxation, participation in active pursuits, or understanding of the principles of the universe. To serve basic human needs—physical, emotional, intellectual, and social—is the primary function of all park and recreation agencies.

"Today, we have a better understanding than ever before of their close relationship. There is a meeting of minds which should make possible in the years ahead such park and recreation progress as has never before been known.—" REYNOLD E. CARLSON, *Professor of Recreation, Indiana University, at the Great Lakes Park Training Institute, 1957.*

## A Beautiful World

"I want a world that is beautiful enough to inspire me, to make me rise to its defense at the slightest provocation. I like shade on a hot day. I like kites on a March day. I want to see the thrill of discovery in my son's eyes, even if it is only a hollow tree full of owls or a crawfish under a stone that he finds. I want him to have some inkling as to his place in a society of living things. I think we all need something around to remind us that there are

things which are bigger than man, like mountains and trees, older than man, like rocks, things that man can't make; like grass and things so complicated that man can't understand them; like the rich fresh soil.

"I am writing this now having just seen one of the most beautiful woods I have ever known bulldozed into nothingness. Today, yellow hills and flimsy houses stretch over two hundred acres that in 1936 were bought for a mere \$60,000 as an investment. It was a good investment all right, for this year it sold for three times as much; but if it had been bought as a park, and preserved as an impressive island in an industrial community, its value would have been immeasurable, not to be reckoned in such earthly items as dollars or acres, but in inspiration, education, relaxation and exercise. Ironically, the desert which has been created from it has been called Forestwood, and its main street is Meadowrest. So we salve our consciences and confuse our descendants!" —ALFRED G. ETTER in "*Cry, The Beloved City*," RECREATION, April 1954.

## The Danger of Uniformity

Individual hobbies to offset uniformity are urged in the annual report of the Twentieth Century Fund by August Heckscher, fund director. He says that a new measure of uniformity is reflected by findings that men and women in their free time tend to do the same things, buy the same goods, watch the same television shows.

Mr. Heckscher concludes that the United States is in the midst of a profound shift in values and ways of living. The emphasis on leisure—particularly with the four-day work week possible in the future—is bound to remake and transform much that has been familiar.

The report observes, "In the best lives the vocation and the avocation are closely related. Men and women have attained leisure only when they recapture in their free time something of what in their happiest moments they find in work—the satisfaction born of having mastered manageable things, the relaxation that comes from moving in an element where one feels instinctively at home."

## The Four-Day Week

"Reuther Reports Members Favor Four-Day Week." So reads a headline

in *The New York Times*, April 7, 1957. A few days later, columnist Sylvia Porter writes in the *New York Post*, "Of course the four-day week will come in our land.

"Of course the trend will develop gradually, selectively, and the four-day week will be the result of union-industry bargaining, not of legislation or violent depression. . . .

"If the trend is given the push powerful unions undoubtedly will give it, the four-day week will be standard for millions in a wide variety of fields—say in the early '60's. . . .

"Actually, a government survey in 1955-56 revealed that seventeen per cent of all workers in seventeen major labor areas already are working on a schedule of fewer than forty hours. The standards are changing right now. . . .

"Reuther is not being revolutionary at all; he is just dramatizing a natural trend."

## LitterBAGS—Not LitterBUGS

Until just a few years ago hardly anyone had ever heard of litterbags. Today a large percentage of Americans consider the portable trash container an essential piece of travelling equipment.

Concern over the trash-tossing propensities of the motoring public is getting results! Many Americans are accepting an individual responsibility for maintaining the clean, attractive appearance of their highways and recreation areas, and regard the litterbag as a valuable aid to outdoor housekeeping.

Like everyone else there must have been times when you've wondered what to do with sticky wrappers, used tissues, the remains of a picnic lunch, or the many other articles which accumulate during normal automotive travel. After a slight twinge of conscience, perhaps you've surreptitiously tossed the whole mess out the window. From now on, however, resolve to use a litterbag instead. There are many varieties, from simple home-made devices to patented commercial products, but any kind of sturdy bag will do. Use one, regardless of type, and dispose of its contents in your garbage can at home!

## Ultimate Qualification

This item appeared recently in a Sunday edition of the Worcester (Massachusetts) *Telegram*.

TRUE STORY: A North High School teacher applied and was found fully qualified by Civil Service to be a recreation leader in the park department's summer program, except for one thing. He was missing a molar; so he was declared ineligible despite protests of city officials.

"I don't want to bite the kids, just teach them," was his sad comment.



A proposal to put a superhighway through Rock Creek Park in the nation's capital<sup>1</sup> met with such strong opposition by various organizations and agencies that the plan is now apparently dormant as the highway planners are seeking alternate routes outside park limits.

"Lands that have been given for man's enjoyment of nature and the outdoors can have no higher use. If park land is judged necessary to another needed project, then and there arrangements should be consummated to pay back the public with other lands to be developed for man's relaxation."—Joseph Prendergast.

D. Donaldson

## The Loss of Local Park Lands to Highway Planning

THE OMINOUS crash of falling trees is being heard across the land! Has it reached your local parks as yet—or is it scheduled there for the near future? Will the "new turnpike" take acres from that last green open space in your community? If you do not know the answer to this, or the plans of your state highway commission in relation to the federal aid to highways program, do not hesitate to check with it at once.

It is said on good authority that the new 42,000-mile interstate highway system will take some two million acres of land, much of it in metropolitan areas, and that two-thirds of it will cross the nation where no highways now exist.<sup>2</sup>

Today, from coast-to-coast, bulldozers are busily gouging the earth where once stood woodlands or lawns of cool green shade. They are cutting across towns and wilderness areas alike—leveling forest giants, hemlocks and hickories, ploughing up the rhododendron beds and the dogwoods of the parks. Public tennis courts, ballfields, playgrounds, fishing ponds and campsites are being sacrificed to quick transportation in this day of speed; and communities are running out of land for recreation and for beauty. The machine mows shrubs and blossoms; and, as Lewis Mumford says, "The concrete clover leaf is becoming our national flower!"

To some, this state of affairs is "progress"—but to alert, farseeing park and recreation men it is catastrophe, and very nearly the crack of doom. For, unless we act quickly and wisely, it may lead to the disappearance of open space to be used for the enjoyment of man, and new generations will know only the thruways, never realizing the beauty that was

here. It is a paradox of our day that with our increasing leisure, space for its enjoyment is pre-empted or destroyed.

We will always want, and need, parks in America because we are an outdoor people and have been conditioned by the woodlands and natural playgrounds of a young country. But what steps are we taking to make sure that we will always have them?

Joseph Prendergast, executive director of the National Recreation Association, pointed out in a recent speech: "The folklore, tradition and fact of the American wilderness, frontier and open space have had an enormous influence on the American character. . . . The land of opportunity basically meant endless open space where a man could stretch and achieve individual growth and happiness. Open space for leisure living is essential for the kind of American character we cherish."

In an epilogue to the recent book about John D. Rockefeller, Jr.,<sup>3</sup> Horace Marsden Albright quotes an editorial from *The New York Times*: "As our urban, mechanized society spreads itself with increasing speed and destructiveness across the land, the human need for preserving contact with natural areas, with living, wild and growing things, becomes more explicit and more pervasive. As natural areas rapidly diminish, the battle to keep the best of the remaining ones intact grows more intense."

And yet we, as a people, recently passed the Federal Highway Act which leaves the routing of highways in the hands of state highway officials, subject to federal OK because the federal government is paying ninety per cent of the cost. These officials, quite rightly, are primarily con-

<sup>1</sup> See "Cry, the Beloved City," RECREATION, April 1954, page 208, and "Rock Creek Park Day," October 1956, page 368.

<sup>2</sup> According to New York Congressman Harold Ostertag in *Redbook Magazine*, April 1957.

<sup>3</sup> *A Contribution to the Heritage of Every American: The Conservation Activities of John D. Rockefeller, Jr.*, Alfred A. Knopf, \$13.50.



"You're gonna have to MOVE, mister! We're buildin' a FREEWAY through here!"

cerned with keeping construction costs down and putting their plans into effective operation with the fewest number of problems. Last March, John T. Howard, associate professor of city planning at the Massachusetts Institute of Technology, told a national planning conference in San Francisco that this highway program places a "terrible responsibility" on highway engineers and "forces them to make decisions that have impacts far outside their fields." They are *not* concerned with the preservation of parks, but it is to be hoped that park and recreation leaders will undertake to educate them as to the importance of park lands. In any case, it will pay us to keep a sharp eye on what may be happening in our own communities!

In December, 1956, an article in *Nature Conservation News* warned: "Highway planners must of necessity carry on their work with great secrecy because of the inevitable opposition of some land owners. . . . Therefore they follow a policy of having the route firmly established by the time plans become publicly known. Thus, the most practical way to safeguard natural areas that may be threatened by highway construction is to convince the highway planners of their value early in the game."

State highway plans, in order to qualify for federal aid, must follow the most direct and economical route east to west, north to south. And it is less bother, though not less costly as a rule, to traverse the open spaces and to go through a town instead of around it. At this moment in Bergen County, New Jersey, for example, three huge freeways are booked to cut through the county's ranch-type homes, thus affecting some hundreds of families. According to a recent article<sup>4</sup>, this decision was made by one man, New Jersey's highway commissioner, Dwight R.G. Palmer, who says, for the benefit of anyone who objects, "The federal government is picking up the check for dinner. We just pay the tip."

The article goes on, "And because the government will

<sup>4</sup> "Turnpikes: Where Are They Taking Us?" by William G. Wing in *Today's Living*, Sunday magazine of the *New York Herald Tribune*, April 7, 1957.

pick up the check, the route has to meet its standard of good engineering practices. It won't approve unnecessary curves or steep grades. . . ."

Actually, planning for a highway route through a community should be the result of the cooperative planning of, or the cooperative decision of, the highway officials and the local governing authorities—including the park and recreation departments whenever park and recreation lands are affected. Recreation and park commissioners should take definite steps toward effecting this cooperation, and should start immediately by acquainting themselves with any real or implied threats to existing local park lands. C.C. Curtiss, commissioner of public roads of the Federal Bureau of Roads, in a letter to the National Recreation Association, writes, "A wise, long-term policy is essential if the many problems arising from proposed highway locations in or adjacent to park areas are to be solved. Such policy calls for cooperation, in each locality, between state and federal highway organizations, municipal and county governments, and park administrators, with associations like your own. *Public support is needed for comprehensive regional plans that coordinate development of recreation and transport facilities.*" [Italics are ours.]

Mr. Curtiss goes on to say that the bureau has encouraged state highway departments toward systematic use of aerial photographs and photogrammetric contour maps in comparing alternate routes and selecting the most advantageous location. Such methods provide for careful examination of park and recreation land in advance of highway location.

He states, "Parks and recreation organizations can be of assistance to state highway officials and other groups in combined efforts toward wise and comprehensive land-use planning policies in each region, in accordance with subsection (c) of Section 116 of the Federal-Aid Highway Act of 1956: 'Declaration of Policy with Respect to Federal-Aid Highway Program.' This reads as follows:

"*Public Hearings. Any state highway department which submits plans for a federal-aid highway project involving the bypassing of, or going through, any city, town or village, either incorporated or unincorporated, shall certify to the Commissioner of Public Roads that it has had public hearings, or has afforded the opportunity for such hearings, and has considered the economic effects of such a location. . . .*"

"We would emphasize the many advantages to be gained by conferences between interested parties whenever possible well in advance of public hearings. . . ."

Public hearings, as provided in the legislation, afford park and recreation officials an opportunity to point out that *other than economic effects are also important* and should be considered. The local citizenry, therefore, must be alerted to the local situation, its stake in this planning and the importance of prompt action.

### Among Affected Park Lands

This state of affairs may seem fantastic; but if you find it hard to believe you can check in a thousand places. For example, ask the Cincinnati Recreation Commission about Deer Creek Commons, the city's largest softball and baseball installation, which has been scheduled for elimination by the

Northeast Expressway construction. Ask the Detroit Park Commission about its experience with the Michigan Turnpike Authority; Newark, New Jersey, about the highway request for the lower end of Branch Brook Park; or the Portland, Oregon, Bureau of Parks and Public Recreation about the encroachment of highways upon park and recreation properties in that city.

Harry Buckley, superintendent of parks in Portland, states that, as a result of the new federal-aid highway program, a proposed twenty-year plan places highways in twenty-one of Portland's parks. Some of these, where the alignment traverses large park areas, do no particular damage, he says; but he adds, "The greatest loss to parks will be in the neighborhoods where an entire park will be taken or reduced in size as to render it impotent to serve its intended purpose. This would occur in sixteen of Portland's areas. . . ."

"The representatives of the right-of-way division of the

"The Griffith Park situation is unique in the fact that the larger portion of the park was accepted by the city by grant deed from Griffith J. Griffith in the late '90's, with a provision in the deed that the land must forever be held inviolate as a park, and if otherwise used title thereto would revert to the donor or his heirs. A representative of the estate has brought suit in the Superior Court of California to repossess the park by reason of its diversion to other than park purposes. . . . It is expected that this will become one of the memorable suits in respect to taking of park lands for state highways, and in respect to the inviolability of park lands with reversionary clauses contained in their deeds.—GEORGE HJELTE.

state highway commission say that they cannot pay more for park land than for vacant land. No other values are recognized. They hold that they cannot acquire alternate land to exchange because they can only purchase what is needed for highway."

He feels that our biggest job throughout the country is to "do a selling job to the residents in our communities to protest the conversion of park properties without alternative facilities being provided in the same neighborhood."

Another case in point, is the struggle over Griffith Park in Los Angeles. George Hjelte, general manager of the department of recreation and parks, reports, as of April 10, 1957, that the construction of a vast link of the state freeway system through Griffith Park is proceeding apace, notwithstanding the continued disapproval of the Los Angeles Board of Recreation and Park Commissioners. Determination of this route was made by the state highway commission in the face of continued opposition, under the authority granted by the legislature.

"Decisions of the state highway commission as to the location of state freeway routes are not subject to appeal to any other state body," writes Mr. Hjelte. "This project—with another which is planned by the state to follow the two known as Golden State Freeway and a portion of the Ventura Freeway—will remove from Griffith Park approximately two hundred and six acres of usable park land, much of which has heretofore been laid out in golf fairways, miniature train, tennis courts, picnic grounds, baseball fields, archery range, and so on."

It was the contention of the Los Angeles Board of Recreation and Park Commissioners that an alternate route existed adjacent to the park where undeveloped open land was available at market prices, and where a minimum of improvements would have been required. "The alternate route was never studied in detail by the state highway commission," Mr. Hjelte says, "possibly in the belief that the route through the park would prove less costly. Since these determinations were made, however, policy has developed to the point where any right of way taken from park lands must be compensated for at market prices. Market price in the instance of Griffith Park land, while considerable, will not be sufficient to purchase alternate land in the vicinity of the park, preferably contiguous thereto, at anywhere near the same price. Contiguous open land is now priced at \$35,000 per acre."

Wilmington, Delaware, is in line to lose fifty-one acres, including ten tennis courts, to an express highway which is being designed "to miss major buildings and private homes by passing through park property." The area that would be left after this deduction would be a bare 260 acres in city parks while, according to National Recreation Association standards, there should be 1,100 acres within the city limits for normal park purposes.

Maurice duPont Lee, president of the Wilmington Board of Park Commissioners, stated late in February, 1957, "The department of parks has had no word from anyone asking for its thoughts in the matter, although it is the department of the city government responsible for the property under consideration. . . . It is my understanding that the proposed location is selected purely for economic reasons, but I would like to point out that there are more important things in this life than the almighty dollar."

Dedham, Massachusetts, reports a like loss of public forest; Greenwich, Connecticut, lost some of its Bruce Park to the New York Thruway. In Montgomery County, Maryland, an expressway is cutting through one side of a golf course. In Lincoln, Nebraska, a four-lane highway is going through one of the main public parks. A proposal in New York City to route through traffic via Washington Square Park, at the start of Fifth Avenue, has aroused acute controversy in that city.

A further indication of the seriousness of the land problem was a report in *The New York Times* last November that of the fifteen private golf courses in the Borough of Queens in 1936 only three remain. The others, with a total fifteen hundred acres of open space, have gone into housing developments, apartments, university buildings and airport runways. So it goes in hundreds of instances around the country. The land grab as applied to local building is equally grave. (See also "The Land Grab for Building Purposes," page 204.)

Experience indicates that the best way to stop encroachment on recreation and park lands is through an informed public. Recreation officials might well consider using National Recreation Month, during June 1957, as an occasion for making the community generally recreation land-conscious. Specific land grabs call for immediate action. ■

# The Land Grab for

What new structures will be constructed on your parks? A shopping center? Housing? Do you want to see this—

**P**UBLIC OPEN space devoted to recreation use has become widely recognized as an increasingly valuable community asset. Yet today it is constantly being threatened, as has been shown in preceding articles. In addition to the highway grab, however, private interests covetously seek to acquire it as cheap building sites, or public authorities see that taxpayers' dollars will be "saved" if park land is used for other facilities.

The opportunity to collect needed dollars from the sale of park land or to cut the cost of a new structure by putting it on park property has proved too tempting for many tax-conscious city governments. Consequently, across the nation, public recreation areas are being disposed of, or allocated to other uses, to an unprecedented degree.

Park and recreation authorities need to be alerted to the gravity of this situation! In some cities where parks have been "lost," the authorities were unaware of the transactions until they were consummated. With the mounting demand for the decreasing amount of open space, especially in and around the large cities, pressure upon local governments to dispose of it for other public purposes is bound to grow in the years ahead. Complacency on the part of park and recreation authorities will be inexcusable and fatal: none of their areas are automatically immune from attack.

## Public Parks Imperiled

Nearly ten years ago Tom Wallace, long an outstanding leader in the movement for state parks, stated: "Every park of every classification, every national park, every state park, every

---

MR. BUTLER is head of the NRA Research Department.



municipal park, which has any value, is imperiled. That is due to the public's frequent failure to realize that park lands well chosen increase in value as surely as population grows. Whenever a park is treated as land which may be, without great loss, or with advantage to the public, surrendered for other use, the public suffers in this generation a loss which will be a far greater loss to future generations."

More recently the problem has been stated in an editorial in the *Christian Science Monitor*: "For a community to acquire parks and public forests after it has grown up is no easy task. But to hold such green open spaces intact after they are won is almost as great a challenge."

Many of our cities acquired a large part of their park acreage during the early decades of this century, when open land was abundant, and people had little leisure and recreation was not generally considered of major importance. Yet our fathers had the foresight and vision to set aside lands for the benefit of future generations. Urban conditions today—limited open space, much leisure and great demands for recreation—make the reservation of lands for public recreation use more essential than ever before. But not only are cities failing to acquire recreation space as fast as population\*, but they are letting slip through their hands the precious

land our fathers acquired.

The slogan "It Can Happen Here" applies to every community that is not alert to the situation. For, as the Buffalo and Erie County Planning Commission points out, "Encroachment on public park acreage by local governments for non-recreational uses is a national trend which could well foreshadow the ultimate disappearance of open space from the urban pattern. This is a dangerous and short-sighted practice . . . ."

"Most communities (Buffalo included) desperately need all the open space they now have. Yet, local governments keep whittling away at public lands . . . . All across the country, parks are being turned into building sites for hospitals, libraries, schools. . . ."

## Rationalizations for Encroachments

Economy and dollar savings to the taxpayers are the common excuses given for the grabbing of park lands for other purposes. Among the arguments used by proponents of such measures are:

1. "The public already owns this land: it's in the interest of economy to use it."

---

\* See "Park Acreage to Population," page 228.

\*\* *The Planner*, March, 1955, published by the Buffalo and Erie County (New York) Planning Association.



# Building Purposes

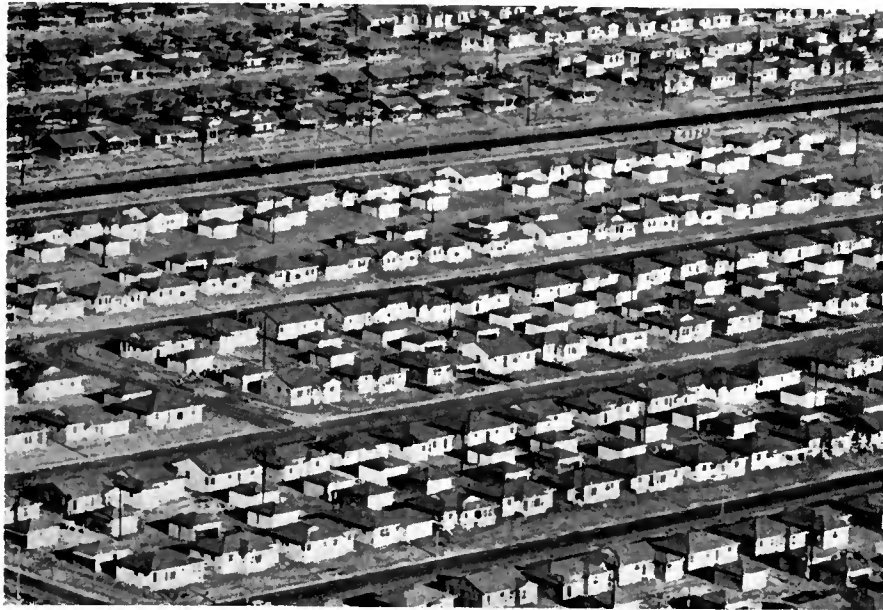

—Or this? Should we fight to retain our open spaces? What plans are now in the making for *your* community?

George D. Butler

*Murfreesboro, Tennessee.* Its only public recreation land, a small playfield, was sold for the use of incoming industry and was not replaced.

*Toledo, Ohio.* A portion of one park was given to a private industry for parking of employee cars. The YMCA was sold one acre of land and given a lease on another acre for erection of a branch building. A total of twenty-five acres of a third park has been utilized for sewage disposal, a naval armory, U.S. Coast Guard buildings, police pistol range, and private yacht club.

*Andalusia, Alabama.* The entire area of its beautiful park square in the center of town was black topped and converted into a parking lot. In spite of opposition of the people, pressure by business men prevailed.

*New Rochelle, New York.* An eighteen-acre parcel of vacant city-owned land, the last sizeable tract ear-marked for recreation, was sold at public auction by the consent of the council, without consulting the planning board.

*Detroit, Michigan.* Nine acres in General Patton Park was taken for cottage-type detention shelter for young people.

*Edgewood, Pennsylvania.* Four acres of its one eight-acre park were taken for a new road.

*New Haven, Connecticut.* The mayor and board of education, which sold its three high schools to Yale University, requested the park board to permit the building of two new schools on park property. Although it refused, the park board offered two alternate park properties for the purpose—one of them a fourteen-acre tract.

*Waukesha, Wisconsin.* City officials gave the federal government more than two acres of a six-acre park for a post office, with no compensation.

*Kansas City, Kansas.* Erected fire sta-

What they really mean is that here is land which has not been built upon or expensively developed. The truth is that this is about the most expensive land that could be used. It is the land that generation after generation of children, teen-agers and adults of all ages will need for active physical recreation and for the relaxation and enjoyment that only outdoor activity can provide.

To take away from our small stockpile of public lands for parks because there appears to be a pressing need is like borrowing from a child's college fund.

2. "It is only a little bit of park land and we have plenty already." Actually, few cities have ample park properties or a well-balanced system of areas of different types and sizes. Every successful attempt to nibble on park properties encourages others.

3. "We can't afford to keep so much tax exempt property off the tax rolls."

This argument is used when proponents seek to divert public park property to private use. They point to exempt real estate to show that the taxable land is decreasing, and that the selling of public parks is a step toward reversing this process.

The truth of the matter is that park lands are an important reason why surrounding property values increase, as repeated studies have shown. Withholding some lands from private develop-

ment actually increases the value of the whole area.

4. "This is the only available land for the purpose."

What they mean is that the use of park land represents the line of least resistance and that it would involve less work and expense than the acquiring of other lands for the project. For this reason, the open spaces of parks draw, like a magnet, every interest seeking additional space.

## It Did Happen There

The variety of non-conforming uses to which parks have been put and the various agencies to which park lands have been transferred are illustrated by the following examples—which also indicate that the problem is widespread: *Anniston, Alabama.* The local housing authority planned housing projects on two city-owned recreation properties, both "ideally located in areas of great need." One project was approved by the federal government before the city park and recreation board knew about it and could take steps to stop it. A protest was then lodged with the mayor at whose recommendation the city council refused to release land for the second project.

*Redwood City, California.* Five acres of its limited parks were given to the county for a justice hall and to the school department for a new school.

tions in several of the city's parks.

Other areas have been used for shopping centers, industrial sites, high school stadia, libraries, chamber of commerce headquarters, commercial enterprises, woman's club houses, Scout buildings. The greatest loss has perhaps resulted from encroachments in the form of roads and highways.

In spite of many defeats, park authorities have often successfully resisted attempts to have their properties diverted to other uses.

Central Park in New York City has been threatened over the years by more proposals than any other park but has been strongly defended by the park association, and in many cases by the city officials. It is said that if all the requests for exceptions in the use of the park had been allowed, it would have buildings three layers deep.

The Cook County Forest Preserve Commissioners control more than 40,000 acres that afford recreation for the people of Chicago and the surround-

ing region. Repeated attempts have been made to secure the ownership or control of portions of this extensive preserve for other facilities. Had these requests been granted, thousands of acres would have been lost to the forest preserve. Resistance to the many demands has been made possible through the adoption of sound policies by the Forest Preserve Commissioners. Furthermore, all such proposals have been referred for study and recommended action to a citizen advisory committee. ■

## What You Can Do About Encroachment

**H**ERE are a number of suggested ways by which park and recreation authorities can help to discourage successfully attempts to grab park lands.

1. Prepare, with the aid of competent planners, an over-all long range plan for the acquisition and improvement of recreation areas; publicize the plan widely and coordinate the program of land acquisition with that of the school, housing and planning officials. Your plan and program will therefore be known by the city authorities and will have the understanding support of the related agencies.

2. Develop attractively and utilize effectively every property under your control, insofar as funds for doing so are available. The more highly an area is regarded and the more widely it is used, the greater will be citizen opposition to its disposal or diversion to other uses.

3. Have a sound plan for the design and use of every undeveloped or partially developed area. The public cannot be expected to oppose the transfer to other uses of park properties that for years have not been developed or used for recreation. However, preparation of an attractive sketch or use-plan, after consultation with and approval by the people of the neighborhood or community the area is to serve, helps arouse public interest in the area, enlists support for its development and creates sentiment against proposed encroachments. Publicize your plan, keep it in the public eye through every means at your disposal.

4. Know the status of the park and recreation lands under your control by being familiar with the conditions and

procedures under which each area was acquired; for example, if lands were given the city, know what conditions were attached to the gift. If certain properties were purchased, learn whether they were paid for by funds voted by public referendum specifically for park purposes or by general city funds.

5. Be familiar with state legislation relating to the status of park lands and conditions under which they may be disposed of or diverted to other use. Legislation, as well as court decisions in cases involving the disposal or non-conforming uses of park lands, may be effective means of combating encroachments.

6. Know the respective legal powers, duties and responsibilities of the local governing authorities, park or recreation departments, planning agency or others, as related to the acquisition, management and disposal of park property. Many parks have been sold by action of city authorities who usurped or ignored powers legally assigned to another agency.

7. Establish and maintain close working relationship with the city authorities, and especially with the planning department. This enables you to learn promptly of any proposals involving the disposal or non-conforming use of your areas. If possible, secure agreement that no city properties will be disposed of without consulting your department. Decisions on many such proposals have been reached before recreation or park authorities knew of them.

8. Marshall citizen opposition to unjustifiable encroachment. Parent groups, civic organizations, recreation councils and other interested groups may be urged to protest at city hall;

petitions may be circulated in the neighborhood or community most affected by the proposal. In one city where more than half of a playground was sold to a veterans' organization for a center, with no attendant publicity, a later attempt to sell another playground was blocked when the neighbors learned of the proposal and submitted petitions forbidding the sale.

9. Enlist the cooperation of the press in opposing the proposal. More than one project which would have curtailed the usefulness of New York City's Central Park was killed through the vigorous opposition of the press, even though there was, in some cases, official support.

10. Resort to court action only as a last resort. If transfer or disposal of park land is clearly contrary to public interest or violates any legal procedure, court action is justified in an attempt to prevent it. Augusta, Georgia, affords an example of the organization of a Committee to Preserve Augusta's Parkways and Playgrounds which filed a court injunction to restrain the city from selling a park for commercial use.

In commenting upon the attempt in a southern city to transform an attractive bayfront park into a parking lot a newspaper writer asks, "What will a city give in exchange for its soul?"

Recreation and park leaders today have an opportunity to earn the gratitude of future generations by working incessantly to preserve and expand the public open spaces which others acquired for our enjoyment and use. For, as General David Sarnoff has said, "Not labor but leisure will be the great problem in the decades ahead." ■

**"LOADS OF FUN"**



**with SAFETY**

**HOBBY HORSE SWING**

Excitement—adventure—fun and exercise. They're all combined in this heavy duty Burke-Built Hobby Horse Swing . . . with complete safety. Three point suspension keeps seat level at all times. No pushing necessary—even a tot can create his own momentum.

**KIDDIE GLIDER**

A companion piece to the Hobby Horse Swing. Two can find adventure together in Burke's Heavy Duty Kiddie Glider and they can't bong their heads, pinch their legs, or swing too high.

Burke builds a complete line of swings, slides, and playground equipment for schools, hospitals, institutions, cities and recreation areas, including several new and completely tested revolutionary units for playgrounds everywhere.

For complete information write Dept. A

*The J.E. Burke Company*

FOND DU LAC, WISCONSIN  
NEW BRUNSWICK, NEW JERSEY

For Concrete Playing Surfaces  
and Highly Polished  
Floors . . .



**SUPERIOR  
"LIFETIME"  
SHUFFLEBOARD  
PUSHER**

Superior's new non-friction shuffleboard pusher has rolling fibre wheels—a real floating head! Permits the player to approach from any angle without lifting disc. Fibre wheels guaranteed not to wear out. Each set of 4 pushers packed with 8 unbreakable plastic discs in carton with instruction book. Write for literature today.

**Superior**  
INDUSTRIES CORP.

565 Barry Street • New York 59, N. Y.

Pool and Table Tennis Tables  
Poker Tables • Bumper Pool  
Paddle Tennis Paddles

**x-acto<sup>®</sup> LINO  
BLOCK PRINTING  
CUTTING TOOLS**

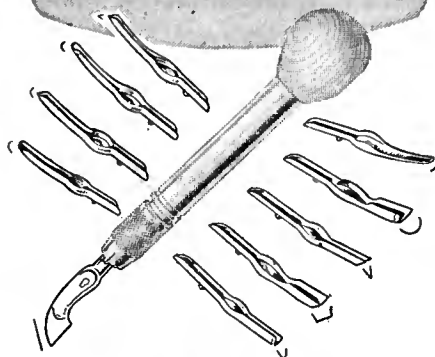

Most popular group craft activity . . . and X-acto tools are preferred because they are the *sharpest, most accurate* and **LOWEST IN COST!** Patented, all-metal handle with non-slip, vise-grip chuck. Complete line of X-acto Lino Tools and Brayers—individually and in sets.

*Illustrated Buying Guide for X-acto Knives, Tools and Handicrafts* . . . 25¢



**X-ACTO, INC.**

48-99 Van Dam Street  
Long Island City 1, N. Y.

*Hop-Hop-Hop your way  
to Hoppy Taw Day*  
**AUG. 17TH**



**National  
HOPSCOTCH  
TOURNAMENT**

**Winner receives**

- 1 10 day free trip to HOLLYWOOD
- 2 Appearance with Art Linkletter
- 3 A tour of DISNEYLAND
- 4 A ride in a HELICOPTER
- 5 Round trip flight on DC-7 by United Airlines



**BE ON TV  
WITH  
ART  
LINKLETTER**

**Contest Rules**

- Must be under 14 years of age and attend public school or recreation center
- Must be the winner of local Hoppy Taw tournament
- Must send one Hoppy Taw card with full name and address—plus name and address of school or recreational center, and name of instructor or teacher

For complete details write to:  
**TOURNAMENT DEPARTMENT, HOPPY TAW CORPORATION**  
927 South State Street, Salt Lake City, Utah



Model 15 Moto-Jig Saw—15" throat, 12 lbs. \$29.95

**A New, Safe Jig Saw That  
Outperforms Higher-Priced Models  
DREMEL Moto-Jig Saw**

Not a toy, but a professional power saw priced within anyone's budget. Performs to the exacting needs of any craftsman, yet can be mastered by an eight-year-old. It's portable; rubber-suction feet let you set up shop anywhere. Unique blade guard protects fingers—makes saw super-safe. The only jig saw in its price class that's powered by a real rotary motor

. . . not a vibrator. With Dremel's exclusive Rocker Action principle the blade stays taut—rarely breaks. Permits using a very thin blade for sharper turns, more accuracy. Cuts 1 3/4" wood, plastics, leather, light metals with ease. Widely accepted by handicraft directors everywhere. For hours of wood-working fun, for young and old, buy a Dremel Moto-Jig Saw.



**WRITE FOR FREE CATALOG** and craft project folder TODAY!

**DREMEL MANUFACTURING CO, Dept. 867F, Racine, Wis.**

# How Golden Gate Park Was Saved

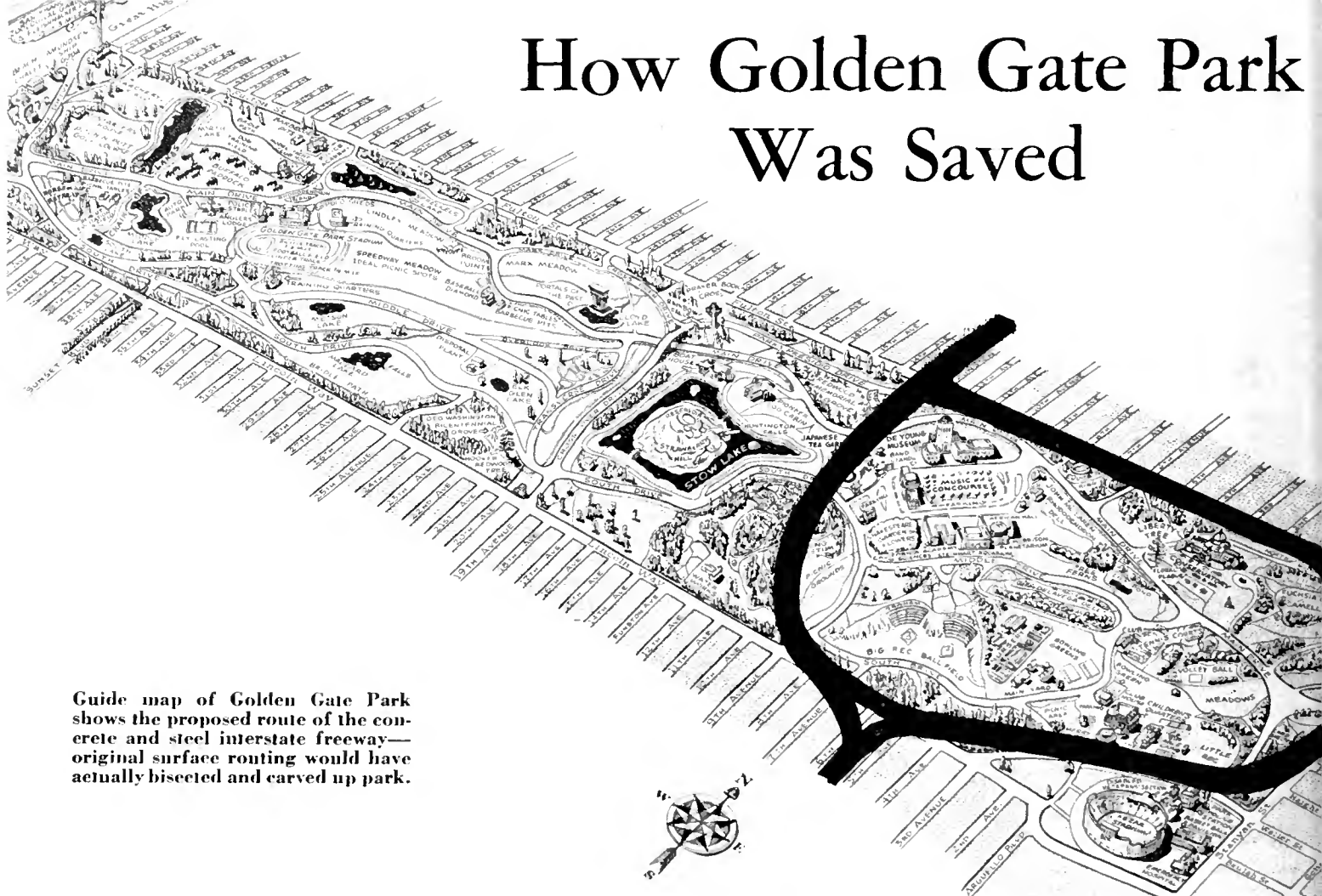

Guide map of Golden Gate Park shows the proposed route of the concrete and steel interstate freeway—original surface routing would have actually bisected and carved up park.

*This modern "success story," of a fight to save land for recreation, is an extremely important one—not only to San Francisco but to every park-conscious community in the country.*

**T**O SAN FRANCISCO its beloved Golden Gate Park is a sacred grove, and anyone who threatens its 1,013 acres is an enemy. Therefore the city declared war on a freeway which would have created a concrete and steel barricade around one of the park's loveliest, most popular sections.

The battle was actually started two years ago when Max G. Funke, general manager of the recreation and park department, told the recreation and park commission he felt the time had come to give voice to public indignation against attempts to encroach on the park with superhighways.

"Freeway construction threatens to destroy our city's inherent beauty and charm, for which it has become famous," he said. "We are faced with the problem of preserving for the use of all people our vast and treasured network of parks and playgrounds. . . ."

"We all realize that a great city like ours must keep up with progress and that progress means freeways. But the people of San Francisco do not subscribe to any theory that progress must inevitably result in permanent scars."

A big six-foot-four, forty-five-year-old former newspaperman, with a keen sense of public relations, Funke urged the commission to intensify its campaign aimed at eliminating from the city's master plan of trafficways any reference to freeway routing which would require any part of the surface

of Golden Gate Park or its panhandle.

The commission promptly and enthusiastically approved the proposal and Commissioner Francis J. Herz was appointed to lead the anti-freeway campaign with Funke and his staff. The commission, in the words of Mr. Herz, "realized that this area, more than three miles in length, created a natural barrier to the movement of north and south traffic through the city, and, therefore, pointed out that it would not oppose tunneling under the park but would vigorously oppose any open-cut, surface or elevated construction."

The committee composed of Herz, Funke and others of the recreation-park staff immediately and systematically began to visit civic, parent-teacher, and neighborhood improvement clubs, to tell of the danger threatening the park. The story was told over and over to groups ranging in size from half a dozen persons to several hundred. And each telling was illustrated by panels showing the park as it is today and how it might look if overhead freeways were permitted.

Stress was laid by the speakers on the fact that one major playground, Father Crowley, had already been completely destroyed by freeway construction, and that large portions of other playgrounds throughout San Francisco had been irretrievably lost to the rapidly expanding freeway system.

City-wide reaction was immediate and positive. Indeed,

so greatly did this campaign "click" with the people of San Francisco that Herz, Funke and their little group were quickly augmented by a large number of volunteer speakers who tried to reach every segment of the city's population.

Scores of organizations passed freeway-lambasting, "Save Golden Gate Park" resolutions. These and hundreds of letters from individuals flooded the mayor's office, the board of supervisors and the newspapers, resulting in coverage that, at times, received Page One position, as well as editorial sup-

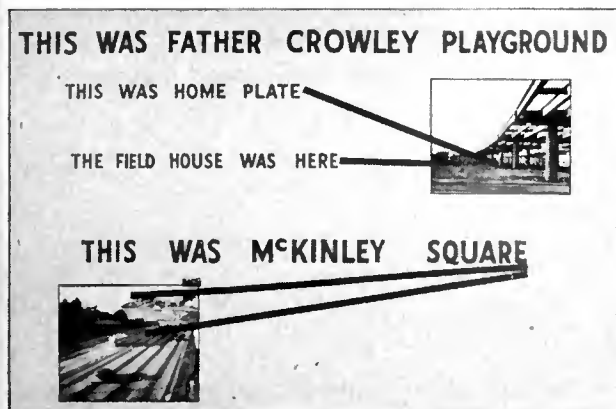

Campaign to reroute freeway utilized especially prepared picture panels which were used very effectively in talks alerting local citizens to imminent danger threatening to disfigure and dismember a park it had taken 75 years to develop.



A loud outcry throughout the city opposed any open cuts, surface or elevated construction within the park's confines. It was felt that "progress" need not inevitably leave permanent scars in its wake, ruining the city's areas of natural beauty.

port. The county grand jury endorsed the campaign.

The swell of public opinion supporting the recreation and park commission's anti-freeway position became so great that it clearly constituted a mandate from the people. Consequently, on May 19, 1955, the planning commission acceded and the portion of freeway going through Golden Gate Park was deleted from the master plan.

But the park defenders couldn't afford to rest on their laurels. The California State Highway Department has tremendous autonomy, and its powers to locate freeways wherever they felt best from a completely functional engineering point of view are almost unlimited. Up to this time the state highway engineers had rarely consulted the recreation and park department of the city in determining preliminary routing of its freeway network.

Now, with the strength of aroused public opinion and with the planning commission's action having been taken, the state agreed to restudy the freeway situation as it affected Golden Gate Park. In this restudying, it asked the assistance of a new committee (which included the city's director of public works, director of planning, fire and police chiefs, manager of the municipal railway, and the general manager of the recreation and park department) to consider possible

effects on the city as the freeway program was developed.

The effectiveness of this committee was vividly demonstrated when it was learned that another freeway—the Southern Freeway Extension in San Francisco—would bisect a brand new playground just completed by the recreation and park department at a cost of \$350,000. On the map the impact of this situation on a costly and needed recreation facility was not apparent, but the situation came to light under the careful scrutiny of the committee. The result was that the state engineers, in a new-found spirit of cooperation, revised their plans so that the freeway could bypass the playground without harm.

Of even greater importance was the convincing of the state highway district engineer that the people of San Francisco would never stand by while Golden Gate Park was criss-crossed with overhead or open-cut freeways. The state revised its plans and the highway district is now surveying the park with a view to placing all freeway crossings underground. Then, if and when construction is completed, the surface will be restored to public recreation and park use.

In this campaign the recreation and park department went

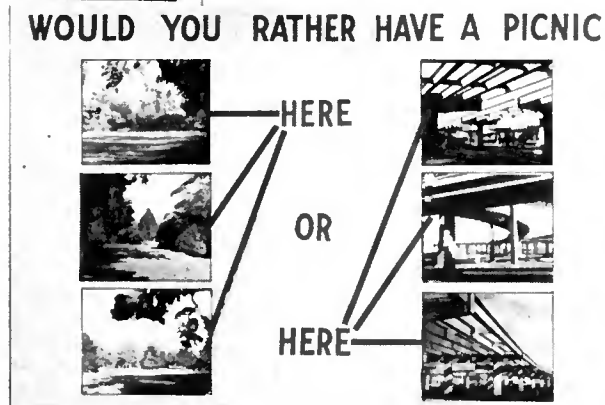

into action *before it was too late*. Other cities in the state had suffered the disappointment of discovering that plans for freeways and acquisition of property for them had progressed too far to be halted when the effect of the freeway on playgrounds and parks was discovered. Its constant contention has been that freeways can—and must—be so located and constructed as not to destroy the natural beauty and the leisure-time facilities of the city.

Tunnels are now shown on the state highway department's drawing boards and San Franciscoans intend to see that they remain that way. ■

# DRAG STRIPS VS

*Showing two sides of a current, controversial activity. Shall we sponsor high-speed competition?*

**I**N ORDER to make the highways safe for the ordinary motorist, hot-rod racing has been taken off the road and placed on a drag strip, under supervision! The drag strip is a special piece of ground set aside for this purpose. It may be anything from an old airport runway, or any flat, smooth strip of land, to an especially built racing strip. A hot rodder, according to the *New York Times*, is a "young man between sixteen and sixty who is a sincere automotive enthusiast." He alters his car, affectionately known as a "beast," to increase its speed, performance and safety. National Hot Rod Association<sup>1</sup> members hold safety as of a Number One importance, performance second.

Drag racing is the competitive part of hot rodding and consists of off-highway racing in souped-up cars which often reach speeds of well over one hundred miles per hour. Such racing, which at one time was a matter of resentment and opposition on the part of the populace, is now an organized activity. It grew among speed-crazy teen-agers after the war; but with supervision has gradually become a recognized sport. In many instances, it has won the support of the police.

A recent article in the Kansas City, Missouri, *Times* stated, "Some hot rodders give a bad reputation to the boys indulging in that sport; but the organized hot rodders have constructive aims, and limit their fast driving to the drag strip." And it goes on to tell the story of a woman who found herself stranded with a flat tire on a busy expressway. A teen-ager in a hot rod pulled up and offered aid. He changed

<sup>1</sup> 5959 Hollywood Boulevard, Los Angeles 28.

## PRO . . . . .

the tire quickly, but refused the five-dollar bill which the woman offered.

"I can't accept that," he said. "It's against the rules." When she inquired what rules, he answered: "The hot-rod club. I had to stop to help—that's part of the rules, too."

Many local organizations, of which the recreation department is often one, are now either singly or collectively sponsoring hot-rod clubs, and the operation of drag strips. Parental consent is always required for participation. Among these communities are: Rockland, Maine; Pomona and Whittier, California; Concord, New Hampshire; Columbia, Missouri; Glen Cove, New York; Sioux Falls, South Dakota; Grand Rapids, Michigan; and others.

In Wilmington, Delaware, the local recreation agency, Recreation and Promotion Service, Inc., originally appointed a hot-rod committee. This eventually organized Wilmington Automotive Activities for all local automobile fans. George Sargisson, RPS executive director, writes, "It seems to me that it is up to recreation personnel to help carry the ball and give leadership in this comparatively new field of youth and young-adult interest."

The organization now has a clubhouse which has been loaned to the group. Membership is open to the weekend pleasure driver as well as to the lad with the stripped down Model A. Among activities and events, limited only by the interests of members, are

talks by people well known in the automotive industry and famed racing drivers, automobile shows, promotion of courtesy, safety, aid to motorists, skill driving contests, use of drag strip and racing. Members agree to a membership code, and their certificate of incorporation, as set forth in the *Membership Manual*, reads in part:

The objectives and activities to be transacted, promoted, and carried on by Wilmington Automotive Activities, Inc., are primarily to further and inculcate in and among the youth and other persons of all communities and places where the activities of this corporation shall be conducted, the principles of safety, courtesy and observance of law in the driving, operation and maintenance of motor vehicles of all kinds; by training, precept and education, to instill in drivers and prospective drivers of motor vehicles and others, a proper sense of responsibility to other persons using the public highways and to the public at large, together with a knowledge of and proficiency in the maintenance, equipment and testing of all kinds of motor vehicles in the interest of safe and efficient operation and the proper control thereof.

The hot rods themselves are, in many instances, wondrous to behold—very often consisting of a patched together body on a high-powered engine and additional carburetors. Speed matters, but so does safety, as any hot rodder will tell you.

John Weitz, international sports-car racing driver, says in a recent article,<sup>2</sup> "Safe driving and skilled driving are inseparable." If you learn one, the other follows—and you can't win a race without skill.

<sup>2</sup> "It Matters That You Finish," by Susan Bennett Holmes, *Woman's Day*. May 1957.

# NO DRAG STRIPS

Some folks think that racing automobiles at top speed is NOT public recreation!

## CON

QUESTIONS regarding the use of drag strips for high-speed racing are arising in an increasing number of quarters. Doubts about combining the drag strip race with the idea of promoting good driving habits and safety are rearing their ugly heads. Since when has automobile racing been safe anyway, and isn't it usually necessary to take chances to be the winner? An article, "The Drag Racing Rage," in *Life*, April 29, 1957, offers an additional argument to the growing controversy: "Safety groups and some police officials feel that the glorification of speed on the strips infects the teen-agers with a fatal spirit of derring-do on the highways." And it points up the fact that "illegal" drag racing at night has sprung up in some cities.

As skepticism began taking over, a National Safety Council committee embarked on a nation-wide check of the situation, which resulted in a recent statement<sup>3</sup> opposing speed contests. The council felt, "Public interest would be better served if the energy and enthusiasm now devoted to drag racing were channelled into more constructive activities."

This has been done with success in Minneapolis, with the Rod Buddies Club which, according to an article in *The Optimist Magazine*<sup>4</sup> is "trying to prove by good example that a hot rodder is not always a 'squirrel' or a 'screw-

driver.' Translated from teen lingo, this means that not all hot rodders are teen-agers bent on speed at the risk of doing harm to themselves and others on the highways."

Recently the members took seven cars on a twenty-mile "safe driving safari" to Remer, Minnesota. En route, the boys relayed to a Minneapolis radio station periodic reports of motorists' driving violations which they spotted. The boys have studied safety regulations and safe driving practices.

A summary of the hot-rod survey undertaken by the National Safety Council reads in part:

Traffic officials and others submitted nearly four hundred replies. Sixty per cent listed existing clubs and seventy per cent contained tabulatable information. The total report indicated information on about two thousand clubs in nearly two hundred cities. The majority of the reports (sixty-seven per cent) indicated a personal opinion in favor of hot-rod club activities except where they involve competitive speed contests. They indicated that hot-rod activities related to safety should be encouraged unless they are expedient measures to gain public support for the actual goal of obtaining a drag strip for speed competition events.

Drag strips were also condemned at the annual conference of the International Association of Chiefs of Police in Chicago last September. According to the *Kansas Government Journal*, the association called on all law enforcement agencies "to refrain from participating in the establishment and/or operation of drag strips or other similar activity for speed contests."

"All clashes, of opinion on this subject, can be lessened, however, if drag races are held under proper supervision at a site that holds to a minimum the chances for accident," says the American Society of Planning Officials<sup>5</sup> in a thirty-one-page report, *Hot Rods, Car Clubs and Drag Strips*.

Interesting, too, is the comment in an editorial in a Reading, Pennsylvania newspaper: "Whether or not there is any sense at all in stepping up the velocity of gas engines which, as they come from the assembly line, already are equipped to deliver more speed than may legally be used on even Pennsylvania's modern turnpikes may be a debatable question. Be that as it may, however, we shall offer no objection to "drag strips"—if those who want to use them also pay for them.

"We bow to the principle of personal freedom by conceding that if some folks want to drive at dangerous speeds and possibly endanger their own lives at locations and under conditions which do not place the safety of others in jeopardy, that is their business. But in our view, and we believe in the view of a great majority of taxpayers, it would be wrong to use a single cent of public funds for that purpose.

"That condition appeals to us as being reasonable because driving 'souped-up' automobiles at top speed can scarcely be called public recreation. In any case, it is not the kind of recreation that should be emulated by others in everyday life. On the contrary, it sets an example which, if followed on public highways, would be a violation of the law." ■

<sup>5</sup> 1313 East 60th Street, Chicago 37, Illinois.

<sup>3</sup> See RECREATION, March 1957, page 72.

<sup>4</sup> "Teen-Age Drivers," January 1957.



# Recreation Developments in 1956

*Based upon the annual reports of NRA district representatives.*

**Compiled by Charles E. Reed**

**T**WO IMPORTANT trends in consolidating administrative authorities for recreation and parks gathered momentum in 1956. One of these is the increasing consideration being given to the combining of city and county recreation departments or park departments—a result of the growing problem of providing recreation services for “fringe areas.” These sections, just outside city boundaries, increasingly plague many urban communities.

Some of the localities presently consolidating city and county efforts are Fort Lauderdale and Broward County, Gainesville and Alachua County, Sarasota and Sarasota County, Florida; Augusta and Richmond County, Georgia; and Greenville and Greenville County, South Carolina.

The city recreation department of Dalhart, Texas, provides service to Hartley and Dallam counties through a recreation council of nine members, three appointed by each of the three government authorities.

In suburban sections around Detroit, Michigan, several areas formerly incorporated as townships, with rapidly growing smaller communities within their borders, have reorganized, with the township now being incorporated as a total city, thereby facilitating total coverage in planning facilities, recreation services and financing. Marion Preece, former NRA Southern District representative, says, “It is reported that Warwick, Hampton and Newport News, Virginia, will consolidate into one municipality. In that event, the recreation areas of the three incorporated towns would be combined. This would be a boon to Newport News, the one town that provides recreation areas and facilities under full-time year-round leadership and bears the financial burden for this leadership which also serves Hampton and Warwick.”

Out of a total of 134 different administering authorities established during 1956, there were fourteen new county and fifteen new district recreation and park authorities.

The other continuing trend is toward the combination of local separate park and recreation departments. For example, the park and recreation departments in Colorado Springs, Colorado, were consolidated during 1956, with the appointment of a director of parks and recreation and changing the title of the former recreation director to assistant director of parks and recreation. In Grand Forks, North

Dakota, the director of recreation was appointed superintendent of parks and recreation when the superintendent of the former separate park department resigned. A similar transition is occurring in Rapid City, South Dakota, where the park superintendent has also resigned. Some other cities and their effected consolidations during the year are: Bellwood, Marion and Murphysboro, Illinois, combined parks and recreation; St. Louis Park, Minnesota, combined schools, recreation and parks; Mercer, Wisconsin, combined parks and recreation. These facts demonstrate the growing stake in parks, on the part of recreation administrators, and in recreation, on the part of park administrators.

*Local Referendum Elections.* Levy and bond issues approved during 1956 exceeded even the high levels of 1953 and 1954, after a less active year in 1955. *One hundred and ten* successful bond issues were reported over the country.

*Training of Local Leaders.* The variety of training programs promoted and conducted by many of the state recreation societies and associations, state recreation departments or consultants, colleges and universities were more numerous and productive of good results. These included institutes, workshops and special sessions, many for training in activities skills. State and district conferences and the National Recreation Congress regularly provide more special training sessions in which both paid and volunteer leaders participate. Everywhere interest in various types of leadership training is more evident.

In addition to training in the skills of playground leadership, indoor recreation center programs, music, arts and crafts and drama, the need is emphasized for training of administrators\* in administrative procedures, planning, operation and maintenance and public relations. There is more demand for training courses in nature education, day camping, water sports and other aspects of outdoor living.

The National Recreation Association is still being urged to continue its present leadership training services and to add courses in nature education and other phases. A total of approximately six thousand local recreation leaders, both paid and volunteer, were trained by the Association's specialists in social recreation, playground activities, drama and creative recreation and arts and crafts. The Association also initiated an internship training program for students with graduate degrees in recreation, during the year. ■

---

MR. REED is director of the National Recreation Association Field Services.

\*See “Second National Institute for Recreation Executives,” page 234.



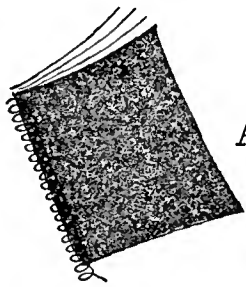

## A REPORTER'S NOTEBOOK

### NRA Board Elections

Former New York City Police Commissioner Francis W.H. Adams was elected chairman of the Board of Directors of the National Recreation Association at the annual meeting of the Board at Association headquarters in New York, May 22. Mr. Adams, a long-time member of the board, will fill the vacancy created by the death of Otto T. Mallery in December 1956.

Grant Titsworth of Noroton, Connecticut, an attorney, was elected first vice-president; Miss Susan Lee of New York City continues as second vice-president and secretary of the board; Mrs. William L. Van Alen of Edgemont, Pennsylvania, becomes third vice-president. Joseph Prendergast of New York City was re-elected executive director and secretary of the Association, and Adrian M. Massie of Rye, New York, was re-elected treasurer.

New board members are: James H. Evans of Chicago, secretary, treasurer and general counsel of the Reuben H. Donnelley Corporation; Richard A. Dougherty of New York City, public relations counselor; and Edgar W. Smith of Portland, Oregon, a previous president of the Portland Chamber of Commerce, interested in serving youth, and an NRA sponsor since 1949.

Mr. Adams, the new chairman, has been active in the National Recreation Association for many years. He has also been appointed to the New York City Board of Education by Mayor Robert Wagner, as recently as May 21, 1957. He is a partner in the law firm of Satterlee, Warfield and Stephens, was formerly United States attorney for the Southern District of New York.

Miss Lee is known to the readers of RECREATION as an officer of the board, a contributor, and as the daughter of beloved Joseph Lee, one of the founders

of the Association and of the playground movement in America.

### Parsons Memorial Gardens



Mrs. Howard A. Frame is shown at the dedication of the Parsons Memorial Gardens with Waldo J. Dahl (left), president, Seattle Board of Park Commissioners, and Mayor Gordon Clinton. Mrs. Frame, a Parsons, is on NRA Board.

Children of the late Mr. and Mrs. Reginald H. Parsons donated to Seattle, Washington, the family's formal gardens overlooking Puget Sound. These will be a living memorial to their parents who, among other local contributions, gave several hundred acres on Hood Canal for a Boy Scout camp. Mr. Parsons was an NRA sponsor for many years; his son, George, is a present sponsor; and one of his daughters, Mrs. Howard A. Frame of Los Altos, California, is an NRA Board member. She and her sister, Mrs. John S. Day of Medford, Oregon, made the presentation to the mayor and the park board.

### Milestones

Two park and recreation agencies celebrating fiftieth anniversaries this year are the Milwaukee, Wisconsin, County Park Commission and the Fort Wayne, Indiana, Park and Recreation Department. Still going strong, Milwaukee is currently constructing a war memorial building on Lincoln Memorial

Drive to house two art galleries and other facilities—including headquarters for its new children's art program. An ultra-modern zoo is also due to open shortly. Fort Wayne boasts a new artificial ice rink. Two-thirds of the rink's \$175,000 cost was provided by the MacMillen foundation.

### Honored

WALTER L. SCOTT, director of recreation, in Long Beach, California, recently received a fitting tribute to his twenty-five years of recreation leadership in the form of a scholarship fund established in his name by the Long Beach Recreation Association.

JOSEPH E. CURTIS, director of recreation in Oceanside, New York received the annual community service award presented by the local Veterans of Foreign Wars post. The Oceanside recreation department and VFW co-sponsor an increasing number of community recreation activities.

### Safety Afloat Campaign

The first state-wide effort for water safety for everyone recently initiated by the state of Georgia might well serve as a pattern for other states (or even community recreation departments). Because of the high incident of deaths by drowning throughout the nation last year, Georgia's governor issued a proclamation designating May as Safety Afloat Month and calling upon local organizations for cooperation. A printed safety afloat campaign bulletin outlined safety rules, suggested activities, Georgia laws and regulations pertaining to the use of boats. For further information, write to John J. Komp, First Aid and Water Safety Services, ARC, 1955 Monroe Drive, N.E., Atlanta 9.

### Outlying Recreation Lands

Working on a research grant for study of the need for outlying recreation lands, Cliff Hutchins, of the University of Wisconsin, will make an effort to determine the amount and kinds of lands outside of population centers that should be reserved for public recreation uses, as a part of sound planning. Conclusions will be based upon data collected in the state of Wisconsin this summer. He writes, "It is clearly a technique-developing type of study

which we hope will be followed by an analysis of the available lands of scenic, scientific, historic, and other recreation interests within the state, and possibly a further study of the economic effects of reserving the requisite amounts of land for recreation purposes. In all of this our focus is on outlying park lands away from the immediate environment of the study."

### Global Baseball

Hundreds of non-pro baseball clubs with players of unlimited ages will soon be playing in the forty-eight state tournaments to determine the U. S. representative in the third annual global baseball series in Detroit's Briggs Stadium, September 13 to 18.

After the forty-eight state titles are decided, the twenty-third annual national tournament will follow in Wichita, Kansas, starting August 16. The cream of the state championship teams will participate in this event, which annually attracts about 100,000 fans. The national winner will represent the United States in the third global series with an all-expense trip.

Sandlot and semi-pro baseball clubs interested in participating in the tournament program should write to National Baseball Congress, Wichita 1, Kansas.

### National Folk Festival

The twenty-second annual National Folk Festival will be held in Oklahoma City, June 26-29, as a major part of Oklahoma's statewide semi-centennial celebrations. The festival will be presented at a gala folk center within the semi-centennial exposition grounds. Oklahoma Indians, who have been a part of nearly every folk festival program, will play a vital and colorful role in this year's event.

### Foresight to the Future

Three American cities, after examining the slums and other mistakes of their past, have undertaken ambitious reclamation and rehabilitation projects and have made long-range plans for future expansion. St. Louis, which has passed a \$1,500,000 bond issue for park and street improvement on its Memorial Plaza, is moving to check and correct the spreading squalor of the congested

residential areas in this 193-year-old city. Philadelphia has had 276 years for growth of its slums, so its present reclamation project in South Philadelphia is on an extremely large scale. In New Jersey, 165-year-old Paterson has adopted a Master Reference Plan after eight years of study, which calls for "enlarged recreation areas to enhance the residential character of the city." It also calls for master recreation areas, athletic fields and separate playgrounds for pre-school, grade school and high school pupils; and it proposes several new major parks and small neighborhood parks.

### "A Tree is Nice"



The 1956 Caldecott Medal, given annually by the Children's Library Association for "the most distinguished American picture book for children," has been awarded Marc Simont for his illustrations in *A Tree is Nice* by Janice May Udry (Harper & Brothers).

The annual Newbery Medal for "the most distinguished contribution to the American literature for children" for 1956 went to Virginia Sorensen for *Miracles on Maple Hill* (Harcourt, Brace).

The John Burroughs Association Medal for 1957 was given to Archie Carr, author of *Windward Road* (Alfred A. Knopf), a naturalist's adventures studying sea turtles and other water creatures in the Caribbean.

### About Face

When a Little Leaguer takes the field is he, in effect, an employee of the sponsoring organization? This question recently perplexed the New York State Workmen's Compensation Board. One of the board's referees had ruled that a fourteen-year-old boy was entitled to four hundred dollars in injury benefits from the merchants' organization spon-

soring his Little League team. He had lost several teeth when struck in the mouth by a ball during a pre-game warm-up. A review board later reversed this decision.

The boy's parents contended that, as a member of a team sponsored by the association, he was, in fact, an employee of that association and therefore entitled to the same workmen's compensation as any other employee. The compensation board referee agreed that, although the youngster was not an employee "in the ordinary sense," he nonetheless "furthered the purpose for which the association was incorporated" and that the association "profited from the advertising" carried on the team uniforms (name of the association).

Later, a three-member panel reviewed the case and ruled that the boy was not an employee under the New York Workmen's Compensation Law and hence not entitled to injury benefits. The board chairman further pointed out that sponsors of teams in the Little League and Babe Ruth Baseball League were required by their national headquarters to provide adequate accident, health, hospitalization and liability insurance.

### On the Plus Side

The past year has seen some notable additions to our recreation acreage as well as some victories in preserving threatened recreation areas:

⊕ An attempt by the Army to annex 10,700 acres of the Wichita Mountains National Wildlife Refuge in Oklahoma to Fort Sill was settled when the Army accepted 3,600 acres across the southern tip to be used as a buffer zone only.

⊕ A projected national historical park along the Maryland bank of the Potomac, to include a considerable portion of the picturesque old Chesapeake and Ohio Canal, seems assured.

⊕ In Florida, historic Sugar Mill Gardens near Port Orange, formerly a private tourist attraction, have been leased to the Volusia County Commission as a public park at \$1.00 a year.

⊕ A new 220-acre International Park at Idlewild Airport, New York City, is nearing completion.

⊕ In California, Los Angeles County is progressing firmly with its program to develop a network of 700 miles of

horseback and hiking trails (over 250 miles are already completed). This is a major segment of a projected 3,000-mile state trail system being constructed with a five-year \$2,000,000 appropriation. The trails will eventually take the rider or hiker from the Oregon line to the Mexican border with a minimum of interferences with, or from, inhabited areas (even new subdivisions are required to establish easements for the trail system). The Los Angeles County Parks and Recreation Department has a full-time trails director, Paul R. Little, and a full-time construction crew of seven developing the trail network.

### Among the Missing

GOING! A National Park Service survey of the Atlantic and Gulf coasts reveals that, of the 3,700 miles of general shoreline, there are only 240 miles, or 6½ per cent, under federal or state ownership for public recreation purposes and little available for future acquisition. More than half of the 240 miles is in the Cape Hatteras National Seashore Recreation Area and in Acadia and Everglades National Parks. The Park Service will do a similar study of the Pacific and Great Lakes shorelines.

GOING! Various international organizations have become concerned about threats to wildlife and open lands in Africa! An attempt by the Tanganyika government to reduce the Serengeti game park by a third in order to accommodate migratory Masai tribesmen aroused an international storm. Local wildlife conservationists, as well as American and British authorities, have protested the move and the Serengeti affair is being regarded as a test case for national parks and reserves in Africa.

GONE! The U. S. Forest Service has changed the boundaries of the Three

Sisters wilderness area in Oregon to allow timber production and has let contracts to American and Japanese companies for large-scale lumbering activities on Admiralty Island in Alaska. Conservation organizations have long advocated that both these areas be given national park status.

### Youth Fitness Benefits



At the Big Bike Ride and Jamboree in Washington, D.C., sponsored by American Youth Hostels on May 19, Miller Moore, (above right) presented the AYH National Award for Distinguished Service to Youth to President Eisenhower through Dr. Shane MacCarthy, executive director of the President's Council on Youth Fitness. Miss Margo Lucy, the current Miss Washington, is shown riding one of the American middleweight bikes presented to local orphanages by Robert E. McLaughlin, president of the District's Board of Commissioners, in behalf of the Bicycle Institute of America. The purpose of the AYH Big Bike Ride was to direct attention of the public to the benefits of cycling and hosteling for youth, and to demonstrate the need for bike paths and special routes for cycling.

Local recreation departments might well use a like stunt to catch public attention and support for community cycling programs as well as for physical fitness values of cycling.

### To Uphold the 97

The firm belief that "97 out of 100" of the 13,000,000 teen-agers in this

country "are responsible kids," has led Cornelius Vanderbilt Whitney to invest \$2,000,000 in a film to prove that today's youth "is a terribly maligned generation." Mr. Whitney, an industrialist, sportsman and motion-picture producer, believes that the film (based on John Burress' *The Missouri Traveler*, published by Vanguard Press, 1955) will present a more balanced picture of American youth than the usual Hollywood movie indicates.

### IN MEMORIAM

#### Charles Frederick Weller

As we go to press, the news reaches us that an old friend of the recreation field died in May, at the age of eighty-six. Charles Frederick Weller, one of the pioneers of the playground movement, established the first playground in our nation's capital when he was an Associated Charities executive in Washington. He also was one of the founders of the Playground Association of America, serving as a member of the Association's staff for about ten years, beginning in 1912. During part of that time, he was Association Secretary.

The National Recreation Association's Board of Directors has passed a resolution at its May 22 meeting, honoring Mr. Weller for his contributions to recreation, social welfare, and world fellowship. He was editor of *World Fellowship*, a book published in 1936 by Liveright Publishing Corporation.

#### Guy L. Shipps

Guy L. Shipps of Midland, Michigan, died on May 23. He was a pioneer in the field of recreation in Midland and was well known nationally for his interest and activity in recreation for the industrial worker. He served as consultant on community activities of the Dow Chemical Company at Midland. Taking a six months leave of absence in 1942, he served on the staff of the National Recreation Association in connection with a study of recreation for wartime defense workers.

RECREATION Therapist positions in California State Hospitals open to college graduates with major in Recreation or Recreation Therapy and supervised field work. Opportunities for advancement. For information and salary schedule effective July 1957 Write: Medical Recruitment Unit, Box R90, State Personnel Board, 801 Capitol Ave., Sacramento, California.

**Jamison PLAYGROUND EQUIPMENT**

Be sure to check the many exclusive features of this rugged line. Write for free catalog of 254 items.

Jamison Manufacturing Co. Since 1925  
 8701 South Mettler Street  
 Los Angeles 3, California

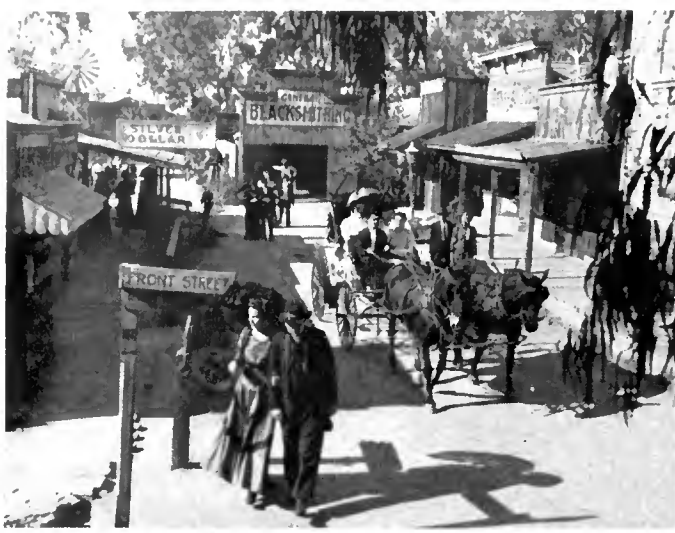

Early California lives again in this Main Street in Ghost Town. Stop off here when you go over to Knott's Berry Farm in Buena Park for a chicken dinner, or en route to pay a visit to the Steak House.

**D**ELEGATES, ATTENTION! Save a few of your summer vacation days for Congress time, and use them for some adventuring down Long Beach way. Enjoy this playground of Southern California.

From the balcony of Congress headquarters, the Municipal Auditorium, you will not only be able to enjoy the blue Pacific Ocean but, on a clear day, to see lovely Catalina Island. Or, after only a few minutes by air or two hours by steamer, you can examine Catalina first hand and explore a paradise of undersea gardens, flying fish and submarine life through glass-bottom boats. Many outstanding recreation facilities and activities are to be found in and around Avalon, Catalina's charming small city.

As a matter of fact, there are other famous attractions within a thirty-five-mile radius of Long Beach—the San Gabriel Mountains, desert areas, orange and lemon groves, and miles of Pacific Ocean beaches. Or do you yearn to take a stroll down to "Hollywood and Vine"? The movie studios are only an hour from Congress headquarters. This goes also for Beverly Hills, Santa Anita, the Rose Bowl and the beautiful Pasadena area. For those who wish to play golf or tennis or go swimming, ample opportunities exist.

Fantastic Disneyland, built at a cost of more than \$22,000,000, requires at least a whole day. It is a land of make believe, where grown-ups revert to childhood fantasy as they visit True Life Adventureland on a jungle boat ride, Frontierland, Fantasyland, Storybookland, and other imaginative and thrilling lands.

According to Jessie Ash Arndt, writing in *The Christian Science Monitor*, the adult in Disneyland "either feels like a child again or he remains rather wistfully adult, a little ashamed of having forgotten to check his grown-upness at the gate."

#### For Congress Week

It is usually warm during this season in Long Beach. Lightweight clothes are in order and no rain equipment is necessary. Those coming in cars will find innumerable short

# What To Do and See

*Combine your vacation with The National Recreation Congress, by the sea, September 30 to October 4!*

sidetrips of great interest. The county abounds in attractive motels and good moderately-priced hotels in addition to the larger ones where conferences are usually held. Living expenses will be no higher than in other sections of the country and are really much more reasonable than in many. *Make your hotel reservations early!*

#### Congress Tour

A Congress tour has been arranged on Wednesday, October 2, for delegates to visit the Long Beach municipal parks, beaches and schools and to observe the operation of the unique and successful coordinated municipal and school recreation program. Many new recreation facilities will be in readiness at Congress time as a result of the \$5,000,000 park and recreation bond issue passed by the people of Long Beach in 1956. These improvements include, among others, five new recreation buildings, a modern baseball stadium and many acres of new landscaping. More about them and the local recreation program will appear in the next issue of RECREATION.

On Saturday, October 5, an all-day tour also will be taken to see the beautiful and outstanding Los Angeles County parks and recreation areas.

In addition, many sidetrips have been planned for the leisure time of delegates, and particularly for their wives. For exploration in your leisure, there are many facilities actually at your doorstep. The "Nu-Pike," a large commercial recreation area within walking distance of headquarters, is the "Coney Island" of this southland. Visitors may walk or drive around Rainbow Pier—a drive built over a part of the Pacific Ocean—then stop to rest and listen to the public forum at the "University-by-the-Sea." Belmont Shore and Pierpoint Landing afford nautical atmosphere, varied restaurants and interesting shops. The newly-completed marina, built at a cost of \$14,000,000, provides anchorage for many small craft including sailboats.

At Congress time the sport-fishing season will be at its peak. White sea bass, barracuda, albacore, yellowtail, and so on, can be caught even on half-day fishing trips. Live-bait barges lie within the calm harbor waters. Here halibut, mackerel and shark will give all the thrills of a deep-sea trip. Several fresh-water spots are close by for trout and other species. If you are *really* vacationing, be sure to pack your fishing tackle. ■

# n Long Beach



Pacific Ocean breaks on Southern California's interesting coastline. This panorama shows Alamitos Bay in Long Beach and the popularity of the surf on its azure surface. Sun and surf relax on beautiful beaches protected by breakwaters. There is ample opportunity for deep sea and surf fishing. Long Beach is one of the country's great ports and produces one fourth of California's oil.

pan real gold in the sluice box in Long Beach. From Long Beach, you take Highway 39 north just five miles to the Ghost towns and old missions, orange groves, mountains, desert and ocean. Would a sight-seer find a wider choice?

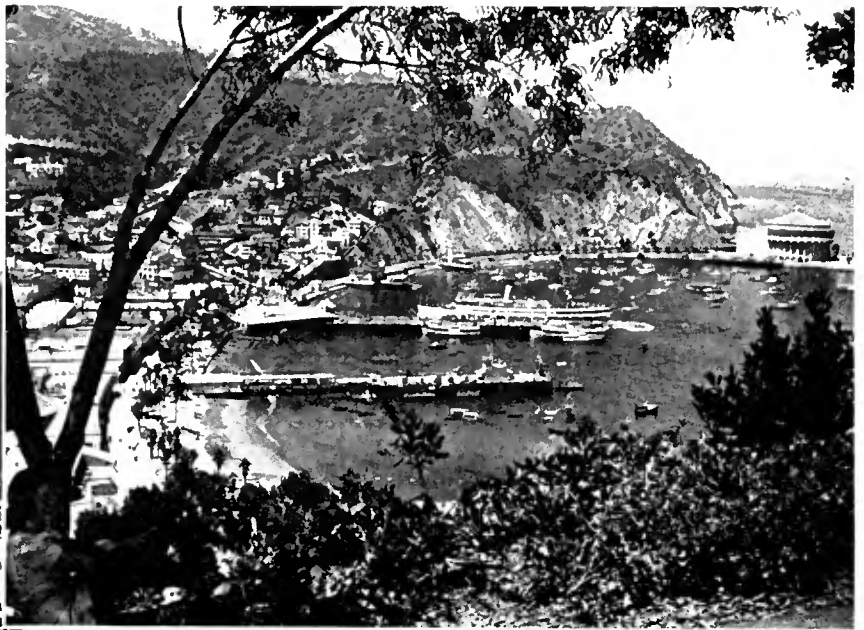
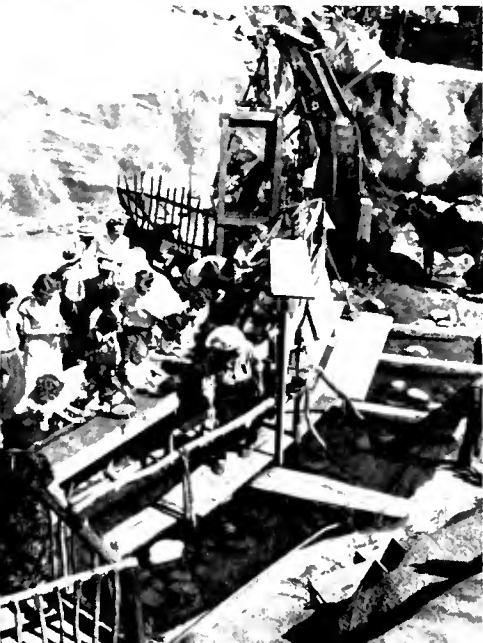

Beautiful Avalon Bay, showing steamer at dock and glass-bottom powerboats awaiting passengers for the voyage over Santa Catalina's renowned submarine gardens. The island also offers sight-seeing tours and moonlight horseback rides.

Right: In Disneyland visit the Rainbow Desert and Caverns aboard the miniature Rainbow Mountain Mining and Exploration Company train that chuffs along, passing such wonders as multi-colored waterfalls and other spectacles. If you fancy you can also travel via the Mississippi River paddle steamer.



Marineland of the Pacific is located thirty miles south of Los Angeles along a rocky coastline drive. Here you can watch marine life underwater. This is the largest oceanaria in the world and is an enthralling experience even if ichthyology isn't for you. It takes all kinds of fish to people an ocean.



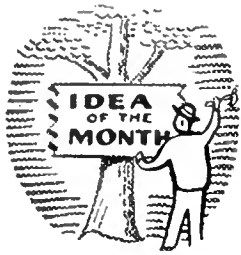

# Brainstorming in Recreation

Mary Frances Sargent

*We can see a teen council trying out this idea, or the outdoor carnival committee, the pageant committee, the Christmas party committee or other special special committees that are usually tearing their hair to think of new and exciting ideas. A department staff, too, can use this plan to discover new special events, or promotion schemes, for the summer playgrounds. Try it out! See if it works, and write us your experiences with it!*

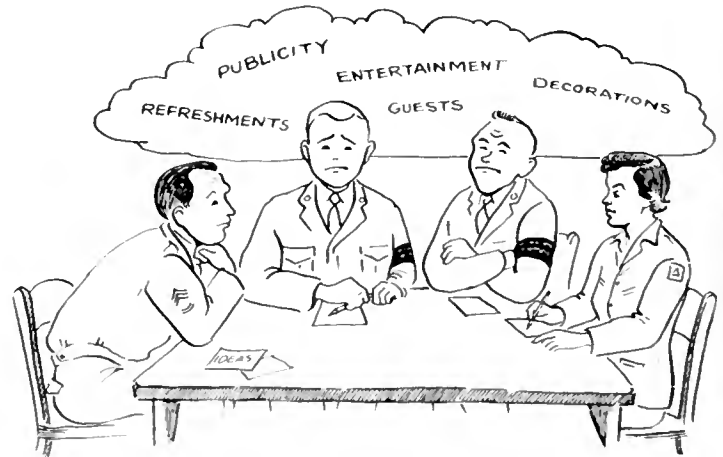

STUDIES have shown that you often can get fully sixty-five per cent more ideas from people thinking together than from the same number of people thinking about the same problem by themselves for the same period of time. In any field that depends upon ideas for the bulk of its success, it is difficult for one person to be a store of unending originality and imagination. A recreation program should be varied and creative and one which offers some different ideas to maintain the interest and pleasure of the participants. I imagine any director knows the anguish of studying a month's program plan and wondering what to offer his participants that will be new, interesting and also stimulate social growth of the individual, or otherwise accomplish the purposes he has set for his program.

Most recreation agencies do have a program committee of some type or provide some method by which the program participants have a voice in deciding what activities are presented and what policies are established. In Army Service Club recreation, this is accomplished, for the most part, by the use of enlisted men's councils. At our installation, we have used these councils as a part of the planning process. Many valuable suggestions have been given by the men. They not only have a voice in what activities to include in the program, but also in establishing policies and in actually carrying out part of the program scheduled.

Council meetings in the past have been of a pretty general type and dealt not only with program plans but with many

other topics and problems. By dealing with so many topics in one morning, however, we generally did not get down to developing or generating any real creative thinking. When it came to deciding what activities to include in the month's program we stuck pretty much to what had been done before. If a particular activity had proved highly successful, the tendency was to repeat it. It seemed evident that some tool was needed to use the council in a more effective way, to keep the group from thinking in a stereotyped manner and to raise the level, so to speak, of its function.

With these thoughts in mind, I happened upon an article which described a thought process, originated in the advertising field, labeled *brainstorming*.<sup>\*</sup> This is a freewheeling thought process that produces ideas for solving specific problems. The ideas come from a group of people who sit down together, concentrate on a specific problem, and speak their minds without having to worry about how silly their ideas may sound to anyone else. "The process works on the basis that a meeting is devoted *only* to the giving of ideas. No discussion, no criticism. No can't's, but's, that-wouldn't-work! No handshaking, no smiles of approval, or frowns of doubt."

This process might well be adapted, I felt, as the tool we had been seeking to make our council more effective. It also seemed a way to have the enlisted men concentrate on one phase of our work at a time. Often in our usual meetings, good ideas were sometimes lost in the immediate discussion of details or the pros and cons of something. So we decided to try brainstorming. Although its exponents recommend the technique to get new ideas and to solve any problem, we used it in one meeting to get new ideas for service club programs and completed the session with a goodly number of very workable ones not thought of before.

This thought process is used by such commercial com-

<sup>\*</sup> "Brainstorming" has passed into language, being one of the new words cited in the 1957 *Britannica Book of the Year*.

---

MRS. SARGENT is director of the Granite City Engineer Depot Service Club, Granite City, Illinois. Excerpts are reprinted with permission from an article by Karon Kehoe, Jobs Editor, September 1956 issue of *Charm, The Magazine for Women Who Work*.

panies as Campbell Soup, Bristol Myers and other large concerns. The whole business, I understand, was a 1939 "brain-*lash*" of Alex Osborn, co-founder of Batten, Barton, Durstine and Osborn, one of the largest advertising agencies. "Brainstorming," the article in *Charm* which served as a guide in our adaptation of the process to our enlisted men's council, was written by Karon Kehoe. She points out that, to successfully use the method, the group must fully understand the rules and the process involved. The first thing to get across is that this is to be a thought process to solve a specific problem; in our case, "What types of recreation program activities would be of interest to the soldiers who use our club?" We purposely chose a comparatively simple subject for our first session.

Miss Kehoe suggests that certain ground rules, which follow, should be observed. Each is important and contributes to the total success. A chairman is appointed (this could be the Service Club director or chairman of the council) and has a small table bell at his disposal. He rings this bell when anyone makes a slip in brainstorming etiquette, offering criticism, or a that-wouldn't-work comment, and so on.

### Governing Rules

1. Judgments are out. Criticism of ideas must be withheld until later. The no-evaluation approach elicits more ideas than alternate thinking and discussion.
2. Freewheeling is the order of the day. The more uninhibited the mental calisthenics performed, the better. Wild ideas spark others to think more imaginatively. It is always easier to tame down than to think up.
3. The more ideas the better, sheer quantity is important because the percentage of usable ones remain stable.
4. Combinations of two or more ideas may be best of all. In addition to contributing ideas of his own, each council member may try to improve on the ideas of others or recombine them in new ways. Hitchhiking, as it is called, is welcome.

### Preplanning

Apart from instructing your council or panel on the ground rules, some preplanning is necessary:

1. Members of the council can be the "core" members, or the group can be enlarged with guests invited for varying backgrounds or experiences.
2. Ideally, all participants should be on a par in authority (all enlisted men, or workers, or volunteers) but officials should not, as a general rule, be included. One member of higher authority will halt the free-thinking process usually. "Fear of appearing foolish in front of the boss can squelch even the most precocious—and possibly precious—brainchild."
3. The chairman should present a memo to each member at the beginning of the meeting stating the exact problem or idea to be tackled.
4. Arrangements should be made for pre-meeting food. It needn't be fancy but "on the house." Coffee and cookies will suffice. Sharing food establishes a relaxed atmosphere.
5. Someone should be assigned to take notes—reportorially, not word for word. No one is given credit for his

ideas as such, because he might never have had it if someone across the table hadn't had another idea first.

6. The secretary also numbers the ideas so the chairman can keep track of how many ideas have been developed. This information can be used in a "squeeze play" by the chairman, who may say, "We have twenty-five ideas, now let's make it thirty in the remaining five minutes time." Even when the panelists are limp, just one more idea can set off a whole set of others.

Care should be exercised in the selection of a chairman, as a session may "curl up and die" because of a pontificating chairman, or a council member, determined—bell or no bell—to hog the whole show.

### Idea Use

After the meeting the chairman should go over the original list to see that all ideas are properly and adequately described. From this list the chairman or council will have to weed out those ideas which may not be suitable for local reasons, those that are way beyond the budget or those against agency policy. What's left? Eight, ten or more ideas, probably, which are good, and maybe some which are outstanding.



Some provision should be worked out whereby the panel or council can be given a report on which ideas are to be adapted and, maybe, reasons why others had to be rejected. Or it may be a more suitable plan to have the members of the council, in a later meeting, sift through the list and select those ideas most suitable. Subject of the meeting and local conditions will probably dictate which plan would best fit the needs. At any rate, members will be interested in the fate of their brainchildren and some provision should be worked out to take care of this interest.

### Do's and Don't's

If you are thinking of promoting a session:

1. *Don't* be aggressively enthusiastic before the session is held. You will provoke a skeptical, "we'll see" attitude.
2. *Do* brief your council members thoroughly both about "brainstorming" and about the problem to be worked on.
3. *Do* follow up and hold council member interest by reporting results.

Valuable as are the specific ideas that come out of the sessions, perhaps even more valuable are the by-products in human terms: limbered imaginations, greater tolerance of others "crackbrained" ideas. And, there is the business of

learning to play a game, so to speak, while working. The value, too, of working as a team becomes evident to each council member.

Although brainstorming is a process developed in the advertising field, it seems an ideal process to adapt to recreation planning. A good method to insure that participants in the program have an active part in planning and a sure method of injecting their recreation "wants" into your program.

Some topics that have been selected for future brainstorming sessions by our enlisted men's council are:

1. By what new ways can we more effectively publicize service club activities?
2. In what new ways can we best utilize our community resources in our program?
3. What activities can we plan to attract married couples to the service club?
4. New ideas for a program to honor service club volunteers.

We feel this list is just a start, and can foresee many aspects of our recreation program that could be improved with a brainstorming session. ■

## Softball is Dead?

### NOT IN SAGINAW!

Butch and Pigtail Leagues are slinging some fast ones.

Malcolm Elliott

**I**N THIS day and age of the stepped-up Little League, the Babe Ruth League, the Pony League and the just plain Knothole Leagues, many recreation departments have seen softball, their old standby, sink to the threshold of extinction. This was the case in Saginaw, Michigan, until three years ago when the recreation department decided to do something about it. From a once thriving pre-war program of forty-six men's teams and many thousands of spectators, softball had dwindled to fourteen teams and a few wives and relatives who came out to watch the games. While many laid the blame on TV, on the high cost of fielding a team, and on a stepped-up baseball program in Saginaw, recreation department officials refused to accept a defeatist attitude and set about to win new friends for softball.

Realizing that if you're going to rebuild interest in softball, you have to do it on the youngsters' level, a Butch League for boys and a Pigtail League for girls were organized. Ages for the girls were set at fourteen-and-under, and eighteen-and-under. This was roughly to divide them into categories for junior-high and senior-high girls.

The Butch League afforded an interesting recreation experiment. The YMCA had previously conducted a boys' softball program which had been

dealt a death blow by the advent of Knothole Baseball in the city. Only a few scattered teams remained when the "Y" turned the gasping softball program over to the recreation department. The problem was this—with one hundred and ten boys' baseball teams in town, was there any room for a softball program? Obviously some new source had to be tapped and some new ideas instilled in the program.

Since the baseball program used age categories of twelve-and-under, fourteen-and-under, sixteen-and-under and eighteen-and-under, the age-span seemed pretty well covered; but recreation officials noticed that the nine- and ten-year-olds who were playing in the twelve-and-under division became gunshy of a baseball after a few had bounces in the infield or a few wild pitches hit them. The result was a whole host of youngsters who were falling away from the pitch at the plate and becoming discouraged in the field.

Therefore, in addition to the twelve-and-under and fourteen-and-under age division, a ten-and-under division was added—and it draws more spectators to games than any of the other divisions. On top of this it has stimulated parent interest in the program beyond belief. Whereas many parents figure a twelve- to eighteen-year-old youngster can get to the game on his bicycle and is pretty independent, they will drive the little eight- nine- and ten-year olds to the

game site and stay to watch and cheer. One word of caution in connection with spectators, however. Parents can become overzealous and get carried away to the point of disrupting your game and officials; so Saginaw just put in the rule that no adult may stand in the coaching box or step on the field of play during a game.

Since the baseball program was held in the morning, it was obvious that softball had to be in the evening and this worked out so well that it draws twice as many spectators as the baseball program does. There is only about a twenty-five per cent overlapping of players participating in both programs.

Now, after three years of extensive softball at the younger level, Saginaw's softball program is once more on the upswing, with one hundred and four softball teams playing in seven leagues in Saginaw this past season.

And what effect has this had on the baseball program? *The Knothole Baseball program has actually grown at the same time.* Many of the eight- and nine-year-olds who play softball overcome their fears as their self-confidence grows and join twelve-and-under baseball teams, too. In fact, there were one hundred and seventeen youngsters' baseball teams in Saginaw last year.

The old theory that baseball kills softball participation and vice versa has been disproven here, and other cities may well profit from this experience. ■

MR. ELLIOTT is director of recreation in Saginaw, Michigan.



# Young Citizens Improve Recreation Areas

B. D. Mott

**“A partnership of user and management”— isn’t that what we all want in recreation? Providing opportunities for the “user” to be of lasting service is one of the best ways of achieving such partnership.**



**B'nai B'rith youth at work on their planting project to improve parks and playgrounds. In center (left to right), B. D. Mott and Orin Wennersten of the recreation and park department and Rabbi Morris Kaplan.**

**T**REE PLANTING is important and can be fun! So say hundreds of young Southern Californians, who volunteered to participate in a program of park planting and recreation improvement in Los Angeles.

The idea was conceived in the office of George Hjelte, general manager of the department of recreation and parks, where the chairman of the Interfraternity Council of University of California at Los Angeles and the director of the youth division of B'nai B'rith sat down with William Frederickson, Jr., recreation superintendent, and asked if they could do something of a lasting nature for a park or playground.

Heretofore, these young people had conducted an annual paper drive, and vast quantities of paper were gathered and sold. Revenue thus derived went to local charities. The endeavor was worthy of emulation, but it had no lasting visible effect.

Partnership in industry has long been considered good business, so the question posed was, “Why not try it in the field of recreation?” Certainly the feeling of ownership would be a determinate factor in the reduction of juvenile vandalism, because no youngster is likely to desecrate something in which he has possessive interest.

With this partnership of user and management in mind, a program was formulated and presented to each B'nai B'rith young person and the fraternity in turn. Recreation and park depart-

*MR. MOTT is senior park foreman of the Los Angeles Recreation and Park Department.*

ment maintenance personnel under supervisor Orin Wennersten took to the plan with gusto, and many meetings between park men and leaders of the youth groups resulted in an organization that worked to perfection.

The idea of planting trees, something alive and growing, or improving a bare field with play equipment had an immediate appeal to youthful imagination, and the program was received with great enthusiasm. For a period of three years, this enthusiasm has persisted and has utilized the efforts of twenty-five hundred boys and girls for an average of four hours per person on each project.

As a result, fifteen thousand trees, fifty thousand shrubs, and twenty-five thousand square feet of lawn have been planted. Also, two hundred fifty picnic tables have been put in place and a clubhouse has been painted. A softball diamond with cage and fifteen charcoal-burning picnic stoves were installed.

All was not toil, however, as each group enjoyed a grand picnic during the day. There were games and other features to give every participant a feeling of fun as well as accomplishment.

Five locations were selected for improvement. The first was a brush-covered, hilly sixty acres, with a good level site for a ball field. This site was donated to the city by public-spirited citizens interested in recreation. These same people cooperated further by furnishing transportation, lunch, and refreshments to the five hundred UCLA interfraternity members who improved the area entirely by themselves. The boys did the planting and heavy jobs,

and the girls painted, handled first aid and helped in many other ways. This was a two-year effort and the class of 1954-55 may point with pride to the cedar and eucalyptus trees many years hence and remark how they had a hand in their being.

The other four locations were very well handled by the youth organization and its two thousand teen-age members from all over Southern California who gave their Memorial Day holiday to participate. The problem of organizing them was a little complicated because none of the tree-planters was over eighteen years old. The recreation and park department furnished park foremen to instruct group leaders selected for their maturity from the groups; and these leaders, in turn, gave directions to ten or twelve of their fellow workers.

Results were amazing, in view of the inexperience of the young people engaged in the undertaking. Every tree and every shrub planted was identified as to proper name and place of origin and the planting procedure was explained in detail so that no one would be in ignorance as to what he was doing. No casualties of any nature—except blisters—were suffered by anyone.

It is certain that everyone concerned with this program gained something—the young folks enjoyed the satisfaction of lasting accomplishment and their instructors had the benevolent feeling brought about by a job well done.

The Los Angeles Recreation and Park Department can well be proud of this successful “partnership in recreation” experiment. ■



How would you survive if you were to be stranded suddenly in these surroundings? A "survival hike" will help you find out.



## For Successful Nature Hikes

*Try these new techniques which have been used successfully in holding and expanding the interest of both children and adults—in clubs, schools, churches, Scouts, families.*

William R. Overlease

MANY PEOPLE going on nature hikes and walks need something special to develop or continue their interest on a conducted trip. During six years as a park naturalist in Indiana, leading nature walks for nearly all kinds of groups—from schools and churches to women's clubs, sororities, Scouts, and family groups on vacation—I have found several techniques successful in sustaining and expanding interest. These consist primarily in the use of certain special themes for nature hikes which excite the imagination and relate nature to adventure, history, religion, and other subjects that are so much a part of nearly everyone's experience.

When hikes are scheduled for groups of various ages, including elderly people, they are shorter and listed as walks. For young folks they are hikes. The following four themes have proved most popular.

### Survival Hike

In an area where all the trails are

MR. OVERLEASE is assistant to the director of education in the Academy of Natural Sciences of Philadelphia, Pennsylvania.

very similar, it is often difficult to hold interest after a group had been on more than two or three hikes. Announce a "survival hike"; one that will not be difficult or long. No other information is given to the hikers except that they will need their imaginations. The group is taken to a preselected spot, usually near a small stream. Then tell them to imagine that they are the only survivors of an airplane crash hundreds of miles in a vast wilderness. All they have to help them now is their own good sense and whatever is in their pockets.

After pooling resources—candy bars, gum, matches, pocketknives or anything else they have—they should discuss what to do. Often they need a little help to get them going on their imaginary predicament, but, once started, imaginations work overtime. Usually one or two persons are designated as having broken arms needing immediate attention. This often gets the group started on the right track without further ado. They are soon discussing how to make an emergency splint; handkerchiefs and belts are out, the injured persons are bedecked with bandages, and this sort of situation is under control. It is important

to select the prospective victims carefully. They should have a good sense of humor as they often set the tone of the whole walk with their remarks.

The rest of the hike is spent in figuring out how to signal, whether to stay with the wreck, how to find shelter, what to eat and drink. The leader can help by pointing out edible wild fruits, nuts and greens; how to prepare them; how to catch animals by simple snares; how to find shelter; and ways of keeping warm. "Salamander stews" and "roast grasshoppers" have been favorite recipes discussed on this hike.

Adults seem to enjoy this hike as much as the younger folks, if not more so. The most successful hikes appear to be the ones with a large percentage of adults. There is a note of seriousness with nearly all the groups, as they seem to feel that some day what they are doing and learning might indeed be very valuable. There are several books available on edible wild plants; and the armed forces survival manuals are excellent sources of information.\*

\* See review of *How To Survive on Land or Sea* on page 240.

## Pioneer Hike

Another theme that works well with small groups and family groups is a "pioneer hike" or walk. The groups turn back the clock one hundred and fifty or, if you like, one hundred years by crossing over a magic path—with left arm raised over their head, right eye closed, and holding their breath for ten steps. It sounds corny, but it gets the group in a good mood and is received better by adults than might be supposed. After passing over the magic trail and finding themselves transported back to the year 1820 or so, the group is led to figure out what they will need to live in the wilderness and how to meet these needs with materials from the forest. For example: tulip tree logs for a cabin; white oak clapboards for the roof; pioneer mahogany (wild black cherry) for furniture; inner bark of slippery elm for chewing gum; and so on. Pioneer medicines from herbs also prove to be an interesting subject on these walks — such plants as pleurisy root (butterfly weed), sassafras, boneset, pennyroyal (chigger weed), and flowering dogwood (ague tree). Other materials that can be worked in include soap-making from wood ashes, pioneer dyes, greens and other foods, methods of clearing land (girdling trees and why), folklore, and uses of various kinds of woods for certain products such as fence rails, wedges, mallets and chair caning.

The magic path is crossed again to bring the group back to the present with the same ritual used at the beginning. The hike ends with a short lecture on what these "pioneers from one hundred and fifty years ago" should watch for in this *twentieth century*—horseless carriages, flying machines, noise boxes called radios, and other contraptions.

Elderly people particularly enjoy this walk as they often can give many suggestions from their own early experience or from having heard their parents talk about some activity related to pioneer living.

## Indian Hike

This is a hike along similar lines, appealing mostly to younger groups. It provides an excellent means of interesting young children in spring wild flow-

ers, and has many other possibilities. It helps the group experience, to some degree, how the Indians lived and how much they depended on the things they found growing in the forest. Another objective of this hike is to help the children and their leaders realize how much of our national heritage is the result of our association with the Indians; for example, the names of many of our well-known cities, lakes and rivers, trees, wildflowers, animals and expressions of speech are Indian. These include such names as chinquapin (dwarf chestnut), catalpa, hickory, cohosh, persimmon, pecan, poke, raccoon, coyote, Chicago, Allegheny, Hoboken, Kalamazoo, Pasadena, Illinois and Connecticut. Many, many others could be listed for almost

Why not start an Audubon Junior Club on your playground or in your camp? A minimum of twenty-five members at twenty-five cents each (\$6.25) is all that is necessary to enroll a club. Each child gets a lovely twenty-four-page booklet and an attractive club button. The leader gets the Nature Counselor's Guide and the Audubon Flower Chart. Write to Audubon Junior Clubs, 1130 Fifth Avenue, New York 28.

any local area by checking through state historical materials, county histories, or, if these fail, the several books that have been written on names of U. S. cities and states.

Indian craft materials can be pointed out on the hike; such as those used for making fire by friction, making rope from basswood innerbark, huts from elm bark, preferred wood for bows and arrows, and any others the leader may wish to stress. Indian medicinal herbs, natural dyes, edible roots, greens, and seeds, and how they were prepared and used are also good subjects to work into the hike.

When the group is small, it often adds to the hike to give each member an Indian name, usually referring to something they have on: green shirt, purple hat, big buttons. This works best if done by the leader, as children sometimes are apt to give certain members highly uncomplimentary names!

## Church Walk

A favorite of all special-theme walks, especially with adult groups, is the "church walk" given on Sunday morning and lasting about an hour. The theme of such a walk can be our common trees and wildflowers and their related Bible stories and legends. Animal material related to the Bible can be worked in occasionally but is more difficult because the particular animals are seldom present when wanted.

Common legends are those concerning the flowering dogwood, the Joshua tree, the Judas tree (redbud) and the sycamore. The legend of the robin's red breast is another favorite. There are also stories behind the common names of many of our wild flowers: Jacob's-ladder, Job's-tears (false Solomon's-seal), Solomon's-seal, and Aaron's-rod (common mullein).

The botanical relationship between some of our common plants and those mentioned in the Bible works in very well. Some examples of botanical relationship are the anemones of our woods and the "lilies of the field," which, according to most scholars, were really anemones; also, the relationship of the common red cedar to the cedars of Lebanon and the history of King Solomon sending 180,000 men to cut the cedars. This story can also be used to demonstrate the need of forest conservation, for the hills where once these mighty forests grew are today nearly barren desert.

A sermon on the out-of-doors and its spiritual values can be easily worked into this walk to make it a fine Sunday service to use, on occasion, in camps and other outdoor gatherings. There are many books on the animals of the Bible and several on the plants which can be obtained at any large library.

These special themes are best when worked into a regular program of nature hikes and walks to help promote interest among those who may think that nature is strictly biology and classroom stuff. Variations of these themes can make them attractive to nearly any age group depending on the leader's ingenuity. ■

## MAKE A BANJO

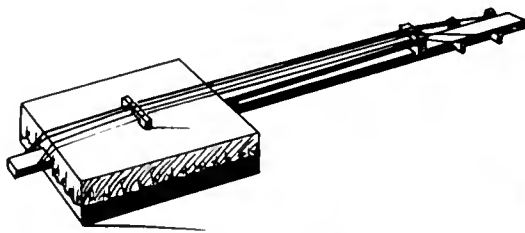

### MATERIALS NEEDED

Cigar Box - Hard Wood Pieces;  $30" \times 1" \times \frac{1}{2}"$ ,  $1\frac{1}{2}" \times \frac{3}{4}" \times \frac{1}{4}"$ ,  $20" \times 2" \times \frac{1}{4}"$ ,  $2" \times \frac{1}{2}" \times \frac{1}{4}"$ , and four pieces  $2" \times \frac{3}{4}" \times \frac{1}{4}"$  - Sheepskin and Banjo Wire Strings.

### METHOD

1. Make Box - Cigar box, sand smooth, even sides, reinforce with brads and cut out 1" sq. notch on each end.
2. Make ARM - (see diagram).
3. Make NUT - (see diagram).
4. Make FINGER BOARD - (see diagram).
5. Make FOUR PEGS - (see diagram).
6. Make BRIDGE (see diagram).

Note: Cut grooves when assembled.

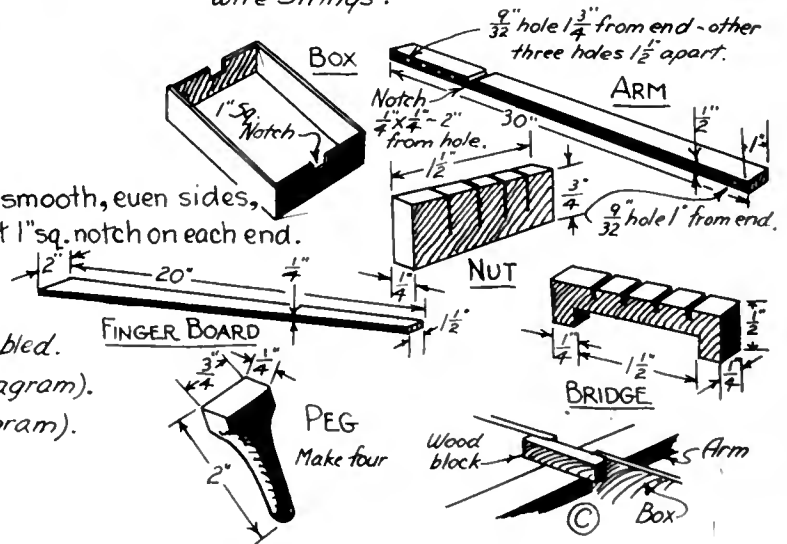

### ASSEMBLE BANJO

- A) Glue nut into notch in arm. B) Glue arm to box (bottom end projects 2" outside box). C) Reinforce joints (box and arm) by gluing piece of wood on top of arm and exactly flush with top of box edge.
- D) Check all joints and fill cracks with glue or plastic wood - when dry sandpaper. E) Put sheepskin in place - soak skin thoroughly in water, squeeze out water and stretch over top of box, tack about halfway down on all sides folding skin around arm evenly, dry skin as quickly as possible.

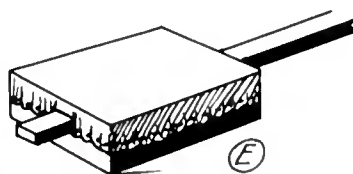

Sheepskin tacked in place

- F) Fit finger board in place between box and nut - two inch end next to box - the upper surface should be level with top of sheepskin - fit small blocks of wood against box and nut between arm and finger board.

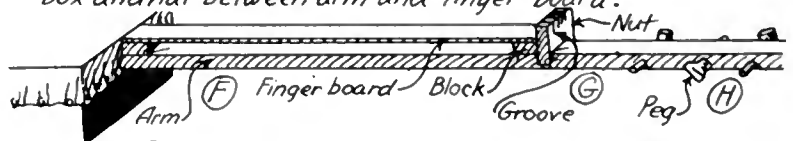

- G) Cut grooves in nut - bottom of groove exactly  $\frac{1}{16}$ " above finger board. H) Fit four pegs in holes. I) Sandpaper banjo and stain or varnish all wooden areas. J) String banjo - tie one end to hole at bottom of arm - pull string through groove in nut - tie other end of string to peg (heaviest string farthest to the left and finest string farthest to the right).

- K) Place bridge on head of banjo with strings through notches (move bridge toward or away from finger board to get best tone).

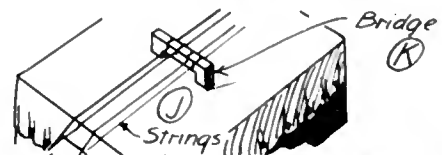

- L) Tune strings by tightening or loosening the tension of strings by turning the pegs slightly.

Beatrice H. Hill

The NRA Hospital Recreation Consultant Service has been working very closely with two new projects. One involves the Williamsport (Pennsylvania) Recreation Commission, which is trying to solve a problem for the Williamsport Technical Institute. There are over three thousand students at the institute, 399 severely handicapped. Their tuition fees are being paid by the government. This number will perhaps be tripled in 1958 because of new government grants for vocational rehabilitation training.

This institute is actually the only one of its kind in the country where such a large number of severely handicapped students are accepted. Every part of the student program is successful, except for the leisure-time after-school hours of this group. They have no place to enjoy leisure-time activities because there is no way to transport them to the many facilities the town has to offer. Thus, they either go back to their rooms and do homework in the late afternoon, go to evening adult education classes, or are limited to radio and television programs. A third possibility is to go to the neighborhood bar for sociability. Obviously, none of these three possibilities is very healthy; and the Williamsport Recreation Commission and its director, James Dittmar, called upon the National Recreation Association for help.

Together, the NRA Hospital Service and the department have set up a recreation program for the handicapped twice a week, at the YWCA. The NRA has suggested games, holiday activities, special events, movies, passive and active music, hobbies, drama, newspaper, arts and crafts, outings and so on.

At the same time, the NRA and the Williamsport Recreation Commission are considering a pilot project for such students. It is to have the community, and the state and federal governments jointly finance a large building for handicapped students—or at least a large quonset shelter—with partitioned

areas, for the many diversified facets of the recreation program. Such a building will not isolate the handicapped students from the non-handicapped ones, but will provide a place easily reached without transportation difficulties.

\* \* \* \* \*

The other one is a pilot project in Westchester County, New York, where there are thirty-five nursing homes directly under the jurisdiction of the Westchester Health Commission and the Westchester Recreation Commission. The National Recreation Association knows that there is a tremendous need for sustained recreation programs in all nursing homes. Therefore, a pilot project is being set up with seven nursing homes, by the Westchester Health and Recreation Commissions in cooperation with the NRA. These will share the salary of one recreation worker, rotating volunteers and, in some cases, equipment. The worker will have office space at the largest home, and will personally visit each once a week. Most of her time will be spent in making up lists of local entertainment or adult education sources and places where volunteers can drive patients for a day away from the home. She will be responsible for finding, training and placing volunteers, setting up recreation programs in each one of these homes. If this project works out successfully, it may prove that nursing homes and communities can cooperate to the advantage of both, recreationally speaking.

\* \* \* \* \*

"Dance in Psychotherapy" was the subject of a talk by Elizabeth Rosen,\* at a recent meeting of the New York Metropolitan Hospital Recreation Association. She said, in part:

Dance cannot be used as a panacea.

\*ELIZABETH ROSEN, Ed.D., is a certified corrective therapist and recreation therapist, and has taught modern dance and dance therapy in New York City's school system, and Teachers College, Columbia University. She will take part in the "Recreation in Rehabilitation" workshop, co-sponsored by the NRA and Columbia University, June 3-28.

All activity is important. Some patients can make more use of dance, than others. The therapist must be an active part of the treatment team for dance to be effective.

Today, art is being used diagnostically and therapeutically to help patients express their emotional problems. Creative dance may also be used in this way; but only with certain patients who can use this means of expression. Other forms of dance can also be used. Dr. Richard Kraus of Columbia University says that square and folk dancing is one of the best measures of reality testing that we have. The patient who can keep up and dance the involved figures is certainly in touch with reality.

Modern or creative dance is based on natural body movements. The body is used as the tool of the dancer. This type of dancing is easy to participate in. Anyone can swing an arm. There is a kinetic response to others moving, which is a form of communication. It opens the way for socialization and the therapist might begin to dance with one patient, include another, and slowly widen the circle.

For further information, see Mrs. Rosen's book, *Dance in Psychotherapy*, Teachers College, Columbia University, \$4.50. It may be purchased from the National Recreation Association Book Center, as can another book of interest, *Clinical Application of Recreation Therapy* by Dr. John Davis. Charles C. Thomas, publisher, \$3.75.

\* \* \* \* \*

A first annual conference, on "Recreation Club Leadership of, by and for the Handicapped," was recently conducted by the recreation and camping department of the Connecticut Society for Crippled Children and Adults. More than one hundred handicapped persons and their friends, representing special recreation groups from Connecticut and New York, attended the one-day conference to learn about improving their club operation and program.

A complete proceedings has been compiled and is available at fifty cents per copy from: Mr. Theodore Fabyan, Director of Recreation and Camping, Connecticut Society for Crippled Children and Adults, Inc., 740 Asylum Avenue, Hartford 5. ■

# The Importance of Land

**T**HE IMPORTANCE of acquiring land in advance of actual need has been pointed out by Dr. Luther H. Gulick in an article entitled, "The Coming Age of Cities," published in the December 1956 issue of *Internal Affairs*, issued by the Commonwealth of Pennsylvania. Dr. Gulick proposed a drastic new line of approach as follows:

It is now evident that metropolitan areas, to preserve the good life, will need many radial and circumferential parkways as well as areas reserved for air transport, parks, and future industrial and private residential development. Once private suburban developments have started, parkways, parks and other such projects become prohibitive in cost and damaging to existing private developers. The only way out is the immediate purchase by some public authority of extensive rights of way and tracts of suitable land, including properties outside of city boundaries, in accordance with comprehensive plans. Such lands should be held for future use, though used productively in the meantime as conditions may permit.

Such a program of advance land acquisition, supervised by a commission representative of the strongest and the ablest leaders and interests of the entire metropolitan area, will make our great cities of the future more economical, more efficient and more beautiful. Bonds issued would make an excellent outlet for the increasing volume of funds seeking long and stable investment and would rest upon assets whose values



What would we all do without the green quiet of our parks, woods and streams? We must have space to stretch the spirit!

would rise with the inevitable population gains of the metropolitan areas.

✻ The tendency of many cities to "settle" for substandard recreation areas because of expensive land costs has been strongly criticized by Professor John T. Howard of M.I.T.: "The fact that land costs twice as much per square foot in one city as in another is not a valid excuse for chiseling a 'standard,' although it may be a very real reason for not planning to meet the standard in the near future."

Professor Howard, former president of the American Institute of Planners, has also pointed out the importance of recreation areas as a factor in planning metropolitan areas "to make the residential parts of the region places for good living—not merely healthful, but convenient and pleasant."

Such a planning policy "means opportunities for recreation, of all kinds, both local and regional—the playground, and the quiet little park; the

athletic grounds, for players and for watchers; the picnic place, the boating and riding and swimming places; the woods and streams, the natural reservation big enough to get lost in. There should be enough of all of these, and so placed that everybody can get at them. And beyond the measurable requirements for specific recreational activities, natural open spaces are very much needed to break the monotony that has become so typical of our suburban sprawl, not only for visual pleasure, but to divide what would otherwise be frighteningly big urban areas into communities to which people can feel that they belong, in scale with human dimensions.

"These criteria are no more than the accepted policies for the planning of residential areas and services that have been crystallized during the last generation. I have repeated them, not because they are new, but because they are important."\*

Another noted planner, Lewis Mumford, has decried the increasing tendency toward excessive population densities as follows: "Instead of maximizing facilities for motorcars, we should maximize the advantages of urban life. Parks, playgrounds, and schools, theatres, universities, and concert halls, to say nothing of a quiet night's sleep and a sunny outlook when one wakes up, are more important than any benefits to be derived from the constant use of the automobile. To accomplish this improvement, we must devise a fundamental change in the city's whole pattern. The plain fact is that the high-density city is obsolete."

✻ Recreation and park authorities have been much more conservative than school authorities in setting up demands for neighborhood and community recreation spaces and have been less aggressive in the actual acquisition of sites for future use. The National Council for School House Construction has pointed out that experience has indicated that *ultimate* site requirements should be met with the initial site acquisition.

\*"A Planner's Philosophy for the National Capital Region." *Planning and Civic Comment*, March 1956.

✿ The favorable effect on property values resulting from the redevelopment of substandard areas in which land has been set aside for park and recreation purposes is illustrated by the experience in Pittsburgh. In a sixty-acre slum area, every building was ripped down; one-half of the area was made into a park and a housing project was built on the remaining land. A few years later, despite the fact that thirty acres had been taken off the tax rolls, the values of land in the rehabilitated district had increased \$10,500,000.

✿ At the 1957 Convention of the California Society of the American Institute of Park Executives the keynote was sounded by Dr. Robert E. Burns, president of the College of Pacific and member of the California State Park Commission. He said, "It is vital that we move now to acquire lands for tomorrow's park and recreation areas. Unless we do, highways, industries, and urban growth will swallow up the valuable sites. Our lands are a heritage and no one generation has the right to use them up."

✿ The question of preservation of open spaces was the topic for discussion at a workshop session of the American Institute of Planners. A number of questions were posed and discussed, and the following statements indicate the consensus of opinion regarding some:

1. Should public open spaces be considered as vacant lands subject to a "higher use" if one appears?  
*Answer:* Public open spaces when being used for a beneficent purpose or held for such use in the *near future*, for uses which require open out-of-door space, must not be considered as vacant land, for there can be no higher use than beneficial out-of-door activities.
2. Under what circumstances should open reservations be subject to military (and restricted) uses?  
*Answer:* Public land reservations for beneficial out-of-door activities should not be appropriated for military purposes except in a *grave* national emergency, and should be returned in its original condition within one year or less after the emergency is past.
3. Should public buildings be placed

in public parks?  
*Answer:* Only such public buildings as are *necessary* for the fulfillment of the primary purposes of parks, playgrounds, reservations should be permitted. All others should be strictly excluded and should be on their own sites, properly located for ease of public access and use.

4. Should existing public open spaces be appropriated for school buildings?  
*Answer:* See answer to Question 3. In the new design called park-schools, providing for a close cooperation between park board and school board, the school building and its accessory areas should be *added* to and not *subtracted* from any existing play park to which it will be adjacent.

5. Should expressways for multiple-type traffic be located in existing parkways or through park lands in order to save land and construction costs or to simplify engineering?  
*Answer:* This is a most serious issue facing our urban people. Admitting the grave necessity of expressways into and through urban areas, they must be located where they will be most *convenient* and effective. Cost is definitely a secondary consideration. And shifting location to save a few thousand dollars by using public park land is shortsighted and stupid. However, if parks are definitely in the line of the best location and *no other* location is possible, the park board must be liberally compensated for the loss of valuable park recreation land to enable replacement to be made where most needed. Taking such land without such compensation is reprehensible management.

6. Should reservoirs for irrigation, flood control or power where a heavy draw-down occurs in summer be placed in existing city, state or national park lands?  
*Answer:* Irrigation, flood control or power reservoirs where a heavy draw-down occurs should not be located in existing or planned park lands, unless a grave danger exists from floods, from drought, and if no other feasible site can be found. Power reservoirs can be permitted only if a power shortage is present in the community with no other source available, and this only if a draw-down of not more than two feet is

allowed. In primitive or natural scenic parks, of state or national governments, none of the above can be permitted. Only artificial lakes for recreation use maintained at constant level are permissible in state, county and city landscape parks.

7. Should so-called port or navigation districts take over lake or harbor fronts in public park lands where private frontage is available without replacing for public use an equal amount of lake frontage within the metropolitan area?  
*Answer:* No.

8. Should military or veterans' hospitals be considered a higher use than open space parks?  
*Answer:* No—both are important for safety, health, and welfare, but a hospital should be in its own specially adapted site, which may overlook, but not be in, public-use park land.

9. Should public agencies acquire open spaces in advance of needs in ostensibly growing areas?  
*Answer:* Yes—definitely. But only in conformity with a definite, well-considered plan for recreation areas and among all levels of government, so that the citizens and the courts, if necessary, understood fully the necessity of this advance acquisition. Requiring all new subdivisions to allocate five to eight per cent of land for park purposes is not workable unless the urban authorities can accept cash or lands to increase ownership where needed. ■

## monroe

### FOLDING BANQUET TABLES



If you are on the Board of your Church, Lodge, Club, School, etc., you will be interested in this modern Folding Banquet Table.

AND MONROE TRUCKS

Completely finished tops, resistant to most serving hazards. Used with or without table cloths.

Write for Table and Truck Catalog and special price discounts to institutions and organizations.

Monroe Co., 181 Church St., Colfax, Ia.

# Park Acreage to Population

## 1930-1955

Prepared by the Research Department,  
National Recreation Association.

**H**IGHWAYS, schools, shopping centers and many other forms of development are competing for space in and around almost every city in the country. Some public officials appear to think that the solution to the problem is to be found in the broad expanses of our public parks. In city after city, attempts are being made to encroach upon park and recreation areas. In view of the fact that a majority of cities fall far short of meeting any reasonable standard of park and recreation space, these proposals represent a serious threat to municipal welfare and accentuate the inadequacy of available recreation opportunities.

The 1956 *Recreation and Park Yearbook*\* provides information as to the extent of park areas in American cities. A comparison of the park acreage reported by cities in 1955 with that reported in earlier park studies affords an indication of the degree to which the acquisition of municipal parks by American cities is keeping pace with their population increase. Comparable studies of municipal park acreage were conducted by the National Recreation Association in 1930, 1940 and 1950. The data in this statement covers 189 cities of 10,000 population or over for which consistent and apparently accurate park acreage figures are available for the years 1930, 1940, 1950, and 1955.

This data is expressed in terms of park acreage per capita or the number of persons per acre of park property. The more people there are per acre, the less adequate is the provision of park area. In studying the tables that follow it must be kept in mind that the figures for municipal park acreage include properties both inside and outside

city limits. Some of the cities covered have large out-of-city park holdings. Since the widely accepted standard of one acre of park per one hundred people applies only to areas within the city limits, it is evident that many of the cities studied are less adequately provided with urban parks than the figures would seem to indicate.

Table I shows the park acreage per capita for the selected years over the twenty-five-year period. It indicates a considerable improvement between 1930 and 1940. In 1930 less than one city in four met the standard of one acre of park per one hundred people; more than one out of five had less than one-fifth the standard acreage. Ten years later five more cities had achieved the standard and only one in seven fell below one-fifth of the standard acreage. This gain was more apparent than real, however, for in the decade 1930 to 1940 the out-of-city park acreage in the United States increased by sixty-eight per cent and a number of the cities in this study acquired such out-of-city areas.

Little change in the picture occurred between 1940 and 1950 although a few cities gained more park acreage than population, percentage-wise. This was counterbalanced by a relative loss in several cities between 1950 and 1955. For example, the same number of cities (forty-nine or twenty-six per cent of the group) had at least one acre of park per one hundred population in 1955 as in 1940; one hundred and fourteen cities, or sixty per cent of the total, had at least one-half the standard acreage in each of these years. The only consistent advance throughout the quarter-century was the decreasing number of cities with less than one-tenth of the standard park acreage—a fact that offers little basis for boasting.

Table II illustrates the extent to which cities in various population

**TABLE I**  
**RATIO OF PARK ACREAGE TO POPULATION,**  
**1930, 1940, 1950, 1955**

| Number of Persons<br>per One Acre of<br>Park Property | Number of Cities |      |      |      |
|-------------------------------------------------------|------------------|------|------|------|
|                                                       | 1930             | 1940 | 1950 | 1955 |
| Under 50                                              | 14               | 16   | 13   | 14   |
| 50 - 100                                              | 30               | 33   | 40   | 35   |
| 100 - 200                                             | 54               | 65   | 62   | 65   |
| 200 - 500                                             | 52               | 48   | 51   | 51   |
| 500 - 1,000                                           | 17               | 12   | 11   | 15   |
| Over 1,000                                            | 22               | 15   | 12   | 9    |

groups attained various ratios between park acreage and population in each of the four years covered by the study. It therefore provides a supplement to Table I and additional information as to trends in the acquisition of park area.

The table indicates that several cities in the 10,000 to 25,000 group made relative gains in park acreage between 1930 and 1955, although there was a slight loss between 1950 and 1955. This is the only population group in which the number of cities meeting the standard is less than the number that have less than one-fifth the standard acreage. Obviously a large percentage of the total group still lack park property.

The 25,000 to 50,000 group made slight gains between 1930 and 1955, but less than one-sixth met the standard. Gains are also reported in several cities of 50,000 to 100,000; thirty-seven per cent of them met the space standard but the number doing so is less than in 1930. Little change is noted in the cities of 100,000 to 200,000; whereas a slight slump is noted in recent years in cities of 200,000 to 500,000. No city over 500,000 meets the standard and only one has half of the normal park acreage. With one exception the status is comparable to that of 1930.

\*Available from the National Recreation Association, 8 West Eighth Street, New York 11. \$2.00.



**TABLE II**  
**NUMBER OF CITIES WITH VARIOUS PARK ACREAGE PER CAPITA, 1930, 1940, 1950, 1955, BY POPULATION GROUPS**

| Population Group                 | Number of Persons per Acre of Park | Number of Cities |      |      |      | Population Group                 | Number of Persons per Acre of Park | Number of Cities |      |      |      |
|----------------------------------|------------------------------------|------------------|------|------|------|----------------------------------|------------------------------------|------------------|------|------|------|
|                                  |                                    | 1930             | 1940 | 1950 | 1955 |                                  |                                    | 1930             | 1940 | 1950 | 1955 |
| 10,000 - 25,000<br>(53 Cities)   | Under 100                          | 11               | 9    | 13   | 13   | 200,000 - 500,000<br>(19 Cities) | Under 100                          | 5                | 6    | 6    | 5    |
|                                  | 100 - 200                          | 5                | 15   | 10   | 9    |                                  | 100 - 200                          | 12               | 10   | 11   | 9    |
|                                  | 200 - 500                          | 14               | 11   | 16   | 16   |                                  | 200 - 500                          | 2                | 3    | 2    | 5    |
|                                  | 500 & over                         | 23               | 18   | 14   | 15   |                                  | 500 & over                         | 0                | 0    | 0    | 0    |
| 25,000 - 50,000<br>(45 Cities)   | Under 100                          | 5                | 6    | 7    | 7    | Over 500,000<br>(7 Cities)       | Under 100                          | 0                | 0    | 0    | 0    |
|                                  | 100 - 200                          | 14               | 13   | 13   | 14   |                                  | 100 - 200                          | 0                | 0    | 2    | 1    |
|                                  | 200 - 500                          | 10               | 13   | 12   | 11   |                                  | 200 - 500                          | 6                | 7    | 4    | 5    |
|                                  | 500 & over                         | 6                | 3    | 3    | 3    |                                  | 500 & over                         | 1                | 0    | 1    | 1    |
| 50,000 - 100,000<br>(35 Cities)  | Under 100                          | 14               | 18   | 17   | 13   | All Cities (189)                 | Under 100                          | 44               | 49   | 53   | 49   |
|                                  | 100 - 200                          | 12               | 15   | 15   | 21   |                                  | 100 - 200                          | 54               | 65   | 62   | 65   |
|                                  | 200 - 500                          | 13               | 8    | 11   | 8    |                                  | 200 - 500                          | 52               | 48   | 51   | 51   |
|                                  | 500 & over                         | 6                | 4    | 2    | 3    |                                  | 500 & over                         | 39               | 27   | 23   | 24   |
| 100,000 - 200,000<br>(30 Cities) | Under 100                          | 9                | 10   | 10   | 11   |                                  |                                    |                  |      |      |      |
|                                  | 100 - 200                          | 11               | 12   | 11   | 11   |                                  |                                    |                  |      |      |      |
|                                  | 200 - 500                          | 7                | 6    | 6    | 6    |                                  |                                    |                  |      |      |      |
|                                  | 500 & over                         | 3                | 2    | 3    | 2    |                                  |                                    |                  |      |      |      |

Table III shows the change in the ratio of park acreage to population between 1930 and 1955, in cities of various sizes. All the groups of cities studied increased their park acreage ratio this period with the exception of those in the 200,000-500,000 bracket, in which only thirty-two per cent of the cities succeeded in acquiring proportionally more park acreage than they gained in population. The greatest improvement appears to have been in the largest cities, but the sampling in this bracket was too small to be truly indicative. The smallest cities ranked sec-

ond, with a decreased ratio in sixty-two per cent of the fifty-three cities studied.

In the over-all picture, fifty-six per cent of the cities studied improved their park acreage ratio between 1930 and 1955. When we recall that less than one-fourth of the cities met the standard in 1930, and consider the growing appreciation of the importance of recreation and the increase of leisure in the last quarter century, the advance is far less than might have been expected. The fact that nearly one-half of the cities failed to improve their park situation during the period indicates that the

picture is far from encouraging.

**TABLE III**  
**CHANGE IN RATIO OF PARK ACREAGE TO POPULATION, 1930 - 1955**

| Population Group<br>(As of 1930) | Number of Cities | Number of Cities in which Park Acreage per Capita |           |
|----------------------------------|------------------|---------------------------------------------------|-----------|
|                                  |                  | Decreased                                         | Increased |
| 10,000 - 25,000                  | 53               | 20                                                | 33        |
| 25,000 - 50,000                  | 35               | 15                                                | 20        |
| 50,000 - 100,000                 | 45               | 19                                                | 26        |
| 100,000 - 200,000                | 30               | 14                                                | 16        |
| 200,000 - 500,000                | 19               | 13                                                | 6         |
| Over 500,000                     | 7                | 2                                                 | 5         |
| Total                            | 189              | 83                                                | 106       |

Table IV shows the change in ratio of park acreage to population in each of the three periods studied. It clearly indicates that the great acquisitions of property came, in general, between 1930 and 1940, when there was a nation-wide tendency to acquire out-of-city parks. During these ten years, sixty-four per cent of the cities improved their ratio; eighty per cent of those in the 100,000-200,000 bracket did so, and only the cities in the 200,000-500,000 group lost ground.

Between 1940 and 1950, fifty-seven per cent of the cities either lost acreage or gained so greatly in population that they failed to acquire sufficient park acreage to compensate. The groups between 50,000 and 200,000 suffered the greatest downgrade.

The trend toward less park acreage

per capita was even more marked in the period between 1950 and 1955; only three out of eight cities improved their park status. This confirms the statement in the 1956 *Recreation and Park*

*Yearbook* that less than forty-two per cent of the 1,907 cities reporting park and recreation areas increased their park holdings between 1951 and 1955 inclusive, although practically all of

**TABLE IV**  
**CHANGE IN RATIO OF PARK ACREAGE TO POPULATION, 1930 - 1940, 1940 - 1950, 1950 - 1955**

| Population Group<br>(As of 1930) | Number of Cities | 1930 - 1940                                       |                |            | 1940 - 1950                                       |                |            | 1950 - 1955                                       |                |            |
|----------------------------------|------------------|---------------------------------------------------|----------------|------------|---------------------------------------------------|----------------|------------|---------------------------------------------------|----------------|------------|
|                                  |                  | Number of Cities in which Park Acreage per Capita |                |            | Number of Cities in which Park Acreage per Capita |                |            | Number of Cities in which Park Acreage per Capita |                |            |
|                                  |                  | De-creased                                        | Did Not Change | In-creased | De-creased                                        | Did Not Change | In-creased | De-creased                                        | Did Not Change | In-creased |
| 10,000 - 25,000                  | 53               | 19                                                | -              | 34         | 27                                                | 1              | 25         | 33                                                | 1              | 19         |
| 25,000 - 50,000                  | 35               | 15                                                | 1              | 19         | 17                                                | -              | 18         | 20                                                | -              | 15         |
| 50,000 - 100,000                 | 45               | 13                                                | 1              | 31         | 28                                                | 1              | 16         | 26                                                | 4              | 15         |
| 100,000 - 200,000                | 30               | 5                                                 | 1              | 24         | 21                                                | -              | 9          | 14                                                | 3              | 13         |
| 200,000 - 500,000                | 19               | 12                                                | -              | 7          | 12                                                | -              | 7          | 13                                                | -              | 6          |
| Over 500,000                     | 7                | 1                                                 | -              | 6          | 3                                                 | -              | 4          | 4                                                 | -              | 3          |
| Total                            | 189              | 65                                                | 3              | 121        | 108                                               | 2              | 79         | 110                                               | 8              | 71         |

these cities increased in population. A number of the cities reported actually less park acreage than in 1950.

\* \* \* \*

To summarize briefly, while the present per capita acreage is lower than in 1930, this is primarily because of the great gains between 1930 and 1940. Since 1940, the growth in park acreage has failed to keep pace with population gains, and the loss was greater between 1950 and 1955 than in the preceding decade. Only one city in four meets the

standard of one acre per hundred population; the percentage would be even smaller if out-of-city parks were excluded. The picture is therefore far from satisfactory.

Many of the finest municipal park systems in this country were largely acquired during the first two or three decades of this century, as a result of the action of farsighted civic leaders and city authorities. These lands were dedicated as parks in a period when leisure was far less abundant than it is today, when cities were much less con-

gested and when the importance of space for recreation was less widely recognized or urgently needed. The people of America are enjoying the benefits resulting from the courage and wisdom of their fathers.

The least that people in this period of unprecedented prosperity can do is to preserve and protect the areas set aside for parks in the past. Unless it does more, and acquires much additional park acreage, recreation opportunities will be infinitely less adequate in years ahead than they are today. ■

---

## NOTES *for the Administrator*

●

### *Dedication of land for park use, including recent court decisions.*

The legal status of public park and recreation lands and the right of authorities to dispose of them or to use them for non-conforming purposes vary from state to state. They also differ depending upon the method by which they are acquired by the city. As suggested elsewhere in this issue, it is highly important that park and recreation agencies become familiar with the legislation and court decisions relating to the status of park and recreation areas in their city. The following cases\* illustrate the diversity of opinion on this subject.

**PARK-DEDICATED PROPERTY CANNOT BE SOLD TO PRIVATE CORPORATION:** Where property has been dedicated by city to public use as a park and such use has been continuous for more than forty years, the city could not declare park abandoned and sell property to private corporation even though proceeds of sale were earmarked for development of other recreational areas. *City Council of Augusta versus Newsome* (89 S.E. 2d 485 Georgia, October 13, 1955).

**RIGHT TO LEASE PARK FOR UNDERGROUND PARKING DENIED:** An ordinance making a lease between San Antonio, Texas, and an individual for the purpose of developing an underground parking area below Travis Square was declared "invalid, null and void and of no force and effect whatsoever." In handing down this decision, the judge also held that "though the City holds the title to Travis Park in fee simple, in its proprietary capacity, yet said park has been used

as a public square or a public park for over one hundred years, and has thereby been dedicated (by public use) to the public as a city park. . . . Having permitted Travis Square to become dedicated to the public for use as a public park as hereinabove stated, and since the public is still using said park as a city park, though the city acquired fee simple title thereto in its proprietary capacity, this title is now subject to the rights of the public accruing by reason of the dedication, and cannot be diverted to an inconsistent use. . . . For reasons above stated the Court holds that the City Ordinance and lease agreement in question are invalid."

**CITY PROPERTY ACQUIRED UNDER SPECIAL STATUTE FOR PARK AND HOSPITAL USE CANNOT BE SOLD:** Taxpayer could not enjoin sale of surplus property acquired by city under statute providing for acquisition of land for hospital and park purposes only. *Aldrich versus City of New York*, 145 N.Y.S. 2d 732 (Sup. Ct., Sp. Term, Queens County, October 25, 1955)

**EXTENSION OF RESTAURANT PARKING LOT IN PARK DENIED:** In handing down a decision in the case involving a suit to restrain conversion of land in Central Park for a parking lot to serve patrons of a restaurant in the park, the court stated: "No foot or even inch of park space is expendable in our teeming metropolis. . . . It is a sufficiently grave question whether a half-acre of park land, shrubbery and trees—used by older children, and immediately adjacent to a more formal playground for youngsters—may be sacrificed to a contemplated use of compounded dubiety, for example more parking space (for eighty or more cars), for an enlarged cocktail lounge of a plush restaurant."

**CITY PROPERTY CANNOT BE CONVEYED TO CHARITABLE INSTITUTIONS WITHOUT PROPER CONSIDERATION:** In view of the increasing requests on the part of private agencies for the transfer, lease or sale at a nominal fee of public property this decision is significant. The court held that the City had no power to convey to a private charitable foundation property which city owned in governmental capacity and which

\* A number of the cases were reported in *The American City* magazine.

was concededly worth thirty-two times the monetary consideration to be received. *Gritton versus City of Des Moines*, 73 N.W. 2d 813 (Iowa, December 13, 1955).

**AUTHORITY TO DISPOSE OF RECREATION AND PARK PROPERTY:** A tendency is apparent in some recent court decisions to hold that a city has the authority to dispose of property designated for park purposes in the absence of specific deeds of conveyance or other constricting factor. The board of trustees of Village of Babylon had authority to sell property allegedly restricted for park purposes and neither deed of conveyance nor judgment registering title restricted or conditioned its use to park purposes. *O'Shea versus Hanse*, 147 N.Y.S. 2d 792 (Sup. Ct. Sp. Term Suffolk County, November 16, 1955).

In answer to a question as to the authority of a village council to dispose of one-third of a property that was purchased for a park site and recreation area but all of which was not considered necessary for this purpose, the legal counsel of the Wisconsin League of Municipalities offered the following opinion: "I believe that our court would hold that where a municipality has originally purchased property for a public purpose, it could sell that property to the municipality's best advantage when the public purpose was abandoned.

"There are no statutory limitations on the right of a municipality to sell property which it has acquired by purchase. The village, therefore, is free to sell the property in question at the best price which it can obtain and is entitled to apply the proceeds to any lawful municipal purpose."

### Effective Acquisition Plans

A successful way of acquiring park lands for rapidly growing suburban areas has been developed by the Maryland and National Capital Park and Planning Commission. Its land reservation program requires subdividers to set aside park or other lands for later acquisition by the commission, prohibits construction on the land, forgives taxation of the property during the reservation period, and then lets the property revert to the subdivider if it hasn't been purchased within a given time. The reservation period is limited to three years.

Although the program does not obviate the need for purchasing properties for park or other public purposes in rapidly growing areas, it does give a breathing period of up to three years in which purchasing schedules can be developed and carried out.

The Midland, Michigan, Planning Department has taken steps to assure satisfactory residential park and school site developments in the undeveloped land within its annexed area. A recent report indicated that the department had prepared preliminary plans for eight square miles of such an area. Each square mile is proposed to be a neighborhood with a fifteen-acre school site centrally located, parks totaling ten per cent of the gross area, one or two neighborhood shopping areas, and about 1,000 to 1,200 residential lots.

### Potential Threat to Park and Recreation Lands

A tendency in some government circles to treat park and recreation lands not as permanently dedicated as open space, but rather as available for any desirable public purpose affords a potential threat, the importance of which cannot be ignored. For example, in addressing the Institute of Government at the University of Washington last summer, Dr. Ernest H. Campbell of the university's bureau of governmental research and services stated, "Experience indicates that, whenever possible, it is desirable for cities and other political subdivisions to avoid acceptance of land dedicated for 'park purposes only,' since best and highest use of the land in the future may not be for parks and recreation. Also, when conveyed with such restrictive covenant or dedicated solely for a public park, such a restriction on use of the land usually may be released only with consent of dedicatory by execution of a quitclaim deed by the grantor, if he is still living, releasing the restriction; or by a specific legislative act releasing it, or sometimes by a bona fide abandonment of the land.

"Also, keep in mind that if a city acquires land for public park purposes with city general funds, the city may sell for an entirely different use if the deed by which the land was conveyed to the city does not contain a restriction that it may be used only for park purposes. Also, if a city has acquired property for public park and payment is by special assessments levied upon the neighboring property specially benefited by reason of acquisition and use of the property for such purposes, the owners thus assessed may, in a proper case, prevent the property from being used in a manner that would destroy its use and enjoyment for the purposes for which it was acquired." ■

ADMINISTRATION

**ENGRAVING FREE!**  
**On All Trophies Purchased From**

*National*

**SAVINGS OF**  
**20% to 40%**

**TROPHIES - MEDALS - PLAQUES**

**FREE CATALOG**

*National* **TROPHY SALES, INC.**

75 W. Van Buren St. Dept. C-5 Chicago, Illinois



**SUBSCRIPTION RATES**

Subscription rates for RECREATION magazine are:

|                                                   |        |                   |        |
|---------------------------------------------------|--------|-------------------|--------|
| 1 year . . . . .                                  | \$4.00 | Library           |        |
| 2 years . . . . .                                 | 7.25   | subscriptions . . | 3.70   |
| Foreign . . . . .                                 | \$4.50 |                   |        |
| Club subscriptions . . . . .                      |        |                   | \$3.50 |
| (Ten or more individuals subscribing at one time) |        |                   |        |
| Single issues . . . . .                           |        |                   | .50    |

**NATIONAL RECREATION ASSOCIATION, 8 W. Eighth St., New York 11, N. Y.**

# Court Decisions



**C**COURT DECISIONS resulting from accidents occurring in municipally-owned swimming pools have been handed down in many states. The nature of the decision varies not only with the circumstances surrounding the accidents, but also with the attitude of the court as to the nature of the function performed. The following brief comments with reference to several court cases serve as illustration:

In an address before the Kansas Beach and Pool Conference, sponsored by the University of Kansas, Albert B. Martin, director of research of The League of Kansas Municipalities, cited the following decisions:

In the case of *Gilliland versus City of Topeka and J. Torsney, 124 Kansas, 726 (1928)*, a privately operated swimming pool, with sloping bottom and equipped with a diving platform, springboards, bathhouse and other accessories, was located in a city park. No lifeguard was on duty. A six-year-old child was drowned while attending a Sunday school picnic. The parents sued the city and the pool operator but lost. It was held that:

A swimming pool in a public park of a city, constructed of concrete and equipped with the usual swimming pool accessories, is not a nuisance, although attractive to children.

In *Sroufe versus Garden City, 148 Kansas, 374* a swimming pool was being repaired. The grating was left off a drain and the pool was being used without a lifeguard on duty. A fourteen-year-old boy apparently was caught in the suction of the drain and held under water until he drowned. It was held that the city was engaged in a government function, the pool was not an attractive nuisance, and the city was not liable.

The court came to a different conclusion as to a lease agreement in *Shoemaker versus City of Parsons, 154 Kansas, 378 (1941)*. Here the city provided water, electric current and chemicals and received fifty per cent of the gross receipts. A man broke his neck diving into the pool. The city and the lessees were sued. The court held for the city but against the lessees on the ground that under the agreement they were independent contractors and not agents of the city as in the other cases. The court said that the agreement was along the idea of the Swan case below. The question was not raised as to the validity of the lease. This case and the others show that the terms of the agreement can be important to the party entering into an agreement with the city.

An earlier case presented a different problem. *Swan versus Riverside Bathing Beach Company, 128 Kansas, 230 (1929)*. Here the city of Independence entered into an agreement with the Riverside Bathing Company whereby the company was permitted to build and operate a swimming pool in a city park. The city leased the necessary land to the com-

pany. A nine-year-old girl was killed at the pool and the parents sued the company. The company defended upon the ground that the pool was a government function of the city and as the city was immune the company was immune. The court said not:

The immunity of a city from liability for negligence in the performance of its governmental functions is not imputed to one who, under the contract referred to in the opinion, constructs and operates for profit a swimming pool on land leased from the city, so as to relieve him from liability for his own negligence.

The company was not held an employee of the city.

The question whether the lease was valid was not raised and probably it would have made no difference in this case.

It would appear that the holdings relating to swimming pools and ponds or lakes in city parks would apply to lakes in county and township parks. A number of counties have parks in which there are lakes but it appears there have been no decisions because of injuries or deaths occurring at such lakes. It is certain such lakes are not attractive nuisances; they are attractive but they are not nuisances and it would appear that government immunity would attach to the counties and townships.

The Tennessee State Planning Commission, in a bulletin citing a number of court decisions relating to municipal liability for accidents, listed the case of *Vaughn versus City of Alcoa, 251 S.W. (2d) 304 (Tennessee, 1952)*. A lifeguard at a city-owned and -operated pool negligently allowed a nine-year-old child who was using the pool as a paying customer to drown. The city invited both residents and non-residents of the city to use the pool and realized a profit from the operations.

The plaintiff alleged that the city in operating the pool was acting in a proprietary capacity and thus was liable. He also alleged that the city was liable because of the *last clear chance* doctrine which is based upon the theory that the defendant is negligent in not extricating the plaintiff from his place of danger after it is discovered, notwithstanding the fact that the plaintiff was guilty of contributory negligence in placing himself in danger. It was also stated that maintenance of the pool was an attractive nuisance and that, because it created and maintained a nuisance, the city was liable.

The decision stated in part:

In this State a municipality is liable in damages for torts to its citizens only if it was negligent in the operation of one of its proprietary functions as distinguished from its governmental functions or if it created or maintained a nuisance in the performance of one of its governmental functions.

... Public parks, playgrounds, swimming pools and public golf courses are all examples of municipal functions undertaken for the public benefit, and are under our decisions conducted by the City in its governmental capacity as distinguished from its proprietary capacity.

# Affecting Swimming Pools

In commenting on the effect of the charging of a fee the court held:

The manner in which the details of the business of paying for the right to operate the pool is managed is not the controlling element.

As for the *last clear chance* doctrine, it held that:

It can have no application in this case because liability of the City is denied on the ground that the City cannot be held for negligence of its officers in the operation of a governmental function.

The court further held that the attractive nuisance doctrine does not hold in the case, since courts have held it "not applicable to injuries incurred in public parks, because trespass is the basic requirement of an attractive nuisance and since those using the swimming pool or park were not induced there by the attractive condition of the thing." It was therefore held that the city was not creating or maintaining a nuisance in the pool.

Different conditions and a different decision was reached in the case of *Williams versus Town of Morristown, et. al. 222 S.W. (2d) 607 (Tennessee, 1949)*. The court held that "Where Town permitted people to use area surrounding reservoir of Town's water works system for picnic purposes, area was not 'public park' and when nine-year-old girl drowned in reservoir, Town could not escape liability on ground that she lost her life in public park operated by Town in its governmental capacity." The decision stated:

The operation of an electrical power system or a water works system is a corporate or private function of a municipality.

If a municipal enterprise is operated for profit it is a proprietary undertaking, but it does not follow necessarily that it is a governmental undertaking if it is not operated for profit.

Where person injured by dangerous condition is a child of tender years, land owner will be liable for injuries (negligence) sustained by her although child is trespasser if condition was such that it constituted an attractive nuisance to the child.

Where area surrounding pool in town water system had been frequented for many years by children attending picnics, and danger in pool was exceptional due to deceptive depth because of clear water, and treacherous because of sloping floor, and walls, and slick moss on them and there were no warning signs, guards or fences around, pool constituted attractive nuisance and town was liable for death of child who drowned in pool, even though child was trespasser.

The Wisconsin Park and Recreation Society *News Bulletin* records the case of *Virovatz versus Cudahy (1933)*, 211 *Wisconsin* 357. The case involved a child who was drowned while bathing in a natural pool or pond in a municipal park. It was alleged that the pool was an unfit and unsafe place for swimming and bathing; that it was a nuisance and immediately dangerous to the life and health of those who swam therein for the reason that the bottom of the pool was rolling and was of uneven depth and contour, contained large step-offs and was composed of thick and heavy mud.

The court held that a municipality while engaged in operating and maintaining a public swimming pool is performing a government function and will not be liable for the negligence of its agents, employees or officers. As long as the village does not operate a swimming pool for its pecuniary advantage, it would be operating in a government capacity. However, if someone is injured or killed because of a defect in construction of the pool itself or the bathhouse or other structures used in connection with use of the pool, a possibility of liability exists under the safe place statute.

In the Cudahy case, because the pool was a natural pond involving no construction, the court assumed that the safe place statute would require that it be maintained in a safe condition.

In *Feirn versus Shorewood Hills (1948)*, 253 *Wisconsin* 418, 34 *N.W. (2d)* 107, a girl slipped and was injured on a swimming pier consisting of a board walk and a board platform supported by wooden posts, with a wooden bench, diving board and observation tower. It was alleged that the village was negligent in failing to treat the wood platform to prevent it from becoming water-soaked and slippery and in failing to provide a suitable material to cover the slippery surface.

The court said that in view of the nature and manner of construction, and the village's use of the pier and platform as a place of public resort and occupancy, it was clearly a structure and a public building within the safe place statute. Thus the village was held liable for negligence for failing to keep the pier and platform in safe condition.

According to *Public Works*, October 1956, the case of *Orrison versus City of Rapid City, South Dakota*, 74 *N.W. (2d)* 489, was an action by a patron of a municipal swimming pool for injuries sustained when she stepped on a broken bottle in the dressing room.

The jury gave her a verdict of \$1,000, and the city appealed. Among other things, it was claimed that Rapid City, as a city, was immune from suit.

The holding of the appellate court, however, was that even though the Rapid City might be a city, it still did not have the immunity of a city, because the operation of a swimming pool is a proprietary function rather than a government function. This was so even though the city offered to prove that it was losing money on the operation of the swimming pool. Since it was found by the jury that the city had been negligent in its operation of the dressing room, the city was liable.

The above is a good example of the rapidly changing picture of municipally operated recreation facilities from government to proprietary function and its resultant liability. ■

# P E R S O N N E L

## SECOND NATIONAL INSTITUTE FOR RECREATION EXECUTIVES

W. C. Sutherland

The Second National Institute in Recreation Administration will be held at the National Recreation Congress in Long Beach, California, October 2-3, 1957. This year the theme is "Organizational Teamwork and Creative Leadership." The faculty will be specialists in leadership and personnel development from leading corporations who will serve as resource persons and special instructors.

There will be demonstrations of new methods of creativity in organizational operations. Methods in dealing with specific problems will be demonstrated. Special attention will be given to:

- Integrating and motivating for effective performance.
- Administrative experience and lessons from outstanding executives in recreation and other fields.
- Development of creative leadership.
- Solution of specific problems—problem clinic for application and testing principles discussed.
- Demonstration of new methods of creativity in organizational and administrative teamwork.

The Institute has been carefully designed to include twelve clock-hours in order to meet college and university requirements. Those interested in having academic credit may do so. Candidates themselves will be responsible for negotiating personally with the institution of their choice.

The Institute's fitting location is the Long Beach Municipal Recreation Center. This interesting and attractive facility is near the sea, just a stone's throw from Congress headquarters and all activities. Although the location is in the heart and center of all Congress affairs the center will be reserved exclusively

MR. SUTHERLAND is the director of the NRA Recreation Personnel Service.

for the Institute, and will provide complete privacy.

Registration and enrollment will be limited to one hundred executives based on regional quotas. Applications will be accepted in the order they are received, with careful consideration given to geographical balance and representation. Special certificates designed by an artist from the Long Beach Recreation Department will be presented to those attending the Institute.

The twelve-dollar registration fee includes a kit of materials especially prepared for the Institute. This will have documents on the administrative pattern of Long Beach dealing with the "Acquisition and Financing of Facilities," "School-Community Relationships," "Program Evaluation," "Creativity Techniques in Administration," and possibly some of the material on recreation now being developed for the Annals of the American Academy of Political and Social Science.

The Institute Committee is as follows: Dr. Paul F. Douglass, Washington, D.C., coordinator; Robert W. Crawford, Philadelphia, chairman; John L. Hutchinson, Columbia University; Raymond T. Forsberg, Waterloo, Iowa; Howard Holman, Fresno, California; Raymond Kimbell, San Francisco; Norman Johnson and William Frederickson, Jr., Los Angeles; Frank Harnett, Long Beach, California; and W. C. Sutherland, NRA, secretary.

Every effort is being made to make this an outstanding experience for those executives interested in personal growth and further professional development and preparation. Last year many recreation commissions and managing authorities encouraged their executives to attend and paid the Institute fee. It is believed that most of the executives attending this year will again have their

registration fees paid for by their respective departments. This is an unusual opportunity since those planning to attend the Congress anyway will not have additional travel and living expenses. The intensive period of training at the Institute will be supplemented by special Congress sessions dealing with personnel and administrative problems.

Recreation executives from thirty-four states and six foreign countries attended the Institute last year. Those desiring to attend this year should secure application and registration forms promptly by writing to the Admissions Committee, National Recreation Association, 8 West Eighth Street, New York 11. ■

*Had You and Prior  
Ever Met . . .*

*What Lovely Prizes  
You Would Get  
Records, Agreed, Aren't  
Easily Set,  
But Their's The Best  
Record Yet!*

The heavenly priced, gold-plated trophies you select are moulded of finest art metal and can be mounted on bases of your choice . . . genuine onyx, or the Italian marble . . . beautiful as the marble in Villa d'Este. Send for your FREE 40-Page Catalog today.

**PRIOR**  
*jewelry and award co.*

220 Fifth Ave., N. Y.

MORE THAN

100,000

U. S. SCHOOLS AND COLLEGES EACH YEAR SPECIFY

America's Finest Sports Equipment by

VOIT®

NEW YORK 11

DANVILLE, ILL. · LOS ANGELES 11

for every

RECREATION  
ACTIVITY

HI-FI

sound  
at low cost

R-16CV



NEWCOMB

- transcription player
- public address system

For every sound reproduction application in recreation halls, gyms, auditoriums, or summer camps, the Newcomb R-16CV does the job better, yet weighs less than 22 pounds. A separate microphone and phonograph volume control permits mixing recorded music with the microphone presentation. *Variable speed control* allows variable tempo and pitch (from any basic speed setting). A quality heat and humidity resistant high fidelity ceramic pickup is encased in a professional-type tone arm. Balanced-design amplifier with inverse feedback in combination with a fine ten-inch extended range speaker give quality you'd never expect at its price. Newcomb is the "sound of quality since 1937"... recognized by leading school authorities from coast to coast.



NEWCOMB VARIABLE SPEED

Exclusive Newcomb design gives dependable continuously variable control at all 3 speeds.

FREE CATALOG

NEWCOMB

Audio Products Co., Dept. Z-6  
6824 Lexington Av., Hollywood 38, Calif.

- Send free catalog of Newcomb portable sound equipment.
- Send name of our nearest Newcomb distributor.

Name \_\_\_\_\_  
Address \_\_\_\_\_  
City \_\_\_\_\_

RONALD Books for Camping Fun . . .

CAMPING

ARTHUR H. DESGREY. Shows how to make life out of doors comfortable, zestful, and safe. Reliable guidance on preparations, water supply, protection, desirable camp sites, sanitation, camp pests, first aid, cooking, etc. 53 photographs. \$3

CANOE CAMPING

CARLE WALKER HANDEL. How to plan a canoe camping trip filled with a maximum of excitement and good fun. Gives an expert's tips on food, equipment, packing and portaging, etc. A special chapter on the outfits needed by the fly or bait fisherman and the hunter. 167 drawings. \$3

The Junior Book of CAMPING and WOODCRAFT

BERNARD S. MASON. For the young outdoorsman who wants to learn the way of the woods. Teaches by word and picture the handling of jack-knife, ax, and saw; making camp beds; pitching tents; choosing the right wood and laying a fire; etc. 315 photos, sketches. 8½ x 11. \$3.50

The Book of INDIAN-CRAFTS and COSTUMES

Also by MASON. A beautifully illustrated study of the American Indian emphasizing his crafts and customs. Detailed instructions for making reproductions of war-bonnets, ceremonial garments, and equipment. 620 photos, drawings. 8¾ x 10¾. \$5

Dances and Stories of the American Indian

MASON. Preserving the American Indians' dances, this book includes 68 authentic examples and the fascinating stories behind them. Fully illustrates basic steps, costuming, and properties essential to recapturing the Indian ritual and routine. 140 ills., 3 musical scores. 7 x 10. \$5

Order your books from:

START 'EM SAILING!

Gordon C. Aymar. Designed to teach the novice how to sail a small boat. 106 ills. \$2.50

RIDING SIMPLIFIED\*

Margaret Cabell Self. Practical advice on how to become a skilled horseman. 53 ills. \$1.95

KITES\*

H. Waller Fowler, Jr. Complete instructions on a fascinating hobby for young and old. 70 ills. \$1.95

ROPING\*

Bernard S. Mason. The elements of roping for the beginner and the enthusiast. Special attention given to the lariat. 81 ills. \$1.95

\*Books in the Barnes  
SPORTS LIBRARY

THE RONALD PRESS COMPANY  
15 East 26th St., New York 10

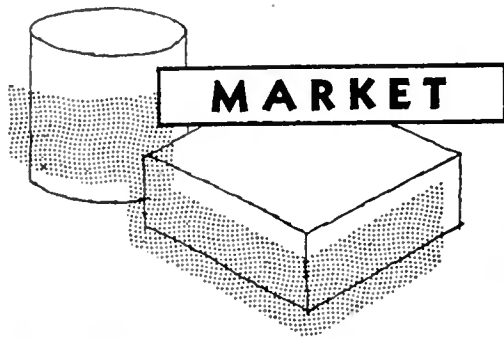

## NEWS

*If you are interested in any of these products, write directly to the manufacturer at the address given. PLEASE mention that you read about it on RECREATION magazine's Market News page.*

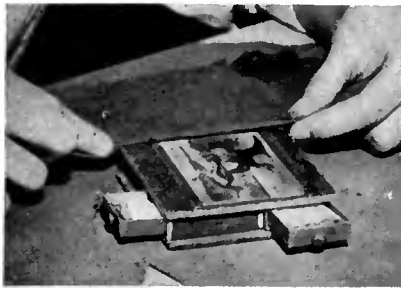

◆ LeatherOn, a thin slice of genuine, tanned pigskin leather, can be applied to wood, metal, ceramic and plastic surfaces as easily as wall paper, giving these surfaces the rich color of leather and a highly appealing pigskin

grain. Although too thin and pliable for making billfolds and other leather products which require stiffness, LeatherOn can be used in a multitude of projects, ranging from book covers and animal cutouts to personalized jacket patches and rugged-looking identification labels for suitcases and bicycles. Hunting Interiors, 1422 Lake Drive S.E., Grand Rapids, Michigan. (Ask for Bulletin 323.)

◆ A new all-weather fan-shaped backboard and goal is an economical play unit designed especially for backyards, school yards or playgrounds. The backboard is fabricated from one-piece double-laminated oil-tempered Presdwood, developed primarily for outdoor service. It will not rust or corrode and is protected from moisture and weather with two coats of non-glare outdoor white enamel. The backboard is pre-drilled to accommodate a special heavy one-half inch goal. This special goal is finished in baked-enamel regulation orange and comes complete with necessary mounting hardware and twelve "No-Tie" net holders. Rawlings Sporting Goods Company, 2300 Delmar Boulevard, St. Louis 3.

◆ Recreation directors can conduct a playground-wide tetherball contest without expense by means of a special package, available on request, which contains necessary prizes, announcements, publicity releases, rules and instruction. Tetherball, a game designed primarily for schools and playgrounds, requires no other equipment than a ten-foot-pole, a tetherball and enough space for a twenty-foot circle.

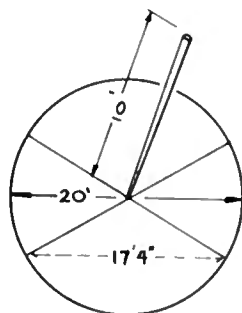

a contest provides a perfect introduction. For further information about the free kit, write Tetherball, W. J. Voit Rubber Corp., Box 3068, Terminal Annex, Los Angeles 54.

◆ A featherweight float made of styrofoam supports fifty-five pounds per cubic foot and won't sink, rust, rot, mold or deteriorate. There is nothing to puncture or leak; it won't attract or sustain marine life, rodents or pests and has no odor—wet or dry. The float is immune to temperature changes from below zero to over 170 degrees; salt water has no effect on it, and it won't absorb either salt or fresh water.

The Styrofloat measures 6'x10' and weighs 596 pounds. It is built of good grade spruce or fir in a blockhouse design with oak skids. The styrofoam is completely protected and all metal parts are galvanized to resist corrosion. Each unit comes with one mooring ring and one mooring cleat. Two or more units may be joined together in any shape or pattern to perform as one float. Hussey Manufacturing Company, Inc., North Berwick, Maine.

◆ Tite-Roper is a new piece of playground equipment developed to satisfy the child's natural love for testing his balancing ability. It consists of a twenty-foot steel cable suspended, sixteen inches above the ground, between two platforms. Tite-Roper is ruggedly constructed—the sturdy platforms have a step and handrails; the cable is three-quarters of an inch in diameter. According to the manufacturer, the equipment can remain in continuous use without any kind of maintenance. Wise Engineering Company, 165 Delancy Street, Newark 5, New Jersey.



◆ Are your files a matter of hide and seek? Transparent index tabs of pressure-sensitive acetate are now pre-printed in eighteen different standard sets—alphabetical, numerical, bookkeeping, monthly, daily and geographical, and so on. Each set has a distinctive color bar for easy color-coding. Ready to attach, the tabs require no cutting, inserting or moistening by users and thus permit attachment in a matter of seconds. Pressure-sensitive coating adheres immediately to thick or thin materials including acetate sheet protectors. Superior-Tabbies, Inc., Department 353, Room 954, 131 South Franklin Street, Chicago 6.



# THE SARGENT GUIDE TO SUMMER CAMPS

12th Edition

A compact guide that provides all the basic statistics for the intelligent choice of an appropriate summer camp. Listings by type, athletic specialty, trips and remedial instruction. Complete information on fees, administration, and facilities.

160 pages  
\$2.20 cloth  
\$1.10 paper

## THE BIG RED BOOK

THE HANDBOOK OF PRIVATE SCHOOLS

38th Edition

For half a century the complete objective survey of independent education. Staff written, the HANDBOOK has become a by-word among educators for up-to-date accuracy and dependability.

1216 pages  
\$8.00 cloth

## PORTER SARGENT PUBLISHER

11 BEACON STREET, BOSTON 8, MASS.

# ★ THREE IMPORTANT McGraw-Hill GUIDES



for Recreation Leaders and Teachers

## PLAY ACTIVITIES FOR BOYS AND GIRLS

*A Guide for Teachers, Parents, and Recreation Leaders*  
*Ready in June*

By RICHARD KRAUS, Columbia University  
This new book of timely interest describes the underlying values of youthful play, and gives examples of successful play programs. It gives many specifically helpful suggestions and guides for working with groups of children as well as clearly-written directions for a wide variety of activities including active and inactive games; musical play and singing; folk and creative dancing; arts and crafts; and dramatics. Recent advances on play programs and up-to-date material on childhood development are included.

★ ★ ★

## RECREATION LEADER'S HANDBOOK

By RICHARD KRAUS. Series in Health Education, Physical Education and Recreation. 312 pages, \$5.75

This outstanding work provides a practical, down-to-earth discussion of social leadership objectives and techniques applied to the recreation needs of groups of all sizes and ages. It covers the background of social recreation in this country, the role of recreation in everyday life, leadership objectives and techniques in working with recreation groups, and a wide variety of time-tested acceptable materials. There is an extensive treatment of program planning to meet the needs of different types of groups.

★ ★ ★

## INDUSTRIAL RECREATION

*A Guide to Its Organization and Administration*

By JACKSON M. ANDERSON, National Industrial Recreation Association. Series in Health Education, Physical Education, and Recreation. 304 pages, \$5.00

The first complete book on the increasingly important subject of industrial recreation. It is intended as a guide to recreation directors in administering employee recreation programs, and for those who wish to study its organization and administration. In addition to specific recommendations on planning and initiating a program, its activities, leadership and financing, there is a thorough discussion of the history of employee recreation and its benefits to industrial relations.

### USE THIS COUPON

COLLEGE DEPARTMENT, McGRAW-HILL BOOK COMPANY, Inc.  
330 West 42nd Street, New York 36, N. Y.

Please send me, on approval, a copy of the book(s) checked. I agree to pay for the book(s) upon receipt of invoice or return the book(s) within 10 days.

- PLAY ACTIVITIES FOR BOYS AND GIRLS  
 RECREATION LEADER'S HANDBOOK  
 INDUSTRIAL RECREATION

Name .....

Address .....

City ..... Zone ..... State .....

Title .....

Affiliation ..... R657

**McGraw-Hill BOOK COMPANY, Inc.**

330 West 42nd Street, New York 36, N. Y.

# Handweaver & Craftsman

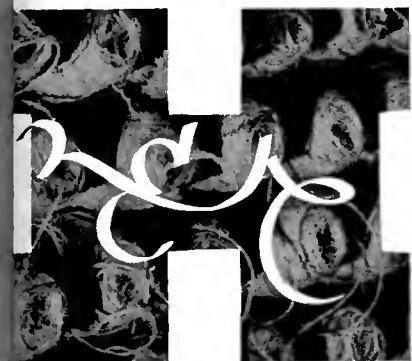

NEW  
INTERESTING  
PROJECTS  
FOR YOUR  
SUMMER  
RECREATION  
PROGRAMS

Single Copies \$1.00

Published Quarterly — 64 Informative Pages

Write today for brochure and prices on back issues.

A subscription to Handweaver & Craftsman and a complete file of back issues will provide you with a live weaving library.

## Handweaver & Craftsman

DEPT. R, 246 FIFTH AVENUE, NEW YORK 1

Single copy \$1, 1 yr. \$4, 2 yrs. \$7.50, 3 yrs. \$10, 5 yrs. \$15  
Canadian postage 50c year extra, Post American and foreign \$1

# ..... CLASSIFIED ADVERTISING .....

RATES: Words in regular type \$.15 each  
Words in boldface type \$.25 each  
Minimum ad accepted ... \$3.00

COPY: Type—or clearly print—your message and the address to which you wish replies sent. Underline any words you want to appear in boldface type.

DEADLINES: Copy must be received by the fifth of the month preceding date of the issue in which ad is desired.

Send copy with remittance to: RECREATION Classified Advertising, 8 West Eighth Street, New York 11, New York.

## HELP WANTED

Qualified Counselors over 20 for delux Santa Barbara Girls camp: riflery, drama, modern dance, CIT Director, Unit leader, General. \$200 min.—8 weeks. Virginia Barnes, 2535 Fordham, Palo Alto, California.

Recreation Leaders wanted. New World-Wide Summer Placement Directory lists 1000's of summer jobs in 48 states, 20 foreign lands. Resorts, camps, earning trips abroad, study awards, etc. Rush \$2.00 now. Crusade, R, Box 99, Station G, Brooklyn 22, N. Y.

## POSITIONS WANTED

Recreation Director institution or Assistant Director community program. Two years experience, 50-mile radius of New York City. Available September 1957. Write full details to Apt. 21-B, 611 West 171st Street, New York 32, N. Y.

The publisher assumes no responsibility for services or items advertised here.

HELP WANTED • • POSITIONS WANTED • • SERVICES AVAILABLE • • WORKSHOPS & CONFERENCES • • EDUCATIONAL OPPORTUNITIES • • ITEMS FOR EXCHANGE

## Books & Pamphlets Received

CHURCHES AND JUVENILE DELINQUENCY, THE, Robert and Muriel Webb. Association Press, 291 Broadway, New York 7. Pp. 64. \$.50.

CLAY, WOOD AND WIRE—A How-To-Do-It Book of Sculpture, Harvey Weiss. William R. Scott, 8 West 13th Street, New York 11. Pp. 48. \$3.50.

COME BOATING WITH ME, Percy Woodcock. Sport Shelf, 10 Overlook Terrace, New York 33. Pp. 142. \$3.00.

CRUISING BOATS WITHIN YOUR BUDGET, John J. Benjamin. Harper & Brothers, 49 East 33rd Street, New York 16. Pp. 229. \$4.00.

DESIRABLE PRACTICES FOR THE ADMINISTRATION OF CONSOLIDATED MUNICIPAL PARK AND RECREATION DEPARTMENTS, Serena E. Arnold. American Institute of Park Executives, Oglebay Park, Wheeling, West Virginia. Pp. 31. \$1.00.

DIRECTORY OF CAMPS FOR THE HANDICAPPED. American Camping Association, Bradford Woods, Martinsville, Indiana. Pp. 61. \$.50.

FOLK DANCING, Grace I. Fox and Kathleen Gruppe Merrill. Ronald Press, 15 East 26th Street, New York 10. Pp. 89. \$3.50.

FORMS AND PATTERNS IN NATURE, Wolf Strache. Pantheon Books, 333 Sixth Avenue, New York 14. Pp. 22 (plus 88 full-page plates). \$7.50.

GAMES AND STUNTS FOR ALL OCCASIONS (Revised Edition), William P. Young and Horace J. Gardner. J.B. Lippincott, East Washington Square, Philadelphia 5. Pp. 120. \$2.50.

GAMES FOR THE NOT-SO-YOUNG, Sid G. Hedges. Philosophical Library, 15 East 40th Street, New York 16. Pp.

106. \$2.75.

GAME PLAYS OF BASEBALL, THE, Al Niemiec. Craftsman Press, 2030 Westlake Avenue, Seattle 1. Pp. 58. Paper \$2.00.

I WANT TO BE A FISHERMAN, Carla Greene. Childrens Press, Jackson Boulevard and Racine Avenue, Chicago 7. Unpaged. \$2.00.

ON THE TRAIL OF VANISHING BIRDS, Robert Porter Allen. McGraw Hill, 330 West 42nd Street, New York 36. Pp. 251. \$4.50.

ORNITHOLOGISTS' GUIDE, THE, H. P. W. Hutson, Editor. Philosophical Library, 15 East 40th Street, New York 16. Pp. 275. \$10.00.

PHYLLIS (Baseball Fantasy), Ted Key. E. P. Dutton & Company, 300 Fourth Avenue, New York 10. Pp. 59. \$1.95.

SEA TREASURE—A GUIDE TO SHELL COLLECTING, Kathleen Yerger Johnstone. Houghton Mifflin Company, 2 Park Street, Boston 7. Pp. 242. \$4.00.

YMCA SWIMMING MANUAL (1956 Revision), National Council of Young Men's Christian Associations of Canada, 15 Spadina Road, Toronto 4, Ontario. Pp. 72. \$.50.

## Magazine Articles

ARTS AND ACTIVITIES, April 1957  
The Magic Formula (Sculpturing material), Lucile Jenkins  
—, May 1957  
Why Shed Creativity in the Summer? Alex Pickens.

CAMPING MAGAZINE, March 1957  
Hosteling—Its Place in Your Camp Program, Frank W. Harris.  
Some Current Developments in Algae Control.  
—, April 1957  
Conservation Projects for Camp, Janet Nickelsburg.  
Get Off to a Good Start with Basic

Pre-Camp Training, Marvin Rife.  
Safari—An Adventure in the Out of Doors, Herbert F.K. Klinger.  
Some Basic ABC's for Evaluating Your Camp Program, Daniel Feinberg.

JOURNAL OF HEALTH, PHYSICAL EDUCATION, RECREATION, March 1957  
Indoor Drills and Conditioning for a Baseball Squad, Robert M. Wren.  
Mountain Recreation, Frederick Bierhaus.  
—, May-June 1957  
Outdoor Recreation Areas—A Symposium.  
School Camping is Rewarding for Retarded Children, Edgar A. Taylor, Jr.

PARK MAINTENANCE, May 1957  
Hamilton County's Winton Woods Archery Center, Melvin J. Rebholz and George Helwig.  
Operation Outdoors is Forest Service Answer to Camping Public.  
You Can Expect Stricter Codes for Swimming Pools.

SAFETY EDUCATION, May 1957  
Counselors and Helpers in Summer Camps (Safety Education Data Sheet #80).  
SPORTS ILLUSTRATED, March 11, 18, 25, April 1, 15, 1957  
The Modern Fundamentals of Golf (in five parts), Ben Hogan.  
—, April 15, 1957  
Special 1957 Baseball Issue.  
—, April 29, 1957  
The Great U.S. Pool Boom, Fred R. Smith and Jo Ahern.

SWIMMING POOL AGE, April 1957  
The Latest in Indoor-Outdoor Pool Design.  
New Jersey's First "Pool Clinic" Great Success.  
Teaching Tiny Tots to Swim, Ray Taylor.  
—, May 1957  
Articles on swimming pool operation and maintenance.

# NEW

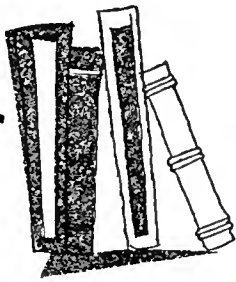

# PUBLICATIONS

*Covering the Leisure-time Field*

## Camping\*

Barbara Ellen Joy. Burgess Publishing Company, 426 South Sixth Street, Minneapolis 15. Pp. 85. Paper \$2.75.

The author, formerly owner and director of the Joy Camps, former president of the American Camping Association and now a camp consultant, is very well-known in the camping field. Even if not, however, it would be possible for anyone to see that this book was written by someone to whom camping is a personal experience. No one but a real "practitioner" could bring out these small details, the intimate information.

No one book can give all the answers. If this reviewer could place only one book in the hands of a new camp director, however, it would be this one. Why? Not because of the information in it, although this information is sound, but because of this book's open-mindedness, its questioning philosophy, its refusal to go blindly along with every new concept without looking ahead to see possible results.

It dares to question, to refute, to analyze—even to quarrel with and disagree—but always without the intrusion of personal feelings, and always with the basic objective of the right of every child to be an individual.

The author's interest in the individual is the key to this book. ". . . This concept is that the camping experience should develop the individual child,"

she writes, "not only as a member of a group, but as an entity who has needs and desires apart from those fulfilled for him through the inevitable and induced group sharing, planning, playing, and living together. . . ." Her final statement of ultimate objective is not only philosophically sound for camping, but for any other childhood experience:

"And so, as camping grows with the years, let us hope and pray that somehow we as leaders may learn how to speak not only to the social self of the child camper, the participant in the world's complexity, but also to that still remaining solitary self that can never be caught up in the interdependence of the swiftly changing world.

"This emphasis on the development of the individual as a vigorous and strong personality . . . will be the next great challenge to camping. Its ultimate accomplishment may well be its most noble purpose. . . ." To which we will all say a fervent Amen!—*Virginia Muselman, NRA Program Service.*

## Act It Out\*

Bernice Wells Carlson. Abingdon Press, 810 Broadway, Nashville 2, Tennessee. Pp. 160. \$2.00.

A collection of simple dramatic activities written for children. Because of the simplicity of style, as well as of the material, this is a good source of dramatic activities for playground leaders who are not drama specialists, but who know the importance of playground drama.

It contains many dramatic games, short skits, stunts, pantomimes, tableaux, and playlets, as well as two short pageants and a good collection of simple, short skits and playlets for various types of puppets and marionettes. The style is informal, the material is in good taste, and the illustrations by Laszlo Matulay are full of humor and vitality. The book will be very useful to playground leaders, camp counselors, and other playground leaders working primarily with six-to twelve-year-olds.

## Education and Art

Edwin Ziegfield, Editor. UNESCO, United Nations, New York. Pp. 129. \$5.50.

It is not our general custom to re-

view books printed several years ago, but this one (1953) somehow slipped by us, possibly because it was printed in Switzerland for UNESCO, and so did not appear on the usual lists. It is so stimulating and so important a book, however, that we should be remiss not to call it to the attention of art departments and all serious art leaders and teachers.

This symposium has eight major sections. Specialists in art, education, sociology and psychology consider the nature of creative activity and art education. Creative art teaching of the young child and the adolescent is described and discussed in terms of methods and materials. Problems of administration, training of art teachers, and art education in its relation to the community are dealt with and lead into a consideration of art education and indigenous cultures. The last section discusses art education from the international point of view.

The names of the authors of the various articles sound like an international roll-call of artists, artist-educators, psychologists, and sociologists: Henri Matisse, in "The Nature of Creative Activity"; Herbert Read, English poet, art critic and writer, in "Education Through Art" and so on. A quotation from this last article somehow seems to sum up the intent of the entire book: "It is a mistake to define a world of art and set it apart from life. For that reason it is a mistake to teach the appreciation of

\* Available from NRA Recreation Book Center, 8 West Eighth Street, New York 11, N. Y.

## CUTE TOY ANIMALS FROM ECONOMICAL WOOL YARN

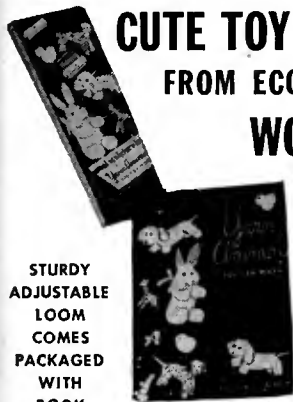

Be one of the first to teach this fascinating new art of wool sculpture for fun and profit. Make rabbits, dogs, cats, squirrels, elephants, monkeys and other animals using the cheaper grades of wool. More than 150 easy-to-follow, step-by-

step line drawings and photos.

STURDY ADJUSTABLE LOOM COMES PACKAGED WITH BOOK

BOOK AND LOOM, ONLY \$2.75

## THE SHADOW BOX

1378 E. 8th St., Brooklyn 30, N. Y.

## IDEA BOOK 64 PAGES!



### ENAMEL-ON-COPPER

Learn jewelry making; latest enameling processes and techniques from step-by-step illustrated instructions. Book lists many new copper items, complete supplies, tools & equipment. Send for your copy of this valuable reference book today! IT'S FREE

### THE COPPER SHOP

A Div. of Immerman & Sons • Dept. 208  
2185 East 14th • Cleveland 15, Ohio



## Jayfro BASKETBALL STEEL CHAIN NETS

3 Years Guarantee outdoors or indoors

Also featuring Jayfro's custom built

✓ ALUMINUM MULTI-PURPOSE STANDARDS

✓ SHUFFLEBOARD SETS WITH

"RUBBER CUSHIONED" DISCS

✓ PADDLE TETHERBALL SETS

• Send for Free Catalog •

JAYFRO ATHLETIC SUPPLY CO.  
Dept. R, Box 1065, NEW LONDON, CONN.

art. for the implied attitude is too detached. Art must be practised to be appreciated, and it must be taught in intimate apprenticeship. The teacher must be an artist no less active than the pupil. . . . We do not insist on education through art for the sake of art, but for the sake of life itself."

The numerous color plates of children's paintings from all over the world are delightful and exciting; and there are many other excellent black and white photographs of children sharing creative activities.

This is a book to treasure, to study, to refer to, to quote from, to learn from—for those people deeply interested in child development, in the use of the best education methods to free, not suppress, the instinctual and emotional components of human personality.

### Public Relations for Social Agencies

Harold P. Levy. Harper and Brothers, 49 East 33rd Street, New York 16. Pp. 208. \$3.50.

This book is for executives, board members, advisory committee members and others in the field of social welfare who are not specialists in public relations. Written by a counselor who has

had many years of experience, it shows how public relations thinking (in the widest sense of the word) can, and should, permeate all that an agency does. It is not primarily a publicity manual, although it has many helpful things to say about ways to get publicity and to make the most of it.

Enlivened by case histories and brief examples, it can be read with profit by all who feel the need for better public relations but don't quite know how to go about it.

A chapter on public agencies will be of special interest to many state, county, and municipal recreation directors, but the entire book contains ideas and suggestions that are broadly applicable and easily adapted. *Anne New, NRA Public Information and Education Service.*

### How to Survive on Land and Sea\* (Second Revised Edition)

U. S. Naval Institute, Annapolis, Maryland. Pp. 368. \$4.00.

Aside from being interesting reading, a great deal of the information in this book could be utilized in any programs planned around the subject of survival—a discussion program, a hike such as described on page 222 of this issue, and other adventure, nature or campcraft activity. It covers finding food and water, building fires, improvising shelter—all in a strange environment, far from civilization—and such topics as how to spear fish, prepare wild animal food, orientation and travel, and environmental hazards.

This was one of a series of training manuals originally prepared by and for naval aviation personnel. It is liberally and attractively illustrated.

### FAMILY CAMPING

*Sunset Ideas for Family Camping.\** Lane Publishing Company, Menlo Park, California. Pp. 128. Paper \$1.75.

Families who are going camping can't afford to overlook this book unless they are very experienced indeed! It is a manual and guide to everything they need to know in order to take their outing in stride and make it a huge success. Contents are related to taking the trip in the family car and include ingenious ideas for comfort and convenience which may be overlooked by even seasoned campers. Assembling equipment, what to take, when to go, transporting gear, traveling with children, pitching camp and cooking are some of the many subjects covered. Although suggestions as to obtaining information about *where to go* only apply to the Western states, the camping instructions are good and include the setting up of a camp in *any* national or state park, forest or monu-

ment. One chapter is devoted to desert and beach camping; the inside back cover carries a checklist of camping equipment; the front inside cover, a checklist of food. Recommended.

*Family Camping and Places to Camp in the North Central States*, George T. Wilson. R. Laacke Company, 1025-35 West Walnut Street, Milwaukee 5. Pp. 112. Paper \$1.00.

Some readers will remember the small, but very popular, pamphlet with the same title published several years ago. This is a completely revised and enlarged second edition. The author is supervisor and director of outdoor education for the Milwaukee Department of Municipal Recreation and Adult Education, and conducts the department's Family Camping Association. He and his family have been camping enthusiasts for many years and this booklet is based upon what they have learned from practical experience.

The last forty-one pages contain a detailed directory of places to camp in Wisconsin, Michigan, Minnesota, Iowa, Illinois and Indiana; a listing of books, guides and organizations; and a listing of where to write for more information on state parks, forests, national areas.

It is always a pleasure to see professional leaders in public recreation produce good program publications. Last month we reviewed the book on playground activities by Frank Geri, director of playgrounds in Bellingham, Washington. Who's next?

### Inspirational Poetry for Camp and Youth Groups

(Second Edition)

Compiled by H. Jean Berger, 49 North Main Street, Cortland, New York. Unpaged (8" x 4 3/4", 3-hole, loose-leaf cards). \$2.00.

This compilation of verse, quotations and poems is for those who love the out-of-doors or who are leaders of inspirational services in camp. Its contents were a part of a collection, started by the author when she was a camper twenty years ago, which she presents to today's campers in the hope that it may be "but the beginning of a rich and valuable anthology. . . ." She is now an associate professor of physical education at State Teachers College, Cortland, New York.

Poetry is one of the vital means of expressing the spiritual experiences which occur in camp. In the hands of an enthusiastic camp leader, this little book can do much to start an awareness of camp beauty and poetry. It should be in every camp library, and available to campers through the camp store if there is one.

## INDEX OF ADVERTISERS

|                                    | PAGE               |
|------------------------------------|--------------------|
| All Metal Tennis Table Company     | 193                |
| American Playground Device Company | 193                |
| Associated Films                   | 196                |
| The Athletic Institute             | 194                |
| Beltz Engineering Laboratories     | 193                |
| The J. E. Burke Company            | 207                |
| California State Personnel Board   | 215                |
| The Copper Shop                    | 239                |
| Dremel Manufacturing Company       | 207                |
| Duo-Kiln Manufacturing Company     | 193                |
| Greenwich Book Publishers          | 193                |
| Handweaver & Craftsman             | 237                |
| Hillerich & Bradsby                | Inside Front Cover |
| Hoppy Taw Corporation              | 207                |
| Jamison Manufacturing Company      | 215                |
| Jafro Athletic Supply Company      | 239                |
| J. C. Larson Company               | 194                |
| McGraw-Hill Book Company           | 237                |
| Monroe Company                     | 227                |
| National Trophy Sales              | 231                |
| Newcomb Audio Products Company     | 235                |
| Park Maintenance                   | 194                |
| Porter Sargent Publisher           | 237                |
| Prior Jewelry and Award Company    | 234                |
| The Ronald Press Company           | 235                |
| The Shadow Box                     | 239                |
| James Spencer & Company            | 193                |
| Square Dance Associates            | 194                |
| Superior Industries Corporation    | 207                |
| Voit                               | 235                |
| X-acto, Inc.                       | 207                |

# Recreation Leadership Courses

Sponsored by the National Recreation Association  
and  
Local Recreation Agencies

**June, July and August, 1957**

|                                                  |                                                                                                                                                                                               |                                                                                                                                                                                                                                                                                                                                                                                                                         |
|--------------------------------------------------|-----------------------------------------------------------------------------------------------------------------------------------------------------------------------------------------------|-------------------------------------------------------------------------------------------------------------------------------------------------------------------------------------------------------------------------------------------------------------------------------------------------------------------------------------------------------------------------------------------------------------------------|
| <b>HELEN M. DAUNCEY</b><br>Playground Recreation | Youngstown, Ohio<br>June 13-14<br>York, Pennsylvania<br>June 17-18<br>Lancaster, Pennsylvania<br>June 19-20<br>Durham, New Hampshire<br>June 24-27<br>Whitinsville, Massachusetts<br>July 1-2 | O. S. Ellis, Director-Treasurer, The Youngstown Playground Association, 2218 Ohio Avenue<br>Mrs. Sylvia C. Newcombe, York Recreation Commission, 32 W. King<br><br>Albert E. Reese, Director of Recreation, 135 N. Lime Street<br><br>Miss Patricia L. Olkkonen, Recreation Specialist, University of New Hampshire<br>Roscoe M. Marker, Supervising Director, Town of Northbridge Playground and Recreation Commission |
| <b>RUTH G. EHLERS</b><br>Playground Recreation   | Shepherdstown, West Virginia<br>July 5-8                                                                                                                                                      | J. O. Cullison, Dean, Shepherd College                                                                                                                                                                                                                                                                                                                                                                                  |
| <b>ANNA S. PHERIGO</b><br>Playground Recreation  | Reading, Pennsylvania<br>June 5-7<br>Toledo, Ohio<br>June 10-13                                                                                                                               | John Wise, Director, Recreation Board of Berks County, Court House<br><br>Arthur G. Morse, Division of Recreation, 214-18 Safety Building                                                                                                                                                                                                                                                                               |
| <b>GRACE WALKER</b><br>Creative Recreation       | Montgomery, Alabama<br>June 4-8<br>Great Falls, Montana<br>June 10-23                                                                                                                         | William L. Brannon, 1001 Tuscaloosa<br><br>Miss Margaret Bucher, Director of Education, Montana Farmers Union, Box 2089                                                                                                                                                                                                                                                                                                 |
| <b>FRANK A. STAPLES</b><br>Arts and Crafts       | Toledo, Ohio<br>June 10-13<br>Altoona, Pennsylvania<br>June 15                                                                                                                                | Arthur G. Morse, Division of Recreation, 214-18 Safety Building<br><br>Stuart E. Nolan, Assistant Superintendent of Recreation, Lexington Avenue and Tenth Street                                                                                                                                                                                                                                                       |

---

Mr. Staples will conduct an arts and crafts course the first week in June at Offutt Air Force Base in Omaha. For further details, communicate with the Air Force Regional Representative, Howard Beresford, 3055 Bellaire, Denver, Colorado.

---

Attendance at training courses conducted by National Recreation Association leaders is usually open to all who wish to attend. For details as to location of the institute, contents of the course, registration procedure, and the like, communicate with the sponsor of the course as listed above.

**JUNE**

**NATIONAL  
RECREATION  
MONTH**

**LIVE *ALL* YOUR LIFE**



# Recreation

Henry Pfeiffer Librarian  
MacMurray College  
Jacksonville, Illinois

NATIONAL RECREATION ASSOCIATION • SEPTEMBER 1934

# Center-Powered

to give you **FOLLOW-THRU** Feel

You're looking at the ultranew Center-Powered iron in which is achieved great concentration of weight directly in back of the hitting area. Adroit designing, for appearance as well as for weight displacement, imparts to this club that rare combination of beauty and power. What's more, the new Grand Slams are forged from **STAINLESS**—the premier metal for iron golf heads.



Brand new for 1957, these confidence-inspiring wood beauties have in good share that head-power-feel for which H & B woods have long been noted.

*It's looks, feel, and performance that count with golfers—the new Grand Slams have everything.*

**HILLERICH & BRADSBY CO., Louisville, Kentucky**  
Also Makers of Famous Louisville Slugger Bats

When writing to our advertisers please mention RECREATION.





**GET ENTHUSIASM!**

*Free... complete kit to organize a gold medal*

# HARVARD TABLE TENNIS TOURNAMENT IN YOUR SCHOOL, PLANT OR RECREATION PROGRAM

Everyone plays in a Harvard Gold Medal Table Tennis Tournament . . . because everyone enjoys this exciting event that serves more players, in less space, without any permanent installation and at lower cost than most other school sports.

We will send, ABSOLUTELY FREE, the Harvard Tournament Kit containing everything you need to organize your own full-participation tournament: Harvard Table Tennis Teacher with instructions, rules and tournament tips; 2 Tournament Charts; complete publicity program and tally sheets.

FREE . . . for your winners, Harvard Gold Medals and award certificates when you complete the tally sheets. Mail the coupon below today.

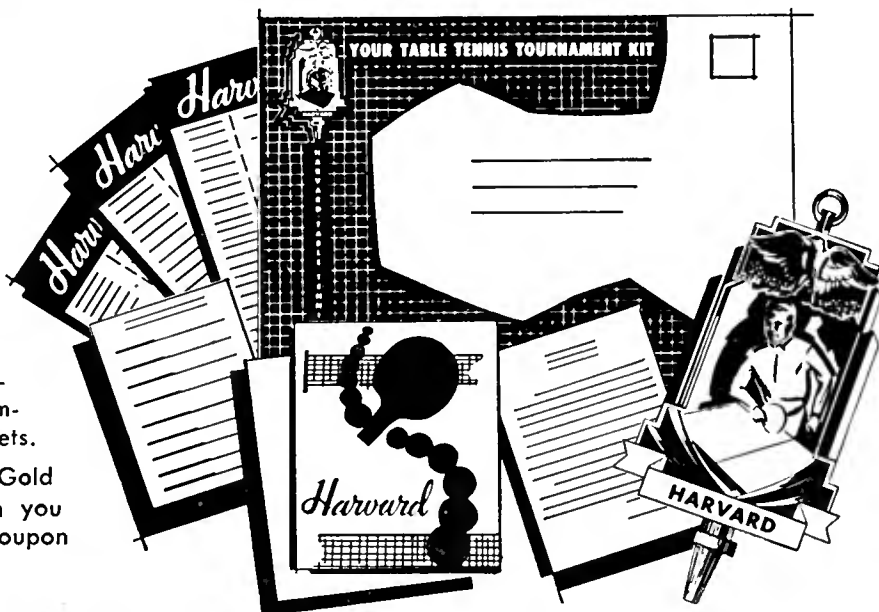

*Harvard* TABLE TENNIS CO. 60 STATE ST. BOSTON 9, MASS.

Gentlemen:

In order to run a table tennis tournament please send us the FREE Harvard Tournament Kit.

SCHOOL OR ORG. \_\_\_\_\_  
 NAME \_\_\_\_\_  
 POSITION \_\_\_\_\_  
 STREET & NO. \_\_\_\_\_  
 CITY \_\_\_\_\_ ZONE \_\_\_\_\_ STATE \_\_\_\_\_

R-9

We plan to start our tournament on \_\_\_\_\_  
 There will be approximately \_\_\_\_\_ participants.  
 We do \_\_\_\_\_, do not \_\_\_\_\_ offer table tennis all year.  
 Table Tennis is part of our \_\_\_\_\_ program.  
 There are \_\_\_\_\_ in our school or organization.

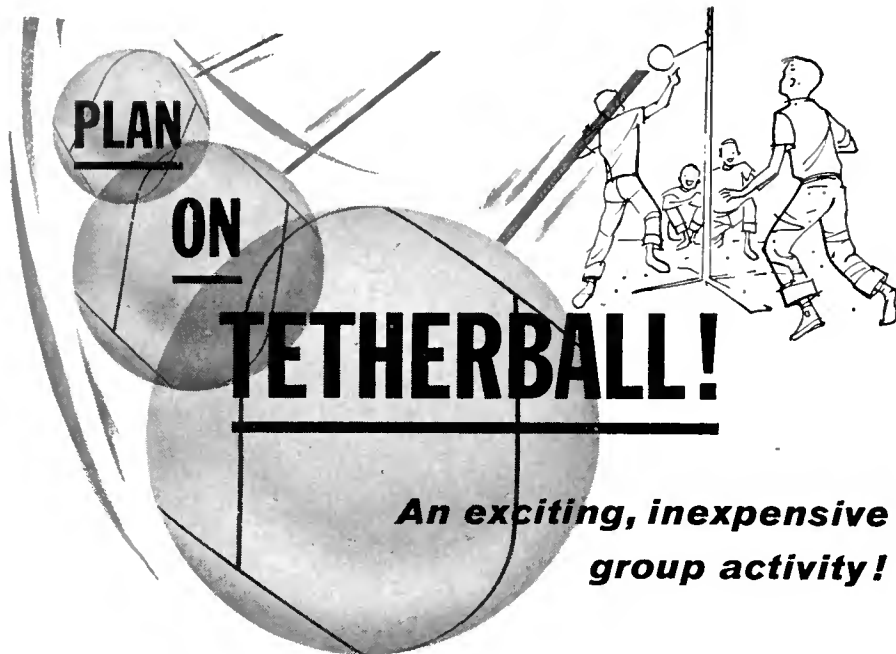

**Looking for a new recreation idea? Voit has it in a pre-tested, packaged Tetherball Contest!**

If you haven't tried tetherball, this contest is a wonderful way to get it started on your local playgrounds.

If the game is already well-established in your area, here's a way to adapt it into an organized *new* Recreation Department activity.

Voit will furnish you with complete instructions, awards and tested suggestions on how to make tetherball contests a high spot on your calendar.

Tetherball knows no season. It's popular year 'round, so you can make use of the contests to perk up a recreation program during any doldrum period.

Fun for all ages, tetherball draws its peak attention from the 7 to 12 year old age group—boys and girls.

For the youngsters, tetherball means fun, excitement and action.

For the playground director, it means safe play with minimum supervision.

For the purchaser, it means easy installation, low-cost, long-lasting recreational equipment.



**VOIT OFFICIAL TETHERBALLS**

Safe, durable, waterproof and washable. Built for hard use with strong fabric carcass and a soft, "Stingless" cover in bright yellow for highest visibility. Exclusive spiral design—first true tetherball.

**TETHERBALL**

2945 East 12th Street  
Los Angeles 23, California

Please send me complete details on your packaged Tetherball Contest. Including rules, court layouts and installation instructions.

NAME \_\_\_\_\_  
ADDRESS \_\_\_\_\_  
CITY \_\_\_\_\_ STATE \_\_\_\_\_



America's Finest Sports Equipment By

45 W. 18th Street, New York 11  
315 E. Grand Avenue, Chicago 11  
2945 E. 12th Street, Los Angeles 23

for every  
**RECREATION  
ACTIVITY**

**HI-FI**  
sound  
at low cost



**NEWCOMB**

- transcription player
- public address system

For every sound reproduction application in recreation halls, gyms, auditoriums, or summer camps, the Newcomb R-16CV does the job better, yet weighs less than 22 pounds. A separate microphone and phonograph volume control permits mixing recorded music with the microphone presentation. *Variable speed control* allows variable tempo and pitch (from any basic speed setting). A quality heat and humidity resistant high fidelity ceramic pickup is encased in a professional-type tone arm. Balanced-design amplifier with inverse feedback in combination with a fine ten-inch extended range speaker give quality you'd never expect at its price. Newcomb is the "sound of quality since 1937"... recognized by leading school authorities from coast to coast.



**NEWCOMB VARIABLE SPEED**  
Exclusive Newcomb design gives dependable continuously variable control at all 3 speeds.

**FREE CATALOG**

**NEWCOMB**  
Audio Products Co., Dept. 7-9  
6824 Lexington Av., Hollywood 38, Calif.

- Send free catalog of Newcomb portable sound equipment.
- Send name of our nearest Newcomb distributor.

Name \_\_\_\_\_  
Address \_\_\_\_\_  
City \_\_\_\_\_

# Recreation\*



THE MAGAZINE OF THE RECREATION MOVEMENT

*Editor in Chief, JOSEPH PRENDERGAST*  
*Editor, DOROTHY DONALDSON*  
*Editorial Assistant, AMELIA HENLY*  
*Business Manager, ALFRED H. WILSON*

ASSOCIATE EDITORS  
*Recreation Administration, GEORGE BUTLER*  
*Program Activities, VIRGINIA MUSSELMAN*

Vol. L. Price 50 Cents No. 7

**On the Cover**

CAN YOU RESIST the call of a country lane in September or October? As school opens for the year, the countryside puts on its most beautiful dress. Use the weekends, now, for a last round of hikes, picnics, cookouts. Have your share of fun under autumn skies—for indoor activities belong primarily to the winter, and the winter can be long! Photo courtesy Massie, Missouri Resources Division.

**Next Month**

Do you know why we celebrate Halloween, and origin of some of its pranks? The October 1957 issue of RECREATION will tell you. Also, that issue will carry an interesting article on American folk dancing by Sarah Gertrude Knott and an excellent one on public relations by Richard M. Baker, vice-president of the Brady Company in Appleton, Wisconsin. Program articles include one on promotion and decoration by Mary Frances Sargent, Army Service Club director, and one on adapting dancing for senior citizens. Frank Staples' How-To-Do-It! covers mosaic making; and don't miss the center-spread which reports the results of June as National Recreation Month this year.

**Photo Credits**

Page 250, Pacific Air Industries, Long Beach, California; 252-4, Jasper Nutter and Marshall LeCour, Long Beach, California.

RECREATION is published monthly except July and August by the National Recreation Association, a service organization supported by voluntary contributions, at 8 West Eighth Street, New York 11, New York, is on file in public libraries and is indexed in the *Readers' Guide*. Subscriptions \$4.00 a year. Canadian and foreign subscription rate \$4.50. Re-entered as second-class matter April 25, 1950, at the Post Office in New York, New York, under Act of March 3, 1879. Acceptance for mailing at special rate of postage provided for in Section 1103, Act of October 3, 1917, authorized May 1, 1924. Microfilms of current issues available University Microfilms, 313 N. First Street, Ann Arbor, Michigan.

*Space Representatives:* Mark Minahan, 168 North Michigan Avenue, Chicago, Illinois; Seymour A. Robbins & Associates, 101 West 55th Street, New York 19, New York; The Jules E. Thompson Company, 681 Market Street, San Francisco 5, California.

Copyright, 1957, by the National Recreation Association, Incorporated

Printed in the U.S.A.



\* Trade mark registered in U. S. Patent Office.

**CONTENTS**

**GENERAL FEATURES**

Recreating for Fitness (Editorial) . . . . . *Shane MacCarthy* 244  
 Sure-Fire Safety in Riflery . . . . . 256  
 New Vistas in Recreation for Patients  
 . . . . . *Maurice E. Linden, M.D.* 259

**NATIONAL RECREATION CONGRESS**

Highlights of the National Recreation Congress . . . . . 250  
 Public Recreation in Long Beach . . . . . *Duane George* 252

**ADMINISTRATION**

Location of Facilities for Senior Citizens Clubs  
 . . . . . *Ronald D. Johnson* 266  
 A Matter of Policy . . . . . 268  
 Research Reviews and Abstracts . . . . . *George D. Butler* 270

**PROGRAM**

Easy Ways to Change Partners . . . . . *Jane A. Harris* 261  
 Rhythm Groups in Rehabilitation  
 . . . . . *Leo Shatin and Wallace Kotter* 262  
 Nature Crafts Year 'Round . . . . . *Alice Howenstine* 264

**REGULAR FEATURES**

Things You Should Know . . . . . 246  
 Letters . . . . . 248  
 Reporter's Notebook . . . . . 255  
 Personnel—SOS! Danger Ahead . . . . . *W. C. Sutherland* 272  
 Books and Pamphlets Received, Periodicals, Magazine Articles 274  
 Index of Advertisers . . . . . 274  
 New Publications . . . . . 276  
 Recreation Leadership Training Courses . . . . . Inside Back Cover

# Recreating

for

# Fitness . . . . . Shane MacCarthy



Shane MacCarthy

**R**ECREATION must be recognized as an *integral part of life* if we are to attain proper individual standards of fitness. Those of you who are dedicated professional recreation leaders need not be “sold” on this fact. Unfortunately, however, millions of fathers and mothers, who today care for their children in creditable fashion, consider recreation as something to do when one has no important function to perform. They consider recreation as a frill or an appendage—too often classified as “fun.”

Even in the face of this prevalent interpretation, we are convinced that no undertaking has a greater opportunity and challenge in achieving fitness goals for youth and adults alike than does recreation. Human fitness is a compendium of many factors—mental, emotional, cultural, social, spiritual, and physical—blended in proportions so balanced that each person at a particular time and under certain circumstances will be able to perform to the best of his or her ability and capacity.

In the normal apportionment of time, we find work and non-work segments. There are some persons with seemingly bottomless reservoirs of energy who continue their work habits even while off the primary job and cease only for sleep. Where does recreation fit into such patterns of living? Too many would be prone to answer immediately, in shallow fashion, by saying that the economic demands of today prevent people from “being idle” when they could be doing something to add to their monetary resources. Others might respond that recreation can be embarked upon “at some future time” when they may have some opportunity “for less important things.” Many would say that recreation is “only for children who have nothing more important to do.”

All such responses not only ignore the fundamental meaning of recreation but at the same time show the dimensions of the task facing us in attempting to alert the nation to the need for total fitness of all our people. We realize that youth fitness will never be achieved unless the leadership of example of the adult population is seen in conspicuous fashion by our young girls and boys—and how can this be done unless we blast the very bases of erroneous meanings regarding recreation which have become en-cased in the minds of our citizens?

Merely to state that recreation is a necessary ingredient in attaining fitness will achieve little. It is more fundamental and essential for all leaders in our democratic society to understand the full dimensions and proportions of recreation as it fits into the context of current life. If parents, teachers, and those in government, labor, industry, builders, planners, and others could recognize that recreation is an integral and essential part of each one’s life, then the concomitance between it and fitness would be self-evident.

What function of the man is closer to the action of the infinite power of God Himself than the ability to *re-create*? In the multitudinous listings of dictionaries, no word exists which gives more credit to the capacity of the human being than his ability to take what God has made out of nothing by the process

---

DR. MACCARTHY is executive director of the President’s Council on Youth Fitness, Washington, D. C.

of creation and then try to renew it. Thus, recreating is not being idle and debasing the normal use of time available for leisure. It is a purposeful endeavor which can encompass every item performed by youth or adults, whether this be rest or activity, the development of tense competition in sport or the easy system of basking in the sun, the vigorous application of physical energy to win or the desire to admire the prowess of others. It may be the motivating force to accelerate the speed of the championship runner, or the wish on the part of the same individual on another occasion to take a leisurely stroll. Recreation may direct the interest of one human being in the joy of looking at masterpieces of art hanging on a wall, while another may be getting his recreation benefits and pleasures simultaneously by playing handball against the outer side of the same wall.

These are but a few observations to illustrate the vast span of divergent appeal in re-creating the human personality. Notice that running throughout these activities (and remember that sitting and gazing are activities when done by act of the will) is a deliberateness. In its manifold variety, recreation is a positive factor for achieving a purposeful, good goal. In this sense, it demands the thoughtful attention of each individual to the directing of himself, or herself, without the force of outside compulsion.

The civilization of today too easily provides ready-made, artificial pleasures demanding little effort or initiative. This by-product of automation affects all age brackets of our society and gives to recreation new demands and opportunities. For example, as recreation looks at the wonderful world of childhood, it expresses concern about all of the items of manufactured mechanization which are robbing children of the simplicity in play that is a powerful stimulant for the use of imagination. When, by pressing buttons, castles are lighted and their gates open and close, little initiative is left to the child to *create* his or her own castles in the air.

The trend in the adult field is to invent all sorts of items which will do for individuals what these same persons were compelled to do themselves not so many years ago. The further we get into the realm of mechanical contrivances, the more distant we appear to be from the benefits that come from simple recreation processes more closely akin to human endeavors. Though we now have the ability to be transported quickly from one place to another, we seem to get little recreation benefit in the tense process. Though the same journey took somewhat longer in days past, perhaps it provided the opportunity for the thoughtful recreation and beneficial conversation which is lost in today's hustle and bustle.

With the inevitable trend of giving to the human being more off-the-job time, and with the soft living habits which have become a part of the pattern of our civilization, you, as members of the National Recreation Association, have a necessary and essential responsibility to corral leadership forces outside your ranks to achieve the fitness of our youth and our adults. When you speak and write about recreation benefits, your deepest sincerity is suspect as "mere professional utterances." Thus, you have the task of ringing the doorbells of interest, which in our category are necessary alerts, to win disciples to the thinking that recreation is just as important for the human being as food and rest, and that, unless our citizens begin to school themselves in this manner now, the continuance of present thinking and present methods may make this task impossible of attainment in the future. We hope that the Thirty-Ninth National Recreation Congress will be the potential that leads to the fulfillment of this fitness goal. ■

## RECORDED TAPE

ONE STOP SERVICE

We carry all lines of stereophonic and monaural tapes.

EDUCATIONAL • BACKGROUND MUSIC  
GENERAL MUSIC TAPES  
TAPE PLAYBACK EQUIPMENT

Special discounts to recreation officers

Write on letterhead for free mail-order catalog.

**MAL'S RECORDING SERVICE**

Dept. RE, Box 37, Rockaway Park 94, N. Y.  
Phone GRanite 4-4607



## A FENCING PROGRAM

For 2 or 200. Requires minimum space and simple inexpensive equipment. We design and manufacture the best and least expensive weapons and accessories for beginners and experts. Let us help you set up a fencing activity or develop the one you have. Consultations free.

Write Dept. R for FREE CATALOG.

AMERICA'S OLDEST AND LARGEST IMPORTERS AND MANUFACTURERS OF

**FENCING EQUIPMENT**

30 EAST 10th STREET, N. Y. 3, N. Y. • GRamercy 3-6930

## Things You Should Know . .

CALLING ALL AMATEUR PHOTOGRAPHERS! If you are planning to take pictures at the National Recreation Congress in Long Beach, please keep RECREATION in mind for some of your informal action shots. We would like to see, especially, any good pictures taken at the "Rancho Roundup" at the Vessels Ranch on Wednesday evening, or any of the loading of buses for the tours, and so on. Magazine staff members Donaldson and Henly will be staying at the Hotel Wilton. Check with one of them if there are any questions.

▶ **PARK PRACTICE** is a program established in 1956 by the National Conference of State Parks with the assistance of the National Park Service. Ira B. Lykes is its chief, with offices at the NCSF headquarters, 901 Union Trust Building, Washington, D.C. The program is designed to aid in the dissemination of information on the planning, development, and management of parks and recreation areas. Park and recreation personnel at all levels of government are eligible to participate or benefit. Write to Mr. Lykes for further information.

▶ **HOW ABOUT A BOOK FAIR FOR BOOK WEEK**—November 17 to 23? The theme this year is "Explore with Books." Cooperate with your local library or with any already established book fair in your community. It's fun!

Helpful and still good is the pamphlet published by the Children's Book Council last year: *How to Run a Book Fair* by Dorothy L. McFadden. This is available from the council at 50 West 53rd Street, New York 19, for seventy-five cents. Send for it and for other Book Week materials—and be sure to specify the free folder, "Aids to Choosing Books for Your Children." (Members of the National Recreation Association will be receiving some of these items with their Membership Newsletter.)

▶ **IN THE MAGAZINES:** "Modern Man's Wearying Rat Race"\* in *Life*, July 15, 1957; "Could You Stand a Four-Day

Week?" by Robert Bendiner in *The Reporter*, August 8, 1957; "A measure of Fitness" by Dorothy Stulm, *Sports Illustrated*, August 5, 1957; "Is American Youth Physically Fit?" (the findings that shocked Eisenhower), *U. S. News and World Report*, August 2, 1957; "The Small-Town, One-Man Recreation Department" by Charles E. Hartsoe, *The American City*, July 1957.

▶ **STIPENDS FOR GRADUATE ASSISTANTS** have received a second increase at the University of Illinois this year. They are now \$900 for a quarter-time assistantship and \$1,800 to \$2,100 for the half-time assistantship. Recipients of these awards are also exempt from paying tuition. For out-of-state students—and most of the graduate students are from out of state—a quarter-time assistantship in recreation will mean \$900 for stipend plus \$550 for tuition and fees, or a total of \$1,450. Lucky students!

▶ **RECREATION MAGAZINE BIBLIOGRAPHIES** at the National Recreation Congress: Collected sets of the bibliographies on Congress topics will again be available at the Consultation Center. They have been brought up-to-date and are now fat and sleek and cost one dollar. A charge is necessary at last, because of publication costs, and we hope you'll think them worth it. Copies of the single listings are still free, however, and to be had for the asking.

▶ **A NEW FILM, *Planning Recreation Facilities***, will be shown for the first time at the Congress in Long Beach, by the Athletic Institute of Chicago. Produced by a longtime NRA member, Herb Price of Hollywood, California, the 16mm film is a color, sound motion picture which demonstrates, by the use of stop-motion animation of scale-model sets, the need for careful planning and supervision. It is especially designed as an audio-visual aid for recreation courses on the college level, but can serve as a resource for planners and recreation authorities. For purchase price and rental charges write the institute at 209 South State Street, Chicago 4, Illinois.

▶ **VISITS TO STATE PARKS** throughout the United States in 1956 went over the 200,000,000 mark, for the first time, according to a compilation recently completed by the National Park Service. Reports from eighty-nine state parks in forty-seven states provided this information. Survey figures are given in detail in *State Park Statistics—1956*, available from the National Park Service, Department of the Interior, Washington 25, D.C.

▶ **"YOUTH APPRECIATION WEEK"** is being introduced for the first time by Optimist Clubs, November 4-10, 1957, to give the normal, well-balanced boys and girls—who are too often identified with vandalism and hoodlumism—the credit they deserve. This pilot project was described in *The Optimist Magazine*, October 1956, and again in February 1957. The magazine is the official monthly publication of Optimist International.

▶ **AN ARIZONA STATE PARKS BOARD** was recently created by the passage of House Bill No. 72. The board consists of seven members, to include the state land commissioner and six other residents of the state appointed by the governor and selected for their "knowledge of and interest in outdoor activities, multiple use of lands, archaeology, natural resources and the value of the historical aspects of Arizona, and because of their interest in the conservation of natural resources."

Charles J. Reitz, superintendent of the Yuma Recreation and Parks Department, writes to Joseph Prendergast of the National Recreation Association: "Your letter to Hank Swan, as well as Jesse Reynolds' letter to Hank, was mimeographed and distributed to key legislators. The same procedure was used with letters written to me by George Hjelte, Howard Holman and Skip Winans.

"The person who is almost totally responsible for recreation features included in the bill is State Senator Harold C. Giss of Yuma. Senator Giss has been a friend of recreation for many years, and your letter, written to him during the last session of the legislature, provided the spark that gave him renewed vigor and determination to fight with increasing diligence for our cause . . . I wish to thank you for your assistance."

▶ **A CLINIC FOR PUBLICATION EDITORS** is scheduled at the National Recreation Congress for Thursday afternoon, October 3, at 2:15. Whether you do, or do not, publish any materials in your department or organization, you are invited to attend. Perhaps you can pick up some valuable inspiration or pointers. Come and see! ■

\* Excerpted from *Osborn On Leisure* by Robert Osborn (Simon and Schuster).

Year 'round Fun for Everyone...

# TARGET SHOOTING

*America's Traditional Recreation...*

More and more progressive communities are turning to TARGET SHOOTING as an ideal public recreation program. Recognized as the traditionally American sport, TARGET SHOOTING is fun for everyone because everyone — boys and girls, young and old, can participate.

Officials concerned with public recreation programs are invited to investigate the many advantages of the NRA's complete package Recreation Program. The package includes range plans, instruction manuals, a shooting program and complete information covering conduct of a safe public shooting range.

Be sure to visit our Exhibit Booth at the National Recreation Congress in Long Beach — or, if unable to attend this year's Congress, write for free packet containing details.

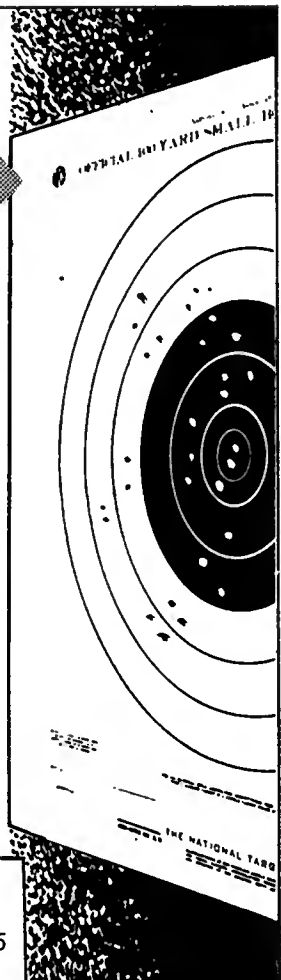

Write for  
FREE  
Packet

**NATIONAL RIFLE ASSOCIATION**  
1600 RHODE ISLAND AVENUE • WASHINGTON 6, D. C.

Visit  
Booth  
No. 65

# THE TRAMPOLINE IS A PIED PIPER



The day it arrives boys and girls of all shapes, sizes and ages miraculously appear from every direction. Children love the thrill of bouncing and flying through the air on a Trampoline. And they like the fact that the basic jumps are so easily mastered. They're experts in no time at all.

Trampolining is good for them, too. Provides excellent all-around conditioning exercise. It's the favorite new recreational activity at camps, Y's community centers, schools, and playgrounds.

Nissen Trampolines bounce better longer. Are sturdily constructed to take it and last. There's a model and size to fit your needs at a price to fit your budget.

AND IF IT ISN'T A **NISSEN** IT ISN'T A TRAMPOLINE\*

See your sporting goods dealer or write to—

**NISSEN TRAMPOLINE COMPANY**  
200 A Ave. N.W., Cedar Rapids, Iowa

**NISSEN TRAMPOLINE OF CALIFORNIA**  
479 W. 6th Street, San Pedro

\*Reg. U.S. Pat. Off.



AT LAST—  
a complete, easy-  
to-follow guide  
to square dancing

GENE GOWING'S  
THE  
**Square  
Dancers'**  
GUIDE

Now, you can get more fun out of square dancing with this practical book by Gene Gowing, Director of the world-famous Folkways Foundation. His new book, **THE SQUARE DANCERS' GUIDE**, is the first book that shows you not only how to become an expert square dancer, but also lets you in on the secrets of professional square dance calling!

Drawings, diagrams, and call-by-call instructions illustrate all the essential steps, movements, and patterns of folk dancing... show you the recommended way to follow any call.

Every fundamental movement and pattern is explained in detail, enabling even a beginner to dance the most intricate square dance sets. Calls, tunes, and sample programs for every kind of gathering are included.

A separate section gives full information and pointers for square dance leading and calling—information that will be especially useful to recreation directors, camp counselors, band leaders, and anyone who wants to get the most out of this wholesome, enjoyable recreation.

This handsomely bound 8½" x 11" volume is illustrated with over 100 drawings and diagrams. Order your copy of **THE SQUARE DANCERS' GUIDE** today, and before you know it, you'll be leading 'em as well as dancing 'em.

**54 FAVORITE DANCES** are described with full directions, calls, and easy-to-understand drawings and diagrams. Includes the Arkansas Traveler, Blackberry Quadrille, Red River Valley, The Boston Fancy, Spanish Circle, Maple Leaf Jig, The Lancers, Kentucky Running Set, Texas Star, and many others.

**ONLY \$3.95.** At all bookstores, or order from CROWN PUBLISHERS, Dept. C54, 419 Fourth Avenue, New York 16, N. Y. Save postage and C.O.D. charges by enclosing payment. Refund in ten days if not delighted.

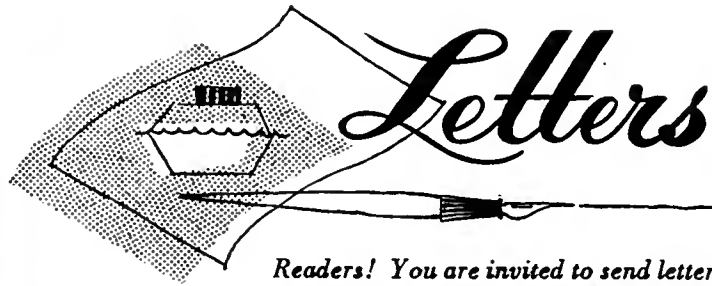

Readers! You are invited to send letters for this page to Editor, RECREATION, 8 West Eighth Street, New York 11—so that your ideas, opinions and attitudes may be exchanged with others on the wide range of subjects of concern to us all. Here is your chance to agree or disagree with the authors of our articles. Keep letters brief—not more than 250 words.

—The Editors.

**Congress City Sights**

Sirs:

Recently the people of Long Beach, California, (scene of the 39th National Recreation Congress, September 30—October 4, 1957) voted approximately five million dollars in bonds for park and recreation developments. Many of the projects included in this bond election are being completed now and will be on display for the first time as the Congress convenes. Much of this bond money is being spent to "green up" many undeveloped park areas. Sprinkler systems are being installed and landscaping work is going forward throughout the city.

A small-boat marina has just been completed in Alamitos Bay which connects with the ocean. This is the newest and one of the most modern marinas in southern California. It will be inspected during the Congress tour of recreation areas and facilities. Two buildings which will be used part-time as youth canteens are now under construction; as are several new park areas with attractive, although small, multiple-use recreation buildings, and a beautiful new baseball field with steel bleachers accommodating 3,800 spectators.

Delegates will be able to visit a downtown adult recreation center near City Hall where shuffleboard, cards, roque, horseshoes, chess and other games are played by large numbers of senior citizens. Near the auditorium where the Congress is to be held is an interesting "University by the Sea" forum club for adults where large groups meet each day to discuss the problems of the world. This area is also supervised by the recreation department.

These are but a few of the improvements which delegates may want to see.

WALTER L. SCOTT, *Director of Municipal and School Recreation, Long Beach, California.*

• See also the article, "Public Recreation in Long Beach," by Duane George, on page 250.—Ed.

**Camping Issue**

Sirs:

I would like to congratulate you on your very well done Camping Issue of RECREATION in March. There is so much food for thought throughout the entire issue, it should be a *must* for everyone working with or interested in camping.

We, of the National Association for Retarded Children, were particularly pleased to see the splendid article entitled "The Mentally Retarded at Camp" by Roland Larson. With the permission of NRA, we have had reprints of this article made for distribution purposes. The value of such an article is immeasurable in giving encouragement and help where it is needed. While this article is of special interest to us, there are several other extremely informative and useful ones which I believe will make this issue in great demand for some time to come.

It might be of interest to you to know that the NARC has a hard working camping committee which, in addition to two of our own representatives, is composed entirely of professional camping experts from other national youth serving organizations, including your own NRA. Through their efforts, a brochure of twenty-four concepts, entitled *Retarded Children Can Go Camping*, has been published for free distribution.

Although these concepts have been developed specifically with the retarded child in mind, many of them are applicable to all campers whether they are handicapped or not.

With all of this in mind then, and the picture that is depicted in your Camping Issue, it is surely most encouraging and indicative of real progress when so much sincere interest and thought is



being given to this ever-increasing leisure-time activity of this age.

KATHRYN G. GOULD, *Recreation Committee Chairman, National Association for Retarded Children, Inc., New York City.*

\* \* \* \*

Sirs:

Congratulations to you on the March issue, devoted to camping. I wanted to say "bravo" and "amen" in the same breath after reading Eugene Swan's article on "What are Today's Campers Missing?" Then I turned the page and the picture on page 74 is shouting evidence of the emphasis which Mr. Swan deplores. It is really too bad that the pictures at the bottom of page 75 could not have traded places with the trampoline activity.

I realize that picture editors are not always aware of the program emphasis of the pictures they select. I am particularly disturbed by the illustration of Lewis Reimann's article on "Campsite Selection, Layout and Development." The three-story lodge on page 85 is exactly what we are trying to get away from.

I realize that I am overly sensitive at these points. I am now working with some seventy-five camps, many of which are starting from scratch and want to build in keeping with the current trend in the out-of-doors as reflected, for example, in our suburban housing developments. This means openness and space between buildings.

Perhaps our stress on the necessity for sports in the camping setting has made us less aware of the fact that discovery is re-creation, also. It seems to me you missed a chance on nature games and I wish you had included, at least in your illustrations, some concern for the child becoming at home in the out-of-doors.

MAURICE D. BONE, *Counselor in Camping, Board of Christian Education of the Presbyterian Church, Philadelphia, Pennsylvania.*

• We thought we showed, in the emphasis in our March issue, our concern with the honest values of life outdoors—a world of campfires, woodlands, nature, adventure, outdoor education, as against life and recreation activities in the city or indoors.—Ed.

**SUBSCRIPTION RATES**

|                                                                  |        |
|------------------------------------------------------------------|--------|
| 1 year                                                           | \$4.00 |
| 2 years                                                          | 7.25   |
| Foreign                                                          | 4.50   |
| Library subscriptions                                            | 3.70   |
| Club subscriptions                                               | 3.50   |
| <small>(Ten or more individuals subscribing at one time)</small> |        |
| RECREATION MAGAZINE                                              |        |
| 8 West Eighth Street, New York 11, N. Y.                         |        |

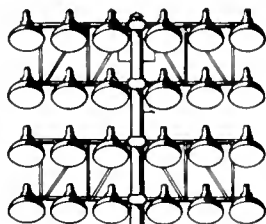

# MONOTUBE Floodlighting Poles

*proved by experience  
and acceptance*

If you are planning the development or modernization of sports, recreational, commercial or industrial areas, Monotube floodlighting poles will help you make full use of nighttime hours.

Available in heights up to 100 feet, Union Metal Monotube poles are designed, engineered and produced by a company specializing in pole manufacture for more than half a century.

Monotubes offer attractive appearance, exceptional strength, minimum maintenance, quick and easy installation . . . *and no guying required.*



To learn more about Monotube floodlighting poles, steel or aluminum, write to The Union Metal Manufacturing Co., Canton 5, Ohio for catalog information. In Canada: The Union Metal Manufacturing Company of Canada, Limited, Brampton, Ontario.

**UNION METAL**  
*Monotube Floodlighting Poles*

Digitized by



Robert E. Richards



W. Ballentine Henley

# HIGHLIGHTS

of the

## *National Recreation Congress*

Long Beach, California

September 30 - October 4



Aerial view of Alamitos Bay — Long Beach in background.

**F**IVE EXCELLENT speakers will set the pace and highlight the exciting program planned for the 39th National Recreation Congress. This major event of the year for recreation people will have "something for everyone." Inspirational addresses, discussion groups, workshops, clinics, demonstrations and exhibits will cover all phases of recreation. Whether your interests are in a specialized area—such as program, personnel, administration; in rural, urban, industrial, military or hospital recreation; for tots to senior citizens—or in the broad over-all philosophy of recreation, you'll get the latest ideas, trends, and professional stimulation at Long Beach. See you there September 30-October 4!



Paul F. Douglass

REVEREND ROBERT E. RICHARDS, minister-at-large for the Church of the Brethren, will address the opening session on Monday morning on "Recreation for a Strong America." A renowned athlete, he has been on three Olympic teams and has won twenty-two national championships. In 1956 the U. S. Junior Chamber of Commerce selected him as one of the ten outstanding young men of the year.

DR. W. BALLENTINE HENLEY orator, educator, and civic leader will address the Tuesday evening general session on "Exploring New Recreational Frontiers." Dr. Henley has earned academic degrees in law, government, religion, and history. He is president of the Los Angeles College of Osteopathic Physicians and Surgeons and a member of the Los Angeles, American, and California Bar Associations. Dr. Henley is under the sponsorship of General Motors Corporation.



Vierling Kersey

DR. PAUL F. DOUGLASS, educator, author, speaker, and government consultant, needs little introduction in the field of recreation for he is a noted lay leader of the movement and chairman of the National Recreation Association National Advisory Committee on Recruitment, Training and Placement of Recreation Personnel. His address at the Thursday morning general session will be "The Next Hundred Years."

DR. VIERLING KERSEY, an active member of the Los Angeles City Recreation and Parks Commission, is well qualified to give the Congress banquet address Thursday evening on "Citizens Offer Leadership in American Recreation." He is an outstanding educator, president of the Los Angeles College of Optometry, and is interested in the promotion of new frontiers in recreation, outdoor enjoyment, and safe vacationing.



Harold W. Kennedy

DR. HAROLD W. KENNEDY, the counsel for the County of Los Angeles, will address the Friday morning general session on "The Philosophy of Recreation and Its Legal Aspects." Dr. Kennedy, a recognized authority on public law, is the author of numerous articles in this field, among them "Revenues from Federally-Owned Property" and "Municipalities and the Law in Action." A scouting enthusiast, he has been associated with the Boy Scouts of America for forty-five years. ■

*Superior By Every Comparison!*



So sensationally better are they on every count—design, construction, quality, durability and play-ability—that Rawlings HERCULITE Rubber-Covered Athletic Balls have established a new high standard. They're in a class by themselves—they're...

*"The Finest In The Field!"*

- VOLLEY BALLS
- BASKETBALLS
- SOCCER BALLS
- FOOTBALLS

RAWLINGS SPORTING GOODS CO. • St. Louis • Los Angeles • Dallas • Chicago

for the finest

# PLAYGROUND EQUIPMENT

specify

# Jamison

Safety En-J-neered

## EQUIPMENT



While at the Convention

**VISIT** the Jamison plant . . . inspect the rigid production controls that guarantee safe equipment.

Transportation provided — ask Mr. Jamison at the Convention or call PLeasant 3-2682.

# Jamison

MANUFACTURING COMPANY  
8800 S. METTLER ST.  
LOS ANGELES 3, CALIF.

For ideas that appeal to the  
**IMAGINATION**  
and provide hour-after-hour  
**FASCINATION**  
for primary through adult  
**RECREATION**  
using the material  
that's a low-cost color  
**SENSATION**  
*Dennison Flameproof  
Crepe Paper*

**BUY THESE ILLUSTRATED  
32-PAGE BOOKS  
ONLY 50¢ EACH**

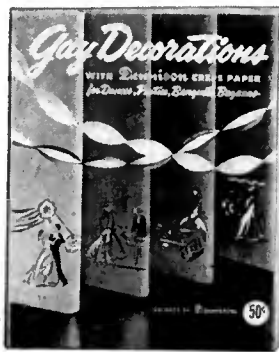

# Dennison

Manufacturing Co., Dept. W-189,  
Framingham, Massachusetts

Enclosed is \$..... for (please indicate number of copies) .....

Gay Decorations (50¢)  Fun with Crafts (50¢)

Name .....

Address .....

City.....Zone....State.....

**P.S. YOU ARE INVITED** to visit Dennison Booths—Nos. 46 and 47—at the National Recreation Congress, Long Beach, Calif., September 30th to October 4th.

Duane George



The Friday Nighters Club for junior high school boys and girls makes public use of Long Beach school gymnasiums from seven o'clock to nine-thirty.

Rather than present a sort of "alphabet soup" by listing all activities in the diversified public recreation program in Long Beach, California we are highlighting only certain ones here—not because they are new but because their "flavor" may be different or distinctive.

*Sharing—the Key to Planning.* The obligation for Long Beach's comprehensive public recreation program is accepted as a shared responsibility. An employee planning group is composed of twenty members who represent all divisions and activities of the municipal and school coordinated recreation program. It is convened at intervals when a sounding board is needed for administrative ideas, for planning improvements or for offering new suggestions. From this group's comments and reactions, recommendations for changes in policy or improvements in procedures are determined. By rotating the planning group membership many employees have opportunity to participate.

The group devises in-service education emphases so that training sessions are a reflection of employee needs. To further stimulate interest and maintain realistic training, capable recreation directors are assigned to committees which prepare the content of training sessions, and their abilities as instructors are utilized. These sessions are scheduled continuously the year round, except during the busy summer months.

MR. GEORGE is assistant director of recreation in Long Beach, California.

Sharing extends beyond the school-municipal framework, inasmuch as the group work and recreation division of the Community Welfare Council serves as a clearing house for all public and private recreation matters. Two specific examples are:

1. The support of the day camp sub-committee which has made a careful study and maintained constant vigilance to assure the development of day camp sites that can be used by all agencies. This support has been helpful in terms of both promotion assistance and interpretation of needs.

2. The annual publication of an in-town summer program calendar presents the total offering of all public and private organizations and is an outgrowth of the coming together of representatives from each of the youth-serving and recreation agencies.

*Employee Organization Stimulates Interest.* Since inception of the coordinated plan, school and municipal employees have been responsible for an effective social and professional advancement program which serves all employees. The Long Beach Recreation Association takes the lead in planning special events for employees and their families, participates actively in the professional advancement part of each general employees' meeting, and sponsors projects that stimulate interest in increasing the department's effectiveness. Through money-raising affairs, funds are contributed by this group for services not available from public tax funds, such as hospitality during conferences, refreshments for the Play-

ground Leaders Council special events, and a scholarship fund for recreation majors. The program committee chairman for the recreation association is automatically a member of the department-sponsored employee planning group.

Another interesting liaison is the "new idea" program, sponsored by the recreation association, which recognizes suggestions for improvement of program or procedures within the school-municipal operation.

*New Games Add Spice.* With inventive impetus from the director of school and municipal recreation, a recreation leader skillful with tools is employed in the maintenance shop to construct new games and improve old ones. Acting on suggestions from a municipal-school games committee, he experiments with innovations which are tested on playgrounds until they are satisfactory; then, duplicates are made. These games are rotated from playground to playground and returned, periodically, to the shop for repair and repainting. Most of the games are playable in limited space and all of them are easy to set up and take down daily.

Suggestions for purchase of games not already carried in stock are referred to the games committee for preliminary experimentation to determine appeal and durability.

*Traveling Specialists and Strength.* Skilled leaders in crafts, drama, rhythms, puppetry and music are assigned by supervisory personnel to function in a dual capacity: first, as face-to-face leaders where large groups are assembled for instruction, and, second, to help playground leaders improve their leadership skills in these activity fields. The emphasis on face-to-face leadership holds during the ten weeks concentrated summer program.

*Publicizing the Program.* In addition to the usual media of newspapers,

# Recreation in Long Beach

These interesting aspects of the local municipal and school coordinated programs illustrate an effective and successful sharing of responsibilities in the National Recreation Congress city.

the recreation department provides a mimeograph service for the use of community recreation leaders. Bulletins printed with multi-colored ink, silk screen posters, and quantities of program announcements are continuously made available for display and distribution.

At the local playgrounds, special in-service education sessions are conducted on the effectiveness of using bulletin boards. The weekly bulletin from the office of the superintendent of school, the junior and senior high school student newspapers, the daily announcements on the public address systems in the high schools, and the daily distribu-



Another group brushes up on basketball on Will Rogers Junior High playground.

tion of school mail by messenger all serve as avenues for publicizing public recreation. Distribution of bulletins in classrooms to all school-age children is readily possible through advance approval from the school superintendent's office. The Long Beach Unified School District educational radio station KLON is another usable medium.

*Employee Aids are Important.* Beginning with nine hours of paid orientation for all new employees, a number of working tools placed at the disposal of each worker helps assure effectiveness. Clearly stated operating policies form the content of the *Employees Handbook for Municipal and School Recreation*. This provides quick reference for all personnel. Each summer, as a

special adjunct to program operation, a sixty-page mimeographed manual containing a master calendar of activities, personnel assignments, schedules and program outlines is given to each employee. A large printed calendar form for each month is also available and serves as a reminder of the events scheduled in advance. Its large size permits the writing in, by each playground or center, of other program items. In addition, a four-page mimeographed publication, *What's New*, is distributed twice monthly—with the pay checks. It keeps communications open between administration and field personnel.

A library of recreation books, magazines and bulletins is available in the assistant director's office. Those containing the know-how of games and other activities are distributed to the activity leaders and a supply is maintained at the central office.

To further maintain employee status, the employee planning group has developed standard wearing apparel—not



Elementary school youngsters like after-school play, too. Grounds are well kept.

a prescribed uniform, but practical clothing suitable for activity leadership. A plastic identification badge, with the leader's name in large type, completes the identification.

*Playground Leaders Council.* Using the slogan, "If you don't have a playground leaders council, you are working too hard," each playground director is ad-

vised to organize a young leaders' group. Varying in size from six to ten, these groups are made up of elected leaders who serve as chairmen of various committees concerned with different activities and responsibilities. This gives the recreation director a chance to keep informed regarding the wishes of participants and gain helpful volunteer assistance, while providing an opportunity for the children to grow in leadership. Members of the playground leaders council receive appropriate identification, meet weekly or more frequently to plan and evaluate the program, and receive appropriate recognition through means of certificates and at the annual "playday."

## Program

*ADEX Meets a Need.* ADEX (adult excursions) is a club designed for single adults over twenty-one years of age. Although organized informally, it provides a means for field trips to local and out-of-city points of interest more easily visited by a group than by unattached individuals. Similar clubs for married people and for senior citizens are now being planned by the recreation department.

*Youth Clubs Popular.* Youth clubs are divided into two groups, the Canteen Clubs and the Friday Nighters. Canteen Clubs are designed to meet the recreation needs of older teen-agers—the senior-high-school-age group. ➡



All ages turn out. Above, a sample of activity at the Downtown Roque Club.



Members of the Downtown Adult Club enjoy on old standby—a game of cards. Games, indoors or out, are among the favorite activities of all groups.

Young people not attending high school but living in the school district of the youth club, and under twenty years of age, may become associate members.

The Friday Nighters are conducted for eighth and ninth graders at each junior high school on alternate Friday nights during the school year. The evenings are devoted to social dancing and other party activities.

A different type of group participation for the teen-ager has been enthusiastically received by junior and senior high school students. This is the co-recreational fun night held in the gymnasiums of various junior and senior high schools. Natural leaders from the school's faculties are employed by the municipal recreation department to direct these.

*Government of Friday Nighters.* From the faculty of the school where the program is carried on, one director and two assistant directors are selected, and paid from the public school recreation funds. They meet with the youth committee of the school and plan the program, run the mixers and select the recordings. The PTA chairman is active with the Friday Nighters and secures the patrons and patronesses.

*Government of Canteen Clubs.* Youth club members assume important roles in planning, organizing and administering club activities. Each club has an executive committee of young officers whose meetings are attended by at least one adult director.

An advisory board includes youth club executive committee members, the paid adult leader of the club, representatives from the municipal and school

recreation departments, the PTA and the school principal specifically involved. The recreation department's director of youth clubs serves as chairman. *Camping and Youth Clubs Coordinated.* Municipally owned Camp Hi-Hill, a mountain camp, is used for outdoor education by the public schools. The instruction staff and food preparation are provided by the Long Beach Unified School District, and maintenance personnel, maintenance supplies and utilities are carried by the city recreation budget. Other public use on weekends is reserved for family groups under direction of the municipal recreation department.

Similar to the city's use of school gyms, one of the city-financed youth clubs occupies board-of-education land on a dollar-a-year lease for thirty years. *Recreational Swimming.* School swimming pools are administered by the municipal recreation department for public recreation use when not used for school purposes. The charges are twenty-five cents for children through high school, and fifty cents for adults. Suits and towels are furnished by the board of education which receives all admission money. Board of education employees "man" the locker and shower rooms and the city recreation department assigns the swimming instructors and pool attendants (lifeguards). The recreation swimming program is scheduled in five enclosed pools on a year-round basis and in the city college "open" pool for daytime hours for ten weeks during the summer. At public beaches free instruction is provided by the recreation department.

To publicize these opportunities, teams of lifeguards show water safety motion pictures at every elementary and junior high school during April and May. They see that every youngster receives a printed sheet telling him where to learn to swim.

*Sports for Junior High Age.* Designed to meet the needs of highly skilled youth through vigorous competition without exploitation, Saturday athletic contests are organized jointly by the municipal sports supervisor and an assistant supervisor of physical education. These are an outgrowth of the schools' instruction program and after-school intra-mural schedule for junior high schools.

Recreation leadership for the teams is provided by physical education teachers of the junior high schools with school district funds. These men are employed after school at play directors' hourly rate of pay. On Saturday they are employed by the recreation department at the regular municipal play directors' rate. School facilities are used for the games without cost, supplies are provided by the recreation department.

*Youth Talent Showcase.* Young people are eager to serve and anxious to be recognized. The recreation department's "Youth Talent Showcase" affords them an opportunity for the expression of abilities and talents in neighborhood programs. By circulating application cards through elementary and secondary schools, a central talent file, classified by kinds of entertainment, is maintained in the recreation department central office. Following informal auditions where each performer is encouraged and assisted by the adult leaders of the audition committee, notations are entered on each applicant's card for later use in organizing talent shows in all districts of the city. Each participant receives a certificate of award when he appears in one of the neighborhood or city-wide productions. All audition records are confidential and there is no obligation for a performer to accept an invitation to make an appearance. Parent-teacher organizations, service clubs and church groups who request their assistance in programs are referred directly to the young performer or to his parents. ■

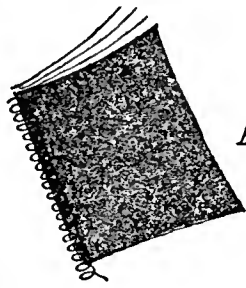

## A REPORTER'S NOTEBOOK

### People in the News

HAROLD L. TEEL, SR. has been appointed to the newly created post of chief deputy director of parks and recreation for Los Angeles County, California. Mr. Teel has been in professional recreation since 1932 and is a past president of the California Recreation Society.

WALTER L. FOWLER, a member of the recreation board in Washington, D. C., since 1941, received an NRA Recreation Month citation for his notable service to recreation. Mr. Fowler, who is the District Budget Officer, has made many contributions to civic and community life. A recent significant talk by him was introduced into *The Congressional Record*. NRA executive director, Joseph Prendergast presented the citation at a District Board of Commissioners meeting in June.

CHARLES HARTSOE, an administrative employee in the Philadelphia Recreation Department, has received the first certificate awarded under the NRA National Internship Training Program begun in 1956. He received the certificate from Mrs. William L. Van Alen, NRA Board vice-president.

LOU EVANS has retired after forty-five years of service with the park department in Seattle, Washington. This will break up the beloved brother team of Lou and Ben Evans. The latter is head of the Seattle department.

### Youth Fitness

The President's Council on Youth Fitness will convene at West Point, New York, on September 9-10 for further study of this all-important problem. Dr. Shane MacCarthy (see his editorial on page 244) is the council's executive director, with Ott Romney as assistant director. NRA's Joseph Prendergast is on the Citizens Advisory Committee.

### Hats-Off Department

⊕ The city housing agency in Vancouver, Washington, has made sure that the new 1,000-acre McLoughlin Heights residential area is being developed as an integrated part of the city's future expansion pattern. Neighborhood park and playgrounds are spotted throughout the development which will have one community-wide park and greenbelts.

⊕ In northeastern Pennsylvania a long-proposed reservoir at Wallpack Bend has been reconsidered by Army engineers after a new study showed that Tocks Island in the Delaware River would not only provide a more economical site but its longer shoreline would provide "more recreational opportunities."

⊕ North Carolina is developing 464-acre Mount Jefferson State Park in the northwestern part of the state, accessible from the Blue Ridge Parkway.

⊕ The New Jersey Highway Authority has beautified its Garden State Parkway with 328-acre Telegraph Hill Park, a former Indian smoke-signal point.

⊕ Officials in Westchester County, New York, have rejected repeated bids from the city of New Rochelle to convert part of the Nature Study Woods beside the Hutchinson River Parkway there into a high school stadium. Meanwhile the county, which has been restricting its recreation facilities to local residents, agreed to turn over 650 acres of Mohansic Park for a new state park, open to all. The acreage will be augmented by 150 acres of adjacent New York City water supply land. Westchester County was recently bequeathed a 175-acre tract, adjacent to the Ward-Pound Ridge Reservation, for use as an arboretum.

Superior Design,  
Construction and  
**PERFORMANCE**

far greater  
strength and  
**SAFETY!**

**AMERICAN**  
*Approved*

**PLAYGROUND  
AND SWIMMING  
POOL EQUIPMENT**

The wise choice of experienced  
buyers for nearly half a century.

WRITE FOR LITERATURE

**AMERICAN**  
PLAYGROUND DEVICE CO.  
ANDERSON, INDIANA, U. S. A.

WORLD'S LARGEST MANUFACTURERS OF FINE  
PARK, PICNIC, PLAYGROUND, SWIMMING  
POOL AND DRESSING ROOM EQUIPMENT

**Exciting x-acto**  
**SUJI WIRE ART for**  
**GROUP ACTIVITY**

• **Inexpensive!**  
• **Fascinating!**  
• **Simple-to-do!**

This SUJI Cowboy  
made in minutes.

Just a few turns of colorful SUJI wire produces exquisite figure miniatures, ornaments, jewelry, party favors...the most excitingly new craft activity for individuals or groups. **INEXPENSIVE** ...less than 10¢ worth of materials for a simple project.

SPECIAL GROUP  
OFFER  
Try-it-yourself SUJI  
Sample Pack with a  
generous supply of  
wire, glue, tools and  
instructions ..... 25¢

**x-acto**

**X-ACTO, INC.**  
48-99 Van Dam Street  
Long Island City 1, N. Y.

# Sure-Fire Safety in Riflery



Boys in Fayetteville, North Carolina, have a BB gun club and are taught wildlife protection. Fayetteville is a bird sanctuary.

## WHAT'S DOING in Community Programs

In recent years, the rifle club program has grown in favor in community recreation departments able to provide the careful supervision and safety precautions which are a *MUST* in such an activity. The clubs attract boys and girls, men and women, and family groups as well. Air rifles are used widely with the junior groups.

There is a stimulating satisfaction in hitting a target—be it with a gun, bow and arrow or merely a dart—which leads on to the perfecting of skill. You can compete with yourself or compete with others—in the latter case, a club is born.

The first activity in a community riflery group, or any shooting group, is a lesson in proper gun handling, and a setting up of safety rules,\* such as the following which are used in ranger training:

### The Ten Commandments of Safety

1. Treat every gun with the respect due a loaded gun. This is the cardinal rule of gun safety.
2. Carry only empty guns, taken down or with the action open, into your automobile, camp and home.
3. Always be sure that the barrel and action are clear of obstructions.
4. Always carry your gun so that you can control the direction of the muzzle, even if you stumble.
5. Be sure of your target before you pull the trigger.
6. Never point a gun at anything you do not want to shoot.
7. Never leave your gun unattended unless you unload it first.
8. Never climb a tree or a fence with a loaded gun.
9. Never shoot at a flat, hard surface or the surface of water.
10. Do not mix gunpowder and alcohol.

\*These, as well as suggestions for organization of clubs and operation materials, such as score sheets and targets, are available from the National Rifle Association, a non-profit service agency, 1600 Rhode Island Avenue, N. W., Washington 6, D. C.

Knowledge about the use of a rifle range comes next. Some of the experiences of community groups follow.

### The Long Rifles

The children at Loring Air Force Base, Maine, have a new rifle club, the Long Rifles, which attracts about fifty boys and girls. Organized under the direction of officers and airmen, it is now a member of the National Rifle Association. Its purpose is "to teach proper gun handling, in the hunting field and in the home, and to teach sportsmanship because sportsmanship and safe hunting go hand in hand." *Primary Rule:* A student who lacks respect for others, or is unwilling to accept group discipline, has no place in a hunter-safety class or in the world of sportsmen.

A skeet and trap group meets during the summer months. Regular meetings are spiced with range sessions, sport and shooting films and sociability. Club members have sleeve emblems depicting a B-52 crossed with a rifle and bearing the legend "Long Rifles—Loring AFB, Maine."

### Demerits

Separation from the club may be achieved at the request of any member or by the accumulation of a total of twenty demerits, listed in the club constitution as follows:

1. Horseplay with weapons—fifteen demerits; horseplay during classes—five demerits.
2. Pointing a weapon at another individual—fifteen demerits.
3. Absence from meetings—five demerits.
4. Shirking of duties—five demerits.
5. Infraction of the range rules—five demerits.
6. Failure to leave the weapon in proper configuration (bolt open when in rack or action open if not a bolt action weapon)—five demerits.
7. Profanity on the firing line or within the confines of the range, or within the body of a regular meeting of the club—two demerits.



The following are from lesson outlines for the first four meetings with the children. All these points were covered and demonstrated, and the children tested before being permitted to enter the range and fire.

**LESSON ONE.** Safety in the field: Methods of carrying weapon (alone and with groups); methods of crossing fences (alone and with groups); carrying a weapon in the car; storing weapon in the closet; hunting a field in groups (up to three); stalking game; the crawl with the weapon.

**LESSON TWO.** *Exam:* Safety in the field and ten commandments; explanation of line of sight, line of bore, and path of projectile; cause of propulsion of projectile and twist; triangulation; make triangles and correct sighting picture with bars and discs.

**LESSON THREE.** Trigger squeeze and method of holding breath to prevent wavering of weapon; sight adjustments for elevation and lowering of the shot group; windage and effect of wind on the projectile; range rules.

**LESSON FOUR.** Explanation of range procedures and rules, including stacking of weapons on rack when not in



**Junior Rifle Club using rifle range managed by the Metropolitan Park District in Tacoma, Washington. District's indoor range has twenty-three firing points.**

beginning: "One of our members of the Canterbury Belles 4-H Club was interested in having a group of senior members (girls over fourteen) form a rifle club and so she was appointed project leader. L. Harold Bullock, an ex-Army man, was secured as instructor.

"This was in May 1956. We invited all boys and girls in town between the ages of twelve and eighteen to join us. The Canterbury Belles 4-H Club and the Sunset Mountain Fish and Game Club are our sponsors and permit us use of their rifle range.

"In the winter we meet in the church vestry, using air rifles for target practice. When the weather permits, we will be using the rifle range again, returning to the use of '22' rifles." The club now includes a course in hunter safety.

### Class Attendance Required

The department of recreation in Mount Clemens, Michigan, has a junior rifle program open to boys and girls aged twelve through eighteen. Shan Cousrouf, a member of the National Rifle Association, is volunteer instructor.

All members are required to attend a six-week series of classes on safety, nomenclature of rifle and ammunition, correct firing techniques and proper range procedure. At the end a written examination is given all members.

The club is affiliated with the National Rifle Association and the members compete weekly to earn individual awards for marksmanship. So far the girls have surpassed the boys. The club is also affiliated with the Office of Civilian Marksmanship and club members fire the prescribed course for junior rifle clubs affiliated with the OCM.

The club fires into bullet traps in a gymnasium, allowing a minimum of eight firing points. The city provides seven rifles. Additional rifles are available for loan from the Office of Civilian Marksmanship. The program began with twenty-six members and has grown to fifty-eight. An adult program will start this fall.—FRED M. MERRILL, *Director, Recreation Department, Mount Clemens, Michigan.*

### Father-Son Shoots Held

The recreation commission in Emporia, Kansas, sponsors an indoor junior rifle program under the auspices of the National Rifle Association. It was organized two years ago in cooperation with the local National Guard armory. The



**The children at Loring Air Force Base, Maine, learn proper gun-handling and safety in Long Rifles club.**

use. Fire fifteen rounds each student: five for sighting and five and five for breath control and trigger squeeze. Last ten can also be used for sight alignment. Fire *prone* position.

### Sunset Mountain Junior Rifle Club

"I visited a weekly session of the rifle club in Canterbury, New Hampshire, recently," reports a National Recreation Association representative, "and it is unusual in many ways.

"When I walked into the church vestry of the old colonial town of Canterbury it seemed that time had suddenly turned back fifty years! The room was small, heated by a stove, and whole families were gathered there. There were brothers, sisters, mothers, and fathers of the youth participating, and adults either watching or assisting. Chairs were all lined up on one side and the other half of the room was set up for shooting. Shooting mats were blankets, target backstops were cardboard boxes filled with crumpled paper and backed with tin.

"The Canterbury area has a scattered population of seven hundred and fifty citizens, and the club has forty members!"

Mrs. Alice Thompson, club leader, tells the story of its



Some of the rifle clubs report that the girls surpass the boys! These junior misses are members of the unusual rifle club in Canterbury, New Hampshire.

recreation commission provides the club leader who handles the organization and publicity for the program. The National Guard furnishes the instructor from their unit, who is paid by the recreation commission.

The program, for boys twelve to nineteen, is conducted at the National Guard armory indoor range. Adult volunteers with knowledge of small arms are encouraged to help whenever possible. At least one father-and-son shooting contest is held each season to encourage closer father-son relationships.

The boys are also taught proper care and handling of all small arms. Safety is of paramount importance in a program of this type. They are not allowed to bring or take live ammunition to and from the armory. The club leader supervises distribution of ammunition during shooting periods.—JAMES A. PETERSON, *Superintendent of Recreation, Emporia, Kansas.*

### Civil Rifle Range

In Tacoma, Washington, a rifle range is operated under the management and control of the Metropolitan Park District. Permits are issued to approved rifle and pistol clubs by the superintendent of public recreation. While clubs are using the range, provision is also made for any other individual to shoot at assigned firing points, unless this interferes with scheduled matches, and providing such person complies with the safety rules and obeys the orders of the range officer in charge.

This is an indoor range with twenty-three firing points, all located on the second floor of an old building. It was constructed through the joint efforts of the rifle and sportsmen's clubs and the park board. The clubs raised about \$4,000, and the board contributed labor, lumber, and other materials and funds.

*Issuance of permits.* A club may be granted a practice night in addition to time for matches. In case two or more clubs are allotted the same periods one club is designated as in charge and acts as host club. All others shooting do so under the auspices of the host club and are subject to the orders of the host club's range officers. Applications for permits must be in writing and approved by the superintendent of public recreation. Permits may be refused or revoked at the discretion of the superintendent if he finds a

club does not present sufficient evidence of responsibility, has unqualified representatives or has failed to obey or enforce these rules or the safety rules.

*Fees.* From the beginning it was suggested that a flat range fee of twenty-five cents be charged each person on each occasion that he used the range; however, the facilities are also used one evening a week by the high school rifle teams, and no charge has ever been made to these juniors. The range has brought in an income of approximately \$800 per year from the charge to the adults. It is known as the only self-supporting activity at Point Defiance Park today. The funds collected have been used for needed improvements and to defray operating costs.

### Other Programs

- The Brunswick, Maine, Recreation Commission runs a weekly junior riflery program from September through March. Some sixty-odd youngsters, twelve to seventeen years of age, learn the fundamentals of hunting safety and marksmanship under experienced leadership, at practically no cost to the town. Ammunition is donated for the program, and reserve officers volunteer their services as instructors. Rifles are supplied by the ROTC unit at Bowdoin College. The Brunswick Naval Air Station and a ROTC sergeant worked on and improved the safety aspects of this fifty-foot indoor range. It is one of the community's most popular recreation assets.

It consists of five positions with spotlights on the targets, control lighting, individual lockers, marking tables, and wheel-operated target carriers. This is one of the finest facilities of its kind in Maine.—PENNEL S. EUSTIS, *Director of Recreation, Brunswick, Maine.*

- The rifle club at St. John and St. Joseph Home (for dislocated children) in Utica, New York, is made up of sixteen boys aged nine to thirteen, who meet every Friday night. Instruction is given in safety, care of rifles and marksmanship, and target shooting. The club is affiliated with the National Rifle Association and is eligible to shoot the Official NRA Junior Fifteen-Foot Air Rifle Qualification Courses to earn national riflery awards.

Riflery is probably one of the most successful programs conducted by the home's volunteer worker guild.\*\* and the boys develop a very healthy respect for "shooting irons."—JOHN E. DAPRANO, *Group Worker at St. John and St. Joseph Home, Utica, New York.*

- Fayetteville, North Carolina, is a bird sanctuary and there is a fifty dollar fine for any boy shooting a rifle in the street; so the recreation and parks department is trying to give them a place to use their BB guns, as well as encourage the protection of wildlife.

Shooting instruction is given to boys who would not normally participate in baseball and football because of their youth. Proper handling of a BB gun and all important safety factors is emphasized. This program is conducted only during the winter months.—SELWYN ORCUTT, *Superintendent, Recreation and Parks Department, Fayetteville, N. C.* ■

\*\* See "Volunteer Workers in a Recreation Program," RECREATION, December 1956, page 478.

# New Vistas in Recreation *for Patients*

Maurice E. Linden, M.D.

The new pattern of care in mental hospitals, through the use of tranquilizing drugs, and its implications for recreation—as based upon the observations of the author and other administrators.

THE USE OF the newer drugs, particularly tranquilizers, is changing the pattern of care and treatment in mental institutions. Thousands of patients formerly regarded as chronically ill and relatively hopeless, and to whom only custodial care was given, are now seen in various stages of rehabilitation in many mental hospitals.

Some observers point out that we are currently in an exciting period in hospital history. We are witnessing changes in social attitudes toward the mentally ill; and it is to be noted that into the hospital therapeutic atmosphere are now brought programs of group therapy, activity and recreation, socializing influences, new patient freedom and new concepts in intergroup relationships. All of these are associated with the impact that the newer drugs have brought to bear upon the systems of therapy and research in psychiatry.

Mentally ill persons, who for many years lived exclusively within the drab confines of locked wards and regressed ever more deeply into private worlds of self-isolation, asociality, and unreality, are now found engaging in a great variety of activities, including sports and games, supervised and unsupervised

group play. More such wards are being opened daily in hospitals throughout the country.

It is well known, of course, that patient freedom, in and of itself, is not curative. The progressive point of view entertained by mental hospital administrators today holds that freedom in the mental institutions really implies freedom to *do* something. As one psychiatrist has put it, there is freedom "to make a choice of work, of occupation, of recreation . . . and how to handle the situations that arise out of liberty."

The new therapeutic measures, with the important effects that they have had upon patient welfare, do not by any means simply account for an intensified and accelerated rate of discharge of patients, as though through some magical transformation of the people thus treated. Successful therapies produce new needs. Patients who for years have been regarded as chronic must now be helped to become acquainted with a whole new world that has developed around them during their imposed absence. These mental immigrants must be educated and trained to resume citizenship in the world of reality. They must be helped to find, for example, that new customs, fashions and traditions have appeared on the community scene. Yet, of even greater importance is the need of such patients to be aided in rediscovering the subtle and refreshing pleasures in coordinated use of their

bodies, the stabilizing influence and reinforcements for security to be found in the warm and affectionate social interchanges of human relationship, and the forces for personality-bolstering and individual self-esteem to be found in the real world of social interplay.

It is the common experience that in many instances in which the tranquilizing drugs have not of themselves produced clinical improvement of mental illnesses, the quieting and tranquilizing effects of such medications have made it possible to use the intensive activity therapies, largely of a recreation nature, which often result in improvement.

It is pointed out by some observers that the intensified use of the modern drug therapies is not always equated with an increase in discharge rate. Dr. Freyhan of the Delaware State Hospital says in a personal communication, "The majority of disturbed or disorganized patients admitted to the hospital respond promptly to drug therapies in a manner which permits early institution of social and recreation activities. Whereas patients often used to be confused and therefore unsocial while undergoing electroshock therapy or insulin therapy, patients on drug therapy remain intellectually intact. We have therefore observed an increase, which is rather substantial, in respect to acute as well as chronic patients."

Experiences in other institutions are also illuminating. For instance, one of Pennsylvania's state hospitals, Embreeville, has found that the use of the newer drugs has increased its recreation program some five hundred per cent. Part of this is the result of an increased emphasis on recreation, but it is found that this very interest has been stimulated by the fact that increasing number of patients are now able to participate in recreation programs. The number of patients suitable for ground privileges has increased significantly.

The state hospital at Wernersville, Pennsylvania, has found it possible to remove an even larger number of patients from the wards. Such patients are placed in occupational therapy and recreation programs. The increase of the recreation program has been about fifty per cent.

At the Philadelphia State Hospital, the staff has noted at least twenty-five

---

*From an address given at the International Recreation Congress in Philadelphia, 1956. DR. LINDEN is director of the division of mental health, Philadelphia Department of Public Health.*

per cent increase in total group activities, with the use of the tranquilizers. The patients in the new programs formerly would not have qualified for recreation participation.

The state hospital at Allentown, Pennsylvania, reports that more patients are going to band concerts, are participating in baseball games than ever before permitted; and patients participate in increased numbers in social activities. Similar experiences have been reported by the psychiatric group of the Philadelphia General Hospital.

The clinical director of the New Jersey State Hospital at Trenton reports a common finding in most mental hospitals, that there has been no increase in attendance at recreation programs from the convalescent section of the hospital. "The attendance from this section has always been high and the drugs seemingly have not caused any marked increase. Where we have noticed a difference has been on our active treatment wards where the state of the patient's psychosis has ordinarily precluded participation in recreation. . . ."

Most institutions today are finding

that the improved state of mind of treated patients creates many new needs within the hospital. While nursing services and certain other administrative costs in institutions, such as the food service, can be reduced and such reduction does constitute a saving of money, no real saving is accomplished because more recreation personnel and facilities are needed. Hospital staffs have become more enthusiastically oriented toward the use of psychotherapy as well as the related activities having a broad psychotherapeutic effect. In this category belong recreation services. Hospital administrators are calling for budgetary implementation of recreation programs; and organized programs are being established. Adequately trained volunteer workers, whose services can be utilized in the various types of recreation activities, have a place in this expanded hospital picture.

One observer points out that there are certain practical aspects growing out of the use of the newer drugs which concern themselves with the architectural designs of new buildings yet to be erected. Eventually, fewer detention rooms

may be needed; while the need can be predicted for more activity rooms, more recreation and occupational therapy facilities, more out-patient and day-care centers, and reduced space for shock therapies.

We are witnessing an increase in numbers of mentally disordered patients in all age categories being released from institutional care to home care. The benefits of hospital treatment are perpetuated, not only through the continued use of the newer medications, but, in addition, by the fostering and maintenance of resocialization activities in the community setting.

The real significance of recreation as therapy lies in its capacity to promote, foster and develop human interaction. It awakens the spirit of competitiveness and of fair play through a pleasurable system of cooperation. In this way it serves as a sublimated outlet for aggressive drives, as a device for retraining and restoring the human capacity for mutual identification, and as a socializing influence through team participation. Few human activities offer so much for so small an expenditure. ■

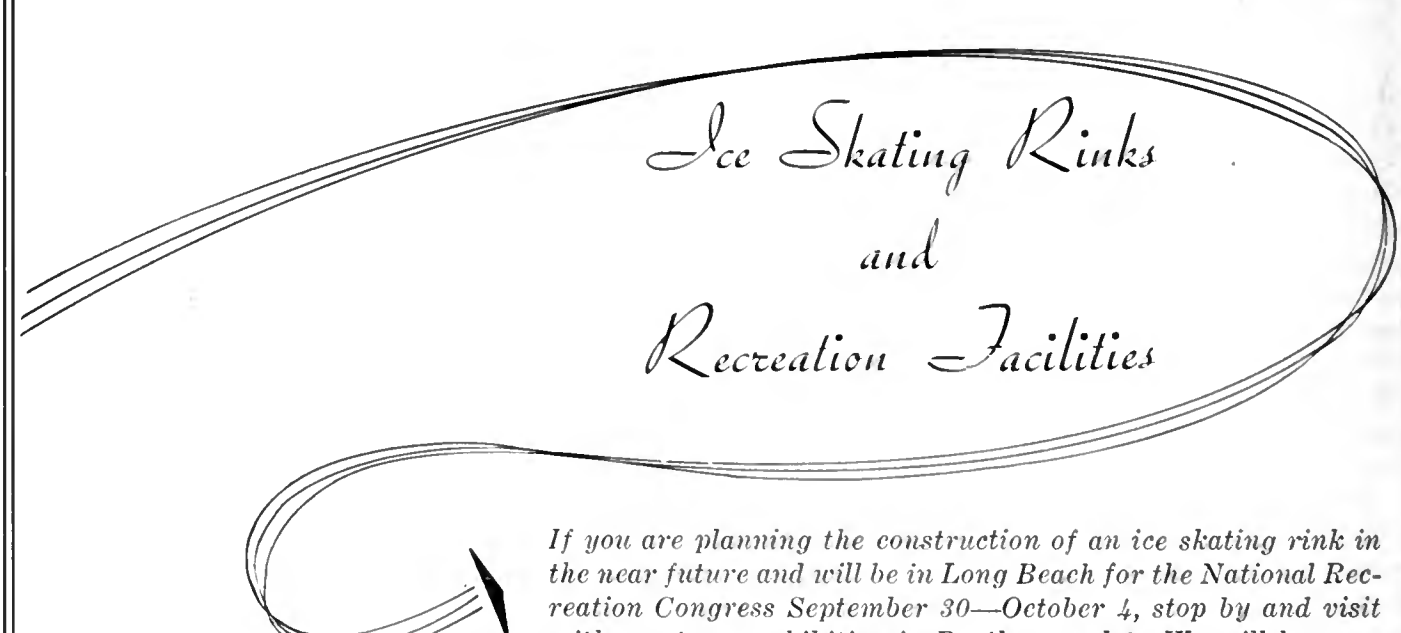

## Ice Skating Rinks and Recreation Facilities

*If you are planning the construction of an ice skating rink in the near future and will be in Long Beach for the National Recreation Congress September 30—October 4, stop by and visit with us at our exhibition in Booths 1 and 2. We will have on display photographs and models of the 34 ice rinks we have designed and engineered in the past three years.*

TAKE ADVANTAGE OF OUR INVALUABLE KNOWLEDGE AND EXPERIENCE  
IN ICE RINK CONSTRUCTION COSTS . . . OPERATIONAL COSTS . . . REVENUE . . . FINANCE.

**Peter Carver Associates** • 70 EAST 45th STREET • NEW YORK 17, NEW YORK

Are you looking for different ways to promote partner changes at parties and dances?

Jane A. Harris

# Easy Ways to Change Partners

For years people have been matching up everything from color cards to doodles in order to change partners at dances and parties. Mixers are fun for junior or senior high school groups if they can be effected quickly without involved teaching of steps. Here are a few which do not require much advance preparation.

**Musical Knees.** Boys on the inside, girls on the outside. The two lines move to the music, in opposite directions, around a circle. When the music stops, boys drop to one knee and girls rush to find a knee to perch on. Play this several times—the last time around the girl is boy's new partner for the next game or dance. Music should be lively. It is even more fun if there are extra boys or girls. (See Figure 1.)

**You'll Never Walk Alone.** When music starts, everyone walks around the circle counterclockwise in a group. When the leader calls, "Walk in threes," they arrange themselves accordingly and continue walking. The leader then alternates the call, "Walk alone," with calls for various numbers—fives, fours, and so on—until she is ready to stop the game and calls, "Walk in twos." This pairs couples for next activity.

**Spokes.** Start eight to ten boys circling in a star formation, left hand into center. Start music. As they circle clockwise, the girls rush out and catch on. Each puts his or her arm around partner's waist. As they continue to circle around, another group of boys catch on, then girls. Continue this until everyone is included. The boy may then dance with the girl on his right or take her as his partner for the next game. (See Figure 2.)

**Use Your Head.** Select four boys and four girls and give them old hats to wear. These eight people may cut in on those dancing, take their places and give them the hats in exchange for their partners. Play lively music so as to keep spirits high and keep the hats moving.

## Musical Mixers with Dance Steps

These two new "fun dances"—to replace or supplement the ever-popular Bunny Hop or La Raspa—have been successful with high-school and college-age groups:

### Hitch Hiker Mixer<sup>1</sup>

**RECORD:** *Pretty Girl Dressed in Blue* (Windsor 7614B) or any lively two-step, preferably in ragtime (4/4 time).

**FORMATION:** Double circle, partners facing, boy's back to

MISS HARRIS, a member of the dance committee of the NRA National Committee on Programs and Activities, is assistant professor of physical education, State College of Washington, Pullman, Washington.

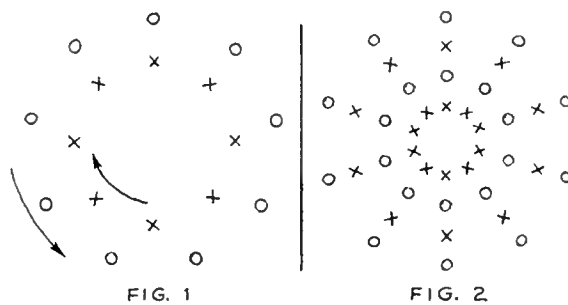

FIG. 1

FIG. 2

center of circle. Directions are for boy; girl's part will, of course, be the reverse.

**JUMP AND HITCH: Measures: 1-2**—Moving away from partner, take two small jumps backward. **3-4**—boy wags his left thumb (girl her right) twice, as if thumbing and turns his left foot (girl, her right) out twice toward line of direction. **5-8**—repeat action of measures 1-4, thumbing and toeing out toward reverse line of direction with other thumb and foot. **9-10**—repeat action of measures 1-2. **11-12**—wag both thumbs, turning out both feet twice.

**DOS-A-DOS: Measures: 13-16**—Strut two steps toward partner (slow, slow) and dos-a-dos partners, passing right shoulders, with four steps (quick, quick, quick, quick) back to place, facing forward and holding partner's inside hand. This figure may be done by taking eight quick steps.

**PROMENADE: Measures: 1-2**—Beginning left, take two steps (or four walking steps) moving forward in line of direction. **3-4**—strut four steps forward in line of direction. **5-6**—repeat action of measures 1-2. **7-8**—Boy, turning left, takes four struts and moves back to lady behind for a new partner. Girl, turning right, takes four struts in place.

### Tennessee Wig Walk<sup>2</sup>

**RECORD:** *On the Carousel* (Decca 28846).

**POSITION:** Partners face, do not hold hands.

**STEPS:** Draw step—toes—heels. Directions are for boy, girl's part reversed.

**Measures: 1**—Beginning left, step left, draw right foot up to left, take weight right (count 1) and repeat (count 2) moving in line of direction. **2**—step left (count 1) and clap hands (count 2). **3-4**—repeat above in reverse line of direction. **5-6**—move both feet together, toes first, then heels moving in reverse of direction. Repeat three times. The lady moves in line of direction. Both move to the right to new partner.<sup>3</sup> **7**—beginning left, take two steps around in place in front of new partner. **8**—slap thighs, clap hands (count 1) and then clap both of partner's hands (count 2). Repeat dance from beginning, getting a new partner on measures 5-6. ■

<sup>1</sup>This dance was originated by the author and appears in *Dance A While* by Harris, Pittman and Waller (Burgess Publishing Company). It is used by permission. The book may be ordered through the NRA Book Center, 8 West Eighth Street, New York 11. \$3.00.

<sup>2</sup>This dance was originated by the author.

<sup>3</sup>Some bop and rock 'n' roll variations fit in here very nicely for sideways move to a new partner. Teen-agers will love the opportunity to use these if they know them.

# Rhythm Groups in Rehabilitation

**A description of the use of the music rhythm group as a rehabilitation method for hospitalized mental patients—especially those who are schizophrenic. These procedures\* are qualitative and do not imply that a “best” method has been developed.**

**W**here does the rhythm group fit into the treatment of mental patients? What effect does it exert? How?

The simple nature of rhythm instruments renders them practicable for use with regressed schizophrenic patients. They do not require exhibitionism; therefore, the withdrawn and shy or frightened patient can participate. On the other hand, the patient who needs to come to the forefront can do so with an exaggerated vigor and sweep of his motions. The wide variety of rhythm instruments provides a gradation from most simple procedures, such as shaking a bell and tapping sticks, to more complex actions with, for instance, a group of drums. The proper instruments may be selected in accordance with the degree of regression. The patient is advanced to more complex instruments and complex rhythms as his progress warrants. He need not feel embarrassed that his performance is not “good.” Destructive anger, as well as passivity or withdrawal, may be expressed in this activity. The materials lend themselves to informality and a feeling of group joviality. This is of prime importance where the patient experiences excessive feelings of inferiority.

The activity is *group* activity. This assumes special significance for the schizophrenic, whose foremost symptom is *aloneness*—emotional isolation and the absence of social communication.

Rhythm group participation requires action; energy is put forth; it is centrifugal, a going-out. As such, it induces the isolated person to bridge the gap of communication.

The sources of stimulation in the rhythm group are many, and centripetal in that they flow in upon the isolated patient despite his unwillingness to receive them. Every member of the rhythm group, every patient playing upon an instrument, constitutes such a source of stimulation.

The leader has an excellent opportunity to form a relation with each of the members, for the vehicle lends itself

to interpersonal participation. Sessions should be scheduled for time and place, with the same participants and the same leaders. Verbal communication then becomes an integral part of the setting. Group discussion and group decisions within the scope of the participants are encouraged.

An informal setting for the music activity is desirable. We have provided refreshments, as available, with musical accompaniment by volunteers. No matter the level of regression, patients look forward to the rhythm group as a time of enjoyment and release.

## Rehabilitation Goals

An important principle must be kept in mind with music therapy and rhythm groups, as indeed with all rehabilitation endeavor. Ease of ward manageability is not necessarily a good yardstick for progress. Often, the first step toward ultimate improvement in a patient is apparent worsening of his behavior. For example, the passive and acquiescent “sitter” suddenly becomes excited and perhaps even assaultive. Although this may create some difficulty for nurse and aide, it has the more important meaning that the patient has been stirred from his passive adjustment to his psychosis. He is entering a state of change. Only when this happens, do we envision progress to a healthier level of adjustment. The rehabilitation therapist, whether he be psychiatrist, psychologist, occupational or educational therapist, music specialist or psychiatric nurse, must be patient with such behavior. It is the forerunner of recovery.

Although the rehabilitation worker should be prepared for this behavior, clinically we have observed that regressed patients become *less* difficult to manage on the ward as a result of their participation in rhythm groups. They are more content and less irritable during those days when they have attended rhythm sessions. This is reported by aides and nurses. Ward personnel have expressed astonishment regarding the degree and adequacy of participation by patients whom they considered “impossible” for such organized group activity.

## The Instruments

Music is usually provided by piano, although records and

\* Based on experiences with long-term schizophrenic patients in a Veterans Administration neuropsychiatric hospital.

---

LEO SHATIN, PH.D. is chief clinical psychologist, Veterans Administration, Hospital, Albany, New York. MR. KOTTER is director of special projects for the Hospitalized Veterans Service of the Musicians Emergency Fund, Inc., New York City. This article is excerpted from a study published by the American Archives of Rehabilitation Therapy, December 1955, and is used by permission of authors and publishers.



The above six patients, in a neuropsychiatric division of a Veterans Administration hospital, have shown an improved condition through rhythm-group therapy.

tape recordings may be used. Sets of rhythm band instruments found on the market in the past were, as a rule, made to be used by children. Because the patients who participate in these rhythm groups are adult and mentally ill, it was decided to furnish them with larger, more sturdy instruments, capable of greater volume of sound. Following is a list of instruments in order of patients' preferences:

- *Single and double-headed drums*, in several types and sizes, are used along with tom-toms which can be struck by hand or mallet. These are the basic instruments, and most preferred by patients in the rhythm groups.

- *Bongo drums*, to be held between the knees and played with the hands, fingers, or mallets. The single drum may be placed on a chair in front of the patient. This is necessary with the long-term patient who seldom grips it with his knees. The double or triple drum consists of a unit of two or three different sized drums joined together. The unit can be supported by the legs of the patient. Although this instrument is popular, it is seldom played properly despite instruction. Most often it is employed as a regular drum with a stick or mallet.

- *Maracas* are greatly favored.

- *Triangles* are accepted and played, but not so enthusiastically as other instruments.

- *Tone blocks* are generally used. However, the gourd tone block, which has circular corrugations along with its length, is never employed for its intended purpose.

- *Tambourines* of varying sizes are used as drums by the patients. Very few will shake the instrument, and then almost never in relation to the music.

- *Cymbals* in pairs, to be struck together, are generally rejected, possibly because they make too much noise. Loud noises generated by the group appear to be beneficially stimulating, but when made by one person it seems occasionally to distress that person. A single cymbal, suspended from a looped handle held in one hand and tapped lightly with a mallet, is in considerably more use.

- *Castanets* attached to a grip handle are greatly liked by individual patients, who will keep a steady beat with them but are unable to accompany in more complicated rhythm such as in a tango.

- *Sleigh bells*, though frequently accepted by patients, are only seldom shaken, and, again, in little relation to the music.

- *Tuned bells*, set on individual blocks, seem to puzzle the patients and none used them after a short experimentation. Doctors, aides, and other attending personnel sometimes increase interest in the proceedings by playing these tuned bells.

- *Claves* are not often in use except by accompanying personnel. A patient frequently likes to use one as a drumstick. Maracas are also pressed into use as drumsticks when patients are allowed a choice of instruments.

- *A small trap drum set*, on a stand, comprising snare drum, suspended cymbal, tom-tom drum, and gourd block, can be played with drumsticks, mallets, or wire brushes. It requires more complex actions in playing than any of the other instruments. Only one or two patients are able to handle this set with any satisfaction, its proper use requiring natural ability, imagination, adequate instruction.

### Orchestration and Music for Long-Term Patients

Attempts at organized orchestration have met with very little success among our regressed groups, most patients preferring merely to keep time with the main pulse of the music. An exception was one group of patients who cooperated in "Pop Goes the Weasel." One patient would be the "weasel" and all other patients would play with the music until time for the "pop," when they would stop and the "weasel" would make a resounding solo "pop" on a drum or block. Another interesting exception was accomplished with a march. One patient would begin alone with a drumbeat in march time and continue as each instrument in turn was signaled into the ensemble. After all were in, the music would strike up in time with the marching beat.

Within our groups, based upon previous experiences, all music is now chosen for its strict rhythm and well-defined beat. The session usually begins with a lively march which conveys the impression that something definite is going on and demands participation. The lively, loud march, more than any other type of music, seems to elicit spontaneous participation. Loud, rhythmically played popular music also brings such response. The march is followed by a waltz—still bright and lively—and so on through different types of music and rhythm. Between selections the psychiatrist or other rehabilitation worker conducting the session talks with various patients regarding their participation or non-participation, whether they liked the last selection, whether they have any requests or suggestions.

After its lively beginning, the music slowly lets down in intensity to a quieter mood—old favorites, mellow popular songs, and so forth. Toward the end of a session the music again picks up quite sharply in tempo and tone, thereby increasing activity and attention and leading to a refreshed, congenial mood at the finish. Sessions have lasted from half an hour to an hour, depending upon patient mood. Though it is impossible to blueprint a program and procedure for rhythm sessions, the procedure outlined on the following page is most often used—with a fine response.

TYPICAL 50-MINUTE GROUP RHYTHM SESSION

| Music Sequence    | Time Duration<br>(minutes) | Cumulative Time<br>(minutes) |
|-------------------|----------------------------|------------------------------|
| Bright, lively    | 8                          | 8                            |
| Moderately lively | 8                          | 16                           |
| Easy-going        | 11                         | 27                           |
| Slower, quieter   | 4                          | 31                           |
| Calm              | 6                          | 37                           |
| Slower, quieter   | 3                          | 40                           |
| Easy-going        | 4                          | 44                           |
| Moderately lively | 3                          | 47                           |
| Bright, lively    | 3                          | 50                           |

Types of Music

|                                |                            |
|--------------------------------|----------------------------|
| Marches                        | Waltzes                    |
| Popular and Boogie             | Folk Songs and Dances      |
| Jigs and Reels                 | Old Favorites              |
| Hillbilly and Western          | Indian and Oriental Dances |
| Tangos, Latin-American Rhythms |                            |

Careful consideration in choosing music for the groups must be given to the mood and activity level of the patients as well as to their age, musical preferences, and general cultural backgrounds. During a session no one selection should extend very long, for the rhythm tends to become monotonous and the motions of the participants automatic,

their concentration dissipated. Frequent changes of rhythm help to prolong the patients' attention and interest. Each selection should have a different pulse regardless of its mood.

Other Applications

Each rhythm group can service a variety of therapeutic functions from its very inception. When the instruments themselves are constructed by patients in occupational or manual arts therapy, the patients tend to develop additional interest in them. They desire to play what they have constructed. The natural rhythm group is thus formed and the progression from occupational or manual arts therapy to music therapy is a normal sequence. The construction of instruments develops an excellent working relationship among the rehabilitation disciplines. When the rhythm group attains some degree of excellence, it can present programs over the hospital radio within wards for bedridden patients. Participants therefore derive heightened self-esteem and personal gratification, in addition to extending a service to other persons. ■

Alice Howenstine

# Nature Crafts Year 'Round

## Cattail Leaf Mats

*Although cattails (also known as reed mace) grow in any wet, marshy area and have been found in limited quantities and localities even in the arid Southwest, they might be rare in your area. If this is so, you can try this same craft with similar longleaf plants, such as blades of tall, coarse grass or long narrow palm leaves. Calamus leaves can also be used; their ridged leaves give a very artistic effect. The same general procedure followed in making cattail mats would apply to making mats with these materials.*

THE winter months are naturally the most difficult ones in which to find native craft materials, but that, by no means, should eliminate nature crafts from your program. Get a good supply of cattail leaves now and you'll be all set for the winter meetings not so far in the future.

MRS. HOWENSTINE has been engaged in native or nature craft work for a number of years. Readers may have seen and heard her at craft workshops at conventions or teachers' meetings.

Cattail leaf mats can be used as doilies under lamps or vases, as coasters, placemats and as frames and mats for pictures. A very large mat can be used as a rustic bulletin board.

Cattail plants reproduce easily. Their seeds are windborne, and they sprout again from the roots; so there is no danger of making them extinct by over-gathering in any one area. They can be found in swampy areas or along pond shores. Let's start from the beginning and make a cattail leaf mat together.

Gathering the Cattails: You will need

a sharp knife and boots. Scissors will do if a knife is not available. Occasionally the whole plant, root and all, can be pulled out and trimmed later before drying.

As a safety precaution, gather more leaves than you think necessary, for the thick bases and narrow tips are not easily used and some leaves will probably crack en route to home, school or camp.

If the cattail pond is on a farmer's property, don't forget to ask his permission. He'll probably be more than glad to have you get rid of some of them for him for they spread rapidly, clogging drainage ditches or farm ponds.

The weaving is done with the dried, but not necessarily brown, leaves. The cut leaves will dry long before the color begins to fade. Leaves can be gathered throughout the year. Of course, the more snows that have fallen on them before they are gathered, the shorter the leaf pieces will be, for the weight of the snow cracks them. However, mats twelve inches square have been made with leaves gathered late in win-



ter. If you gather early in the season, spring through September, some of the leaves will still be green. By late September, however, the majority have dried nicely and need little preparation before weaving. A fresh green cattail leaf mat looks very nice when it is first woven, but the leaves shrink and shrivel a great deal more than the dried ones, leaving large gaps in your mat. So, for a similarly pleasing, but much more lasting effect, use dry leaves.

**Drying:** The amount of time to allow for drying varies with the condition of the leaves and the season in which they are gathered. If they are green, allow two or three weeks; if they are already light brown, with little or no trace of green, only a few days are needed, and often they may be used immediately.

You will need an area large enough for the leaves to lie rather loosely. To hasten the drying process, any thick place at the base of the leaf should be cut away. This can't be used anyway, so you might as well eliminate all the "water storage space" possible. When the leaves are thoroughly dry, they can be bundled together and stored until needed.

**Weaving:** Soak the leaves in water anywhere from a half-hour to a few hours before using. They will float, so bundle them together and weight them down. Having the leaves wet while working not only makes them more pliable but also makes them adhere to the working surface so they do not slip around much. The moisture absorbed during this short soaking expands the leaves a little; however, though there is some shrinkage later, it is slight and does not spoil the finished effect. If the mat is woven while green, the leaves will shrink to one-quarter or one-third their original width and will be shriveled.

The importance of the leaves being thoroughly dry before the preweaving soaking cannot be overstressed. I have known leaders who have used this as a spur-of-the-moment craft—gathering fresh or partially dried leaves and weaving immediately. Results have not been at all satisfactory. Others, using thoroughly dried leaves, have been very enthusiastic about this project.

Do not cut the leaves to desired lengths before weaving, but work with pieces longer than the finished product.

This makes leaves and mat much easier to handle, especially during the last few rows of weaving, and the sides will be much more uniform if trimmed after weaving and binding are completed.

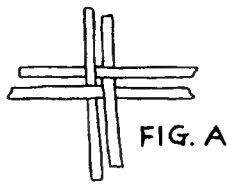

FIG. A

Begin weaving with only four leaves, two each way, weaving these together at the center, as in *Figure A*. This gives the mat some "body" from the beginning and eliminates handling too many loose leaves at once. Use this woven area as the approximate center and build out from there, adding a few leaves at a time to each of the four sides. Keep the leaves pushed as close together as possible to minimize the space created by the slight shrinkage that comes with drying.

**Finishing Edges:** After the desired size is reached, bind the edges to keep the mat from coming apart. Any appropriate raffia, brown cord or string can be used. Cut a length somewhat longer than twice the perimeter of the mat. Double the string, slide the doubled end over a corner leaf of the mat, so you seem to be working with two pieces of string. Now begin to "double weave" around the mat, as in *Figure B*. At the corners twist the string so that one piece won't be likely to slide under the edge of one of the leaves. Finish off with a square knot.

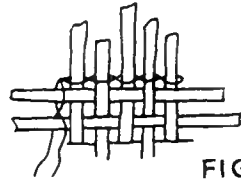

FIG. B

Trim the edges with scissors. The mat may be kept as a square or rectangle by cutting approximately one inch beyond the binding all the way around. If an oval or round effect is desired, this may also be obtained in the cutting process as illustrated in *Figure C*. Remember not to cut too close to the binding.

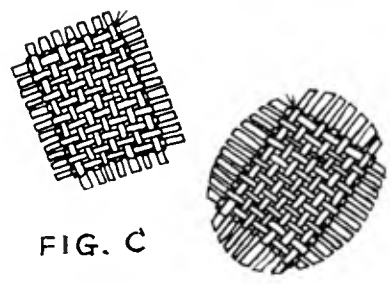

FIG. C

**Completion:** Put the mat between newspapers to absorb the moisture and weight it for a day or so until dry. If you like, a coat of shellac gives the dry mat a nice luster.  
Try it, it's fun! ■

**W. D. GRIFFIN CO.**  
Makers and sellers  
of  
long-lasting wood table games.  
WRITE FOR INFORMATION AND FREE CATALOG  
5927 Euclid Avenue Cleveland 3, Ohio

Business Gift, Imprinted Novelties and Advertising Specialty Catalog Sent FREE on request. Give your clients and customers something to remember you by.  
**IDEAL SPECIALTIES**  
250 W. 57 St. Dept. RN  
New York 19, N. Y.

**ICE WHEN YOU WANT IT**  
with  
**BELTEMP**  
artificial ice skating rinks by  
**BELTZ ENGINEERING LABORATORIES**  
11021 Whittier Avenue  
Detroit 24, Michigan. Venice 9-1811

**monroe**  
**FOLDING BANQUET TABLES**

AND  
**MONROE TRUCKS**

If you are on the Board of your Church, Lodge, Club, School, etc., you will be interested in this modern Folding Banquet Table.

Completely finished tops, resistant to most serving hazards. Used with or without table cloths.

Write for Table and Truck Catalog and special price discounts to institutions and organizations.  
**Monroe Co., 181 Church St., Colfax, Ia.**

# Location of Facilities for Senior Citizens Clubs

Ronald D. Johnson

**A** primary consideration in providing a year-round meeting place or center for senior citizens is the location of the facilities. Should they be centrally located in the community or should they be in the smaller neighborhood areas?

Madison, Wisconsin, with a population of about 100,000 has one centrally located facility to serve all local golden-age clubs. Plans are under way, however, to form smaller clubs and to encourage golden-agers to keep attending their neighborhood meeting places in churches and schools.

Janesville, Wisconsin, almost 25,000 in population, had one large golden-age club which met in a downtown building. Neighborhood locations never were considered seriously because the golden-agers objected to using school and church facilities, very often the only suitable existing meeting places. The large club was finally split into seven small clubs, with membership in any one club not to exceed fifty. These are organized on the basis of common interest rather than according to location of residence. All seven clubs meet in downtown locations and are now working toward the construction of a centrally located building specifically for senior citizens.

Oak Park, Illinois, approximately 65,000, has one large club which meets twice a month at a centrally located facility. The club is split up into interest groups, each limited to about twenty members, which are concerned with such things as reading, discussion, various arts and crafts activities. The small groups meet weekly in homes, churches and other neighborhood places.

In Monroe, Wisconsin, a city of about 8,000, the number of active golden-age club members comes close to one hundred. This may seem a large number for a small town; however, if the clubs were located in the various neighborhoods, I feel that recreation would be provided for more than double that number.

It seems that larger cities might need a number of wide-spread facilities in order to provide a balanced service. Milwaukee, Wisconsin, for example, has a highly organized program with golden-age clubs meeting in the neighborhood social centers. A single center provided within or near a public housing unit or at any other location should be only a part of the total picture.

Centrally located community center facilities usually attract larger numbers of people and provide many more



**WISHING WELL.** At the Charlotte, North Carolina, May Day dance for citizens from seventy to ninety, golden-agers again prove May and December do mix. Today's senior citizens now have a social life in many communities because of the interest and concern of recreation departments and other organizations.

activities than neighborhood clubs. In a large group there usually are more people with like interests than in a small group. Neighborhood clubs tend to group people who already know each other, or who are similar in interests and background.

Many older persons do not feel at ease in large groups and prefer the smaller clubs; but interest groups can be formed within large clubs that would offer the same relationship between participant and leader. On the other hand, many golden-agers enjoy being in a large club, with a chance to meet new people, where experiences and interests are varied.

Duplication of equipment and facilities, as well as the need for additional leaders are drawbacks of the smaller neighborhood clubs. Operating costs and personnel may limit a community to a single centrally located facility, which, usually, does not require the leadership necessary to run a community-wide organization of small clubs. Where desired facilities and leadership do not exist, however, leaders should be able to refer the club members to other places. With more neighborhood facilities and smaller clubs, leadership is more effective, particularly where a social group work service is desired.

A centrally located facility will usually be accessible from all points where public transportation is offered. In some communities a definite transportation problem exists, which must be solved through car pools, free taxi service and other means. With neighborhood facilities transportation is still sometimes a problem, but the distance is less.

The same methods will not work equally well with any two communities. Needs of golden-agers differ and needs of the community differ. The limitation or availability of facilities, leadership, transportation and interest should determine whether we have central or dispersed facilities. The decision is up to the individual community. No program or plan of action should be initiated simply because it is successful elsewhere, or because someone has stated that one method is better than another. Any proposed action should be considered as it would affect the local program and the community, using the experiences of others as the starting point. ■

---

MR. JOHNSON is park and recreation director in Monroe, Wisconsin. The above is from an address delivered at the 1957 Great Lakes District Recreation Conference.

# TWO for TEENAGERS

Well-Illustrated  
Easy-To-Read

INTRODUCING:

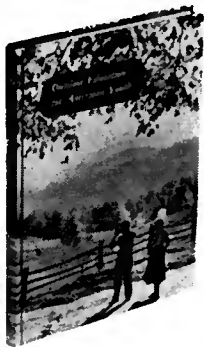

## OUTDOOR EDUCATION FOR AMERICAN YOUTH

This first text for teaching teenagers to enjoy the out-of-doors describes the setting and need for outdoor education, its place in the school program, facilities, resources, and teacher preparation. 150 pp. \$2.50.

## PHYSICAL EDUCATION FOR HIGH SCHOOL STUDENTS

Covers sports, dance, games, parties, athletics, and career information. It is the officially adopted text in many states. 406 pp. \$3.00

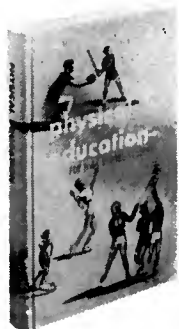

### AAHPER Publication-Sales

1201 - 16th Street, N. W., Washington 6, D. C.

— Outdoor Education for American Youth, \$2.50

— Physical Education for High School Students, \$3.00

(2-9 copies of one title, 10% discount, 10 or more, 20%)

Check enclosed  Please bill me

NAME.....

ADDRESS.....



NEW!  
Optional  
Feature!

Roll-away casters make it easy to clear your floors.

PLAY AREAS DO DOUBLE DUTY WITH

# Superior

## Folding Table Tennis Tables!

Superior tables can be stored compactly, can be opened for play in a jiffy... even rolled away on wheels by a youngster. Sturdy, rigid Superior MT1000 Table has edge-protecting METAL FRAME AND TUBULAR STEEL LEGS, HEAVY DOUBLE HARDWARE ON LEGS. Thousands used by playgrounds, camps, schools, military installations... wherever a heavy duty table is needed.

POPULARLY PRICED! APPROVED BY USTTA.

Write for literature showing complete line of institutional table tennis tables.

# Superior

INDUSTRIES CORPORATION

565 Barry Street, New York 59, N.Y.

# Just off the Press!

## YOUR GUIDE TO SUCCESSFUL FILM PROGRAMMING!

More than 225 FREE films on such subjects as:

- SOCIAL STUDIES
- HOME ECONOMICS
- MUSIC AND THE ARTS
- TRANSPORTATION AND COMMUNICATIONS
- HEALTH AND SAFETY

Plus: The Latest releases from WALT DISNEY STUDIOS! (for rental)

Order your FREE copy TODAY!

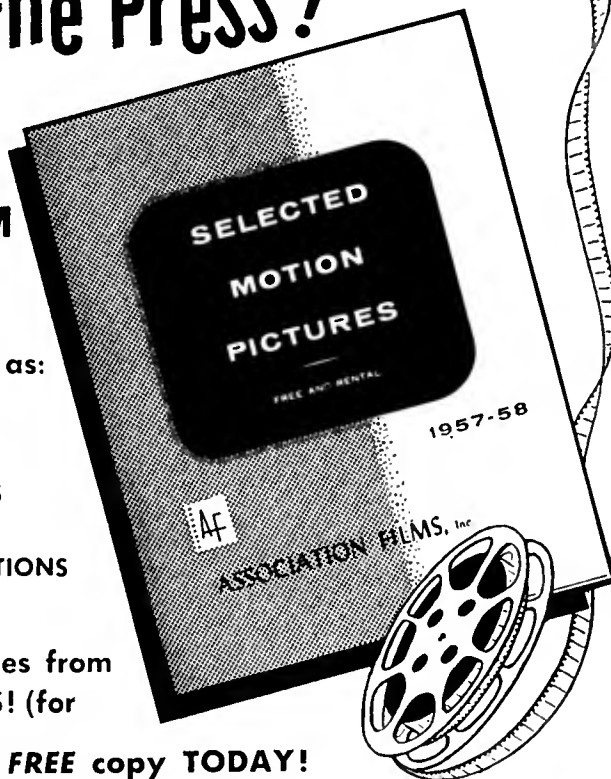

Branch Libraries:  
RIDGEFIELD, N. J.  
Broad at Elm

LA GRANGE, ILL.  
561 Hillgrove Avenue

SAN FRANCISCO, CAL.  
799 Stevenson Street

DALLAS, TEX.  
1108 Jackson Street

**AF** ASSOCIATION FILMS INC.  
347 Madison Ave., New York 17 Dept. R-9

Please send me FREE copy of your 1957-58 edition of Selected Motion Pictures.

Name.....

School.....

Street.....

City..... Zone..... State.....

# A Matter of Policy

## Policy Making

There is great need for more thought on the subject of "policy." Although policies must be formed to fit the community, and while each town is different, principles of public recreation are the same everywhere.

Any recreation executive appreciates fully the value of policies in the daily administration of his department, for they are its anchor, framework and backbone. Determination of policies (using Webster's definition of policy as a settled course followed by a government, institution or agency) is essentially the responsibility of a lay board or commission. The executive, however, exerts his leadership by initiative and by providing the advice and information necessary for determining policies.

If a policy is based on sound recreation principles, it affords a chance for the board or commission and the recreation executive to show the community what public recreation stands for. In some areas of the recreation operation, such as those of personnel and accident procedure, policies are easily made. Other policies, especially those dealing with program or the use of facilities, which can step on the toes of part of the public, are harder to establish. They may take wisdom and courage.

An example of this is the matter of Sunday activities. Where does the recreation department draw the line in this touchy matter? It is right to close swimming pools, ballfields, or golf courses on Sunday afternoon? What about organized sports that make a boy or girl feel compelled to participate? Should department fields be maintained for such sports even though the department is not operating the activity? The answers arrived at will constitute the Sunday policy of the department.

What principle of public recreation is there to guide the establishment of this policy? The building of a well-rounded personality, a full, rich life? Most everyone will agree that religion is as essential to the full life as food, rest and exercise. In addition, President Eisenhower has called for a spiritual resurgence. With these considerations in mind, should public recreation encourage what appears to be a trend away from the observance of the Lord's Day? On the contrary, perhaps it should work in the opposite direction?

This would mean, at the least, complete separation of the department from any activity which *requires*, in any sense, participation on Sunday. Optional activities or pickup games could be played, but no organized league play could be permitted. Public facilities which are used at the option of the citizen could remain open.

In this day and age no recreation department could survive which opposed recreation on *any* day of the week, including Sunday. Let the swimmers splash away, the golf clubs swing, the baseballs fly. But don't encourage anyone to violate his own conscience. Organized play should not take precedence over the real purpose of the day.

Another policy which may be difficult to establish deals with alcoholic beverages in buildings or grounds operated

by the recreation department. It is assumed that no department tolerates drinking on the part of minors. The problem arises when facilities are rented to private adult groups which bring their own drinks. Perhaps the department controls the only facilities suitable for the meetings of such groups. Alcohol and recreation do not mix, however, and age should have nothing to do with the answer.

Making the policy is just the beginning; its application is the important step. The critical stage can be the introduction. On controversial matters, strong leadership, tact and consideration are called for. The thing to remember is that each sound policy represents a step ahead for the recreation program and in the mind of the public.—ROBERT E. KRESGE, *Superintendent of Recreation, Charleston, West Virginia.*

## Los Angeles County Policy

In order to make possible the purchase of additional land needed to meet the growing demands for recreation, the board of supervisors of Los Angeles County, California, have adopted a policy of allocating county sales tax funds from the unincorporated areas for acquisition and development of local park areas. The following policies have been adopted by the county's parks and recreation commission to implement local and regional recreation services:

1. Provide a wide variety of recreation areas and facilities including local parks (unincorporated territory), regional parks and facilities, such as swimming pools, public beaches, campgrounds, sports centers, historic sites, golf courses, riding and hiking trails, system of roadside rests and vista points, museums, arboretums, botanical gardens, inland waterways for purpose of recreation, and reservations for the conservation of wild life and natural resources.

2. Recognize responsibility for acquisition, improvement, maintenance and operation of local facilities and programs in unincorporated territory until local control is available.

3. Recognize that the provision of facilities and special recreation services in hospitals and institutions is the major responsibility of county government.

4. Provide adequate leadership, attractive facilities and a variety of wholesome recreation opportunities throughout the year to meet the needs of all people.

5. Provide adequate funds to finance a capital outlay program of land acquisition and facility development, maintain facilities and establish and operate them.

6. Encourage employment of competent, well-paid professionally prepared leadership.

In carrying out this six-point program, the county department of parks and recreation will observe the following plan of priorities for new development: regional park land acquisition; local park land acquisition within the unincorporated area; capital development of regional parks; staffing of areas and facilities for maintenance and recreation programming; capital development of local parks.—*From the Los Angeles County Parks and Recreation Department News, April 28, 1957.* ■

chosen again for a championship floor

*Hillyard* **TROPHY** *"The Tiffany of Finishes"*

Wichita University Field House  
Architects: Lorentz, Schmidt, McVay & Peddie  
Robbins Hard Maple Floor installed by Cincinnati Floor Co.



ADMINISTRATION

Wichita University's new Field House is an outstanding triumph of modern functional design—with unique lamella dome of structural steel, and circular seating such that every seat is a good seat. Focus of the structure is the playing floor, beautifully conditioned by the finest treatment of all—Hillyard TROPHY Gym Seal and Finish, maintained by daily sweeping with Hillyard SUPER HIL-TONE Dressing.

*Trophy—the Overwhelming Choice!*

More than 15,000 of the nation's finest gym floors are kept in top condition with Hillyard floor treatments—and wherever Championship Basketball is played, TROPHY is the favorite. Famous Trophy floors for Basketball's Best: Boston Garden, Home of N.B.A. Champion Celtics; Kansas City Auditorium, N.C.A.A. and N.A.I.A. finals; Madison Square Garden, National Invitational.

**HILLYARD TROPHY ENCOURAGES CHAMPIONSHIP PLAY!**

Light, natural, no-glare finish enables players and spectators to see all plays clearly (live or televised)!

Non-slip underfoot for faster, safer big-time play.

Outwears any other gym finish by more than 2 to 1.

Maintained with Hillyard SUPER HIL-TONE, simplifies maintenance, slashes maintenance time and costs. Keeps floor dust-free and lustrous, yet non-slip and no-glare.

Hillyard specialized products and labor-saving treatment methods were developed to meet the high standards of the new functional type building.

Mail coupon for free demonstrations.

**S. T. JOSEPH, MO.**  
Passaic, N.J.  
San Jose, Calif.

Branches and Warehouse Stocks in Principal Cities



HILLYARD St. Joseph, Mo.

**Mail This Coupon Today**

Please have the Hillyard "Maintaineer<sup>®</sup>" show me how easily I can have a TROPHY Championship Gym Floor.

Name .....

Institution .....

Address .....

City ..... State .....

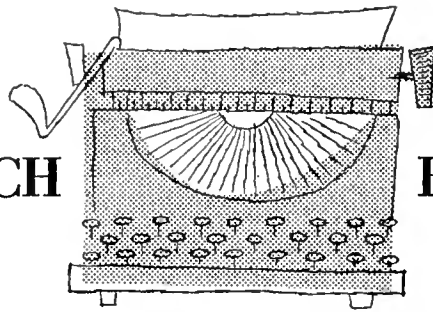

George D. Butler

### Information on Drownings

In *Facts on Drowning Accidents*, a summary of his doctoral study, Bramwell W. Gabrielsen of the University of Georgia has presented for the first time comprehensive data with reference to drowning accidents throughout the country. In the 1,309 cases representing thirty-five states which were studied, an attempt was made to ascertain the facts surrounding such accidents. The analysis is accompanied by a list of implications for education and municipal and state legislation. The report also contains thirty-three tables which record the frequency of drownings by age, sex, education, swimming ability and many other factors.

Important findings, all of which have special significance to recreation authorities, are that:

1. People drown wherever there is water, at all times of the year, every day in the week, every hour of the day.
2. All age groups are susceptible to drownings, but the danger years are from birth to fifteen.
3. A large number of drowning victims each year are children under four years of age.
4. A high percentage of victims are non-swimmers.
5. Many people never have had any form of swimming instruction.
6. More people drown with clothes on than in bathing suits.
7. Many drownings are a direct result of violations of sound safety procedures.
8. More people drown while engaged in other activities than in swimming.
9. A large number of non-swimmers use small crafts.
10. Many drowning accidents occur at areas not patrolled by life guards.
11. Many people lose their lives trying to give assistance to people in trouble.
12. At many drowning scenes there is no one present trained to administer artificial respiration until rescue squads arrive.

The report lists specific steps which parents could take in guarding their children from drowning and outlines the responsibilities of public education agencies. Specific legislative enactments to assure greater aquatic safety are recommended.

A valuable feature of the report is a comprehensive set of safety rules developed with the cooperation of a committee from the Conference for National Cooperation in Aquatics. One section deals with rules that are applicable in all situations; others deal with rules for swimming, boat-

ing and fishing and hunting. Copies of the report are available from Dr. Gabrielsen at the University of Georgia, Athens, Georgia, for \$1.00 each.

### Study of Biotic Communities

*The Ecology of the Watchung Reservation* by James Baird, issued by the botany department at Rutgers University, reports a study of the biotic communities in this two-thousand-acre New Jersey reservation administered by the Union County Park Commission. The report also offers specific recommendations for the management of these communities and was prepared at the request of the commission. The volume\* should be of primary interest to all who are concerned with the conservation and management of reservation areas.

Since the acquisition of the area, it has been the policy of the commission "to preserve this entire tract in its largely primeval state" and, at the same time, to make it more accessible and reasonably available to picnickers, campers, fishermen and all lovers of nature by providing roads, trails, and bridle paths.

According to the report, the policy of leaving the vegetation entirely to itself everywhere in the reservation would certainly be the least expensive method of vegetation management. It would not, however, because of the inevitable decrease in variety as a result of vegetation change, preserve for future generations certain values enjoyed in the reservation today. Specific recommendations are made with the assumption that preservation of variety as it now exists is desirable. "The majority of the vegetation of the reservation would best be left to the natural course of vegetation change."

Detailed recommendations are offered for the control of old field succession through various stages, such as those with grasses, herbs, and scattered woody plants, with extensive thickets, with small grassy glades, red cedar thicket and the young woods. Vegetation control is also indicated for the marsh, pine forest plantation, the honeysuckle-invaded areas, the blown-down and standing dead trees and the roadsides, among others. The introduction of foreign plants in the park would be considered detrimental, according to Mr. Baird.

A major section of the report is devoted to animal populations with a consideration of birds, amphibians, reptiles and mammals and general recommendations for their management. ■

\* Available from the Department of Botany, Rutgers University, New Brunswick, New Jersey. \$1.50.

MR. BUTLER is director of the NRA Research Department.

"The Caller with a Smile in His Voice"



**Bart Haigh**

Former Recreation Director  
Borough of Dormont, Pa.

**SQUARE DANCE  
CALLER**

Records or Band

You want it SIMPLE! You want FUN!

YOU WANT BART!

123-35 82nd Road Kew Gardens 15, N.Y.  
80 Oulevard 1-8955  
(Call collect within 50 miles of New York City)

**NEW AND IMPROVED  
RYAN'S H. & R.**

**DRY LINE MARKERS**

5 DIFFERENT MODELS

From 20# to 100# Capacity  
Force Feed — Instant  
Shutoff — 50 lbs. ca-  
pacity.

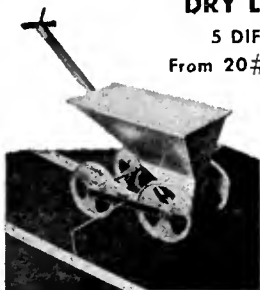

Shaker in Hopper for  
Constant Flow.  
  
Adjustable Control on  
Handle.

**SAVES TIME AND  
MATERIAL**

Send to Dept. R for booklet on four other models  
H. & R. MFG. CO., LOS ANGELES 34, CALIF.

**WRITE FOR  
LITERATURE**

**AMERICAN APPROVED**  
*Jim Patterson*  
**lifetime**  
**ALUMINUM  
DIVING BOARD**

**World's Finest Official Board**  
Rugged Aircraft Girder Construction,  
Unequaled in Design, Durability and  
Performance by any board built today.  
**Exclusive International Distributors**

**AMERICAN**  
**PLAYGROUND DEVICE CO.**  
ANDERSON, INDIANA, U.S.A.  
WORLD'S LARGEST MANUFACTURERS OF FINE  
PARK, PICNIC, PLAYGROUND, SWIMMING  
POOL AND DRESSING ROOM EQUIPMENT

ADMINISTRATION

**RECREATION AREAS**

**-Their Design and Equipment**

**Second Edition. Just Published!** Prepared for the *National Recreation Assoc.* By **GEORGE D. BUTLER.** Up-to-date book offers detailed information on the design and equipment of recreation areas, with emphasis on neighborhood playgrounds, play and athletic fields. 170 practical illustrations, diagrams, and plans include the official dimensions and layouts of nearly 40 playing courts and fields—plus 14 building floor plans. Fully explains how to incorporate modern apparatus, equipment, and game courts into the area plan. Book deals with problems of athletic field construction with special attention to the running track, areas for field events, seating and parking facilities. Includes a complete new section on the construction of artificial ice skating rinks. 9 x 12. \$6

**Playgrounds—Their Administration & Operation**

Also **G. D. BUTLER.** The enlarged function of the neighborhood playground and revised space and leadership standards. Book introduces new, up-to-date programs, outlining current solutions to common playground problems. 21 ills. Revised Edition. \$4.75

**HANDBALL—Its Play & Management**

**B. E. PHILLIPS.** New! Only available book to identify, explain, and illustrate all phases of one- and four-wall softball handball. Includes offense and defense tactics for singles and doubles play. *A Barnes SPORTS LIBRARY Book.* 50 ills. 6½ x 10. \$2.95

**Football Techniques Illustrated**

**JIM MOORE and TYLER MICOLEAU.** Covering kicking, passing, line play, etc., book shows beginning player and coach how these individual techniques are combined in the team's over-all offense and defense. *A Barnes SPORTS LIBRARY Book.* 154 ills. 6 x 9. \$1.95

**SOCCER ILLUSTRATED**

**FRANK F. DICLEMENTE.** Most complete book available on developing the soccer player. Details and illustrates the mechanics of each of the game's fundamentals: kicking, passing, dribbling, etc., showing how the 11 players move as a team. 113 ills. 6 x 9. \$3

Order your books from:

**THE RONALD PRESS COMPANY • 15 East 26th Street, New York 10**

**Checkерette**

**HAT and COAT RACKS**

These multi-purpose wardrobe racks go where-  
ever needed, or store away like folding chairs  
when not in use. They come in 3 ft. or 4 ft.  
lengths, have two hat shelves and 1 or 2 full  
length, hanger bars for coat hangers or coat  
hooks. (Two-sided hooks snap over and strad-  
dle the bar, see detail below). Standard units  
come on glides: stand rigidly under a full load.  
Special caster bases are available for wheel-  
ing racks about—loaded or empty. Write for Cata-  
log CT-515.

**VOGEL-PETERSON CO.**  
1127 West 37th Street • Chicago 9, Illinois

## SOS! Danger Ahead!

W. C. Sutherland

*The recreation movement and profession are in serious trouble!*

**Y**OU have just read a rank understatement! The recreation movement and recreation profession are in serious trouble. Study the tables below and ask yourself a few questions.

Who will lead us fifteen, twenty or thirty years from now?

What will be the status of our profession and the quality of its leadership by 1975?

Where are these leaders coming from? How are they being discovered? How are they being trained, developed?

*These are the questions professional workers and close friends of the recreation movement must answer.*

The number of recreation graduates dropped from 692 in 1951 to 444 in 1956 and decreased still further to 406 in 1957. If this trend is not reversed sharply and quickly the status of the recreation profession by 1975 may be such that it will be impossible to attract even a percentage of the better prospects to a career in recreation!

The drop in recreation graduates is more serious than it first appears because the population is increasing and so is the demand. Also, it is not likely that more than one hundred of the four

hundred graduating this year will enter the recreation profession on a full-time basis. Many will be lost immediately to the armed forces or to marriage. Others will never reach the recreation profession because of more lucrative opportunities offered in other fields.

Some progress is being made, and the National Recreation Association's recruiting committee continues to urge:

1. Every worker get one recruit.
2. Every state recreation society appoint a recruiting committee.
3. Every effort be made to establish local recruiting committees.

**WE MUST:**

- Increase recruiting activities at local state and national level.
- Expand the Association's internships program.
- Prepare more attractive material for local use.
- Secure more recreation scholarship and fellowships.
- Provide more exciting summer jobs for recreation students.
- Provide more meetings at district conferences and national recreation congresses of special interest to recreation students. ■

**COMPARISON OF NUMBER OF SCHOOLS REPORTING AND DEGREES GRANTED IN 1951, 1956 AND 1957**

| DISTRICT          | Number of Schools Reporting |           |           | Number of Degrees Granted |            |            |
|-------------------|-----------------------------|-----------|-----------|---------------------------|------------|------------|
|                   | 1951                        | 1956      | 1957      | 1951                      | 1956       | 1957       |
| New England       | 4                           | 3         | 2         | 27                        | 49         | 21         |
| Middle Atlantic   | 9                           | 6         | 4         | 173                       | 78         | 26         |
| Southern          | 10                          | 9         | 8         | 100                       | 86         | 70         |
| Great Lakes       | 11                          | 9         | 7         | 251                       | 182        | 167        |
| Midwest           | 4                           | 0         | 1         | 26                        | 0          | 1          |
| Southwest         | 2                           | 1         | 1         | 16                        | 3          | 4          |
| Pacific Southwest | 10                          | 4         | 9         | 65                        | 17         | 92         |
| Pacific Northwest | 3                           | 4         | 3         | 34                        | 29         | 25         |
| <b>TOTAL</b>      | <b>53</b>                   | <b>36</b> | <b>35</b> | <b>692</b>                | <b>444</b> | <b>406</b> |

MR. SUTHERLAND is director of the NRA Recreation Personnel Service.

**NUMBER OF DEGREES AWARDED IN 1957**

| DISTRICT          | Number of Schools Reporting | BACHELOR   |            |            | MASTER    |           |            | DIRECTOR  |          |           | DOCTOR   |          |          | TOTAL      |            |            |
|-------------------|-----------------------------|------------|------------|------------|-----------|-----------|------------|-----------|----------|-----------|----------|----------|----------|------------|------------|------------|
|                   |                             | Men        | Women      | Total      | Men       | Women     | Total      | Men       | Women    | Total     | Men      | Women    | Total    | Men        | Women      | BOTH       |
| New England       | 2                           | 11         | 1          | 12         | 6         | 2         | 8          | 1         | 0        | 1         | 0        | 0        | 0        | 18         | 3          | 21         |
| Middle Atlantic   | 4                           | 13         | 1          | 14         | 5         | 4         | 9          | 0         | 0        | 0         | 3        | 0        | 3        | 21         | 5          | 26         |
| Southern          | 8                           | 23         | 31         | 54         | 13        | 3         | 16         | 0         | 0        | 0         | 0        | 0        | 0        | 36         | 34         | 70         |
| Great Lakes       | 7                           | 46         | 51         | 97         | 42        | 16        | 58         | 9         | 1        | 10        | 1        | 1        | 2        | 98         | 69         | 167        |
| Midwest           | 1                           | 0          | 1          | 1          | 0         | 0         | 0          | 0         | 0        | 0         | 0        | 0        | 0        | 0          | 1          | 1          |
| Southwest         | 1                           | 0          | 4          | 4          | 0         | 0         | 0          | 0         | 0        | 0         | 0        | 0        | 0        | 0          | 4          | 4          |
| Pacific Southwest | 9                           | 44         | 33         | 77         | 10        | 4         | 14         | 0         | 0        | 0         | 1        | 0        | 1        | 55         | 37         | 92         |
| Pacific Northwest | 3                           | 15         | 10         | 25         | 0         | 0         | 0          | 0         | 0        | 0         | 0        | 0        | 0        | 15         | 10         | 25         |
| <b>TOTAL</b>      | <b>35</b>                   | <b>152</b> | <b>132</b> | <b>284</b> | <b>76</b> | <b>29</b> | <b>105</b> | <b>10</b> | <b>1</b> | <b>11</b> | <b>5</b> | <b>1</b> | <b>6</b> | <b>243</b> | <b>163</b> | <b>406</b> |



Smart girls \*

\* CHOOSE

**ARMY  
SPECIAL SERVICES**

**EXCITING CAREERS  
IN FAR AWAY PLACES**

Have fun while you work as a *civilian* in Alaska, Germany/France, Italy, Japan, Korea, Okinawa and the United States. Openings for Arts & Crafts Directors, Librarians, Recreation Leaders and Service Club Supervisors.

Starting salaries from \$3670 to \$5440 per year.

**QUALIFICATIONS:**

Single girls, minimum age 23; maximum age restrictions based on particular situations, duties and responsibilities may be imposed; combination of college degree and experience for all positions.

If you meet these basic requirements write for complete brochure

**The Adjutant General  
Department of the Army  
Washington 25, D. C.  
Attention: AGMZ-R (G12)**



**"The Choice of Those Who Play The Game"**

The MacGregor Co. • Cincinnati 32, Ohio  
FOOTBALL • BASEBALL • BASKETBALL • GOLF • TENNIS

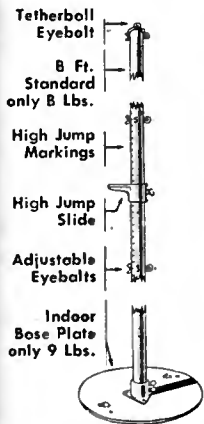

**NEW! jayfro  
Multi-Purpose  
ALUMINUM  
STANDARD**

Use it  
12 Ways!

- Interchangeable  
Indoors and Outdoors for
- VOLLEY BALL • SAGMINTON
  - TENNIS • PAQOLE TENNIS
  - HIGH JUMP • TETHERBALL
- ✓ Official specifications
  - ✓ Lightweight
  - ✓ Easy to Install and move
  - ✓ No maintenance
  - ✓ Six different models



**jayfro  
BASKETBALL  
STEEL CHAIN  
NETS**

3 Years Guarantee!  
outdoors or indoors

Also Featuring Jayfro's Custom Built  
New and Improved!

- ✓ PADDLE TETHERBALL SETS
  - ✓ TETHERBALL POLES
- Revolutionary and Exciting New!
- ✓ SHUFFLEBOARD SETS  
with "RUBBER CUSHIONED" DISCS
  - ✓ OFFICIAL 100% NYLON Basketball  
Nets and Nylon Ball Carriers
- Send for Free Catalog •  
**JAYFRO ATHLETIC SUPPLY CO.**  
Dept. RC, Box 1065, NEW LONDON, CONN.

**"LOADS OF FUN"**



with SAFETY

**HOBBY HORSE SWING**  
Excitement—adventure—fun and exercise. They're all combined in this heavy duty Burke-Built Hobby Horse Swing . . . with complete safety. Three point suspension keeps seat level at all times. No pushing necessary—even a tot can create his own momentum.

**KIDDIE GLIDER**  
A companion piece to the Hobby Horse Swing. Two can find adventure together in Burke's Heavy Duty Kiddie Glider and they can't bong their heads, pinch their legs, or swing taa high.

Burke builds a complete line of swings, slides, and playground equipment for schools, hospitals, institutions, cities and recreation areas, including several new and completely tested revolutionary units for playgrounds everywhere.  
Far complete information write Dept. A



**FREE!**



**THIS  
BIG ILLUSTRATED  
LEATHERCRAFT  
CATALOG**

There is no finer source of materials for Leathercraft projects of all kinds . . . easy-to-assemble kits to enable beginners to make billfolds, gloves, purses, belts and other attractive items . . . top quality tooling and carving leathers for advanced craftsmen. Also complete line of Leathercraft tools, accessories, supplies and instruction books.

**ATTENTION  
METALCRAFT  
HOBBYISTS**

Here is a comprehensive illustrated catalog from which you can make your selection of aluminum and copper in sheets and shapes for many projects; copper, aluminum and brass foil for metal tooling; kilns, colors and kits for metal enameling; instruction books, tools and accessories for metalcraft of all kinds.

SEND TODAY FOR EITHER  
OR BOTH FREE CATALOGS

**J. C. LARSON CO.**

820 S. TRIP AVE., DEPT. 7205  
CHICAGO 24, ILLINOIS

## Books & Pamphlets Received

- BASKETBALL SCORE BOOK FOR GIRLS AND WOMEN — Official NSCWS. American Association for Health, Physical Education, and Recreation, 1201 Sixteenth Street, N.W., Washington 6, D. C. Unpagged. Paper \$.75.
- CHAMPIONSHIP BASKETBALL (Second Edition), Adolph F. Rupp, Prentice-Hall, Englewood Cliffs, New Jersey. Pp. 225. \$4.95.
- DEAR GARBAGE MAN, Gene Zion (pictures by Margaret Bloy Graham).

### INDEX OF ADVERTISERS

|                                                                          | PAGE               |
|--------------------------------------------------------------------------|--------------------|
| American Association for Health, Physical Education and Recreation ..... | 267                |
| American Playground Device Company .....                                 | 255 & 271          |
| Army Special Services .....                                              | 273                |
| Association Films, Inc. ....                                             | 267                |
| Beltz Engineering Laboratories .....                                     | 265                |
| The J. E. Burke Company .....                                            | 273                |
| California State Personnel Board .....                                   | 274                |
| Peter Carver Associates .....                                            | 260                |
| Castello Fencing Equipment .....                                         | 245                |
| Chicago Roller Skate Company .....                                       | Outside Back Cover |
| Crown Publishers .....                                                   | 248                |
| Dennison .....                                                           | 251                |
| Greenwich Book Publishers .....                                          | 274                |
| W. D. Griffin Company .....                                              | 265                |
| H. & R. Manufacturing Company .....                                      | 271                |
| Bart Haigh .....                                                         | 271                |
| Harvard Table Tennis Company .....                                       | 241                |
| Hillerich & Bradsby .....                                                | Inside Front Cover |
| Hillyard .....                                                           | 269                |
| Ideal Specialties .....                                                  | 265                |
| Jamison Manufacturing Company .....                                      | 251                |
| Jayfro Athletic Supply Company .....                                     | 273                |
| Kalah Game Company .....                                                 | 275                |
| J. C. Larson Company .....                                               | 273                |
| The MacGregor Company .....                                              | 273                |
| Mal's Recording Service .....                                            | 245                |
| McGraw-Hill Book Company .....                                           | 275                |
| Monroe Company .....                                                     | 265                |
| National Rifle Association .....                                         | 247                |
| Newcomb Audio Products Company .....                                     | 242                |
| Nissen Trampoline Company .....                                          | 247                |
| Parks & Recreation .....                                                 | 275                |
| Rawlings Sporting Goods Company .....                                    | 251                |
| The Ronald Press Company .....                                           | 271                |
| Superior Industries Corporation .....                                    | 267                |
| Union Metal Manufacturing Company .....                                  | 249                |
| Vogel-Peterson Company .....                                             | 271                |
| Voit .....                                                               | 242                |
| X-acto, Inc. ....                                                        | 255                |

Harper & Brothers, 49 East 33rd Street, New York 16. Unpagged. \$2.00.

FACT BOOK ON CHILDREN IN NEW YORK CITY. Community Council of Greater New York, 44 East 23rd Street, New York 10. Pp. 145 (mimeographed). \$2.00.

FESTIVAL MENUS 'ROUND THE WORLD, Sula Benet. Abelard-Schuman, Ltd., 404 Fourth Avenue, New York 16. Pp. 196. \$3.50.

GARDENING IN A SMALL GREENHOUSE, Mary Noble and J. L. Merkel. D. Van Nostrand Company, 120 Alexander Street, Princeton, New Jersey. Pp. 236. \$4.95.

GUIDE FOR GAMES, A. D. Cyril Joynson. Philosophical Library, 15 East 40th Street, New York 16. Pp. 302. \$7.50.

HOW TO MAKE CONTAINERS AND ACCESSORIES FOR FLOWER ARRANGEMENTS, Jean B. Amer and Alma L. Gray. Hearthside Press, 118 East 28th Street, New York 16. Pp. 128. \$3.50.

HOW TO WIN CHESS GAMES QUICKLY, Fred Reinfeld. Barnes & Noble, 105 Fifth Avenue, New York 3. Pp. 157. Paper \$1.25.

MARIONETTES, Mildred M. Osgood. School Products Company, 330 East 23rd Street, New York 10. Pp. 19. Paper \$.75.

101 FUNNY THINGS TO MAKE AND DO, Paul Castle. Sterling Publishing Company, 121 East 24th Street, New York 10. Pp. 124. \$2.00.

PIONEERS IN SERVICE, Barbara Miller Solomon. Associated Jewish Philanthropies, 72 Franklin Street, Boston 10. Pp. 197. \$3.00.

ROLE PLAYING IN LEADERSHIP TRAINING AND GROUP PROBLEM SOLVING, Alan F. Klein. Association Press, 291 Broadway, New York 7. Pp. 176. \$3.50.

SKETCHING AND PAINTING INDOORS, Percy V. Bradshaw and Rowland Hilder. Studio-Crowell, 432 Fourth Avenue, New York 16. Pp. 96. \$6.00.

TUMBLING TECHNIQUES ILLUSTRATED. Ted Burns. Ronald Press, 15 East 26th Street, New York 10. Pp. 96. \$3.00.

YACHTING WORLD ANNUAL — 1957. Philosophical Library, 15 East 40th Street, New York 16. Pp. 192. \$10.00.

YMCA STANDARDS: STANDARDS FOR ADULT PROGRAM IN THE YMCA; STANDARDS FOR YMCA YOUTH PROGRAM (Revised 1956). Association Press, 291 Broadway, New York 7. Pp. 45 each. \$.75 each.

## Periodicals

MODEL AIRPLANE NEWS. 551 Fifth Avenue, New York 17. Published monthly; single copies \$.35; \$3.50 per year.

## Magazine Articles

CALIFORNIA PARENT-TEACHER, *February 1957*

Are We Mice or Men? (Television) *Mrs. E. J. Ash.*

INDUSTRIAL SPORTS AND RECREATION, *February 1957*

Making a Speech? *Wood Victor.*

NATIONAL PARENT-TEACHER, *March 1957*

Getting Tough Doesn't Help (Juvenile delinquency), *Elizabeth McCain.*

Safeguarding Children's Rights: A Report of the National Congress Conference on Juvenile Protection

NEA JOURNAL, *April 1957*

There is Always Room for Beauty *Ruth K. Carlson.*

\_\_\_\_\_, *May 1957*

The Gift of Time (Coming changes in American life), *August Heckscher.*

PARENTS', *May 1957*

Day Camp in the Driveways (Recreation in a housing project), *Betty Friedan.*

SCHOOL ACTIVITIES, *February 1957*

Developing Potentialities in the Extraclass Activities, *Robert L. Gantert and Dale Hunter.*

Do School Activity Programs Build Better Intergroup Relations? *Grace Graham.*

What's Wrong with Athletics, *Albert M. Lerch.*

\_\_\_\_\_, *March, 1957*

An Early Childhood Play Program, *Milton V. Rose, Gertrude Rubinowitz, and Diane Firestone.*

## BOOK MANUSCRIPTS

### CONSIDERED

by cooperative publisher who offers authors early publication, higher royalty, national distribution, and beautifully designed books. All subjects welcomed. Write, or send your manuscript directly.

**GREENWICH BOOK PUBLISHERS**  
Attn. Mr. Hitchcock 489 Fifth Avenue  
New York 17, N. Y.

### RECREATION THERAPIST

in California State Hospitals. Fifteen new positions are open to college graduates with major in Recreation or Recreation Therapy and supervised field work. Opportunities for advancement from \$376 to \$644 a month. Interviews at National Recreation Congress, Long Beach, September 29 to October 4. Inquire at Registration Desk for Lee Hetsel, State's representative, or write California State Personnel Board, 801 Capitol Avenue, Sacramento, Calif.

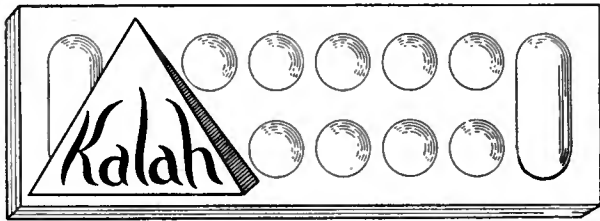

REG. U.S. PAT OFF. 8/28/'45  
Pat. No. 2,720,362; D.165,739; 165,634

TWO SPONSORS OF THE 39th NATIONAL RECREATION CONGRESS APPRECIATE KALAH:

- Initial order for 100 No. 14 B KALAH Games from the LOS ANGELES COUNTY DEPARTMENT OF RECREATION
- 150 KALAH Games used by the LONG BEACH UNIFIED SCHOOL DISTRICT

ALSO

- BOSTON (a typical case) started five years ago with one KALAH game for each of 90 centers. Repeat orders each year since for a number of games so there are now several KALAH games for each playground.

SEE UNUSUAL EXHIBIT AND ASK FOR DEMONSTRATION AT BOOTH NO. 30

Copy of simple rules reprinted from 1956 UNICEF Recreation Kit supplied free upon request.

KALAH IS POPULAR IN SCHOOLS, COMMUNITY CENTERS, AND ON PLAYGROUNDS ACROSS THE NATION.

**KALAH GAME CO.**  
HOLLISTON, MASS.

★ **FOUR IMPORTANT**  
*McGraw-Hill* **GUIDES**



for Recreation Leaders and Teachers

**PLAY ACTIVITIES FOR BOYS AND GIRLS (6-12)**

*A Guide for Teachers, Parents, and Recreation Leaders*

By **RICHARD KRAUS**, Columbia University. 250 pages, \$4.95

This new book of timely interest describes the underlying values of youthful play, and gives examples of successful play programs. It gives many specifically helpful suggestions and guides for working with groups of children as well as clearly-written directions for a wide variety of activities including active and inactive games; musical play and singing; folk and creative dancing; arts and crafts; and dramatics. Recent advances on play programs and up-to-date material on childhood development are included.

★ ★ ★

**RECREATION LEADER'S HANDBOOK**

By **RICHARD KRAUS**. Series in Health Education. Physical Education and Recreation. 312 pages, \$5.75

This outstanding work provides a practical, down-to-earth discussion of social leadership objectives and techniques applied to the recreation needs of groups of all sizes and ages. It covers the background of social recreation in this country, the role of recreation in everyday life, leadership objectives and techniques in working with recreation groups, and a wide variety of time-tested acceptable materials. There is an extensive treatment of program planning to meet the needs of different types of groups.

★ ★ ★

**INDUSTRIAL RECREATION**

*A Guide to Its Organization and Administration*

By **JACKSON M. ANDERSON**, National Industrial Recreation Association. Series in Health Education, Physical Education, and Recreation. 394 pages, \$5.00

The first complete book on the increasingly important subject of industrial recreation. It is intended as a guide to recreation directors in administering employee recreation programs, and for those who wish to study its organization and administration. In addition to specific recommendations on planning and initiating a program, its activities, leadership and financing, there is a thorough discussion of the history of employee recreation and its benefits to industrial relations.

★ ★ ★

**INTRODUCTION TO COMMUNITY RECREATION**

By **GEORGE D. BUTLER**. *McGraw-Hill Series in Sociology and Anthropology*. Second Edition. 548 pages, \$6.00

A popular book dealing with those forms of recreation which require a large degree of organization and leadership, and in which participation plays an important part. All aspects and phases of community recreation are presented, with recent developments included. Recreation is analyzed and a comprehensive bibliography is offered to facilitate reference work. It is a clear and well-organized text, without a peer in community recreation.

the *Management Journal*  
*Parks*  
**RECREATION**  
MAGAZINE



FOR:

- ▶ You
- ▶ Your Board
- ▶ Your City Officials
- ▶ Your Key Personnel
- ▶ Your Informed Lay Supporters

**FOR PARK AND RECREATION SUPERINTENDENTS . . .** techniques described by practical men in the field.  
**BALANCED EDITORIAL FORMULA . . .** the voice of the professional on land acquisition, design, construction, recreational usage, administration and maintenance . . . a complete coverage.  
**A QUALITY PRODUCT . . .** fine paper, printing, photos, maps and editorial approach.

**PARKS & RECREATION . . .** only national magazine designed for both park and recreation administrators.  
**EACH MONTH . . .** the most "referred to" publication in its field . . . a must for your reference library.  
**ALL USABLE INFORMATION . . .** no fiction, no "fairy tales" avidly read from cover to cover . . . send for your free sample and judge for yourself.

SERVING THE PARK AND RECREATION FIELDS SINCE 1917.

**SUBSCRIPTION RATES**

One year . . . . . \$ 5.00  
Two years . . . . . 9.00  
Three years . . . . . 13.00  
Groups of four or more—one year 54.00 each per year.

**PARKS & RECREATION**  
Department RN  
Oglebay Park  
Wheeling, West Virginia



publisher

SEND FOR COPIES ON APPROVAL

**McGraw-Hill BOOK COMPANY, Inc.**

330 West 42nd Street, New York 36, N. Y.

# NEW

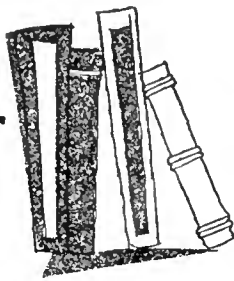

# PUBLICATIONS

*Covering the Leisure-time Field*

**"Where Did You Go?" "Out."  
"What Did You Do?" "Nothing."**

Robert Paul Smith. W. W. Norton & Company, 55 Fifth Avenue, New York 3. Pp. 124. \$2.95.

This delightful book, well-titled, is all about how it was when you were a youngster—and how things have deteriorated since. What has happened to the magic of childhood?

It is written by someone with tender memories and a humorous, heartwarming style, and it is bound to appeal to anyone who was ever small and believed that the grownup was the natural enemy of the child, and to anyone who once called marbles "immies," or played mumbly-peg, or collected horse chestnuts, round stones, or bruises. It offers information about youngsters, in such a way that it is sheer fun to read.

"The thing is," writes the author, "I don't understand what kids do with themselves anymore . . . I was with a bunch of kids a week ago, ranging in age from ten to fourteen (to forty-one, counting me) . . . I said to them, 'How about a game of mumbly-peg? And can you believe that not one of these little siblings knew spank-the-baby from Johnny-jump-the-fence?'"

This is a "natural" for parents, leaders, and all the young-in-heart.

## **Schools for the New Needs Educational, Social, Economic**

F. W. Dodge Corporation, 119 West 40th Street, New York. Pp. 312. \$9.75.

In view of the rapidly expanding school-construction program and the increasing emphasis upon the use of school buildings for community recreation, it is important that recreation authorities become familiar with trends in schoolhouse design. This volume, covering sixty-six new school plans, contains material previously published in the *Architectural Record*, and is an excellent source for information on the design and construction of school buildings. Many of the illustrations and plans relate to facilities commonly used in connection with the community recreation program.

In view of the current emphasis upon cooperative planning between school

and city authorities, it is disappointing to find little indication in the volume that such planning has a place in the development of the school plant. It is possible that many of the school buildings described have been designed on the basis of cooperative planning—one specific example is a junior high school in Seattle—but most of the general articles contain no reference to planning for community use, let alone cooperative planning to this end. In spite of these limitations, the profusely illustrated volume merits careful study.

## **Believe and Make-Believe**

Lucy Sprague Mitchell and Irma Simonton Black, editors. E. P. Dutton & Company, 300 Fourth Avenue, New York 10. Pp. 190. \$3.00.

Above all, children love to listen to spontaneous stories. In lieu of a parent or teacher who can make up stories for Johnny with him as the hero, *Believe and Make-Believe* is a fine substitute. It can be a means of helping the adult to see the value of the story in supplying magic and glamour to everyday routine and to see every day through the child's eyes. It can also be a means of stimulating the adult to creative compositions of his own to satisfy the needs of his child or his group.—*Grace Stanistreet, director, Children's Theatre, Adelphi College, Garden City, New York.*

## **Social Growth Through Play Production\***

Jack Simos. Association Press, New York City, New York. Pp. 192. \$3.75.

In this stimulating and instructive book, Mr. Simos is asking that we accept what may, at first, be considered a new frontier in drama. And yet this is only apparently so, for drama, by its very nature, has always contributed directly or indirectly to the discovery of new frontiers of human growth and understanding.

This is not just another book about drama or drama techniques; neither is its use designated for any specific

\* Available from NRA Recreation Book Center, 8 West Eighth Street, New York 11, N. Y.

group or professional area. It uses for its point of direction and premise not so much *what* we do as *why* we do it, for Mr. Simos believes that, to be effective, "inner justification" is the first approach. He addresses himself to the social worker, teacher, recreation leader, drama director, or any person or persons desiring to chart individual and group experiences through drama activity.

To delineate and make clear drama's part in social growth, he brings together what we may at first consider unrelated fields—play production and social work. In both fields, however, knowledge of human nature, human behavior and life are sought, though purposes and motivations for acquiring it may differ.

It is not suggested that the drama director consider play production as therapy, but rather that he recognize the great therapeutic value of such an activity in growth and development. On the other hand, the social worker may use such a tool in helping "his client with personal problems." This is the basic idea expressed in the *why*.

The remainder of the book gets down to cases in a step by step method of creatively directed play production. Concrete examples drawn from experiences in a community center, college and treatment center give detailed information on the process—the *how*.

Mr. Simos is a student of both drama and social work, having studied widely in both fields. If one believes that drama at its highest and best may become a social force, this is a book of great value.—*Grace Walker, NRA drama and creative recreation specialist.*

## **Play Activities for Boys and Girls\***

Richard Kraus. McGraw-Hill, 330 West 42nd Street, New York 36. Pp. 236. \$4.95.

This book is organized into two major sections. The first is on "Guiding Children's Play"—the value, the technique of leadership, the settings, the reasons why children select certain activities. This section could be the basis for a series of staff meetings.

The second section deals with activities, from active games on through creative rhythms, dancing, music, nature activities, special events and so on. A chapter on evaluating children's play and a carefully selected listing of suggested reading make a fitting conclusion to this well-organized book.

The publisher has given it an attractive binding, excellent paper, very legible print. The result is a book that belongs in any recreation library.

# Recreation Leadership Courses

Sponsored by the National Recreation Association  
and  
Local Recreation Agencies

**September, October and November, 1957**

HELEN M. DAUNCEY  
Social Recreation

Abilene, Texas  
October 21-24

Scott Fikes, Director of Parks and Recreation, Fair Park

RUTH G. EHLERS  
Social Recreation

Canton, Ohio  
October 28-31

C. W. Schnake, Recreation Director, Memorial Auditorium

State of Vermont  
November 5-14

Mrs. A. O. Brungardt, Vermont Director of Recreation, Montpelier

ANNE LIVINGSTON  
Social Recreation

Athens, Ohio  
September 16-17

Miss Margaret Deppen, Dean of Woman, Ohio University

FRANK A. STAPLES  
Arts and Crafts

Klamath Falls, Oregon  
October 21-31

Robert Bonney, Director, Parks and Recreation, City Hall

---

Miss Dauncey will be conducting social recreation courses in the Southwest Area October 14-November 21. For more information as to location of these courses, write directly to the National Recreation Association, 8 West 8th Street, New York 11.

---

Mr. Staples will be at Air Force Bases conducting two-week arts and crafts courses as follows: November 4-14, Warren Air Force Base, Chyenne, Wyoming; November 18-28, Lowry Air Force Base, Denver, Colorado. For further details, communicate with the Air Force Regional Representative, Howard Beresford, 3055 Bellaire, Denver, Colorado.

---

Miss Dauncey and Mr. Staples will be in attendance at the 39th National Recreation Congress, Long Beach, California, September 30-October 4.

---

Attendance at training courses conducted by National Recreation Association leaders is usually open to all who wish to attend. For details as to location of the institute, contents of the course, registration procedure, and the like, communicate with the sponsor of the course as listed above.

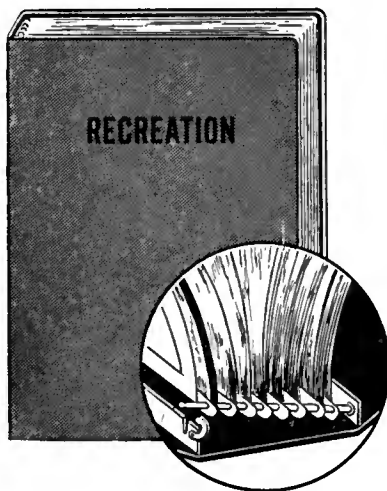

**Order NOW and SAVE!**

## BINDERS for *Recreation*

- Blue heavy simulated leather stamped in gold
- Each holds one year's issues
- Opens flat for changes

1954, 1955, 1957, 1958 and Undated

**\$3.00 each**

After January 1, 1958 the price will be \$3.50

RECREATION MAGAZINE, 8 West Eighth Street, New York 11

# MORE PER SQUARE FEET

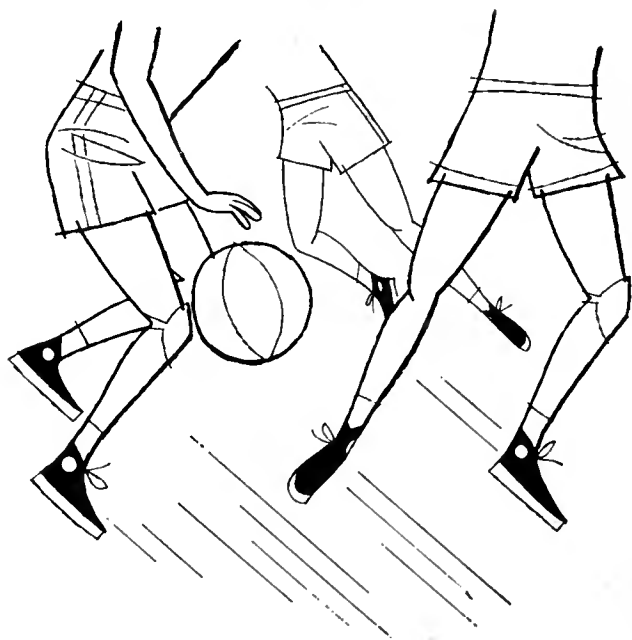

For Exercise and Recreation

## IN YOUR GYM

More youngsters can be *active* in a given area through roller skating than in any other sport...and it's *fun*. Little equipment is needed, little supervision is necessary. That's why more and more schools are making roller skating a definite part of their physical education and recreation programs. Why not inquire today!

NEW DURYTE PLASTIC WHEELS  
ARE KIND  
TO GYM FLOORS



New *Duryte* plastic wheels have a long life and are guaranteed not to mar or scratch gym floors. "Chicago" has a skate designed for every type of floor surface or finish. Write today for free details on roller skating programs and skating equipment.

**"CHICAGO"**

*Roller Skates*

4490-1 West Lake Street, Chicago 24, Illinois

Digitized by Microsoft®

# Recreation

Henry Pfeiffer Library  
Murray College  
Illinois

OCT 7 1957



**CHOOSE  
THE BATS**

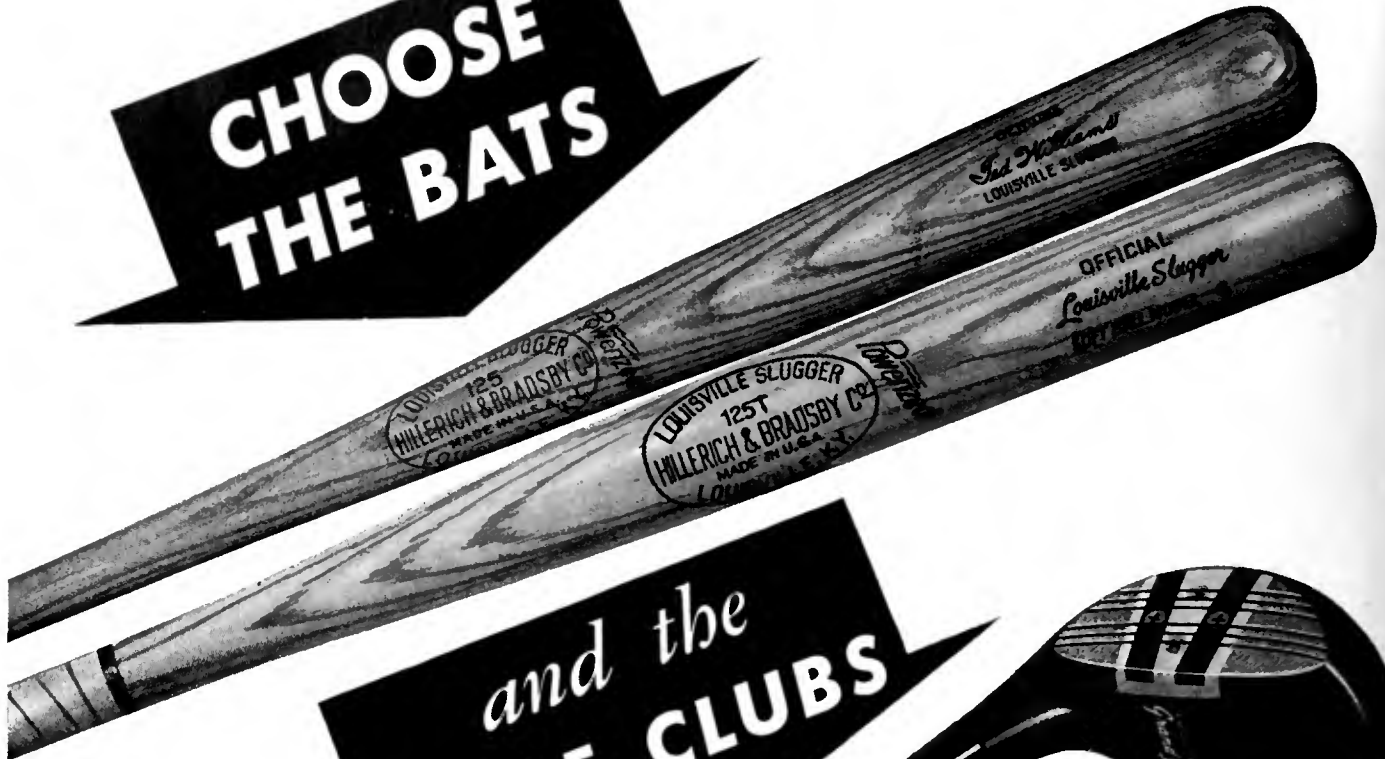

*and the*  
**GOLF CLUBS**



**THAT PACK  
THE POWER**

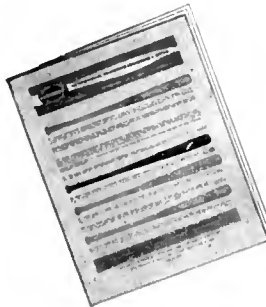

**LOUISVILLE SLUGGER  
BATS  
HILLERICH & BRADSBY CO.  
LOUISVILLE, KY.**

**Louisville  
GRAND SLAM  
Golf Clubs**

**HILLERICH & BRADSBY CO., INC., Louisville 2, Ky.**

When writing to our advertisers please mention RECREATION.





# Ironbound\* FLOORS

# Hillyard FINISHES

Edsel Ford High School, Dearborn, Mich.  
 Architect: Eberle M. Smith Assoc., Inc.  
 Robbins Ironbound\* Continuous Strip\* Maple Floor  
 installed by: Whitcomb-Bauer Flooring, Inc.  
 and finished with Hillyard Floor Treatments

*\* a combination that can take it!*

Manufacturers and installers agree, famous Ironbound\* floors are best conditioned for lifetime service by the application of Hillyard finishes. Superlative Hillyard treatments help these fine floors retain their original beauty, smoothness, toughness, and ease of maintenance over literally generations of hard wear.

## —LEADING AUTHORIZED IRONBOUND\* INSTALLERS CHOOSE HILLYARD FINISHES

## THE MANUFACTURER RECOMMENDS HILLYARD—

- |                                                    |                                                      |
|----------------------------------------------------|------------------------------------------------------|
| The Akron Floors Co.<br>Akron, Ohio                | Rowell-Southern Flooring Co.<br>Miami, Fla.          |
| E. P. Cuthrell Flooring Co.<br>Birmingham, Ala.    | Chas. H. Anderson Floors,<br>Minneapolis, Minn. Inc. |
| National Floors Co.<br>Boston, Mass.               | Storm Flooring Co., Inc.<br>New York City            |
| Canton Floors, Inc.<br>Canton, Ohio                | Federal Hardwood Floor Co.<br>Philadelphia, Pa.      |
| Chas. H. Anderson Floors, Inc.<br>Chicago, Ill.    | R. L. Dresser<br>Raleigh, N. C.                      |
| Austin Flooring Co.<br>Chicago, Ill.               | Yaeger Floor Company, Inc.<br>Rochester, N. Y.       |
| The Ironbound Co. of Cleveland<br>Cleveland, Ohio  | Missouri Floor Company,<br>St. Louis, Mo.            |
| Whitcomb-Bauer Flooring, Inc.<br>Detroit, Mich.    | Acme Floor Company<br>San Francisco, Calif.          |
| Chas. H. Anderson Floors, Inc.<br>Kansas City, Mo. | Southern Hardwood Co.<br>Spokane, Wash.              |
| A. B. Rice Co.<br>Los Angeles, Calif.              | G. E. Weaver Co., Inc.<br>South Bend, Ind.           |
- \* T. M. Reg. Robbins Flooring Co.
- St. Joseph, Mo.**  
 Passaic, N.J. San Jose, Calif.  
 Branches and Warehouse Stocks  
 in Principal Cities

**Robbins FLOORING COMPANY**

GENERAL OFFICE: REED CITY, MICHIGAN • TELLS: 150-1000 • HIGH REED CITY, MO. 10

• HEAVY DUTY AND INDUSTRIAL WOOD FLOORS

MANUFACTURERS OF:  
 "IRONBOUND"  
 "CONTINUOUS STRIP"  
 "PARADE" FLOOR  
 UNIT WOOD BLOCK  
 HERRINGBONE OF H. F. M. A.  
 FULLY REBUILT  
 REPAIRS  
 REFINISHES

NOVEMBER 10TH, 1954 REED CITY, MICHIGAN

HILLYARD  
 ST. JOSEPH, MISSOURI

FOR STY. AND FOR THE  
 WILL NEVER FEEL

"It may be of interest to you that we have in our personal contacts over the past several years, always recommended the Hillyard Products and Hillyard Service, not only to our floor installers across the country, but to architects, owners and the like. I know several of our Ironbound installers use Hillyard's exclusively. We always feel perfectly confident when we recommend Hillyard's, as we know our customer will be getting the best."

### HILLYARD, St. Joseph, Mo.

Without obligation, please have my nearby Hillyard "Maintaineer®" (trained floor expert) show me the treatments that will do most for my floors, while cutting maintenance costs.

Name.....

Institution.....

Address.....

City..... State.....



## Things You Should Know . . .

▶ **DON'T FORGET UNICEF'S PROGRAM IDEAS** for Halloween. If you have not received, as a member of the NRA, your copy of their new *The Trick is to Treat* along with your Membership Letter, write to the U. S. Committee for UNICEF, United Nations, New York.

▶ **A CHEMICAL MAY SAVE WATER FOR CITIES** according to *American Municipal News* of the American Municipal Association. Covering a reservoir with a thin layer of a chemical—hexadecanol—locks in the water, saving twenty-five to thirty per cent of the water now lost by evaporation, studies by the U. S. Reclamation Bureau show. The chemical spreads automatically on the water's surface. Tests so far indicate it is non-toxic, and the cost appears to be small—less than sixty cents an acre of water.

▶ **SINGLE COPIES OF EACH SUBJECT OF RECREATION Magazine Bibliographies** are available free at the NRA Consultation Center in the Municipal Auditorium, Long Beach, during the National Recreation Congress. The collected set of *Bibliographies* is also available. The new, revised edition costs \$1.00 this year.

▶ **THE TENNESSEE DIVISION OF STATE PARKS** has been found qualified to purchase federal surplus personal property. From best available sources, it is thought that Tennessee State Parks is the first park and recreation agency in the country to be so qualified.

The basis for such qualification is contained in the recent amendment to Public Law 655, "Federal Surplus Personal Property is Available for Civil Defense Purposes. . . ." The Tennessee State Director of Civil Defense found state parks eligible because "of the vast and strategically located state park acreage and facilities spread throughout Tennessee which would be invaluable in the event of local, regional, state or national emergency."

▶ **THE RECOMMENDATION** was made recently by Charles Silver, president of the New York City Board of Education that the city's schools remain open every day of the year for recreation purposes. In line with this, the community

recreation program in Long Beach, California—National Recreation Congress city—is a municipal-school coordinated program. See article on page 252 of the September RECREATION.

▶ **THE LARGEST EDITION** of the *Playground Summer Notebook* ever issued by the NRA Program Department—the 1957 edition—was sold out completely by June 15. The department regrets that many leaders had to be disappointed, and urges that orders for the 1958 edition be sent in by May 1 at latest.

▶ **HAVE OUR READERS FORGOTTEN** that it is their own letters which make up the Letters-to-the-Editor pages in RECREATION? Isn't any of the magazine content worth discussing? The bottom of the barrel is now in sight, so think it over. There seems to be a general trend toward letting George do it, but according to an old Chinese proverb: "No lettee, no pagee!"

### World Neighboring

The art of good neighboring must be applied in the world community, as well as in our villages and towns, if every man is to live in peace and harmony with other men in this age of rapidly contracting distances. In this month of United Nations Day and Week (October 24 and October 20-24), therefore, it might be well to ponder this truth and

work it into our programs. It is said:

● The art of neighboring has at its core a willingness to take people pretty much as they come; to let them, within broad limits of tolerance, be themselves and live their own lives. . . .

It was as a neighbor that Robert Frost wrote in "The Star-Splitter,"

*If one by one we counted people out  
For the least sin, it wouldn't take us long  
To get so we had no one left to live with. . . .*

We know these things about neighboring, we Americans. We have learned them by experience: respect for privacy and for individual differences; the sort of undemanding, outreaching good will that gives friendship a chance to grow; readiness to give help when help is needed, regardless of personal liking or not liking; and readiness to pool our efforts as neighbors on behalf of the larger home we share.

Are not these the arts of world neighboring also?—Bonaro W. Overstreet in "A World of Neighbors," *National Parent-Teacher*, June 1957 issue.

● If there is any solution to the problems of living in friendship and in dignity with others, and we must surely hold fast to the faith that there is, that solution will be found, not in weapons or in charters, but in the hearts and minds of men.—Dr. J. B. Kirkpatrick, Director of the School of Physical Education, McGill University, in an address to the Ontario Recreation Association.

● Know you one another and thus you fulfill the law of peace. Share your songs, your music, your art, your sports, your "heart's desire," and you know you have shared what has greatest lasting value. Begin with what we have in common and the rest seems less important.—Howard Braucher in *Treasury of Living*.

● The East and West approach life from quite different angles. . . . When either has the vision to welcome the other's contribution, then the solution of one of the most fundamental of human tensions will be in sight.—Sir Harry Lindsay, "Colour Tension," *Hibbert Journal*, London, July, 1955.

● *Together is a lovely word  
Getting together is a beginning  
Being together is happiness  
Thinking together is unity  
Working together is success. . . .*

Quoted from *What's Cookin'* published by the Recreation and Park Commission of East Baton Rouge Parish, Louisiana, Aug. 1, 1953.

### The Symbol That Means High Standards

You have probably noticed the ABC symbol which is carried regularly on our Contents Page. This symbol means that RECREATION Magazine meets the high standard required for membership in the Audit Bureau of Circulations; that it has eliminated guesswork from statements of circulation information.

We must know how many subscribers we have, who they are and what they do, so that we may plan each issue to meet reader needs and interests, AND so that our advertisers may be assured of reaching the vital concerns of audience, and of receiving reliable circulation facts. A regular ABC audit establishes these facts for us, and helps us to build a better magazine for you.

The ABC symbol is an honor emblem! We are proud to display it, and happy to observe October as ABC Month!

If you are an advertiser as well as a reader and would like to see a copy of our latest ABC report, please let us know.

# Recreation\*



THE MAGAZINE OF THE RECREATION MOVEMENT

*Editor in Chief, JOSEPH PRENDERGAST*  
*Editor, DOROTHY DONALDSON*  
*Editorial Assistant, AMELIA HENLY*  
*Business Manager, ALFRED H. WILSON*

ASSOCIATE EDITORS  
*Recreation Administration, GEORGE BUTLER*  
*Program Activities, VIRGINIA MUSSELMAN*

Vol. L. Price 50 Cents No. 8

**On the Cover**

A PUEBLO POTTER. Recreation activities can do much to help preserve the cultures of the many peoples who make America their home. One of the ways this can be done is by displaying their crafts, arts, and other products, and by means of folk festivals, participating in their games, music and folk dancing. (See "Folk Dancing—The Old and the New" on page 284.) Here, a living demonstration calls attention to the beauty of American Indian art. Photo: New Mexico State Tourist Bureau.

**Next Month**

"An Outsider Looks at Recreation," by Harold W. Williams, associate director, Office of Community Services, U. S. Air Force, will certainly be a discussion piece. Mr. Williams is an interesting thinker and has written a straight-from-the-shoulder article. In addition, "Know Your Adolescents," a summary of the Girl Scout survey of adolescent girls; and an excellent article on space for recreation by Robert D. Carpenter, head planner for the Detroit Metropolitan Regional Planning Commission.

**Photo Credits**

Page 285, (upper left and right) *Globe-Democrat*, St. Louis, Missouri, (center and bottom left) New Mexico State Tourist Bureau, Santa Fe, New Mexico, (lower right) Department of Commerce and Industry, Baton Rouge, Louisiana; 288, (upper left) U. S. Army Photo, (lower left) Chicago Park District, (upper and lower right) Official U. S. Air Force Photo; 289, Recreation and Parks Department, Charlotte, North Carolina; 294-6, U. S. Army Photos.

RECREATION is published monthly except July and August by the National Recreation Association, a service organization supported by voluntary contributions, at 8 West Eighth Street, New York 11, New York, is on file in public libraries and is indexed in the *Readers' Guide*. Subscriptions \$4.00 a year. Canadian and foreign subscription rate \$4.50. Re-entered as second-class matter April 25, 1950, at the Post Office in New York, New York, under Act of March 3, 1879. Acceptance for mailing at special rate of postage provided for in Section 1103, Act of October 3, 1917, authorized May 1, 1924. Microfilms of current issues available University Microfilms, 313 N. First Street, Ann Arbor, Michigan.

Space Representatives: Mark Minahan, 168 North Michigan Avenue, Chicago, Illinois; Seymour A. Robbins & Associates, 101 West 55th Street, New York 19, New York; The Jules E. Thompson Company, 681 Market Street, San Francisco 5, California.

Copyright, 1957, by the National Recreation Association, Incorporated

Printed in the U.S.A.



\* Trade mark registered in U. S. Patent Office.

**CONTENTS**

**GENERAL FEATURES**

The Recreation Policy of the U. S. Air Force  
 (Editorial) . . . . . Col. Roland E. Sliker 282

Folk Dancing—The Old and The New. . . Sarah Gertrude Knott 284

Recreation on Parade . . . . . 292

**ADMINISTRATION**

Public Relations in Recreation. . . . . Richard M. Baker 300

Notes for the Administrator. . . . . 303

Research Reviews and Abstracts. . . . . George D. Butler 304

**PROGRAM**

We Celebrate Halloween—But Do We Know Why? . . . . . 287

Adapting Dancing for Senior Citizens. . . . . Cyrus S. Grossman 289

Display and Decoration Ideas. . . . . Mary Frances Sargent 294

How to Make a Mosaic (How To Do It!) . . . . . Frank A. Staples 298

**REGULAR FEATURES**

Things You Should Know . . . . . 278

Letters . . . . . 280

Reporter's Notebook . . . . . 288

Classified Advertising . . . . . 302

Books and Pamphlets Received, Magazine Articles. . . . . 306

New Publications . . . . . 307

Index to Advertisers . . . . . 308

Recreation Leadership Training Courses. . . . . Inside Back Cover

How To Do It! . . . . . See Program

**SQUARE  
DANCE  
ASSOCIATES**

Freeport, N. Y.

*present*

Expert Oral  
Instructional  
Records for

**SQUARE DANCES  
COUPLE DANCES  
AND MIXERS**

for all ages



*Simple progressive*

**TALK-THRU-WALK-THRU**

*method used in thousands  
of schools*

**FOOT TAPPING MUSIC**



- **Rhythms**
- **Folk Dances**
- **Singing Games**
- **Play Party Games**

*for*

**CHILDREN**

pre-kindergarten  
through 3rd grade

78 or  
33 1/3 rpm

SQUARE DANCE ASSOCIATES

BOX 644 FREEPORT, N. Y.

Name \_\_\_\_\_

Address \_\_\_\_\_

City \_\_\_\_\_ State \_\_\_\_\_



*Readers! You are invited to send letters for this page to Editor, RECREATION, 8 West Eighth Street, New York 11—so that your ideas, opinions and attitudes may be exchanged with others on the wide range of subjects of concern to us all. Here is your chance to agree or disagree with the authors of our articles. Keep letters brief—not more than 250 words.*

—The Editors.

**Terminology**

Sirs:

John C. Tanno, a recreation leader in the Phoenix, Arizona, Parks and Recreation Department, submits the word "discardia" in place of "scrap craft." John is the president this year of the Arizona Association of Health, Physical Education and Recreation.

HENRY T. SWAN, *Superintendent of Recreation, Phoenix, Arizona.*

**Encroachment**

Sirs:

Thanks for the June issue of RECREATION.

My struggle to protect the parks of Wilmington has been long and arduous but is beginning to bear fruit. Instead of planning to go through six parks and injure a seventh, they [the highway authorities] are now down to four and it is just possible that I will save still another and get them to listen to reason . . . so, you see, perseverance tells in the long run!

MAURICE DUPONT LEE, *President, Board of Park Commissioners, Wilmington, Delaware.*

**RECREATION'S Birthday**

Sirs:

Some years ago we were informed that "life begins at forty." More recently, we have learned via television that "life begins at eighty." What does this mean for RECREATION, the magazine of the recreation movement, as you so aptly expressed it in your editorial (April 1957)? In mortal terms you are beyond the midpoint of the customary three score and ten; but we should not, and cannot, measure the life of a magazine in such a limited way.

Rather, let us say, "You have reached the first fifty." Let us think of RECREATION as a mature symbol and spokesman for a movement which has grown to a dynamic new concept of life. We are but at the threshold of a recreation-centered form of society whose wishes, needs and expressions are beyond the

limits of our imagination. Only future generations can measure the significance of our humble beginning.

The few pennies which those congressmen gave to the District of Columbia in 1906 "to teach children how to play" have multiplied to over two hundred million pennies in 1956 to teach all mankind how to live in this era of increasing leisure time. And Congress is doing for the District of Columbia what thousands of legislatures, town councils and boards of aldermen are doing for states, cities and counties throughout the nation. Yes, throughout the world, too.

We respect RECREATION. It has become sort of a bible for the thousands of dedicated leaders who are searching for new ways of doing new things, new ways of doing old things, or successful ways of doing anything. Though all of us will not be around to celebrate your centennial issue, we can be sure that as you enter your "second fifty" you are doing so on a foundation unfettered by the whims of chance or the vagaries of the moment.

Please accept our heartiest congratulations to the magazine and its staff.

MILO F. CHRISTIANSEN, *Superintendent of Recreation, Washington, D.C.*

**Helpful to Staff**

Sirs:

April RECREATION contains an article, "Notes on a Summer Experiment," which provokes my interest. Not since Grace Coyle's "The Group Worker in the Recreation Center" (March 1951) has there been an article which is as helpful to staff volunteers assigned to groups. If reprints of the "Notes" are not available, may I please have permission to mimeograph the statement for use with my study committees and for distribution to staff members in our youth recreation agencies?

I am grateful to Mrs. Keat because

she has "done-it-herself."

MRS. MARY HAIGHT, *Staff Executive, Group Work and Recreation Division, Community Council, Portland, Oregon.*

**Letters to Joseph Prendergast**

Sir:

On behalf of the Department of State I wish to express appreciation to you and to the National Recreation Association for extending a leave of absence to Mr. James A. Madison so that he could visit Pakistan under the auspices of our International Education Service.

Mr. Madison has performed an im-

portant service, both to the United States and to Pakistan. Our Foreign Service posts in that country have been high in the praise of Mr. Madison, citing, of course, his obvious professional competence but equally, if not more important, making particular mention of his generous and friendly manner which endeared him to the local population and paved the way for fruitful and valuable discussion and planning.

We appreciate your cooperation on this project and wish to commend Mr. Madison for his distinguished service.

FREDERICK A. COLWELL, *Chief, American Specialists Branch, Lead-*

*ers and Specialists Division, International Educational Exchange Service, U. S. Department of State, Washington, D. C.*

\* \* \* \*

Sir:

The significant contribution of the National Recreation Association to the recent Ninth Annual California Recreation Conference has been mentioned verbally to several representatives of the Association; however, I have been looking forward to expressing our gratitude to you by letter.

Dr. Paul Douglass presented one of the finest general session addresses that I have had the privilege of hearing. He presented a great deal of information but, most of all, inspired us to creative approach in the solution of personnel problems.

The effect on the conference of Wil- lard C. Sutherland was evidenced on many occasions. As a platform guest and speaker preceding Dr. Douglass, as a panel member in several sessions of the conference, and through personal interviews with individuals in the conference, he was able to influence the results of our discussions.

John Collier carried a major load in the program planning. We have received many comments on the quality of almost all the sessions. It was a privilege to have Helen Dauncey, James Madison and Mary Quirk with us.

STERLING S. WINANS, *Director of Recreation, State of California Recreation Commission, Sacramento.*

\* \* \* \*

Sir:

On behalf of Christ Church House, we would like to thank you very much for the help you have rendered us in securing leaders for recreation and group work. Our thanks go out to you, to Mrs. Binger and to all connected with your Association.

NIKITAS CHRYSOSTOM, *House Director, Christ Church House, New York City.*

\* \* \* \*

Sir:

Our department has been visited recently by two representatives from the NRA, Mr. Westgate and Mr. Hay. In both cases these gentlemen showed a sincere interest in our programs and gave much of their time in discussing our local problems.

On behalf of the Anne Arundel County Recreation Department I would like to thank the NRA for its cooperation and interest.

WARREN W. KERSHOW, *Director, Department of Recreation, Annapolis, Maryland.*

# What Action! What Fun!

with America's Newest Playground Sensation

## JUMPING JACKS

- ★ IT'S SAFE
- ★ NO INSTALLATION PROBLEM
- ★ NO MAINTENANCE REQUIRED



patent applied for

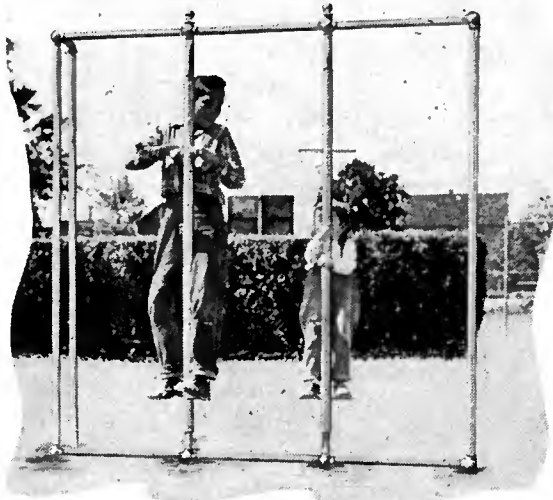

### A STATIONARY VERSION OF THE POGO STICK, AND IT'S SAFE!

Here's the answer to your constant appeal for something new and different at the playground. You should see the kiddies, and the teenagers too, lining up for a chance at this newest playground sensation . . . JUMPING JACKS. Watch their smiles grow broader, and listen to their shouts of glee as they bounce up and down and twirl around at will on the Jumping Jacks. No wonder it meets with instant approval of both, recreational directors and children, alike. And . . . it's safe. The full extent of the vertical travel is only 4 inches. It's ruggedly constructed and stationary. Easily installed and no maintenance required. Attractively decorated in multiple colors. Write today for details. Give the kiddies something new . . . something to satisfy that youthful urge for novel action and healthful exercise. Give them JUMPING JACKS and watch them go, glow and grow.

**WISE ENGINEERING CO.** 165 DELANCY STREET  
NEWARK 5, N. J.  
*Designers and manufacturers of unusual playground and recreational equipment*



# The Recreation Policy of the United States Air Force . . . . Col. Roland E. Sliker

**D**URING WORLD WAR II, when members of the military establishment were concentrated in large numbers at temporary sites and were moved about rapidly in furtherance of the tactical pattern, the psychology of their lives was one of "transiency." In their off-duty time they sought, and were given, mass entertainment and diversions. Generally, there was not time in which to cultivate and harness individual leisure-time interests and skills, with the result that military and civilian agencies tried to do practically everything "for" these people.

Today, the situation has changed radically. Air Force personnel do not now seek merely to be entertained and diverted. They react as settled, but alert and vigorous, citizens. In the main, they are skilled, widely-traveled, responsible, want-to-learn people. A large percentage are married and want the best for their families. They possess a variety of leisure-time interests and skills and are capable of assuming large responsibilities for planning and carrying out their own recreation programs under imaginative stimulation and leadership. In brief, their recreation has become a creative art requiring professional management.

The United States Air Force is convinced that wholesome recreation is a fundamental part of the American way of life, and is determined to provide self-rewarding leisure-time opportunities comparable in terms of variety and quality to those offered in the most progressive civilian community.

The Air Force's conviction and determination rest on two simple, basic premises. First, proper recreation activities improve morale, job performance, character growth and retention. Second, the Air Force is sensitive to its responsibility to the nation for returning to civilian life men, women and children who have continued to grow and improve as citizens.

A significant concomitant of this second point is that skills, interests and attitudes developed in Air Force recreation will be of value to community leaders upon the return of Air Force personnel to civilian life, thus aiding in the improvement of community life and accelerating the spread of the American recreation movement. Obviously, the Air Force does not distinguish between community and military recreation, but rather recognizes their concepts to be correlative and basically identical.

To achieve its recreation goals, the Air Force is supporting its recreation program with commensurate sums of operating funds and giving high priority to the construc-

tion of modern facilities. It has learned, however, that the provision of facilities and funds, without resourceful, efficient management, is not enough. Further, the Air Force realizes that requisite management cannot be accomplished by transient amateurs but demands the acquisition of professionally trained experts. It is necessary, therefore, to establish a progressive recreation system built around experienced civilian leaders, on civil service status, who can give major assistance in planning and supervising a creative program for an entire base community; in making the most productive use of facilities and funds; in capitalizing on the leadership and skills of the members of the military community in "helping themselves"; and in providing dependable continuity in collaborating with the leaders of adjacent civilian communities in expanding the opportunities for Air Force people to participate as partners with their civilian neighbors.

The requirements and advantages of such a system are now being interpreted widely throughout the Air Force. At the time of this writing four major commands have employed experienced professional recreation managers who are assisting in the development of base recreation departments. In addition, the National Recreation Association is cooperating fully and effectively in the Air Force's plans for the enrichment and expansion of recreation programs and opportunities on Air Force bases and in adjacent civilian communities. This collaboration includes interpretation of the career recreation service of the Air Force to colleges and universities and to the recreation profession of America, extensive efforts to enlist individual professionals in the Air Force recreation service, and the training of volunteer leaders in specialized activities.

In all of the interpretation and development now going on, the Air Force is aware that in time some of its command and base recreation managers may accept openings in civilian communities and agencies. In the judgment of the Air Force, an interchange and free flow of recreation leaders will be not only possible but both desirable and normal, since the leadership standards and program concepts of Air Force and civilian recreation are basically the same.

In summary, the three key points of Air Force recreation policy are: (1) the Air Force wants for its people, and believes the nation should want, recreation programs and opportunities equal to the best in the nation; (2) the same high quality of "management" is required in Air Force recreation as is demanded in the many carefully organized systems of defense; and (3) the Air Force desires to be a progressive partner with all other major segments of the American recreation movement. ■

COLONEL SLIKER, a graduate of the Air War College, is chief of the Air Force Personnel Services Division.



**GET ENTHUSIASM!**

*Free... complete kit to organize a gold medal*

**HARVARD TABLE TENNIS TOURNAMENT  
IN YOUR SCHOOL, PLANT OR RECREATION PROGRAM**

Everyone plays in a Harvard Gold Medal Table Tennis Tournament . . . because everyone enjoys this exciting event that serves more players, in less space, without any permanent installation and at lower cost than most other school sports.

We will send, ABSOLUTELY FREE, the Harvard Tournament Kit containing everything you need to organize your own full-participation tournament: Harvard Table Tennis Teacher with instructions, rules and tournament tips; 2 Tournament Charts; complete publicity program and tally sheets.

FREE . . . for your winners, Harvard Gold Medals and award certificates when you complete the tally sheets. Mail the coupon below today.



*Harvard* **TABLE TENNIS CO. 60 STATE ST. BOSTON 9, MASS.**

Gentlemen: R-10  
In order to run a table tennis tournament please send us the FREE Harvard Tournament Kit.

SCHOOL OR ORG. \_\_\_\_\_  
NAME \_\_\_\_\_  
POSITION \_\_\_\_\_  
STREET & NO. \_\_\_\_\_  
CITY \_\_\_\_\_ ZONE \_\_\_\_\_ STATE \_\_\_\_\_

We plan to start our tournament on \_\_\_\_\_  
There will be approximately \_\_\_\_\_ participants.  
We do \_\_\_\_\_, do not \_\_\_\_\_ offer table tennis all year.  
Table Tennis is part of our \_\_\_\_\_ program.  
There are \_\_\_\_\_ in our school or organization.

## *the Old and the New*

*Showing the part the recreation leader can play in helping to preserve the traditional dances of our nation. The folk dancing of many nations, incidentally, can make an excellent United Nations Day or Week observance. UN Week begins October 20, UN Day is the 24th.*

THERE HAS been a challenging folk-song-and-dance-activity movement growing in this country during the last two decades. We are now much more alive to the value of our rich and varied folk songs, music, and dances than we were when the National Folk Festival originated in 1934. There is general, current interest in the question, "What folk songs, dances and legends can we, in the United States, claim as our own?"

Each year, during the five years that the festival took place in Washington, D. C., gay and colorful folk dancers and singers from some thirty states assembled in our nation's capital. Most were from rural communities. Prominent among the groups who originally took part were Indians, British, Irish, French, Germans, Spanish-Americans and Negroes, who had inherited their songs and dances from forefathers making their homes here in early days. Some had created New World songs and dances based upon the old patterns.

From the beginning, the festival also featured worksongs and other lore of our cowboys, lumberjacks, sailors, miners and canal builders, who sang as they blazed the trails, sailed the seas, or did other work necessary in a young and expanding nation.

This rather clear-cut pattern grew more complicated, however, as it became evident that no longer could the programs include only older American groups. There would be value also in claiming, cherishing, and trying to preserve the cultural manifestations of the newer citizens coming to our shores.

The last nine festivals, held in St. Louis, have included Jewish, Polish, Scandinavian, Greek, Lithuanian, Italian and Filipino participants and their

heritages. However, there has been continued emphasis, as far as possible, on those folk traditions which have been longest rooted in America.

Until the end of World War II, the development of folk festivals, and the teaching of folk songs and dances for recreation purposes was gradual. Local and state festivals were on a modest scale; but when peace came and the long tension lifted, a widespread enthusiasm burst forth in unparalleled activity and in giant square and folk dance festivals, especially in the West. The spirit was contagious, and soon there were square and folk dance federations in a number of states, following the lead of California.

For the past ten years or more, each festival has been a law unto itself, each reflecting the special interests of the leaders. It has been difficult to keep the emphasis where it belongs, to make folk festivals reflect the history of our own country and the heart beat of our own people. It has been more difficult to avoid having them become a hodge-podge reflection of many nations, not genuinely expressive of our own.

Standardization has been encouraged by certain groups. Musical recordings have pushed "live" musicians farther and farther into the background. So-called "hillbilly" music floods television and radio, confusing the picture and in many instances replacing genuine folk music, even in states where the traditional music abounds.

Although the situation is somewhat discouraging to those who have special interest in genuine tradition, it is encouraging and hopeful to those who can really appreciate the over-all picture. As long as there is hope, plans can be made to channel and help control the interest to hold and revive the roots of our folk culture.

Those who look beneath the surface can see the influence of three kinds of present-day leaders interested in folklore. If they would join hands for the common good, our folklore could be preserved. The three kinds of leaders are:

*The Purist.* He believes that traditional expressions should not be touched unless it is possible to present them in their original state—what he considers the genuinely authentic form. The purist is, of course, highly important because he helps to set a goal at which to aim. While a festival seldom altogether measures up to his standard, it comes nearer because he exists.

*The For-Fun-Only Leader.* He has no regard for folk expression except to meet immediate needs for recreation and fun. Often this kind of leader has no qualms about changing traditional forms, has no special knowledge of the past or potential future value of any phase of folklore. However, if this type of leader does no more than lighten the load and relieve the tension felt today, he is still serving a very real purpose.

*The Middle-Ground Leader.* He finds real satisfaction in following the traditional as closely as possible in form, substance and spirit, allowing for the inevitable changes which unconsciously come about to make folk creations better meet the needs of the present.

This middle-ground viewpoint is the most logical one to follow, since folk traditions have never remained static. Yet, unless folk songs, dances, legends, and other lore have certain characteristics, they have no right to be classified as folklore. Unless they are genuine, they are not the reflection of the spirit or cultural background of the race or nationality that created them; they are not basic cultures. Unless they measure up to the (Continued on page 286)

---

MISS KNOTT is founder and director of the National Folk Festival.





Left: The Cotton Blossom Singers, from Country Life School, Piney Woods, Mississippi. Negro folklore still forms the chief recreation for several thousand students who work their way through this vocational school which was established by Dr. Laurence Jones. When the day's work is finished and they need recreation, they use the Negro singing games, spirituals, work-songs, legends, riddles, superstitions, traditions, as well as the lively American square dances.



Above: Ozark folks teach their children early in life to dance the special "Ozark Jig." Dances such as these are a part of the annual National Folk Festival. The United States has a better chance than most countries to revive its folk legacies. Thousands are having fun with folk dances and songs recently learned and appreciated, especially city dwellers.



The American Indian has a ceremonial for every incident in life from birth to death. Many of these still have meaning for the Indian. The "Maidens' Dance" or "Crown Dance," for instance, still marks the social debut of the Apache girl. Here, the Mescalero Apache tribe of New Mexico presents the dance on a hill which overlooks the Gallup inter-tribe ceremonial grounds in New Mexico, annual tribal meeting place for powwows and festivities.

Below: Tennessee singing games, Agricultural Extension Division, Mountains of Tennessee. The singing game continues in this state because of the influence of Fred Colby of the University of Tennessee, who has made folk activities for farm families a lifetime interest. He has proved that, with a little leadership, they can serve a real purpose.

Spanish dancers and flower girls at the Santa Fe Fiesta in New Mexico. The Spanish-American folk-songs of that state are taught for recreation purposes by singer Jenny Vincent, in cooperation with the local agencies and schools. Our folk traditions have never remained static. They change with the times.



Acadian boys and girls present a French answering-back song in Abbeville, Vermilion Parish, Louisiana, during one of the preliminary folk festivals which lead up to the Acadian Bicentennial Folk Festival program. It has become increasingly important that we preserve also the cultural manifestations of the nation's newer citizens along with those brought by our earlier settlers. More and more people from other lands have been included in community folk fetes.



genuine form, they are not likely to last and will go the way of all fads.

There are many more problems now than when the National Folk Festival was originated, yet there is more challenge—more definite knowledge of the value of folklore and of the festival movement. Both are considered important now in most countries of the world.

A resolution passed by the Eighth International Folk Music Council which met in Oslo, Norway, in July, 1955—with thirty-one nations represented, including the United States—was recently sent to all countries of the world. It emphasized the importance of folk traditions for social and artistic purposes, as a basis for artistic creations and as a medium through which we might achieve better international understanding—and peace. It warned of the danger of these basic cultural forms passing away before a new civilization and urged all education, recreation and cultural organizations to collect and record them and to make use of them now.

In the United States, it will undoubtedly take the conscious effort of the three types of leaders, as well as that of organizations which have the proper setup to reach down into the communities. They must work cooperatively toward developing a well-planned, continuous program designed to dignify and build pride in traditional forms and show the folks who have inherited them that they have not lost their usefulness for recreation and education purposes. It is highly important that such a program be developed and carried on in rural areas and small towns where the traditional forms are being most neglected by the people to whom they especially belong. Just now, in our country and in most others, it is the city dwellers who are much more interested and active in the utilization of folklore.

It is doubtful that many of the newly created songs and dances springing up at present, more city-made than country-born, will ever build the kind of cultural foundation to influence the future.

Teaching is one of the necessary ways to make folk traditions meet present-day needs. There is a quality and style—not quickly, if ever, acquired—which new folk singers and dancers can get only from association and learning directly from the older persons who have inherited it. There are many dancers left who have special styles of square or folk dances, typical of their own particular regions. There are singers who have a style of singing which belongs only to those who have known the songs long and sung them all their lives. There are Negro, Polish, Spanish, French, Jewish, Italian, German, and other groups, old and new Americans, whose renditions of their traditional lore reflect the inexplicable spirit of the race or nationality of the creators. They are being too widely overlooked by recreation leaders, schools, churches, farm organizations and others who would profit from using the traditional along with newer or different kinds of recreation.

Cannot the old and the new go hand in hand? ■

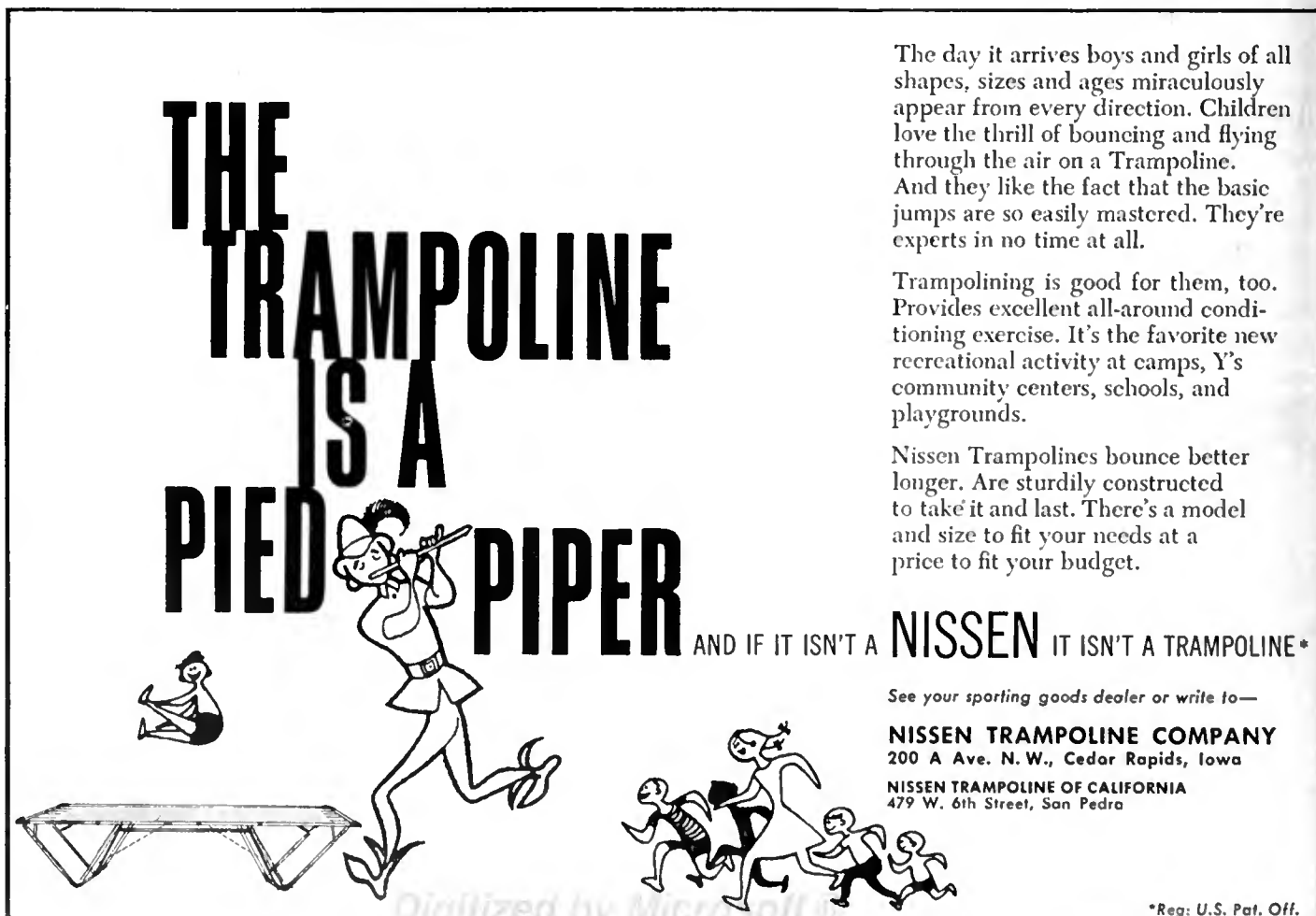

**THE TRAMPOLINE IS A PIED PIPER** AND IF IT ISN'T A **NISSEN** IT ISN'T A TRAMPOLINE\*

The day it arrives boys and girls of all shapes, sizes and ages miraculously appear from every direction. Children love the thrill of bouncing and flying through the air on a Trampoline. And they like the fact that the basic jumps are so easily mastered. They're experts in no time at all.

Trampolining is good for them, too. Provides excellent all-around conditioning exercise. It's the favorite new recreational activity at camps, Y's community centers, schools, and playgrounds.

Nissen Trampolines bounce better longer. Are sturdily constructed to take it and last. There's a model and size to fit your needs at a price to fit your budget.

See your sporting goods dealer or write to—

**NISSEN TRAMPOLINE COMPANY**  
200 A Ave. N. W., Cedar Rapids, Iowa

**NISSEN TRAMPOLINE OF CALIFORNIA**  
479 W. 6th Street, San Pedro

\*Reg. U.S. Pat. Off.

# We Celebrate but Do We

**H**ALLOWEEN is one of the seasonal celebrations, known by many names in many lands, that has come down to us from the shrouded past. In one form or another, it has been celebrated for more than five thousand years.

Meaning "hallowed" or "holy evening," Halloween marks the ending of the harvest season and the coming of winter. The fall, with its harvest of fruits and grains, was a logical time for feasting. It also incorporated ancient worship of the elements—water, wind, fire and, most of all, the sun—which included sacrifices, rituals, and belief in supernatural forces for good and evil.

Much of the Halloween folklore and superstition stems from the Druids, a powerful religious order in ancient Gaul, Britain, and Ireland credited with magical powers. The building of sacrificial bonfires (the fires probably represented the sun) was a Druid custom at that season.

The modern prank of chalking the backs of passing strangers results from an old custom of boys going through the streets of the town marking the backs of strangers and the doors of houses with white chalk to signal the end of "The White God"—warm sun.

People believed that on this hallowed eve, the spirits of those who had left the earth prematurely, or from uncertain causes, roamed the fields and marshes, the paths and deserted lanes. It was also believed that for forty-eight hours after the commencement of this night the souls were released from purgatory, free to revisit their old homes, and that everything possible should be done to make their visit welcome. Dressing up like ghosts, goblins, witches, and other supernatural beings stems from this.

The missing gates and gateposts supposedly had been borne off by the departed souls, winging their way through the gates of death to the life beyond, or else they were stolen by evil spirits. This accounts for the vandalism which



developed on this night.

In the eighth century, as Christianity spread, November first was designated by the Church as a day for honoring all of the lesser saints, the holy men and the martyrs whose records have not survived. As was often the case, merry-making and feasting preceded a serious holy day; and the ancient customs, superstitions and legends have become intermingled in our cultural background.

Our "trick-or-treat" stems directly from the old custom of children making the rounds of the countryside in quest of "soul-cakes," apples, nuts and money. Their original song was something like:

A song for a soul-cake  
A song for a soul  
Please give us a soul-cake  
For a year for a soul.

Through the centuries, feasting has ceased to be a part of Halloween except in the symbols still used in decorating—pumpkins, cornstalks, gourds, apples—and the collection of "goodies" instead of soul-cakes.

Halloween has become a community social event, largely through the nationwide efforts of local recreation departments, instead of a night of superstitious



# Hallowe'en . . . Know Why?

terror. No one believes any more that evil spirits lurk the shadows, that witches mount their broomsticks and fly into the night—but it's fun to *pretend* to believe, once a year, at Halloween.

## Have You Tried . . . ?

*A Dance of the Harlequins*—An exciting figure for a party theme which defies the ghosts and spooks of Halloween is that of the masked Harlequin, who centuries ago came into being in Italian and French comedies, as the spirit of mystery and intrigue. Attired in his brilliant many-colored costume, often of spangled tights and tri-cornered hat, he has continued through the years to symbolize the true spirit of a masquerade. Halloween, then, is the ideal time to invite this masked charmer to cast his spell over your festivities.

"Holly" and "Harley," the Harlequin twins, can be made of black construction paper and gay carnival-colored crepe paper.\* Hang them on the walls, and use a huge mask of black construction paper across one corner of the room, to set your theme. Draped crepe streamers and assorted gaily colored balloons can complete the scene.

Flameproof crepe paper should be used to provide a brilliantly colored background throughout and to assure safety for all. A four-color scheme will create a gay carnival air. Avoid dull, uninteresting colors.

Figures for both boy and girl Harlequins can be made of several diamond and triangular shapes, cut from black mat stock, and secured on the back with cellophane tape. Cut odd-shaped hats, and slant on the head at an angle. Trim both figures with gay little masks and bright diamonds of gummed crepe. A neck ruff for each can be made from flameproof crepe. Add masks, and even guitars or mandolins cut from gay papers, to the walls. ■

\* Dennison materials are manufactured for such uses.

Digitized by Microsoft

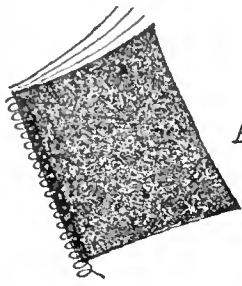

## A REPORTER'S NOTEBOOK



**Contest judges and Army officials** look over entries in the finals of the Second All-Army "Operation Service Club" Contests at Fort Myer, Virginia. Judges: (left to right, foreground) Howard Jeffrey, American Recreation Society; G. Ott Romney, President's Council on Youth Fitness; Jackson Anderson, American Association for Health, Physical Education and Recreation; (seated, left to right, background) Theodore Bank, The Athletic Institute; Marie-Louise Van Vecten, American Red Cross; Amelia Henly, RECREATION Magazine. Army personnel: (standing, left to right) Pat Abernethy, Special Services Division; Lt. Gen. D. P. Booth, Deputy Chief of Staff for Personnel; Maj. Gen. Guy S. Meloy, Jr., Chief of Information; Maj. Gen. R. V. Lee, Deputy The Adjutant General; Col. Louis W. Jackson, Chief of Special Services Division; Col. William Spicer, Post Commander, Fort Myer; Esther Walsh, Special Services Division. Winning entries: first place, Granite City Engineer Depot Service Club, Illinois; second, Neckarsulm Service Club, Germany; third, Fort Niagara Service Club, New York; honorable mention, The Riviera Service Club, Taegu, Korea, and Army Service Club #7, Camp Sendai, Japan.



**Chicago chess players** now have a modern new open-air pavilion through the generosity of chess player Laurens Hammond, chairman of the board of the Hammond Organ Company. It is located right on the lake front in Lincoln Park, on the site where players have convened for more than thirty years for serious concentration on this age-old game, and affords players protection from sun and rain in a satisfying setting for chess. The pavilion is open on all sides and covered by a semicircular pitched roof. It contains five tables with set-in chess boards, and adequate space for players and kibitzers. Additional boards have been set in the sea-wall along the sides of the pavilion. An unusual feature is the provision for night lighting with protected, set-in lights operated by an automatic time clock. The pavilion has already won an award for excellence in architecture and a citation for craftsmanship.

**European sojourner**, Grace Walker, NRA drama and creative recreation specialist, is working with recreation leaders in the Netherlands, under the International Educational Exchange Service of the U. S. State Department.

**Welcome visitor** at NRA headquarters: Arthur Todd, NRA field representative, now working, on leave of absence, with the Air Force in Europe. He attended an official Air Force conference in Washington and returned immediately to Germany.



**Special award** for his "outstanding contribution to the recreation movement in America" is presented to Col. Roland E. Sliker (right), Chief of Air Force Personnel Services Division, by Joseph Prendergast, NRA Executive Director. Brig. Gen. John S. Hardy (center), Deputy Director of Military Personnel, looks on. See Colonel Sliker's editorial on page 278 of this issue.

**Consultant** in recreation and group work to the newly-organized Regional Health and Welfare Council of Metropolitan Kansas City is Mrs. Verna Rensvold, well known in the recreation field.



**Recent returnee** to the United States, James A. Madison, NRA field representative, is shown conferring with Col. L. L. Layden, Air Force Personnel Services, at USAFE headquarters in Europe, about his visits to air bases under USAFE auspices. In a second part of his three-month stay abroad, Mr. Madison conducted seminars for recreation workers in Pakistan under the sponsorship of the U. S. State Department (see letter on page 281).



# Adapting Dancing for Senior Citizens

*Participation in folk and square dancing for this group can be increased and the full flavor of the dances retained by careful simplification.*

Cyrus S. Grossman

**D**ANCING is a most enjoyable form of recreation; however, since *moderate* physical activity is important for the usually sedentary senior citizen, it is necessary to adapt and simplify the folk and square dances for this group.

Most oldsters think they would rather sit and play cards or bingo or watch TV than get onto a dance floor. Once they've tried it, however, they'll like it, and the two equally important objectives, fun and therapy, will have been achieved. Make the test of success *how many participate*, rather than how expertly a select few agile ones can do their stuff. Some leaders are too prone to turn out exhibition teams, no matter what the age group. The leader has a selling job to do on those who, because of timidity, self-consciousness, lack of confidence, hesitate to join the fun. They very definitely won't if they have to compete with "experts."

*Who, then, should dance?* All who are able. However, the leader must remind the group that anyone with a cardiac or foot condition or any other physical disability or infirmity should ask his physician's advice before attempting dancing.

Concomitant with aging are lessened vision, hearing, wind, agility, coordination, and the patience and/or the ability to listen, concentrate and learn. Your program will be successful in the degree that the dances are modified to accommodate these impaired faculties. It can be done. In New York City, alone, there are more than a dozen golden-age clubs with regular weekly folk and square dance programs and they are just as popular everywhere else. While ballroom dancing, which is less strenuous, is an excellent form of exercise too, folk and square dances call into play larger muscles. Often those individuals who have done no ballroom dancing can be interested in folk and square.

*What kind of music should be used?* My preference is for records. They have excellent music and are a "constant,"

---

MR. GROSSMAN has conducted more than six hundred programs, since 1954, in modified folk and square dancing for golden-age clubs and blind, deaf and mentally retarded groups.

you know exactly what to expect. While a piano player would be a big help if certain parts of a dance had to be learned and reviewed separately, all our modified folk and square dances are so easy to do that they do not need to be learned piecemeal.

*What kinds of dances should be done?* Certainly some of each kind for variety's sake. If you have mostly women in your group, however, stick to the circle "no-partners-needed" kind and couple dances in which the footwork is the same for both partners. They're easiest to do and everyone can participate. Squares are more involved and strenuous and require a caller.

A volunteer can be a successful dance leader. He need not be able to play an instrument or read notes; he need not even be an experienced dancer although this would be a definite advantage. He should have a good sense of rhythm, a love for dancing that communicates itself to oldsters, the kind of personality that clicks with them—and patience. If, also, he is adept at adapting dances to meet their needs, he can do a bang-up job and will find the work very satisfying. No dance leader, however, can hope to do even a passable job with *any* dance unless he knows both music and footwork thoroughly.

## Be Your Own Choreographer

Leader, dancers and non-dancers alike can collaborate in this most rewarding activity. Probably among your chair-bound ones are those who used to love to dance but can no longer do so because of some disability. For them, helping to make up a dance will dissipate some of their frustration in no longer being able to whirl about. It is not difficult and can get to be very exciting; but it does take time and experimentation.

Choose a dance with a good beat. It might be an old-time waltz which has never been done as a circle or couple dance, or a currently popular number. If it's already being done as a folk or round dance, if possible have it demonstrated for your group and then let members try to modify it. Sometimes little has to be changed. For the fast turns, the complex routines and so on, substitute those that are



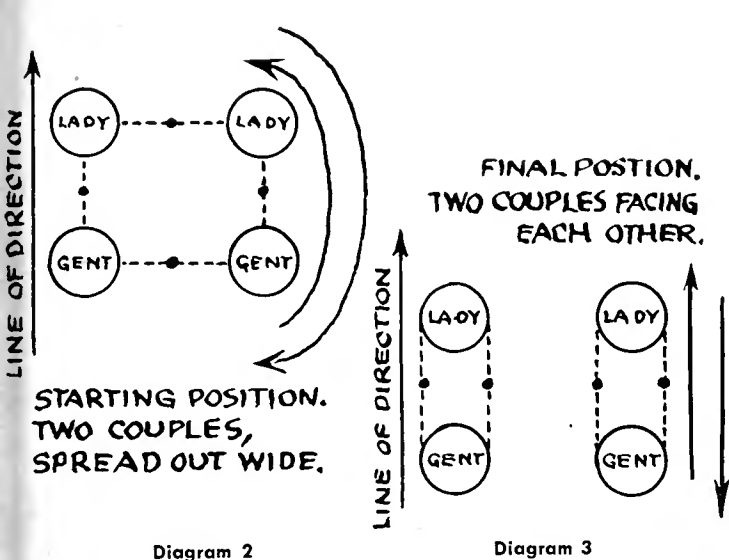

Diagram 2

Diagram 3

they are right in back, and this format is eye-appealing to both dancers and spectators.

### Vira (Portugese)

RECORD: Kismet #137A

*Measures:* 1-4—Introduction, two couples in starting position as in Diagram 2. All join hands, spread out wide; face right. 5-12—Circle right six long slow sliding steps, starting with right foot, as though skating; stop and bow towards center; face left. 13-20—Circle left, six steps as above; starting with left foot, stop and bow; drop hands and form left-hand star. 21-28—Star to right, six slow walking steps, drop hands. 29-36—Star to left, six slow walking steps, drop hands. Dancers should be back at starting point.

Take both hands of own partner. Gent is now facing line of direction. Steps for rest of dance are faster. Each couple dances by itself, *but* both couples go in the same direction as in Diagram 3. 37-40—Each couple takes three steps, raising knee on each step, gent moving forward and lady backward; end with dip. 41-44—Reverse direction (gent back and lady forward) and take three steps as above; end with dip. 45-48—Repeat 37-40. 49-52—Repeat 41-44. Drop own partner's hands, all join hands in a circle, spread out wide, and dance starts again at 5-12. Entire dance is done a total of three times.

*Comments.* Dance is for two couples but may be done by three in same way. Slow, waltz time, graceful, easy to do. Ladies may take gents' parts but must remember to go forward on 37-40 and back on 41-44.

### Potch Tanz (Israeli)

RECORD: Kismet #137B

#### "No Partners" Version

*Introduction:* Four chords—All join hands, spread out wide, face right.

*Measures:* 1-8—Circle right, eight steps, starting with right foot. 9-16—Reverse direction, taking eight steps to left. 17-18—Drop hands, take two steps into center. 19-20—Clap hands three times. 21-22—Take two steps back to

place, still facing center. 23-24—Fold arms across chest and stomp three times; drop arms. 25-32—Repeat 17-24. 33-40—Place arms high above head and, by yourself, make one complete turn right in eight steps, drop arms. Everyone is now facing center. 41-48—All join hands again and sway bodies (left to right, and so on) until ready to start dance again at 1-8.

#### Couples "Change Partners" Version

*Introduction:* Couples, every gent with lady on his right, form circle.

*Measures:* 1-20—Same as above. 21-22—Take two steps back and couples face each other; for example, gent faces his own lady. 23-24—Same as above, except that couples are facing each other. 25-32—Repeat 17-24. 33-40—Couples are facing each other. Gent moves about a foot to his lady's left, she does not move, and they join both hands and spread them out wide, and, as a couple, they make one complete turn in eight steps. 41-48—Both drop hands, facing center, gent passes his lady, bowing as he does so, she does not move, and he goes on to the next lady. All now join hands again and dance starts again with everyone having a new partner. Entire dance is done a total of four times.

*Comments.* Slow, very easy-to-do circle dance with both "no partners" and couples "change partners" versions. Former can be done without any advance demonstration or instruction. *All steps in this dance are "strut" steps.* In measures 1-8 and 9-16 dancers must be cautioned to both face and walk in direction they are going. They can learn this by walking single file in a circle, then extending one hand in front and the other in the back, joining hands with person ahead and in back, and continuing to walk that way in the direction they are going.

### Chimes of Dunkirk

RECORD: RCA #45-6176

A circle-type dance for couples, of the "change-partners" type. It includes clapping and stomping and is easy to learn. Ladies may take the gents' parts. It may be done in conventional fashion. Instructions come with the record.

### Ach Ja

RECORD: Folk Dancer #1110

Also a circle-type dance for couples of the change-partner kind. It is a singing dance which can easily be learned and here again ladies may take gents' parts. Dance may be done in conventional fashion. Instructions come with the record.

"Ach Ja" and "Chimes of Dunkirk" are both very popular with senior citizens groups. ■

The above listed records may be ordered through your local dealer or you may obtain all of them from Kismet Record Company, 227 East 14th Street, New York 5; or Square Dance Squares, Summerland, California.

In ordering be sure to give the name of the record company, the number of the record, and the name of the dance. Records range in price from about \$1.00 to \$1.50. All the records listed are ten-inch 78rpm.



Joseph Prendergast, with Betty Jo Mandlin representing the children who enjoy New York City's parks, accepts first National Recreation Month proclamation from Mayor Robert Wagner. Many other mayors and thirty governors issued proclamations urging all citizens to take a part in the recreation activities in their own communities.

With the wholehearted support of Brigadier General Stephen B. Mack, men of Shaw Air Force Base, South Carolina, showed "100% improvement in participation and interest over the previous year's operation" in their observance of a second annual National Recreation Month.

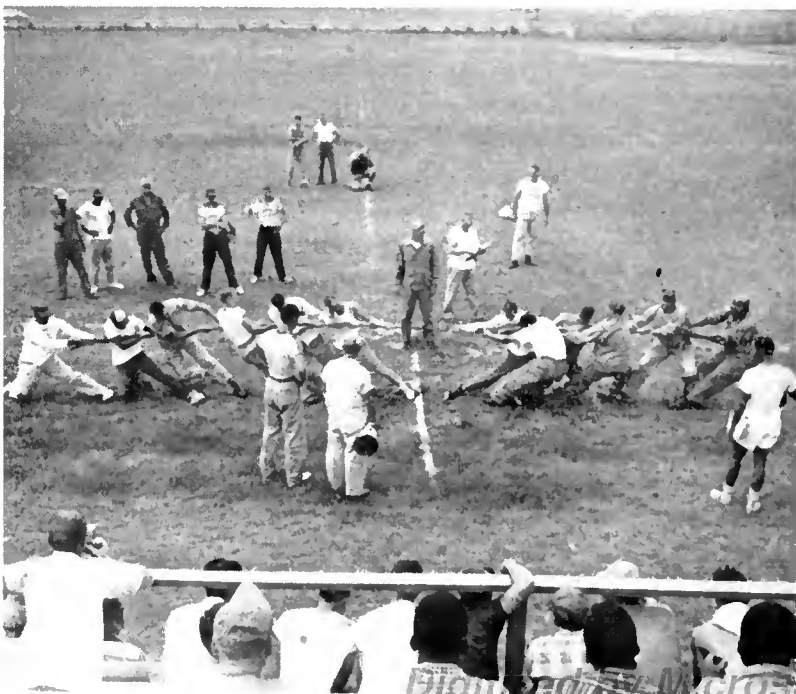

# Recreation ON Parade

**P**RESIDENT DWIGHT D. EISENHOWER telegraphed to Joseph Prendergast, executive director of National Recreation Association:

"During June, National Recreation Month, innumerable Americans will direct their attention toward recreation in its many diverse forms, each familiar to some or as yet unexperienced by others. It is my hope that our citizens will use some of their hard-earned free hours to enjoy the unparalleled recreational facilities of our land. In so doing they will enrich their daily lives and contribute to the health of the national community."

Innumerable Americans took their President's word. In communities, large and small, the proclamation of National Recreation Month was the starting point for launching summer playground activities; for editorials, news stories, radio and TV shows; for special displays in store windows and banks and public buildings; for events honoring men and women who had helped to build and support recreation.

Some of these men and women had donated parks or centers. Some had given years of vigorous leadership to the fight for better facilities. Some had special interests—the drama or arts and crafts; all had a common concern for recreation that earned them NRA citations. During a visit to the mayor's office, the dedication of a ballfield, the opening of a dance festival or a dinner to celebrate the founding of the recreation department, these leaders received handsome red, white and blue scrolls to



*National Recreation Month 1957 made more citizens aware of the importance of recreation—and helped them get better acquainted with recreation facilities in their communities. By taking a good look at what we accomplished this year we can make next year's observance even more effective in telling the recreation story.*

**JUNE**

**NATIONAL  
RECREATION  
MONTH**



**LIVE ALL YOUR LIFE**

...gnified national recognition of their achievements. Service clubs, religious groups, veteran, and fraternal organizations received citations too. Kiwanis, Optimists, Junior Chambers of Commerce, Lions, Moose, Junior League, American Legion, Council of Jewish Women, Boosters, Elks, Civitan, Rotary, FW—the list is almost as long as the roster of public-spirited associations.

Nominations for citations, made by affiliate members of the NRA, served to highlight the importance of Recreation Month for everyone. The Army, the Navy, and the Air Force held special programs for both officers and enlisted men and offered opportunities to get acquainted with new kinds of recreation in line with the month's theme, "Live All Your Life." Members of state recreation societies visited governors and pointed out the growing importance of recreation. Settlement houses and private organizations held news-making events. Some communities preferred to limit their participation to a week, but most found plenty to keep interest going throughout the Month. The story of recreation has many chapters, lots of action—and is certainly packed with dramatic human interest.

Perhaps the best part of the story is that it is still being written. Next year's National Recreation Month will provide new opportunities to honor those who have rendered outstanding service. If we begin to plan now with educators, religious leaders, and civic groups, we can help even more people learn, in time 1958, what recreation can mean to them. ■

More NRA Affiliate Members than ever before—165 in 45 states and Canada—nominated local civic leaders or organizations to receive citations for service to recreation. Here, Mrs. Walter R. O'Hair, sole woman member of Detroit's Parks and Recreation Department, gets award from Mayor Albert Cobo in recognition of her contributions.



Digitized by Microsoft

# DISPLAY and DECORATION Ideas

*Almost every recreation leader has the job of program publicity and decoration, whether he wants it or not! Here are some suggestions for effective and economical use of novel materials.*

Mary Frances Sargent

A PARTY can fall flat without the well-planned and well-timed publicity and effective decorations that turn a routine affair into a rousing success. However, because our training has been, for the most part, on program planning and other phases of recreation, we often either shy away from publicity and decorations or else neglect them completely with the excuse, "I'm no artist."

If you take a close look at these two fields, however, you will discover that you really do not have to be an artist or have specialized training to do an effective job. When you see what can be accomplished without too much effort, both these tasks become a fascinating part of the recreation job.

Probably the most pertinent word to keep in mind in planning your recreation art is *simplicity*. All advertising, to be successful, must catch the eye; but if the eye is distracted by too many things, the tendency is to pass over all lightly. Simplicity, then, is of utmost importance in publicity and decoration.

People do not read ads or announcements for the sake of reading. Unless we can attract their attention, arouse their curiosity, make them laugh, or present something new, chances are they will pass right by our publicity.

Materials are important. We are attracted, not only by color, but by texture and shape. Unusual use of ordinary materials catches attention. There are any number of materials that are very effective and most economical as well. Many of these are materials, which are

not manufactured specifically for decorative purposes, prove to be attractive in decorative settings. They are low in original cost, and can be used for several occasions and in several ways.

If you really want to save money, don't budget and buy decorations for only one party. If you find good material, you'll save money by buying large quantities that can be stored for future affairs. You will find, too, that you have a well-stocked storeroom for many future occasions.

In our own planning, we have successfully contrived some unusual art uses for non-art materials. We have used plain old burlap, the kind feed bags are made of, stapled to sixteen-foot-long closet poles, for hanging an art exhibit. The walls of our club are cut up with windows, pipes, and so on, and we needed a flat surface on which to display the pictures.

Burlap actually can be used over and over. The surface will take paint or can be silk screened. Very attractive drapes can be made at the lowest possible cost. Interior decorators also have discovered this material and are making use of it in home decoration. It is practically wearproof.

Burlap can be obtained inexpensively

from most large bag companies, if you buy in one-hundred-yard lots.\* It comes in two weights: seven-and-a-half-ounce which costs about \$13.25 per hundred yards; ten-ounce which costs \$16.25 per hundred yards. These prices are for forty-inch-wide material; but it also comes in a thirty-six or sixty-inch width.

We also considered the closet poles a "find." There are any number of uses for these, such as for room dividers, at a very nominal cost, which can be set up in a few minutes. The poles are extremely easy to work with as you may choose from several lengths and thicknesses, and the wood has a nice finish and can be painted in gay colors. They can be purchased at lumber dealers.

Another carpenter's material which we have borrowed is "beaverboard." This is a heavy (about one-quarter-inch) cardboard that comes in four-by-eight-foot sheets and generally costs around \$1.60 per sheet. It is excellent for outdoor signs or for panels for exhibits. The material cuts easily with a small handsaw. If you are lucky enough to have an electric Cutawl machine, the material can be used for all sorts of

\* We purchased ours from Bemis Brothers Bag Company, 601 South Fourth Street, St. Louis, Missouri.

Burlap was stapled onto sixteen-foot "closet poles" to make a background for a silk-screen display. Bright wool yarn was interlaced between the burlap panels for a colorful effect.

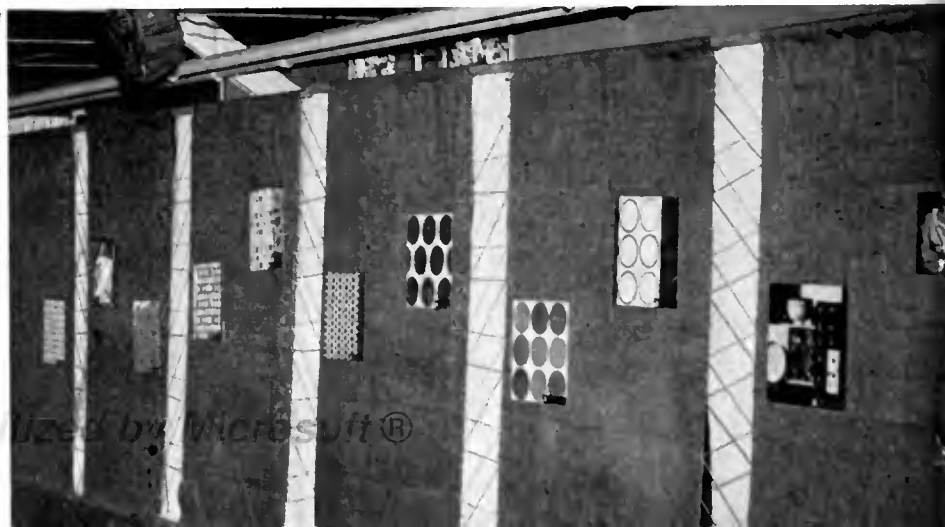

MRS. SARGENT is director of the Granite City Engineer Depot Service Club, Granite City, Illinois. The entry she submitted won first place in the Second All-Army "Operation Service Club" contest in which over three hundred service clubs competed recently (see page 288).

decorations and large sign letters.

Pegboard is excellent for exhibits, too, but we found that its comparatively high cost called for a substitute. We used the beaverboard; but, to add a little glamour, covered the surface by stapling to it "erosion net" which we found in the garden department of a large department store. Many home gardeners cover their newly seeded spring lawns with it. It is an attractive netting made of multi-colored coarse string. Because of its inexpensiveness it can be used profusely, in any number of ways. It could be used nicely, for example, for summer drapes in a club or in a center where large windows are common. It comes in fifty-four-inch width at twenty cents per yard.

In the building department of a hardware store we found "metal lath." Builders use this on walls before they plaster, and we constructed a large display panel segment from it. We wanted a material that could be seen through and would not obstruct the light. By alternating building board with the metal lath panels we obtained the desired results. The metal lath is black and similar in appearance to the perforated metal used in some wrought iron furniture. It may be cut to any desired shape easily with small tin snips (wear work gloves though), or be bent and shaped. It comes in sheets eighteen inches wide and eight feet long, costs about one dollar per sheet. We made an effective sign for an exhibit by stapling the black metal lath over colored posterboard. To put the lettering on the lath we stapled white rope laid out in script writing.

Incidentally, if you have sufficient storage space for leftover materials, it

is surprising what later uses you may find for scraps. For one exhibit we built a large frame of two-by-fours and then tacked on odd-shaped pieces of masonite, pegboard and beaverboard, in an eye-pleasing arrangement. By mixing several cans of leftover paint we came up with an unusual color and painted all the pieces alike. We received several compliments on the work.

Another material we have adapted in decorating is wallpaper. If you have not been in a wallpaper store recently, a trip will be profitable. The array of designs and patterns is tremendous. There is hardly a party theme you could have in mind that would not have a counterpart in wallpaper design. If you are stuck for a theme, you may find one by browsing through the sample books.

We used wallpaper as a stage backdrop for one party. Buying stage curtains is expensive: so, in order to change appearances for a fashion show, we stapled strips of wallpaper together to form the curtain, and then stapled it over the permanent curtain.

For another party we made a different stage backdrop in a similar manner but used white commercial tablecloth paper. This comes in rolls twenty-five yards long and forty-eight inches wide for about \$1.50 per roll. The paper has a slick surface and takes paint and tape very well. Since this backdrop was for a party with an art theme, we cut out abstract shapes of various solid colored wallpaper and glued them to the paper curtain. We also used strips of colored Mystik tape to add to the design. It was economical, effective and easy to do.

Another useful material is jewel cloth. Although this is strictly a decorative

material, it has many uses in the recreation program. Jewel cloth is a glitter material in silver and gold, plus several colors. It is somewhat more expensive than the other materials mentioned, about \$1.50 per yard, but, for the really festive occasion, most effective. The silver and gold does tarnish in time and cleaning is not practical. However, if

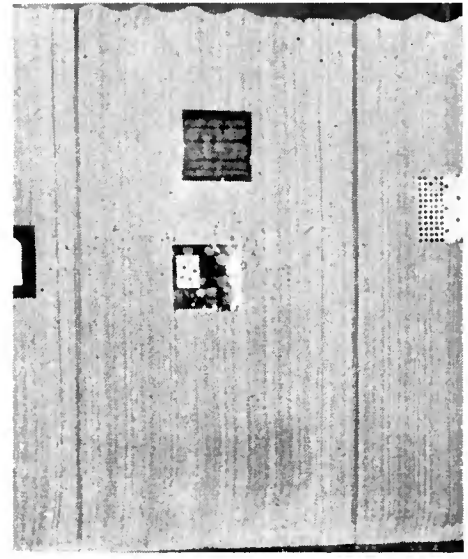

Inexpensive "erosion net" was stapled to beaverboard to hang a silk-screen exhibit.



Service Club bulletin board, using black posterboard, cutouts, and white spray paint.

Side view of free-standing display panel. Metal lath allowed more light, was a most attractive background for this exhibition.

Stage backdrop curtain was made with white tablecloth paper. Abstract shapes were cut from wallpaper and were glued to the curtain. Mystik tape formed the connecting lines.

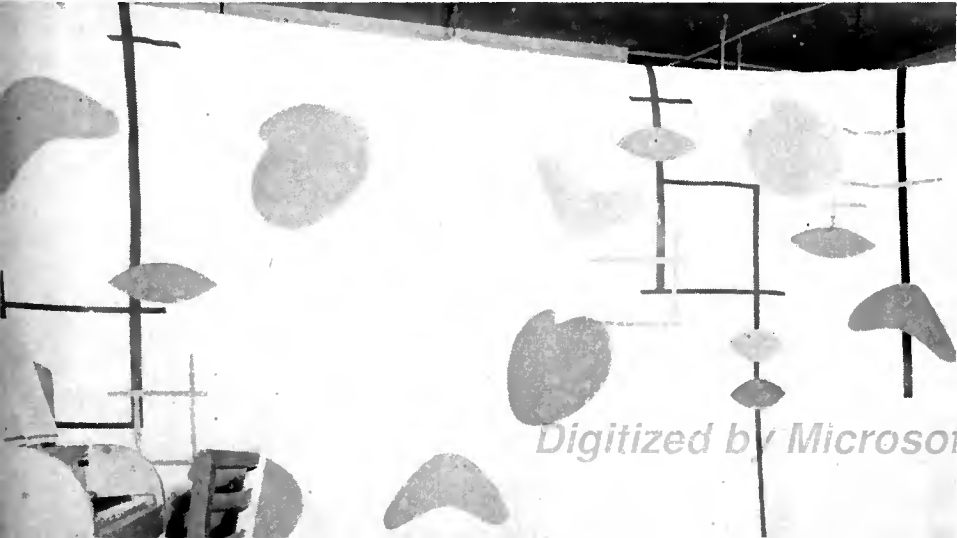

the material is stored by rolling it in a layer of paper, it can be stored for future use. Even when tarnished, it still maintains much of its original sparkle when lighted with spotlights. Jewel cloth can be purchased from several costume companies.\*\*

Posters and flyers, too, are a very necessary part of your publicity and can be made effective by the use of the material you select. It is not always necessary to draw a picture to make a good poster. Sometimes a symbol will convey just the idea you wish to express.

Good posters need an understanding of the power of color and attention-catching gimmicks. They need not and should not be complicated. Cut lettering to as few words as possible; a poster is not a detailed resume of your program plan. It is a capsule announcement to build up interest in the event.

There are any number of eye-catching symbols and gadgets one can use in place of elaborate illustrations. If you need a humorous face, try using buttons for eyes, paper clips for nose and mouth, colored cotton for hair, and so on.

\*\* Dazian's 125 North Wabash Avenue, Chicago, or 142 West 44th Street, New York City, is one supplier. They will give instructions for flameproofing, should you need them.

These three-dimensional-type things are effective.

Wallpaper also can be used in poster making. Try using a plain small pattern as your background. If you do not possess a set of speedball penpoints, by all means obtain a set. Speedball lettering can be very neat and quick for the amateur. Also, in using wallpaper in the above manner, you will find it possible to reuse old posters. Cover the original with wallpaper instead of purchasing new posterboard! Ask your dealer to save his old sample books for you when the new styles come in; he usually will.

One effective way to make posters quickly is by the use of spray paint. This paint comes with its own spray nozzle and can be purchased from the local ten-cent store or paint and hardware stores. We used black posterboard and white spray paint. We cut out a top hat, cane, and gloves from construction paper, and spelled out our message with some pre-cut letters on hand. First we laid these on the board (cellophane tape them at intervals, if they are of lightweight paper), then we sprayed white paint over the materials and around the edge. When we removed the designs they were on the posterboard in deep black. Any combination of col-

ors can be used and you can make several similar posters in a short time.

Other effective posters, without drawing, are made with photomontage. This is a multiple photographic study, consisting of different photographs, illustrations and lettering, cut from magazines or newspapers, mounted and arranged to convey a single idea. For example, you might cut various types of circus ideas from several old magazines and arrange them on a single poster to convey an over-all impression of a circus.

We also make use of "flyers" for publicity, but caution must be used in not overdoing the flyer method. It is best to use them for special occasions and, then, they must be attractive to receive the attention you want. The mails are stuffed with mimeographed material these days and much of it only fair quality. However, attractive flyers can also be made by the use of some of the poster techniques.

If you have the use of the Xerex process of duplicating, more effective lettering can be done by using "Artype" letters. These come in sheets and have an adherent on the back. They must be cut out with a sharp knife and placed on your original. Press the letters with any rounded instrument and they will adhere to the paper. However, unless you duplicate your flyers by the photographic process, Artype would not be practical because of its cost.

We have found that effective publicity is a vital part of the program and feel that time spent on it is worthwhile. Get some of your ideas from the magazines. Glance through and notice which ads catch your eye. Magazine advertisements are done by top-flight, highly trained artists and are a source available to all of us. Study what makes them effective; note the ideas that can be adapted to your own publicity or decorations. We have found the advertisements in both *Esquire* and *Holiday* magazines a good source of ideas.

Another help has been a subscription to *Western Advertising Art*. This is strictly an advertising trade magazine, but it publishes the finest advertisements put out nationally in magazines, billboards, containers and television. Since we feel that advertising is an integral part of our job, it is a wise idea to try to learn from the experts in the field. ■



Humor made posters left and center eye-catching. Funny little artist was used on all publicity for party. "Cutawl" letters on the poster on the right, are simple and re-usable.

Entrance for the "All-Army Art Exhibit" was made by stapling black metal lath over the colored posterboard. White cord script lettering was then stapled onto the board.





# A FENCING PROGRAM

For 2 or 200. Requires minimum space and simple inexpensive equipment. We design and manufacture the best and least expensive weapons and accessories for beginners and experts. Let us help you set up a fencing activity or develop the one you have. Consultations free.

Write Dept. R for FREE CATALOG.

# Castello

AMERICA'S OLDEST AND LARGEST IMPORTERS AND MANUFACTURERS OF

**FENCING EQUIPMENT**

30 EAST 10th STREET, N.Y. 3, N.Y. • Gramercy 3-6930

## RONALD Books

Top teachable guide to . . .

### Principles of RECREATION

By JOHN L. HUTCHINSON, *Columbia University*

A fundamental treatment of recreation for courses related to the subject. This up-to-date textbook makes clear the basic concepts underlying the organization of leisure activity. It provides a full investigation of the cultural significance of the recreation profession, and a systematic discussion of the responsibilities and functions involved. Gives an account of the meaning and objectives of recreation and sketches of the various cultural, economic, and social changes related to leisure activity in the United States — both past and present — and examines the status of recreation provided by municipal, state, federal, and school authorities. \$3.75

### MODEL AIRPLANE ENGINES

NEW! Revised Printing of this non-technical introduction to the theory of internal combustion engines details the design for each working part. Stresses two-cycle type used most often in model airplanes. Specifications for commercially built model engines. 130 ills. By DONALD K. FOOTE. \$3.50

### KITES

A practical guide to kite making and flying. Shows: materials to use; how to make various kinds of kites including fancy and novelty types; etc. *A Barnes SPORTS LIBRARY Book.* 70 ills. By H. WALLER FOWLER, Jr. \$1.95

### Aerodynamics for MODEL AIRPLANES

For new or veteran hobbyists. This helpful book covers model flying's basic principles and clearly shows how to work out design problems. Invaluable coverage of the atmosphere; the forces of gravity, lift, drag, and thrust; the different types of stability and balance; flight adjustments; etc. *Also by DONALD K. FOOTE.* 124 ills. \$3.50

Order your books from:

**THE RONALD PRESS COMPANY** 15 E. 26th St., New York 10

## New Table Tennis Tables

**100% Aluminum**  
EXTRA HEAVY DUTY

ESPECIALLY DESIGNED FOR HEAVY DUTY USE  
*Indoors or Outdoors*

Official Regulation SIZE and BALL BOUNCE

MADE IN 2 SECTIONS

4 LEGS TO EACH SECTION

Nationally recognized and used by the ARMED FORCES, COLLEGES, MUNICIPALITIES, RECREATION CENTERS, SCHOOLS, CLUBS, PARKS, etc.

|                                                          |                                                               |
|----------------------------------------------------------|---------------------------------------------------------------|
| <p>MODEL #104<br/>as above with<br/>stationary legs.</p> | <p>MODEL #106<br/>8 sturdy snap in type<br/>folding legs.</p> |
|----------------------------------------------------------|---------------------------------------------------------------|

- No Maintenance or Replacement Problems.
- Sturdy Lifetime Construction.
- SECURELY INSTALLED HEAVY GAUGE ALUMINUM CENTER NET

For FULL DETAILS WRITE

**ALL METAL TENNIS TABLE CO.**  
P.O. BOX 142, TEANECK, N.J.

Style WM-4

## Checker WALL MOUNTED RACK

**Hold More Wraps in Less Space.** Standard in checkrooms. Also widely used as self-service racks in coffee shops, restaurants, meeting rooms—wherever people gather. Mount on any available wall space, even over floor obstructions, accommodate 4 or 5 persons per running foot. Provides each with a coat hanger and individual hat space. Keeps wraps aired, dry, "in-press." Come with or without numbers and checks. Strongly built of reinforced heavy gauge steel. Finished in baked enamel. 3'2", 4'2", 5'2" lengths. Mount independently or interlock to make continuous racks of any length.

Write for Bulletin CK-515

**VOGEL-PETERSON CO.**  
1127 West 37th Street • Chicago 9, Illinois

PROGRAM

## How To Make A MOSAIC

### MATERIAL and EQUIPMENT

Broken china ~ Household cement ~  
Crack filler ~ Water color paint ~  
Wire cutters ~ Glass bottles ~  
Jars ~ Boxes ~ Ply Wood.

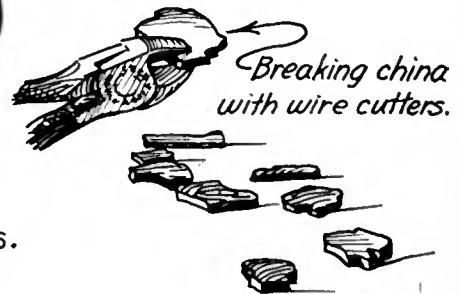
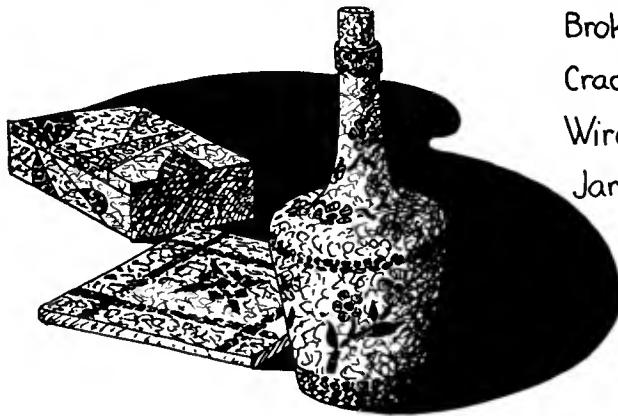

### METHOD

1. Break china plates, saucers, etc. into small pieces.

*NOTE - This can best be done with wire cutters.*

2. Starting at bottom edge of object (*bottle*) stick china pieces to object.

*NOTE - Use household cement. Use straight edge pieces to get even edge.*

3. Continue sticking china pieces to object until entire surface is covered.

*NOTE - Leave no large cracks or open holes. Pieces of china should be fitted closely together.*



4. After cement is dry (about  $\frac{1}{2}$  hour)

fill all cracks with crack filler.

*NOTE - Mix only small amount of crack filler at a time.*

*Mix crack filler to putty-like consistency. Spread with stick and wipe off surplus with damp cloth or paper towel until all filler is removed except in the cracks.*

*NOTE - Water color paint can be mixed with crack filler to get any desired color.*

5. Stopper for bottle can be made with piece of dowel.

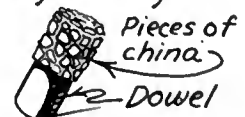

Wooden boxes, jars, table tops and most any article can be covered with mosaic.

If you are planning the construction of an Ice Skating Facility in the near future consult a firm that has designed and engineered 34 ice skating rinks and arenas in the past year

**INDOOR • OUTDOOR  
PERMANENT • PORTABLE**

Take advantage of our invaluable knowledge and experience of ice rink feasibility, planning and construction.

**COSTS  
REVENUE  
FINANCE  
ENGINEERING**

**OPERATION  
PROMOTION  
EQUIPMENT  
SITE PLANNING**

We now are designing 17 rinks and arenas for the 1958 season, and have just completed the design of 3 outdoor rinks for the City of Buffalo.

**Peter Carver Associates**

**70 EAST 45th STREET  
NEW YORK 17, NEW YORK**

Phone: LExington 2-1520

**OUR REFERENCES AND EXPERIENCE ARE YOUR GUARANTEE**

**ALL-AMERICAN HEAVY-DUTY  
PICNIC GRILLS**

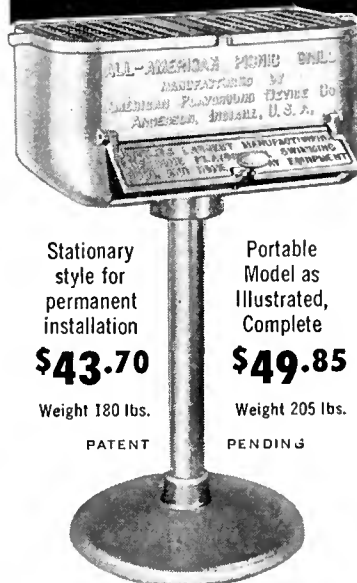

Stationary style for permanent installation  
**\$43.70**

Weight 180 lbs.

PATENT

Portable Model as Illustrated, Complete  
**\$49.85**

Weight 205 lbs.

PENDING

**Features Not Found  
In Any Other Grill**

Built just like a small, complete cooking range. Positive 6-way draft control gives faster, easier kindling, saves fuel, insures tender, juicier steaks, chops, barbecues. Cooks, bakes, warms—burns charcoal, wood or coal. Grill revolves to permit cooking to windward. Cast of heavy stove iron with steel pipe support, for lifetime service. Shipped fully assembled.

★ Write for Literature on All-American Picnic Grills, Heavy-Duty Picnic Tables, Park Benches and Chain Link Tennis Nets

**AMERICAN**

**PLAYGROUND DEVICE CO., ANDERSON, IND.**

WORLD'S LARGEST MANUFACTURERS OF FINE PARK, PICNIC, PLAYGROUND, SWIMMING POOL AND DRESSING ROOM EQUIPMENT

*the Management Journal*  
*Parks & RECREATION*  
MAGAZINE



FOR:

- ▶ You
- ▶ Your Board
- ▶ Your City Officials
- ▶ Your Key Personnel
- ▶ Your Informed Lay Supporters

**FOR PARK AND RECREATION SUPERINTENDENTS . . .** techniques described by practical men in the field.

**BALANCED EDITORIAL FORMULA . . .** the voice of the professional on land acquisition, design, construction, recreational usage, administration and maintenance . . . a complete coverage.

**A QUALITY PRODUCT . . .** fine paper, printing, photos, maps and editorial approach.

**SERVING THE PARK AND RECREATION FIELDS SINCE 1917.**

**PARKS & RECREATION . . .** only national magazine designed for both park and recreation administrators.

**EACH MONTH . . .** the most "referred to" publication in its field . . . a must for your reference library.

**ALL USABLE INFORMATION . . .** no fiction, no "fairy tales" avidly read from cover to cover . . . send for your free sample and judge for yourself.

**SUBSCRIPTION RATES**  
One year . . . \$ 5.00  
Two years . . . 9.00  
Three years . . . 13.00  
Groups of four or more—one year \$4.00 each per year.

**PARKS & RECREATION**  
Department RN  
Oglebay Park  
Wheeling, West Virginia  
publisher



*Superior By Every Comparison!*

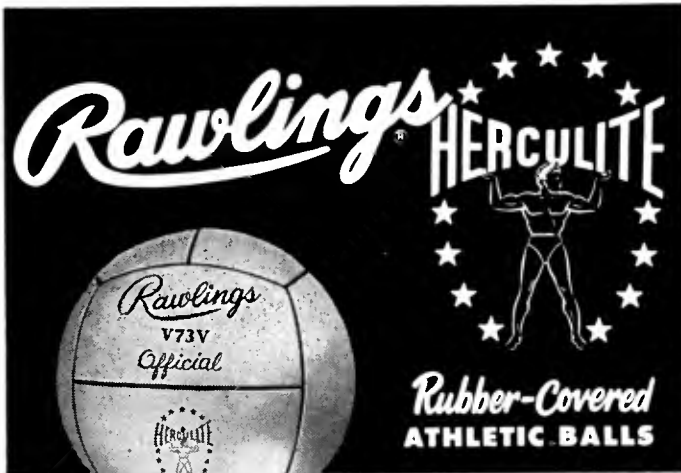

So sensationally better are they on every count—design, construction, quality, durability and play-ability—that Rawlings HERCULITE Rubber-Covered Athletic Balls have established a new high standard. They're in a class by themselves—they're . . .

- "The Finest In The Field!"**
- VOLLEY BALLS
  - BASKETBALLS
  - SOCCER BALLS
  - FOOTBALLS

RAWLINGS SPORTING GOODS CO. • St. Louis • Los Angeles • Dallas • Chicago

# Public Relations in Recreation

*A publicity and public relations specialist addresses some practical advice to recreation workers.*

**Richard M. Baker**

**M**ANY OF YOU, as recreation executives, I know, feel that your work is not being sufficiently recognized, that there is not enough status in your job, that other people don't consider recreation a profession and that, pretty generally, you are an underpaid, unappreciated and overworked group. I think the problem is of your own making.

Let's suppose a successful industrialist were faced with some of the same difficulties and shortcomings that plague recreation—lack of trained workers, an old plan, outworn equipment, lack of funds—what would he do? He'd put on the biggest selling campaign his community had ever seen. He'd explain his problems, his needs and, most important, what he had to offer (his product—recreation). Because he believed so wholeheartedly in his product, he'd tell everyone about it—parents, children, city officials, school boards, his entire community. He'd know that he can get what he wants by *selling his product thoroughly and continuously*.

People will support recreation activities and larger recreation budgets provided *they know what the problems are and are reassured that the money will be spent wisely*.

Recreation workers are like people in many other businesses and professions. We all have a tendency to put the blame on "conditions," a lack of understanding either by our superiors or by the people who control the pursestrings. But it may well be that the fault rests not with others, but with you. *You can do something about this*. The mere wringing of hands is not enough, nor is it enough to say, "We can't get through to our aldermen or to our board—they just won't listen." They will listen if you have something to say, if you organize and present a case!

---

*Condensed from a talk delivered at an annual recreation conference of the Wisconsin Recreation Association and published in the association's monthly bulletin. MR. BAKER is vice-president of an advertising company, The Brady Company, Appleton, Wisconsin.*

Everyone is seeking more recognition. Everyone is seeking more money, as an outgrowth of that recognition. Fortunately, most everyone realizes you have to deserve more money before you get it—either for yourself or for your program.

Getting more money—for your program, for yourself, for your staff—is the result of, and not the motivation for, doing a good job. Employers don't offer pay raises as an inducement to work harder and better; they offer raises as a reward. Like the major league baseball player who receives a substantial pay boost after a good season, the recreation director and the people he supervises will get salary increases only after they demonstrate performance.

Money isn't the whole story, of course. There has to be, above all, a quality of dedication in recreation people—a desire to serve mankind, to bring about richer enjoyment of life for other people.

Recreation leaders have a great deal in common with the teacher, the civil servant, the foreign service officer and, in the old days, the country doctor. The satisfaction of doing worthwhile work, of helping others comes before money. If this isn't the case, you probably shouldn't be in recreation. There isn't enough tangible reward, either in money or in public acclaim, to justify continuing in a job you don't enjoy and respect.

If you do enjoy and respect your work, you're well on your way to an intelligent, accurate appraisal of where recreation activities fit into the future scheme of your city or community. This leads us to a public relations program, organized, detailed, followed through, designed to take your story to the people who either are or should be interested—your townspeople.

Let's take a quick look at what public relations is. There are many definitions, but the one widely accepted today was first given in an article last year in *Fortune* magazine. "Public relations," according to *Fortune*, "is good performance, publicly appreciated because it is adequately communicated." A very basic, a very understandable definition.

"Good will" is another term which can be interchanged with effective public relations, a backlog of friendship, which is based on people knowing and therefore approving what you're doing.

Public relations activity is all around us. It is the fight for ideas, the forces of persuasion which all groups exert upon one another. Whether you like it or not, you're in a public relations struggle too—a struggle to win public understanding and support.

If you accept this as being true, as an inevitable part of our high-speed twentieth century life, then you're probably interested in how well you're doing in your relations with the public. How can you find out?

To help you, let's list some questions, in no particular order of importance, that might give you a better line on your own public relations performance:

1. How often do you see any of the parents of the children who are in your program? At your office, on the street, at community meetings? How often do you simply talk to some of these people just to get to know them?

2. How often do you give a talk to one of your local



service clubs, PTA groups, women's clubs, or any other organization that regularly needs speakers or would logically be interested in what's going on in the recreation department?

3. Do you ever sit down with a member of your school board or city council or recreation commission when you don't have an axe to grind, merely to report on what you're doing?

4. Do you ever go to any of these people—singly or in a group—to ask their advice on a project?

5. Do you ever talk to the man on the street—a relative, a friend, a casual acquaintance, even a stranger—to find out what he knows about your recreation program? I did this with an old friend the other night, a doctor who's known me well for ten years. I asked him to tell me, if he would, what he knew about my work. It was embarrassing for both of us . . . he knew next to nothing . . . but I learned something. As it turned out, he became genuinely interested in what I am doing. So might your friends, but first find out what they know. You may be in for a shock.

6. What's your relationship with other agencies in the community who are doing similar kinds of work—YMCA, Girl Scouts, Boy Scouts, the church groups? Are you trying to improve some hard feelings you inherited or hard feelings you helped develop; or are you drifting—still competing with these organizations?

7. How's your office public relations? How are incoming phone calls handled? With courtesy, helpfulness or grudgingly and abruptly? How are visitors to your office greeted and treated? Is the office a pleasant place to visit, both in decoration and in the manner of the people who work there? For many people, the only contact with your department is over the phone or during a quick drop-in visit. Will their impressions be favorable?

8. Are you taking part in any community activities other than those directly related to your job? Are you active in your church's spiritual and social program? Do you serve on civic fund-raising committees, service club program committees? This list is long. But the important thing to remember is that the success of your program often depends upon volunteers. You can repay this debt—not to the same persons, but to others—by being a volunteer on a reasonable number of civic activities. To rephrase this question: How deeply are you involved in the life of your community?

9. How expendable are you and your program? If catastrophe should strike your city administration or your school board—if, for example, a large source of revenue were cut off—would your department be the first one to feel the axe? Are you considered a necessity or a luxury?

10. What is your relationship with the ministers, priests, rabbis in your community? Do they know intimately the work of the recreation department? Do you invite them to visit one of your programs? Do you extend yourself to communicate with them? Obviously, the clergy is a powerful and articulate voice in your city. For your benefit, and for theirs, they should know what you're doing.

11. Do the police in your city know anything about your program? Do they understand how your work is having beneficial results on your community's juvenile delinquency

problem? Have they visited any of your activities? Have you extended yourself to keep them informed? They're good allies, and can serve as recruiters for you if you aren't getting enough participation in your programs.

12. How often do you check with the parents of your children to test their youngsters' reaction to the recreation program? This is more than just seeing the parents. This means asking pointed questions about what their sons and daughters say, and about the parents' impressions of your program's effectiveness (or lack of it).

13. Do you test the effectiveness of your adults' program? Do you periodically question some of your adults? Are you sensitive to the kind of impact your program is making on both young and old?

14. How often do you hold staff meetings? What kind of meetings are they? Do you find out about the problems of your staff or is the meeting an excuse for you to deliver a lecture on all you know about recreation? Is there participation? Does your staff honestly have a chance to talk and to be listened to courteously? Look back at your last meeting. Were you the only one who talked?

15. Do you take part in the various public ceremonies in your community—the opening of a new recreation site, new public building, the starting off of a fund drive, and so on? Are you in the limelight during these events or do you take the opportunity to push the mayor, school board president, any other logical official to the front? Are you an effective behind-the-scenes worker who is satisfied with this role or must you take the bows?

16. What's your relationship with the local press? Do you know anything about its needs, special problems, deadlines? Have you talked with your editors to learn what they might want from you, rather than emphasize what you want printed? Do you observe the basic rules for good news stories?

17. Do you regularly hold open house—for children, adults, the general community, for special groups like service clubs, women's clubs?

18. Do you publish an annual report, regardless of the elaborateness of the presentation? One of the most effective annual reports I've seen was mimeographed, but the story was so compelling it overcame any typographical shortcomings.

19. Do you acknowledge help promptly? When volunteers pitch in on one of your programs, do they receive a thank-you note or a phone call?

20. Is your program balanced? Because you like outdoor sports, is there an over-emphasis on these, and a resulting under-emphasis on indoor activities? What about the ratio between youth and adult activities? *Does your program take into account the special needs of your community?*

This last is the more important question of all. And it's the question, or questions, you ask yourself about your department and its place in your community—other than the ones we've just mentioned. If the foregoing "twenty questions" have any value to you, the value might lie in stimulating you to look into and appraise your own performance.

The problem of what people think of you is squarely up

to you. You control it. Because of your specialized training in recreation, it's unlikely that you'll find any specific direction from your superiors. You have to be the self-starter, the planner, the doer.

The power of one person is remarkable. It's always surprising to find out what you can do if you're willing to make the investment in energy to do it. You never know what you can do until you try! ■

# ..... CLASSIFIED ADVERTISING .....

**RATES:** Words in regular type \$.15 each  
Words in boldface type \$.25 each  
Minimum ad accepted ... \$3.00

**COPY:** Type—or clearly print—your message and the address to which you wish replies sent. Underline any words you want to appear in boldface type.

**DEADLINES:** Copy must be received by the fifth of the month preceding date of the issue in which ad is desired.

Send copy with remittance to: RECREATION Classified Advertising, 8 West Eighth Street, New York 11, New York.

## HELP WANTED

**Occupational and Recreational Therapists** for 4500-bed modern progressive mental hospital. Occupational Therapists must be registered or eligible for registry American Occupational Therapists Association. Recreational Therapists must be graduate recognized college with major Recreation or Recreation Therapy with supervised field work. Start at \$376; annual increases. Civil Service. Three weeks paid vacation; sick leave; eleven paid holidays. Fine recreational area. 66 miles east of Los Angeles. Write Superintendent, Patton State Hospital, Patton, California.

**Recreation Vacancies in Sixth U.S. Army Area** (eight Western States). Assistant Service Club Directors: salary \$4080, single, female, minimum age 24 years. College degree, two years' paid experience. Plan and direct recreation activities, share administrative responsibilities. Apply to Special Services Officer, Headquarters Sixth U.S. Army, Presidio of San Francisco, California.

**Assistant Superintendent of Parks** to be hired in 1958, with the possibility, if qualified, of being advanced to the position of Superintendent of Parks upon the retirement of the present Superintendent (about December 31, 1958). College graduate preferred with administrative ability. Five years experience in large public park system including administrative or supervisory work. For further information write M. G. Slmonds, Superintendent of Parks, City Hall, Green Bay, Wisconsin.

*The publisher assumes no responsibility for services or items advertised here.*

## POSITIONS WANTED

**Experienced Teacher of Arts and Crafts** desires permanent position. Mature, patient, creative, with therapy background. Will consider overseas. Mrs. Ida G. Fisch, 1902 East 18th Street, Brooklyn 29, New York.

## SERVICES AVAILABLE

**Piute Pete of Village Barn and TV fame.** School Dance—Workshops—Organization Barn Dances. Hilarious Audience Participation Games, Novelty Dances and Square Dances. Piute Pete, 55 West Eighth Street, New York 11, New York.

HELP WANTED • • POSITIONS WANTED • • SERVICES AVAILABLE • • WORKSHOPS & CONFERENCES • • EDUCATIONAL OPPORTUNITIES • • ITEMS FOR EXCHANGE

## CAMP SUPERINTENDENT

Full-time position, including supervision of property maintenance, as well as supervising and coordinating camp building and development program. Also responsible for supervising winter week-end camping program.

Supervisory and administrative experience necessary. Prefer man experienced working with children. Knowledge of any of the following is desirable: building construction, forestry, agriculture and camping.

Housing for family provided.

Camp located near Holly, Michigan approximately 40 miles from Detroit.

Apply Camp Tamarack, 9999 Broadstreet, Detroit 4, Michigan

Complete resume in first letter, expected salary and when available.

## RECREATION THERAPISTS

for California State Hospitals.

New positions in several locations are open to college graduates with major in Recreation or Recreation Therapy and supervised field work. Monthly salary starts at \$376; opportunities for advancement to \$644. Excellent employee benefits. Applications accepted until November 14 for civil service examination to be held in all states. Write Medical Recruitment Unit, State Personnel Board, 801 Capitol Avenue, Sacramento, California.

**YOU CAN PUBLISH YOUR BOOK**

Free brochure tells how we published 2000 books for authors. Free editorial appraisal. Write Dept. R 10  
EXPOSITION PRESS / 386 4th Ave., N.Y. 16

## ICE WHEN YOU WANT IT with BELTEMP

artificial ice skating rinks by  
BELTZ ENGINEERING LABORATORIES  
11021 Whittier Avenue  
Detroit 24, Michigan. VEnice 9-1811

## BOOK MANUSCRIPTS CONSIDERED

by cooperative publisher who offers authors early publication, higher royalty, national distribution, and beautifully designed books. All subjects welcomed. Write, or send your manuscript directly.  
GREENWICH BOOK PUBLISHERS  
Attn. Mr. Hitchcock 489 Fifth Avenue  
New York 17, N. Y.



**joyfro BASKETBALL STEEL CHAIN NETS**

3 Years Guaranteed outdoors or indoors

Also featuring Joyfro's custom built

- ✓ NYLON BASKETBALL NETS & BALL CARRIERS
- ✓ ALUMINUM MULTI-PURPOSE STANDARDS
- ✓ TETHERBALL POLES & PADDLE SETS
- ✓ ALUMINUM SHUFFLEBOARD SETS

Send for Free Catalog

JAYFRO ATHLETIC SUPPLY CO.  
Dept. R, Box 1065, NEW LONDON, CONN.

## RECORDED TAPE

ONE STOP SERVICE

We carry all lines of stereophonic and monaural tapes.

EDUCATIONAL • BACKGROUND MUSIC  
GENERAL MUSIC TAPES  
TAPE PLAYBACK EQUIPMENT

Special discounts to recreation officers

Write on letterhead for free mail-order catalog.

## MAL'S RECORDING SERVICE

Dept. RE, Box 37, Rockaway Park 94, N. Y.  
Phone GRanite 4-4607

## NEW AND IMPROVED RYAN'S H. & R.

### DRY LINE MARKERS

5 DIFFERENT MODELS

From 20# to 100# Capacity  
Force Feed — Instant  
Shutoff — 50 lbs. capacity.

Shaker in Hopper for Constant Flow.

Adjustable Control on Handle.

SAVES TIME AND MATERIAL



Send to Dept. R for booklet on four other models  
H. & R. MFG. CO., LOS ANGELES 34, CALIF.

# NOTES *for the Administrator*

## Public Recreation Boards

A report prepared from data gathered from 321 cities by Community Chests and Councils of America, Inc., *Boards and Board Members of Health and Welfare Agencies*, contains interesting information with reference to 2,136 public and private agency boards with a total membership of 47,235. It reveals that the average membership of public agency boards is eight as compared with twenty-three members of the average voluntary agency. Public agency boards also meet more frequently, have a better average attendance record and tend to have longer terms of office.

An analysis of forty-one public recreation boards reveals that eighty-seven per cent approve policies and seventy-nine per cent prepare budgets; ninety per cent delegate interpretation of program to the director. Members are appointed by the mayor in sixty-one per cent of the agencies, by the local governing body in twenty-nine per cent and by the city manager in seventeen per cent. A high percentage of boards meet more than ten times a year, have overlapping terms and report more than seventy per cent attendance at board meetings; seventy-six per cent of the board members are under forty-five years of age.

## High School Class

Gene Coulson, superintendent of parks and recreation in Renton, Washington, recently completed ten years as instructor in a high school class in recreation leadership. Last year he had seventeen senior students and thirty-five are enrolled for the coming year. The class meets every day for two semesters and students receive one credit for the first semester and two credits for the second. Each must give 125 hours' service outside the classroom in actual face to face leadership in recreation. The course has proved a wonderful asset to the local recreation department and also has resulted in interesting students in recreation as a career.

## Evaluation

At the suggestion of a district representative of the National Recreation Association, a local recreation commission recently made an evaluation of its community, using the "Schedule for the Appraisal of Community Recreation." Many values resulting from this were reported. Members' reactions were interesting. They discovered things in their communities that they did not know and brought difficulties in their programs into focus. The commission had been at fault in some matters. A larger budget and more leadership personnel were needed. "We should do more planning with the school system and with our neigh-

boring city," they stated. These admissions indicated that the evaluation had awakened members to responsibilities they had not recognized previously.

For example: some members had not read the charter provisions relating to the work of the commission and did not know their powers and duties; meetings were rarely held; the city council was making decisions on matters without consulting the commission; the budget had been made up by the recreation director who presented it to the city council without approval or support by the commission.

The commission, as a result, decided to take a number of steps, including the following: secure the use of available school facilities, which use would depend upon securing more leadership personnel; arrange a meeting with the housing authority and, if possible, secure leadership for its recreation center; include in its annual budget request a full-time assistant for activities and part time assistants; hold regular commission meetings; inform the city council that any matter concerning recreation should be referred to the commission for a recommendation or report before city council action; arrange meetings with the city council, the school board and the park and recreation commission of the neighboring city.

## Citizens' Organizations

An organization entitled Friends of Public Parks and Recreation has been established and incorporated in Seattle, Washington. Its membership consists of individuals interested in parks and recreation in the city, in King County and in the state. Among its purposes are to promote, encourage and maintain interest in the preservation, acquisition, development, maintenance and use of natural resources and park and recreation areas. Other purposes include the soliciting of gifts, the expending or loaning of funds for property acquisition, development and maintenance, granting scholarships and assisting organizations with a similar purpose.

Fairmount Park system in Philadelphia also benefits from the services of two organizations of citizens. The Friends of the Wissahickon, organized more than forty years ago, and the recently formed Friends of the Pennypack are dedicated to the preservation of the natural beauty and wildness of these areas within the system.

## Unique Pool Feature

An indoor swimming pool under construction for the Memphis Athletic Club, in Memphis, Tennessee, contains a unique feature. These are overflow troughs both at deck level and eighteen inches lower. The double overflow trough will enable the pool to be filled to the lower level during periods when it is used by children. When filled to the higher trough the pool is suitable for official swimming meets.

Another feature is that the pool enclosure has an arched beamed ceiling and three sides of glass that can be removed for conversion into an outdoor pool in summer months. The pool is one unit of a comprehensive building which is to contain a gymnasium, handball courts, lounge, dining room, recreation room and various service facilities. ■

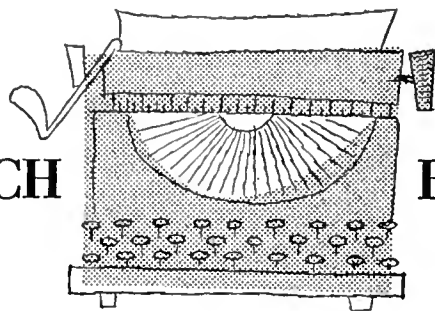

George D. Butler

### “Operation Outdoors”

A plan to double camping and picnic facilities in the national forests within the next five years in order to meet a steadily expanding demand for such facilities has recently been announced by the United States Department of Agriculture. A summary of the plan has been issued in a publication, *Operation Outdoors—Part I—National Forest Recreation*.<sup>\*</sup> The second part of the plan will deal with the improvement and management of wildlife habitat in cooperation with state game departments.

The national forests, with 45,713,000 visits in 1955, are expected to hit a 66,000,000 mark by 1962. Most of the camp and picnic areas and facilities for swimming and winter sports in the national forests were constructed during the 1930's with emergency funds; consequently they are not only inadequate to meet the mounting volume of visitors, but have deteriorated due to limited appropriations for maintenance.

In 1955, forest camp and picnic areas with a safe capacity of some 17,600,000 man-days use, actually received 25,500,000 man-days use—an overload of 39 per cent. The present overcrowding of these areas constitutes hazards and deprives many people of satisfactory use of the forests.

The plan has as its objectives the rehabilitation of existing facilities and the development and installation of new areas to alleviate present overuse and to accommodate future use as it develops. Eleven basic policies have been adopted as guides in carrying out the five-year program which involves a total capital investment of \$54,400,000. Of this amount, \$15,200,000 are allocated to rehabilitation and \$39,200,000 for new construction. This means that the total amount to be spent during the years 1958-62 for administration, operation and development of recreation areas in the national forests would be \$85,000,000.

In estimating the cost of the program several unit costs have been developed. The average cost of developing a new camp and picnic family unit, which consists of a table, fire grate and parking spur, is estimated to be \$860 per unit. An average of \$370 per family unit is needed to rehabilitate existing facilities and to provide modernized water and sanitary facilities. The annual maintenance cost per unit is \$33 for present facilities and decreases to \$23 per family unit with the build-up in the new areas which will require less maintenance. This amount is equivalent to about three per cent on the capital investment and includes about two-thirds

labor cost and one third for supplies and materials. The work of sanitation and clean-up is estimated to cost annually about \$30 per family unit.

The report describing the program contains a number of tables giving detailed information as to expenditures, visits and uses of forest recreation facilities.

### Selected Planning Trends

The Pennsylvania Economy League, Inc., of Pittsburgh, issued a report in 1956 entitled, *Public Capital Improvement Planning and Finance by Major Governments in the Principal Metropolitan Areas*. One section deals with parks and recreation and lists the 1955 capital outlays for forty-one metropolitan cities and proposed capital outlays for designated program periods in the years ahead. The total 1955 outlay of the forty-one cities was \$58,700,000. It comments on a number of significant features made possible by this expenditure.

Another section deals with libraries, museums and art centers. It indicates proposed capital outlays for the years ahead. It points out that financing for facilities such as museums, music halls and other cultural facilities tends, both traditionally and currently, toward a mixture of public and private subscription sources for capital financing. “The accent is on private sources for all or a major share of capital funds. Public agencies are generally found donating land and occasionally meeting operating deficits.”

A third section, covering auditoriums, stadiums and convention centers, describes recent, current or proposed projects in a number of metropolitan cities.

Among the selected capital planning trends listed are: the development of civic centers; increased attention to land acquisition planning; coordination of capital improvement programs between government agencies in a metropolitan area; neighborhood improvement and regional approaches.

### International Leisure Study

A meeting of the Education Committee of the International Union of Local Authorities recently held in Paris was attended by representatives from five countries. There it was decided to make a number of case studies of adult education and leisure-time activities, including sport, in a few carefully selected local authorities in the different countries represented on the committee. ■

MR. BUTLER is director of the NRA Research Department.

\* Available from Superintendent of Documents, U. S. Government Printing Office, Washington 25, D. C., Pp. 14. \$20.

AMERICA'S FINEST ATHLETIC BALLS

FOR EVERY AGE GROUP,  
PRICE OR SKILL —

# VOIT<sup>®</sup>

GOES WITH THE GAME

NEW YORK 11  
CHICAGO 11  
LOS ANGELES 11

## ARE YOU LOOKING FOR A NEW FIELD GAME?

A Game Requiring a Minimum of Equipment?  
A Game that is Fun? Easy to Learn?

### TRY **SPEED-A-WAY**

Now played in U.S., Canada, Hawaii and England

**SPEED-A-WAY FILM**

Rental—\$2.50 (b&w) and \$3.75 (color)

**SPEED-A-WAY GUIDE BOOK**

Containing rules and charts—\$1.00

Order Now  
**MARJORIE S. LARSEN**

1754 Middlefield

Stockton 4, California

## x-acto<sup>®</sup> Colonial Antique Kits

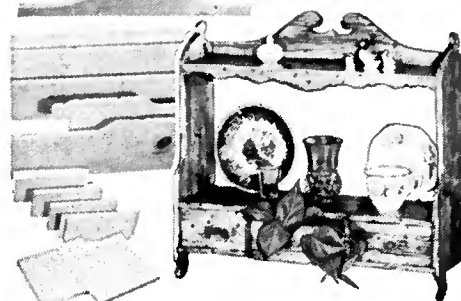

Complete "assemble-it-yourself" kits  
for making full size reproductions  
of Colonial Antique Masterpieces!

Everything included... precise pre-cut wood  
sections with pre-marked nail holes, knife  
for antiquing, rub-on stain, nails, sandpaper,  
steel wool, gauze wipe, and simple direc-  
tions. 6 kits from \$2.95 to \$8.95.

**x-acto**



**FREE!** Full color Bro-  
chure of all six X-acto  
Colonials.

**X-ACTO, INC.**  
48-99 Van Dom Street  
Long Island City 1, N. Y.

### Program in the Doldrums?

Everybody loves to play  
wholesome, action-packed

# POOL

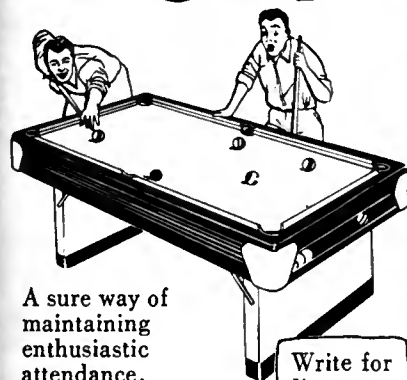

A sure way of  
maintaining  
enthusiastic  
attendance.

Write for  
literature  
today.

**SUPERIOR  
FOLDING  
POOL TABLES**

**Superior**  
INDUSTRIES  
CORPORATION

565 Barry Street • New York 59, N. Y.

## LOST CONTACT ?

Hard to find items for recreation in  
*Pools, Parks, Golf Courses, and at  
Schools and Institutions*  
are all listed in the:

**1957 BUYER'S GUIDE**  
in  
the October issue of  
**PARK MAINTENANCE**

Over 600 suppliers are shown,  
with a product description.

Single copies only \$5.00

One Year \$3.00

Three Years \$7.50

PARK MAINTENANCE  
P. O. Box 409-R  
Appleton, Wisconsin

## "LOADS OF FUN"



## with SAFETY

**HOBBY HORSE SWING**  
Excitement—adventure—fun and exercise.  
They're all combined in this heavy duty  
Burke-Built Hobby Horse Swing... with  
complete safety. Three point suspension  
keeps seat level at all times. No pushing  
necessary—even a tot can create his own  
momentum.

**KIDDIE GLIDER**  
A companion piece to the Hobby Horse  
Swing. Two can find adventure together  
in Burke's Heavy Duty Kiddie Glider and  
they can't bang their heads, pinch their  
legs, or swing too high.

Burke builds a complete line of swings,  
slides, and playground equipment for  
schools, hospitals, institutions, cities and  
recreation areas, including several new  
and completely tested revolutionary units  
for playgrounds everywhere.

For complete information write Dept. A

*the J.E. Burke Company*  
FOND DU LAC, WISCONSIN  
NEW BRUNSWICK, NEW JERSEY

ADMINISTRATION

## Books & Pamphlets Received

- ADOLESCENT GIRLS (Survey). Girl Scouts of the USA, 155 East 44th Street, New York 17. Pp. 251. Paper \$2.75.
- AMERICA LEARNS TO DANCE, Joseph E. Marks, III. Exposition Press, 386 Fourth Avenue, New York 16. Pp. 133. \$4.00.
- BOWLING FOR ALL (Third Edition), Joe Falcaro and Murray Goodman. Ronald Press, 15 East 26th Street, New York 10. Pp. 104. \$2.95.
- CHRISTMAS SONGS AND THEIR STORIES, Herbert H. Wernecke. Westminster Press, Witherspoon Building, Philadelphia 7. Pp. 128. \$2.50.
- CLINICAL APPLICATION OF RECREATION THERAPY, John Eisele Davis. Charles C. Thomas, 301 East Lawrence Avenue, Springfield, Illinois. Pp. 118. \$3.75.
- COMPLETE BOOK OF CHILDREN'S PLAY, THE, Ruth E. Hartley and Robert M. Goldenson. Thomas Y. Crowell, 432 Fourth Avenue, New York 16. Pp. 461. \$5.00.
- CRAZIEST HALLOWEEN, THE, Ursula von Hippel. Coward-McCann, 210 Madison Avenue, New York 16. Pp. 16. \$2.00.
- HEALTH FOR MODERN LIVING, H. Frederick Kilander. Prentice-Hall, Englewood Cliffs, New Jersey. Pp. 494. \$4.95.
- HISTORY OF SQUARE DANCING, THE, S. Foster Damon. Barre Publishing Company, Barre, Massachusetts. Pp. 54. \$3.25.
- HOW TO HOLD AN AUDIENCE (Successful Public Speaking), Howard Geo. Garrett. The Citadel Press, 222 Fourth Avenue, New York 3. Pp. 191. \$3.50.
- HOW TO MAKE CERAMICS, Gertrude Engel. Arco Publishing Company, 480 Lexington Avenue, New York 17. Pp. 144. \$2.00.
- INDIAN TIPI, THE, (History, construction and use), Reginald and Gladys Laubin. University of Oklahoma Press, Norman, Oklahoma. Pp. 208. \$3.95.
- NATIONAL STAY-IN-SCHOOL CAMPAIGN. Superintendent of Documents, Government Printing Office, Washington 25, D. C. Pp. 24. \$1.5.
- ON BEING A LEADER. Association Press,

291 Broadway, New York 7. Pp. 15. \$25.

PAPER FIGURES, Anna E. Pauli and Margaret S. Mitzit. Charles A. Bennett Company, 237 North Monroe Street, Peoria, Illinois. Pp. 102. Paper \$2.00.

PERSPECTIVES ON ADMINISTRATION, Dwight Waldo. University of Alabama Press, University, Alabama. Pp. 143. \$2.50.

PLANNING YOUR EXHIBIT, Jane Lane and Beatrice K. Tolleris. National Publicity Council for Health and Welfare Services, 257 Fourth Avenue, New York 10. Pp. 32. Paper \$1.25 (plus \$.05 postage).

PLANTS INDOORS, C. R. Boutard. Abelard-Schuman, 404 Fourth Avenue, New York 16. Pp. 254. \$4.50.

PLAYS FOR THE CHURCH. National Council of the Churches of Christ, 120 East 23rd Street, New York 10. Pp. 40. \$.50 (plus \$.05 postage).

PSYCHIATRIC ASPECTS OF SCHOOL DESEGREGATION (Report #37). Group for the Advancement of Psychiatry, 1790 Broadway, New York 19. Pp. 95. Paper \$1.00.

RECREATION LEADERSHIP (#87). W. C. Sutherland. Bellman Publishing Company, P.O. Box 172, Cambridge 38, Massachusetts. Pp. 36. Paper \$1.00.

RIFLERY: SHOOTING'S FUN FOR EVERYONE; WHAT EVERY PARENT SHOULD KNOW . . . WHEN A BOY OR GIRL WANTS A GUN. Sportsmen's Service Bureau, 250 East 43rd Street, New York 17. Free.

SCHOOL AND COLLEGE SAFETY (Current Safety Topics — Volume 24). National Safety Council, 425 North Michigan Avenue, Chicago 11. Pp. 130. Paper \$.85.

SEX FACTS AND FICTION FOR TEEN-AGERS, Eugene B. Mozes. Ottenheimer Publishers, 4805 Nelson Avenue, Baltimore 14, Maryland. Pp. 169. \$2.95.

SONGS THE MOHAWKS SING, Mary R. Carse. Mary R. Carse, Hinesburg, Vermont. Pp. 6. \$.50.

SUCCESSFUL SUPERVISION, John D. Gerletti and Frank B. Black. William C. Brown Company, Dubuque, Iowa. Pp. 66. Paper \$2.00.

TEACH YOURSELF BOOKS: PERSPECTIVE DRAWING, H. F. Hollis, Pp. 198; HANDWEAVING, Eve Cherry, Pp. 191. Roy Publishers, 30 East 74th Street, New York 21. Each \$2.50.

THIRTY PLAYS FOR CLASSROOM READING, Donald D. Durrell and B. Alice

Crossley. Plays, Inc., 8 Arlington Street, Boston 16. Pp. 206. \$3.75 (trade edition); \$3.00 (text edition).

UNDERSTANDING GIRLS, Clarence G. Moser. Association Press, 291 Broadway, New York 7. Pp. 252. \$3.50.

WHAT EVERY WRITER SHOULD KNOW ABOUT PUBLISHING HIS OWN BOOK. Exposition Press, 386 Fourth Avenue, New York 16. Pp. 23. \$25.

WHY AND HOW OF DISCIPLINE, THE, Aline B. Auerbach. Child Study Association of America, 132 East 74th Street, New York 21. Pp. 43. \$40.

## Magazine Articles

THE AMERICAN JOURNAL OF SOCIOLOGY, *May 1957*

A Preliminary Bibliography on Leisure, *Reuel Denney and Mary Lea Meyersohn.*

THE CRIPPLED CHILD, *June 1957*  
Aquatic Therapy (Program for handicapped), *Edward J. Koenemann.*

JUNIOR LEAGUE MAGAZINE *July-August 1957*  
Junior Leagues and Senior Citizens.

NEA JOURNAL, *May 1957*  
I Live with Teen-Agers, *Novella Duboise.*  
The Gift of Time, *August Heckscher.*

PARK MAINTENANCE, *June 1957*  
What Happens when Parks, Recreation, Forestry Merge?

SENIOR CITIZEN, *August 1957*  
Senior Citizen Month Widely Observed.  
The Seminar at Rock Island, *Albert T. Sands.*  
The Wonderful Gift of Laughter, *Fern Long.*

SWIMMING POOL AGE, *June 1957*  
Portable Air-Supported Dome Can Add Months to Your Swimming Season.

Aquatics for the Mentally Retarded, *Stratton F. Caldwell.*

A Survey of Pool Structure in High Schools and Colleges, *John Paul Stark.*

Checklist of Pool Design and Construction.  
Increase Your Pool Attendance.

WOMAN'S DAY, *July 1957*  
Art of Arranging Flowers, *Rachel Carr.*

—, *August, September, October 1957*  
Lesson in Flower Arranging (in three parts), *Rachel Carr.*

# NEW

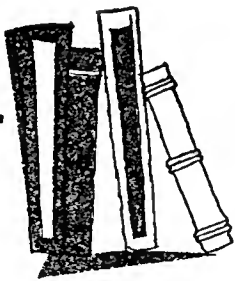

# PUBLICATIONS

*Covering the Leisure-time Field*

## Recreation in the Age of Automation

Paul F. Douglass, John L. Hutchinson and Willard C. Sutherland, Editors. American Academy of Political and Social Science, 3937 Chestnut Street, Philadelphia 4. Paper \$2.00.

The September 1957 issue of *The Annals* of the American Academy of Political and Social Science is devoted to the subject of "Recreation in the Age of Automation." In 80,000 words, written by twenty-seven distinguished leaders in American life, the volume assembles facts for handy reference, surveys the profession of recreation critically but constructively, and ends with "An Agenda for Recreation," designed by Professor James C. Charlesworth, president of the academy, to provide a guide for the further discussion of major issues.

The volume is divided into six parts. Part I attempts to clarify basic concepts. Part II discusses the movement toward professional leadership and professional standards as the fact of leisure is assimilated into the intellectual, emotional, and spiritual life of our times. Part III presents a series of sampling papers to indicate through an examination of some few representative areas of specialization the breadth, depth, and thrust of the leisure mode. Part IV gives three papers of commercial recreation to indicate (1) the resurgence of participation in a family sport (boating), (2) geographical range and mobility as shown by travel, and (3) a new concept of debt in terms of a budget program for leisure enjoyment. Part V presents two representative case histories in public recreation to emphasize the need for planning, for professional and technical competence, and, above all, for the necessity of political literacy and civil courage in the support of recreation policies. The concluding section summarizes fundamental issues.

Above all, this volume indicates the growth of professionalism in recreation administration, an encouraging development in the reconstruction of philosophy, and toward growth, depth, and quality.

Because the Philadelphia Department

of Recreation believes *The Annals* to be unsurpassed for in-service training, Recreation Commissioner Robert Crawford has ordered one hundred and fifty copies for presentation to each professional staff member for individual reading, group study. A special display of *The Annals* has been planned for the National Recreation Association Book Center at National Recreation Congress in Long Beach, and copies will be available to members of the 2nd Annual Institute on Recreation Administration. Members of the recreation profession will find two articles of major importance in Part I. George Soule of the Twentieth Century Fund discusses "The Economics of Leisure," to identify a measurable concept. He comes up with a definition that leisure is time not commercially sold. The other paper, by Professor John T. Howard of the Massachusetts Institute of Technology, is an exciting exploration into "Metropolitan Growth and Planning."

Section II, "Professional Development and Control," provides enough factual analysis and provocative points of view to keep state societies buzzing for the rest of the year. For example, Norman Miller of the University of California at Los Angeles gives a detailed discussion of "Professional Education" and relates the subject to personnel needs and policies. Professor Garrett Eppley of the University of Indiana moves into the area where lesser angels would fear to tread by inventorying professional associations and showing how they might be coordinated and combined so recreation could speak with "one voice."

Among many other notable discussions of special interest to administrators concerned with personnel is the paper by the National Recreation Association's Willard C. Sutherland. He points out that comparative studies in the use of leisure show a higher position, larger income, and increased security do not necessarily lead to culture. Unless material advancement is combined with personal example and the persuasion exercised by the presence of intelligent standards for the use of leisure, it may end in boredom, neurosis, and general decadence. He sees

the necessity for professional workers who continue experiencing inner growth and increasing technical competence.

For many years this publication will be studied as a whole and referred to by articles. Professor Charlesworth's "Agenda" will keep discussion at boiling point for a long time.—*Charles Cranford, Deputy Commissioner of Recreation, Philadelphia, Pennsylvania.*

## A Contribution to the Heritage of Every American

Nancy Newhall. Alfred A. Knopf, 501 Madison Avenue, New York 22. Pp. 179. \$13.50.

This is a beautiful publication. The printing, paper, photography, binding are all in keeping with the subject, which deals with John D. Rockefeller, Jr.'s contributions to scenic America and to the conservation of this country's natural beauty. This boxed edition has stunning color-photo end papers and

## SQUARE DANCE? FOLK DANCE?

RECORDS - BOOKS - SUPPLIES

Official Suppliers to  
Colleges and City Departments

No postage charge—no packing charge—orders shipped same day as received—complete stock of all labels in the field.

Send for free catalogs and a sample copy of

## AMERICAN SQUARES

The Magazine of American Folk Dancing

1159 Broad Street, Newark 2, N. J.

## Jamison PLAYGROUND EQUIPMENT

Be sure to check the many exclusive features of this rugged line. Write for free catalog of 254 items.

Jamison Manufacturing Co.  
5781 South Mettler Street  
Los Angeles 3, California

Since  
1923

## monroe FOLDING BANQUET TABLES

Direct Factory  
Prices & Discounts  
To Churches, Clubs,  
Lodges, Schools  
and All Organizations.

Over 40,000 institutions own and use modern Monroe Folding Banquet Tables.

Write for the new MONROE 50TH ANNIVERSARY CATALOG of Folding Tables, Folding Chairs, Trucks, Movable Partitions, Folding Risers, etc. Get our special prices, quantity discounts, also terms.

Monroe Co., 181 Church St., Colfax, Iowa



AND  
MONROE TRUCKS



thirty-two color plates, as well as approximately 150 other photographs.

In an epilogue, Horace Marden Albright says, "I hope that this book will lead more and more people to share in the responsibility of all of us as individuals to preserve our heritage. Many, through voluntary association, can give material support to conservation projects together that they could not give separately. Legislators intelligently concerned with conservation deserve and need wide support from more citizens who will take the trouble to inform themselves of new needs and weak spots in our conservation program."

The story is one of the realization of early vision and of the desire of one man to preserve natural beauty for the enjoyment of the greatest number of people. Every park and recreation person will want to examine it, own it, give it as a gift.

### The Creation of Sculpture

Jules Struppeck. Henry Holt and Company, 383 Madison Avenue, New York 17, Pp. 260. \$8.00.

This book should be reviewed by an artist, preferably a sculptor. For this

reason, no attempt to judge the quality of the techniques explained will be made here.

The reaction of a non-sculptor to this book, however, seems to warrant calling it to the attention of those recreation departments fortunate enough to have skilled instructors in arts and crafts. A class in ceramics or clay modeling, for example, could go very easily, and with increasing enthusiasm, into the techniques of sculpture in clay described and illustrated so clearly here.

In fact, this book should be very important to the development of progression not only in clay, but in such media as plaster, metals, plastics and wood. The preliminary, explanatory chapters are excellent for the development of an understanding of and appreciation for sculpture.

It is beautifully printed and contains many helpful, photographic illustrations. The author, of the Newcomb College of Art, Tulane University, has created a book capable of holding the interest and enthusiasm of a non-specialist. It will do so to an even higher extent when read and used by someone with training and experience in this or allied fields.

### If You Live with Little Children\*

Carolyn Kauffman and Patricia Farrell. G. P. Putnam's Sons, 210 Madison Avenue, New York 16. Pp. 145. \$3.50.

If you have any small children, if you know anyone who has small children, and if you have any experience of any sort with small children, this is the book for you! It is designed to help children to entertain themselves and make life with small children the fun it should be. Anyone who can read it without chuckling over something on almost any page should be a hermit. It is the best book on home play from the point of view of enjoying small children that I have read.

Mixed with excellent devices for getting along with them, with the least possible irritation and the most possible enjoyment, are hundreds of clever devices and pungent advice, given with a rare sense of humor.

Under "Things that Often Happen at Birthday Parties" are such comments as: "The host cannot bear it when 'Happy Birthday' is sung to him. It is too overpowering an experience, so he hides under the table, puts his fingers in his ears, or makes loud noises. . . . You send your child to a party next door, and in five minutes he wanders home again. . . . The host greets his guests by saying, 'Where's the present?'"

\* Available from the NRA Recreation Book Center, 8 West Eighth Street, New York 11.

. . . The host goes to his room and won't come out."

Anyone with any dealings with pre-school-age children will not only get many excellent ideas for interesting play activities, but will benefit from the warmth and understanding that flows through every page of this book.—Virginia Musselman, NRA Program Department.

### Modern Dance

#### Building and Teaching Lessons Second Edition

Aileene Lockhart. Wm. C. Brown Company, 215 West Ninth Street, Dubuque, Iowa. Pp. 158. Paper \$3.00.

Modern dance is a creative art form and a basic art experience. Give your young people a chance at it! Use this new and revised edition of a book designed to help any leader start a group in this creative art form. All leaders or teachers cannot be trained dance specialists: but this publication acquaints the beginner with the basic rhythms and patterns which can be fun, stimulate interest and further activity in this field.

The book carries detailed sections with instructions and illustrations which include beautifully prepared charts and music drawings. The sections are on: Warm-Ups; Rhythmic Fundamentals; Factors Related to Movement; Movement Fundamentals and Dance Skills; Creative Activity; Evaluation.

Let this book be an open door for your boys and girls—to an exciting new experience.

### Folk Dancing

#### Second Edition

Grace L. Fox and Kathleen Gruppe Merrill. Ronald Press, 15 East 26th Street, New York 10. Pp. 89. \$3.50.

Here is a second edition of a book of teaching suggestions and directions for dances from a variety of countries. It includes American squares with a description of basic figures and formations. A classified index lists contents according to nationalities. Music is given in most instances and has been arranged as simply as possible. Sketches in black and white by Charlotte St. John reflect the spirit of the dances, portray the native costumes, and add greatly to the attractiveness of the book.

## INDEX OF ADVERTISERS

|                                          | PAGE |
|------------------------------------------|------|
| All Metal Tennis Table Company .....     | 297  |
| American Playground Device Company ..... | 299  |
| American Squares .....                   | 307  |
| Beltz Engineering Laboratories .....     | 302  |
| The J. E. Burke Company .....            | 305  |
| California State Personnel Board .....   | 302  |
| Camp Tamarack .....                      | 302  |
| Pefer Carver Associates .....            | 299  |
| Castello Fencing Equipment .....         | 297  |
| Chicago Roller Skate Company .....       | 297  |
| Outside Back Cover                       |      |
| Exposition Press .....                   | 302  |
| Greenwich Book Publishers .....          | 302  |
| H. & R. Manufacturing Company .....      | 302  |
| Harvard Table Tennis Company .....       | 283  |
| Hillierich & Bradsby .....               | 277  |
| Inside Front Cover                       |      |
| Hillyard .....                           | 277  |
| Jamison Manufacturing Company .....      | 307  |
| Jayfro Athletic Supply Company .....     | 302  |
| Mal's Recording Service .....            | 302  |
| Monroe Company .....                     | 307  |
| Nissen Trampoline Company .....          | 286  |
| Park Maintenance .....                   | 305  |
| Parks & Recreation .....                 | 299  |
| Rawlings Sporting Goods Company .....    | 299  |
| The Ronald Press Company .....           | 297  |
| Speed-A-Way .....                        | 305  |
| Square Dance Associates .....            | 280  |
| Superior Industries Corporation .....    | 305  |
| Vogel-Peterson Company .....             | 297  |
| Voit .....                               | 305  |
| Wise Engineering Company .....           | 281  |
| X-acto, Inc. .....                       | 305  |

#### SUBSCRIPTION RATES

|                                                          |        |
|----------------------------------------------------------|--------|
| 1 year .....                                             | \$4.00 |
| 2 years .....                                            | 7.25   |
| Foreign .....                                            | 4.50   |
| Library subscriptions .....                              | 3.70   |
| Club subscriptions .....                                 | 3.50   |
| <i>(Ten or more individuals subscribing at one time)</i> |        |

#### RECREATION MAGAZINE

8 West Eighth Street, New York 11, N. Y.



# Recreation Leadership Training Courses

Sponsored by the National Recreation Association  
and  
Local Recreation Agencies

**October, November and December 1957**

**HELEN M. DAUNCEY**  
Social Recreation

Abilene, Texas  
October 21-24

Scott Fikes, Director of Parks and Recreation

Fayetteville, Arkansas  
October 28-31

Dr. Troy Hendricks, Head, Department of Health, Physical Education and Recreation, University of Arkansas

**RUTH G. EHLERS**  
Social Recreation

Canton, Ohio  
October 28-31

C. W. Schnake, Recreation Director, Memorial Auditorium

State of Vermont  
November 5-15

Mrs. A. O. Brungardt, Vermont Director of Recreation, Montpelier

**FRANK A. STAPLES**  
Arts and Crafts

Klamath Falls, Oregon  
October 21-31

Robert Bonney, Director, Parks and Recreation, City Hall

---

Mr. Staples will conduct two-week periods of training at the following Air Bases, November 4-28: Warren Air Force Base, Cheyenne, Wyoming, and Lowry Air Force Base, Denver, Colorado. For further information regarding these write to Howard Beresford at 3055 Bellaire, Denver 7, Colorado.

---

Miss Dauncey and Mr. Staples will be in attendance at the 39th National Recreation Congress in Long Beach, September 30-October 4.

---

Attendance at training courses conducted by National Recreation Association leaders is usually open to all who wish to attend. For details as to location of the institute, contents of the course, registration procedure, and the like, communicate with the sponsor of the course as listed above.

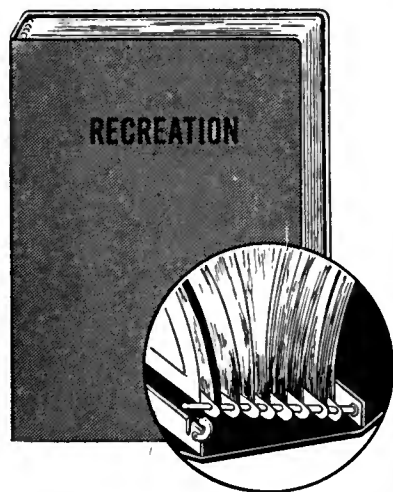

**Order NOW and SAVE!**

**BINDERS for *Recreation***

- Blue heavy simulated leather stamped in gold
  - Each holds one year's issues
  - Opens flat for changes
- 1954, 1955, 1957, 1958 and Undated

**\$3.00 each**

After January 1, 1958 the price will be \$3.50

**RECREATION MAGAZINE, 8 West Eighth Street, New York 11**

# Space for 10 or 210?



## they *All* can have *Active* fun in your gym

Roller skating is more fun than a barrel of monkeys, and it entertains and exercises more people in less space than any other sport.

Little equipment is needed, little supervision is necessary.

That's why more and more schools are making roller skating a definite part of their physical education and recreation programs.

### NEW RUBBER-PLASTIC WHEELS ARE KIND TO GYM FLOORS

These new Duryte rubber-plastic wheels outwear others and are guaranteed not to mar or scratch the floors. "Chicago" has a skate designed for any type of floor surface or finish. Write today for free details on roller skating programs and skating equipment.

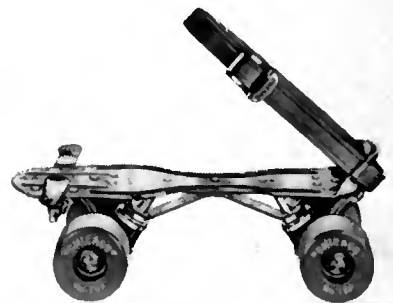

**"CHICAGO"**

*Roller Skates*

Chicago Roller Skate Co., 4490-J W. Lake Street, Chicago 24, Ill.

# Recreation

Henry Hunter Library  
Museum of Science and Industry  
Jacksonville, Florida

Nov 1957



# Your HOLIDAY List

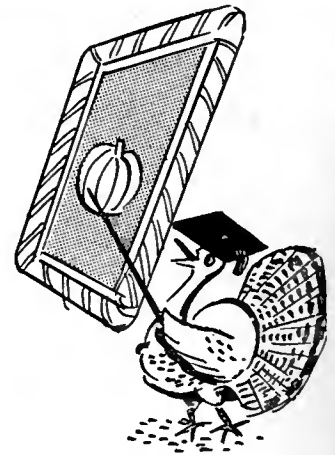

- P 197—Faith of Our Fathers ..... \$25  
Pilgrim pageant: signing of Mayflower Compact, first Thanksgiving.
- P 119—A Harvest Home Thanksgiving Party ..... .15  
Suitable for small groups.
- P 127—Thanksgiving Down on the Farm ..... .15  
A party for large groups.
- P 120—Two Ceremonial Programs for Thanksgiving ..... .15  
Simple ceremonies with music, good for church or community house.
- 375—Ideas for Christmas ..... \$2.00  
To help make Christmas a more complete family holiday. Covers story of Christmas, customs, carols, decorations, parties, gifts, food, etc. Illustrated.
- 370—Decorating for Joyful Occasions .. 1.50  
By Marjorie W. Young. Unique decorating ideas for Christmas, showers, weddings, receptions, other celebrations. Fully illustrated. Brief sketch of history of some of the holidays. Flower arrangements.
- 920—Holiday Craft and Fun ..... 2.95  
By Joseph Leeming. A valuable craft book, full of clever ideas for party materials, favors, games for seventeen important holidays all around the year.
- 133—A Simplified Guide to Gift Wrapping ..... 1.00  
By Adelaide and Josephine Shaw. A spiral-bound book, fully illustrated.
- P 132—Stories of the Christmas Carols .... .15  
With suggestions for a "Learn a Carol a Day" program.
- 919—Holiday Candy and Cookie Cook Book ..... \$2.00  
By J. H. Degros. Recipes for making extra-special goodies for all holidays, and instructions for basic candies and cookies.
- 94—How to Make Paper Flowers and Party Decorations ..... 2.98  
By Natalie Morgan. Complete instructions for hundreds of flowers, gift wrappings, costumes, table decorations, holiday trimmings. Over 600 illustrations.
- 609—Tales for Telling\* ..... 2.75  
By Katherine Williams Watson. Timed stories adapted from old favorites and arranged under the following classifications: Christmas, Easter, fairy and folk tales, farm, Hallowe'en, humor, Indian, Thanksgiving.
- 923—Make Your Own Merry Christmas .. 2.50  
By Anne Wertsner. A guide to handmade Yuletide decorations. Thirty illustrations.
- P 196—A Community Christmas Party ..... .20  
Planning suggestions with many games, stunts and contests.

## CHRISTMAS BOOKLETS

A series of booklets covering activities, games, decorations.

- 364—The Christmas Book ..... \$ .75  
By Marguerite Ickis.
- 365—Christmas Crafts and Decorations ..... .75  
National Recreation Association.
- 366—Games for the Christmas Season ..... .65  
National Recreation Association.
- 367—Plays, Pageants and Ceremonials for the Christmas Season ..... .65  
National Recreation Association.

## SONG SHEETS

Christmas Carols ..... 1,000 for \$8.00; 100 for \$.80



## RECREATION BOOK CENTER

8 West Eighth Street, New York 11, New York

Prices subject to publisher's changes.

\* Not subject to NRA membership discount.



**GET ENTHUSIASM!**

*Free... complete kit to organize a gold medal*

# HARVARD TABLE TENNIS TOURNAMENT IN YOUR SCHOOL, PLANT OR RECREATION PROGRAM

Everyone plays in a Harvard Gold Medal Table Tennis Tournament . . . because everyone enjoys this exciting event that serves more players, in less space, without any permanent installation and at lower cost than most other school sports.

We will send, **ABSOLUTELY FREE**, the Harvard Tournament Kit containing everything you need to organize your own full-participation tournament: Harvard Table Tennis Teacher with instructions, rules and tournament tips; 2 Tournament Charts; complete publicity program and tally sheets.

**FREE . . .** for your winners, Harvard Gold Medals and award certificates when you complete the tally sheets. Mail the coupon below today.

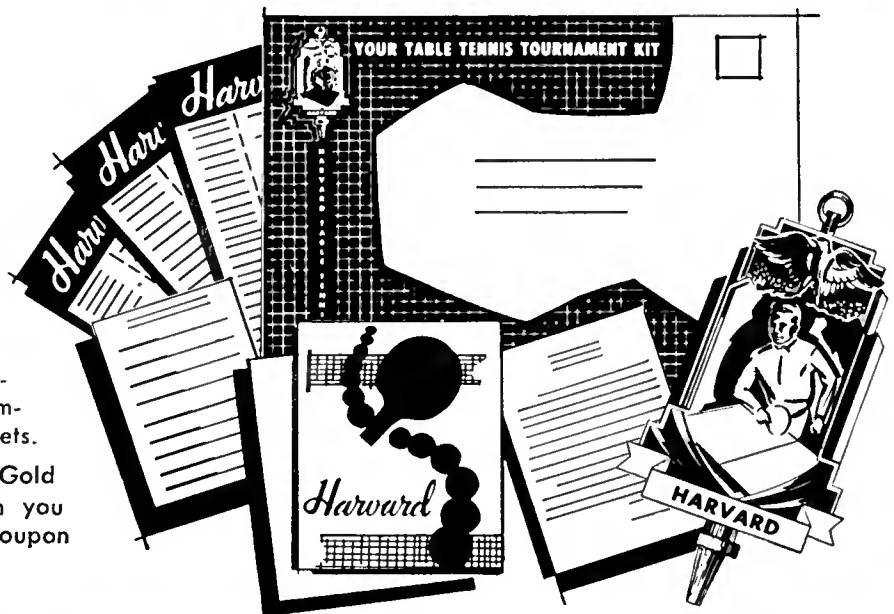

*Harvard* **TABLE TENNIS CO. 60 STATE ST. BOSTON 9, MASS.**

R-11

Gentlemen:

In order to run a table tennis tournament please send us the **FREE** Harvard Tournament Kit.

SCHOOL OR ORG. \_\_\_\_\_  
 NAME \_\_\_\_\_  
 POSITION \_\_\_\_\_  
 STREET & NO. \_\_\_\_\_  
 CITY \_\_\_\_\_ ZONE \_\_\_\_\_ STATE \_\_\_\_\_

We plan to start our tournament on \_\_\_\_\_

There will be approximately \_\_\_\_\_ participants.

We do \_\_\_\_\_, do not \_\_\_\_\_ offer table tennis all year.

Table Tennis is part of our \_\_\_\_\_ program.

There are \_\_\_\_\_ in our school or organization.

# NATIONAL RECREATION ASSOCIATION

*A Service Organization Supported by Voluntary Contributions*

JOSEPH PRENDERGAST, *Executive Director*



## OFFICERS

|                      |       |                       |
|----------------------|-------|-----------------------|
| F. W. H. ADAMS       | ..... | Chairman of the Board |
| GRANT TITSWORTH      | ..... | First Vice-President  |
| SUSAN M. LEE         | ..... | Second Vice-President |
| MRS. WM. L. VAN ALEN | ..... | Third Vice-President  |
| ADRIAN M. MASSIE     | ..... | Treasurer             |
| JOSEPH PRENDERGAST   | ..... | Secretary             |

## BOARD OF DIRECTORS

|                         |       |                     |                        |       |                     |
|-------------------------|-------|---------------------|------------------------|-------|---------------------|
| F. W. H. ADAMS          | ..... | New York, N. Y.     | MRS. CHARLES V. HICKOX | ..... | Michigan City, Ind. |
| F. GREGG REMIS          | ..... | Boston, Mass.       | SUSAN M. LEE           | ..... | New York, N. Y.     |
| MRS. ROBERT WOODS BLISS | ..... | Washington, D. C.   | FREDRIC R. MANN        | ..... | Philadelphia, Pa.   |
| MRS. ROLLIN BROWN       | ..... | Los Angeles, Calif. | HENRY W. MEERS         | ..... | Chicago, Ill.       |
| HOWARD H. CALLAWAY      | ..... | Hamilton, Ga.       | WILLIAM C. MENNINGER   | ..... | Topeka, Kan.        |
| HODDING CARTER          | ..... | Greenville, Miss.   | CARL E. MILLIKEN       | ..... | Augusta, Me.        |
| MRS. ARTHUR G. CUMMER   | ..... | Jacksonville, Fla.  | PAUL MOORE, JR.        | ..... | Indianapolis, Ind.  |
| HARRY P. DAVIDSON       | ..... | New York, N. Y.     | MRS. RUTH E. PEELER    | ..... | Seattle, Wash.      |
| RICHARD A. DOUGHERTY    | ..... | New York, N. Y.     | JOSEPH PRENDERGAST     | ..... | New York, N. Y.     |
| JAMES H. EVANS          | ..... | Bronxville, N. Y.   | MRS. RICHARD E. RIEGEL | ..... | Montchanin, Del.    |
| RICHARD A. FARNSWORTH   | ..... | Houston, Tex.       | WILLIAM S. SIMPSON     | ..... | Bridgeport, Conn.   |
| MRS. HOWARD A. FRAME    | ..... | Los Altos, Calif.   | EDGAR W. SMITH         | ..... | Portland, Ore.      |
| MRS. PAUL C. GALLAGHER  | ..... | Omaha, Nebr.        | GRANT TITSWORTH        | ..... | Noroton, Conn.      |
| ROBERT GARRETT          | ..... | Baltimore, Md.      | MRS. WM. L. VAN ALEN   | ..... | Edgemont, Pa.       |
| MRS. NORMAN HARROWER    | ..... | Fitchburg, Mass.    | FREDERICK M. WARBURG   | ..... | New York, N. Y.     |

## HEADQUARTERS STAFF

|                                                                                                          |                                                                                     |                                                                                                                     |
|----------------------------------------------------------------------------------------------------------|-------------------------------------------------------------------------------------|---------------------------------------------------------------------------------------------------------------------|
| <b>Executive Director's Office</b><br>ARTHUR WILLIAMS    ALFRED H. WILSON                                | <b>Personnel Service</b><br>WILLARD C. SUTHERLAND    MARY GUBERNAT                  | <b>Areas and Facilities Planning and Surveys</b><br>G. LESLIE LYNCH                                                 |
| <b>Field Department</b><br>CHARLES E. REED    WILLARD B. STONE<br>JAMES A. MADISON                       | <b>Program Service</b><br>VIRGINIA MUSSELMAN                                        | <b>Katherine F. Barker Memorial Secretary for Women and Girls</b><br>HELEN M. DAUNCEY                               |
| <b>Research Department</b><br>GEORGE D. BUTLER    MURIEL E. MCGANN<br>RUTH MACKLER                       | <b>Recreation Magazine</b><br>DOROTHY DONALDSON    AMELIA HENLY                     | <b>Recreation Leadership Training Courses</b><br>RUTH EHLEAS    ANNE LIVINGSTON<br>FRANK A. STAPLES    GRACE WALKER |
| <b>Service to Federal and State Agencies</b><br>GEORGE E. DICKIE                                         | <b>Special Publications</b><br>ROSE JAY SCHWARTZ    FRANK J. ROWE<br>MARY E. HOLMES | <b>Hospital Recreation Consultant Service</b><br>BEATRICE H. HILL                                                   |
| <b>Correspondence and Consultation Service and International Recreation Service</b><br>GEORGE A. NESBITT | <b>Work with Volunteers</b><br>MARY QUIRK    ELIZABETH SHINE<br>HAROLD WILCOX       | <b>Public Information and Education</b><br>ANNE L. NEW    BETTY BUNN<br>DAVID J. DUBOIS                             |

## DISTRICT REPRESENTATIVES

|                                                                                                                                     |                                                                                               |                                                                           |
|-------------------------------------------------------------------------------------------------------------------------------------|-----------------------------------------------------------------------------------------------|---------------------------------------------------------------------------|
| <b>New England District</b><br>WALDO R. HAINSWORTH, Northbridge, Mass.<br>RICHARD A. TAPPLY, Bristol, N. H.                         | <b>Southern District</b><br>WILLIAM M. HAY, Decatur, Ga.<br>RALPH VAN FLEET, Clearwater, Fla. | <b>Southwest District</b><br>HAROLD VAN ARSDALE, Dallas, Tex.             |
| <b>Middle Atlantic District</b><br>RICHARD S. WESTGATE, Temple, Pa.                                                                 | <b>Midwest District</b><br>ARTHUR TODD, Kansas City, Mo.<br>HAROLD W. LATHROP, Denver, Col.   | <b>Pacific Northwest District</b><br>WILLARD H. SHUMARD, Seattle, Wash.   |
| <b>Great Lakes District</b><br>C. E. BREWER, Detroit, Mich.<br>ROBERT L. HORNEY, Madison, Wis.<br>DAVID M. LANGHAMMER, Toledo, Ohio |                                                                                               | <b>Pacific Southwest District</b><br>JOHN J. COLLIER, Los Angeles, Calif. |

### Affiliate Membership

Affiliate membership in the National Recreation Association is open to all nonprofit private and public organizations whose function is wholly or primarily the provision or promotion of recreation services or which include recreation as an important part of their total program and whose cooperation in the work of the Association would, in the opinion of the Association's Board of Directors, further the ends of the national recreation movement.

### Active Associate Membership

Active associate membership in the National Recreation Association is open to all individuals who are actively engaged on a full-time or part-time employed basis or as volunteers in a nonprofit private or public recreation organization and whose cooperation in the work of the Association would, in the opinion of the Association's Board of Directors, further the ends of the national recreation movement.

### Contributors

The continuation of the work of the National Recreation Association from year to year is made possible by the splendid cooperation of several hundred volunteer sponsors throughout the country, and the generous contributions of thousands of supporters of this movement to bring health, happiness and creative living to the boys and girls and the men and women of America. If you would like to join in the support of this movement, you may send your contribution direct to the Association.

The National Recreation Association is a nationwide, nonprofit, nonpolitical and nonsectarian civic organization, established in 1906 and supported by voluntary contributions, and dedicated to the service of all recreation executives, leaders and agen-

cies, public and private, to the end that every child in America shall have a place to play in safety and that every person in America, young and old, shall have an opportunity for the best and most satisfying use of his expanding leisure time.

*For further information regarding the Association's services and membership, please write to the Executive Director, National Recreation Association, 8 West Eighth Street, New York 11, New York.*

# Recreation\*



THE MAGAZINE OF THE RECREATION MOVEMENT

*Editor in Chief, JOSEPH PRENDERGAST*  
*Editor, DOROTHY DONALDSON*  
*Editorial Assistant, AMELIA HENLY*  
*Business Manager, ALFRED H. WILSON*

ASSOCIATE EDITORS

*Recreation Administration, GEORGE BUTLER*  
*Program Activities, VIRGINIA MUSSELMAN*

Vol. L. Price 50 Cents No. 9

**On the Cover**

SKIING TIME IS COMING. Bright slopes and crisp air conspire to bring out the skiers, skaters and others who ignore the bite of the wind for rollicking sports in the snow. According to the 1956 *Recreation and Park Yearbook* (published by the NRA) sixty-eight cities in the United States reported 31,460 participants in just skiing for the year 1955. Photo courtesy Sun Valley News Bureau.

**Next Month**

National Recreation Congress pictures and the Congress Story, of course. Don't forget, too, that December carries our Annual Index. An excellent article on the techniques of teaching skiing to beginners; "Last Minute Holiday Hints" and details of a Santa Claus school. "Grass Roots Recreation," by Charles H. Odegaard, Waukesha County, Wisconsin, describes the job of recreation agent; "Recreation, Medicine and the Humanities," by Joseph B. Wolfe, M.D., is condensed from his address at the Regional Institute on Hospital Recreation.

**Photo Credits**

Page 324, (upper left) Kaufmann and Fahry Company, Chicago; (upper right) Glen B. Moody, Morgantown, North Carolina; (center left) *Saginaw News*, Saginaw, Michigan; (lower left and 325, upper left and right) *The Christian Science Monitor*, Boston; 325, (center right) Board of Education, New York City; (lower right) Recreation Department, Charleston, West Virginia.

RECREATION is published monthly except July and August by the National Recreation Association, a service organization supported by voluntary contributions, at 8 West Eighth Street, New York 11, New York, is on file in public libraries and is indexed in the *Readers' Guide*. Subscriptions \$4.00 a year. Canadian and foreign subscription rate \$4.50. Re-entered as second-class matter April 25, 1950, at the Post Office in New York, New York, under Act of March 3, 1879. Acceptance for mailing at special rate of postage provided for in Section 1103, Act of October 3, 1917, authorized May 1, 1924. Microfilms of current issues available University Microfilms, 313 N. First Street, Ann Arbor, Michigan.

*Space Representatives:* Mark Minahan, 168 North Michigan Avenue, Chicago, Illinois; Seymour A. Robbins & Associates, 101 West 55th Street, New York 19, New York; The Jules E. Thompson Company, 681 Market Street, San Francisco 5, California.

Copyright, 1957, by the

National Recreation Association, Incorporated

Printed in the U.S.A.



\* Trade mark registered in U. S. Patent Office.

**CONTENTS**

**GENERAL FEATURES**

Recreation in the Age of Enjoyment  
 (Editorial) ..... *Paul F. Douglass* 312

An Outsider Looks at Recreation .... *Harold W. Williams* 318

Know Your Adolescents (A Survey) ..... *Carol H. Weiss* 320

Explore With Books ..... 324

**ADMINISTRATION**

Regional Recreation Perspectives .... *Robert D. Carpenter* 333

Legal Notes and Court Decisions ..... 336

Notes for the Administrator ..... 335

**PROGRAM**

Stories at Christmas Time ..... *Mary Strang* 326

Christmas Arts and Crafts ..... 328

Sports Quiz Program ..... 331

A Mobile (How To Do It!) ..... *Frank A. Staples* 332

**REGULAR FEATURES**

Letters ..... 314

Things You Should Know ..... 316

Editorially Speaking ..... 317

Reporter's Notebook ..... 322

Classified Advertising ..... 337

Books and Pamphlets Received ..... 338

Index of Advertisers ..... 338

New Publications ..... 340

How To Do It! ..... See Program

Recreation Leadership Training Courses .. Inside Back Cover

# Recreation in the Age of Enjoyment

Paul F. Douglass

OUR AGE BEARS many titles. To W. H. Auden it is the age of anxiety. Howard Mumford Jones sees it as the age of violence—one dark century of increasing horror. Professor Arnold Toynbee classifies it as the age of militarism. Winston Churchill calls it the age of coexistence—or co-extinction, as you prefer. Shannon and Weaver recognize our times as the age of automation rooted in a matured theory of mathematical communication. To J. Robert Oppenheimer we live in the age of the atom. James B. Conant sees us as standing on the edge of the age of solar energy. Russell Davenport names our era as the age of fine phrases.

Our age has been variously described as the age of apathy, devoid of burning commitments which once made life a crusade; as the age of the neurotic self; as the age of distraction which gives us fidgety souls; and conversely as the age of faith with a return to the church. I propose, however, to discuss our era as the *age of enjoyment!* In the closing decades of our century our pace quickens as we advance toward the fulfillment of the ideals of life, liberty, and the pursuit of happiness, once asserted goals of the Declaration of Independence.

## Ten Professional Problems

The rapid emergence of the age of enjoyment, since the end of World War II, has brought to focus certain theoretical, professional and practical problems. Let us briefly discuss ten of these issues.

*Definition of Field.* The first relates to a clear definition of the field of recreation. We need to know what recreation includes and excludes. It is not a segment of activity attached to physical education. It is not a program for juvenile reform. It is not group work. It is not education as commonly understood. It is not an adjunct of industrial personnel to keep workers happy at their jobs. It is not bait to get men to go to church. Recreation is an independent area of life, requiring its own unique disciplines, and it should be numbered among the professions. The clear-cut definition of the field which recreation occupies in life will come about through the active professional participation of men and women working in close cooperation with the universities, especially the graduate divisions. We need thorough exploration of the meaning of recreation.

*Active Professional Awareness.* The second problem stems from the need for active professional awareness. By this

I mean working membership in professional societies. The Southern regional study, *Recreation As a Profession in the Southern Region*,\* shows that in the upper South about a half of the recreation personnel belongs to state societies, a third to the National Recreation Association, a quarter to the American Recreation Society, and a scattering in other groups. (It should be clear to all that the National Recreation Association is a lay organization, the American Recreation Society, a professional one.)

This membership indicates a far smaller participation than juke-box operators find necessary to maintain their interests. The profession needs the active membership support and society participation of every man and woman identified with recreation.

*Inspired Leadership.* Leadership too often has been inadequately trained or is functioning on minimum standards which do not utilize the full powers of a really conscientious worker. The proposal of certification is also a part of this problem, for legalizing the profession is merely setting an arbitrary minimum standard and not raising sights to those real standards written on the human heart.

*Status.* This problem is closely related to the above. It exists as a result of the necessity for recognized status of the profession. Three-fourths of the Southern communities which employ full-time recreation workers did not have, according to the Southern regional study, job descriptions in writing. We need to concern ourselves with classification, compensation and security. Side-by-side with the development of professional awareness stands the need for a continuous pressure for clear-cut personnel policies, improved salary scales and professional assurance of professional support in maintaining the integrity of work free from political interference.

*Recruitment.* Stable personnel relationships, adequate salaries and good conditions of work will, of themselves, be insufficient forces to supply the profession with adequately trained personnel. The profession has demands for personnel exceeding any visible supply. The demand to fill vacancies in the South exceeds the entire number of recreation graduates in the United States in any recent year.

The encouragement of youth to enter the profession thus becomes an urgent responsibility of the professional societies, the universities, the field agencies, the communities and the National Recreation Association, which is performing its part. The Southern study shows that the curriculums of Southern institutions are operating far below estimated student capacity. This means there are idle facilities at a time that there is urgent need of graduates.

*Recreation Education.* Recreation education is offered at over fifty colleges and universities. For the most part the

DR. DOUGLASS, noted educator, author and government consultant, is chairman of the NRA National Advisory Committee on the Recruitment, Training, and Placement of Recreation Personnel. This material is excerpted from a speech delivered at an L. H. Weir Recreation Banquet at Indiana University.

\* Available from the National Recreation Association Recreation Center, 8 West Eighth Street, New York 11. \$3.75.



programs are centered in widely distributed geographical areas in publicly supported institutions. The pattern however calls for educational statesmanship to provide standard undergraduate programs cooperating closely with graduate institutions. The problem is to see that the nation has geographically accessible programs in sufficient number to meet the needs. Likewise, it is desirable to discourage the development of recreation programs in institutions which have neither the faculty, facilities, resources or student load to justify the offering.

One of the chief concerns in the education field lies in the stimulation of faculty members to professional growth. The Southern study shows that recreation educators are giving little time to research and professional writing.

**Field Work.** Every recreation leadership curriculum should include field experience as an integral part of the total education program. No area of recreation activities provides a better opportunity for interaction of cooperating agencies and universities through the catalytic agent of the student. Field experience is important to the student, to the institution and to the operating agency. The Sub-Committee on Undergraduate Education\*\* has prepared an important report of student field experience. This sets the standards of relationship in field work and provides for an evaluation of the experience program.

Four developments can be helpful to recreation education. The first is the relationship of student *field experience* to academic education. The agencies have an obligation to make positions available to students; the institutions have the obligation to see that student field experience is academically substantial. On the graduate level, likewise, the agencies have the obligation to provide *internships*, as has been done in several instances. These positions again bring the university and the agencies into teamwork relationships. Recreation education needs more and more adequate *fellowships* at the graduate level. These can come from public and private sources.

**In-service Training.** In-service training has been given an outstanding leadership at the University of Indiana. Professor Garrett Eppley and his Sub-Committee on In-Service

\*\* Of the NRA National Advisory Committee on the Recruitment, Training and Placement of Recreation Personnel.

Training\*\* developed an outstanding document on in-service training. Under the stimulating influence of professional associations, it is to be hoped that more attention will be given to the continuing educational growth of personnel.

**Coordination of Specialization.** Already recreation leadership and administration is undergoing functional specialization. Areas, such as public community recreation, park administration, forest administration, hospital recreation, mental hospital recreation, voluntary youth servicing agencies, industrial recreation, welfare agency recreation, church recreation, recreation in penal institutions, tourism recreation, commercial recreation and private club recreation are already developing special fields of activity. Especially in hospital recreation a theoretical foundation and effective therapeutical experience are being demonstrated.

These various groups tend to have their own specialized professional associations such as the National Industrial Recreation Association, the American Institute of Park Executives and the American Camping Association. These are influential and cooperative groups. We need the teamwork of all the societies in a common front. Perhaps the specialized area of campus recreation deserves mention as a field of great potential service.

**Cooperation of Association.** Because the task of meeting the demands for recreation leadership develops upon the professional workers, the need for understanding cooperation among the perhaps dozen major professional societies in recreation and allied fields becomes imperative. The National Recreation Association offers its services as a central secretariat.

Further there needs to be a closer relationship and understanding with the commercial recreation associations and operating centers. By commercial recreation I refer to recreation services provided by private enterprise for profit. To this point there has been little noticeable use of professionally trained recreation personnel in commercial units. Likewise there has been little demand from the field for special training for recreation workers for service in commercial recreation. Nevertheless, city recreation departments are finding areas both of cooperation and competition—and often friction. More interaction with commercial recreation forces will be beneficial. ■



# A FENCING PROGRAM

For 2 or 200. Requires minimum space and simple inexpensive equipment. We design and manufacture the best and least expensive weapons and accessories for beginners and experts. Let us help you set up a fencing activity or develop the one you have. Consultations free.

## Castello

AMERICA'S OLDEST AND LARGEST IMPORTERS AND MANUFACTURERS OF  
**FENCING EQUIPMENT**  
30 EAST 10TH STREET, N.Y. 3, N.Y. • GRamercy 3-6930

Write Dept. R for  
FREE CATALOG.

## NEW AND IMPROVED RYAN'S H. & R.

### DRY LINE MARKERS

5 DIFFERENT MODELS

From 20# to 100# Capacity  
Force Feed — Instant  
Shutoff — 50 lbs. capacity.

Shaker in Hopper for  
Constant Flow.

Adjustable Control on  
Handle.

**SAVES TIME AND  
MATERIAL**

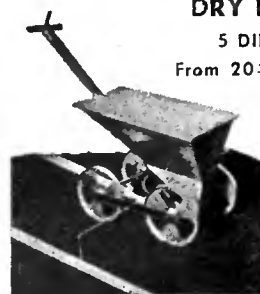

Send to Dept. R for booklet on four other models  
H. & R. MFG. CO., LOS ANGELES 34, CALIF.

for every

RECREATION  
ACTIVITY

HI-FI

sound  
at low cost

R-16CV



**NEWCOMB**

- transcription player
- public address system

For every sound reproduction application in recreation halls, gyms, auditoriums, or summer camps, the Newcomb R-16CV does the job better, yet weighs less than 22 pounds. A separate microphone and phonograph volume control permits mixing recorded music with the microphone presentation. *Variable speed control* allows variable tempo and pitch (from any basic speed setting). A quality heat and humidity resistant high fidelity ceramic pickup is encased in a professional-type tone arm. Balanced-design amplifier with inverse feedback in combination with a fine ten-inch extended range speaker give quality you'd never expect at its price. Newcomb is the "sound of quality since 1937"... recognized by leading school authorities from coast to coast.



**NEWCOMB VARIABLE SPEED**  
Exclusive Newcomb design gives dependable continuously variable control at all 3 speeds.

**FREE CATALOG**

**NEWCOMB**  
Audio Products Co., Dept. Z-11  
6824 Lexington Av., Hollywood 38, Calif.

- Send free catalog of Newcomb portable sound equipment.
- Send name of our nearest Newcomb distributor.

Name \_\_\_\_\_  
Address \_\_\_\_\_  
City \_\_\_\_\_



Readers! You are invited to send letters for this page to Editor, RECREATION, 8 West Eighth Street, New York 11—so that your ideas, opinions and attitudes may be exchanged with others on the wide range of subjects of concern to us all. Here is your chance to agree or disagree with the authors of our articles. Keep letters brief—not more than 250 words.

—The Editors.

### Indian Relationships

Dear Sirs:

I present the attached photograph in hope you will find it suitable for RECREATION. The two people in the photograph are Edwin Jacobs, representing Utah State Extension Service, and Jason Chapoose, a fourteen-year-old Ute Indian who lives on a reservation. It was taken during a recent reservation recreation leadership session conducted by Mr. Jacobs and myself.



I feel that this photograph tells a story of significance. It seems to be the ambition of the white race to educate and sway Indians to the white man's way of life. In spite of millions of dollars spent by the government and private agencies in an effort to educate these people in agriculture and technical fields, limited progress has been made. Yet this race shows a real interest in white men's recreation activities. They seem to be willing and anxious to learn about the games played by white men and to compete with and against white men in these games.

I believe that more progress has been made with the Indians in less time in the field of recreation than in any other field. People who work with this proud race are coming to realize that it is through recreation that working relationships will improve and progress will be made in other fields.

The photograph demonstrates a closer and better working relationship

between two different races than has been known in the past.

CLAYNE R. JENSEN, *Chairman, Division of Recreation, Extension Service Recreation Specialist, Utah State Agricultural College, Logan, Utah.*

### In Asian Countries

Sirs:

I have seen some issues of RECREATION and I must say that I very much appreciated the matter I read. In India and other Asian countries, recreation is becoming more organized than before and it is increasingly becoming of concern to the community. It is my hope that recreation in Asia will be so organized as to strengthen family life and community feelings and not promote the wrong type of individualism.

I am confident that RECREATION Magazine will provide me material for thinking. I am looking forward to the numbers that will come to me during the course of the coming year.

V. M. KULKARNI, *Field Consultant, International Union for Child Welfare, New Delhi, India.*

### On "Encroachment"

Sirs:

We read with keen interest and a great deal of pleasure your June 1957 issue of RECREATION. From our standpoint it is one of the finest issues we have seen. It contains a number of excellent articles that are most helpful and timely. In fact, we regard this issue so highly that I wrote to Mr. Prendergast suggesting that state park authorities would appreciate having copies made available to them.

BEN H. THOMPSON, *Chief, Division of Recreation Resource Planning, United States Department of the Interior, Washington, D. C.*

### Would Like to Hear

Sirs:

I am attempting to introduce the game of sixteen-inch slow-pitch softball

in the schools and recreation areas in and around San Diego. It is my belief if a few teams begin to see the value of such an activity for all age groups the benefits and enjoyment gained would be everlasting and sought by others, as well.

I should like to hear from as many schools and areas as possible where this game is played or has been played, in terms of why the game was introduced, its acceptance or rejection and why, the number of participants and their attitudes about the game, and any special rules used other than the official rules proposed by the Chicago Umpires Protective Association.

Any information concerning sixteen-inch slow-pitch softball you can provide would be greatly appreciated. A list of names and addresses of people interested in the game would be also most helpful.

JOHN HALVERSON, *Roosevelt Junior High School, 3366 Park Boulevard, San Diego, California.*

### BOOK MANUSCRIPTS CONSIDERED

by cooperative publisher who offers authors early publication, higher royalty, national distribution, and beautifully designed books. All subjects welcomed. Write, or send your manuscript directly.

**GREENWICH BOOK PUBLISHERS**  
Attn. Mr. Hitchcock 489 Fifth Avenue  
New York 17, N. Y.



Save Time and Money!

**Leased FREE!**

Stop wasting time recording inventory costs, handing out balls and paying top prices for low quality balls. Install this attractive, cost-cutting TFT Table Tennis Ball Meter NOW!

Leased FREE to responsible agencies on \$10.00 deposit subject to refund. Trouble-free operation assured—return machine for FREE repair. Attractive hard wood and metal cabinet—7½ x 8½ x 15 inches high. Easy to install. Holds 120 balls—dispenses each for 10¢. Choice of 3 grades of top quality balls. Use profit to maintain and replace paddles, nets, etc. No risk guarantee. Send for free folder: "Stop Wasting Their Time."

**T. F. TWARDZIK & CO.,**  
INCORPORATED  
SHENANDOAH, PENNA.

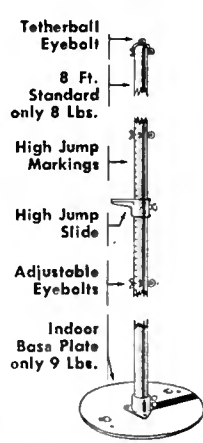

**NEW! Jayfro**  
Multi-Purpose  
**ALUMINUM STANDARD**  
*Use it 12 Ways!*

- Interchangeable  
Indoors and Outdoors for
- VOLLEY BALL • BADMINTON
  - TENNIS • PADDLE TENNIS
  - HIGH JUMP • TETHERBALL
- ✓ Official specifications
  - ✓ Lightweight
  - ✓ Easy to install and move
  - ✓ No maintenance
  - ✓ Six different models



*Jayfro*  
**BASKETBALL STEEL CHAIN NETS**

3 Years Guarantee!  
outdoors or indoors

Also Featuring Jayfro's Custom Built New and Improved!

- ✓ PADDLE TETHERBALL SETS
  - ✓ TETHERBALL POLES
- Revolutionary and Exciting New!
- ✓ SHUFFLEBOARD SETS with "RUBBER CUSHIONED" DISCS
  - ✓ OFFICIAL 100% NYLON Basketball Nets and Nylon Ball Carriers
- Send for Free Catalog •  
**JAYFRO ATHLETIC SUPPLY CO.**  
Dept. RC, Box 1065, NEW LONDON, CONN.



Superior Design,  
Construction and  
**PERFORMANCE**

far greater  
strength and  
**SAFETY!**

**AMERICAN**  
*Approved*

**PLAYGROUND AND SWIMMING POOL EQUIPMENT**

The wise choice of experienced buyers for nearly half a century.

WRITE FOR LITERATURE



**Checkurette**

### HAT and COAT RACKS

These multi-purpose wardrobe racks go wherever needed, or store away like folding chairs when not in use. They come in 3 ft. or 4 ft. lengths, have two hat shelves and 1 or 2 full length, hanger bars for coat hangers or coat hooks. (Two-sided hooks snap over and straddle the bar, see detail below). Standard units come on glides; stand rigidly under a full load. Special caster bases are available for wheeling racks about—loaded or empty. Write for Catalog CT-515.

**VOGEL-PETERSON CO.**  
1127 West 37th Street • Chicago 9, Illinois

**x-acto**  
*Colonial Antique Kits*

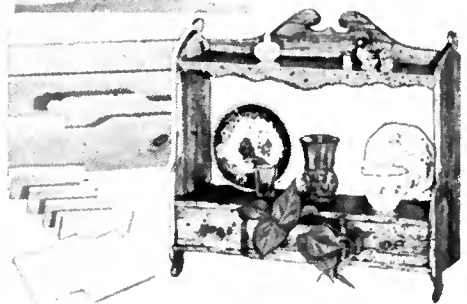

Complete "assemble-it-yourself" kits for making full size reproductions of Colonial Antique Masterpieces!

Everything included... precise pre-cut wood sections with pre-marked nail holes, knife for antiquing, rub-on stain, nails, sandpaper, steel wool, gauze wipe, and simple directions. 6 kits from \$2.95 to \$8.95.



**FREE!** Full color Brochure of all six X-acto Colonials.

**X-ACTO, INC.**  
48-99 Van Dom Street  
Long Island City 1, N. Y.

●  
●  
●  
●  
●

## Things You Should Know . .

●  
●  
●

▶ A TRAVEL STUDY of tourists visiting Great Smoky Mountains National Park in 1956, has recently been published in a beautiful folder. The survey was a cooperative venture conducted by the North Carolina State Highway and Public Works Commission, the Tennessee State Department of Highways and Public Works, and the United States Bureau of Public Roads. Among interesting facts turned up, it was discovered that more people come to this park each year than visit Yellowstone, Yosemite, Glacier, Grand Canyon or any other of the national parks.

Maintaining services, year after year in proportion to the need, and handling the problems of such traffic, are not things that can be left to blind chance. Therefore, this study was planned to provide the sort of information upon which sound planning can be based. Methods employed in making the study are explained. Further information, or a free copy of the study, may be obtained from the State Advertising Division, Raleigh, North Carolina. Please mention that you read about this in RECREATION.

▶ NEW MAGAZINE! As of January 1, 1958, the National Industrial Recreation Association will have a magazine of its own; but its name has not as yet been announced. We welcome it to the field of recreation publications. This, by the way, will be separate and apart from the national *Industrial Sports and Recreation* magazine.

▶ THE NEW HIGH SCHOOL PHOTO CONTEST has just been announced by Eastman Kodak. Sweeping changes have been made, presenting contestants with increased opportunities for recognition. They will, for instance, compete only against other students in the same grade, for state merit certificates; then national award winners will be chosen from among certificate holders. Cash prizes, of \$10,400, are double this year. More than 550 high school students were recognized last year, with 256 cash awards. Grand award winners received \$300 each.

A selection of last year's prize pictures formed a traveling exhibit, available to schools without charge, and a selection of the new prize winners will be treated in similar fashion. For further information write Kodak High School Photo Contest, 343 State Street, Rochester 4, New York.

▶ BEFORE A COMMUNITY PLANS A PROGRAM of almost any type for its aged citizens, it is generally advisable that a comprehensive and detailed "self evaluation" of local resources be made, according to a Survey of Chronic Illness Needs and Services made in St. Louis and reported in the July 1957 issue of the bulletin, *Adding Life to Years*, published by the Institute of Gerontology, State University of Iowa. Careful investigation should reveal not only those facilities which are available, but also the degree to which they are currently meeting the needs of the community's aged persons.

▶ JUNIOR PLAYERS ARE BEING RECOGNIZED for the first time next season, when the United States Table Tennis Association sends a junior team to the International Table Tennis Matches in London, England, March 25 to 29, 1958. Adult contestants have been sent to world meets for years, many of them entered by recreation directors. The National Junior Team Championships will be played in Chicago on January 11 and 12, 1958.

▶ A NATIONWIDE CONTEST to select the "Outboard Boating Club of the Year" has been announced by the Outboard Boating Club of America, national association of boating enthusiasts and manufacturers and sellers of marine equipment. Choice of the outstanding club, based on the group's activities from May 1 to October 31, will be made by a panel of editors of some of the nation's best known boating magazines. First prize in the competition is an all-expense-paid trip for two to the 1958 Chicago National Boat Show, including round trip by air, a three-day stay at the Congress Hotel, appearance as

guests of honor at ceremonies opening the boat show and other festivities. In addition, the winning club will be awarded a \$500 cash prize. Cash awards of \$300 and \$200 will be made to the second and third place clubs.

Final selection of the "Outboard Boating Club of the Year" will be announced prior to the opening of the ten-day Chicago National Boat Show on February 7th. Further information may be obtained from Outboard Boating Club of America, 307 North Michigan Avenue, Chicago 1, Illinois.

▶ KAB IN ACTION: Litter bags are being passed out to motorists in many states, as a part of the Keep America Beautiful Campaign. In New Hampshire, the Automobile Dealers Association urges everyone, "Don't Be a Litter Bug, Use a Litter Bag." At the Long Beach Congress, "Parky Kits" containing two litter bags which could be hung on your car doors, were made up especially for the Long Beach Recreation Department to give out to delegates. We used them when driving to San Francisco, and they were very handy.

Some car manufacturers are also beginning to join this nationwide crusade to end the litter habit. Publicity in the *Los Angeles Times* on Sunday, June 16, 1957, centered around the new litter bag for Chevrolets. The campaign in Southern California is also receiving assistance from the Service Station Association, representing two thousand dealers. General Motors is now a subscribing member of Keep America Beautiful, the national organization created by American business and industry.

▶ IN SPEAKING ON PHYSICAL FITNESS before the Senate last spring, the Honorable Richard L. Neuberger of Oregon called attention to an article, "Does Sports Equal Fitness?" by Mortimer H. Morris, assistant professor of recreation at Oregon State College, published in the *New Republic*, April 29, 1957. He recommended that it be printed in the *Congressional Record*. Mr. Morris speaks of our high-pressure sports promotion in America, and points out that it has not resulted in an athletically superior country and that, disturbingly enough, a fitness survey team led by Dr. Hans Kraus disclosed European children to be stronger. "Why," he asks, "are our sports programs failing to produce a physically fit America?" And he answers his own question, "Because by its very nature a highly competitive sports program is selective in its choice of participants. For every boy or girl who makes the team, there are thirty or forty who do not. . . ." ■

# Editorially Speaking

## THANKSGIVING PRAYER

OUR HEAVENLY FATHER, we thank Thee for the gift of responsibility. Give us this day our daily bread of courage and wisdom, and forgive us our debts of past failures as we forgive those who have failed us. And lead us not into the temptation of indifference to the great issues and needs of our time. But deliver us from the evils of doubt and fear and suspicion and all pettiness. Grant that out of the wide fellowships and noble companionships of our day may come a deep purpose to go forward as we have never gone forward before. Give us the strength to translate our dreams into the concrete things that must be done day by day to realize those dreams. And may the inspiration of great men and women of all ages be and ever abide with us.

—From *Senior Citizen*, November 1955.

### Do Our Children Read?

Some remarks made by Governor Frank G. Clement of Tennessee in the July issue of *The Tennessee Conservationist* are right in line with the "Explore with Books" theme of Children's Book Week, November 17 to 24 (see page 324.)

"We have heard much recently to the effect that Johnny can't read," writes the governor. "Most critics place the blame in the laps of our public school teachers. . . . But the blame, in my opinion, must be shouldered by the parents, who should teach him. . . ."

"It can be done only through introducing the child, at the earliest age possible, to the vast world of good books that eagerly await his exploration. . . ."

" . . . As with everything else, learning to read and enjoying this pastime can only be accomplished by reading. To encourage the child to read, he must be offered the best books available in order to hold his interest.

"Book stores are filled with such books; school and public libraries are stacked high with them. Most of the larger cities now have bookmobiles which bring the best in reading material practically to your front door. Too many of these books, I regret to report, are gathering dust instead of the fingerprints of the young.

"Won't you please see that your child makes use of these many facilities?"

Do not recreation leaders also have an opportunity and a responsibility in this direction?

### Jobs for Volunteers

Those who have problems in successfully using and keeping volunteers will be interested in points brought out at a workshop, "New Horizons for Volunteers," recently held at the National Social Welfare Assembly. Among them:

The needs of volunteers (and we are interested in them as persons and constituents of our recreation centers) are the same for both volunteer and professional leaders. They are the need for—

1. *A feeling of accomplishment and satisfaction.* Give volunteers more work and responsibility, and promote them to committee and board membership. Former staff who volunteer services make able volunteers.

2. *A feeling of being wanted.* Small courtesies give a feeling of welcome. Interesting jobs or, in the case of menial tasks, explanation of usefulness to program can elicit responsible work.

3. *A feeling of security.* Security can be strengthened by training and support of the professional staff.

4. *A feeling of recognition.* Recognition can be given by awards, personal letters of recognition, reports to board, and by consideration as an individual.

Mrs. Henry M. Dodge, who is chairman of the National Social Welfare Assembly-United Community Funds and Councils' Advisory Committee on Citizenship Participation, said that confusion exists among both volunteers and professionals regarding their respective job responsibilities. Some jobs are

clearly accepted as responsibilities of the professional; others of the volunteer. There is a middle ground in which there are no accepted rules, however, which results in confusion. She urged professionals to be more imaginative and creative in thinking of jobs for volunteers. "Try something new," she said, "because every volunteer is useful if there is careful interviewing, thoughtful placement, and consideration and understanding of individual capabilities."

Examples of ways in which imagination can be used creatively in jobs for volunteers are: Involve them in organizing new program in suburban areas; ask volunteers to assist professionals in office management, as case aides, as friendly visitors to senior citizens; assign skilled volunteers to interesting tasks such as volunteer director of volunteer group.

Mrs. Dodge urged consideration of aptitudes in assigning volunteers. "Short-term artists" can do terrific two- to three-weeks- or month-long jobs, such as plans for annual meetings. Long-term planners do a better job on a task such as organizing a volunteer program. Think of new ways to use groups that want to volunteer as a group. Take them in "teams." They can staff hospital desks and similar jobs on rotation basis.

Stop worrying about "motivation," she said. "Remember instead the four basic needs and keep them in mind when planning a volunteer program. The volunteer shares the professional's desire to make the world better because she lives in it, and all volunteers want to make a contribution as useful citizens."

### Automation

If only a fraction of what technologists promise for the future is true, within a very few years automation can, and should, make possible a four-day work-week, longer vacation periods, opportunities for earlier retirement as well as a vast increase in our material standards of living. . . .

We must do all in our power to make sure that the potential abundance of the new technology will be used with social wisdom to improve standards of living and welfare, and to provide increased leisure, for all Americans.

If we accept the challenge of the new technology, if we use foresight and act wisely and vigorously, we can help to usher in an age of abundance and freedom, the like of which the world has never known—WALTER P. REUTHER, in *Here We Are*, UAW publication, May, 1957. ■

# An Outsider Looks at *Recreation*

*This frank article on important aspects of our non-work time will stimulate your thinking and prove an excellent discussion piece. Let us know your reaction to it. . . .*

**Harold W. Williams**

**T**WENTY-FIVE hundred years ago, the Greeks had a word for *leisure*. It was *schole*. It is the root of our own word for *school*; that is, a place and a time for learning. Today, our schools are places of learning, but I am afraid that we have forgotten that our leisure, in addition to being a time for sheer fun, ought to be more of a time for learning than it now is. What is even more regrettable, I fear that many of our recreation leaders are not so concerned about this end of the matter as they should be.

The ancient Greeks had a definition for happiness which went as follows: "The exercise of vital powers along lines of excellence in a life affording them scope." It would be nice if we all had an opportunity to exercise our "vital powers" along lines of excellence in jobs that give us ample scope to do so, and some of us are fortunate enough to be in that position. But I needn't tell members of the recreation profession that many people simply do not have jobs of that type and that even those who have are working only a small part of the time.

Perhaps there was a time in our civilization when our work was so consuming of our energies that we needed to do little else in our free time except to rest or to play. Certainly no one should quarrel with the idea that leisure is at least partly a time to relax. We all like to stretch out on a hammock on a summer afternoon and idly watch the insects; or to watch a good program on television; to see a ball game; to play an idle parlor game; to go to a movie.

But leisure, as the derivation from the Greek root for school suggests, is also a time to learn—a time to cultivate and use vital powers. If the leaders of our recreation movement are really concerned about leisure time, then I suggest that they need to be much more concerned as a group than they now are about learning and perhaps a little less preoccupied with "play for play's sake." Otherwise, we might appropriately continue to call recreation the "play movement" (which it once was), and turn to other leadership to help us develop the other important aspects of our non-

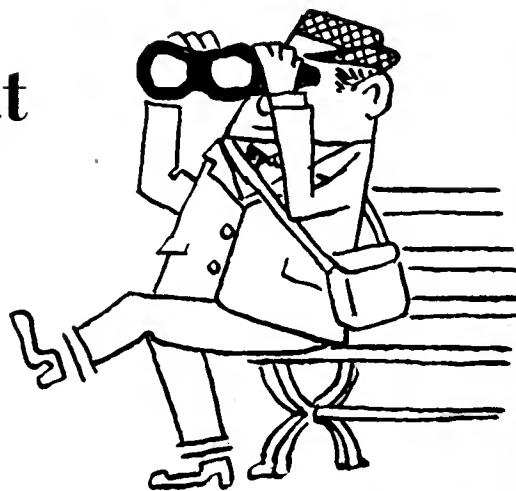

work time in this present complex age.

Do we not have a right to expect that our recreation leaders will help us seek happiness in our leisure time along the lines of that ancient Greek definition? Should there not be an appraisal of our recreation programs to see if they do in fact offer us the opportunity to exercise our vital powers? Should not recreation programs stimulate us to strive for excellence when we do exercise those powers? Should they not broaden every avenue along which we might employ the vital life forces within us?

Do they? To many people, recreation leaders seem overpreoccupied with the frivolous, the trivial, the time-killing game and the artificial ice-breaker. If the recreation movement is to attain the stature it seeks, it needs nobler ideals and more purposeful functions.

Please do not think that it is my purpose in any way to disparage the philosophy and fine idealism of the founders of the recreation movement in America. Their great contributions to human happiness need no defense from me nor are their reputations likely to suffer from anything I might write. But what they preached and taught must be viewed in the light of what they knew about their world at the time in which they lived. It was a very different world from the one we know today, a world which often looked upon play as sinful, a world in which the masses were devoting all their time to the struggle to climb out of the slums and tenements and into a world of light and air. The doctrine that people had a right to enjoy life, to play, to have fun, was a radical doctrine in those days, and we rightly pay homage to the men and women who had the daring and the nobility to preach it.

But ours is a very different world. We have material possessions to an extent undreamed of just a few years ago. We have ever-extensive leisure. More and more of our people are educated. We have moved in large numbers from crowded cities to suburban developments. There are more of us—more older people, more younger people. There are more in the middle class. The automobile has made us more mobile. Labor-saving devices create even more leisure for women and children, as well as men. Our very abundance of material comforts means that, relatively speaking, we get less enjoyment from them because they come so easily.

---

MR. WILLIAMS is associate director of the Office of Community Services, Department of the Air Force, Washington, D.C.

These facts call for new appraisals of the purpose and worth of recreation, not just a recital of creeds and principles enunciated years ago to fit an entirely different set of facts.

Perhaps the time has come for recreation leaders to make up their minds. Are they interested only in organized play or is their goal more fruitful leisure-time experience? There is a large place for play in the latter, but there is also an important place for learning.

The life spirit which makes man what he is has its roots in four quests: the search for truth; the attempt to create, discover and enjoy beauty; the pursuit of goodness; and the seeking of fellowship with other men. As we strive toward these goals, we become men more and animals less. When we neglect them we lose our humanity and our civilization begins to merge with the so-called lower forms of life.

In our struggle for material comfort, most of us have to turn aside from these quests for forty hours a week. We justify ourselves in the knowledge that, after sleeping for fifty-six hours, there are seventy-two hours left to us to refresh and enrich our lives and our civilization. We buy material comforts and leisure time with our work, so that we may have ample scope to live our lives when we are not working.

But we, the people, need help. We need leaders who understand and share these ideals. We need allies. They ought to be in the recreation movement. At the very least, our recreation leaders shouldn't put obstacles in our path. We shouldn't expect to be turned away from the noble to the frivolous, from the important to the trivial.

Perhaps it will be clearer if we list the vital powers of man. They fall into three general categories. First, there is the power of the mind, the power to think, to reason and to learn; then there is the power to create and appreciate beauty; and, finally, there is physical power, the power to run and jump and throw and lift. Each of these powers can be turned to the study and search for truth, beauty, goodness and fellowship; indeed, each must be turned to these ends if we are to find real happiness.

How often have we seen recreation leaders subvert these basic powers in meaningless games or idle hobbies? As a nation, we look more and more to adult educators, librarians and ministers to challenge our intellectual powers. The specialized teacher in music, art or writing inspires our creative powers. Physical educators lead the way to glorifying our physical powers. When it comes to recreation, all too often we get game leaders.

Outmoded ideals add up to one reason why this state of affairs exists. Too much emphasis on training activity leaders and not enough on training philosophers might well be another reason. I would suspect, too, that preoccupation with *organized* recreation would be another.

As a profession, recreation has struggled up from the playgrounds, and on the way it has fought educators, park executives and city councils for status—and rightly so. But, in the process, it has had to lay great emphasis on the importance of *organized* activities; so much so that it has sold itself a bill of goods to the effect that organization is the *sine qua non* of recreation. This just isn't so. There's much

more to recreation than that. As individuals, all of us know that a great deal of our leisure time must, and should be, unorganized.

Our family plays together often, and we like it. We could do with a few more ideas and a few more facilities; and we would like to be able to turn to our recreation professional for help. But, when we do, we find that he is much too busy organizing groups to give us any advice and stimulation.

What all this adds up to is that many recreation leaders are missing the boat. As a nation, we desperately need leadership in helping us to use our leisure time to achieve true happiness. That leadership ought to come from the recreation movement, but it is being held back by an outmoded tradition that recreation consists largely of organized play activities.

As a starter for correcting this state of affairs, I would suggest two things, one in the realm of theory and the other in the realm of practice. I'd like to see some of our recreation practitioners get together on a realistic and up-to-date statement on the aims of the recreation movement. I would hope to see in such a statement a real appreciation of how the recreation movement should help us take advantage of our non-work time in order to promote "the exercise of vital powers along lines of excellence in a life affording . . . scope."

It should contain some explanation of the recreation worker in terms of a teacher of leisure-time skills and a stimulator of leisure-time interests. I'd like to see the recreation movement become the spokesman and guardian of our free-time opportunities as represented by land and water and by the conditions of life in the communities in which we live. Any such statement of principles ought to set out recreation's stake in developing the highest level of free-time activities, unorganized as well as organized.

On the practical side, I would hope to see a recreation department hire a free-time counselor or coordinator, whose only duties would be to ride herd on the whole range of community leisure-time activities with a goal that envisions a gradual increase and uplifting in the quality and quantity of free-time programs. My free-time counselor would be an idea man, a *hair-shirt*, a philosopher, preacher, a practical adviser, a man of wide interests—in short, the kind of person who could get the community excited about free-time opportunities and then steer individuals and organizations to the proper places for help. He would be interested in everything—sports, dining out, automobile travel, do-it-yourself, gardening, music, art, libraries, discussion groups, nature, camping, picnicking, backyard fun—everything that would go to make our way of life a good one.

In fact, if the people in my community (where we have only a summer playground program) were to ask me how to establish a real recreation program, I'd tell them to start with a free-time counselor like the one I've just described. Perhaps he'd be influential enough to raise the quality of our life, maybe only a little bit at first and then more, until finally a visitor from another continent (or another planet) might come to our community and observe the way we live and conduct ourselves in our free time and comment: "What a fine civilization these people have." ■

## *The new Girl Scout survey turns a candid camera on the teen-aged girl—her needs, her interests and her dreams.*

**I** DON'T KNOW what's the matter with my girls," a leader of a troop of 13- and 14-year-old Girl Scouts remarked. "We've been together for three years now, and they've always been whizzes at all kinds of crafts and skills and sports. Now they've turned into a bunch of oddballs—cliquing off in twos and threes, giggling every time a boy appears, and wasting the meeting time with chatter and complaints about why we don't have parties and dances every Tuesday and Friday and twice on Saturday. I'm afraid the troop is coming apart at the seams. Even when I suggest activities that have been favorites for years—like camping—they look at me as I'd just crawled out of a prehistoric mound."

This woman has been a topnotch leader; but she's being outflanked by the onset of adolescence. The survey of adolescent girls, conducted for the Girl Scouts by the University of Michigan Survey Research Center, reveals that around the age of thirteen or fourteen, girls start shifting gears in the drive toward adulthood. Up until then, they are concerned primarily with mastering the physical world. Their interests are centered in the present or immediate future. They are close to their families, and their friendships are relatively shallow, easygoing play relationships.

But about the time girls enter high school, their focus shifts to things social. The most striking change is the appearance on the horizon of a new figure—or rather an old familiar figure in shiny new raiment. The boy becomes a consideration to be reckoned with. Endlessly. At 14 most girls start dating. They are vitally concerned about being popular. When asked what things girls worry about, only a quarter of those under 14 mentioned popularity with boys. Among 14- to 16-year-olds, 45% list this as a worry.

Their relation to their girl friends becomes more intense and emotional. Involved in the search for an identity independent of the family, they want a close friend who will above all be loyal and trustworthy. They need someone in whom they can confide and who will share their new and complex problems. These duos can create problems for a leader who is unaware of their special significance for girls at this age.

As our harried leader found, too, social activities such as parties and dances shove old favorites aside and move to stage center. The researchers asked girls what things a club should do if someone were to start a new girls' club. Thirty per cent of the 12-year-olds suggested outdoor activi-

Surveys and analyses that the National Recreation Association is making constantly at the request of localities which want to improve their recreation services, reveal rather uniformly the lack of recreation programs or opportunities for participation by girls from eleven to sixteen. The study made by the Girl Scouts of America points up the same need for more attention to be given this group. The combined evidence, therefore, clearly indicates that this is an important service market for the local public recreation department.—CHARLES E. REED, *Director, NRA Field Services.*

ties such as hikes, but only half as many 14- to 16-year-olds were interested. Fifty-five per cent of the 12-year-olds suggested social activities; this figure rose to 83% among the 14- to 16-year-old group.

Boys are different; but it complicates life for teen-agers. Boys don't start dating as early as girls. They keep up their interest in sports and games and skill activities long after girls have shifted to the social arena. When asked to suggest activities for a club, fewer than half as many boys aged 14 to 16 mention social activities as do girls of that age (33% compared to 83%).

Not that girls drop all their old interests when they pick up a lipstick. At the 14-to-16 age level, the percentage of girls who participate in sports, outdoor activities, hobbies, and creative activities is still high. The percentages interested in various activities are shown in the sketches at the bottom of these pages.

Nearly all girls want to get married. Ninety-two per cent of them are sure they do, 4 per cent say "maybe" or "don't know," and 4 per cent are against the idea. The nay-sayers are largely younger girls who haven't yet ventured forth on their first date.

Unlike their foremothers in the early part of the century, girls today see no incompatibility between marriage and a

Leisure activities of 14- to 16-year-olds—percentage of girls participating.

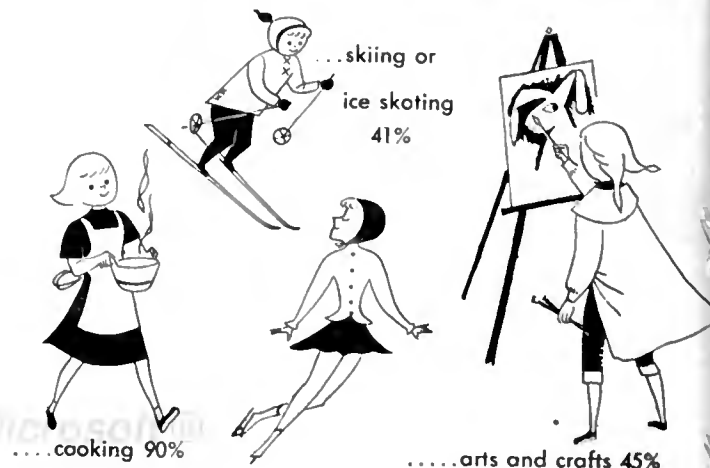

MRS. WEISS is a research analyst in the research and statistical division, Girl Scouts of America. Condensed and reprinted with permission from Girl Scout Leader, May 1957.



career. Almost all of them expect to hold a job, too. And in adolescence they are more concerned about choosing an occupation than about getting married. Favorite job choices are secretary, nurse, and teacher. These are the traditional jobs for women that are publicized and glamorized in the mass media. They offer opportunities to be of service and to have a certain professional or subprofessional status.

Girls say overwhelmingly that in selecting an occupation they are not interested in being their own bosses, in being leaders of other people, or even particularly in high pay. What they are looking for is interesting work, nice people to work with (each of these is regarded as an important consideration by over half of all girls), steady work, and the opportunity to help others. Four out of every five girls between the ages of 11 and 18 are already doing some kind of paid work.

About half of all girls, too, receive a weekly allowance from their parents. More of the under-14's get an allowance than do older girls, who presumably are earning enough to keep themselves in pocket money. But when the older girls do get money, they rake in sizable amounts. The most frequent amount of allowance for girls under 14 is between one and two dollars a week. For 14- to 16-year-olds the average is between two and three dollars a week. Of the girls over 16 who get allowances, nearly a third are in the five-dollars-or-over bracket.

Girls' responsibility for making their own purchases is one indication of the freedom that their parents allow them. There is considerable evidence throughout the study that the home atmosphere for today's youngsters is permissive and cooperative. Girls get along well with their parents and share activities with them. Although most girls wish their parents were less strict, they accept the need for parental discipline and generally agree with the specific rules their parents make for them. Half of all girls have some part in making the rules at home.

While adolescent girls are tremendously concerned about themselves—their appearance, their personality, their future—they also have a strong desire to be of service to others. The urge to help people is one of the main considerations in their choice of a future job. And when asked what things make them feel important, about half of them mention help-

ing others. But this is not the tray-favor kind of service. Increasingly, as they grow older, they want their role to be on an adult level. They like to assume grown-up responsibilities in their after-school jobs, at home, and also at school.

Scouting obviously has a great deal to offer girls at this age. But from the age of 14 up, only one girl in 35 is a Girl Scout. Over one-fourth of all girls used to be members (Girl Scouts is the organization most widely joined by younger girls) but have dropped out of scouting since the age of 10.

The reason for giving up scouting is not that girls are less interested in clubs as they grow older. On the contrary, from the age of 11 to 16 there is a steady rise in the number of girls belonging to some kind of club. Girls belong to school activity clubs (54%), church groups (52%), national organizations such as Y's, 4-H, Girl Scouts (45%), and social groups (9%). Most of the national organizations, except for the Y's (YWCA, YWHA, Hi-Y, and so on) and Future Homemakers, have a pattern similar to ours in drop-outs among older girls, but school activity clubs and church groups increase in popularity at upper age levels.

Three out of four girls belong to some organization (28% to one group, 22% to two groups, 12% to three groups, 13% to four or more). But what of the girls who haven't joined at all? The survey reveals that they are more likely to come from the poorer homes where the father and particularly the mother have had less than a high school education. Non-members from every background display less self-confidence, less verbal skill, less maturity in their plans for the future, in their relation to adults, in their social skills and personal resources.

The reasons for not joining a club, at least up through the age of 16, don't appear to have much to do with how much free time a girl has. Members hold jobs outside the home more often than non-members, they more often date, and they participate in more leisure activities.

It seems that the very girls who have fewest outlets and are least mature, the girls who could benefit most from constructive club activities, are the ones who do not join. How do we go about reaching them? Have we unwittingly set up any obstacles that discourage older girls from joining or re-joining anything? ■

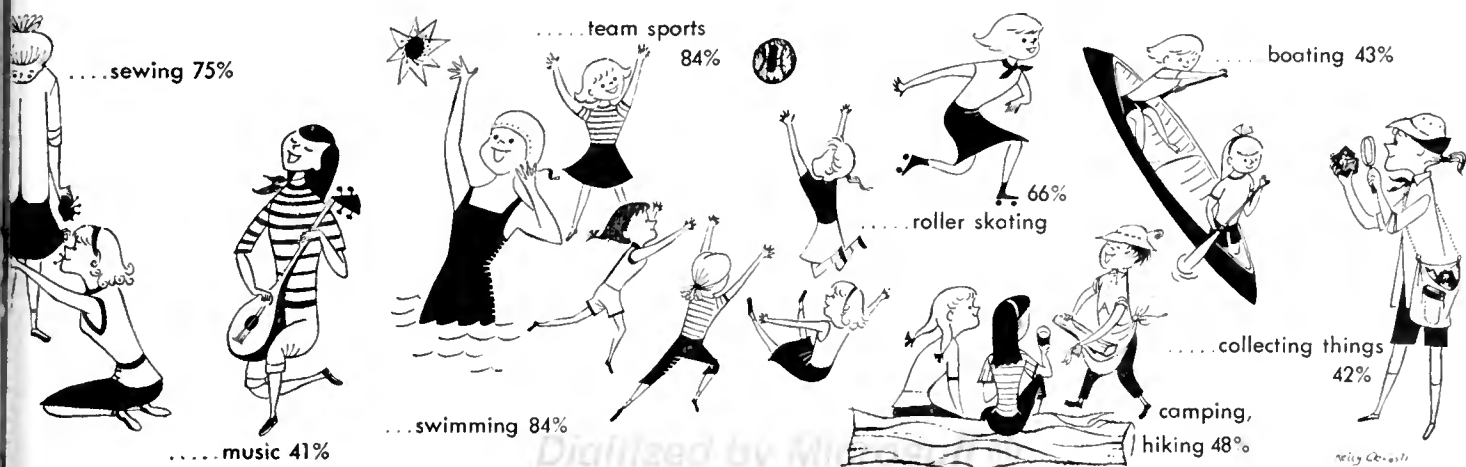

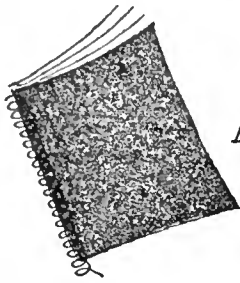

## A REPORTER'S NOTEBOOK

### People in the News

- DR. WILLIAM C. MENNINGER, general secretary of Menninger Foundation, Topeka, Kansas, and member of the NRA Board of Directors, has been chosen as one of nine "Great Living Americans" by the U. S. Chamber of Commerce for his achievement in the advance of mental health.
- FRANK M. SABINO, superintendent of recreation in Leonia, New Jersey, was presented with a certificate of appreciation in recognition of the "invaluable services rendered the youth of Leonia" by the local Lions Club.
- DENNIS MCCARTHY, former director of parks and recreation for Maricopa County, Arizona, has assumed the directorship of the newly established Arizona State Parks Department. He is also president of the Arizona Recreation Association and a member of the NRA Pacific Southwest District Advisory Committee.
- JOEL C. HOLIBER has been appointed as executive director of the Metropolitan New York Council, American Youth Hostels. He had formerly been associated with Boy Scouts of America and the New York University camping and outdoor education program.
- DOROTHY BOYCE, supervisor of recreation for Chicago public schools, has received the "Leader in Volleyball" national recognition from the United States Volleyball Association.

### New Officers

Officers of the American Recreation Society for 1957-58 are: Dorothy Taaffe, San Francisco, president; Charles B. Cranford, Philadelphia, president-elect; Sidney G. Lutzin, Albany, New

York, first vice-president; Kathryn E. Krieg, Des Moines Iowa, second vice-president; Oka T. Hester, Greensboro, North Carolina, secretary; and R. Foster Blaisdell, Topeka, Kansas, treasurer.

Geographic representatives: *New England*—John B. Penney, Concord, New Hampshire; *Middle Atlantic*—Frank E. Evans, Englewood, New Jersey; *Central States*—Malcolm J. Elliott, Saginaw, Michigan; *Southeastern*—Mae Crandall, Mooresville, North Carolina; *Midwestern*—J. Nevin Nichols, Cedar Rapids, Iowa; *Southwestern*—Lillian Schwertz, Dallas, Texas; *Western*—Kenneth M. Kurtz, Casper, Wyoming; *Pacific*—Jack Hoxsey, Pomona, California.

Members-at-large: Pat Abernethy, Washington, D. C.; Edith Ball, New York; William Frederickson, Jr., Los Angeles; Ray R. Butler, Shorewood, Wisconsin; and Fred M. Chapman, Minneapolis.

---

Dream, books, are each a world; and  
books, we know,  
Are a substantial world, both pure and  
good.  
Round these, with tendrils strong as  
flesh and blood,  
Our pastime and our happiness will  
grow.

—WILLIAM WORDSWORTH  
*Personal Talk, Sonnet III.*

---

### Children's Book Fair

The World Affairs Center, New York City, in cooperation with the children's Book Council, is holding a children's book fair during National Book Week, November 16 to 24.

The fair will exhibit a thousand children's books about other countries, foreign-born groups in the USA, and

also books about the United Nations and related organizations. The entire ground floor of the World Affairs Center will be given over to this unique children's book fair. Film programs and talks by authors and illustrators will be given in the auditorium. The World Affairs Center is a non-profit organization serving as a clearing house and meeting place for all organizations and individuals interested in world affairs.

### Achievement Awards

*Parents Magazine* third annual Youth Group Achievement Awards for community service in 1956-57 went to 121 young people's organizations. Among the winners was the Junior Board of Directors of the Yavapai County Youth Center, Prescott, Arizona. After volunteering to operate the community swimming pool during the summer of 1956, sixty-three youngsters organized formally to provide a clubhouse for teens and have collected \$2,000 through the sale of youth bonds.

Other winners are a youth organization in Georgia, which has set up the first Scout troop in the world for blind children; a group of ten-year-olds in Brooklyn, New York, who have "adopted" as grandparents twenty-two lonely inmates of a home for the aged; ten victims of cerebral palsy in California, who make tray favors for a children's ward; and a church club which reseeded the Malibu, California, mountain fire area.

### First County Park Re-Studied

The NRA has just completed a re-study of a portion of Branch Brook Park, Essex County, New Jersey, which was the first county park in the United States. It was designed by Olmsted Brothers, Brookline, Massachusetts, in 1899. Union County, New Jersey, and Westchester County, New York, have followed with the development of outstanding county park systems.

The present Essex County study was made necessary by the abandoning of the park reservoir as a reservoir. The concept of parks has changed during the years to include spaces for recreation; and the purpose of this study is to make area useable for the enjoyment of active recreation.

## Nautical Elbow Room

With the phenomenal development of pleasure boating has come an anguished cry for more mooring, berthing and anchorage facilities. Pleasure boat skippers look particularly for the protection and accessibility of a berth along a finger pier easy to reach by car.\* They also want fresh-water hose connections and a 110-volt electric current to "spell off" batteries.

New Jersey has embarked on an ambitious program of developing new marine playgrounds by dredging mud flats and creating new rivers, creeks, bays and coves. The latest waterway to be tackled by the state division of conservation and economic development is the Shrewsbury River area which affords boating facilities not only for residents of New Jersey and New York but for soldiers stationed at Fort Monmouth and Sea Scout units of the Boy Scouts, who combine overnight camping with their seagoing.

The \$1,500,000 public marina, dedicated in September at Clam Creek, Atlantic City, will be, when completed in 1960, the largest, most modern and complete facility of its type on the 120-mile New Jersey coast. Financed and constructed jointly by the state and Atlantic City—site of next year's National Recreation Congress—the marina is designed to accommodate visiting craft en route between New England, New York, other Jersey harbors and southern waters.

In addition to an ultra-modern administration building which will not be fully occupied until next spring, the yacht basin will eventually boast 370 slips designed to accommodate boats ranging in length from 30 to 175 feet.

Other facilities being built are electrical and television outlets for each berth, as well as water, ice and fuel depots where skippers can replenish their supplies. When additional funds are appropriated by the city and the state, a 1,200-automobile parking lot and a heliport will be added.

Boat occupants and crews may be paged twenty-four hours a day through amplifiers located on the individual

piers. Taxis and rental cars are also available near the administration building. The sheltered harbor is accessible during all weather, the whole year round.

The state operates three other marinas which are located at Forked River, Leonardo and Point Pleasant.

## Junior Museums



The Junior Museum in Greensboro, North Carolina, is a cooperative community affair, started a year ago by the parks and recreation commission, recreation department and other agencies. Here museum director Walter Martinetti holds a workshop session for the volunteer personnel.

The growing number of junior museums across the nation is providing an absorbing outlet for nature activities with particular emphasis on "education through recreation" and on live and outdoor exhibits and programs. A five-year project by the National Foundation for Junior Museums is providing California with ten new junior museums. Eight are already in operation (Kingsburg, Stockton, Carmichael, Sacramento, San Jose, San Mateo, San Rafael and Fresno); the Diablo Junior Museum in Walnut Creek will be open on a daily basis by the end of 1957; and the tenth project, the Happy Isles Nature Center in Yosemite National Park, is under way.

A new two-year project by the foundation is providing junior museums for Morristown, New Jersey, Greensboro, North Carolina, Savannah, Georgia, and Corpus Christi, Texas.

The junior museum movement is also receiving much attention in India where the government is planning a children's museum in Delhi. India's first junior museum opened in Amreli in 1955.

## Bridge, Anyone?

Planning a bridge tournament in your program? The booklet *Let's Play Cards* will tell you how to organize and conduct it. It's available (without charge to recreation leaders who write for it on their official letterhead) from the

Association of American Playing Card Manufacturers, 420 Lexington Avenue, New York 17, New York. And from the same source can be obtained a delightful little booklet, excellent for beginners, *How to Start Playing Bridge in 22 Minutes*, priced at only ten cents. Mention RECREATION when ordering.

## Ways and Means

≠ A North Tonawanda, New York, bank has made available to the city 495 feet of riverbank land, for the sum of one dollar.

≠ A former Army reception camp in Orangetown, New York, is being converted into a 2,000-family community, Shanks Village, by private developers who have set aside fifty of the project's seven hundred acres for two park and recreation areas, one hundred acres for five public schools plus additional acreage for churches, community buildings and shopping centers.

≠ Hoffman and Swinburne Islands in Lower New York Bay have been purchased from the federal government by New York City for \$10,000, a gift of Bernard Baruch. The two islands will be joined by filling in the shallow water between them and be made into an ocean park.

≠ The Nature Conservancy, a private organization "dedicated to saving America's heritage of wild nature," recently took title to the Battle Creek Cypress Swamp in Calvert County, Maryland. The Conservancy has also acquired Dome Island in Lake George, New York.

≠ An automobile-free recreation area is being developed in Stamford, Connecticut, as part of its \$1,600,000 Cove Island Park project. The park is divided into two sections, forty acres on the mainland and forty acres of island, and will have two beaches and a modern marina. A tractor-drawn observation train of "Minicars" will provide transportation to the island across a main causeway or bridge. This is a historic area from which the China clipper ships once set sail. ■

\* See "The Modern Marina," RECREATION, February 1956, page 80.

# "Explore with

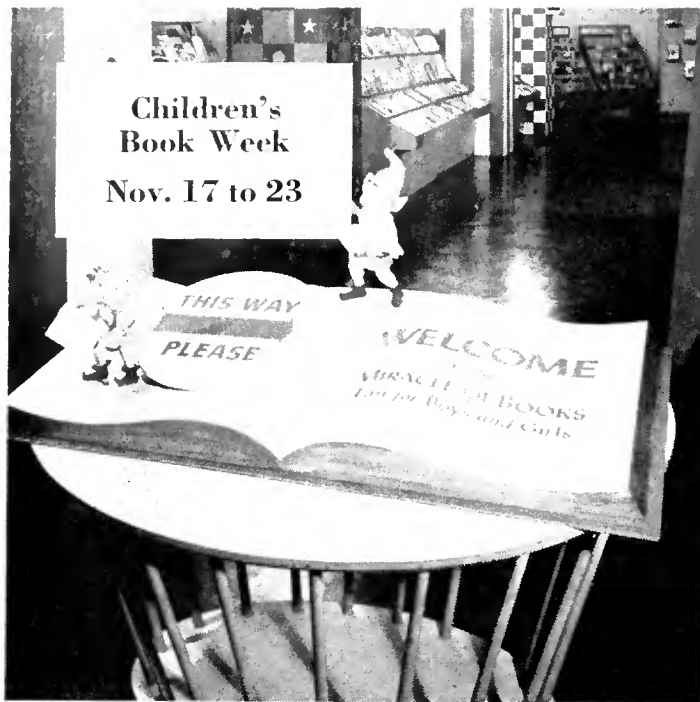

Scene from "Peter Pan's Magic Pipes" brings to life the beloved Wendy, Peter and Tinker Bell.



▲  
Help children discover the miracle of good literature! Participate in your community book fair program.

A child on a playground in Saginaw, Michigan, delightedly surrounds herself with a mountain of books.

▼  
"Boy, I'm goin' to ask for that big baseball book today!" Eagerly they flock to the mobile library for books.



THE WINNING SLOGAN for Children's Book Week 1957, above, is certainly applicable to the adventuring in storyland that is a part of the program of many recreation departments throughout the nation.

We are familiar with storytelling on the playground—preparation for which is done, of course, from storybooks; and, too, there is the magic of reading aloud, which can open the door to fabulous adventure. The acting out of stories by creative dramatics groups, or by the puppets made by the children is also a part of the storybook scene. . . .

Then there are the bookmobiles or bookwagons, sponsored by community agencies in cooperation with the local library, familiar to so many of us and exposing many more children to the fun of reading and the exploration of new horizons through books.

"The library walls are breaking down and books are overflowing not only to community centers, playgrounds, suburban homes, but to the hinterlands as well," according to the *Christian Science Monitor*. "In Massachusetts they are being stretched to include areas as big as one thousand square miles. Coursing down through birch groves and up rocky roads, the bookmobile and its children's specialist reach into the remotest hamlets. A day spent with her makes one realize how strong is the thirst for books in these rural areas." And books are for recreation as well as for learning: as you know, these two go hand in hand.

Recreation leaders, therefore, carry a responsibility toward calling the right kinds of books to the attention of children—the kind that will stimulate their imaginations and help them grow. One way in which leaders can do this is by cooperating with their local libraries, perhaps in a year-round series of adventures with books, using Book Week, or the local book fair, as the springboard for a program which will promote continued "exploring with books."



"We've read all of them!"  
As many as sixty books are left with one country family.



"Mom will enjoy these, too."  
Adults share in reading programs.

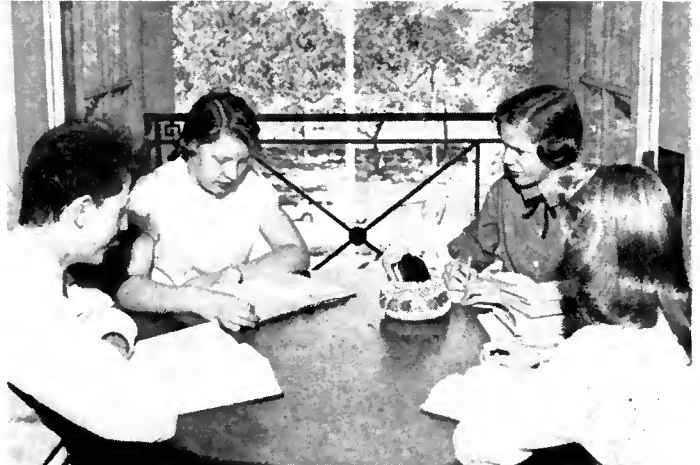

Teen-agers, right, are enjoying library facilities as a part of a book program.

## Cooperative Venture

In Lawrence, Kansas, the traveling library is a cooperative project, the idea for which was generated by a conversation between Wayne Bly, superintendent of recreation, and Leroy Fox, city librarian. Each was anxious to expand the extensive summer reading program sponsored by the library and the Lawrence PTA Council. It was felt that both the reading and the playground program would benefit if a bookmobile could be obtained. Neither the recreation commission nor the library had the equipment or finances to carry the project. They, therefore, appealed to the Junior Chamber of Commerce which responded immediately with an offer to pay the rental on a trailer. The library constructed shelves in it and set up a checking system. The city schools assisted in the program by furnishing a librarian for the wagon. A storyteller was hired by the recreation commission to accompany the library.

During the summer the recreation commission arranged for the library to be pulled to each of eight playgrounds and scheduled either all morning or in the afternoon, with two half-days for checking and filing. Books were taken out one week and returned the next. Children could check out books at either the public library or the book wagon for credit on the reading program.

Through this cooperation of various divisions of public service, many enjoyable hours were spent by Lawrence boys and girls who might otherwise have missed an opportunity to read good books.

## Playground Libraries

In Saginaw, Michigan, Frances Dunn, children's department director for the public libraries, feels that "books can be an integral part of a playground program." Miss Dunn,



Storytelling and reading aloud, either or both, transport the young listeners from the playground to far-off magic worlds.

aided by Mrs. Nelda Hinz, extension department assistant, and other library staff members, each summer puts together a selection of books for use on each city playground.

Playground libraries are contained in large wooden boxes with shelves and consist of from seventy-five to one hundred books. Youngsters check books out just as they do from the city libraries. And they take good care of the books. Of approximately thirteen hundred books placed on playgrounds last summer, only seven wound up missing. ■



# Stories at Christmas Time

Mary Strang

EACH YEAR as I gather the children together in the hush of candlelight for the library's Christmas Eve story hour, there seems to be mingled for a moment with the scent of pine and fir, the fragrance of clove and cinnamon and warm yeast rolls rising on the back of the kitchen stove. I can see again in the bay window the Christmas tree aglow with candles, tinsel, iridescent birds, and small red cotton Santas, and I can hear my father reading—"In the time of swords and periwigs and full-skirted coats with flowered lappets—when gentlemen wore ruffles and gold-laced waistcoats of paduaso and taffeta—there lived a tailor in Gloucester. . . ."

How I loved as a child the sound of the "stuffs"—the "satin, pompadour, and lutestring," the "cherry-coloured corded silk," the "gauze and green-worsted chenille!" How I delighted in the old rhymes heard by Simpkin on Christmas Eve from the garrets, the eaves, and behind the wooded lattices of the old houses of Gloucester! How I rejoiced in the goodness of the little mice, the repentance of Simpkin, and "the luck of the tailor of Gloucester!" Remembering my own childhood, I could never quite enjoy a Christmas Eve with children if I did not share with them the beloved story of Beatrix Potter.

Thus it should always be at Christmas. The beauty of the season lies not only in its special religious significance but in the bonds of tradition which draw us together in a common heritage of fellowship, a heritage as ancient as man's first rejoicing in the return of the sun at the time of the Winter Solstice. When I first began my work in the library, I was sent to two neighborhoods with mixed religious backgrounds. Both were served by children's librarians deeply loved and respected by the whole community. At Christmas time, one used in her programs only the secular material; the other introduced St. Nicholas through Eleanor Farjeon's *Ten Saints*, told the the story of the Maccabees and had the candles lit at dusk during the eight days of Hanukkah, and on Christmas Eve read the story of

the Nativity. Each, being true to her own convictions, enriched the lives of the children and drew them together in her own way. This, it seems to me, is a lesson worth learning and, as I mention the stories which have been used successfully in our libraries, let it be borne in mind that they are no more than suggestions for others who will be reading and telling stories to children during Christmas season, and that the success with which they are used will always depend on the story-teller and the mood she creates through her own heritage.

We begin our season in the library with St. Nicholas Eve on December 5th and end on Twelfth Night, January 6th. In our programs we may read or tell old favorites with no more reason than mine for *The Tailor of Gloucester*, but as a rule we plan them on themes which bring out the many facets of our Christmas heritage. Music and poetry have their place, and with those who have the time and staff for it, the puppet show may be the chief event of the season. We use several editions of *The Night Before Christmas*, many of them now out of print but always new and exciting to the children. The favorite is always that illustrated by Elizabeth MacKinstry with its double-page spreads of the reindeer dashing over the rooftops and the enchanting toys in Santa's bag. Eleanor Farjeon's *Come Christmas*, Jean Thoburn's *Away in a Manger*, and Anne T. Eaton's *The Animals' Christmas* and *Welcome Christmas!* are favorite sources for poetry though many other anthologies are used. *The Cherry Tree Carol* is lovely to read or sing.

We sing informally with the children, unaccompanied (unless we are fortunate enough to have someone on the staff who plays recorder, flute, or guitar) and we use, as a rule those collections of songs which are also picture books: the Van Loon and Castagnetta *Christmas Carols*, Tertius Noble and Helen Sewell's *A Round of Carols*, *The Twelve Days of Christmas*, and so on.

In our story hour we usually tell our stories, learning them well to achieve that intimate ease and facility of tongue so essential in all good storytelling. Some material, however, should be read. On St. Nicholas Eve, for instance, we will tell "How the Good Gifts were Used by Two" from Howard Pyle's *Wonder Clock*, but we read "Olaf's Dream" from *Knickerbocker's History of New York* and the "St.

---

MISS STRANG is children's librarian in the Nathan Straus Children's Room, Donnell Library Center, New York City. Reprinted with permission from *Getting Ready for Christmas*, published by the Arts Cooperative Service, Inc., New York, N. Y. Pp. 32. Paper \$.75.

Nicholas Festival" from *Hans Brinker*. Other suggestions for yuletide material include:

**Stories to be Told**

- "The Happy Prince," *Happy Prince and Other Tales*, Oscar Wilde.
- "How the Good Gifts Were Used by Two," *Wonder Clock*, Howard Pyle.
- "The Voyage of the Wee Red Cap," *Long Christmas*, Ruth Sawyer.
- "Schnitzle, Schnotzle, and Schnootzle," *Long Christmas*, Ruth Sawyer.
- "The Crib of Bo'Bossu," *Long Christmas*, Ruth Sawyer.
- "Fiddler, Play Fast, Play Faster," *Long Christmas*, Ruth Sawyer.
- "The Wee Christmas Cabin of Carn-naween," *Long Christmas*, Ruth Sawyer.
- "The Elves and the Shoemaker," *Fairy Tales*, William and Jacob Grimm.
- "The Cat on the Dovrefell," *East of the Sun and West of the Moon*, Gudron Thorne-Thomsen.
- "Every Man Heart Lay Down," *How God Fix Jonah*, Lorenz Graham.
- "The Peterkins' Christmas Tree," *Peterkin Papers*, Lucretia Hale.
- "Demerara Sugar," *Fairy Caravan*, Beatrix Potter.
- "The Christmas Cuckoo," *Granny's Wonderful Chair*, Frances Browne.
- "The Christmas Masquerade," *Pot of Gold*, Mary E. Wilkins.
- "The Legend of the Christmas Rose," *Christ Legends*, Selma Lagerlof.
- "The Rose and the Ring," *Christmas Books*, William Thackeray.
- "The Christmas Spider," Marguerite de Angeli, in *Eaton's Animals' Christmas*.
- "Cinderella," *Told Again*, Walter de la Mare.
- "The Fir Tree," *Fairy Tales*, Hans Christian Andersen.
- "Wee Robin's Yule-Song," *Tales of Laughter*, Kate Douglas Wiggin and Nora A. Smith.
- "The Three Magi," *Tiger and the Rabbit*, Pura Belpre.

And the following books:  
*The Nutcracker of Nuremberg*, Alexandre Dumas.  
*The Velveteen Rabbit*, Margery Bianco.

**Stories to be Read**

- "Olaffe's Dream," *Knickerbocker's History of New York*, Washington Irving.
- "The Coming of Nicholas," *Nicholas: A Manhattan Christmas Story*, Anne Carroll Moore.
- "The Festival of St. Nicholas," *Hans Brinker*, Mary Mapes Dodge.
- "Christmas," *Nino*, Valenti Angelo.
- "Christmas," *A Norwegian Farm*, Marie Hanson.
- "Christmas Eve," *Dobry*, Monica Shannon.
- "Dolce Domum," *Wind in the Willows*, Kenneth Grahame.
- "Playing Pilgrims," *Little Women*, Louisa May Alcott.
- "Christmas! Christmas!," *Tag-Along-Tooloo*, Frances Clarke Sayers.
- "A Letter from Santa Claus," *Middle Moffat*, Eleanor Estes.
- "The Christ Child," *Pictures*, Maud and Miska Petersham.

And the following books:

- Hansi*, Ludwig Bemelmans.
- Noel for Jeanne-Marie*, Françoise (Seignabosc).
- All Through the Night*, Rachel Field.
- The Steadfast Tin Soldier*, Hans Christian Andersen.
- Hansel and Gretel*, William and Jacob Grimm (Illustrated by Warren Chappel).
- The Magic Fishbone*, Charles Dickens.
- The Christmas Whale*, Roger Duvoisin.
- The Christmas Bunny*, Will and Nicolas (William Lipkind and Nicolas Harcourt).
- A Christmas Carol*, Charles Dickens.
- Miss Muffet's Christmas Party*, Samuel M. Crothers.
- Bertie's Escapade*, Kenneth Grahame.
- Lullaby, Why the Pussy-Cat Washes Himself So Often*, Josephine Bernhard. ■



# THE TRAMPOLINE IS A PIED PIPER

AND IF IT ISN'T A NISSEN IT ISN'T A TRAMPOLINE\*

The day it arrives boys and girls of all shapes, sizes and ages miraculously appear from every direction. Children love the thrill of bouncing and flying through the air on a Trampoline. And they like the fact that the basic jumps are so easily mastered. They're experts in no time at all.

Trampolining is good for them, too. Provides excellent all-around conditioning exercise. It's the favorite new recreational activity at camps, Y's community centers, schools, and playgrounds.

Nissen Trampolines bounce better longer. Are sturdily constructed to take it and last. There's a model and size to fit your needs at a price to fit your budget.

See your sporting goods dealer or write to—  
**NISSEN TRAMPOLINE COMPANY**  
 200 A Ave. N. W., Cedar Rapids, Iowa



\*Reg. U.S. Pat. Off.

# CHRISTMA

FIG. 1



FIG. 2

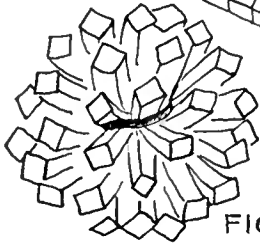
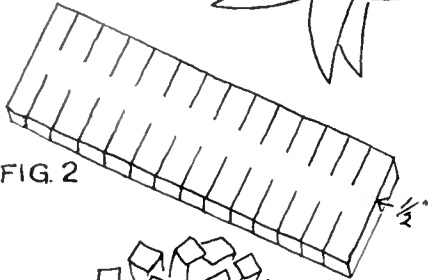

FIG. 2A

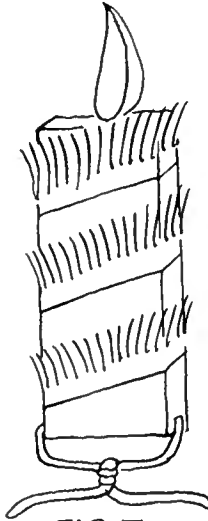

FIG. 3



FIG. 3A

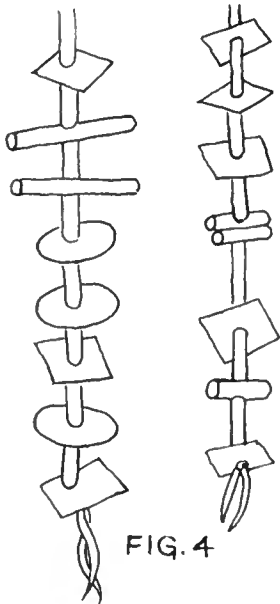

FIG. 4

## COMMUNITY HOLIDAY GIFT

A series of free Christmas lecture-demonstrations called "Holiday Hints" was the result of an idea conceived in one of the regular staff meetings of the San Mateo, California, Recreation Department. The previous year we had sponsored a series called "Home Decorations for Christmas," and the response had been overwhelming. Unfortunately, we were unable to cope with the thousands of ideas the group seemed to want, and attendance dropped off radically.

We knew, therefore, that public enthusiasm for a Christmas-idea session was very real; and we also knew that the interest span ranged from holiday foods to door swags. A group of Christmas lectures, covering as many Christmas subjects as possible, was planned. We listed all these subjects and consolidated them into the following five sessions with a specialist scheduled to talk in each field:

- *Creative Christmas Cards.* Block printing, inner-tube and felt printing, resist printing, simple silk screen, wrapping papers.
- *Gift Wrapping.* Theme ideas, bows and ties, decorative wraps, food packages, parcel posting.
- *Floral Art and Christmas Decor.* Centerpieces, door swags, mantel pieces, special demonstrations.
- *Christmas Ornaments and Crafts.* Tree fantasies, craft ornaments, home decorations.
- *Creative Holiday Foods and Table Ideas.* Decorating cakes, pies, and cookies, hors d'oeuvres, children's food ideas, food gift ideas.

We offered the series free, our "Christmas gift to the community."

The next step was to find people to do the lecturing, and this, of course, was the biggest assignment. We had set a tentative budget of one hundred dollars for the lecturers. After talking

with dozens of people, including members of our craft classes, instructors, floral designers, librarians, adult education administrators and many others, we started calling selected people. Within two weeks we had our lecturers signed up, topics ironed out and dates definitely set.

The public library basement was the best available location. It had a platform that seated approximately one hundred, so all except the floral art session were scheduled there. The latter was held at the shop providing the lecturer. The program was scheduled to start on November 14, the fifth and final session to be on December 12, missing the holiday rush. All sessions were held in the evening.

Handbills were printed by the offset method and distributed to organizations and individuals expressing an interest in this type of program. The library also placed them on the sign-out desk, and its supply was replenished several times. Other publicity appeared in local and San Francisco newspapers, as well as on public information radio programs. One of our lecturers was scheduled for an interview on the radio, and she mentioned the series during her program. A five-foot foil Christmas tree, made by one of the instructors, was placed in the lobby of the library the first week of November, and served as our "theme tree." It was flooded with spotlights and attracted a great deal of attention.

The attendance at the sessions averaged ninety persons. Some of the participants attended all the sessions, while others came to just the one or two of particular interest to them. All those present signed a register and indicated what other types of programs might interest them.

As a department, we were very pleased with the reception given our "Holiday Hints" program, which will undoubtedly continue and grow in years to come. Not only did we ac-



# Classes and Crafts

quaint many new people with the services of the San Mateo Recreation Department, but we were able to provide the public with the type of program they wanted—which is, after all, our purpose.—CAROL BROWN, *Recreation Supervisor, San Mateo, California.*

## CRAFTS FOR CHILDREN

Christmas crafts—or crafts for any season or holiday, for that matter—get a head start in Long Beach, California, through the stimulation provided in the children's crafts preparation room. Located near the main recreation office, it is easy for the directors of the nineteen play areas to visit. From the many craft projects on display, the supplies and the bulletins available, they take back all sorts of suggestions for crafts children enjoy.

At Christmas the room is gaily decorated. Two of the windows are painted with poster paint to look like stained-glass windows. Angels and choir girls are everywhere. Hanging from white index tabs glued to the plaster ceiling are all sorts of tree decorations. They are simple, attractive, and can be made by children from low-cost materials. A make-believe fireplace and a small tree with bright decorations add a traditional touch.

Right after Christmas all these disappear, and New Year's decorations, then those for the February holidays, Easter, spring, and so on, replace them—a never-ending treasure trove of craft projects for all occasions.

About four years ago, the idea of letting the children make the decorations for the big, 188-foot Christmas tree for the City Hall got started. Now it's a tradition, and the city fathers look forward with interest to seeing what the tree will be like each year. A white tree has displayed the ornaments very effectively for the past two years; this year we may leave it green.

Every municipal play area takes part. Samples are made in the preparation

room, and each area makes twenty-five of a selected ornament for the City Hall tree. A sample and a kit of supplies are given to each area. Actually, most of the children make three ornaments—one for the City Hall tree, one for the area tree and one to take home for the family tree. Each area sends its group of twenty-five ornaments to the preparation room and receives public credit for its ornaments.

Last year foam-rubber ornaments were featured, so five areas made them. Other ornaments made were metal-foil angels, plastic-foam candles, tassels, paper-cup bells, glitter stems, straw-drops—to name only a few.

Work starts early in November, with a deadline of the thirtieth. The tree is painted and flameproofed by the maintenance crew of the department, which is responsible for all city trees. The lights belong to the department. The tree takes five strings of twenty-five lights, outdoor type. Staff members hang the ornaments on the lower limbs, and two maintenance men do the high climbing.

Our carpenters made two huge candles, about five feet tall and eighteen inches in circumference, painted a brilliant red, and we put a twelve-inch neon-tube light in the top of each. These stand in the hall approaching the tree. The name of each play area and a sample of the ornaments made by each are pinned on these candles.

Materials used in the ornaments include metal-foil paper, chenille humps, pipe cleaners, felt, oilcloth, gummed crepe paper, plastic-foam balls, sheets of plastic-foam, colored foam rubber, paper cups, ice cream cartons, and the like. The examples that follow are only a few of the many chosen and made by the youngsters as a Christmas gift to the City Hall.

### Star Angel

*Materials needed:* Metal foil, one-and-a-quarter-inch plastic-foam ball, yarn,

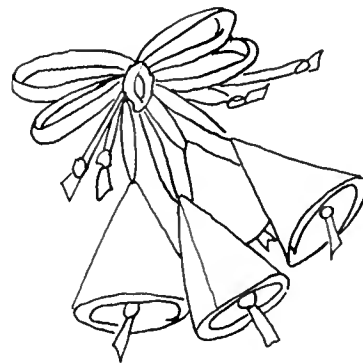

FIG. 5

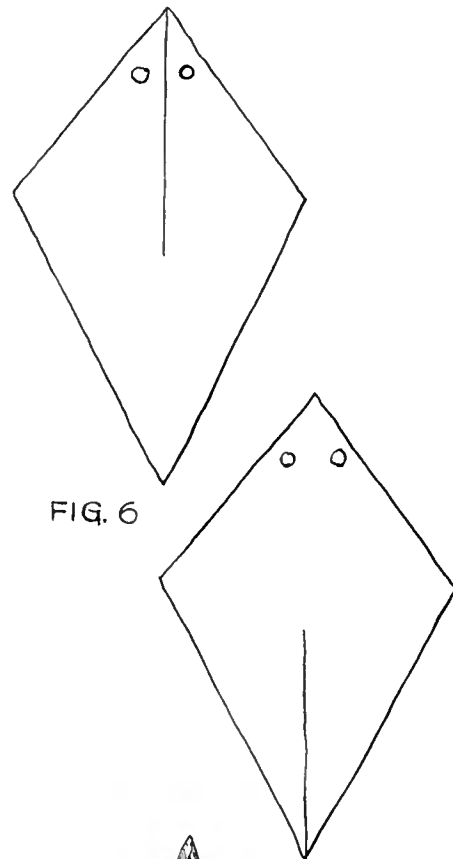

FIG. 6



FIG. 6A

scissors, pipe cleaner.

*Directions:* Cut two five-pointed, six-inch stars from metal foil. Use a plastic-foam ball for the angel head; push a pipe cleaner through the center of the ball, leaving a short piece at one end for a tree hook. Staple the stars to the long piece of pipe cleaner and then staple the stars together. Decorate the face with metal foil (Figure 1).

### Foam Ornaments

*Materials needed:* Foam rubber, pipe cleaners, scissors, gummed crepe paper, plain crepe paper.

*Directions:* Cut foam rubber into strips (a three-inch-wide strip of foam rubber should be cut about fifteen inches long, a narrower width would require less length). Slash strips on both sides (Figure 2). Roll and wrap a pipe cleaner tightly around center (Figure 2A). To hang on tree, make a loop or hook from the pipe cleaner.

### Candles for the Boughs

*Materials needed:* Plastic-foam, pipe cleaners, chenille humps, metal foil,

sequins, small pins.

*Directions:* Cut a candle, five inches high, by one-inch wide, from a one-inch-thick piece of plastic-foam; leave it square or round it by sanding. To make candle in Figure 3, cut strip of metal foil one-inch wide, slash it to make a fringe, and curl fringe slightly. Put a yellow and a red chenille hump together and push into the top of the candle for flame. Put a pipe cleaner through the bottom of the candle and fasten to branch of tree. To make the candle in Figure 3A, follow the directions for Figure 3, but omit fringe and add sequins.

### Straw Ropes

*Materials needed:* Yarn, colored drinking straws, metal foil, large needle.

*Directions:* Thread needle with yarn. tie knot in one end. Cut straws into short pieces. Cut various shapes from foil. Alternate stringing straws and foil pieces on yarn (Figure 4) beginning and ending with foil pieces, until two inches from the needle. Make loop at end for hanging.

### Elfin Bells

*Materials needed:* Metal foil, yarn.

*Directions:* Cut a circle three inches in diameter from aluminum foil. Make a straight cut from edge to the exact center of circle. Knot a piece of yarn, leaving end long enough for a bell clapper, and insert at the center of circle. Slide one edge over the other until there is an overlap of three thicknesses and circle is cone-shaped. Tie several in a cluster (Figure 5).

### Tassels Ornament

*Materials needed:* Metal foil or construction paper, yarn, scissors.

*Directions:* Cut diamonds or circles from metal foil or construction paper. Cut along straight line (Figure 6) to the center of each. Fit two of them together. Make tassels or pompoms of yarn (this takes about four feet of yarn) and paste or staple to ornament. Insert string through holes of ornaments to hang from the tree (Figure 6A).—MRS. LOIS DELANO, craft specialist, Recreation Department, Long Beach, California. ■

**MacGregor Sports Equipment**

**"The Choice of Those Who Play The Game"**

The MacGregor Co. • Cincinnati 32, Ohio  
FOOTBALL • BASEBALL • BASKETBALL • GOLF • TENNIS

the *Management Journal*  
**Parks & RECREATION**  
MAGAZINE

**FOR:**

- ▶ You
- ▶ Your Board
- ▶ Your City Officials
- ▶ Your Key Personnel
- ▶ Your Informed Lay Supporters

**FOR PARK AND RECREATION SUPERINTENDENTS . . .** techniques described by practical men in the field.

**BALANCED EDITORIAL FORMULA . . .** the voice of the professional on land acquisition, design, construction, recreational usage, administration and maintenance . . . a complete coverage.

**A QUALITY PRODUCT . . .** fine paper, printing, photos, maps and editorial approach.

**PARKS & RECREATION . . .** only national magazine designed for both park and recreation administrators.

**EACH MONTH . . .** the most "referred to" publication in its field . . . a must for your reference library.

**ALL USABLE INFORMATION . . .** no fiction, no "fairy tales" avidly read from cover to cover . . . send for your free sample and judge for yourself.

**SERVING THE PARK AND RECREATION FIELDS SINCE 1917.**

| SUBSCRIPTION RATES              |                       |
|---------------------------------|-----------------------|
| One year                        | \$ 5.00               |
| Two years                       | 9.00                  |
| Three years                     | 13.00                 |
| Groups of four or more—one year | \$4.00 each per year. |

**PARKS & RECREATION**  
Department RN  
Oglebay Park  
Wheeling, West Virginia

publisher



# SPORTS QUIZ PROGRAM

**L**OOKING for ideas for men's or boys' clubs, service clubs, sports banquets—or for a community night program, indoors or out? The following sports quiz, and a new way to put it on, comes from *USAREUR Service Club Notes*.

**Decorations.** Simple. Use pennants of all the major league teams. They can be made of paper, plastic, cloth or felt. Craft groups will enjoy making them. **Music.** If possible, provide a combo group, fanfares, and snatches of songs such as "Take Me Out to the Ball Game."

**Setup.** Arrange the stage or open area as a baseball diamond, using chairs for first, second and third base, microphone for homeplate.

Nine chairs on each side represent the "dugouts"; and seat contestants when they are in the field. When a team is up to bat, the first member is asked a question. If he answers correctly, he goes to first base. If he fails, he is "out," and the second batter comes up. Each time a batter answers a question correctly, he goes to first base and any runners on base advance one base. Three wrong answers bring the other team up to bat. Each batter has his choice of a "single," "double," or "home run" hit, depending on the degree of difficulty of the questions.

Make up your own questions, drawing upon your knowledge, your sports library, other publications and sports experts, being careful to include some questions that are fairly easy as well as some more difficult. Everyone should have a chance at an easy one now and then to keep him from becoming discouraged; but he should have to think too! Don't make your quiz so long that participants have a chance to become bored. Fifteen questions in each category would be about right.

The following are examples of questions that might be asked in each of the categories:

## "Singles" Questions

1. In what sport are the following terms used: "on guard," "feint," "parry," "thrust"?

2. In football, how many points are scored for a touchdown?

3. In horse racing what is a "bookie"?

4. In what sport is the term "squeeze play" used?

5. Where is the famous New Year's Day football game played?

6. What does the umpire call out at the start of a baseball game?

7. By what name was Cornelius McGillicuddy known?

8. In swimming, do you get more power from the arms or legs?

## Answers

1. Fencing. 2. Six. 3. A person with whom one can place bets. 4. Baseball. 5. Rose Bowl, California. 6. "Play ball." 7. Connie Mack. 8. From the legs.

## "Doubles" Questions

1. Are the Curtis Cup matches polo matches, golf matches, or hockey matches?

2. In boxing, which is heavier, a bantamweight or a featherweight?

3. What is the highest possible score in bowling?

4. What is meant by "taking a dive" in a prizefight?

5. What star hitter and first baseman held the record for the greatest number of baseball games played in succession?

6. What does "offside" mean in hockey?

## Answers

1. Golf matches. 2. A featherweight. 3. 300. 4. Pretending to be knocked out. 5. Lou Gehrig. 6. Offensive player goes across the defensive line before the puck.

## "Triples" Questions

1. What sport draws the largest attendance in America?

2. What manager has won pennants in both major leagues?

3. What does the term "double fault" mean in tennis?

4. What young lady is known as the foremost woman swimmer today?

5. Who in baseball are known as "Little Poison" and "Big Poison"?

6. The drop kick in football has almost disappeared. What took its place?

7. What college basketball team had several of its players disqualified due to bribery charges in 1945?

8. What are the gaits of a three-gaited horse?

## Answers

1. Softball. 2. Joe McCarthy, eight with the New York Yankees; one with the Chicago Cubs. 3. Two bad serves. 4. Ann Curtis. 5. Paul and Lloyd Warner. 6. The place kick. 7. Brooklyn College. 8. Walk, trot, and canter.

## "Home Run" Questions

1. Where is baseball's Hall of Fame located?

2. How many innings was the longest baseball game in the history of the majors?

3. Name the only horse that ever beat Man O' War?

4. What are periods in a polo game called?

5. From what date is the age of race horses calculated?

6. Name in order the three heavyweight champions previous to Joe Louis.

7. What have the following in common—Sutton, Mallery, Jacobs?

8. Rounders was an early form of one of our national sports. What is it?

## Answers

1. Cooperstown, New York. 2. Twenty-six innings—a 1-1 tie between Brooklyn and Boston in 1920. 3. Upset. 4. Chukkers. 5. From January 1—A race horse born in July, 1930 is said to be two years old January 1, 1932. 6. Primo Carnera, Max Baer, James J. Braddock. 7. They are all women tennis players. 8. Baseball. ■

A MOBILE ~ makes interesting decoration for SEASONAL HOLIDAYS ~ PARTIES ~ ETC.

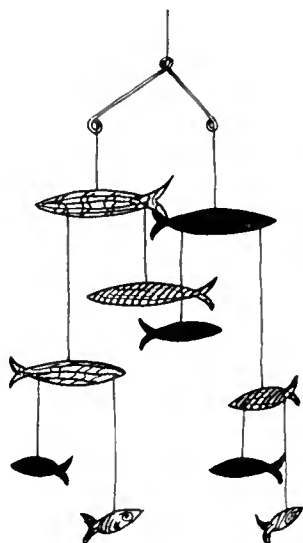

## MATERIALS

Fine wire (florist's wire) ~ Cardboard ~ Tin ~ Paint ~ Black Thread.

## SUBJECTS for MOBILES

Free forms ~ Abstract forms ~

Natural forms ~

Man-made forms.

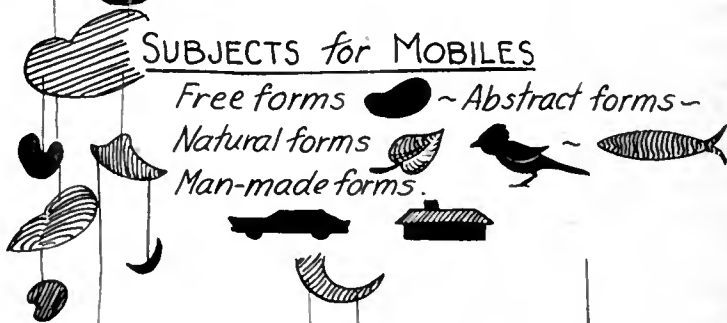

## How THE FISH MOBILE was made.

1. Five sizes of fish were cut out of cardboard.

Ten fish in all ~ two of each size.

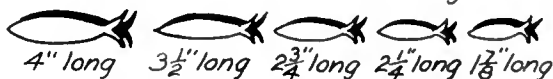

2. Fish painted various harmonizing colors.

3. Wire bracket 8 inches long.



4. Two largest fish attached to ends of bracket with black thread.

Note: Be sure thread is attached to fish at point of perfect balance.

Thread on one fish is longer than thread on other fish.

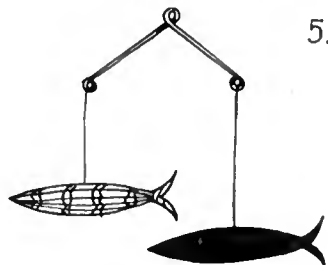

5. The remaining fish are now attached in a sequence of sizes so that they are in perfect balance.

Note: The lengths of black threads vary to give interesting arrangement to the cluster of the different sizes of fish.

6. Try one of your own ~ select a subject suited to the purpose of the mobile.

If it is for Christmas decorations use shapes such as stars - trees - Christmas ornaments ~ Santa Claus ~ children's toys, etc.

Your problem is to secure perfect balance so that all parts of the mobile will move independently of all other parts and yet the mobile moves in the slightest air current as a unit.



# Regional Recreation Perspectives

Robert D. Carpenter

## Historical Goals

The development of recreation has been based on the ideal that all who desire recreation activities in the open air should be able to find adequate public open space for their enjoyment. We have attributed to recreation, qualities which improve physical and mental health and moral values. We have attempted to perpetuate, although in a reduced form, the open-space tradition inherited from our past, for the enjoyment of the out-of-doors, and for education in nature lore.

## Growth Factors

Today, in metropolitan areas throughout the United States, recreation development is faced with several important happenings:

1. Our population is growing. In order to maintain today's ratio of recreation lands to people, large acreages will have to be acquired for the future.

2. Our economy is expanding and incomes are rising. More of our people who desire elaborate and land-using recreation activities are obtaining the financial means with which to realize them.

3. People are more mobile. They are able to get into the family car and travel to more distant open spaces quicker and with greater frequency than ever before.

4. We are using up raw land at a greater rate than in the past. More land is required for residences; our highways are wider; suburban shopping centers are built on four to five times as much land as is required for a store's floor area; industry is acquiring four to eight times as much land per manufacturing unit as it did previously; the competition for all types of land is increasing every day.

In the face of all this, it's going to be increasingly hard to obtain adequate recreation lands in the future. Yet, spaciousness is one of the characteristics people seek in recreation areas.

---

MR. CARPENTER is executive director of the Tri-County Regional Planning Commission of Medina, Summit and Portage Counties, Ohio. He was formerly head planner of the Detroit Metropolitan Area Regional Planning Commission.

## Automation

Automation is one of the most important factors in the recreation picture: the shortening work week and the effect of automation on the leisure time of our people. We have gone through one industrial revolution in this country, in which the muscles of men were replaced by machines and men were retained as operators. An increase in leisure time resulted under these conditions and recreation as an important factor in our lives developed to its present proportions.

We are now at the beginning of a second industrial revolution. Through automation, men as operators of machines are being replaced by machines, and another increase in leisure time is coming. The effect on the further development of recreation is incalculable at this time without additional research, the development of new research concepts and continuous intensive study.

## Background for Recreation

This then is the background from which we look at our regional recreation picture: a growing population; an expanding and rising personal income; people more mobile than ever; greater competition for land for all purposes; an increase in leisure time, and time available for recreation that is beyond reasonable prediction at the present.

## Concern of Regional Planning

Because of its land-use implications, all metropolitan or regional planning commissions should be concerned with recreation. Their concern is for the over-all perspective, for the relation of recreation to other land uses and to transportation, utilities and services. Our concern, on a metropolitan scale, is with recreation land—quantitatively, qualitatively and location wise—to make sure that enough land is provided to accommodate in the future the recreation activities of the people who will be living in those regions.

The major interest is in large recreation areas developed for extensive type activities, such as camping, boating, fishing, swimming, winter sports and picnicking. These are differentiated from intensive local recreation uses characterized by the playground and playfield. →

## Recreation Standards

The weakness of the approach to determining future recreation requirements by most agencies becomes apparent upon examination of the basis on which they determine their land requirements. These reveal a variety of attitudes, such as:

- Accepting the limitation of the lands now owned and making the most of them.
- Acquiring lands that have some features to recommend them for recreation use, wherever they may be, and developing them.
- Conserving flood plains and providing parkways.
- Repeating, in some cases with minor variations, the thirty-four-year-old standards of the National Recreation Association.
- Providing playgrounds and playfields to complement the public school system.
- Providing a park or two.
- Stating that more lands are needed, but without further specification or precision.

In practically no instance is there a relation between lands to be acquired and a determination of the need for recreation activities to be accommodated. There is not in existence today a body of information that can indicate what the desires of people are for recreation of various kinds. The consideration of the growth factors and automation, listed earlier, have not been applied. The community or area goals (what are we trying to accomplish) have not been defined with respect to recreation. Recreation programing and land acquisition appear to be pretty much a matter of responding to pressures exerted by various interest groups for projects they are sponsoring.

Recreation desires of the present population must be determined and projected on some logical basis for the future. A great deal of original research needs to be done on the subject of the future trend of leisure time activities in the

highly industrialized regions. Principles, goals and standards must be established explicitly for a determination of future recreation land needs, to serve as a basis for a plan, and as a basis for the future spending of public funds.

A rule of thumb for allocating recreation lands has been in use since 1923, promoted by the National Recreation Association, and with some variations is used throughout the country today. It states that ten acres of park and recreation land should be set aside within the city for each one thousand of the population. For metropolitan regions an additional ten acres of park and recreation land should be allowed for each one thousand of the total population of the region.

### The Magnitude of the Problem

There is great danger in the use of any national standards. They are intended only as general guides. They give no assurance that a community will achieve the kind of recreation development required to meet its situation. At best, they can only indicate, in "round numbers," the magnitude of the problems confronted.

With our present expanding recreation picture, there is a growing need that the thirty-four-year-old general standards of the NRA should be revised, consistent with recreation requirements of a future way of life that is rapidly overtaking us. The question is *how* and on *what basis*?

It would seem most logical that the people best qualified to undertake this work would be the National Recreation Association. Recreation needs a new and expanded philosophy. Principles and goals should be re-defined, to serve as a basis for standards and a determination of land requirements on a metropolitan basis.

If it is not logical or feasible for the NRA to do the job, then it is hoped that in our metropolitan area proper inter-county recreation organizations can make these determinations adequately. In this instance the following recommendations would be appropriate:

1. The scope of the investigation and planning should be sufficiently extensive to cover the recreation requirements of the people living in a metropolitan area projected over a long period into the future. In most cases the area under consideration should encompass a major portion of the state.

2. Acceptable principles of public recreation and desirable standards for recreation land and capital requirements should be developed for the entire area.

3. A statement of recreation needs should be prepared based upon the desires and requirements of the people in the area.

4. A general land plan of public parks and recreation facilities should be prepared.

5. Concerted steps should be taken to coordinate recreation planning and area development among the state, metropolitan park and recreation authorities, the counties, and the municipalities.

6. An organizational structure best adapted to the needs of contemporary and future recreation programs and lands should be provided. ■

## NEW YORK UNIVERSITY SCHOOL OF EDUCATION

### LEADERSHIP TRAINING IN RECREATION

Courses lead to the B.S., M.A., Ph.D. and Ed.D. degrees

#### A SPECIAL WORKSHOP JANUARY 6-31, 1958

in

Workshop in Administration and Supervision of  
Recreation for the Armed Services

Workshop in Recreation Leadership for the  
Homebound

- Write for further information to
- Dr. Edith L. Ball
- School of Education
- New York University
- Washington Square
- New York 3, New York

# NOTES *for the* *Administrator*

## The Changing County

In view of the growing interest in the possible organization of recreation services on a county basis, the following pros and cons of the county as a unit of government merit attention. They appeared in a report, *The Government of Milwaukee County*, prepared by the Public Administration Service.

Among major objections to counties as units of government:

- Most county boundaries were laid out one hundred or more years ago.
- Counties have been unable to attract superior personnel to their service and usually have limited financial resources.
- Many county functions serve only the residents of unincorporated areas but county taxes are paid by all residents.
- County organization is ill-adapted to sound public management.
- The county is often a unit for representation in the state legislature.
- County boundaries have impeded the orderly development of metropolitan government.

On the other hand, counties are likely to persist in the future because they have the following virtues commonly possessed by no other unit of government.

- A sizable fraction of the American public knows only the county as a unit of local government.
- Most states are too large in area and too varied in population to render their services centrally.
- It is desirable that the decentralization of state government should be combined with the administration of local government at some level.
- The alternatives to county government are by no means appealing.—From *National Municipal Review*, October 1956.

## Report Writing

Many practical suggestions for effective report writing originated in a recent three-day session for professional engineers sponsored by the University of Wisconsin. Some approaches to report writing that can improve the caliber of communication are:

1. Write in the same manner as you talk.
2. Organize the report before writing.
3. Use charts or graphs to dramatize your information.

Ideas proposed for helping the report to "talk" are:

1. Use the personal pronoun "I" in place of the vague "we" or impersonal "it."

2. Replace deadening past tense verbs with the present tense.

3. Use words that are simple, clear; also short sentences.

Lack of organization is the most common fault in report writing.

Practical ideas presented are:

1. *Report Title*: A title's job is to tell all by itself what the report contains. Write in one sentence the purpose of the report, using as many words as necessary. Then prune words, and compress the title.

2. *Table of Contents*: Always include a listing of the report's contents to enable the reader to locate immediately the section that interests him.

3. *Introduction*: The introduction section often is no more than a letter of transmittal to the mayor and city council or city manager. If the introduction is more extensive, the writer should offer the reader a crisp statement of the purpose of the report.

4. *Conclusions*: This is your "show window." The newspaperman might call this section the "lead" of your story.

5. *Developing Section*: You've introduced the reader to the report, set out your conclusions, and now you've got to back them up. This is the purpose of the developing section.

6. *Summary*: A summary is more a formality than a necessity. If you have clearly stated your conclusions, and the development section is concise, then a summary is only a rehash at best. If a summary is required, however, then briefly restate the problem, results, and procedure.

7. *Appendices*: This is the catch-all for calculations, historical data, and other material of a supporting nature. Such information should be included in a report to back up your conclusions, but place it in this "bin" to avoid cluttering up the body of your report.

Ideas for pictorial statistics are:

1. The symbol should be related in meaning to the statistic; for example, use garbage cans to indicate increases in the workload of the garbage trucks.

2. Symbols on the chart should represent a definite unit of value.

3. The number of ideas presented in a chart should not exceed two or three at the most. A complex chart defeats its reason for existence.

Guides that serve as a final check: Is the problem well stated? Are conclusions stated clearly? Are conclusions well-supported? Are technical terms understandable? Is the organization compact?—From "Effective Reporting Can Help City Government" by Richard A. Carver. *The American City*, June 1957.

## Court Decisions

The following court decisions were recorded in June, 1957.<sup>1</sup>

In action for death caused by negligently maintaining boats in park, it was held such a function is proprietary and renders public corporation liable for negligence. *Ward v. County Court of Raleigh County*, 93 S.E. 2d 44 (*West Virginia*, May 29, 1956).

A private, non-profit nursery school has no legal right to use public park and building. *San Vicente Nursery School v. County of Los Angeles*, 304 P. 2d 837 (*California App.*, December 19, 1956).

<sup>1</sup> From *The American City*, June 1957.



## Legal Notes and Court Decisions

### Golf Injury

Action brought by golfer against city and golf ball driver for injury received when city employee-starter directed driver to tee off and golf ball struck plaintiff on another fairway. Complaint dismissed as golfer assumed the risks of the game and driver was under no obligation to warn players on contiguous fairways. *Truman versus City of New York*, 143 N.Y.S. 2d 467 (Sup. Ct. Bronx City, June 16, 1955).

### Acquisition Power Established

Statute to ratify and confirm powers, acts, and duties of Town of Huntington's trustee together with prior statutes and case law conclusively establish the Board of Trustees of Huntington's right to acquire beach property, recreation fields, parking areas, and to sell sand and gravel. *Knapp versus Fasbender*, 151 N.Y.S. 2d 668, (N.Y., April 27, 1956).

### Not Attractive Nuisance

Where boy drowned in artificial lake filled and maintained by town, action based on attractive nuisance doctrine could not be sustained where complaint failed (1) to allege where, how, or under what conditions the boy fell into the lake and (2) to cite similar acts by children that could constitute notice to

the town of such a nuisance. *Lovin versus Town of Hamlet*, 90 S. E. 2d 760 (N.C., Jan. 13, 1956).

### Refreshment Stand in Park

Right of park commissioners to maintain refreshment stand in public park situated in residence zone upheld by Court which said that such stand was not a nuisance but was a necessary part of a public facility, a proper accessory use serving the public, and had caused no destruction of neighboring property values. *Board of Park Commissioners versus City of Bay Village*, 141 N.E.2d 769. (Court of Appeals, Cuyahoga County, Ohio, Apr. 24, 1957.)

### Beach Right

In this case a special Act of the State Legislature authorized the Township of Huntington to establish and maintain public beaches on any point within the Town, regardless of conflicting regulations established by any incorporated Villages within the Town. This Act was challenged by two Villages and by taxpayers living there.

In the opinion, the Court held that the special law destroyed the uniformity required under the Constitution, and so was invalid. It was also pointed out that, with the establishment of a beach, the result might be to create heavy traffic congestion and policing hazards. *Incorporated Village of Lloyd Harbor versus Town of Huntington*, 157 N. Y. Supplement (2d) 442 (Supreme (lower) Court, November 8, 1956.)

### Fishing Resort

Zoning change which put his property in residential zone challenged by

operator of fishing resort. Nearby were public golf course, hunting and fishing club, milk distributing station, and sale stable for horses. Residences were on other side of main road. Court held that ordinance making change was invalid as applied to fishing resort as it was in well known "fishing area" and that road was natural boundary between residence area and that devoted to recreation and associated purposes. *Regner versus County of McHenry*, 133 N.E.2d 545. (Ill. Supreme Court, Nov. 26, 1956.)

### Dining and Dancing

Bar and restaurant operated as non-conforming use in house in residence zone. Owner desired to enlarge second floor facilities to provide for dining and dancing. Court ruled that burden of proving that second floor had been used for dining and dancing when zoning ordinance was passed twenty years ago rested on owner, and held that dining and dancing were not incidental to the non-conforming use of the house. *Heagen versus Borough of Allendale*, 122 A.2d 181. (N.J. Supreme Court, Appellate Division, Nov. 21, 1956.)

### Clubhouse and Swimming Pool

Granting of permit for operation of clubhouse and swimming pool in residence area upheld by Court. Ordinance permitted "semi-commercial" use and Court held that there was ample evidence to show qualification as such. *Schumm versus Board of Supervisors*, 295 P. 2d 934. (Calif. District Court of Appeal, 3rd Dist., Apr. 18, 1956.)



# .....CLASSIFIED ADVERTISING.....

**RATES:** Words in regular type \$.15 each  
Words in boldface type \$.25 each  
Minimum ad accepted ... \$3.00

**COPY:** Type—or clearly print—your message and the address to which you wish replies sent. Underline any words you want to appear in boldface type.

**DEADLINES:** Copy must be received by the fifth of the month preceding date of the issue in which ad is desired.

Send copy with remittance to: RECREATION Classified Advertising, 8 West Eighth Street, New York 11, New York.

## HELP WANTED

**Community Recreation Director** for town of five thousand. Starting salary \$4500-\$5500 based on experience. Send complete application to Mrs. Richard Tysseling, 506 Broadway, Pella, Iowa.

## SERVICES AVAILABLE

**Bart Haigh—Square Dance Caller.** Simplicity and fun to records or band. Also: gummed paper stamps made to order for square dance, recreation, and general publicity purposes. 123-35 82nd Road, Kew Gardens 15, New York.

**Piute Pete of Village Barn and TV fame.** School Dance—Workshops—Organization Barn Dances. Hilarious Audience Participation Games, Novelty Dances and Square Dances. Piute Pete, 55 West Eighth Street, New York 11, New York.

*The publisher assumes no responsibility for services or items advertised here.*

HELP WANTED • • POSITIONS WANTED • • SERVICES AVAILABLE • • WORKSHOPS & CONFERENCES • • EDUCATIONAL OPPORTUNITIES • • ITEMS FOR EXCHANGE

## ASSISTANT DIRECTOR OF RECREATION

Graduate with specialization in Recreation, Physical Education, Group Work or closely related field, with four years full-time paid experience in Community Recreation Group Work. Municipal Civil Service. \$483 - \$532 per month. Write: Civil Service Commission, City Hall, El Cajon, California.

## TABLE TENNIS

... Teachers, Recreation Directors and coaches do you have any table tennis players? Write for FREE information on how to qualify for the tryouts of the U.S. "JUNIOR TEAM" to London, England this season.

**ALL-AMERICAN TABLE TENNIS**  
20 E. Jackson, Chicago 4, Ill. Box 501

## YOU CAN PUBLISH YOUR BOOK

Free brochure tells how we published 2000 books for authors. Free editorial appraisal. Write Dept. R 10  
**EXPOSITION PRESS / 386 4th Ave., N.Y. 16**

## Jamison PLAYGROUND EQUIPMENT

Be sure to check the many exclusive features of this rugged line. Write for free catalog of 254 items.

Jamison Manufacturing Co. Since 1925  
3781 South Mettler Street  
Los Angeles 3, California

## RECREATION THERAPISTS

for California State Hospitals in several locations. Positions open to college graduates with major in Recreation or Recreation Therapy and supervised field work. Monthly salary starts at \$376; promotional opportunities in expanding rehabilitation program to \$644. Liberal employee benefits. Write Medical Recruitment Unit, State Personnel Board, 801 Capitol Avenue, Sacramento, California.

## ICE WHEN YOU WANT IT with BELTEMP

artificial ice skating rinks by  
**BELTZ ENGINEERING LABORATORIES**  
11021 Whittier Avenue  
Detroit 24, Michigan. VEnice 9-1811

## Wear Your Golden Age Club Pin With Pride Wherever You May Go



Designed by representatives of over 100 Golden Age clubs and used nationally.

Gold colored metal with evergreen tree in jewelers' enamel. Symbolic of long life, strength and perseverance. The words LOVE, PLAY, LEARN, SERVE (greatest values of club membership) enameled in black. The border is a laurel wreath for honor. Safety catch.

**EXACT SIZE**  
The words LOVE, PLAY, LEARN, SERVE (greatest values of club membership) enameled in black. The border is a laurel wreath for honor. Safety catch.

Available Only to Authentic Clubs.

50c each, minimum order 10 pins.

**James Spencer & Co.** 22 N. 6th Street Philadelphia 6, Pa.

## RECREATIONAL DIRECTORS IF ROLLER SKATING

is on your program send for— Games, Hints and New Ideas

*Free*

**SKATING REPORTER**  
65 Shadyside Ave., Dumont, N.J.

## Change of Address

If you are planning to move, notify us at least thirty days before the date of the issue with which it is to take effect, if possible, in order to receive your magazines without interruption. Send both your old and new addresses by letter, card or post office form 22S to: Subscription Department RECREATION Magazine, 8 West Eighth Street, New York 11, N. Y.

## PLAY AREAS DO DOUBLE DUTY WITH

# Superior

## Folding Table Tennis Tables!



Superior tables can be stored compactly, can be opened for play in a jiffy... even rolled away on wheels by a youngster. Sturdy, rigid Superior MT1000 Table has edge-protecting METAL FRAME AND TUBULAR STEEL LEGS, HEAVY DOUBLE HARDWARE ON LEGS. Thousands used by playgrounds, camps, schools, military installations... wherever a heavy duty table is needed.

**NEW! Optional Feature!**

Roll-away casters make it easy to clear your floors.

**POPULARLY PRICED! APPROVED BY USTTA.**

Write for literature showing complete line of institutional table tennis tables.

# Superior

**INDUSTRIES CORPORATION**

565 Barry Street, New York 59, N. Y.

# Books & Pamphlets Received

ALSATIANS, Lillian Leonard, Dover Publications, 920 Broadway, New York 10. Pp. 95. \$.75.

BAFFLING EYES OF YOUTH (Study of juvenile delinquents), John K. Donohue. Association Press, 291 Broadway, New York 7. Pp. 251. \$3.50.

BASIC RIFLE MARKSMANSHIP. National Rifle Association, 1600 Rhode Island Avenue, N.W., Washington 6. Pp. 30. \$.25.

BEST SPORTS STORIES—1957, Irving T. Marsh and Edward Ehre, Editors. E. P. Dutton, 300 Fourth Avenue. New York 10. Pp. 355. \$3.95.

BOOK OF CONTEMPLATION, A, Dagobert D. Runes. Philosophical Library. 15 East 40th Street, New York. Pp. 149. \$3.00.

BOOK PUZZLE PAD (Crossword puzzle based on children's books), Eugene Maleska. Children's Book Council. 50 West 53rd Street, New York 19.

Each pad contains thirty-five copies of puzzles. \$.35 each. 12 pads for \$4.00.

BUD PLAYS JUNIOR HIGH FOOTBALL, C. Paul Jackson. Hastings House, 41 East 50th Street, New York 22. Pp. 157. \$2.75.

CHILD AND HIS WELFARE, THE (Second Edition). Hazel Fredericksen. W. H. Freeman, 660 Market Street, San Francisco 4. Pp. 364. \$5.00.

COMMUNITY OF THE FUTURE, Arthur E. Morgan. Community Service, Yellow Springs, Ohio. Pp. 166. \$3.00.

CONSERVATION HANDBOOK. Interstate Printers and Publishers, 19-27 North Jackson Street, Danville, Illinois. Pp. 499. \$4.00.

CREATING WITH MATERIALS FOR WORK AND PLAY. Association for Childhood Education International. 1200 Fifteenth Street, N.W., Washington 5. Twelve leaflets. \$.75.

DANCE: A CREATIVE ART EXPERIENCE. Margaret N. H'Doubler. University of Wisconsin Press. 430 Sterling Court, Madison 6. Pp. 168. \$4.00.

DANCE IN PSYCHOTHERAPY, Elizabeth Rosen. Bureau of Publications, Teachers College, Columbia University, New York 27. Pp. 178. \$4.50.

DARTBALL RULES (Revised 1955). Wisconsin State Dartball Committee, c/o Municipal Athletic Division, 461 North 35th Street, Milwaukee 8. Pp. 37. \$.30 (plus three cents postage).

EDUCATORS GUIDE TO FREE FILMS—1957, Mary Horkheimer and John W. Diffor, Editors. Educators Progress Service, Randolph, Wisconsin. Pp. 625. Paper \$7.00.

EDUCATORS GUIDE TO FREE SLIDEFILMS—1957. Mary Foley Horkheimer and John W. Diffor, Editors. Educators Progress Service, Randolph, Wisconsin. Pp. 204. Paper \$5.00.

EGGHEADS IN THE END ZONE (College football). Robert L. Scribner. Exposition Press. 386 Fourth Avenue, New York 16. Pp. 191. \$3.00.

FOOTBALL FUNDAMENTALS, John F. Bateman and Paul V. Governali. McGraw-Hill, 330 West 42nd Street, New York 36. Pp. 290. \$5.95.

GETTING READY FOR CHRISTMAS. Arts Cooperative Service, 322 East 23rd Street, New York 10. Pp. 32. Paper \$.75.

GUIDE TO VISUAL AIDS FOR PHYSICAL EDUCATION SPORTS AND RECREATION—1958. Athletic Institute, 209 South State Street, Chicago 4. Pp. 45. Free.

GUNS IN YOUR SCHOOL (Reprint), G. E. Damon. National Association of Sec-

ondary-School Principals, 1201 Sixteenth Street, N.W., Washington 6. Pp. 6. Free.

HANDBALL—ITS PLAY AND MANAGEMENT, B. E. Phillips. Ronald Press, 15 East 26th Street, New York 10. Pp. 72. \$2.95.

HANDBOOK OF ORNAMENT, Franz Sales Meyer. Dover Publications, 920 Broadway, New York 10. Pp. 548. Paper \$2.00.

HOLIDAY PLAYS FOR LITTLE PLAYERS (Royalty-free plays for children). Deborah Newman. Plays, Inc., 8 Arlington Street, Boston 16. Pp. 286. \$4.00.

MAGIC HOUSE OF NUMBERS (Riddles, tricks, and games), Irving Adler. John Day, 62 West 45th Street, New York 36. Pp. 128. \$2.95.

ONE-ACT-PLAYS: BETWEEN YESTERDAY AND TOMORROW (Japan), Vern Rossman; DARK PLACES, THE (Prejudice), Mae Hurley Ashworth; FEVER-HEART (Japan). Raymond Jennings. Friendship Press, 257 Fourth Avenue, New York 10. Pp. 31 each. \$.50 each.

PAPER SCULPTURE AND CONSTRUCTION, J. V. Miller. Charles A. Bennett Company, 237 North Monroe Street, Peoria, Illinois. Pp. 56. Paper \$1.50.

RECREATION CLUB LEADERSHIP OF, BY AND FOR THE HANDICAPPED—First Annual Conference. Connecticut Society for Crippled Children and Adults, 740 Asylum Avenue, Hartford 5, Connecticut. Pp. 20. \$.50.

RETIREMENT: A NEW OUTLOOK FOR THE INDIVIDUAL, Gifford R. Hart. Harcourt, Brace, 383 Madison Avenue, New York 17. Pp. 179. \$3.95.

SEVENTEEN PARTY BOOK, THE, Enid A. Haupt. J. B. Lippincott Company, East Washington Square, Philadelphia. Pp. 207. \$2.75.

TEEN-AGE PLAYS FOR ALL OCCASIONS (Royalty-free, one act plays), Mildred Hark and Noel McQueen. Plays, Inc., 8 Arlington Street, Boston 16. Pp. 463. \$5.00.

WEE TREE'S CHRISTMAS, THE, James W. Hatch, Box 409, Kinderhook, New York. Pp. 55. \$2.50 (also available in Facil-I-Telformat, \$10.00; pageant form, \$.50; and color pads, 25 for \$2.00).

WILDLIFE CAMERAMAN, Jim Kjelgaard. Holiday House. 8 West 13th Street, New York 11. Pp. 218. \$2.75.

WONDERFUL WORLD OF THE SEA, THE, James Fisher. Garden City Books, Garden City, New York. Pp. 68. \$2.95.

## INDEX OF ADVERTISERS

|                                         | PAGE               |
|-----------------------------------------|--------------------|
| All-American Table Tennis               | 337                |
| American Playground Device Company      | 315                |
| Beltz Engineering Laboratories          | 337                |
| California State Personnel Board        | 337                |
| Castello Fencing Equipment              | 313                |
| Chicago Roller Skate Company            | Outside Back Cover |
| El Cajon Civil Service Commission       | 337                |
| Exposition Press                        | 337                |
| Greenwich Book Publishers               | 315                |
| H. & R. Manufacturing Company           | 313                |
| Harvard Table Tennis Company            | 309                |
| Jamison Manufacturing Company           | 337                |
| Jayfro Athletic Supply Company          | 315                |
| The MacGregor Company                   | 330                |
| Monroe Company                          | 340                |
| New York University School of Education | 334                |
| Newcomb Audio Products Company          | 314                |
| Nissen Trampoline Company               | 327                |
| Parks & Recreation                      | 330                |
| The Ronald Press Company                | 339                |
| Skating Reporter                        | 337                |
| James Spencer & Company                 | 337                |
| Square Dance Associates                 | 339                |
| Superior Industries Corporation         | 337                |
| I. F. Twardzik & Company                | 315                |
| Vogel-Peterson Company                  | 315                |
| Voit                                    | 339                |
| X-acto, Inc.                            | 315                |

## Biblical Costumes for Church and School

**Virginia Wilk Elicker.** Put a true biblical atmosphere into your church and school religious plays! Practical book reveals the authentic dress of characters from the Old and New Testaments, gives informative historical background. Shows how to select materials, cut patterns, make costumes inexpensively. *25 ills.* \$3.00

## Creative Play Acting

**Isabel B. Burger.** Working guide to creative drama for directors in schools, recreation centers, camps for children 8 to 18. Book tells how to organize projects; gives A-to-Z instructions ranging from pantomime to producing the finished play. Includes acting exercises, 3 complete plays, tips on costuming, etc. *18 ills.* \$3.25

## Let's Celebrate Christmas

**Horace J. Gardner.** Fun for the whole Christmas season! Book gives details on parties, plays, legends, carols, poetry, stories—all filled with the spirit of Christmas. Includes menus, recipes, games, quizzes, decoration tips, etc., that bring St. Nick to the school, community, and family. *7 ills., 15 musical scores.* \$3.50

## It's Fun to Make Things

**Martha Parkhill and Dorothy Spaeth.** Show your children the pleasure of creative work! Practical book tells youngsters how to make things from wood, tin, leather, paper, etc. Gives information on costs, materials, tools, specifications. Includes actual size patterns, photos of the finished product. *158 ills.* \$3.25

## The Book of Games for Boys and Girls

**Evelyne Borst.** How to instill leadership qualities in children through constructive play! Book details indoor games for the classroom, clubroom, home, gymnasium, as well as games for the playground. Includes games for holidays, games with and without equipment. *36 ills.* \$4.00

Order your books from:

THE RONALD PRESS COMPANY • 15 E. 26th St., New York 10

## SQUARE DANCE ASSOCIATES

Freeport, N. Y.



Expert Oral  
Instructional  
Records for  
**SQUARE DANCES  
COUPLE DANCES  
AND MIXERS**

for all ages

Simple progressive

**TALK-THRU  
WALK-THRU**

method used in thousands  
of schools

FOOT TAPPING MUSIC

- Rhythms
- Folk Dances
- Singing Games
- Play Party Games

**FOR CHILDREN**

pre-kindergarten  
through 3rd grade

78 or 33 1/3 rpm

Mail coupon for  
FREE descriptive brochure.

SQUARE DANCE ASSOCIATES  
BOX 644 FREEPORT, N. Y.

Name \_\_\_\_\_

Address \_\_\_\_\_

City \_\_\_\_\_

State \_\_\_\_\_

AMERICA'S FINEST ATHLETIC BALLS

FOR EVERY AGE GROUP,  
PRICE OR SKILL —

**VOIT**  **GOES WITH THE GAME**

NEW YORK 11  
CHICAGO 11  
LOS ANGELES 11

# NEW

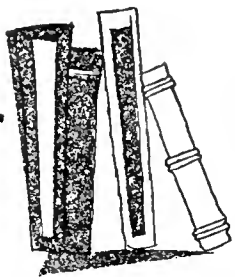

# PUBLICATIONS

*Covering the Leisure-time Field*

## Oil Painting

James Bateman. Studio Publications, 432 Fourth Avenue, New York 16. Pp. 96. \$6.50.

A painter of distinction adds a book to the "Studio How to Do It Series." This is for the student beginner who has previously been concerned with drawing. Mr. Bateman reveals his own approach to painting and many valuable tips.

He gives the evolution of painting from primitive times to the present day and provides practical advice on the simple technical aspects of oil painting. Color plates and black and white prints of famous paintings form the illustrations.

## FOR YOUR CHILDREN'S CORNER (Add these in Book Week!)

*The Wee Tree's Christmas*, James W. Hatch, Box 409, Kinderhook, New York. Pp. 55. \$2.50 (also available in Facil-I-Tel format, \$10.00; pageant form, \$.50; and color pads, 25 for \$2.00).

This book was written by someone who has worked with children's groups for many years. Delightful illustrations add much to a new and entertaining Christmas story. An attractive gift book.

*The Craziest Halloween*, Ursula von Hippel. Coward-McCann. 210 Madison Avenue, New York 16. Pp. 16. \$2.00.

Although it is past time for reviewing a Halloween story, we *must* mention this charming little book. It is about a little witch who has to wait until she is old enough to ride a broom. Weeny was four hundred years old but had another hundred to go. Clever illustrations.

*The Butterflies Come*, Leo Politi. Charles Scribner's Sons, 597 Fifth Avenue, New York 17. Pp. 16. \$2.75.

This brightly illustrated story not only makes an attractive book, but has merit in its own right. It is about the annual coming of a cloud of Monarch butterflies to the Monterey Peninsula in California and the adventures of two children during their visit.

*Terry's Ferry*, Marion Belden Cook. E.

P. Dutton & Co., Inc., 300 Fourth Avenue, New York 10. Pp. 45. \$2.50.

A tale of a small boy with a boat is always fun. This one is no exception. and, in addition, is filled with the suspense and excitement of circus time when Terry meets the performers. Illustrated in color.

## Games to Build\*

Bays Clubs of America, 381 Fourth Avenue, New York 16, New York, Pp. 96. Paper \$2.00.

This spiral-bound booklet solves the problem of how to provide simple, sturdy games for gameroom programs and, at the same time, offers the craft or woodworking department an opportunity to make excellent, useful projects. It gives simple, clear directions for making a number of board games, box games, floor and wall games, game tables and puzzles. Directions for each include information as to age-group, cost, time to make, materials needed, instructions for making and for playing. Construction plans are clear, and a sketch shows the finished project.

The book does not quarrel with commercial games; there are many fine ones. Unfortunately, many commercial games are designed more for home use than for the rigorous wear and tear

they get in a community center or club gameroom. Also budgets often do not permit the purchase or the replacement of many games and gameboards. Here, this book will be valuable in increasing the variety of games on hand, and, at the same time, providing sturdy, long-lasting ones. Highly recommended. The sixty-four projects have all been made and tested.

## How to Make a Miniature Zoo\* (Revised edition)

Vinson Brown. Little, Brown & Company, 34 Beacon Street, Boston 6. Pp. 212. \$2.75.

Anyone who has read the author's two books, *Amateur Naturalist's Handbook*, and *How to Make a Home Nature Museum*, will want to add this to the collection. It should be very useful to camp counselors who wish not only to encourage the study of wild life but also to protect it. Playground or club leaders and parents of boys and girls at the collecting age will find themselves using it frequently.

We might add that an excellent feature of this book is the fact that it does not deal exclusively with Eastern wildlife. Mr. Vinson is a native of the West Coast; therefore he includes species of wildlife native to the West, as well as the East.

The information on how to house, feed, care for and observe insects, spiders, fish, frogs, reptiles, mice, birds and the like is presented accurately and sympathetically.

## Forms and Patterns in Nature

Wolf Strache. Pantheon Books, 333 Sixth Avenue, New York 14. Pp. 22 (plus 88 full-page plates). \$7.50.

Looking for a new design? This beautiful publication is for those who love beauty of form and pattern, who use it either in an art or craft or who just enjoy looking at it. The rhythmic patterns of nature are presented in a series of unique and striking photographs, one to a page. The magnificent designs inherent in ice formation on a river, reflections on moving water, Sahara sand dunes, cracks in dry mud, polished agate, star tracks, leaves, shells, lightning, peacock feathers, tropical fish and other natural phenomena, make up the book. Each page is a photographic masterpiece, and a detailed list of plates provides a scientifically accurate description of each subject. Other printed matter consists only of titles and preface. Add this to your crafts or art library; place it high on your list of gift books!

\* Available from the NRA Recreation Book Center, 8 West Eighth Street, New York 11.

# Recreation Leadership Training Courses

Sponsored by the National Recreation Association

and

Local Recreation Agencies

**November, December 1957, January, 1958**

|                                       |                                                               |                                                                                         |
|---------------------------------------|---------------------------------------------------------------|-----------------------------------------------------------------------------------------|
| HELEN M. DAUNCEY<br>Social Recreation | Albuquerque, New Mexico<br>and adjacent areas<br>November 4-8 | Dr. Armond H. Seidler, The University of New Mexico, Albuquerque                        |
|                                       | El Dorado, Arkansas<br>November 11-14                         | Mrs. W. B. Watkins, Director, TAC House, El Dorado                                      |
| RUTH G. EHLERS<br>Social Recreation   | State of Vermont<br>November 5-14                             | Mrs. A. O. Brungardt, Vermont Director of Recreation, Montpelier                        |
| GRACE WALKER<br>Creative Recreation   | Poughkeepsie, New York<br>January 13-16                       | Rupert J. Tarver, Jr., William W. Smith Community Center, Poughkeepsie                  |
|                                       | Bozeman, Montana<br>January 20-24                             | Miss Geraldine G. Fenn, Associate State 4-H Club Leader, Montana State College, Bozeman |
| FRANK A. STAPLES<br>Arts and Crafts   | Industry, New York<br>December 9-12                           | John B. Costello, Superintendent, State Agricultural and Industrial School, Industry    |

Miss Dauncey will be conducting social recreation courses at the following Air Force Bases: January 13-16, Keesler Air Force Base, Biloxi, Mississippi, (for further details, communicate with the Air Force Regional Representative, Wayne Shields, USAF Office of Community Services, University of Georgia, Athens); January 20-23, Lackland Air Force Base, San Antonio, Texas; January 27-30, Sheppard Air Force Base, Wichita Falls, Texas, (for further details, communicate with the Air Force Regional Representative, Ray Morrison, 248 Casa Blanca, Fort Worth 7, Texas).

Mr. Staples will be at the following Air Force Bases conducting two-week arts and crafts courses: November 4-14, Warren Air Force Base, Cheyenne, Wyoming; November 18-28, Lowry Air Force Base, Denver, Colorado; January 6-16, Chanute Air Force Base, Rantoul, Illinois; January 20-30, Scott Air Force Base (near St. Louis, Missouri). For further details, communicate with the Air Force Regional Representative, Howard Beresford, 3055 Bellaire, Denver, Colorado.

Attendance at training courses conducted by National Recreation Association leaders is usually open to all who wish to attend. For details as to location, contents of the course, registration procedure and the like, communicate with the sponsor of the course as listed above.

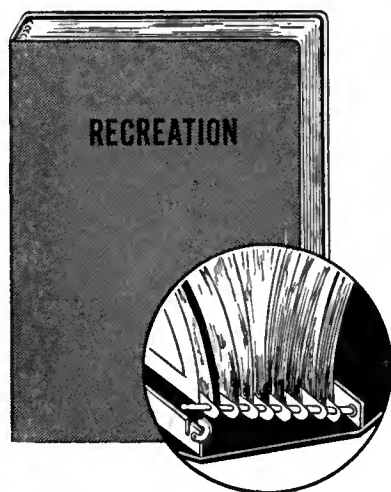

**Order NOW and SAVE!**

## BINDERS for *Recreation*

- Blue heavy simulated leather stamped in gold
  - Each holds one year's issues
  - Opens flat for changes
- 1954, 1955, 1957, 1958 and Undated

**\$3.00 each**

After January 1, 1958 the price will be \$3.50

RECREATION MAGAZINE, 8 West Eighth Street, New York 11

# Space for 10 or 210?



they *All* can have *Active* fun in your gym

Roller skating is more fun than a barrel of monkeys, and it entertains and exercises more people in less space than any other sport.

Little equipment is needed, little supervision is necessary.

That's why more and more schools are making roller skating a definite part of their physical education and recreation programs.

## NEW RUBBER-PLASTIC WHEELS ARE KIND TO GYM FLOORS

These new Duryte rubber-plastic wheels outwear others and are guaranteed not to mar or scratch the floors. "Chicago" has a skate designed for any type of floor surface or finish. Write today for free details on roller skating programs and skating equipment.

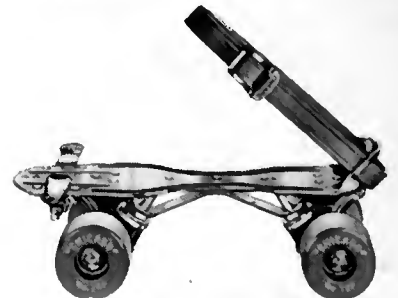

**"CHICAGO"**

*Roller Skates*

Digitized by Microsoft®

Chicago Roller Skate Co., 4490-K W. Lake Street, Chicago 24, Ill.

Peiffer Library  
MacMurray College  
Jacksonville, Illinois

DEC 12 19

# Recreation



# Let Us Remember . . .



“The old message ‘For unto you is born this day in the city of David a Saviour which is Christ the Lord’ is still the heart of Christmas . . . . And this message can neither be changed nor quite forgotten although there are many things that tend to make us forget.”

—Peter Marshall

Let us remember the true meaning of Christmas and lift our voices with those of the angel host, “Peace on earth, good will to men.”

. . . . .

## To all a true and beautiful Christmas

from the

### National Recreation Association

and

### *Recreation Magazine*





Save  
Time  
and  
Money!

Leased **FREE!**

Stop wasting time recording inventory costs, handing out balls and paying top prices for low quality balls. Install this attractive, cost-cutting TFT Table Tennis Ball Meter NOW!

Leased FREE to responsible agencies on \$10.00 deposit subject to refund. Trouble-free operation assured—return machine for FREE repair. Attractive hard wood and metal cabinet—7½ x 8½ x 15 inches high. Easy to install. Holds 120 balls—dispenses each for 10¢. Choice of 3 grades of top quality balls. Use profit to maintain and replace paddles, nets, etc. No risk guarantee. Send for free folder: "Stop Wasting Their Time."

**T. F. TWARDZIK & CO.,**  
INCORPORATED  
SHENANDOAH, PENNA.



## The famous Golden Guides to Nature and Science

PAPERBOUND, EACH \$1.00 NET

IN GOLDEN CRAFT DELUXE LIBRARY BINDING, EACH \$2.50 NET

Here are the 13 books in a series that is widely acclaimed for its accuracy, beauty, and remarkable value.

Each Golden Guide (size 4½ x 6¼) contains 112 to 475 superb color pictures. Each is prepared by some of the country's outstanding naturalists to help children (5th grade up) and adults understand and enjoy one aspect of the natural world around us.

A new guide to ROCKS AND MINERALS has just been added to the series, and it will fascinate readers of all ages.

Use the coupon below to order these Golden Guides in the regular paperbound edition or in Golden Craft Deluxe School-and-Library Binding.

**WEATHER.** A guide to wind, storm, rain, clouds, snow, hail, etc. Forecasting. By Dr. H. S. Zim, Dr. R. W. Burnett, Paul E. Lehr. 300 color pictures and diagrams by Harry McNaught.

**FISHES.** Superb color plates illustrate hundreds of facts about American fresh and salt-water species. By Dr. H. S. Zim and Dr. Hurst H. Shoemaker. Pictures by James Gordon Irving.

**BIRDS.** Identifies 265 species; 112 full-color plates; 128 silhouettes, range maps. Endorsed by Audubon Society. By Dr. Herbert S. Zim and Dr. I. N. Gabrielson. Illustrated by J. G. Irving.

**STARS.** A guide to the constellations, sun, moon, planets, meteors, comets, 150 color paintings, constellation maps. By Dr. H. S. Zim and Dr. R. H. Baker. Pictures by James Gordon Irving.

**FLOWERS.** 134 paintings, arranged by color for quick reference, show 200 wild flowers. Range maps. By Dr. Herbert S. Zim and Dr. Alexander C. Martin. Illustrated by Rudolf Freund.

**INSECTS.** 225 species in full-color. Habitat pictures, structure diagrams, range maps. By Dr. Herbert S. Zim and Dr. Clarence Cottam. Illustrations by James Gordon Irving.

**TREES.** Leaf-shape Key identifies 150 species. Over 100 full-color plates. Tips on tree-study. By Dr. Herbert S. Zim and Dr. Alexander C. Martin. Illustrated by Dorothea and Sy Barlowe.

**REPTILES AND AMPHIBIANS.** Full-color paintings identify 212 species (from snakes to salamanders). Range maps. By Dr. H. S. Zim and Dr. H. M. Smith. Illustrated by J. G. Irving.

**SEASHORES.** A guide to shells, sea plants, shore birds, ocean currents, geology, marine life. By Dr. Herbert S. Zim and Dr. Lester Ingle. 475 color paintings by D. and S. Barlowe.

**MAMMALS.** Hundreds of color pictures and descriptions of familiar American species. Range maps. By Dr. H. S. Zim and Dr. Donald F. Hoffmeister. Illustrated by J. G. Irving.

**AMERICAN SOUTHWEST.** Geography, history, Indian culture, plants, animals, geology of our Southwest. By N. N. Dodge and Dr. H. S. Zim. Color pictures by Miriam and Arch Hurford.

**PHOTOGRAPHY.** For the beginning photographer whatever his age or camera. By Dr. Herbert S. Zim and Dr. R. Will Burnett. With diagrams and drawings by H. Wartik and H. McNaught.

**ROCKS AND MINERALS.** Color pictures of over 400 minerals, gems, ores, rocks. Identification tests, explanation of origins. By Dr. H. S. Zim and Dr. P. R. Shaffer. Pictures by Raymond Perlman.

Order from your Bookseller, Recreation Book Center, or SIMON AND SCHUSTER, Educational Division Dept. REC. 136 W. 52nd St., New York 19, N. Y.

Please send me—for free examination—the Golden Nature Guides I have checked at the right. If not delighted, I may return my purchase within 14 days. Otherwise you will bill me for the cost of the books, plus few cents postage.

NAME.....

ADDRESS.....

CITY..... STATE.....

SAVE. If you enclose remittance WE pay postage. Same return privilege applies.

Regular Edition \$1.00  
DeLuxe Binding \$2.50

Regular Edition \$1.00  
DeLuxe Binding \$2.50

| Weather            | Seashores          |
|--------------------|--------------------|
| Fishes             | Mammals            |
| American Southwest | Rocks and Minerals |
| Stars              | Birds              |
| Flowers            | Photography        |
| Insects            | Reptiles           |
| Trees              |                    |

Help Fight TB



Buy Christmas Seals

# NATIONAL RECREATION ASSOCIATION

*A Service Organization Supported by Voluntary Contributions*

JOSEPH PRENDERGAST, *Executive Director*



## OFFICERS

F. W. H. AOAMS ..... *Chairman of the Board*  
 GRANT TITSWORTH ..... *First Vice-President*  
 SUSAN M. LEE ..... *Second Vice-President*  
 MRS. WM. L. VAN ALEN ..... *Third Vice-President*  
 AORIAN M. MASSIE ..... *Treasurer*  
 JOSEPH PRENDERGAST ..... *Secretary*

## BOARD OF DIRECTORS

|                         |                      |                        |                     |
|-------------------------|----------------------|------------------------|---------------------|
| F. W. H. AOAMS          | New York, N. Y.      | MRS. CHARLES V. HICKOX | Michigan City, Ind. |
| F. GREGG BEMIS          | Boston, Mass.        | SUSAN M. LEE           | New York, N. Y.     |
| MRS. ROBERT WOODS BLISS | Washington, D. C.    | FREDERIC R. MANN       | Philadelphia, Pa.   |
| MRS. ROLLIN BROWN       | Los Angeles, Calif.  | HENRY W. MEERS         | Chicago, Ill.       |
| HOWARD H. CALLAWAY      | Hemilton, Co.        | WILLIAM C. MENNINGER   | Topeka, Kan.        |
| HODDING CARTER          | Greenville, Miss.    | CARL E. MILLIKEN       | Augusta, Me.        |
| MRS. ARTHUR C. CUMMER   | Jacksonville, Fla.   | PAUL MOORE, JR.        | Indianapolis, Ind.  |
| HARRY P. DAVIDSON       | New York, N. Y.      | MRS. RUTH E. PEELER    | Seattle, Wash.      |
| RICHARD A. DOUGHERTY    | New York, N. Y.      | JOSEPH PRENDERGAST     | New York, N. Y.     |
| JAMES H. EVANS          | Bronxville, N. Y.    | MRS. RICHARD E. RIECEL | Montebasin, Del.    |
| RICHARD A. FARNSWORTH   | Houston, Tex.        | WILLIAM S. SIMPSON     | Bridgeport, Conn.   |
| MRS. HOWARD A. FRAME    | Los Altos, Calif.    | EDGAR W. SMITH         | Portland, Ore.      |
| MRS. PAUL C. GALLAGHER  | Omaha, Nebr.         | GRANT TITSWORTH        | Noroton, Conn.      |
| ROBERT GARRETT          | Baltimore, Md.       | MRS. WM. L. VAN ALEN   | Edgemont, Pa.       |
|                         | FREDERICK M. WARBURC |                        | New York, N. Y.     |

## HEADQUARTERS STAFF

|                                                                                                          |                                                                                     |                                                                                                                     |
|----------------------------------------------------------------------------------------------------------|-------------------------------------------------------------------------------------|---------------------------------------------------------------------------------------------------------------------|
| <b>Executive Director's Office</b><br>ARTHUR WILLIAMS    ALFRED H. WILSON                                | <b>Personnel Service</b><br>WILLARD C. SUTHERLAND    MARY GUBERNAT                  | <b>Area and Facilities Planning and Surveys</b><br>G. LESLIE LYNCH                                                  |
| <b>Field Department</b><br>CHARLES E. REED    WILLARD B. STONE<br>JAMES A. MADISON                       | <b>Program Service</b><br>VIRGINIA MUSSELMAN                                        | <b>Katherine F. Barker Memorial Secretary for Women and Girls</b><br>HELEN M. DAUNCEY                               |
| <b>Research Department</b><br>GEORGE D. BUTLER    MURIEL E. MCGANN<br>RUTH MACKLER                       | <b>Recreation Magazine</b><br>DOROTHY DONALDSON    AMELIA HENLY                     | <b>Recreation Leadership Training Courses</b><br>RUTH EHRLER    ANNE LIVINGSTON<br>FRANK A. STAPLES    GRACE WALKER |
| <b>Service to Federal and State Agencies</b><br>GEORGE E. DICKIE                                         | <b>Special Publications</b><br>ROSE JAY SCHWARTZ    FRANK J. ROWE<br>MARY E. HOLMES | <b>Hospital Recreation Consultant Service</b><br>BRATEICK H. HILL                                                   |
| <b>Correspondence and Consultation Service and International Recreation Service</b><br>GEORGE A. NARBITT | <b>Work with Volunteers</b><br>MARY QUIRK    ELIZABETH SHINE<br>HAROLD WILCOX       | <b>Public Information and Education</b><br>ANNE L. NEW    BETTY BUNN<br>DAVID J. DUBOIS                             |

## DISTRICT REPRESENTATIVES

|                                                                                                                                     |                                                                                               |                                                                           |
|-------------------------------------------------------------------------------------------------------------------------------------|-----------------------------------------------------------------------------------------------|---------------------------------------------------------------------------|
| <b>New England District</b><br>WALDO R. HAINSWORTH, Northbridge, Mass.<br>RICHARD A. TAPPY, Bristol, N. H.                          | <b>Southern District</b><br>WILLIAM M. HAY, Decatur, Ga.<br>RALPH VAN FLEET, Clearwater, Fla. | <b>Southwest District</b><br>HAROLD VAN ARSDALE, Dallas, Tex.             |
| <b>Middle Atlantic District</b><br>RICHARD S. WESTGATE, Temple, Pa.                                                                 | <b>Midwest District</b><br>ARTHUR TODD, Kansas City, Mo.<br>HAROLD W. LATHROP, Denver, Col.   | <b>Pacific Northwest District</b><br>WILLARD H. SHUMARD, Seattle, Wash.   |
| <b>Great Lakes District</b><br>C. E. BREWER, Detroit, Mich.<br>ROBERT L. HORNET, Madison, Wis.<br>DAVID M. LANCKAMMER, Toledo, Ohio |                                                                                               | <b>Pacific Southwest District</b><br>JOHN J. COLLIER, Los Angeles, Calif. |

### Affiliate Membership

Affiliate membership in the National Recreation Association is open to all non-profit private and public organizations whose function is wholly or primarily the provision or promotion of recreation services or which include recreation as an important part of their total program and whose cooperation in the work of the Association would, in the opinion of the Association's Board of Directors, further the ends of the national recreation movement.

### Active Associate Membership

Active associate membership in the National Recreation Association is open to all individuals who are actively engaged on a full-time or part-time employed basis or as volunteers in a nonprofit private or public recreation organization and whose cooperation in the work of the Association would, in the opinion of the Association's Board of Directors, further the ends of the national recreation movement.

### Contributors

The continuation of the work of the National Recreation Association from year to year is made possible by the splendid cooperation of several hundred volunteer sponsors throughout the country, and the generous contributions of thousands of supporters of this movement to bring health, happiness and creative living to the boys and girls and the men and women of America. If you would like to join in the support of this movement, you may send your contribution direct to the Association.

The National Recreation Association is a nationwide, nonprofit, nonpolitical and nonsectarian civic organization, established in 1906 and supported by voluntary contributions, and dedicated to the service of all recreation executives, leaders and agen-

cies, public and private, to the end that every child in America shall have a place to play in safety and that every person in America, young and old, shall have an opportunity for the best and most satisfying use of his expanding leisure time.

*For further information regarding the Association's services and membership, please write to the Executive Director, National Recreation Association, 8 West Eighth Street, New York 11, New York.*

# Recreation\*



THE MAGAZINE OF THE RECREATION MOVEMENT

*Editor in Chief*, JOSEPH PRENDERGAST  
*Editor*, DOROTHY DONALDSON  
*Editorial Assistant*, AMELIA HENLY  
*Business Manager*, ALFRED H. WILSON

ASSOCIATE EDITORS  
*Recreation Administration*, GEORGE BUTLER  
*Program Activities*, VIRGINIA MUSSELMAN

Vol. L. Price 50 Cents No. 10

**On the Cover**

AT CHRISTMAS. The tradition of the Christmas tree brings us the piney fragrance of the woods and the gay gleam of colored Christmas balls in the depths of its dark green boughs. It adds bright warmth and loveliness to our homes in this most beautiful of seasons. Cover design courtesy Condie Lamb, New York City.

**Next Month**

The January issue of RECREATION will bring you new leaves to turn for the new year. Each article will present a different phase of recreation for your consideration or review, as for instance: "Your Office—Its Importance in Your Job"; "The Superintendent's Code of Principles for 1958"; "Let's Take a Look at Our Standards"; "Research in Action"; "Plan that New Art and Craft Room"; "A Citizens' Theatre" (do you have one?). We hope each leaf will be useful in the year to come.

**Photo Credits**

Inside front cover, Condie Lamb, New York City; page 340, 352 (right), 353 (left and right), and 368-9, Jasper Nutting and Marshall La Cour, Long Beach, California; 346, Sun Valley, Idaho, News Bureau; 349, Harry Merrick, Long Beach, California; 356 and 377 (upper left), *News Tribune*, Tacoma, Washington; 357 (center and lower right), *The New York Times*; 360 (left), Moody's Studio, Bristol, New Hampshire, (right), Rappoport Studios, New York City; 366, Cleanliness Bureau, New York City.

RECREATION is published monthly except July and August by the National Recreation Association, a service organization supported by voluntary contributions, at 8 West Eighth Street, New York 11, New York, is on file in public libraries and is indexed in the *Readers' Guide*. Subscriptions \$4.00 a year. Canadian and foreign subscription rate \$4.50. Re-entered as second-class matter April 25, 1950, at the Post Office in New York, New York, under Act of March 3, 1879. Acceptance for mailing at special rate of postage provided for in Section 1103, Act of October 3, 1917, authorized May 1, 1924. Microfilms of current issues available University Microfilms, 313 N. First Street, Ann Arbor, Michigan.

*Space Representatives*: Mark Minahan, 168 North Michigan Avenue, Chicago, Illinois; Seymour A. Robbins & Associates, 101 West 55th Street, New York 19, New York; The Jules E. Thompson Company, 681 Market Street, San Francisco 5, California.

Copyright, 1957, by the National Recreation Association, Incorporated

Printed in the U.S.A.



\* Trade mark registered in U. S. Patent Office.

**CONTENTS**

**GENERAL FEATURES**

Christmas . . . 1957 (Editorial) . . . . . *Robert E. Kresge* 346  
 The Recreation Congress Story . . . . . *Dorothy Donaldson* 349  
 Congress Briefs . . . . . 354  
 Season in the Snow . . . . . 356  
 What is the Point of Sport? . . . . . *Arnold Kaech* 358  
 Recreation, Medicine and the Humanities . . . . . *Joseph B. Wolfe, M.D.* 364  
 Scenes from the Thirty-Ninth Congress . . . . . 368

**ADMINISTRATION**

"Grass Roots" Recreation . . . . . *Charles H. Odegaard* 362  
 Recreation Education in the World of Higher Learning . . . . . *Charles K. Brightbill* 374  
 Notes for the Administrator . . . . . 376  
 Research Notes . . . . . *Muriel E. McGann* 378  
 Personnel—Current Comments . . . . . *W. C. Sutherland* 379

**PROGRAM**

Christmas Customs in Many Lands . . . . . 359  
 Last Minute Holiday Hints . . . . . 366  
 Christmas Tour for Golden-Agers . . . . . 367  
 Techniques of Ski Teaching . . . for Beginners' Groups . . . 370  
 Printing with Plaster of Paris (How To Do It!) . . . . . *Frank A. Staples* 372  
 Santa Goes to School . . . . . 373

**REGULAR FEATURES**

Letters . . . . . 344  
 Things You Should Know . . . . . 348  
 Reporter's Notebook . . . . . 360  
 Personnel . . . . . See Administration  
 On the Campus . . . . . 381  
 Hospital Capsules . . . . . *Beatrice H. Hill* 382  
 Market News . . . . . 384  
 Books and Pamphlets Received, Magazine Articles . . . . . 385  
 Index of Advertisers . . . . . 386  
 New Publications . . . . . 387  
 Index to Volume L . . . . . 389  
 Index of Advertisers and Exhibitors for 1957 . . . . . 394  
 Recreation Leadership Training Courses . . . Inside Back Cover

for every

RECREATION  
ACTIVITY

HI-FI

sound  
at low cost

R-16CV



**NEWCOMB**

- transcription player
- public address system

For every sound reproduction application in recreation halls, gyms, auditoriums, or summer camps, the Newcomb R-16CV does the job better, yet weighs less than 22 pounds. A separate microphone and phonograph volume control permits mixing recorded music with the microphone presentation. Variable speed control allows variable tempo and pitch (from any basic speed setting). A quality heat and humidity resistant high fidelity ceramic pickup is encased in a professional-type tone arm. Balanced-design amplifier with inverse feedback in combination with a fine ten-inch extended range speaker give quality you'd never expect at its price. Newcomb is the "sound of quality since 1937"... recognized by leading school authorities from coast to coast.



**NEWCOMB VARIABLE SPEED**  
Exclusive Newcomb design gives dependable continuously variable control at all 3 speeds.

**FREE CATALOG**

**NEWCOMB**  
Audio Products Co., Dept. Z-12  
6824 Lexington Av., Hollywood 38, Calif.

Send free catalog of Newcomb portable sound equipment.  
 Send name of our nearest Newcomb distributor.

Name \_\_\_\_\_  
Address \_\_\_\_\_  
City \_\_\_\_\_



**Readers!** You are invited to send letters for this page to Editor, RECREATION, 8 West Eighth Street, New York 11—so that your ideas, opinions and attitudes may be exchanged with others on the wide range of subjects of concern to us all. Here is your chance to agree or disagree with the authors of our articles. Keep letters brief—not more than 250 words.

—The Editors.

### Recreation Philosophy

Sirs:

The editorial by Colonel Roland E. Sliker in your October issue is of considerable interest to us in the Air Materiel Command. We have been one of the first commands to subscribe to the philosophy of a professional recreation manager for the air base under our control, and we are actively selling this philosophy to all of our commanders.

To further inform our commanders and recreation personnel in the field, we would like to reproduce Colonel Sliker's editorial in our own *Military Personnel Career Facts Bulletin*. This is our monthly publication devoted to keeping our military personnel informed on all matters pertaining to an Air Force career.

It will be appreciated very much if you will permit us to reproduce Colonel Sliker's editorial in our next issue. We are asking you for this authority since we would like to cite your publication as the source of our quotation.

EUGENE WEINLAND, *Chief, Personnel Services Branch, Military Personnel Division, Air Materiel Command, United States Air Force, Wright-Patterson Air Force Base, Ohio.*

### For Our Senior Citizens

Sirs:

The article "Adapting Dancing for Senior Citizens" by Cyrus S. Grossman in the October, 1957 issue inspires us to write to you expressing our deep appreciation for the outstanding work RECREATION has been doing in stimulating the recreation movement for senior citizens. During the past few years this magazine has given desirable emphasis to stimulating recreation directors to serve this growing segment of our population. We feel confident that much of

the recent interest by local recreation people in this field has been due in large measure to the stimulus received from your magazine.

Because this particular area of recreation is developing so rapidly, there is now an immediate need for (a) development of standards for recreation centers for the elderly; (b) the provision of model designs for the construction of such centers; (c) development of basic lists of equipment; (d) development of closer liaison between the recreation professionals and the adult education people; and (e) training of recreation personnel in dealing with human beings in their later years of life.

ALBERT J. ABRAMS, *Director, New York State Joint Legislative Committee on Problems of the Aging, Albany, New York.*

### Use for "Prunings"

Sirs:

In the parks of Wilmington, we have two very fine public rose gardens. It has recently been decided that, when these fine plants are pruned, the clippings will be laid on the ground in front of each plant and will then be collected in such a way that various small bundles of clippings will represent different plants. These packages will be distributed, gratis, through our Negro garden club for their members to plant in their yards or flower gardens.

I wrote to one of my friends in Cincinnati with regard to this idea, and here is a quote from his reply on the subject: "Your idea of making 'prunings' that would otherwise be wasted available without cost is a 'knockout.' I wonder how many park commissioners have been thoughtful enough to put such a plan into operation?"

MAURICE DUPONT LEE, *President, Board of Park Commissioners, Wilmington, Delaware.*



PLAY AREAS DO DOUBLE DUTY WITH

*Superior*

Folding Table Tennis Tables!

Superior tables can be stored compactly, can be opened for play in a jiffy . . . even rolled away on wheels by a youngster. Sturdy, rigid Superior MT1000 Table has edge-protecting METAL FRAME AND TUBULAR STEEL LEGS, HEAVY DOUBLE HARDWARE ON LEGS. Thousands used by playgrounds, camps, schools, military installations . . . wherever a heavy duty table is needed.

NEW! Optional Feature!

Roll-away casters make it easy to clear your floors.

POPULARLY PRICED! APPROVED BY USTTA.

Write for literature showing complete line of institutional table tennis tables.

*Superior* INDUSTRIES CORPORATION  
565 Barry Street, New York 59, N.Y.

WRITE FOR LITERATURE

AMERICAN APPROVED  
*Jim Patterson*  
**lifetime**  
**ALUMINUM**  
**DIVING BOARD**

*World's Finest Official Board*  
Rugged Aircraft Girder Construction, Unequaled in Design, Durability and Performance by any board built today.  
**Exclusive International Distributors**

**ICE WHEN YOU WANT IT**  
with **BELTEMP**  
artificial ice skating rinks by  
**BELTZ ENGINEERING LABORATORIES**  
11021 Whittier Avenue  
Detroit 24, Michigan. Venice 9-1811

**YOU CAN PUBLISH YOUR BOOK**  
Free brochure tells how we published 2000 books for authors. Free editorial appraisal. Write Dept. R 10  
**EXPOSITION PRESS / 386 4th Ave., N.Y. 16**

**AMERICAN**  
**PLAYGROUND DEVICE CO.**  
ANDERSON, INDIANA, U.S.A.  
WORLD'S LARGEST MANUFACTURERS OF FINE PARK, PICNIC, PLAYGROUND, SWIMMING POOL AND DRESSING ROOM EQUIPMENT

**RECREATION**

LAST CHANCE!  
Order NOW and SAVE!  
**\$3.00 each**  
  
\$3.50 after January 1, 1958

**Recreation BINDERS**  
1954, 1955, 1956, 1957, 1958 and Undated

- Blue heavy simulated leather stamped in gold
- Each holds one year's issues
- Opens flat for changes

**RECREATION MAGAZINE**  
8 West Eighth Street, New York 11

*the Management Journal*  
*Parks*  
**RECREATION**  
MAGAZINE

FOR:

- You
- Your Board
- Your City Officials
- Your Key Personnel
- Your Informed Lay Supporters

FOR PARK AND RECREATION SUPERINTENDENTS . . . techniques described by practical men in the field.  
BALANCED EDITORIAL FORMULA . . . the voice of the professional on land acquisition, design, construction, recreational usage, administration and maintenance . . . a complete coverage.  
A QUALITY PRODUCT . . . fine paper, printing, photos, maps and editorial approach.

PARKS & RECREATION . . . only national magazine designed for both park and recreation administrators.  
EACH MONTH . . . the most "referred to" publication in its field . . . a must for your reference library.  
ALL USABLE INFORMATION . . . no fiction, no "fairy tales" avidly read from cover to cover . . . send for your free sample and judge for yourself.

**SERVING THE PARK AND RECREATION FIELDS SINCE 1917.**

| SUBSCRIPTION RATES              |                      |
|---------------------------------|----------------------|
| One year                        | \$ 5.00              |
| Two years                       | 9.00                 |
| Three years                     | 13.00                |
| Groups of four or more—one year | 54.00 each per year. |

**PARKS & RECREATION**  
Department RN  
Oglebay Park  
Wheeling, West Virginia  
publisher



# Christmas...1957

Robert E. Kresge

The world has moved on from the simplicity of the first Christmas. There is no denying the fact that Christmas now takes a beating from the world of commerce. The steady din of Christmas music from store fronts and street corners, the endless sending of cards and buying of gifts, the emphasis on glitter and fancy wrappings—all of these, and more, tend to make of Christmas a holiday with emphasis on *things*, even though its origin is spiritual.

And yet, Christmas manages to surmount this exploitation and its results each year. It is simply too great an event to be diminished by little man. It always manages to make man bigger, by causing him to think more about the welfare of others. The more of this he does, the more of self he loses and the better he feels. And so is born the Christmas spirit, which is the opposite of selfishness.

The Christ Child, whose birthday this is, was born 1,961 years ago, in circumstances which never cease to touch our hearts; but that was just the beginning! The life of truth and grace that followed is the reason that Christmas is still observed. It was the origin of Christianity. The "Christmas Spirit" is strangely similar to the life of Christ on earth! It is only when we recall this fact that we realize the reality of Christmas.

Could it be that God chooses to ennoble us as we celebrate the birth of the infant Jesus?

*What comfort by Him do we win,  
Who made Himself the price of sin,  
To make us heirs of glory!*

*To see this Babe all innocence,  
A Martyr born in our defence,  
Can man forget the story?*

—BEN JONSON (1573-1637)

Yes, Christmas is a time of good feeling, of kindness and of love. It is the time for observing the ancient traditions of the season and the message, "Peace on earth, good will to men." That is the beauty of Christmas. Let us do as Mary did, and "ponder these things" in our hearts.

MERRY CHRISTMAS!

---

MR. KRESGE is superintendent of parks and recreation in Charleston, West Virginia.

AMERICA'S FINEST ATHLETIC BALLS

FOR EVERY AGE GROUP,  
PRICE OR SKILL —

**VOIT** <sup>amf</sup> **GOES WITH THE GAME**

NEW YORK 11  
CHICAGO 11  
LOS ANGELES 11

**FUN**

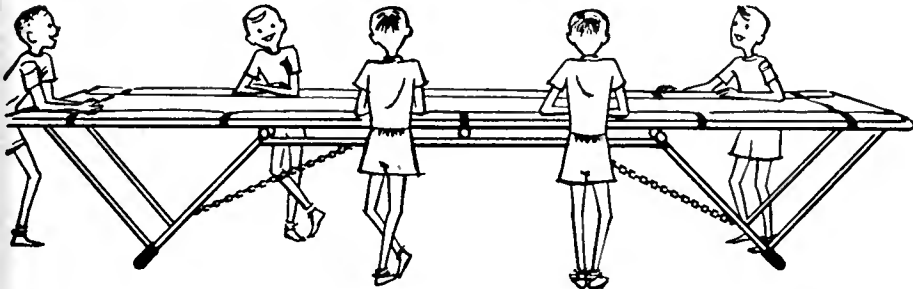
Ask any kid who's tried it. The Trampoline is fun.  
Always the favorite recreation at parks, classes or playtime.  
And it's such a good all-around conditioner.

*Is the Trampoline part of your recreation program?*

IF IT ISN'T A **NISSEN** IT ISN'T A TRAMPOLINE®

© Reg. U.S. Pat. Off.

**NISSEN TRAMPOLINE COMPANY** 200 A Avenue NW, Cedar Rapids, Iowa, U.S.A.

**New** 100% Aluminum  
EXTRA HEAVY DUTY

**Table Tennis Tables**

ESPECIALLY DESIGNED FOR HEAVY DUTY USE  
*Indoors or Outdoors*



Official Regulation SIZE and BALL BOUNCE

MADE IN 2 SECTIONS      4 LEGS TO EACH SECTION

Nationally recognized and used by the ARMED FORCES, COLLEGES, MUNICIPALITIES, RECREATION CENTERS, SCHOOLS, CLUBS, PARKS, etc.

MODEL #104 as above with stationary legs.      MODEL #106 8 sturdy snap in type folding legs.

- No Maintenance or Replacement Problems.
- Sturdy Lifetime Construction.
- SECURELY INSTALLED HEAVY GAUGE ALUMINUM CENTER NET

For FULL DETAILS WRITE      **ALL METAL TENNIS TABLE CO.**  
P.O. BOX 142, TEANECK, N.J.

**Exciting x-acto**  
**SUJI WIRE ART for GROUP ACTIVITY**

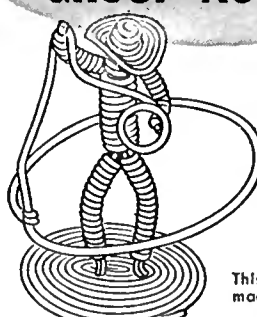

- Inexpensive!
- Fascinating!
- Simple-to-do!

This SUJI Cowboy made in minutes.

Just a few turns of colorful SUJI wire produces exquisite figure miniatures, ornaments, jewelry, party favors... the most excitingly new craft activity for individuals or groups. **INEXPENSIVE** ...less than 10¢ worth of materials for a simple project.

**SPECIAL GROUP OFFER**  
Try-it-yourself SUJI Sample Pack with a generous supply of wire, glue, tools and instructions ..... 25¢

**x-acto**

**X-ACTO, INC.**  
48-99 Von Dom Street  
Long Island City 1, N. Y.

●  
●  
●  
●  
●

## Things You Should Know . .

●  
●  
●

▶ **THE MITTEN TREE** and other popular winter projects have been altered by the American Friends Service Committee so as to be in line with new trends both overseas and in the USA. Additional service activities and other program materials are being developed. For further information, write to Educational Materials for Children, American Friends Service Committee, 20 South 12th Street, Philadelphia 5, Pennsylvania.

▶ **FEATURE STORIES** on recreation and related subjects are still appearing in popular magazines. Two appeared in *The Saturday Evening Post* in September. "They Befriend the Mentally Ill," by Steven M. Spencer, in the September 5 issue, told what warm-hearted volunteers from college campuses can do for mental patients in hospitals; while "Independent at Sixty-Five," by Arnold Nicholson, in the September 21 issue, was about special housing projects for older folks in New York State. Another, in *Redbook* in July, "The Most Rewarding Night of Our Week" by Jean Stewart with Arthur Gordon, tells a similar story of a young couple volunteering with the mentally ill.

▶ **WHAT VOLUNTEERS CAN DO** for a prison program is amply illustrated by the wide citizen support for a recreation program in the new state prison in Walpole, Massachusetts. This is reported in *Channels*, a publication of the National Publicity Council for Health and Welfare Services. More than eighty per cent of the prison population is engaged in a hobby program led by businessmen, doctors, lawyers, and school teachers, some of whom were among the strongest opponents of the institution.

▶ **UNITED STATES POPULATION** is now 170,981,000. The total population, including Armed Forces overseas, was about 170,981,000 on June 1, 1957, according to recent estimates by the Census Bureau. This figure represents an increase of 19,849,000, or 13.1 per cent, since April 1, 1950, the date of the last census, and a 3,047,000, or 1.8 per cent

increase over the estimate for June 1956.

▶ **FORMATION** of a new voluntary organization to stimulate international understanding through sponsorship of international projects in rehabilitation of the physically handicapped was announced recently. This is the world Rehabilitation Fund, Inc., of which Howard A. Rusk, M.D., who is well-known to many recreation people, is president. Its offices are at 400 East 34th Street, New York 16.

▶ **STARTLING FIGURES** from a recent Gallup Poll indicate that forty-five million Americans cannot swim—fourteen million of these are men. Swimming instructors, where are you? Sampling a cross-section of adults from coast to coast, the American Institute of Public Opinion discovered that seventy-seven per cent of the men and fifty-two per cent of the women have had the opportunity to learn. This leaves twenty-three per cent of the men and forty-eight per cent of the women still waiting for someone to help them.

▶ **THE FIRST STEP TOWARD A "NEW CONCEPT"** in legislation governing the recreation of some 30,000,000 Americans has been taken by the Outboard Boating Club of America with announcement of its new recommended Uniform Pleasure Boating Act. The suggested act, intended to serve as a guide for federal and state lawmakers studying possible enactment of new measures affecting boating, is the initial move in the compilation of an Omnibus Boating Code which will be offered as a broad master plan for recommended legislative regulation of the fast growing sport.

The existing federal boating law provides for a fine of \$2,000 and/or a jail term of one year for negligent or careless operation of a motorboat. The acknowledged harshness of present penalties has resulted in all but the most flagrant cases going unpunished. The new proposal would strengthen marine enforcement by addition of a less severe but more acceptable penalty by allowing

the court to order a violator off the water for up to two years.

### Materials Available

• Every community should have a public recreation service, according to "Public Recreation and Parks in California," released at the September San Francisco meeting of the State of California Recreation Commission. This is an eighty-page "do-it-yourself" guide for communities now establishing recreation park agencies and is available from the State Printing Office, Sacramento 14, at fifty cents plus a two-cent tax for California addresses.

• Parents and leaders interested in the development of wholesome attitudes in children will find a new leaflet, *Rearing Children to Meet the Challenge of Change*, very helpful for discussion and study purposes. It is written by Dr. Dan W. Dodson, director of the Human Relations Center in the School of Education, New York University. It is available free in quantities of less than a hundred, and at \$7.08 per hundred. Order from The National Conference of Christians and Jews, Inc., 43 West 57 Street, New York 19. ☆

## YOUR BEST CANCER INSURANCE . . .

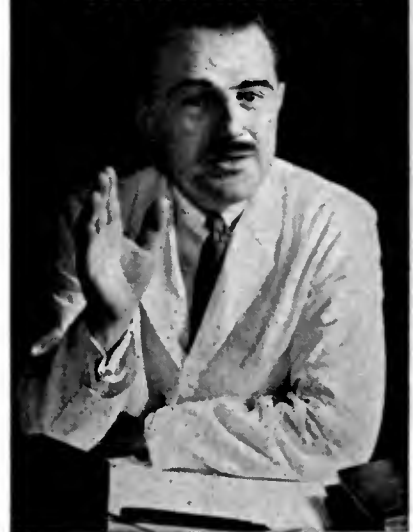

*a health checkup  
once a year  
every year . . .  
make it a habit  
... for life.*

American Cancer Society



# The RECREATION CONGRESS STORY

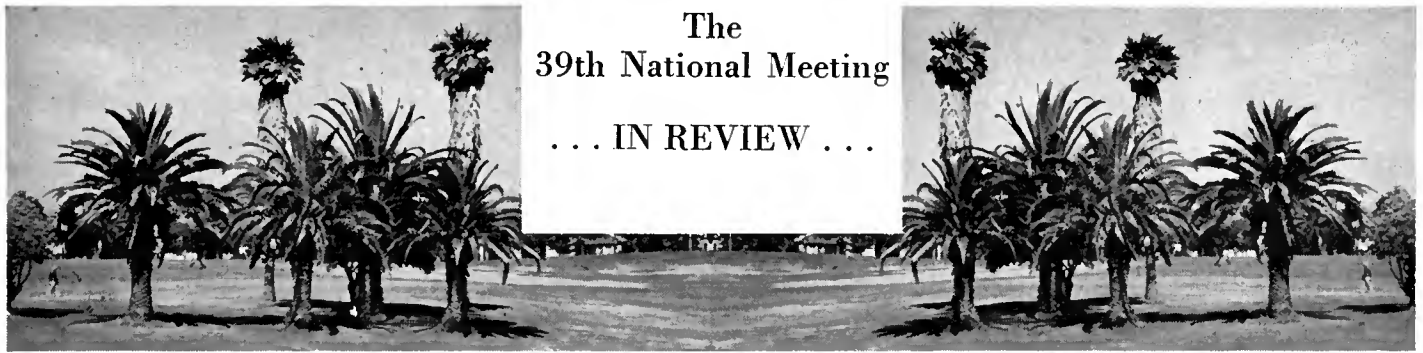

Dorothy Donaldson

**T**O GREET the nation's recreation leaders as they gathered in Southern California for the 39th National Recreation Congress, Long Beach flaunted its best weather—clear skies, dazzling sun and blue ocean. The vastness of the Pacific seemed to symbolize the wider horizons to be achieved at the meetings ahead. The tropical atmosphere was further enhanced by palm trees, gay flower gardens, and the trays of orchid corsages brought from Hawaii by Ethel Mori for the Congress banquet. (The latter reminded us of the Seattle Congress when Mrs. Manuel from Honolulu presented leis—and kissed the male guests in the process. Ah, these attractive Hawaiians!)

The beautiful weather held all week, to everyone's delight, for it was necessary to get from hotel to hotel in the fastest possible way—by scooter, skip, or Pogo stick. Through necessity, exhibits and large general meetings had to be held in the Municipal Auditorium by the sea, while other sessions were in the hotels, recreation center, and a high school—in as many different directions. In spite of this, recreation folks turned out by the hundreds—as they always do. Attendance totalled 1,792 persons.

While casting a reflective eye over Congress Week, the perspective of time makes it obvious that this session will be a long-remembered milestone in the recreation field for two important rea-

sons. It was the first National Recreation Congress to be co-sponsored by a number of recreation organizations; notably, the California Recreation Society, Los Angeles County Park and Recreation Department, Long Beach Recreation Commission, American Recreation Society and National Recreation Association—rather than by the National Recreation Association alone, as during the past fifty years. In spite of so many fingers in the pie, however, this one went off with a minimum of confusion. This Congress will be remembered, too, because of the general agreement, born out by the week's program, that the field of recreation has reached a peak of importance never before realized—a result of the rapidly increasing leisure in this era of automation.

Dr. Paul Douglass, author, government consultant and old friend of recreation, brought this out forcibly in his notable address, "The Next Hundred Years," at the general session on Thursday morning. He emphasized the need for a realignment of national thinking about recreation and its relation to our culture. "The assimilation of leisure into the folkways of tomorrow makes essential the reconstruction of the goals and values of life," he said.

This was just a few days before the advent of Sputnik into our planet's skies, as Dr. Douglass was pointing out the great good and great evil, at the same time, of our twentieth century. He spoke of the miracles which, on the one hand, have released man

from drudgery and the fetters which have shackled him to the earth, and, on the other, have "unfolded a deepening horror" and the possibility of untold savagery. "The look forward to another century has always been the occasion for evaluation and forecast," he stated as he expressed the concern of all of us for the kind of world in which our children—and some of us—shall live in the twenty-first century.

## Program Gets Under Way

The activities of Congress Week were led off by a grand opening of the more than one hundred exhibits, commercial and educational, on Monday morning, with a ribbon-cutting ceremony conducted by Long Beach's Mayor Ray Kealer, and William Frederickson, Jr., president of the California Recreation Society and superintendent of the Los Angeles City Department of Parks and Recreation.

At the general session which immediately followed, Joseph Prendergast, NRA executive director, officially opened the 39th Congress in his capacity as chairman of the Congress Committee and called on all Congress participants to lead a crusade to alert the nation to save recreation lands threatened by subdivisions, superhighways and parking lots. The Reverend Robert (Bob) Richards, renowned champion athlete, was the principal session speaker and paid stirring tribute to the character-building values of recreation, using the field of sports as an illustration because "this is a phase of recreation with

---

MISS DONALDSON is editor of RECREATION Magazine.



Dr. Paul F. Douglass (left), principal speaker at a general session, and Joseph Prendergast, NRA executive director.

which I am most familiar." (He has been a member of three Olympic teams.) "Give me a playground or a gymnasium," he said, "and I will do more to help boys and girls than I can from the pulpit," and he pointed out the wonderful opportunity which recreation leaders have to do this.

Present on the stage were members of the National Congress Committee, who were introduced individually by Mr. Prendergast. Flags of the forty-eight states and Canada formed a background for the speakers, and official representatives of state governors were seated in the audience. They and the Canadian guests and foreign delegates present were asked to stand for recognition. The audience was seated according to states. Dr. Frank M. Kepner, pastor of the First Baptist Church in Long Beach, pronounced the invocation.

Speakers at other general sessions included Dr. W. Ballentine Henley, educator and civic leader, who spoke on "Exploring New Recreational Frontiers"; Dr. Vierling Kersey, active member of the Los Angeles City Recreation and Parks Commission, who gave the banquet address on "Citizens Offer Leadership in American Recreation"; and Dr. Harold W. Kennedy, the counsel for the County of Los Angeles, who addressed the closing session on "The Philosophy of Recreation and Its Legal Aspects." Dr. Henley traced the social and industrial developments which have led to today's increase of leisure and emphasized the fact that more professional recreation leaders are needed now and even more will be needed soon;

while Dr. Kersey set the gay mood of the banquet with his rollicking humor.

At the closing session, Dr. Kennedy reminded delegates that the enjoyment of recreation is legally the right of all people. He further cited recreation as a vital defense against communism. "Happy people are likely to critically inspect alternative ways of life," he said. "As we face the uncertain tomorrow against the tragic backdrop of the appalling catastrophic possibilities of destruction in the atomic age, we need no further arguments for the importance of recreation."

In all phases of program for the week, the follow-through on this emphasis was the sharp challenge to workers to recruit promising young people for urgently needed leadership in this important field and to enlist more lay understanding and support.

There were over one hundred sessions at the Congress — which gives some idea of the program's especially wide scope. For a few highlights of these see "Congress Briefs," page 354.

Special meetings of all sorts were held, some as a part of the streamlined Congress program and some added thereto. The sessions on "Recreation for the Ill and the Handicapped," as set up by the NRA Hospital Recreation Consultation Service, made up one very effective section of the Congress.

Wives had a special room of their own to use as headquarters and their own program—although wives seemed to be attending more regular sessions than ever before.

Another was the Armed Forces Section of the ARS, which had its own conferences, chaired by Lt. Colonel Donald M. Kupfer, deputy chief of Personnel Services Division, Headquarters Air Defense Command, Ent Air Force Base, Colorado. Dorothy Clemens, staff service club director for Fifteenth Air Force, served as program chairman.

### Workshops and Demonstrations

These again proved a popular type of meeting, and a desire to add more of them next year was expressed. They included such sessions as:

*Day Camping in a Recreation Setting.* This was an outdoor demonstration and

exhibit. Overnight a day camp appeared on the lawn of the Municipal Auditorium, through the handwork of a special Day Camp Committee and cooperation of the Southern California Camping Association. Well-planned and informally conducted, and chaired by Esther G. Bristol, program advisor for the Los Angeles Camp Fire Girls, this offered much to stimulate interest, ideas and to give information in this program area. Outstanding day camp directors from public and private camps were on hand to explain, teach or advise. Samples of lashing, camper-made equipment, nature crafts, ropemaking, trail making and types of outdoor cooking equipment were among those displayed. Crafts demonstrations were given and, in a sanded area, various outdoor cooking recipes were carried out, using different types of fires, ovens and improvised equipment. Delicious cookery samples were fed to the delegates.

Bulletins on nature games, camping standards, and recipes were available to those interested.

*Music.* This meeting was presided over by Mrs. Virginia Clark, director of drama, music and rhythms for the Long Beach Recreation Commission, and presented our old friend, Dr. Frederick Hall—who could make even the furniture want to sing. Dr. Hall, as you remember, has led Congress demonstrations in St. Louis and Denver and is director of the music division at Southern University, Baton Rouge, Louisiana. The session included, of course, demonstrations of his very effective song leadership. "We have spent years producing performers and not enough time producing 'consumers,'" said Dr. Hall. "We need more new ideas today to help us revitalize recreation through music." Dr. J. A. Lewis, head of the excellent Bureau of Music in Los Angeles, reinforced by members of his staff, told of its early beginnings with youth choruses, then progressing to adult choruses and community sings. The bureau's slogan is, "More music for more people." It uses school facilities and most of its directors are school music teachers.

Dr. Fletcher Hodges, Jr., curator of Foster Memorial Hall, University of

Pittsburgh, told of an opportunity to obtain a beautiful eleven-page booklet, *Songs of Stephen Foster*, free of charge. Write to him at the university, using your official letterhead and telling him the number of copies you can use with your choral groups. The booklet contains words, tunes and accompaniments, and information about each song.

*Underwater Recreation, Scuba and Skin Diving.* This fascinating session was conducted by two co-chairmen, Lt. Don St. Hill, chief diving officer of the Los Angeles County Department of Parks and Recreation, and Al Tillman, professor of recreation at Los Angeles State College. The Los Angeles department leads the rest of the country in this activity.\*

*Creative Dramatics.* Mrs. Howard Braucher of the National Recreation Association presided, and a demonstration was presented by Agnes Haaga, director of creative dramatics at the University of Washington, with a group of twenty-four Long Beach children from the fourth, fifth and sixth grades. Miss

\* A new book, *The Science of Skin and Scuba Diving*, is reviewed on page 387.

### Wanted: A Builder

As preparation for the session on "How to be a Better Recreation Board Member," chairman Mrs. Paul Gallagher of Omaha, board member of the National Recreation Association, asked professional recreation directors in the Midwest to give their opinions as to the qualities most needed in board members. To encourage freedom of speech she suggested that the opinions be unsigned. The following is one of these opinions.

On every board there should be  
a person with ideas to the future  
a watchdog or financial wizard  
a builder  
a grouch  
a leader of the board  
an arbitrator  
a listener  
a person who wants to know why  
a liberalist  
a dreamer  
a walking law library  
a lover of children  
a really, really cool cat to keep up  
with the times  
and, finally, someone to pick up the  
check at the board dinners.

Haaga showed how this activity can touch off a child's imagination and provide an outlet for social and emotional experiences. The children learned that costumes, sets, make-up, props and lines are not necessary for drama, that a character must grow by feeling it from the inside, and that actions can tell a story better than words.

*Dance Symposium.* NRA's Helen Dauncey, Katherine F. Barker Memorial Secretary for Women and Girls, presided. Leaders were: *ballet*, Maria Fielding, supervising recreation specialist of the San Diego Park and Recreation Department, with six members of her senior group demonstrating; *ballroom*, Mrs. Mae Mathers, activity director of girls, women's and co-recreational activities for the Long Beach Recreation Commission, with junior-high-school boys and girls; *folk dancing*, Dr. J. Tillman Hall, director of recreation at the University of Southern California, with his group of forty older and younger dancers (these dancers know one hundred and fifty dances, from many countries); *modern dance*, Dr. Lola Sadlo, recreation director-specialist of the Los Angeles City Parks and Recreation Department, with a group of fifth- and sixth grade girls whom she had not seen before; *square dancing*, Robert Van Antwerp, district supervisor of the Long Beach Recreation Commission, using the audience as participants.

Among other workshops and demonstrations were: "Rhythmical Expression for the Hospitalized," chaired by Dr. Edith L. Ball, assistant professor of education at New York University, with a demonstration by Helen M. Hocker, assistant professor of physical education and recreation at Washburn University and consultant of the Menninger Foundation, Topeka, Kansas; "Creative Crafts," with demonstrations presented by Mrs. Frances Werschkul, crafts director of the Bureau of Parks and Public Recreation, Portland, Oregon, and Frank A. Staples, NRA director of arts and crafts (the Portland Recreation Department brought all of the supplies, equipment, and so on, plus an exhibit of children's paintings): "Veterans Administration Hospital Workshop," conducted by the San Fran-

The 1958 National Recreation Congress will be held at the Hotel Ambassador, Atlantic City, New Jersey. Dates have been moved up one week, so that the meeting will be from September 22 to 26.

cisco Area Office of the Veterans Administration, Department of Medicine and Surgery, Education and Training; and "The Group Process in Hospital Recreation," chaired by Robert Rynearson, director of volunteer activities, Veterans Hospital, Sepulveda, California, and Dr. Jessie L. Rhulman, associate professor of the psychology department, University of California, Los Angeles. A "Bazaar of Seasonal Themes for the Ill and Handicapped," chaired by Mary McGregor Kerns, assistant director of recreation at Veterans Administration Hospital, Long Beach, sported an impressive list of consultants.

### Exhibits

This year the exhibits included displays of both commercial and educational materials, thus offering executives and those leaders wise enough to plan time for browsing a wealth of new ideas. The big room in the Municipal Auditorium was gay and colorful, its carnival air enhanced by the trying out of equipment and the usual serving of free soft drinks by our old friends, Pepsi-Cola, Coca-Cola, and Seven-Up in their attractive booths. Every registrant received a free copy of NRA's new publication, *1957 Buyers' Guide to Recreation and Park Equipment, Supplies, Services*, with the suggestion that they keep it for ready reference when ordering equipment and supplies in the future.

Griswold Duplicating Products, Inc., local distributor for A. B. Dick Company mimeographing supplies, demonstrated mimeograph machines, an electric collator and a folder to interested recreation executives in the exhibit hall. We are grateful to James Hightower, the company representative, and his able crew for yeoman service daily in mimeographing all the session summaries and the *Daily Hi-Lighter*, working long after the other exhibitors had "closed shop" for the night.

Among the non-industrial displays,

we hope you saw the prospectus for the construction of a "playshore" area in Montebello, California. This is to be a new and unusual play area by the sea. (More about these plans may appear in a future issue of RECREATION.)

Also, in the same section, did you try to solve the mystery of the unknown game? The recreation department in Redondo Beach, California, was asking for help. Recently, a local family presented a game to Fred Tweedy, city director of recreation, but no one knows its origin or how to play it. According to Don Watkins, recreation supervisor, the game is very old. It is an octagonal-shaped board, having four players using "chesslike" men. Action takes place on an inner circle studded with mother-of-pearl discs about the size of a dime. If you recognize the game, please let them know.

### TV and Radio

Radio and television appearances for Congress delegates were arranged by the Press Room, and there was quite a bit of shuffling back and forth to Hollywood. On his coast-to-coast television show, September 30, Lawrence Welk saluted the Congress, and sixteen Long Beach boys and girls who were taking part in the Congress Dance Symposium made two appearances on his program. Mr. Prendergast appeared on the fourteen-state TV program, "Panorama Pacific," as did Mrs. Frances Werschkul, crafts director of the Portland Recreation Department. Mrs. Werschkul also appeared on the "Bill Gwyn" local television program on KABC. Adah Donohue, recreation supervisor of Santa Monica, appeared on the "Dee Parker Show," a popular KABC program.

Don Watkins (left), recreation supervisor, and Fred Tweedy, director of recreation, Redondo Beach, California, with their "mystery game."



Mr. Prendergast was interviewed on the Columbia Pacific Network (sixty-seven radio stations) "Sunday News Desk," also on the local "Ruth Ashton Show." Ruth Ashton—"Los Angeles' Answer to Jinx Falkenburg"—did one show with Willard B. Stone, Congress secretary, and one with Mrs. Donohue.

Dr. Douglass was interviewed by Carroll Alcott on his CPN show; and Reverend Richards was the guest on Tom Harmon's CPN sports program. Coverage in the press included special interviews and news releases.

### Local Arrangements

The Local Arrangements Committee, chaired by Walter L. Scott, director of municipal and school recreation of the Long Beach Recreation Commission, did an outstanding job; and we picked up the comment, in San Francisco later, that this excellent cooperation with visiting conferences is usual in Long Beach. This year, ushers and hostesses were provided under the direction of Mrs. Everett M. Findlay, president of the commission. The special hosts who were present at all sessions were provided by the California Recreation Society and headed up by Ernest B. Ehrke of Los Angeles. One of them was always standing by at a crucial moment. It was helpful, too, to have the local staff members wearing identifying amulets on a cord around their necks so that they could be sorted out from the crowd. Many thanks to you, Long Beachers and CRS members.

### Innovations

Among other things were the *Daily Hi-Lighter*, a free news sheet replacing the daily *Reporter*, and the substitution

"Miss Recreation" and the Reverend Robert Richards, opening session main speaker.



of daily session summaries for a proceedings this year. Summaries could be picked up at the Congress, and copies of the five key speeches could be ordered in advance, by registered delegates only, for \$1.25. A combination of summaries and speeches could also be ordered in advance, for \$2.50. (These are now available from the Association.)

A Hospitality Center for all delegates was set up by the Long Beach Hospitality Committee in Convention Hall and on the south terrace of the Municipal Auditorium. Food and beverages could be purchased there. Games used by Long Beach recreation leaders were on display, also on the outdoor terrace.

### Trips and Fun

Tours, special-interest events, and entertainment might all be said to come under one heading, because, no matter how informative or advantageous, these are also *fun*. The special-interest events, of course, included the dinners, breakfasts, luncheons which were held all week, all over the place.

The tour of Long Beach park and recreation facilities afforded delegates a view of the city and an opportunity to observe several of its outstanding recreation centers. Attractive clubhouse buildings, unusual types of brightly colored playground apparatus, non-glare lighted tennis courts, multiple-use play areas, and the new marina aroused special interest. Extensive school recreation areas and the exceptional indoor and outdoor facilities at Long Beach City College greatly impressed the visitors.

Two bus loads of delegates went on the sightseeing tour of recreation facilities in metropolitan Los Angeles, on Saturday, after the Congress was over. This tour covered over one-hundred miles and gave visitors an excellent opportunity to see more of the area. Among the many places visited, it is difficult to pick out some that are more noteworthy than others. However, a few of the sights included the Los Angeles Coliseum; Hollywood Bowl; Travel Town, where coffee and doughnuts were served through the courtesy of the Recreation Directors Association of the Los Angeles Recreation and Parks De-

partment; and McCambridge Park in Burbank. A stop for lunch was made in Descanso Gardens at Montrose. In the afternoon the itinerary included the Rose Bowl, Brookside Park and the Pasadena Recreation Department. San Gabriel Mission was not skipped, nor was the Los Angeles County Parks and Recreation Department.

An outstanding feature of the tour was the stop at Descanso Gardens, not only because of lunch but also for the beauty of the gardens. Hollywood Bowl, of course, was of great interest; McCambridge Park has a fine new recreation building and swimming pool. The system of freeways was interesting to see, and there were some glimpses of the mountains. All were impressed with the great distances.

Among purely social events, beginning Wednesday, a round-up was held for delegates at the Vessels' Ranch, in the evening. This is the home of the famous Western "quarter horse." Festivities took place at the private racetrack of Mr. Vessels, who offered hospitality of his facilities to the Long Beach Recreation Department for the occasion. A wonderful roast beef dinner was served in front of the ticket windows, a novel experience for the racing fans present. Afterwards, guests were invited to the grandstands to observe the fine program planned by the local committee. Bob Van Antwerp acted as master of ceremonies; and the entertainment included band music by the Los Angeles County Sheriff's Boys' Band; a rope-twirling exhibition, courtesy of the Los Angeles Department of Recreation and Parks; a thrilling precision drill by Long Beach's mounted police with their silver embossed saddles and beautiful palominos.

One disappointment was the non-appearance of the "quarter horse." Mr. Vessels breeds this small horse which, as we understand, is the fastest quarter-mile runner on any track. It was scheduled for exhibit, but still remains a myth—to Eastern guests, at least. Unanswered are such queries as Bill Hay's \*\* "Do we reckon, by simple arithmetic, that two horses make eight quarter-horses?"

A square-dance number on horseback was thrilling to watch and was beautifully executed by the Buttons and Bows Mounted Square Dance Association, after which square dancing for all was initiated with an exhibition by the South Coast Square Dance Association. This proved a colorful and exciting windup for the evening, with what must have been hundreds of dancers swinging their partners under the stars.

Ballroom dancing, with Bob Brunner's nineteen-piece orchestra, in the Grand Ballroom of the Lafayette Hotel after the Congress Banquet on Thursday evening, was fun too—with everyone dressed in their best finery. The table decorations, done by the local recreation department, were beautiful.

The Friday tour to fabulous Disneyland was another high point of the week. This offers four lands in one, all radiating from the typical Main Street of Early America, where one can listen in on a "party line" or see Mabel Normand and Fatty Arbuckle in their silent films at the local movie. There are many exhibits, shops and stores. The four lands are: Tomorrowland, with a rocket-ship trip to the moon; Fantasy-

\*\* NRA representative from the Southern District, where the horses eat bluegrass for breakfast.

land, where you fly with Peter Pan over moonlit London and visit Storybookland with its miniature homes of such beloved characters as "Mr. Toad" and "Three Little Pigs"; Frontierland, which exhibits America's pioneer past; and Adventureland, where boats tour the mysterious and savage jungles of the world. Great care has been taken to make each as authentic as possible. Delegates had a ball! As tourists for half a day, they tried them all. . . .

During the week, also, a few persons managed to get to Marineland, although no regular tour was arranged. Here they made the acquaintance of "Bubbles," the trained whale with a personality. According to reports, she is the only whale in captivity. The porpoises, too, won everyone's heart with their smiling antics—as they always do. Marineland, incidentally, is said to be "the largest of the three oceanaria in the world." It stands on a rugged cliff just outside of Los Angeles, overlooking the Pacific.

## Farewell

The closing general session of the Congress was held on Friday morning, and the luggage of most delegates was packed by noon, before the Disneyland trip. Sandwiched between rather hectic activities, farewells were exchanged with old and new friends in the recreation field, and—suddenly—the fast five (or six) days were over! Delegates, armed with summaries of the meetings, printed materials and pencilled notes, departed, to settle down in planes, trains, boats and cars, to sort out impressions, new ideas, inspiration, know-how, and memories—grist for that all-important local report and future planning! ☆

"Bazaar of Seasonal Themes for the Ill and the Handicapped" was a humming swap shop of party ideas and materials, with displays of props and posters. Participants sat at appropriately decorated tables.



ARC's Dorothy Taaffe, ARS president, member of Congress Committee.



Lulu Lydell and John Collier of NRA Pacific Southwest staff.



An engrossing session was held by the executives, who divided attendance into ten sub-groups, each with a previously appointed chairman. For example, a group led by Walter Cammack, superintendent of recreation in Whittier, California, discussed the importance of the annual report among the various media utilized by a recreation department. Members decided that it ranks high because its purpose is to give the public an account of stewardship. They recommended that it contain: (1) progress of programs or plans (factual statistics); (2) information about personnel—full-time and part-time; (3) report re present facilities; (4) capital improvements; (4) finances—increase of previous years, financial needs, analysis of sources, factual figures of expenditures; (6) co-sponsorship, descriptive material, acknowledgement to co-sponsoring organizations; (7) plans for future expansion (very important); and (8) achievements.

On the other hand, Martha Maitre, superintendent of recreation in Mobile, Alabama, chaired a sub-group discussion on whether teen-agers should be used more extensively as recreation leaders. Mrs. Maitre's group felt, generally, that teen-agers can make good leaders, and that their employment is one of the best recruiting devices a recreation executive can support. (This was considered a very important point.) The youngsters should, however, be assistants to trained, adult leaders. A teen-ager has limitations and should not ever be hired to the exclusion of a qualified adult.

These two topics merely indicate the wide range of subjects at the session.

*Industry Plans for Its Retiring Employees.* A favorable trend, brought out in this session, is that, with early retirement and more leisure, industries are now paying more attention to preparing employees for this adjustment, many of the companies starting as early as five years in advance. Some are employing retirement administrators or counselors.

It was agreed that retiring persons should be encouraged, among other things, to join community recreation activities and to familiarize themselves



with all of the possibilities of their own neighborhood or town.

#### **From the Summaries . . . \***

*Recreation's Role with Youth in Conflict.* This session was chaired by Philip G. Green, director of the Division of Juvenile Delinquency Service, U. S. Department of Health, Education and Welfare. Panel members were Sidney Dvoskin of the probation department of Los Angeles County and Sidney G. Lutzin, director of community organization of the New York State Youth Commission. The role of recreation in juvenile delinquency prevention, control and treatment was discussed in the light of current facts: Children's Bureau Juvenile Court statistics indicate a twenty per cent increase in cases in 1956. The FBI recently reported a seventeen per cent increase in juvenile arrests in 1956 over 1955—over forty per cent of these were children under fifteen years of age. Professional organizations and agencies are taking a new look at their total service to children, youth and their families. The American public has accepted the premise that recreation is a delinquency preventative, although recreation leaders have not developed programs for this purpose. The recreation field therefore stands accused of failure because it has not stemmed the delinquency tide.

It was pointed out that we must begin to make this important by-product of delinquency prevention an important facet of our programs or we run the risk of losing community support for the total program servicing the larger percentage of population. We must recognize that recreation programs which can serve the needs of youth in conflict must be concerned with the develop-

\* Full summaries, with addresses from general sessions, are available from NRA, \$2.50.

# Congress Briefs

ment of better human beings, rather than better activities.

Recreation departments, whether cooperating with another agency or not should seriously consider sending out workers detached from a "facility" and able to work with youngsters wherever they are—perhaps eventually drawing them to their program. This detached worker must be willing to take the initial rejection of a group, or even continued hostility, without becoming defensive. This is part of the "testing" process by which group members determine whether or not the worker is really interested in them as persons.

When a relationship has been developed to the point that the worker is accepted, he is in a position to assist the group members in participating in a more socially acceptable program.

The whole staff of a playground must understand that an effort is being made to help these "youth in conflict" resolve some of their conflicts. A custodian or a watchman or a gardener can destroy the results of weeks of effort by professional staff by too much assertion of authority or by showing contempt or disregard for the personality of those in conflict.—LESLIE E. EICHELBERGER, Executive Director, Special Services for Groups, Los Angeles, California.

#### *Patterns of Church Recreation Services.*

Henry W. Waltz, executive secretary of the Los Angeles Metropolitan Recreation and Youth Services Council, chaired this meeting on Thursday. Problems encountered by churches include: discouragement of volunteer leaders and their feeling that they are not competent to adequately handle the leadership task; the feeling of some persons that recreation has no place in the church; failure of leaders to keep abreast of changing needs of citizens, so that often

## Random Highlights from Discussion Sessions

programs are continued only because they have been in existence for years; administrative body of the church often relegates its recreation life to a minor role; and need to remind leaders of the basic purpose of their responsibility. Often objection to church recreation stems from the feeling that the program is just entertainment and not something that is meeting basic needs.

*How'm I Doin' — The Importance of Self-Evaluation.* Chaired by Howard Jeffrey, the American Recreation Society's new executive director, this session discussed three questions:

1. What is self-evaluation? Observing one's self is self-evaluation. As a preliminary to observing one's self it is important to know human behavior and the dynamics of cause and effect as they relate to leisure. It is important to know your community, the people, economics, culture, and how to relate psychology and sociology to your work.

2. The purpose of self-evaluation. This is to help people to understand themselves and to grow. It is a two-way role. You must evaluate yourself as a supervisor and as a supervisee. It should be done with respect to the goals of the employing organization.

3. What is done with self-evaluation results? A study is made of the results and a decision reached as to how to improve for growth.

It is important to share evaluation concepts of individuals with one another, keeping aware of the need to be constructive in discussion and that communication can easily break down. Self-evaluation tests are important for every staff member, regularly, and this procedure can be applied to part-time staff with success.—THOMAS BELTON, Superintendent of Recreation, Waterford Township, Drayton Plains, Michigan.

*State Legislation and Special Appropriations and Projects.* Sterling S. Winans, director of recreation in Sacramento, California, chaired this meeting. Before the session, panel members had canvassed an assigned list of states for information regarding 1957 legislation, whether passed or defeated, relating to public recreation and park services (state government, city, county or park district). About forty states replied, but indicated a need for some agency to compile digests of legislation, as California, Colorado, and Washington have done. Almost every state had bills pertaining to recreation. Defeat of some measures was as significant as passage of others. States with official recreation agencies had more bills. Washington in 1947 had only three, in 1957 fifty-six, thirteen of which passed. California had two hundred bills, not counting those dealing with conservation.

Every state has some agency to acquire and administer state parks, historical monuments. The process of acquiring and developing lands for state park and recreation purposes involves such factors as: reluctance to take lands by condemnation; development of way-side rests with picnic facilities; regulation of boating with measures for safety, sanitary controls, registrations; and establishment of state park and recreation boards. A considerable number of states are considering measures to establish a state agency for development of local recreation and park services. In California a "Public Outdoor Recreation Plan" is to be developed by a committee of the executive officers of eight state departments and agencies for recommendation to the legislature.

A digest of legislation reported from all states will be prepared, and copies will be available on request from Mr. Winans, California Recreation Com-

mission, Sacramento, Calif.—RUTH MCINTYRE, Extension Specialist in Recreation, University of Massachusetts.

*Clinic for Publication Editors.* This, the first meeting of its kind at a Congress, may prove to be the forerunner of others. It was chaired by Dorothy Donaldson, editor of RECREATION. Only a few of the many items of concern to the group could be discussed. Among them were: that alert recreation administrators and staff personnel must be aware of the tremendous importance of professional publications as a tool for stimulating interest and providing essential information in the recreation field on local, state or national level; the importance of establishing the purpose of a publication.

The purposes and objectives of departmental publications should include the providing of vital information regarding local city-wide events and activities, new program ideas and public relations values.

Design: All should have an especially designed masthead, and complete identification in a prominent place. Careful use of "white space" and an interesting presentation without too much solid copy are important.

Advertising: Many basic elements govern the principles of advertising in material published at the state level, such as the following: (1) potential includes regional and state firms or local firms serving several communities; (2) do not overlook contributing or gift advertising from industry, insurance companies or individuals; (3) don't go into the advertising business blindly—determine publication costs; extent of advertising should support the publication, and the circulation; (4) establish basic size ads and establish the price on a year's contract commitment and a higher rate for a single issue; (5) establish a committee, if desirable, under a business manager.

An information and rate sheet should be printed, for proper clarification, for prospective advertisers. Of pertinent importance is the need to clarify the extent to which the publication is read, establish proof-of-readership.—TEMPLE R. JARRELL, Director of Parks and Recreation, Fort Lauderdale, Florida. ☆



Some of the 700 boys and girls at the Mount Rainier-Tacoma ski for fun school.

# Season in the Snow

## School for Skiing

Go to ski school on a snowy slope, acquire a winter tan, learn to take part in the many aspects of this exciting outdoor sport! When you report to your instructor, have your equipment shipshape and ready to go. Don't start lessons with skis on the wrong feet, bindings loose, no mittens, and so on. If you do, you'll soon hear about it!

Ski schools for local young people are starting in the northern parts of the country, from coast to coast, and will be well under way by the end of

December. On Washington's Mount Rainier, a weekend school, held in January and February for young Tacomans, is sponsored by the Metropolitan Park Board and the *Tacoma News Tribune*. Transportation is provided.

In Vermont and New Hampshire, skiing is so popular that citizens feel it unfair that any child should grow up without instruction. Therefore, the Ford Sayre Ski Council was founded, with funds to be used for ski instruction for any school child from the first through the eighth grade in Hanover

and Etna, New Hampshire, and Thetford, Vermont. The program includes approximately four hundred children. Skis are rented for one dollar per season to those not owning them. A group of fifty *volunteer* instructors, under an outstanding chief instructor, teach beginning, intermediate and advanced classes. A uniformity in teaching is essential, and the techniques used with the beginners' groups in this school are presented on page 370.

Jumping, on the other hand, is the thing in Lebanon, New Hampshire.\* A local lad, at the age of sixteen, became the first American born jumper to win a Class A rating in the sport. Since then, the town has developed several Olympic contenders. Thus the whole state has become enthusiastic, and a group of business men provide facilities and instruction after school and on weekends. Youngsters pile into the school bus for the haul to the ski area, a few miles from town, and learn to jump as soon as they learn to ski.

Skating rink in Williamsport, Pennsylvania, is used by families, groups, all ages.



\* The *New York Times* recently devoted two pages of pictures to Lebanon's ski activities. Two of them appear on the next page.



## Ice-Skating Safety

Provision to safeguard local ice skaters were made last year by the South River, New Jersey, Recreation Commission for the first time in the history of the commission. They provided:

**Life-guards.** Swimming guards were given special ice-skating instruction on rescue and safety, and were on duty from 4 P.M. to 10 P.M. on weekdays and from 10 A.M. to 10 P.M. on Saturdays and Sundays.

**Telephones.** They were installed with-



"Now what do we do?" Three novices wait for further instructions and an answer to this highly important question.

in twenty feet of each pond. (These are also used during the summer swimming period.) They are always open for emergency use with direct telephone connection with the police department which, in turn, will call the rescue squad. Splendid cooperation has always been received from both of these departments.

**Emergency equipment.** Items such as a ladder, ropes, lifebuoys, long planks, tree branches, and first aid kits are now at hand.

**Especially Designated Areas.** These include areas for various types of ice-skating, such as hockey, racing, tag, figure skating, a special children's area, and an area for recreational ice-skating.

**Lights.** Lighting is provided for night ice-skating at both ponds.

**Prohibition of Certain Games and of Rough Play.** Snap-the-whip, cross-traffic skating, use of sleds on ice, and

throwing of foreign substances on the ice are prohibited. Non-skaters are kept off the ice.

**Newspaper and Radio Publicity.** These media are used to caution all parents to warn their children about the condition of the ice.

In addition, an ice-skating safety demonstration was conducted by the recreation department, with the cooperation of the rescue squad and the police department. The high school physical education classes served as demonstrators. It included demonstrations of the use of ordinary clothing and other easily found materials in making a rescue. Items used were scarves, sweaters, belts, jackets, and so on; a plank or a long pole; lifebuoys with a long rope (at least one hundred feet in length); a rope with looped ends; a ladder; and a tree branch.

Various methods of *self-rescue* were covered, such as the hip-climp-out and roll method; the use of mittens sticking to the ice; what to do if you find yourself under water; what to do if it is necessary to keep breaking the ice to reach the shore line, when you have fallen through the ice; and the use of



On the bus. Good jumpers start young in Vermont. These are aged 8 to 12.

*home-made* dowel sticks with a nail in the end. In the last, the audience was surprised to see how quickly the boys were able to pull themselves along the ice with these "icepicks." Parents and children were shown how to make the "lifesavers." A list of safety hints was also given to the audience. When we conducted the demonstration the temperature was seven degrees above zero. We were surprised to have approximately 250 persons witnessing the demonstration.

Several neighboring towns have re-

cently asked for information for their own use in sponsoring a similar show. —CHESTER ZDRODOWSKI, *Recreation Director, South River, New Jersey.*

## Don't Forget Snow Sculpture

Students at Dartmouth College began to model in snow in 1920, and have been at it ever since. Their snow sculpturing has achieved world renown, and their know-how should be of great value to anyone interested in this activity. A detailed account of their techniques was published in the November 1953 issue of RECREATION,\*\* "The Art of Snow Sculpture." J. Rand of the Dartmouth Outing Club, in writing us recently, again emphasizes the best effects are *not* achieved with the use of colored snow. "Snow is snow, is snow"—with apologies to Gertrude Stein—"and should look like it."

## Make that Little Hill a Big One!

Of course, if your sliding hills serve your purposes, as they are, you will pass this one up. But if you have a playground such as Broadway Park, in Bangor, Maine, a special snow slide may be just what you need.

The playground is smack in the center of the city, completely surrounded by residential streets. Each street has a full complement of kids! There is a small hill at one side, so small that it is of interest only to the six-year-old set. But what about those twelve-year-olds? The answer is a special snow slide.

The platform, two-and-a-half by four feet, was placed six feet above the ground. The fourteen-foot slide, two-and-a-half feet wide, was placed with

\*\* A special Outdoor Winter Sports Issue. Some few copies are still available at \$.35.

No champion yet, but well on his way!



its bottom on the brow of the hill. The cleats on the slide helped to hold the snow and ice. The platform and slide were packed with two inches of snow and wet down to freeze over night. And

that made the little hill a big one!

Now, even the fourteen-year-olds use the hill, with sleds, toboggans, flying saucers—and their posteriors! The six-inch side boards keep the sleds safely

on the slide. Business is great!

One handrail for the ladder is enough. The children will need the other hand for carrying or pulling up the sled. If you slope the platform about three inches from the rear toward the slide, the take off will be easier. This slide is not good on level land. If the bottom of the slide is not on the brow of a hill, the leveling off will jar the daylight out of the sliders. The slide and ladder will prevent sway one way; you may want to brace it the other way. We did.

Paint the contraption in bright colors, service it, and you will find it very popular. Bangor is going to build more of them.—BERNARD B. (BEN) CAMPBELL, former Director of Recreation in Bangor, now Director of Recreation in Portland, Maine. ☆

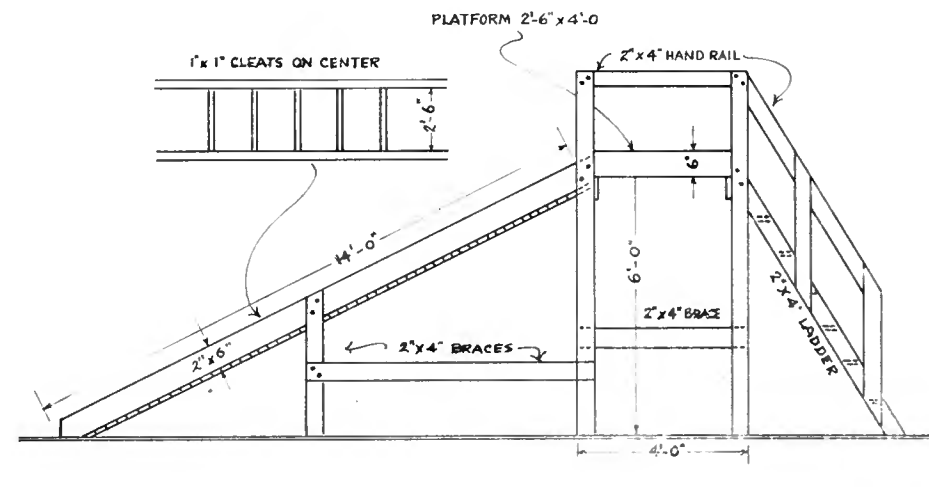

## What is the Point of Sport?

Arnold Kaech

Why should we look for a justification for sport? Why insist on making it utilitarian and give it an end outside itself? Because, doubtless, we live in a time that claims "that every undertaking must be useful, and every man must let himself be used"; and because we can neither imagine nor accept the idea of sport as self-sufficient, owning no particular aim, and finding its true sense and justification precisely in its detachment from material things.

We can be glad that sport is good for health; that sport can mold character; and that, through sport, this or that individual has formed lasting bonds of friendship in defiance of frontiers and oceans. Even if there were no more to it than joy in the rhythm of the runner's gait, the jumper's illusion of freedom from earthly ties, the helter-skelter down the ski-slopes, the sudden cool of a dive, or the passionate, total absorption in a contest—if sport were nothing but aimless, useless play—we should still have no choice but to defend it.

While we are engaged in sport we move in the blessed realm of childhood; while we are engaged in sport the dreams of youth are still alive within us. We give freely of ourselves because we ask nothing in return; we are disinter-

ested because we do not ask if our acts are useful. When we engage in sport we are at play and it is only at play that man is truly man, as Schiller has told us.

To many this play seems an activity of the body merely. They see the body in movement, the vigor of a stroke, the swing of the gymnast's arms and legs, but they do not see what goes on inside. They do not see all. It is as if a man should look at a picture and see nothing but lines and colors, or at a statue and think only of the material of which it is made, or read a score and never hear the music. The body, and the feats it performs, are ends to them; whereas in true sport the performance is not an end in itself—nor the body either—but the means of expression. Moving over the ground, thrusting through the wave, gliding over the snowy slopes, or wrestling with the rock face—these are expressions of the joy of life itself, expressions of the well-being won from living close to nature. The body is but the means of expression, the instrument the soul requires to enable it to measure the territory which has been granted to man, and occupy it to the limit.

Only thus can we explain why "they which run in a race run all, but one receiveth the prize," only thus understand how records can go on forever being broken. . . . Sport is the faithful image of the struggle of humanity towards perfection; in sport soul and body together strive to accomplish the age-old aspiration of mankind—"faster, harder, higher."

There lies "the point" of sport, its whole importance, its true meaning. It needs no other justification. ☆

*Condensed and reprinted with permission from Physical Recreation, The Quarterly Journal of the Central Council of Physical Recreation (London), January 1957. MR. KAECH is director of the Swiss School of Sport and Gymnastics, Macolin, Switzerland.*



# Christmas Customs in Many Lands

*A collection of not-so-well-known beliefs and ceremonies. Tell the stories in your story hour or adapt some of the ideas new to your program.*

☆ *Denmark*—There is one custom in Denmark that is almost entirely unique to that country: "Blowing in the Yule." At sunrise, while the people are at breakfast, the town band climbs the many steep ladders to the top of the church tower and plays four old hymns, one to each corner of the compass, so that no one is forgotten. Those sitting in their homes always join in with the song as soon as they hear the first note. As the fourth hymn ends, the deep voices of the big church bells commence to boom and Yule is under way.

☆ *Norway*—In Norway they have a legend that on every Christmas Eve the little Christ Child wanders all over the world bearing on His shoulders a bundle of evergreens. Those who would invite Him into their homes set a lighted candle in the window to guide Him on his way. They believe He comes in the disguise of any wandering person who knocks humbly at their door for sustenance, thus testing their goodness. So they show hospitality to all visitors, believing that such aid is done as unto the Christ Child.

☆ *Sweden*—Here, the people prepare for the Christmas festival by a thorough housecleaning, in which everything indoors and out is made spotless. At all times in the year they believe that "cleanliness is next to Godliness" and so, in honor of this day, they prepare to celebrate it in a Godly house. Wheat for the birds is placed on a pole in front of each house. The horses, cows, cats and dogs are not forgotten, but are given an extra portion of the best for their supper because, when the Christ Child was born, His cradle was in a manger.

☆ *Germany*—Every home in Germany has a Christmas tree, and it is from the Germans that other countries have learned to use it. "Knecht Rupert" delivers toys to the deserving and a rod to the naughty from a branch which he carries.

☆ *France*—In France at Christmas time it is the rule of the family gatherings that all the quarrels of the year shall be forgiven and forgotten before the family have their celebration. While the feast is in progress, the older people usually tell stories of the doings of those who, in the past, have brought honor upon the family name. After the supper is over, noels are sung.

On December 4, the Feast of St. Barbara, the women plant St. Barbara's grain. On Christmas day the plants are placed in a bowl on the table when the great supper is served, the growing sprouts being a symbol of the harvest of the New Year that is soon beginning.

☆ *Holland*—Christmas Day is celebrated by the Hollanders with church rites and pleasant family visiting. St. Nicholas comes on December fifth. He tells the children whether he thinks they have been good or bad during the year. He then wishes them all a Happy New Year and scatters a great shower of candies on a linen sheet spread out by the door. After St. Nick leaves each child removes one of his clean wooden shoes, places it on the window sill, and fills it with oats and hay or carrots for the good Saint's horse. In the morning the oats, hay and carrots are gone and the shoes are found filled with gifts and candy.

☆ *England*—They play games, sing carols, feast on puddings and mince pies in this country, but probably the oldest custom, and one which we usually associate with them, is the bringing in of the yule log. This is an emblem of the true light that dawned on the world at the birth of Christ. A yule candle sheds light on the festivities during the evening.

☆ *Ireland*—Christmas Eve is the only time in the year when Mass is said at night. It is observed in Roman Catholic countries at midnight, because it is commonly believed that Christ was born at about that hour. In Ireland, each family leaves for the village church at about eleven o'clock. The father leads the way with a lantern or torch. As the different families come together they unite in singing carols. Bells are also rung to announce the Nativity of Christ.

☆ *Italy*—In Italy, instead of having a Christmas tree, a large urn is used. It is filled with small gifts and an occasional dummy package. When the children and adults draw from this much fun results especially when the empty package is drawn. Carol singing, the making of the Christmas manger and the giving of Christmas plays are also popular.

☆ *America*—Most of the Christmas customs in America have come from Europe: our Christmas tree from Germany; our Santa Claus from Holland; our Christmas stockings from Belgium or France; Merry Christmas from England, and also our Christmas cards, plum puddings and mince pies. The one thing that is strictly native to this country is the use of the poinsettia.

*This material was originally prepared and distributed by the recreation department of Brookline, Massachusetts.*

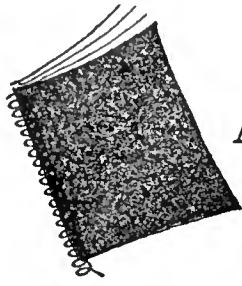

## A REPORTER'S NOTEBOOK

### NRA Expansion



Tapply



Langkammer

As part of the expansion of the National Recreation Association services, two new district representatives are now in action in the field. Richard "Wink" Tapply, who has been a special Association representative in New Hampshire under special funds for that purpose, will become a regular member of the NRA field staff as of January 1, 1958.

In addition, David M. Langkammer, superintendent of recreation in Altoona, Pennsylvania, since 1948, has been appointed third full-time NRA district representative for the Great Lakes District. Dave, as he was known to everyone in Altoona, did an outstanding job in that city; and a recent, very fine editorial in the *Altoona Mirror* attests to his accomplishments and popularity in that community. It says, in part, "He leaves behind a memory of success, one of development. . . . He helped put this city on the map in recreation and in community enterprises."

### NRA Citations

At the annual National Recreation Congress Banquet, Joe E. Brown, professional comedian, member of the board of the Los Angeles Recreation and Parks Commission and a national sponsor of the NRA, received an NRA citation from the city of Los Angeles for his long service to the cause of recreation. Another citation, presented in

absentia, honored C. M. Goethe of Sacramento, California, for his outstanding service to recreation.

### ARS Honors

The American Recreation Society, at its Annual Award and Recognition Banquet at the National Recreation Congress in Long Beach, paid recognition to the following for their contribution to the recreation profession: Fellow Awards honored Madolin Cannon, consultant in volunteer services, Bureau of Mental Hospital Services, Pennsylvania; Charles Cranford, deputy commissioner, Department of Recreation, Philadelphia; and Jesse A. Reynolds, director, Department of Recreation and Parks, Richmond, Virginia.

Other citations for outstanding achievement in the field of recreation were presented to Alta Sims Bunker, executive director of program for the recreation department, Oakland, California, and to Dr. Paul Douglass, author, educator and chairman of the NRA National Advisory Committee on Recruitment, Training and Placement of Recreation Personnel.

The ARS Armed Forces Section citation award plaques were presented to: (military) Colonel Arthur W. Gustafson, special services officer, Sixth Army, and (civilian) Reba K. Taylor, chief of service clubs, USAREUR. Certificates of special merit were awarded to: Clarence J. Koehler, staff sports director, AFFE/Eighth Army (Rear); John C. Berssenbrugge, staff entertainment director, USAREUR; Caroline H. Reid, assistant chief of service clubs, USAREUR; Mary Frances Sargent, service club director, Granite City, Illinois; Vera Lucille Vincent, staff service club director, AFFE/Eighth Army

(Rear); Colonel Karl Lowe Springer, commander of 3350th Air Base Group; and Margaret E. Lynn, staff entertainment director, Second Army.

### Swimming Pool Awards

A series of annual competitions in the swimming pool field has been initiated by *Swimming Pool Age* magazine, endorsed by the National Swimming Pool Institute. George Butler, director of the NRA Research Department, will serve on the award panel in the public relations field. The award will go to the community, organization, group or individual who has done the best public relations job for their pool(s) to increase attendance, build community good will and increase, in the eye of the community, the importance of the pool to community life and the value of swimming.

### Milestone

The California Recreation Commission celebrated its tenth anniversary in October. Over 150 state leaders from the legislature, the California Department of Natural Resources, Division of Water Resources, Department of Fish and Wildlife, Division of Park and Beaches, Department of Education, private agencies and public recreation and park departments of the state gathered to mark the occasion. An all-day program was arranged with remarks from key leaders in the recreation movement in California. The program was culminated by a banquet with the closing address given by Mrs. Rollin Brown, chairman of the commission and NRA board member, on the subject "California Looks Ahead."

The National Recreation Association Board of Directors, through its district representative, John J. Collier, presented a Special National Citation for the outstanding contribution made to the recreation movement by the California Recreation Commission, its director, Sterling S. Winans, and his staff.

### Young Folks in Homes

The Bureau of Child Welfare, State Department of Social Welfare, 112 State Street, Albany, New York, has published in bulletin form, with NRA permis-

sion, a large portion of *Young Folks in Homes*, written by Jeanne Barnes for the NRA. These bulletins were so helpful to child care institutions that they have now been printed in an attractive spiralbound booklet through funds made available by the Federal Child Welfare Services Fund. Leaders in child-care institutions may obtain a copy without charge while the supply lasts. Write to the above address.

### Uprooting Prejudice

The Workshop for Cultural Democracy, an educational service organization in the field of human relations, has been developing techniques, materials, and the kinds of emotionally satisfying face-to-face experiences which help to get at the roots of social prejudices. Most significant among the techniques developed by the workshop, under the leadership of Dr. Rachel Davis DuBois, is group conversation. Under the guidance of a skilled leader, participants of a session share meaningful memories. Wit, humor, songs, and, often, remarks of deep significance come spontaneously; and a feeling of belonging together comes over the group. The resultant acceptance of self as well as of others has been found to be healthful and helps to produce a feeling of community.

The workshop has trained hundreds

of professional and lay leaders and has conducted projects in intercultural education in numerous educational, social and religious agencies. A manual for leaders, *Know Your Neighbors*, may be secured for \$1.25 at the workshop's headquarters, 204 East 18th Street, New York 3.

### Tools of Learning

The Association for Childhood Education International has just published a revised copy of *Equipment and Supplies* (General Service Bulletin No. 39), listing "tools of learning" that have been tested and approved for pre-school, school and home—and for the recreation program as well. The listing is so organized that equipment and supplies for any special type of program can be found quickly; for example, a complete listing of all the different supplies and equipment for an intermediate group of thirty youngsters. Should you need to find out what types of climbing structures are available, the manufacturers and the age-level of use, a separate listing makes them simple to locate. Listings for arts and craft supplies, musical instruments, records and furniture are an excellent resource. The bulletin is available for \$1.25 from the association at 1200 Fifteenth Street, N.W., Washington 5, D. C.

**CAMP DIRECTOR**  
 Experienced, for co-educational camp for diabetic children located in New York State. Modern plant, 2 four-week sessions, 100 children, ages 5½ to 16. Responsibilities include program development, staff procurement and training. Full time July and August only. Write or call: New York Diabetes Association, 104 East 40th Street, New York 16, N. Y. OXford 7-7760.

### Recreation for Handicapped

Interesting work is being done in California in recreation for the handicapped. Janet Pomeroy, founder and director of the Recreation Center for the Handicapped, Inc., San Francisco, is spearheading a movement to acquaint public recreation departments with their opportunities and responsibilities to these people—and some of the results that can be obtained with them, by using recreation leadership techniques as against the "therapy" approach. "In therapy, children perform activities upon prescription," says Mrs. Pomeroy, "and there is no free choice. It is almost like taking medicine to get better.

"On the other hand, recreation is participated in 'for fun,' and in the process, the children become so absorbed that they forget about their infirmities. I have seen them drop and forget their crutches. Our results have been amazing."

A seven-day institute on "Recreation for the Physically Handicapped," held for California recreation leaders under the auspices of the Recreation Center for the Handicapped, the Adult Education Division of the San Francisco School District, the San Francisco Recreation Department, and the California Recreation Commission last March, was well attended. It included actual work with the handicapped members of the center, to stimulate the interest and add to the "know-how" of recreation workers, in this field. As a result of this institute, a number of recreation departments in that area have since set up new and flourishing programs for the handicapped.

Copies of the syllabus prepared for this meeting are still available from Mrs. Pomeroy at the center. Fleishacker Pool Building, Great Highway near Sloat Boulevard, San Francisco 16, for \$1.50 per copy. ☆



Reprinted by special permission of *The Saturday Evening Post*  
 Copyright © 1957 by The Curtis Publishing Company.

# "Grass Roots"

## Recreation

Charles H. Odegaard

*"This county recreation plan appears to be suitable for use by other states and counties."*

—C. E. Reed, NRA Field Department

TO THE WEST of the growing city of Milwaukee lies even faster-growing Waukesha County. In 1950, this county had 86,000 people engaged in business, industry and farming over its 576 square miles of rolling green interspersed with placid lakes. Then the rush started. Six short years later small communities had mushroomed where cornfields once had been; cities with increased commerce and industrial developments had displaced the smaller villages. A conservative estimate placed the population at 110,000, or an increase of twenty-eight per cent. This made Waukesha the fastest growing county in Wisconsin.

This population growth, which shows every indication of increasing even more rapidly, is gathered into sixteen townships, sixteen villages and three cities, the largest having only 25,000 inhabitants. To add further to the widespread clusters of population, there are ninety separate public school districts outside of the three cities, plus thirteen parochial schools.

To all of which you might say—so what? It is easy to see where this affects taxes, transportation, zoning and the like, but what effect does it have on recreation? Basically, two things: first, with the exception of two cities and one township, no municipal area has over five thousand population, the average being around two thousand; second, a great majority of this increased growth is the result of migration from cities where there are existing recreation programs and where a recreation director does the planning.

Put these two points together (small communities and people who desire recreation opportunities but have always had them planned for them) and you have a real problem. Many of these communities are not even large enough for a full-time summer program, to say nothing of a year-round program. Nevertheless, these people want a year-round program just the same, and this is where the problem arises.

To further add to this, we find that the county has over

---

MR. ODEGAARD, first recreation agent for Waukesha County, Wisconsin, is president of the Wisconsin Recreation Association and vice-president of the Wisconsin Park and Recreation Society.



The county's first united recreation conference had advance registration of 225. Charles H. Odegaard (left) discusses the program with Bob Horney, NRA district representative.

one hundred and fifteen churches, the majority of which are extremely interested in recreation programs within their churches. The rabbis, priests and ministers are wonderful people, trained in their particular religion but not to any degree in recreation. They, too, need help in operating a program.

One hundred and twenty industries, most of which are too small to hire a recreation director but large enough to need in-plant programs, are also searching for the way to conduct activities for the benefit of their employees and their families. So the need grows, but what to do about it?

Many people decided that something should be done about it. The research, study and legwork done by these individuals and agencies is too great to go into here. However, their success was evident when, early in 1956, the county board of supervisors authorized and directed the agriculture committee to hire a county recreation agent whose "sole duty shall be to coordinate recreation in Waukesha County and to provide leadership training."

This broad statement has provided the latitude for doing a great deal of work with the various county organizations. Basically the role of the county recreation agent and that of the National Recreation Association field representative are very similar.

### Information and Training Services

*Resource.* Schools and part-time recreation departments ask for information on how to lay out a playground or about the selection of equipment. We try to aid them in the choice of materials and in locating sources. Or an individual might seek information about camp sites—the only limit to the questions is the limit of the ever-searching mind.

*Consultation.* All types of agencies and groups have presented us with their specific problems to be solved. Naturally, we don't have all the answers; but by talking with these people and using educational techniques we are often able to help them find solutions.

*Workshops.* By studying the various types of problems and requests that are presented, we are able to determine some of the needs. Based upon these needs, a workshop is held

in an effort to reach many of these people at one time. It might be through a skills workshop with instruction in a specific area of interest, such as arts and crafts, or it may be a techniques workshop where leaders learn how best to instruct their group or class.

*Miscellaneous.* Through meetings, radio talks, newspaper articles and features, and TV appearances, our office is continually broadcasting the message of recreation—the need for it as a part of the process of living and the proper standards necessary for evaluating leisure-time practices. Though the results are intangible, it is felt that this approach has been very effective.

### Coordination

As is to be expected, the coordination phase of the Waukesha County program is taking longer to put into practice. It will develop only as the various groups and activities are started in different areas. Some examples of how this coordination might take place are:

*Through Athletics:* Setting up county-wide leagues when the various municipalities develop baseball teams. These leagues to be financed and operated completely by the teams, with our aid in scheduling, promoting and general administration.

*Through Programing:* Grouping together of four or five neighboring communities so they can more efficiently and economically operate their summer programs.

*Through Other Activities:* Holding cooperative training institutes and jointly scheduling activities by way of program planning.

In the brief year of the existence of the county agent's office, direct services have been given to officers and/or leaders in recreation departments, schools, PTA's, Boy and Girl Scouts, 4-H, churches, service clubs, industries, YMCA, adult groups and other special interest groups.

As you can see, our program is not an activities program, but, as is true with all extension work, a service program. We have no money to operate activities per se but only staff personnel to aid others in helping themselves. We firmly believe that these communities and the people therein will not only be better citizens by participating in recreation but even the more so by planning and administering it themselves.

This is not the easiest type of recreation program to conduct. In my last job, as director of parks and recreation in another Wisconsin community, I thought that there was no limit to the scope of such a program. I still feel that there is no limit; however, I believe, now, that it is more difficult to stimulate others to desire the proper program and then to train their leaders to operate it, but it is also very satisfying and wider in scope. We all realize, I am sure, that there is a place and a need for both types of program—activity and service.

Many people would not like this type of a job because rarely do you come in direct contact with program participants. However, this is more than compensated for by the

tremendous number of leaders with whom you come in contact every week. In a sense, these people become your participants, as they too are learning the tools of leisure time—only from a different view.

We have found that, though each agency or organization has a philosophy of its own and a training program peculiar to itself, there are also many ideas common to all. As an example of this, our office operated a one-day recreation conference with six speakers covering the following subjects: "Recreation—A Basic Essential Today," "What It Is and Where Found," "Aids and Resources for Recreation Development," "Recreation is Big Business," "Special Needs in Recreation," "Public Relations." Area workshops were held in the afternoon. More than two hundred and fifty people participated in this conference—and are clamoring for more. All but about ten of these participants were non-professionals.

As is to be expected, no program with such new ideas of operation can be successful without excellent assistance from many areas. There is, of course, the invaluable consultation and advice given by the extension staff and the agriculture committee in Waukesha County and the extension staff of the state university. These are available to all agents. In addition to these wonderful people, there are two special groups which need further explaining.

At the start of this program we carefully selected certain topflight qualified people who serve as a consultant committee on recreation for our department. These men represent certain local branches of government plus the state university, state government and the National Recreation Association; and they have done wonders in aiding with nearly all program planning. Their keen minds have saved many an error, as they have perceived the problems which would arise and have pre-planned optional roads of travel.

And then there is the Citizens Recreation Council which, naturally, is county-wide in membership, with all activity areas being represented. The council as a unit is divided into sub-committees concerned directly with the development and promotion of such areas of interest as arts and crafts, music, outdoor recreation, and the others with which we are so familiar. These people are not only close to the citizens; they *are* the citizens. At this time, none of us are truly able to view the scope of what this council might do. Our office shall aid it in any way possible for it is truly the vehicle by which citizens plan their own recreation destiny.

Here, then, is a brief glimpse of a new avenue in recreation—an avenue that drives right into the problems exemplified in grass roots, an avenue that has tributaries yet untraveled but which someday will be well worn.

Naturally, only time will give validity and stability to such a program. However, if the amount and variety of services already requested and rendered are indicative of its need, it looks as though this is potentially a new era in recreation! ☆

## *The place of the recreation worker in the hospital set-up.*

Joseph B. Wolffe, M.D.

**A**T THE VERY OUTSET, let us dispel any notion concerning lines of demarcation between preventive and therapeutic medicine, recreation and the humanities. They are interdependent.

We hear it often said, even by recreators: "If only we had enough scientific proof, our profession would make tremendous strides!" Let us take a moment to analyze that. All of us are strong for the accumulation of scientific data, on any subject. Science is a discipline—a discipline of thinking, of planning, of deduction. Therefore, the results must come as disciplined conclusions.

To what extent, however, is the practice of medicine scientific? Preventive medicine against infectious and contagious diseases, the use of antibiotics in therapy—these are definitely based on scientific observations. The same prospects will hold true for recreation, as we go along.

At this stage, when recreation is serving more and more as an important, universally applicable modality, let us not make a fetish out of science, and shun empiricism.

The history of mankind from its earliest beginnings, starting with the narrative of the Old Testament, if you will, is replete with examples of practical appreciation of methodologies aimed at health and fitness. There are the stringent sanitation regulations laid down by Moses for the ancient Hebrews.

True, recreation indulgences such as the rhythmic dance were connected with emotional expressions of religious fervor. Cleanliness of body was equated with purity of mind, heart and soul.

Yet, how did the teachers and leaders of those ancient people know these activities were beneficial? Surely not through scientific investigation! Their knowledge and insights were empirical. What they, and those who followed them in succeeding generations, distilled from observation and experience came later to be confirmed by evolving scientific wisdom.

Prior to the turn of the century, the great cellular pathologist, Rudolph Virchow, crystallized, in his own career, the responsibility of medical science in the realm of the humani-

ties. The founder of cellular pathology, he contributed to virtually every branch of medicine.

"Medicine is a social science, and politics is nothing but medicine on a large scale," Virchow declared. What the good doctor was trying to tell us is that statesmen have the same responsibility to the welfare of humanity that medical science has, in its own sphere.

That medicine, again, is a social science, is evidenced in the fact that, when his defenses are down, the average physician will admit that he practices, largely, empirical medicine—based on what he has observed, often contrary to what would be indicated by laboratory findings.

In the past decade, after examining thousands of athletes and subjecting patients in our hospital to recreation activities, we learned what we should have known long ago: Abnormalities found on physical examination, X-ray, in clinical laboratory tests, electrocardiography, and through other precision instruments—all of these must be interpreted in terms of the individual, particularly in relation to his capacity for performance.

The implication is clear—and for me, sound and true. If we reason honestly and competently from experience, we are utilizing the best of know-how for the benefit of those we seek to help, whether medically or educationally.

In the area of education and health, where recreation is coming to be recognized more and more as a vital modality in both preventive medicine and therapeutics, the non-MD—you, the recreator—has an historic role to play.

The competent recreator is in a uniquely important position to observe many things which the practicing physician never gets to see. Such observations are very valuable and need to be called to the attention of the medical profession at large. The physician, the hospital, the private and public health agency all need the recreator as a key member in the multi-disciplined team.

The recreator in a hospital setting is in a strategic position to observe that a certain type of music tranquilizes the agitated, while music of another kind counteracts depression. He or she may note that on a night following a certain type of movie, fewer patients will require restraint; that dancing diminishes hostility; that a successfully played game produces more self-confidence than any drug as yet available on the market. It becomes the job of that recreator to record such observations and disseminate the information where it can be utilized to greatest therapeutic advantage.

The time must come soon when the non-MD, who is trained, by academics and, more especially, by experience, in fields vital to the realization of medicine's own true aims, should be liberated from the fear of overstepping professional bounds. They are professionals. Aware of their limitations, the men and women skilled in the arts of recreation

---

*Condensed from an address presented at Third Southern Regional Institute on Hospital Recreation in Chapel Hill, North Carolina, and published as Bulletin #22, Recreation in the Hospital Setting, by the University of North Carolina. DR. WOLFFE is medical director, Valley Forge Heart Institute and Hospital, Fairview Village, Pennsylvania.*



are capable of making clinical observations that are on a par with those produced by the best of physicians.

There is an area of diagnostic acumen and treatment know-how which, under the supervision of medical authority, can make the recreation therapist an invaluable member of the broad team involving the cardiologist, the neuropsychiatrist, the surgeon, and other specialists. At the same time, the various specialists in medicine must learn from the recreator about the available modalities and their physiologic and therapeutic effects. Our knowledge in this field calls for a close and free exchange of experiences.

I now report to you on the application of a recreation therapy program under good leadership in one of our hospitals, as against another under our direction in which no recreation therapy was employed.

In the institution with the recreation program, unexpectedly rapid improvement was seen among those patients in whom the overlay of tensions, anxieties, organ fixations and repressions were prevalent. This observation convinced us that in many of these instances the somatic disease from which the patients were supposedly suffering accounted only in part for their symptoms.

The lack of ability to perform daily tasks without undue fatigue was found to be the result of an overcautious attitude on the part of medical authorities toward needed physical exertion.

A distinct relationship seemed to exist among our patients between the degree of functional disturbance and restriction of physical activities. Limited mobility of joints, muscular aches and pains, and a tendency to hopelessness were outstanding symptoms which could not be accounted for by organic disease even when present. With the diminution of the individual's total fitness, a greater degree of anxiety and organ fixation became very apparent. This vicious cycle results from the lack of appreciation that activities, recreational as well as others, are as essential as food and oxygen.

### **Prerequisites for a Department of Recreation Therapy**

1. Outdoor recreation activities are preferred if the hospital's physical setup is suitable. Even in crowded city quarters a splendid job can be done. An air-conditioned, clean, indoor, recreation room can be superior to a dusty, windy, and noisy outdoors.

2. Personnel must become thoroughly familiar with each patient's functional capacity. The recreation therapist must understand the diagnosis and prognosis in every case in order to be able to recognize the symptoms of progression and retrogression of the malady.

3. Graded walks are of great value.

4. Space for playing medicine ball, croquet, quoits, horse-shoe, dancing, and other activities should be provided.

5. Indoor facilities should be available for inclement weather and for those patients not well enough to partake in outdoor activities. Since indoor activities must be provided at least one-third of the year because of climatic conditions, the facilities must be adequate.

6. Proper time allotment for recreation should be made in the hospital schedule.

7. Nursing, medical and technical staffs from other departments should come to understand that the recreation department is as important to the individual in need of it as any other therapeutic procedure.

8. Periodic re-evaluation of the patient's clinical progress is essential and should be done jointly by the medical and recreation staff.

9. If the patient fails to show improvement, a re-evaluation of the methods employed is imperative. This should be done in the same manner as review of drug therapy in patients who fail to show the expected progress.

10. The head of such a department should be a member of the major staff and report the patient's progress at regular staff conferences.

### **Remuneration for Recreation Services**

It is quite apparent that it will take time until everybody concerned comes to realize that recreation activities are an effective form of therapeutics and prophylaxis. Many patients do not yet understand the medical value of properly supervised recreation activities. Needless to say, a patient with this type of attitude is not willing to pay for such services.

The various hospital insurance plans such as Blue Cross and Blue Shield are also unaware of the fact that an effective recreation program is not only humane but also economically sound. It diminishes the number of days spent in a hospital, reduces the need for expensive drugs, and prevents frequent re-hospitalization. The moneys thus saved would not only cover the expense of an outstanding recreation department, but would also mean a saving in manpower. In addition, an important facet would be added to preventive medicine, and invalidism would be reduced.

If moneys were available to compensate adequately for recreation therapy, all hospitals would be able to provide their patients with this needed advantage. Recreation personnel would be afforded the recognition they deserve, and this, in turn, would assure growth of the profession.

Recreation, properly employed as an auxiliary therapeutic measure, will yet prove to be equally as important as any of the so-called "miracle" drugs.

More importantly, "re-created" patients, helped by a skilled team of therapists who respect and care for each of them as a complete person, will symbolize the interrelated values of recreation, medicine and the humanities. ☆

# Last Minute Holiday Hints

Make streamlined, up-to-date decorations for a gay and glittering Christmas.

## Enchanting Tree Trims of Cork

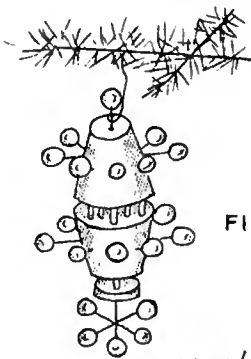

FIG. 1

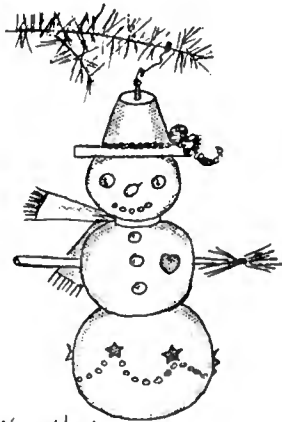

FIG. 2

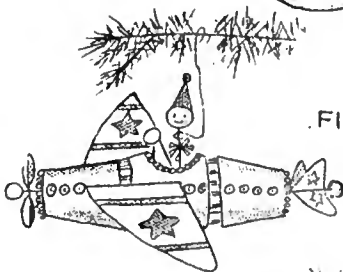

FIG. 3



FIG. 4

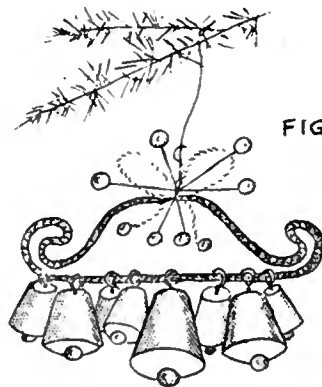

FIG. 5

MOBILE ORNAMENT (Figure 1) is formed of two corks painted white and fastened with toothpicks sharpened at both ends. Bead-headed pins make a design around middle, top and bottom.

SNOWMAN (Figure 2) is three bobber corks glued together; hat is small cork on circle of balsa wood. Trim with colored bead-headed and straight pins. Tie together wood shavings for broom.

AIRPLANE (Figure 3) is made from two ordinary corks joined by toothpicks to a straight cork. Pilot, wheels and tail-light are bead-headed pins. Wings and tail are balsa wood.

LITTLE ANGEL (Figure 4) has a body of corks with a bit of paper doily glued between. Trim with doily frills, tiny pearl buttons, balsa-wood wings, Christmas ball head, and metallic paper halo.

CHRISTMAS BELLS (Figure 5) are small corks decorated with paint, cord, sequins, with bead-headed pins for clappers. Top with screw-eyes and slip onto pipe cleaner tied with a bow knot. —CHICO AREA RECREATION DISTRICT RECREATION BULLETIN, Chico, California.

## Santa Balloons

It's a new idea to decorate gay red balloons with soapsud faces to give the illusion of Santa, complete with lopsided cap and shaggy beard. To decorate, knot the balloon ends onto flexible long sticks. Use either a rotary beater or electric mixer to whip up a batter made from plenty of soap flakes or powder with a little water. To thicken, add more soap; to dilute, add more water. For Santa faces, the batter should be beaten to the consistency of stiff whipped cream. When "painted" on the surface of the balloon with a long-handled spoon, it hardens and remains in place. Stick the finished balloons in a tall vase filled with tinsel. Place them at the door as take-home favors for the tots who come to romp at your Christmas party.



## Christmas Fountain

To make a lovely, and very simple, table or mantel ornament, insert ten lightweight, flexible, copper or steel wires, each about a foot long into the base of a large spool which has been painted to match your Christmas color scheme. White is very pretty; so is gold, silver, blue, red or green. Anchor

the wires in florist's clay, cork, plastic-foam or any other substance that will hold the wires erect, or stick them into small holes bored into the top of the spool. Bend them into graceful curves, to resemble the fall of a fountain. Twist a small loop, or bend the end of each wire, and insert a tinsel rosette or a one-inch length of long-haired tinsel. The wires will tremble slightly in any movement of air and the "fountain" will shimmer in the light.

### Fancy Balls

Dress up colored Christmas balls by using the metal light reflectors that can be purchased at any decoration or light counter, and are very inexpensive. Slip the reflector over the hook end of the ball and/or fasten one to the bottom of the ball with all-purpose clear household cement. Devise variations. These are very elegant when hung in windows, or from mirrors, or in any prominent place in the room.

### Ribbon Tree

This is a simple, novel, and very pretty decoration for mantel or table. Fasten a cardboard tube, such as that from a paper towel roll, to the center of a paper or aluminum foil cake or pie plate. Gummed paper will hold it in place. Cover the tube with small flowers or glitter of any sort. Tape or glue narrow strips of ribbon from the top of the tube over the edge of the plate, giving a modern "tree" effect. Fill the plate with "snow," small Christmas balls, or other shiny ornaments. The tree can be adapted to match any color scheme. Red and green ribbons and red

and green balls are effective; or try an all-gold or all-silver effect, or blue and silver, or red and gold.

### Light-Bulb Ornaments

Cover the metal base of a burned out electric light or flash bulb with gold or silver foil or colored masking tape. Tie a cord or ribbon to form a loop or bow that can be used to hang the bulb on a tree or any place desired. Decorate the glass part of the bulb with glitter, sequins, beads, tinsel, or any bright scraps, using clear liquid cement. Spread the cement directly on the glass and shake the glitter on it in any design you like.

### Copper Foil Ornaments

Cut out designs—house, Santa, bell, tree, heart—from copper foil and emboss them with just a few lines with the blunt end of an orange stick or anything that won't pierce the foil. Punch a hole, insert a cord or ribbon, and hang on tree.

### Cone Trees

All the material needed to make this tree (*Figure 6*) is an ice-cream cone or cone cup, two pipe cleaners, a small scrap of plastic-foam for the base, and any scraps of bright paper, beads, sequins, or glitter for decoration. Cover the cone with metallic paper, and glue the ornaments on it. Or decorate the cone by glueing a fringed strip of metallic paper around it so that it is covered completely. Twist the pipe cleaners together, push up through the top of the cone and anchor the other ends in the plastic-foam base.—RECRE-



FIG. 6

ATION DEPARTMENT, Long Beach, California.

### Tree Lighting Ceremony Dance

The children dance in a circle around the tree singing "Here We Go 'Round the Christmas Tree" to the tune of "Here We Go 'Round the Mulberry Bush," or "Merry Christmas to You" to the tune of "Happy Birthday to You," shaking hands with three different people on each of the first three lines, crossing arms and shaking hands on either side of them on the last line.—DEPARTMENT OF RECREATION AND PARKS, Richmond, Virginia. ☆

## Christmas Tour for Golden-Agers

Robert A. Lee, superintendent of recreation in Iowa City, Iowa, tells of a program his department and the local Kiwanis Club inaugurated four years ago—a program which gives the senior citizens of the area a chance to see their city's holiday trim in comfort and sociability.

The recreation department and the Kiwanis Club plan a motor caravan for the local Golden-Age Club to take place several days before Christmas. The program is organized in the following manner: The recreation department compiles a list of the various homes that have been entered in the annual Christmas decoration and lighting contest; a route is planned to include as many of these decorated homes and areas as possible; and the names and addresses of those Golden-Age Club members who want to make the tour

are obtained. Then the Kiwanis Club takes over by supplying the required number of cars and drivers needed to transport these oldsters; and, at 6:00 P.M. on the day set aside for the expedition, each driver is given the names and addresses of the four club members he will take on the trip.

The caravan of cars tours half the city in one direction, viewing the elaborate and colorful displays, and then returns to the starting point. Here the elderly sight-seers pause for hot coffee and doughnuts; and, in keeping with the spirit of the season, all join in singing Christmas carols. Warmed by the hospitality of the food and caroling, the tour continues on its way through the rest of the city. At the end of a greatly enjoyed evening, the older folks are returned to their homes. ☆



Brilliant weather and semi-tropical scenes such as this formed the backdrop for the Congress. The Pacific is noted for its sunsets.



Day camp demonstration took place beside the sea on the first day and included cooking delicacies on improvised outdoor equipment. Section presented many new ideas for this area of program. Bulletins on nature games, camp standards, recipes were available.

J. Earl Schlupp, vice-chairman of the Congress Committee and outgoing president of ARS (left), introduces Dr. W. Ballentine Henley, orator, educator civic leader, who addressed Tuesday's general session on "Exploring New Recreation Frontiers."



# Scenes from

**T**WO IMPORTANT ingredients, nestness and fun, blend well the shores of the Pacific. These pictures tell, in part, the interesting story of

*"A meeting worth holding makes a difference in the lives of its participants."—Adult Leadership, December 1952.*



Everyone was required to register this year and the badges were the open sesame to all the meetings and activities. Here, Mrs. Ramona L. Klee, of Lemont, Illinois, is helped by Mrs. Dee Ann Rushall of the Los Angeles City Parks and Recreation Department. The Congress registrations totalled 1,792.



# The 39th Congress

39th National Recreation Congress, an important and memorable meeting of national recreation leaders, in Long Beach, California.

Joe E. Brown, famous movie and stage comedian, and a long-time member of the Los Angeles Recreation Commission receives a citation in honor of his many contributions to recreation from the NRA's Joseph Prendergast.



Delegates on the tour of Long Beach park and recreation facilities were interested in the unusual types of brightly colored playground apparatus and the city's outstanding youth and adult centers, and other installations.



Scene from the remarkable folk dance exhibition put on, in costume, at the Dance Symposium, by Dr. Tillman Hall's groups. Youngsters of all ages "danced with their hearts as well as their feet" during this outstanding session.

Trying on hats made by the ill and handicapped are, left to right: Mary Lou Warner, head recreation worker, American Red Cross, U. S. Naval Hospital, San Diego; Gerald Callahan, chief, Recreation Section, Veterans Administration Center, Los Angeles; and Mrs. Mary Kerns, assistant recreation director, Veterans Administration Hospital in Long Beach.

Right, another of the intriguing modern pieces of Long Beach playground equipment which was viewed by the touring delegates. The multiple-use play areas and the new marina also aroused special comment. City's recreation program is a well coordinated municipal-school operation.



# Techniques of Ski Teaching . . .

## for Beginners' Groups

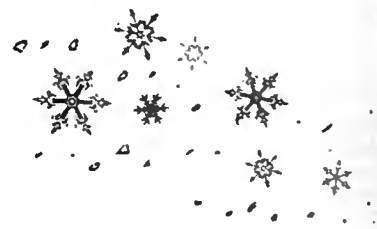
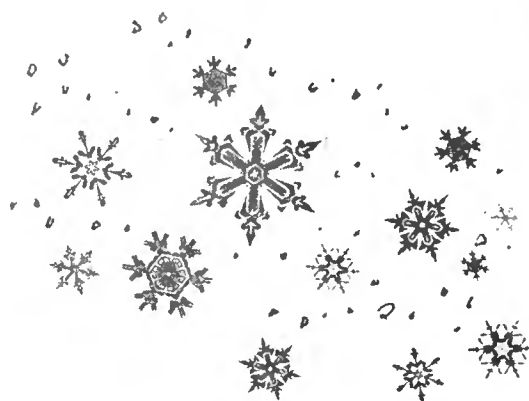

**A** GOOD SKI INSTRUCTOR for children of the first through eighth grades in the New Hampshire and Vermont schools\* need not be an expert skier but should have certain qualities, according to the bulletins of teaching techniques issued for volunteers or other possible leaders. If you are to be the teacher of a beginners' group in any part of the country, the following specific instructions which are quoted from these should be of value to you:

### Conducting Classes (General)

- Check your pupils' gear at the beginning of each lesson; and be sure that boots are laced or tied, bindings secure no mittens are missing. Then organize your little group into some semblance of order as you take them to the slope, while there, and while returning. Learn each child's name, and use it!
- While teaching one pupil, keep an eye on the others. Some may be cold; but the main problem is the very young who tend to wander off. Children *must not* leave the class without your permission.
- When class is over, return *all* pupils to the disbanding place. Collect stray poles, mitts, and so on. *You* are responsible.
- In case of accident, use your good judgment and act promptly to help the child. If you must leave the slope,

\* See "Season in the Snow," page 356.

*Condensed from instruction bulletin for teachers of beginners, which is available from Mrs. A. O. Brungardt, Director of Recreation, State House, Vermont. Others, on teaching of intermediate and/or advanced groups, can also be obtained upon request.*

be sure to turn your class over to another instructor first.

- If a child has been hurt in your class, submit a brief written report of the cause, injury and disposition of the case as far as you know.
- In severe weather, particularly, watch small fry for cold feet and hands, frostbite on noses, cheeks and ears, extreme fatigue, wet panties. Don't risk health!
- Should you be asked to drive children to a slope, be sure to bring them back. *Be sure* that your car carries adequate liability insurance.

### Instruction Procedure

*Choice of ground.* Beginners often fear a long, continued slope; choose a short, gentle one with a level runout. What is a suitable slope under one snow condition may be absolutely wrong for your students under another. Pupils should have their backs to the wind, bright sun or falling snow, if possible.

*Explain the movement.* Use clear, precise speech!

*Demonstrate—with comments.* One good demonstration is worth ten thousand words.

*Have each student carry out the movement.* Let the whole class benefit from your corrections. Ordinarily, a position half-way down the slope is best for running, side-slips and turns.

*Clear the course!* As each pupil completes his movement, see to it that he hustles back up the slope, but not in the downhill path of the next pupil!

*Repeat the demonstration, again and again, if necessary.*  
*Variety.* Children are like puppies: after a few minutes it is difficult to hold their attention. Use variations to achieve your purpose. Also, make it fun!

## Some Requirements for Beginner Skiers

To be accomplished before a child graduates into the next upward class:

**Sleeve Mark:** Red tape, sewed horizontally under the Ford Sayre Memorial (or similar) shoulder patch.

**Terrain:** Only well-packed, very gentle slopes with level outrun.

**Speed:** All turns must be made at slow speed.

1. Put on, take off skis; carrying skis.

2. Walking on level.

3. Step-around turns on level (tails of skis remain on the snow while tips move in an arc).

4. Falling.

5. Getting up after a fall (accomplished by getting skis horizontally across the slope below the body, drawing knees up under the chest and getting up).

6. Running straight (on gentle slope with good run-out). Feet flat on skis, one ski slightly advanced in good snow; increase the lead on deep or heavy, wet snow; boots together (laterally) on soft or deep snow (somewhat apart on hard-packed surfaces); use of inside edges, knock-kneed position on hard snow and ice; arms free of the body, elbows slightly bent, hands gripping the poles *firmly*, hands being just forward of the hips and *below the belt*; round-shouldered position.

7. Climbing: Sidestep; sidestep and forward (uphill traverse); use of uphill edges to hold a grip on the slope; stamp.

8. Step-around turns on slope. Poles *must* be firmly planted downhill of skier's body; poles, hands, wrists and arms carrying almost all of the skier's weight, particularly while skis are pointing up or down the fall-line during the turn.

9. Narrow snowplow down the fall-line. This is *not* a turn exercise, but the first element in controlling speed and increasing stability. (The fall-line is an imaginary line down the slope which, if a ball were released at the top of the hill, would be followed down the slope by the ball. Usually the most direct line down the hill, avoiding traverses.) Feet flat on the skis, ankles turned neither extremely in nor out. Knees pressed somewhat forward, upper body in the normal position, hands low. Force skis into a narrow V, heels out; hold the V down the slope. Tips must not cross. Too much edging causes crossed tips: too much speed, lack of edging, sitting back, involuntary turning, not standing equally on both skis.

**Snowplow variation.** Start down with skis parallel, open into narrow plow, let skis run together; repeat.

10. Turning. We must maintain both skis on the same side of the trees which confront us; therefore we are obliged to learn to turn.

**Counter-Rotation:** In skiing, one utilizes certain physical forces to obtain emphasis, push, firmness, decision to the skis. It is simple, relaxed twisting of the upper body and arms in a direction *counter* to the direction one wishes to turn.

**Rotation:** Having drawn back, *wound up or counter-rotated*, the upper body and arms are now unwound, smoothly, firmly, in the direction of the desired turn.

**Clutching:** At the moment when the rotating upper body is perpendicular to the skis, all of the muscles of the trunk of the body are compressed, contained, frozen, so that the developed force of the unwinding upper body is imparted to the legs, feet and skis. Allais calls this momentary tensing of the trunk *clutching*.

In order to obtain force for turning, one *counter-rotates*; to develop that obtained force for utilization, one *rotates*; to utilize the developed force for turning, one *clutches*—at the moment when the rotating upper body is perpendicular to the line of the skis. Clutching carries the twist of the upper body to the legs, feet and skis, imparting that twist to the skis in the desired direction.

11. Very narrow snowplow position, with alternate quick rotations. Weight equally on both skis; brief, firm rotations, resulting in tiny linked skidded turns down the fall-line.

**Variation** (on good surfaces). Narrow snowplow linked turns with rotation (as above), but more deliberately timed, longer turns, making an effort to step directly on the lower ski as each small skidded turn is executed.

12. Snowplow single turn with rotation. Running down the fall-line, with skis in narrow snowplow position, make a long, separate turn. When the new direction has been reached, *rotation ceases*. Attempt to maintain the normal forward lean of the straight snowplow; hands slightly forward of the normal downhill running position, tips of poles back. Avoid sitting back. *Never lean into the hill*—try to maintain a position equally over both skis. Practice turns *each way*.

13. Linked snowplow turns with rotation. Hold the snowplow position from one turn to the next.

14. Advanced snowplow linked turns. After each snowplow turn, the skis are *coaxed* to some parallel during each small traverse.

## Ski Manners

Help tramp the hill; fill and tramp your own bathtubs; never ski too close to the other fellow; plan to stop some distance away from him. *Never run over your instructor's skis!* Take *your turn* in class; then *get out of the way*, and hustle up the slope out of the next skier's way. Help the other fellow—*always* if he is hurt.

## Basic Waxing and Care of Skis

- Paraffin rubbed on thick for wet sticky snow; never for dry snow. Get it on before the ski bottoms are wet; otherwise it won't go on.
- Children can wax their own skis, and carry their own paraffin. If you don't teach them, you'll have to do it.
- Keep skis dry! Stand skis on tips to drain, tails against the wall, *don't* dry them behind the stove (too much heat).
- Check list before skiing: toe-irons, straps; cables adjusted and in cable-guides; boots laced; both poles with skis. ☆

## PRINTING with PLASTER OF PARIS

*MAKE PICTURES, DRAWINGS, SEASONAL GREETING CARDS, ETC.*



### METHOD

1. Make rectangular clay wall the size required on clean glass plate.

2. Mix *Plaster of Paris* and pour on glass - fill area inside clay wall. *Note: Plaster of Paris mixture - 2 parts plaster, 1 part water. Note: Let plaster dry 6 hours.*

3. Remove clay wall and push plaster slab

off glass. *Note: Let slab dry 24 hours after it has been removed from glass.*

4. Paint slab with shellac and dye mixture.

5. Using sharp knife engrave desired design in plaster of paris slab.

6. Ink engraved plaster slab - roll ink on with a brayer.

7. Lay paper on inked plaster slab and rub back of paper with a spoon.

Peel paper off plaster of paris slab and print is made.

*Note: Re-ink slab and by repeating step seven*

### MATERIALS NEEDED

*Glass Plate - Brayer - Modeling Clay - Plaster of Paris - Mixture of Thinned Shellac and Black Dye - Printing Ink - Sharp Knife - Paper.*

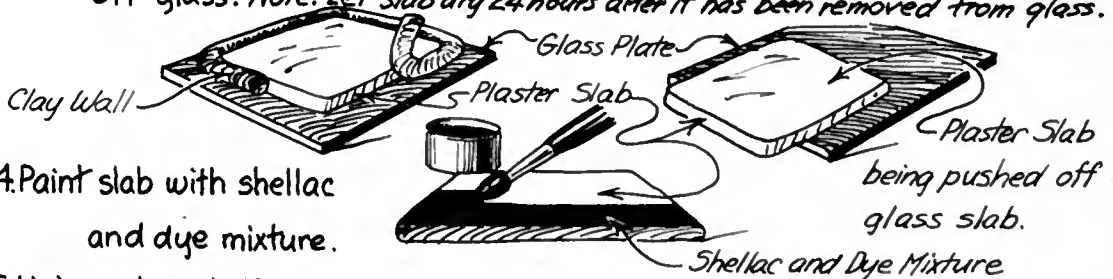
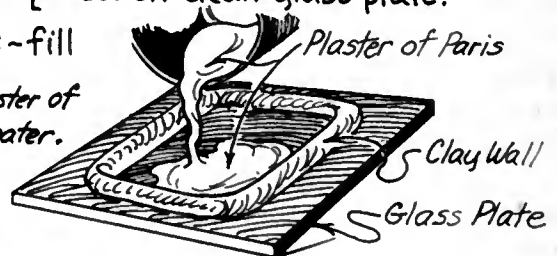



# Santa Goes to School



EVERY COMMUNITY has a number of potential Santas—fathers or other male family relatives—for the Christmas at home; Santas for the office party; Santas to appear at social and civic clubs; Santas among generous and tender-hearted volunteers who want to bring joy and happiness to the homebound, the hospitalized and the institutionalized youngsters; Santas to pop into the schoolroom, at the community sing, or the tree-lighting ceremony.

Being Santa Claus, however, is more than putting on a red suit and false whiskers. It is more than just distributing toys. Santa must symbolize the spirit of good will, the spirit of giving. He is the patron saint of children at Christmas time.

The Wilmington, Delaware, Recreation Promotion and Service, Inc., recognizes Santa's importance in American tradition. In order that Santa Claus may not disappoint youngsters by his appearance, manner, or actions, this department conducts a training course for volunteer Santas (not for store or commercial Santas). Anyone who wants to be a Santa Claus, or has been one on previous occasions and wants to improve his techniques, may attend. The "school" is held one evening about two weeks before Christmas, and it is free.

The department offers another fine service: the nominal rental of top-quality Santa Claus suits, including cap, wig, whiskers, jacket, trousers, belt,

*This article is based on a bulletin issued by the Recreation Promotion and Service, Inc., of Wilmington, Delaware.*

leggings and an empty sack — outfits that originally cost \$75.

What do these amateur and novice St. Nicks learn? They learn something about Santa's background: the legend of St. Nicholas, the American legend of Santa Claus and *The Night Before Christmas*. They learn what the well-dressed Santa wears, how the costume is worn, the make-up required, and the properties he will need.

**Costume:** This consists of pants, coat and cap with fur or white trimming, white beard and wig, wide black belt, black leather boots, boot tops, black shoes and a pillow for padding. It must be worn with an air of assurance and poise. The beard and wig must fit snugly; the cap must not fall off. The pillow must be tied or pinned on securely.

**Make-Up:** Santa will need spirit gum, alcohol, white crepe hair for eyebrows, rouge and natural color powder. He may need white shoe polish and a brush, tapes or pins for the pillow, a good ruddy, but not beet-red, complexion, rouged high on cheeks and nose. He must not get make-up on his wig and whiskers!

**Properties:** A big toy sack, sleigh bells, snowshoes and a big book (for children's names).

**Procedure:** The well-trained Santa plans his visits well, knows the places he is going and plots each visit from beginning to end. He must know the names of the children. If there are any special messages, he must have all this information in advance.

**How Does He Enter?** "Lively and

quick," with a little noise outside, such as instructions to reindeer and a jingle of bells. He enters with a generous, jolly "Merry Christmas to All," but he should not be too boisterous. He should be careful not to frighten the very little children.

**What Does Santa Say?** He talks about how busy he is, how hard everybody has worked, how many visits he must make. He laughs a lot, keeps up conversation and asks questions. If he can, he may dance a little, tell a story, and call the youngsters by name. He gives the gifts, listens to the children's requests, letting them take their time. He does *not* promise them things, but asks what they'd like.

**Leavetaking:** He leaves as he entered, with a "Merry Christmas to All," and a jingle of sleighbells.

**Psychology:** Santa must try to be the person the child has imagined; and does not stay long enough for the child to be disillusioned. He must remember that the two- and three-year-olds may be frightened, so he doesn't take their hands or touch them. If they cry, he concentrates on others. The three-to-fives are curious; and Santa asks questions to keep them from doing so. The six and sevens may try to show Santa up, so he talks fast to this age group.

**Tips For Santas.** Do not play to anybody except those who believe. The ones who do not believe will embarrass you and the others, so bypass them. If there are any handicapped children in party, be sure to know about them so as not to embarrass them. ☆

# Recreation Education Higher

THE NATURAL, innate characteristics which link recreation education with liberal learning and general education can be found in their common purpose—the realization of free and abundant living!

Recreation, and hence, to a degree, the proper kind of education preparatory to its development, is designed inherently to stimulate the imaginative and creative powers of those it serves. Recreation, as a kind of living, is not confined by time, distance or cultures. Its human values are unending. It is only without reason if life itself is without meaning. It is not a specialty to serve the whims of the frivolous, any more that it is primarily a social welfare device to soften the blows upon the misfortunate.

Recreation is not so much what one does as it is an attitude of mind which brings from an experience a feeling of personal satisfaction and enjoyment. Its main goal is the development and manifestation of personality at its fullest. Recreation, being a way of living, is, in the first instance, an end in its own right. The kind of recreation which contributes to our being better persons may help keep us out of trouble, but this is not its major purpose. It may help sharpen the learning processes, but this is not its initial design. It may help tighten the spiritual bonds, encourage higher codes of ethics and morals, help heal and rehabilitate the ill and disabled and even add to our material wealth, but these are intentions it sets and victories it claims not uniquely and basically for itself. It can flourish only with and through minds that are completely free and capable of making a choice. Recreation which generates intellectual, social and spiritual growth, rather than the leisure behavior which leads to character disintegration, presupposes an appreciation of those life values which make our behavior decent and good, our actions responsible and reasonable, and our motivations and accomplishments productive and worthwhile.

Recreation is—or could be—a revitalizing element in the process of education itself.

Recreation education, in its broadest and deepest sense, has two functions to serve: to help *all* persons develop appreciations, interests and skills which will enable them to use their leisure in creative, wholesome and personally rewarding ways, either with or without the use of society's organized facilities and services; and to professionally prepare a limited number of persons competent in multiplying worthwhile recreation opportunities for others. Both functions lay a strong claim upon the resources of liberal learning because their missions are invested in factors and conditions which represent living at its fullest.

## Liberal and General Education

Liberal education in our colleges and universities is concerned with discovering and disseminating knowledge. Uppermost in the hopes of liberal learning is the cultivation

---

DR. BRIGHTBILL is professor of recreation at the University of Illinois.

. . . . .

of the mind and the intellect. Preparation for any field of professional specialization, including the recreation profession, cannot take precedence over the one and only point of departure for the learning process—cultivation of capacities to *think*. To attempt to do otherwise is only to prevent the individual from realizing his greatest potentials for living and for giving and getting the best from his chosen profession.

There is also the matter of general education which admittedly, is interpreted in many ways. The various shades of intent and understanding of it often depend upon the status and importance attached to it. In this instance, general education is considered to be the adjustment of education to the needs of the people, and a common ground for cooperative action among people. Although general education connotes the study of the humanities, languages, social studies and natural sciences in such combinations as to give the student a broad foundation for later specialization of a vocational nature, a large part of its emphasis appears to be upon social responsibility, people and their common needs. It suggests experiences beyond the taking of traditional courses. It places more emphasis upon behavior and perhaps less upon given disciplines.

## Recreation Education and Liberal Education

*Although recreation education has a dual role to perform, as interpreted and used here, it refers only to that phase of higher academic preparation which prepares a student for a professional career in the field of recreation.* It is not to be construed here, in any sense, as being a part of general education and liberal learning even though it is built upon a foundation of and often contributes to the implementation of both. Recreation education accepts completely the belief that liberal learning in itself increases the joy of living for people. Surely it makes for a better and more competent individual in a profession which involves wide social, economic and ethical considerations. Recreation education recognizes that minds which are harnessed too closely to a restricted area of knowledge are minds which are not likely to be free to explore, to discover and, hence, diffuse learning. It agrees that the ability to think is the primary prerequisite not only to the full development of the individual but also to professional competency in any field. It encourages students to take part in a wide range of extra-

# in the World of Learning

Charles K. Brightbill

class activity—the kind of experiences which make of college existence itself a laboratory of living; and it acknowledges the need for the student to develop and control his motor facilities, to create and produce with his hands as well as his mind, to communicate effectively, to know and enjoy his natural environment and to help create richer living opportunities for others.

How, then, does recreation education differ from liberal learning? Indeed, the similarities of these phases of education are far greater than their differences. Recreation education differs only in respect to the requisite of liberal education that the student gain command over one discipline (or subject), and even this difference diminishes depending upon what one chooses to call a *single* discipline. If, for example, history, rather than the several social sciences including history, or philosophy, rather than several of the humanities including philosophy, are considered as but one discipline, it would be at this point that the two approaches part company. Why, then, does recreation education choose the *several* social sciences or the *several* humanities rather than the single disciplines within such vital areas of study?

Surely, the values derived from intensive study of a single subject are obvious; but there is also much intellectual merit in exposure to related subjects within a broad field because of the resultant cross-fertilization of ideas and correlations. This is especially true in recreation, wherein the resources of the basic disciplines are drawn upon heavily. Most individuals have only the most limited impressions of what life can really hold for them, and it is only as they are given the chance to investigate more than one approach that they can discover their greatest potentials.

The only other departure of recreation education from liberal education is the inclusion in the curriculum of professional courses, usually in amounts not exceeding a third of the total number of hours required for graduation, courses designed to give the student knowledge for helping others toward more gracious, creative and satisfying living.

A well-planned curriculum in professional recreation preparation is soundly based in the social sciences, the arts and the humanities. It adds to these the theory and philosophy of recreation and leisure, several skills in the more popular types of recreation pursuits and the technical information required to competently discover and serve the vast range of people's leisure needs and interests.

The objectives of general education are desirable for *all* members of society and necessary for all students, including those preparing professionally for the field of recreation. No claim is made that recreation education is, or could be by any stretch of the imagination, a substitute for either general education or liberal learning. Nevertheless, a sound curriculum in recreation education provides the kinds of learning experiences which help attain the objectives of general education. Why this is so might be better understood by reflecting upon a few of the recreation education aspects of the "Objectives of General Education," as set forth by the President's Commission on Higher Education.\* These are enumerated here, but lack of space precludes detailed comment.

1. To develop for the regulation of one's personal and civic life a code of behavior based on ethical principles consistent with democratic ideals.
2. To participate actively as an informed and responsible citizen in solving the social, economic, and political problems of one's community, state and nation.
3. To recognize the interdependence of the different peoples of the world and one's personal responsibility for fostering international understanding and peace.
4. To understand the common phenomenon in one's physical environment, to apply habits of scientific thought to both personal and civic problems, and to appreciate the implications of scientific discoveries for human welfare.
5. To understand the ideas of others and to express one's own effectively.
6. To attain a satisfactory emotional and social adjustment.
7. To maintain and improve his own health and to cooperate actively and intelligently in solving community health problems.
8. To understand and enjoy literature, art, music, and other cultural activities as expressions of personal and social experience, and to participate to some extent in some formal, creative activity.
9. To acquire the knowledge and attitudes basic to a satisfying family life.
10. To choose a socially useful and personally satisfying vocation that will permit one to use to the full his particular interests and abilities.
11. To acquire and use the skills and habits involved in critical and constructive thinking.

Perhaps the most lastingly significant observation which can and should be made about the close relation of liberal, general and recreation education is that the last of these complements and supplements the other two. Recreation education is not a substitute for them. It does not weaken them. There is even good reason to believe that, as the new leisure envelops us and recreation education goes beyond the professional preparation of the student to the task of helping all students make better and more satisfying use of their leisure, it will help strengthen liberal and general education—and then not only in terms of serving the educational needs of the future recreation profession but in helping *all* students to learn the art of living wholesome, creative and recreative existences. If and when this happens, we may make leisure contribute to the order and not the disorder of life, or at least help us gain the perspective we need to pay more attention to human values than to material things. ☆

\* President's Commission on Higher Education, *Higher Education for American Democracy*, Volume I, pp. 50-58. December, 1947. Available from U. S. Government Printing Office, Washington 25, D. C.

# NOTES *for the Administrator*

## Cities of the Future

In an article entitled "Five Challenges in Today's New Urban World"<sup>1</sup> Dr. Luther Gulick, president of the Institute of Public Administration, points out that within fifty years the population of the United States is likely to reach 300,000,000. Of this added 132,000,000 people, from eighty to ninety per cent will work and make their homes in and around metropolitan areas. This development within the short span of fifty years will have a staggering impact upon municipal and other local governments, and the difficult problems of today will seem minor ripples compared to the tidal waves already sweeping toward us.

Dr. Gulick asks the following thought-provoking question: "Have you thought what it means in America to see the national productivity and income rise along with the population? Might it not be better to make our cities of 2000 A.D. truly adequate and beautiful than prematurely to shorten the work week further? Make no mistake, this decision could be made by the American people largely in terms of taxation and finance."

## Developing Parks

The National Park Service has made public the recommendations of a survey team which studied the organization and operations of the National Capital Parks. In its report the team stressed the responsibility of the National Capital Parks for developing and promoting a successful system of parks for the nation's capital. It pointed out that NCP is essentially a metropolitan park system and, unlike the other national parks and monuments, must be more directly concerned with meeting the current recreation needs of the District of Columbia metropolitan area as well as providing an embellished setting for government buildings and the preservation of park areas.

The team urged constant study and mutual recognition of the division of responsibility between NCP and the district recreation board. It declared that the recommended classification of parks would lead to clearer understanding of this division of responsibility and would be an influence toward more definite tenure by the recreation board which now uses only such NCP lands for recreation as the NCP permits. "It appears," the report continues, "to be reasonable to expect that, were all elements of recreation of a public nature in the District of Columbia to be administered by the district

<sup>1</sup> In *The American City*, December 1956.

recreation board, greater benefit to the people of the district would result through force of public opinion."

The establishment of five divisions in the office of the superintendent was recommended, with delegation of a large degree of authority and responsibility to the division heads. Proposed divisions are: planning, design and construction; park operations; park police; public use; and administrative. Other recommendations suggest the adoption of a classification system for the parks; a reappraisal of the nature and function of parkways; and the necessity of employing well qualified personnel in such fields as engineering, architecture, landscape architecture and horticulture.

Commenting on the extensive system of concessions and special permits to private operators, the team recommended that steps be taken now to prepare for complete liquidation of private interest by the time present contracts expire.

## Services in School Plant

In an article entitled "School Buildings—Quality Level and Cost,"<sup>2</sup> Charles D. Gibson, president of the National Council on Schoolhouse Construction, comments as follows:

The quality level of the educational services that can be carried on in a school plant is determined by space adequacy—of site, buildings and provisions for flexibility to insure long term functional usefulness. Proper location, size and shape of school sites controls to a large degree educational programs and opportunities. . . . Convenience and adequacy of site largely control the success of supervised recreational programs.

The educational program planned for a site should determine its size. More often than not, false cost analysis reverses the emphasis. Program trends call for more area; school site sizes will continue to be larger.

The educational program also determines the requirements of the buildings to be placed on the site. . . . Time and competence are two cost factors which must be applied to the price of documentation of educational program needs. Far better educational space, at less cost, often results from an intelligent, organized approach to program space needs analysis.

Time and competence must be purchased in developing the master plan of a school site if either educational services or dollar considerations are to be taken seriously. . . . The sacrifice, loss and penalty paid in educational services for the lack of flexibility is immeasurable.

Speaking of the psychological importance of color, proper acoustics and lighting, Dr. Gibson states that with imperfect organs of sight or poor seeing conditions or both, one uses more than one-quarter of his total energy resources for seeing.

## Recreation Services and the Department of Education

Continuous efforts have been made this year to expand the recreation services of the New Mexico Department of Education in keeping with its major purpose of improving the total fitness of all boys and girls in the state as a result their daily educational-recreational experiences. The dominant ideas stressed by the division of health, physical education and recreation in encouraging the development of satisfactory, progressive and challenging local plans and programs are:

1. Give top priority to spending whatever funds are available (earmarked taxes, general appropriations, donations)

<sup>2</sup> *Schools for The New Needs*. F. W. Dodge Corp., 119 West 40th Street, New York. Pp. 312. \$9.75. (See *RECREATION*, October 1957, page 276.)

for leadership, such as professional consultants, part-time or full-time directors. Such persons should be selected solely on their ability to perform specific duties, judged by professional training and previous work experiences.

2. Initiate *coordinated planning* with schools, cities, counties joining hands in providing an area-wide blue print for land acquisition, site planning, selection, design and layout of park-recreation facilities (swimming, parks, gymnasiums, picnic and camping areas, playfields, club rooms, museums, workshops) and selection and placement of appropriate play equipment.

3. Make sure at the outset of any programs that all existing school and community facilities have *maximum use* before embarking upon a construction program. The development of the school as a neighborhood or community center, referred to as the "lighted schoolhouse," and the avoidance of separately operated, duplicate structures or outdoor areas, saves administrative, maintenance and leadership costs. Special and additional facilities can and should be provided after the point of maximum utilization has been reached.

4. An effective, satisfactory or balanced recreation program includes *all types* of indoor and outdoor activities for *all ages throughout the year* without over-emphasizing one type of recreation, such as competitive athletics for boys to the underdevelopment of other phases, such as crafts, hobbies, informal dramatics, camping, and so on.

5. Keep in mind when equipping play areas, especially for small children, that inexpensive, attractive, functional and safe items for play can be provided, locally, by school or recreation personnel, parents and civic groups. The underlying factor is the imaginative use and conversion of available materials (trees, pipes, barrels, autos, tires) on a do-it-yourself basis.

6. Obtain *official recognition* for the field of recreation. This means, in the case of cities and counties, the passage of an ordinance, the creation of a board or a department, the inclusion of a recreation item in the budget. From the standpoint of the schools, it means a statement of board policy, the formulation of a program, and the designation by the superintendent of an individual responsible for the supervision of the program or its coordination with city-county officials.

7. Maintain a *representative citizens' group*, a council, committee or association, including youth, that stimulates thought and action in park-recreation programs and works closely with the school superintendent, city council, park-recreation commission, board of county commissioners, recreation executives, and all local organizations concerned with recreation.

8. Develop a *long-range financial plan* based upon the fact that the schools and the community will have to regard cigarette tax proceeds as a supplement to other sources of income. The earmarked taxes will not be sufficient to depend upon as the sole support for an adequate program.—GEORGIA L. LUSK, *Superintendent of Public Instruction*, and DORO-

THY I. CLINE, *Director, Division of Health, Physical Education and Recreation, New Mexico State Department of Education. From a department Information Letter for local agencies. (For further information regarding New Mexico's expanding recreation picture see RECREATION, September 1956, page 327.)* ☆

| <b>SUBSCRIPTION RATES</b>                                                   |                                           |
|-----------------------------------------------------------------------------|-------------------------------------------|
| Subscription rates for RECREATION magazine are:                             |                                           |
| <b>1 year</b> . . . . .                                                     | <b>\$4.00</b> <b>Library</b>              |
| <b>2 years</b> . . . . .                                                    | <b>7.25</b> <b>subscriptions . . 3.70</b> |
| <b>Foreign</b> . . . . .                                                    | <b>\$4.50</b>                             |
| <b>Club subscriptions</b> . . . . .                                         | <b>\$3.50</b>                             |
| (Ten or more individuals subscribing at one time)                           |                                           |
| <b>Single issues</b> . . . . .                                              | <b>.50</b>                                |
| <b>NATIONAL RECREATION ASSOCIATION, 8 W. Eighth St., New York 11, N. Y.</b> |                                           |

**STATEMENT OF OWNERSHIP**

STATEMENT REQUIRED BY THE ACT OF AUGUST 24, 1912, AS AMENDED BY THE ACTS OF MARCH 3, 1933, AND JULY 2, 1946 (TITLE 39, United States Code, Section 233) SHOWING THE OWNERSHIP, MANAGEMENT, AND CIRCULATION OF RECREATION, published monthly except July and August at Cooper Post Office, New York City, for October 1, 1957.

- The names and addresses of the publisher, editor, managing editor, and business manager are:  
 Publisher: National Recreation Association, 8 West Eighth Street, New York 11, N. Y.  
 Editor-in-Chief: Joseph Prendergast, 8 West Eighth Street, New York 11, N. Y.  
 Editor: Dorothy Donaldson, 8 West Eighth Street, New York 11, N. Y.  
 Business Manager: Alfred H. Wilson, 8 West Eighth Street, New York 11, N. Y.
- The owner is: (If owned by a corporation, its name and address must be stated and also immediately thereunder the names and addresses of stockholders owning or holding 1 per cent or more of total amount of stock. If not owned by a corporation, the names and addresses of the individual owners must be given. If owned by a partnership or other unincorporated firm, its name and address, as well as that of each individual member, must be given.)  
 National Recreation Association, Inc., 8 West Eighth Street, New York 11, N. Y., a non-profit organization. The officers are: F. W. H. Adams, Chairman of the Board; Grant Titsworth, First Vice-President; Susan M. Lee, Second Vice-President; Mrs. Wm. L. Van Alen, Third Vice-President; Adrian M. Massie, Treasurer; Joseph Prendergast, Executive Director. (Addresses care of National Recreation Association, as above.)
- The known bondholders, mortgagees, and other security holders owning or holding 1 per cent or more of total amount of bonds, mortgages, or other securities are: (If there are none, so state.)  
 None (nonprofit organization).
- Paragraphs 2 and 3 include, in cases where the stockholder or security holder appears upon the books of the company as trustee or in any other fiduciary relation, the name of the persons or corporation for whom such trustee is acting; also the statements in the two paragraphs show the affiant's full knowledge and belief as to the circumstances and conditions under which stockholders and security holders who do not appear upon the books of the company as trustees, hold stock and securities in a capacity other than that of a bona fide owner.
- The average number of copies of each issue of this publication sold or distributed through the mails or otherwise, to paid subscribers during the 12 months preceding the date shown above was: (This information is required daily, weekly, semi-weekly, and triweekly newspapers only.)  
 Alfred H. Wilson, Business Manager

Sworn to and subscribed before me this 6th day of September, 1957.

Emily H. Stark, Notary Public, State of New York. No. 41-3813275. Qualified in Queens County, Certificate filed with Queens County Clerk and Register. Term expires March 30, 1959.

ADMINISTRATION

# Research Notes

Muriel E. McGann

## Midget Football Survey

The Michigan Recreation Association has recently completed a survey of midget football for boys eleven to thirteen years of age in the state of Michigan. The two-part questionnaire covered (1) operation of existing programs and (2) opinion of recreation and education authorities on the value of the program.

Twelve cities of the twenty-three replying to the first part reported that they are operating midget football leagues. Teams average six to a city, although one city has 124 teams. All use park and/or school facilities exclusively. Eight cities use the regulation 160' x 360' field; the other four use areas ranging from 40' x 60' to 160' x 240'.

Of the thirty-two responses to the second section of the survey, twenty-three came from city recreation departments and nine from school authorities. Seventeen respondents favored midget football, thirteen were opposed to such a program in any form, and two expressed no opinion. Some of those who opposed tackle-type football for this age group reported that they are operating a successful touch football program. Sixteen of those favoring the program felt that competition should be entirely on the local level; only one had no objection to state, regional or national tournaments.

There was virtually unanimous agreement that all games should be

played after school or on Saturdays, and fifteen cities felt that professional coaches should be employed. Twelve cities indicated that the weight bracket for the specified age group (eleven to thirteen) should be eighty-five to one hundred and ten pounds. Six cities recommended using a field measuring 120' x 240'; five, a regulation field, and four suggested various sizes from 80' x 180' to 160' x 240'. Thirteen cities indicated that a complete uniform should be worn, and nearly all the respondents specified the substitution of rubber gym shoes for regulation leather football shoes.

The consensus seems to be that the acceptability of midget football depends largely on the sponsorship, the degree and type of supervision, and the extent to which outside interests gain control.

## Frequency of Accidents

Many facts worthy of note by recreation workers are contained in *Nature and Frequency of Accidents Among Elementary School Children in New York State*,\* which reports the conclusions of a study by Gerald J. Hase. The study covers ninety-two New York public elementary schools, outside New York City, during a seven-month period. It is confined to accidents occurring in school buildings, or grounds during school hours or in an activity supervised by school personnel before or after hours, and having a follow-up after first aid.

Of the 524 accidents reported, 64 per

cent occurred on the playground and in the gymnasium, although these two areas ranked only seventh and sixth respectively, with regard to severity of injury. Two or more people were involved in 28 per cent of the accidents, the majority of them caused by collisions; either equipment or supply was involved in 27 per cent. Of the 131 accidents attributable to the physical plant, the greatest number resulted from a slip on the floor or ground.

Wrestling, with two accidents in 532 exposures, is the only activity that seems to be hazardous for this age group. In the physical education class instruction program, games had the highest accident rate with 4.7 per 100,000 exposures, followed in order by stunts and tumbling, gymnasium apparatus, rhythms and dance, and body mechanics. No swimming accidents were reported for 1,819 exposures, which probably reflects the special precautions taken to safeguard children in a swimming situation.

It appears that the use of all of the playground apparatus except the giant stride is relatively safe. The developmental apparatus, such as the climbing structure, rings, hanging ladder and hanging bar, had a lower accident rate than recreation apparatus such as teeter, slide, swing and merry-go-round. Fifth- and sixth-grade pupils appear to be less interested in playground apparatus than pupils in the lower grades.

Schools with asphalt or dirt under apparatus had the highest rate for all types of accidents; those with sand, lowest. Unorganized noon-hour play resulted in the highest accident rate.

Among the specific recommendations made were the following:

During free play periods, the number of pupils in any one area should be restricted and carefully supervised; teachers should teach children how to use equipment and supplies safely; all playground apparatus should have some resilient material such as sand underneath it; all areas where noon-hour activities are offered should be properly supervised; the noon-hour program in elementary schools should consist of directed organized play or organized free play or both. ☆

MRS. MCGANN is a member of the National Recreation Association research staff.

\* Published by the University of the State of New York, Albany, N. Y., 1957.

# P E R S O N N E L

## CURRENT COMMENTS

W. C. Sutherland

*U. S. Air Force.* Once in a very great while there is a rare and unusual development that captures the imagination, encourages and inspires the profession. One of these is now taking place in the U. S. Air Force. It was a thrilling and exciting experience to hear Colonel Roland E. Sliker, chief of Air Force Personnel Services Division, explain to delegates at the 39th National Recreation Congress the new concept and policy governing recreation for Air Force personnel and their families. In proclaiming the underlying truth,<sup>1</sup> Colonel Sliker emphasized that Air Force personnel and their families, as American citizens, needed, wanted, and deserved the best recreation possible.

The top commands and the base commands are determined to see that they get it. How? By the logical procedure of putting the recreation function into the hands of qualified professional recreation executives and by bringing modern management principles to the administration of recreation. The plan calls for a recreation department at every Air Force base of reasonable size with an experienced recreation manager in charge. The segmented recreation pieces for the first time are to be coordinated, reinforced, expanded and enriched under a professional recreation manager. Existing positions will be strengthened and broadened to give more professional meaning. The four major commands have appointed recreation supervisors at the top command levels who will service the respective bases and help them establish recreation departments. Recreation in the Air Force now becomes a career for trained leaders under Federal Civil Service, with positions defined to relate to community recreation systems, making possible the free flow of recreation personnel from Air Force to other agencies and vice versa. This new development will be welcomed by all serious professional leaders for it strengthens and broadens the foundation of the recreation profession.

Individuals now registered in our personnel services, and those registering in the future, should indicate whether or not they are interested in opportunities with the Air Force as well as with other types of agencies. The variety of professional recreation positions with the Air Force include: *Recreation supervisor*,<sup>2</sup> command level, salary \$7,570-\$9,290

<sup>1</sup> See also Colonel Sliker's editorial in *RECREATION*, October, 1957.

<sup>2</sup> Very few of these and none available at present.

MR. SUTHERLAND is director of the NRA Recreation Personnel Service.

(Grade 12); *recreation manager*,<sup>3</sup> base command, salary \$5,915-\$7,130 (Grade 10) and \$6,390-\$8,110 (Grade 11) depending upon size of base; *youth activities director*, salary \$4,525-\$5,740 (begins at Grade 7); *club director*, salary \$4,525-\$5,740 (Grade 7).

*National Institute in Recreation Administration.* The solid core of executive leadership in public recreation is determined to grow and develop with the rapid expansion of the leisure time field which demands increasingly modern, efficient functional skills and creative leadership. Top executives setting examples for members of their staffs and less experienced people, and demonstrating that no one, regardless of age or position, needs to stop learning and growing, present one of the most encouraging signs of the times.

The second National Institute in Recreation Administration held at the 1957 Congress, like its predecessor in Philadelphia a year ago, filled its quota of one hundred executives and supervisors with applications placed on reserve. Its theme, "Organizational Teamwork and Creative Leadership," was accented by the excellent Long Beach Recreation Department staff who dealt with the "Coordinated School and Municipal Administrative Pattern," special phases of program, and the securing and financing of facilities. A specialist from industry spoke on the selection and training of supervisors, and the most creative developments of four outstanding recreation agencies were presented by their able executives.

The institute reached its climax with a lively brainstorming demonstration and a rapid-fire lecture with colored slides on how to be creative by Dr. Paul Douglass.

The question has been asked: "How can the National Recreation Association give so much for such a small institute fee?" The answer is found in the fact that no instructors, no lecturers and no committee members receive any honorariums or expense money; and there is no rental fee, since the host city provides, free of charge, the facility which houses and gives privacy to the institute. The institute fee this year included: considerable printed material prepared by the instructors, some of which was mailed for advance study; a copy of *The Annals*; the special institute tour; the institute luncheon and refreshments at the coffee

<sup>3</sup> Qualifications and requirements comparable to those for superintendent of recreation.

break. Even the certificates were designed, individually lettered and provided by the Long Beach Recreation Department without charge to the institute. The temptation is strong to start mentioning names, including the very excellent Institute Committee, but space would run out before we could complete the list.

Suggestions are now being received (please send yours promptly) for subjects, procedures and instructors for the 1958 Institute. Communities have a right to expect their executives to develop in the broad range of functional ability in leadership strength and over-all comprehensiveness. Executive development is pretty much an individual responsibility. General Electric requires its executives to make job specifications for their personal growth. Can we do less than to suggest as much for community leaders and recreation executives? The 1957 Institute had quite a bit to say about those executives and supervisors who spend most of their time passing judgment on fellow workers, always negating and killing ideas of others before they have a chance to develop. As Dr. Douglass stated, "The greatest modern assassin is the person who kills ideas before they are born." Executives who will remain safe from this crime are the ones who continue to study, learn and grow, regardless of age or position.

*The Annals.* This official publication of the American Academy of Political and Social Science devoted its entire September issue to recreation, under the title, "Recreation in the Age of Automation." The 80,000-word volume, written by twenty-seven different leaders, is a handy reference and surveys the field constructively. There are controversial issues as might be expected in such a large volume and considering the scope and number of writers involved. Recreation leaders might enhance the status and understanding of recreation by getting local citizens' groups and women's clubs to use this publication for next year's study book.

*Internships.* The new NRA internship program, started this past year, has enrolled twelve trainees. Five have completed the year's program, received their certificates and are now located in permanent positions. The others will finish during the spring and summer of 1958. Intern vacancies exist and these excellent opportunities will be available for June graduates. Departments participating in the internship program to date are Los Angeles County and Oakland, California, Portland, Oregon, Milwaukee, Wisconsin, and Philadelphia in the community recreation field and the Indiana and California Departments of Mental Health.

*Personnel Standards in Community Recreation Leadership.* This revised and enlarged publication of sixty-one pages should be in every recreation library. Recent requests for information indicate that some have not secured copies. This is the fifth and most comprehensive revision since the report was first published in 1930. Job specifications and personnel standards materials involve twenty-eight different positions—a practical and handy reference for board members, city officials, educators and recreation people.

*Recruiting.* The most encouraging news in this area is the movement toward local state committees. Many of the state recreation societies and associations have established state recruiting committees and a few have worked out scholarship programs. Some major projects are under consideration and much more needs to be done. Recruiting for a profession is not something that can be turned over to one or two agencies for aid. Insofar as recreation is concerned, there must come a new and enlarged sense of responsibility from the profession. We do not need clever techniques as much as a deep concern for the needs of people.

The Association's National Advisory Committee on Recruitment, Training and Placement of Recreation Personnel is concerned with all references in this article. Suggestions for improving the personnel situation are welcome and may be sent to me at the NRA Personnel Service Department or to the new major division chairmen: *Recruitment*—William Lederer; *In-Service Training*—Al Cukierski; *Under-Graduate Education*—Harlan Metcalf; *Graduate Education*—John Hutchinson; *Placement*—Frank Evans.

*Personnel Survey.* The NRA Hospital Recreation Consultant Service reports that the national study to determine the role of recreation in nine thousand hospitals and institutions is well under way. The report is expected to be available in the spring. Although not all are under recreation titles, the early returns indicate that there may be five thousand full-time and another five thousand part-time recreation workers in this field. Like the new developments in the Air Force, this is yet another indication of the growing need and demand for more recreation personnel. ☆

Publications on

PERSONNEL & LEADERSHIP

- 394—COUNSELING WITH YOUNG PEOPLE,  
*C. Eugene Morris* ..... \$3.00
- 401—HOW TO BE A MODERN LEADER,  
*Lawrence K. Frank* ..... 1.00
- 409—LEADERSHIP IN RECREATION,  
*Gerald B. Fitzgerald* ..... 4.00\*
- 410—LEADERSHIP OF TEEN-AGE GROUPS,  
*Dorothy Roberts* ..... 3.00
- 413—METHODS AND MATERIALS IN RECREATION  
LEADERSHIP, *Maryhelen Vannier* . . . . 4.25\*
- 421—RECREATION LEADER'S HANDBOOK,  
*Richard Kraus* ..... 5.75
- 948—PERSONNEL STANDARDS IN COMMUNITY  
RECREATION LEADERSHIP, *National  
Recreation Association* ..... 2.00
- 950—RECREATION LEADERSHIP,  
*W. C. Sutherland* ..... 1.00

\* NRA membership discount of 10% not allowed

RECREATION BOOK CENTER

NATIONAL RECREATION ASSOCIATION  
8 West Eighth Street, New York 11, N. Y.





## On the Campus

### Developments at Illinois

Dr. Charles K. Brightbill, professor of recreation at the University of Illinois, writes of the establishment of a department of recreation (it was formerly a recreation curriculum) at his school. The department is a "primary unit of education and administration"; it is "established for the purpose of carrying on programs of instruction and research in a particular field of knowledge"; and it has "the fullest measure of autonomy consistent with the maintenance of general college and university educational policy. . . ."

Concurrently, the board of trustees has changed the status of the *school* of physical education to *college* of physical education, the title of its director to dean, and established a department of health and safety education. Both new departments remain within the college of physical education.

### Indiana Enrollment

Professor Garrett G. Eppley of the Indiana University School of Health, Physical Education, and Recreation reports the enrollment on both the undergraduate and graduate levels shows a substantial increase over last year, with approximately sixty undergraduate majors and fifteen undergraduate minors. Graduate majors total twenty-eight living on the campus, five driving to the campus for recreation classes offered at night, and ten or more graduates in recreation enrolled in the extension centers. This makes a total of over forty graduates enrolled in recreation as well as a number of doctoral candidates minoring in recreation.

### Scholarships

• The Michigan Recreation Association is now giving six scholarships—

three for \$200 and three for \$100—to juniors and seniors attending Michigan colleges and universities who are majoring or minoring in recreation. These scholarships are currently being given to students enrolled in Michigan State University, Central Michigan College and Eastern Michigan College.

• The second recreation scholarship given by the Evansville Community Center was awarded to Susan Walton. The \$2,000 scholarship is made possible from the \$1.00 year dues of teenage members of the center.

Selection of the winner is one of the projects of the student council of the center, and the winner is determined on the basis of academic achievement, leadership, and participation in extra-curricular activities in high school as well as in other youth agencies. During the summer vacation periods Susan will be employed at the community center as a paid staff leader to gain practical experience in recreation programs. This is the second scholarship offered by the center.

### Wisconsin Registration Plan

On January 1, 1958 a professional registration plan will be established for all recreation leadership personnel in Wisconsin. It is sponsored by the Wisconsin Recreation Association and is to be administered by a five-member professional registration committee headed by H. C. Hutchins, associate professor of education and coordinator of recreation curriculum at the University of Wisconsin.

### Fundamental Education

Nancy Ann Ferguson, a recreation major from Oregon State College, is currently in Mexico for nineteen months

of study and work under a special grant by the U. S. State Department. She is one of five Americans selected for the program, which is conducted at the Latin American Fundamental Education Center at Patzcuaro as a project of the United Nations Educational, Scientific, and Cultural Organization. Some 120 representatives from nineteen Latin American countries and the United States delegation are participating.

The five Americans were selected from the professional fields of recreation, health, homemaking, literacy, and economics. Miss Ferguson, a recreation major, was recommended by the National Recreation Association.

The first seven months of the assignment are devoted to classwork at the education center, followed by eight months of work and observation in rural villages of Mexico. The final four months include study, research, and completion of a thesis. Each participating country finances its own delegation. The U. S. State Department grants cover expenses plus a salary for the nineteen months.

### Internship Vacancies

Of the twelve enrollees under the NRA Internship Program, five have completed their work and received their NRA certification of recognition and the others are finishing their year's work: therefore, vacancies will be available in the summer and fall of 1958. Prospective graduates interested in the program should apply now to W. C. Sutherland, NRA Personnel Service, 8 West 8th Street, New York City 11.

### Summer Work Program

The success of the NRA Student Summer Work Program was led to the consideration of a similar program for the summer of 1958. Last summer ten recreation students in training served on Air Force bases as youth activities directors and leaders, working with military and civilian personnel and their families. Their salaries were paid by the bases and transportation was provided by the Air Force. Both the students and the Air Force found the program a valuable and profitable experience. ☆

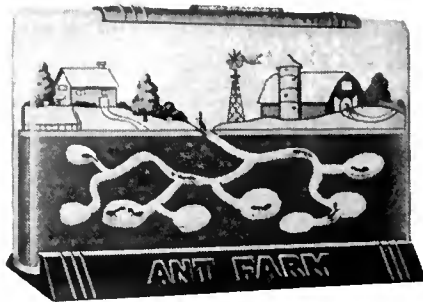

### FASCINATING ANT FARM-\$2.98

An ant's entire world seen through the clear plastic walls of this unbreakable, escape-proof ANT FARM. Have fun watching the busy army of worker ants digging tunnels, building bridges, moving mountains! Large 6" x 9" size. Includes barn, silo, windmill and barnyard where the ants can work and play. Actually a scientifically designed living TV screen that will keep the kids fascinated for hours. Educational! A generous supply of ants included FREE with every ANT FARM, together with a free book, "The Ant Watchers' Manual". Only \$2.98 complete. HOWARD STEVEN CO., 7015 Sunset Blvd., Dept. AH-43, Hollywood 28, California.

### RECREATION THERAPISTS

for California State Hospitals in several locations. Positions open to college graduates with major in Recreation or Recreation Therapy and supervised field work. Monthly salary starts at \$376; promotional opportunities in expanding rehabilitation program to \$644. Liberal employee benefits. Write Medical Recruitment Unit, State Personnel Board, 801 Capitol Avenue, Sacramento, California.



*Jayfro*  
**BASKETBALL  
 STEEL CHAIN  
 NETS**  
 3 Years Guarantee  
 outdoors or indoors

Also featuring Jayfro's custom built  
 ✓ NYLON BASKETBALL NETS & BALL CARRIERS  
 ✓ ALUMINUM MULTI-PURPOSE STANDARDS  
 ✓ TETHERBALL POLES & PADDLE SETS  
 ✓ ALUMINUM SHUFFLEBOARD SETS  
 • Send for Free Catalog •  
**JAYFRO ATHLETIC SUPPLY CO.**  
 Dept. R, Box 1065, NEW LONDON, CONN.

### Recreation Directors

needed by the City of Los Angeles  
**\$395 to \$489 per Month**

College graduate with major in physical education or recreation.

College seniors in their final semester may apply now for a position upon graduation.

Write: ROOM 5, CITY HALL,  
 LOS ANGELES 12

## Hospital Capsules

Beatrice H. Hill

A very successful Congress, co-sponsored by four organizations and the National Recreation Association, was held this year. The sessions pertaining to recreation for the ill and handicapped were numerous and well attended, with attendance ranging from fifty-five to two hundred and fifty-five at each session. There were two workshops, one on group dynamics and one on rhythmical expression, and a very successful "Bazaar of Seasonal Themes for the Ill and Handicapped,"\* with excellent displays, was an informal swap shop of party ideas for this group.

The Hospital Section opened with Dr. Edward Stainbrook, professor and chairman of the Department of Psychiatry at the University of Southern California School of Medicine, discussing "The Hospital—A Therapeutic Community." He said it is essential to develop a "conceptual framework" of a hospital, with a scientific understanding of what goes on within it. It is not just an aggregate of individuals. He emphasized the importance of meaningful communications, saying that how well the therapeutic tasks which hold the community together are accomplished depends upon how well communications are developed between individual staff members as a staff team.

Among other hospital meetings, summaries of which are available from the NRA were: "Hospital Recreation Volunteer—My Training and Supervision," chaired by Lillian Summers, American Red Cross hospital consultant; "Recreation for the Mentally Retarded," chaired by Mrs. Frances Grove, supervisor of recreation at Pacific State Hospital, Pomona, California; "Recreation for Nursing Homes and Homes for the Aged," chaired by Annabelle Story, American Red Cross hospital recreation

\* See "The Congress Story," page 349 (under *Workshops and Demonstrations*).

MRS. HILL is the NRA consultant on hospital recreation.

consultant; "The World from the Patient's Window," with Dr. Charles K. Brightbill, professor of recreation at the University of Illinois, as chairman; "Workshop on Group Process in Hospital Recreation," chaired by Robert Rynearson, director of volunteer activities at the Veterans Hospital, Sepulveda, California, which had three sessions.

The session on "Neurological Involvements for All Ages" was chaired by Birger J. Rudquist, chief of special service, Veterans Administration Hospital, Palo Alto, California, and addressed by Dr. O. Leonard Huddleston, medical director of California Rehabilitation Center and clinical professor of physical medicine at the University of Southern California School of Medicine. The speaker used slides to show a comprehensive study of the structure of the nervous system. He talk involved the structural arrangement of the neurological system and its abnormalities.

The Veterans Administration Workshops were well attended. Just for employees of Veterans Administration Hospitals was "New Horizons for Hospital Recreation." (If readers of "Hospital Capsules" wish to know how and when summaries of the many VA workshops will be distributed, write: L. O. Janssen, Area Chief, Special Service, Veterans Administration, San Francisco, California.)

*Summaries of all other meetings, and transcripts of addresses at general sessions, can be ordered from the National Recreation Association for \$2.50.*

\* \* \* \*

Have you the new listing of publications in our field entitled *Recreation in the Medical Setting?* Are you registered as yet with the Council for the Advancement of Hospital Recreation?

You must be a member of one of the three professional organizations before you can be registered. Several hundred people have already registered and received their formal certification. If you wish information about the various

levels of registration and the requirements, write to: Miss Annabelle Story, Hospital Recreation Consultant, American National Red Cross, Washington, D. C.

\* \* \* \*

One of the best speeches ever given in my opinion, has now been published in pamphlet form and is ready for distribution, through our organization or the University of North Carolina. The speech, by Dr. Joseph B. Wolffe, medical director of Valley Forge Heart Institute and Hospital, Pennsylvania, is entitled *Recreation, Medicine and the Humanities*; and it is an entirely new slant on recreation for the ill and handicapped. A condensation of this appears on pages 364-365 of this issue of RECREATION.

\* \* \* \*

New York City is now considering the position of a recreation director to coordinate and supervise the thirty-two municipal hospitals within its department of hospitals. Let's hope that the budget department will make this possibility become a reality. If this happens, New York City will have the first city-wide hospital recreation director in the country.

### Training

- The National Recreation Association, in conjunction with New York University will hold a seminar, "Recreation for the Homebound Ill and Handicapped" January 29-31, 1958. For further details see inside back cover of this issue.
- The Department of Recreation and Rehabilitation of Columbia University will conduct a course in recreation for the mentally ill in their second semester. For further information write to: Dr. Josephine Rathbone, Associate Professor of Health, and Physical Education, Teachers College, Columbia University, 525 West 120 Street, New York.
- There is an excellent correspondence course concerning administration for hospital recreation directors being given through the University of Minnesota. Write to: Fred Chapman, Assistant Professor of Recreation, University of Minnesota, Minneapolis, Minnesota. ☆

**Wear Your Golden Age Club Pin With  
Pride Wherever You May Go**



Designed by representatives of over 100 Golden Age clubs and used nationally. Gold colored metal with evergreen tree in jewelers' enamel. Symbolic of long life, strength and perseverance. The words LOVE, PLAY, LEARN, SERVE (greatest values of club membership) enameled in black. The border is a laurel wreath for honor. Safety catch.

Available Only to Authentic Clubs.

50c each, minimum order 10 pins.

**James Spencer & Co.** 22 N. 6th Street  
Philadelphia 6, Pa.

## BOOK MANUSCRIPTS

CONSIDERED

by cooperative publisher who offers authors early publication, higher royalty, national distribution, and beautifully designed books. All subjects welcomed. Write, or send your manuscript directly.

**GREENWICH BOOK PUBLISHERS**  
Attn. Mr. Hitchcock 489 Fifth Avenue  
New York 17, N. Y.

## Jamison PLAYGROUND EQUIPMENT

Be sure to check the many exclusive features of this rugged line. Write for free catalog of 254 items.

Jamison Manufacturing Co.  
8731 South Mettler Street  
Los Angeles 3, California

Since  
1925

## Selected RONALD Books . . .

### Intramural and Recreational Sports

For High School and College—2nd Ed.

NORMA M. LEAVITT, *University of Florida*; and  
HARTLEY D. PRICE, *Florida State University*

**January 2.** Activities, practices, policies, and procedures for planning and conducting a program of intramurals in high schools and colleges. With practical emphasis, the book details duties of administrative personnel; ways of organizing tournaments; program management problems; record keeping, point systems, awards. Includes helpful appendix suggestions for preparing an intramural handbook and forms for use in organizing a high school recreation association. 334 pp., 45 charts, record forms. \$4

### Active Games and Contests—2nd Ed.

RICHARD J. DONNELLY, *University of Minnesota*; WILLIAM G. HELMS  
and ELMER D. MITCHELL, *both University of Michigan*

**January 15.** Offering the most complete collection of active games available today, this new book is both a textbook for students preparing for game leadership and a sourcebook for those on the job. The more than 2,000 games and contests described are systematically classified for quick reference, and offer selections adaptable to all occasions and any age level. Richly illustrated. 545 pp., 91 ills., tables. \$5.50

### Recreation Areas, Their Design and Equipment—2nd Ed.

GEORGE D. BUTLER. *Prepared for the National Recreation Association*

**Just Published!** Detailed information on the design and equipment of recreation areas, with emphasis on neighborhood playgrounds, play and athletic fields. 170 illustrations, diagrams, and plans include official layouts of nearly 40 playing courts and fields—plus 14 building floor plans. Fully explains how to incorporate modern apparatus, equipment, and game courts into the area plan. 170 ills., 9 x 12. \$6

### Playgrounds, Their Administration and Operation

Also by GEORGE D. BUTLER

This book discusses the enlarged function of the neighborhood playground; describes revised standards of playground space and leadership. Introduces new and up-to-date programs and outlines current methods of dealing with a variety of playground problems. *Revised Edition.* 459 pp., 21 ills. \$4.75

Order your books from:

**THE RONALD PRESS COMPANY • 15 E. 26th St., New York 10**

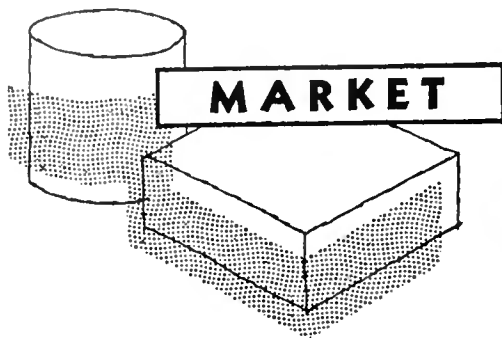

## NEWS

If you are interested in any of these products, write directly to the manufacturer at the address given. PLEASE mention that you read about it on RECREATION magazine's Market News page.

◆ Free help with the junior or adult rifle club was offered in the form of a neat kit by the National Rifle Association of America at their exhibit at the National Recreation Congress in Long Beach. They also distributed attractive reprints of the article which appeared in the September issue of RECREATION, "Sure-Fire Safety in Riflery." These materials are still available singly, and without charge, upon request. Drop them a card at 1600 Rhode Island Avenue, N.W., Washington 6, D. C., and they will send you a check list.

◆ A new table tennis ball dispenser, the TFT Ball Meter, saves valuable leadership time now spent in issuing balls and recording inventory costs. This machine is durably made of metal and hard wood, easily installed, holds 120 balls which it dispenses to players for ten cents each. It is leased free to recreation agencies, and three different grades of balls may be purchased at less than the cost to players. Profit can be used to maintain and replace other table tennis equipment. Free descriptive folder entitled "Stop Wasting Their Time" will be sent on request. T. F. Twardzik and Company, Inc., Shenandoah, Pennsylvania.

◆ Jayfro All-Purpose Nylon Ball Carrier simplifies handling in transporting balls from one place to another. It is manufactured from extra heavy braided nylon cord, is washable and weather resistant, holds as many as eight basketball-size balls at one time. There are two models, an all-purpose one and one with a tighter mesh for footballs. Jayfro has also introduced a basketball net of the same extra heavy braided nylon cord, formed and knotted entirely by hand to official specifications, which has proved through tests to be more serviceable than the conventional net. Jayfro Athletic Supply Company, P. O. Box 1065, New London, Connecticut.

◆ One of the lightest electronic megaphones ever produced, the Pye Transhailer features a germanium transistor amplifier for dependability and is powered by standard flashlight batteries. The Transhailer has a 10½-inch diameter horn, is only 15½ inches long, and its over-all weight with batteries is only five pounds! The megaphone has a maximum power output of 3½ watts, resulting in an operating range of more than a quarter-mile under normal noise conditions, with exceptional voice quality. It is completely self-contained, with speaker, amplifier, batteries and microphone in one sturdy weather-resistant unit, with a pistol grip handle and trigger control. Ideal for athletic contests, maritime and industrial use, or any place where distance and/or background noise hinder voice power or intelligibility. Pye Corporation of America, Telecommunications Division, 270 Park Avenue, New York 17.

◆ A new drink vending machine now on the market delivers a cool cup of either plain milk or flavored milk. The machine has an automatic coin changer; drinks sell for ten or fifteen cents, and size of drink can be adjusted from six to nine ounces. The milk is dispensed from five gallon cans which are sealed by the dairy at the time the dispensing valve is placed on the can. In the machine, the milk is held at a safe low temperature at all times, and has an automatic switch control which prevents sale of milk if, for any reason, the temperature goes above the safety level. Food Engineering Corporation, 25 Bedford Street, Manchester, New Hampshire.

◆ The new *50th Anniversary Monroe Folding Tables Catalog* (No. 350) is especially rich in color illustrations and is larger and more complete than ever. Over sixty different models, sizes and finishes of tables are included, also folding chairs, movable partitions and room dividers; folding risers, platforms and stages. The Monroe Company, 181 Church Street, Colfax, Iowa.

◆ An all new "flush-front" storage locker features a door with recessed handle and ventilating louvers. It has a three-way action latch with a completely retractable padlock loop and pre-locking feature, permitting the door to be locked while open and to lock automatically when closed. The latch plate serves as a padlock striking plate, protecting the locker against digs and scratches. The latch is also designed to receive a built-in master-keyed flat key lock or combination dial lock. The new locker line is available in standard sizes, in flat or slope top styling with a choice of base type and of colors. Aurora Steel Products Company, 208 Third Street, Aurora, Illinois.

◆ A free booklet and two 1958 catalogs are now available from Rawlings Sporting Goods Company. The booklet, entitled *Intramural Handbook*, is directed toward helping persons connected with school intramural programs, recreation programs, and athletic administration in general. The twenty-four page handbook contains complete field and court diagrams, detailed instructions on how to run a tournament and how to arrange a schedule, complete pairings for round robin schedules for four-team to eighteen-team leagues, sources of rules and information, and a table which gives won-lost percentages in a split second. The *1958 Spring and Summer Catalog* discloses a theme keyed to the company's observance of its sixtieth birthday. Interesting features are a section devoted to just boys' equipment, a new easy-to-read index, a baseball uniform weight and color chart, and the industry's buyer's almanac. The company has also released its *1958 Advance Football and Basketball Catalog*. Rawlings Sporting Goods Company, 2300 Delmar Boulevard, St. Louis 3, Missouri. ☆

# Books & Pamphlets Received

- AMERICAN ANTIQUE DECORATION, Ellen S. Sabine. D. Van Nostrand Company, 120 Alexander Street, Princeton, New Jersey. Pp. 131. \$6.95.
- AMERICAN COMMUNITY, THE, Blaine E. Mercer. Random House, 457 Madison Avenue, New York 22. Pp. 304. \$5.00.
- ARCHITECTURE FOR ADULT EDUCATION, Adult Education Association, 743 North Wabash Avenue, Chicago 11. Pp. 74. Paper \$2.00.
- BACKGROUND TO GARDENING, W. O. James. Pitman Publishing, 2 West 45th Street, New York 36. Pp. 224. \$4.50.
- BASEBALL RULES IN PICTURES, G. Jacobs and J. R. McCrory. Grossett & Dunlap, 1107 Broadway, New York 10. Pp. 75. Paper \$1.00.
- BOATS AND OUTBOARDS, Elbert Robberston. Random House, 457 Madison Avenue, New York 22. Pp. 144. \$2.95.
- CAMPSITE FINDER, THE, (Volume 1, West), Richard and Jane Hartesveldt. Naturegraph Company, San Martin, California. Pp. 128. Paper \$1.50.
- CAST OFF THE DARKNESS, Peter Putnam. Harcourt, Brace, 383 Madison Avenue, New York 17. Pp. 253. \$3.95.
- COMPLETE ARCHERY BOOK, THE, Louis Hochman. Arco Publishing, 480 Lexington Avenue, New York 17. Pp. 143. \$2.00.
- CONSTRUCTING AN ASTRONOMICAL TELESCOPE (Second Edition), G. Matt-hewson. Philosophical Library, 15 East 40th Street, New York. Pp. 100. \$3.00.
- COSTUMING FOR THE MODERN STAGE, Laura Zirner. University of Illinois Press, Urbana. Pp. 46. Paper \$3.00.
- CONVERSATIONS WITH CASALS, J. Ma. Corredor. E. P. Dutton, 300 Fourth Avenue, New York 10. Pp. 240. \$5.00.
- DACHSHUNDS, E. Fitch Daghish. Dover Publications, 920 Broadway, New York 10. Pp. 94. \$75.
- DISCIPLINE. Association for Childhood Education International, 1200 Fifteenth Street, N.W., Washington 5. Pp. 36. Paper \$75.
- EASY DOES IT (Program for better health and long life), Harold J. Reilly. Thomas Nelson, 19 East 47th Street, New York 17. Pp. 280. \$3.95.
- EDUCATION FOR SAFE LIVING (Third Edition), Herbert J. Stack and J. Duke Elkow. Prentice-Hall, Englewood Cliffs, New Jersey. Pp. 364. \$5.75.
- FEAR AND PREJUDICE (#245), Selma Hirsh. Public Affairs Pamphlets, 22 East 38th Street, New York 16. Pp. 27. \$.25.
- FIRST AID (1957 Revision), Carl J. Pott-hoff. Boy Scouts of America, New Brunswick, New Jersey. Pp. 82. \$.25.
- FIVE MENTAL HEALTH PROBLEMS. Social Legislation Information Service, 1346 Connecticut Avenue, N.W., Washington 6, D.C. Pp. 7. \$.25.
- FLEXIBLE RETIREMENT, Geneva Mathiasen. G. P. Putnam's Sons, 210 Madison Avenue, New York 16. Pp. 226. \$3.75.
- FOOT TROUBLES, T. T. Stamm. Philosophical Library, 15 East 40th Street, New York 16. Pp. 122. \$4.75.
- GOLF PUBLICATIONS: GOLF FOR INDUSTRY—A Planning Guide, Ben Chlevin; pp. 50; Paper \$1.50. GOLF LESSONS, unpagged, \$.25. GOLF PLAN FOR SCHOOLS, A, Ray Hall; pp. 9; free. HOW TO IMPROVE YOUR GOLF; pp. 72; \$.50. National Golf Foundation, 407 S. Dearborn Street, Chicago 5.
- GUIDE TO THE FISHES OF NEW MEXICO, William J. Koster. University of New Mexico Press, Albuquerque. Pp. 116. Paper \$1.00.
- HOW TO IMPROVE YOUR ARCHERY. The Athletic Institute, 209 South State Street, Chicago 4. Pp. 80. \$.50.
- HOW TO ORGANIZE FOR MORE FUN AFLOAT. Outboard Boating Club of America, 307 North Michigan Avenue, Chicago 1. Pp. 14. Free.
- HUNTING WITH THE CAMERA, Allan D. Cruickshank, Editor. Harper & Brothers, 49 East 33rd Street, New York 16. Pp. 215. \$4.50.
- I DRIVE THE TURNPIKES AND SURVIVE, Paul W. Kearney. Ballantine Books, 101 Fifth Avenue, New York 3. Pp. 148. \$.35.
- INTELLECTUALLY GIFTED, THE (Reprinted from *Special Education for the Exceptional*), Merle E. Frampton and Elena D. Gall. Porter Sargent, 11 Beacon Street, Boston 8. Pp. 46. \$1.00 per copy.
- IRONWORKS ON THE SAUGUS, E. H. Hartley. University of Oklahoma Press, Norman. Pp. 328. \$4.50.
- KANGCHENJUNGA — THE UNTRODDEN PEAK, Charles Evans. E. P. Dutton, 300 Fourth Avenue, New York 10. Pp. 187. \$5.95.
- KEY TO THE STARS, A, (Third Edition), R. van der Riet Woolley. Philosophical Library, 15 East 40th Street, New York 16. Pp. 144. \$4.75.
- LAWN AND GARDEN BOOK, C. Robert Bilbrey, Editor. Popular Mechanics Press, 200 East Ontario Street, Chicago 11. Pp. 192. \$2.50.
- LEADER'S GUIDE TO NATURE AND GARDEN FUN, A, Ernestine S. Coffey and Dorothy F. Minton. Hearthside Press, 118 East 28th Street, New York 16. Pp. 127. \$2.75.
- LONG DISTANCE SWIMMING, Gerald Forsberg. Philosophical Library, 15 East 40th Street, New York 16. Pp. 189. \$4.75.
- MAGNIFICENT YANKEES, THE (Revised Edition, 1957), Tom Meany. Grossett & Dunlap, 1107 Broadway, New York 10. Pp. 214. \$1.25.
- MATHEMATICAL PUZZLES AND PASTIMES, Philip Haber, Editor. Peter Pauper Press, 629 MacQuesten Parkway, Mount Vernon, New York. Pp. 62. \$1.00.
- MEASUREMENT IN PHYSICAL EDUCATION, Francis Stroup. Ronald Press, 15 East 26th Street, New York 10. Pp. 192. \$3.50.
- METHODS AND MATERIALS IN ELEMENTARY PHYSICAL EDUCATION, Edwin Jones, Edna Morgan and Gladys Stevens. World Book Company, Yonkers-on-Hudson, New York. Pp. 432. \$4.25.
- MODERN APPLIED PHOTOGRAPHY, G. A. Jones. Philosophical Library, 15 East 40th Street, New York 16. Pp. 162. \$4.75.
- MODERN DANCE FOR HIGH SCHOOL AND COLLEGE, Margery J. Turner. Prentice-Hall, Englewood Cliffs, New Jersey. Pp. 181. \$3.75.
- MOVEMENT FUNDAMENTALS: FIGURE, FORM, FUN, Janet A. Wessel. Prentice-Hall, Englewood Cliffs, New Jersey. Pp. 270. Paper \$3.75.
- MOZART AND MASONRY, Paul Nettl. Philosophical Library, 15 East 40th Street, New York 16. Pp. 150. \$4.75.
- NATURE TRAIL LABELS, Leslie M. Reid. American Institute of Park Executives, Oglebay Park, Wheeling, West Virginia. Pp. 47. \$.50.
- OBSERVER'S BOOK OF MUSIC, THE, Freda Dinn. Warne Publications, 210 Fifth Avenue, New York 10. Pp. 190. \$1.25.
- ON CALL FOR YOUTH, Rudolph Wittenberg. Association Press, 291 Broadway, New York 7. Pp. 241. \$3.50.
- 1000 PLEASURE SPOTS IN BEAUTIFUL AMERICA, Marilyn Field and J. George Frederick. Business Bourse, 80 West 40th Street, New York 18. Pp. 245. \$3.85.
- PHYSICAL EDUCATION IN THE ELEMENTARY SCHOOL CURRICULUM, Arthur G. Miller and Virginia Whitcomb. Prentice-Hall, Englewood Cliffs, New Jersey. Pp. 331. \$5.75.
- PLAYGROUND MUSIC (Musical games), Madeline Carabo-Cone. Playground Music, 866 Carnegie Hall, New York 19. Pp. 14. Paper \$1.00.
- POCKET ENCYCLOPEDIA OF MUSIC, Harry Dexter and Raymond Tobin, Editors. Philosophical Library, 15 East 40th Street, New York 16. Pp. 160. \$2.75. ➡

POSTURAL AND RELAXATION TRAINING IN PHYSIOTHERAPY AND PHYSICAL EDUCATION, John H. C. Colson. Charles C. Thomas, 301-27 East Lawrence Avenue, Springfield, Illinois. Pp. 105. \$2.50.

PUBLIC HUMAN RELATIONS AGENCIES—1957. Anti-Defamation League of B'nai B'rith, 515 Madison Avenue, New York 22. Pp. 31. Paper \$ .75.

READING THE LANDSCAPE, May Theilgaard Watts. Macmillan Company, 60 Fifth Avenue, New York 11. Pp. 230. \$4.75.

REPORT OF THE PROCEEDINGS, A, (39th Annual Meeting). American Institute of Planners, 34 Brattle Street, Cambridge 38, Massachusetts. Pp. 69. Paper \$3.50.

RIVER OF LIFE, THE (Story of earth's living things), Rutherford Platt. Simon and Schuster, 630 Fifth Avenue, New York 20. Pp. 309. \$5.00.

ROADS AND TRAILS OF OLYMPIC NATIONAL PARK, Frederick Leissler. University of Washington Press, Seattle 5. Pp. 84. \$1.75.

ROGER WILLIAMS AND MARY (Drama for three players), Albert Johnson. Friendship Press, 257 Fourth Avenue, New York 10. Pp. 48. Paper \$ .75.

ROUNDERS. Sport Shelf, 10 Overlook Terrace, New York 33. Pp. 33. Paper \$ .75.

SECRETS OF LIFE (A Walt Disney True-Life Adventure), Rutherford Platt. Simon and Schuster, 630 Fifth Avenue, New York 20. Pp. 124. \$3.50.

SELECTING SUPERVISORS FOR THE PUBLIC SERVICE (Personnel Report #551), John M. Pfiffner, Joseph W. Hawthorne and Harold Fields. Public Personnel Association, 1313 East 60th Street, Chicago 37. Pp. 25. Paper \$1.00.

SIMPLE SKETCHING, L. A. Doust. Frederick Warne, 210 Fifth Avenue, New York 10. Pp. 76. \$1.50.

SNAKES AND SNAKE HUNTING, Carl Kauffeld. Doubleday & Company, 575 Madison Avenue, New York 22. Pp. 266. \$3.95.

STARLIGHT AND STORM (Mountain climbing), Gaston Rebuffat. E. P. Dutton, 300 Fourth Avenue, New York 10. Pp. 189. \$5.50.

STORY OF THE ROCKS, THE, Dorothy Shuttlesworth. Doubleday, Garden City, New York. Pp. 56. \$2.95.

SUPERHIGHWAYS—HOW TO DRIVE THEM, Paul W. Kearney. Birk & Company 22 East 60th Street, New York 22. Pp. 15. \$ .15 (minimum 20 copies).

TEACHING CAN BE FUN, E. Harlan Fischer. William-Frederick Press, 313

West 35th Street, New York 1. Pp. 39. Paper \$1.50.

TEACHING JOHNNY TO SWIM (Manual for parents). Available from local Red Cross Chapters. Pp. 31. \$ .20.

TROPICAL FISH, Lucile Quarry Mann. Sentinel Books, 112 East 19th Street, New York 3. Pp. 130. Paper \$ .95.

UNCONQUERED SEMINOLE INDIANS, THE, Irvin M. Peithmann. Great Outdoors Association, 9520 Gulf Boulevard, St. Petersburg, Florida. Pp. 95. Paper \$1.00.

UNDERSTANDING MAPS, Beulah Tannenbaum and Myra Stillman. Whittlesey House, 330 West 42nd Street, New York 36. Pp. 144. \$2.75.

U.S. AVIATION TODAY (1957 Edition). National Aviation Education Council, 1025 Connecticut Avenue, N.W., Washington 6, D.C. Pp. 94. \$ .35.

WE CAME TO CAMP IN WASHINGTON STATE PARKS. State Parks and Recreation Commission, Box 335, Olympia, Washington. Pp. 44. Free.

WHAT DID I DO? (Play on family living), Nora Stirling. Human Relations Aids, 1790 Broadway, New York 19. Pp. 40. \$1.25.

WORK PLACE FOR LEARNING, Lawrence B. Perkins. Reinhold Publishing, 430 Park Avenue, New York 22. Pp. 62. \$4.00.

WORK-PLAY PROGRAM FOR THE TRAINABLE MENTAL DEFICIENT, A (Reprint), Dorothy Cleverdon and Louis E. Rosenzweig. Play Schools Association, 41 West 57th Street, New York 19. Unpagged. \$ .20.

YMCA WATER SAFETY AND LIFESAVING, Harold T. Friermood. Association Press, 291 Broadway, New York 7. Pp. 48. \$ .50.

YOUR OWN BOOK OF NATURE AND GARDEN FUN, Ernestine S. Coffey and Dorothy F. Minton. Hearthsides Press, 118 East 28th Street, New York 16. Pp. 63. \$1.75.

YOURS IS THE POWER, Florence Widutis, The Pilgrims, Box 495, Somerville, New Jersey. Pp. 224. \$3.50.

YOUTH AND CRIME, Frank J. Cohen. Editor. International Universities Press, 227 West 13th Street, New York 11. Pp. 273. \$6.00.

WILDLANDS IN OUR CIVILIZATION. Sierra Club, 2061 Center Street, Berkeley 4, California. Published monthly except July and August. \$3.00 to non-members (included in member's dues).

## Magazine Articles

WOMAN'S DAY, November 1957  
Record Hop, Susan Bennett Holmes.  
How to Build a Jazz Record Collection, Eddie Condon.

PARENT'S, October 1957  
What Will They Do with Their Increasing Leisure? Margaret Albrecht.

PUBLIC MANAGEMENT, July 1957  
The Challenge of Automation for Cities, Edwin S. Howell.

NEA JOURNAL, October 1957  
More Time Tomorrow, Dr. Gerald Wendt.

Can TV Teaching Make a Difference? Dr. Alexander J. Stoddard.  
Gently by the Ears (Public speaking), Dr. Loren Reid.

ALA BULLETIN, July-August 1957  
The New Bookmobile, Earl H. Gray.

## INDEX OF ADVERTISERS

|                                           | PAGE |
|-------------------------------------------|------|
| All Metal Tennis Table Company            | 347  |
| American Playground Device Company        | 345  |
| Beltz Engineering Laboratories            | 345  |
| California State Personnel Board          | 382  |
| Exposition Press                          | 345  |
| Greenwich Book Publishers                 | 383  |
| Jamison Manufacturing Company             | 383  |
| Jayfro Athletic Supply Company            | 382  |
| Los Angeles City Civil Service Commission | 382  |
| Monroe Company                            | 341  |
| New York Diabetes Association             | 361  |
| Newcomb Audio Products Company            | 344  |
| Nissen Trampoline Company                 | 347  |
| Parks & Recreation                        | 345  |
| The Ronald Press                          | 383  |
| Simon and Schuster                        | 341  |
| James Spencer & Company                   | 383  |
| Howard Steven Company                     | 382  |
| Superior Industries Corporation           | 345  |
| T. F. Twardzik & Company                  | 341  |
| Voit                                      | 347  |
| X-acto, Inc.                              | 347  |

## Periodicals

SWIMMING POOL ANNUAL (25th Edition). Swimming Pool Age, 425 Fourth Avenue, New York 16. Pp. 402. Subscription: two years, \$8; one year, \$5.



## PUBLICATIONS

*Covering the Leisure-time Field*

### **Laughter Is a Wonderful Thing**

Joe E. Brown, as told to Ralph Hancock. A. S. Barnes, 232 Madison Avenue, New York 16. Pp. 312. \$4.95

After Joe E. Brown's hilarious talk at the 39th National Recreation Congress in Long Beach (and his "casual" reference to his book), we feel our readers, and especially the delegates, will be interested in hearing more about it. Although it was published in 1956, there are many who have not seen it.

Joe E. Brown fits easily and well into the recreation picture, for, in addition to being a member of the Los Angeles Recreation Commission and a national sponsor of the National Recreation Association, he is a man of laughter. He loves it, and he inspires it—good-natured, rollicking, and even affectionate, laughter. This book, his autobiography, is the tender story of a father and of his family. As you read it, you will laugh some, but more often you'll be serious; and you will know him so much better—this humanitarian and beloved comedian!

### **New Understandings of Leadership**

Murray G. Ross and Charles E. Hendry. Association Press, 291 Broadway, New York 7. Pp. 158 \$3.50.

This book covers a wide range of material and through its many references and bibliographies will call the reader's attention to many important publications on leadership. In fact, it is a summary of recent thinking and research on the nature and meaning of leadership. The authors have reviewed a large number of studies and have drawn on many sources for their information.

The book is organized into three parts. Part One deals with theories of and clarifies many of the new concepts of leadership; Part Two deals with the requirements of leadership in terms of personality, special qualities, and skill; Part Three discusses the leader's role and the development of a leadership program.

The authors point out a fact all too frequently overlooked—that a leader-

ship development program is not only complex and time-consuming, but it costs money. We are accustomed to the fact that more tangible items, such as a building, require much preparation and the skills of architects, engineers and construction workers, all of which adds up to a considerable sum. However, this same acceptance of cost is not readily understood when it comes to the less tangible matter of training and developing leaders. Perhaps the more we learn about leadership and understand it, the more we will be able and willing to invest time and money wisely in the staff development and leadership aspects of the job. Apparently, it is this lack of understanding of leadership that is responsible for so many ineffective leadership training programs. We recommend this book to all those who may have jurisdiction over others as another helpful aid to the understanding of the leadership phenomenon.—*W. C. Suherland, NRA Recreation Personnel Service.*

### **101 Money Making Ideas for Clubs**

Nellie Zetta Thompson. Public Affairs Press, 419 New Jersey Avenue, S.E., Washington, D.C. Pp. 50. Paper, \$1.00.

Scores of ways whereby your organization can raise money for worthy causes are spelled out in this book by Dr. Nellie Z. Thompson which is just off the press. It not only specifies projects with concrete details, but it also discusses plans, problems and policies. The interests and needs of practically every type of group are taken into consideration.

### **The Science of Skin and Scuba Diving: Adventuring with Safety Under Water**

Developed by Conference for National Co-Operation in Aquatics. Association Press, 291 Broadway, New York 7. Pp. 306. \$3.95.

Here is authoritative information for the people who are interested in know-

ing about adventuring with safety under water. Developed by the Conference for National Co-Operation in Aquatics, in which the National Recreation Association is a member, this volume was prepared by outstanding authorities, including Army and Navy experts, medical specialists and experienced divers and trainers from all parts of the country. It is the first standard guide on skin and scuba (self-contained underwater breathing apparatus) diving and its purpose is to insure safe and scientific diving as a hobby, sport or vocation.

Among the subjects treated are the medical aspects of diving, gases used for scuba, types of apparatus, currents, visibility and marine life, first aid for diving accidents, scuba training techniques and club organization.

This book is required reading for all who are interested in this rapidly growing sport.—*George D. Butler, NRA Research Department.*

### **Seven Steps to Creative Children's Dramatics\***

Pamela Prince Walker. Hill and Wang, 104 Fifth Avenue, New York 11. Pp. 150. \$3.00.

Our readers may remember the article by Pamela Walker, "Lively Ideas for the Summer Play," in the April 1957 issue of RECREATION. As that article—and this book—indicates, Mrs. Walker does not write from any ivory tower. She is well-trained in drama and has worked in this field a number of years.

This book was written while she was drama and dance director for the recreation department in Charlottesville, Virginia. It makes delightful reading because the author remembers and knows what goes on inside a child's mind. She explains in simple, informal style the techniques of awakening interest of his senses, of expressing himself through movement, and of developing a better understanding of himself and the world around him. Teachers, recreation readers and anyone interested in children's drama will be delighted with this book.

We read it with great interest while it was in manuscript form, and asked Grace Stanistreet, well-known specialist in creative dramatics, and NRA specialist Grace Walker to evaluate it before we recommended it to a publisher. Their response was complete agreement as to the soundness and the value of this book. It is made even more valuable by the inclusion of three original dramatizations for children—plays that can be put into immediate use.—*Virginia Musselman, NRA Program Service.* →

## CHILDREN'S BOOKS

Christmas belongs to the children: and what better time of year to give them books—the keys to learning, adventure, make-believe?

*How the Grinch Stole Christmas!* Dr. Seuss. Random House, 457 Madison Avenue, New York 22. Unpaged. \$2.50.

Another delightfully imaginative book for the very young, about the Who's of Whoville, by the well-known children's author, Dr. Seuss. The Grinch, who hated Christmas, tried to stop it—but he found he couldn't! Attractively illustrated in red, and black and white.

*Praying Mantis*, Harriet E. Huntington. Doubleday & Company, Garden City, New York. Pp. 44. \$2.00.

A boy around eight or nine who is fascinated with the wonders of nature would love this. It would also be a worthwhile addition to any nature library. Every other page carries a beautiful photograph of this insect that is so much like an animal.

*The Bird Watchers*, Marjory Bartlett Sanger. E. P. Dutton & Company, 300 Fourth Avenue, New York 10. Pp. 164. \$2.75.

Older children will like this absorbing story based on a love of birds, which grew out of the installation of a bird feeder at Christmas time. The author, Mrs. Sanger, does editorial work for the Massachusetts Audubon Society.

*Dear Garbage Man*, Gene Zion (pictures by Margaret Bloy Graham). Harper & Brothers, 49 East 33rd Street, New York 16. Unpaged. \$2.00.

This is one of those juvenile books with equal appeal for the adults who are still young in heart. Stan, the new garbage man, has all sorts of funny adventures when he tries to save discarded objects from his truck's chewer-upper. His saving spree reaches a logical and inevitable climax. The many bright, detail-filled sketches by Margaret Bloy Graham provide half of the story and endless amusement.

## PAPER SCULPTURE

*Paper Figures Based On Children's Artwork*. Anna Pauli and Margaret S. Mitzit, pp. 102, paper \$2.00; and *Paper Sculpture and Construction*, J. V. Miller, pp. 56, paper \$1.50. Charles A. Bennett Company, 237 North Monroe Street, Peoria, Illinois. *Sculpture in Paper*, Bruce Angrave, pp. 96, \$6.50. Studio Publications, 432 Fourth Avenue, New York 16.

Paper, said to have been invented in China back in 105 A.D., has been used

in decoration and design throughout the centuries. Many who have been in China, Japan or Korea remember the amazing paper folding that even small children there do so easily. Many who have visited Poland, Mexico, and the Scandinavian countries remember the intricate and beautiful paper cutting and folding of those countries.

As an art medium, paper is light and springy. It can assume only very simple forms—cones, cylinders, box shapes, and curved scored shapes. It is two dimensional; but, even with these limitations, more and more artists are finding it a most exciting art form and a most popular medium for displays and promotion work. Craft leaders have discovered again that it is a medium through which children can express their best creative and imaginative power.

Here are three books, listed in the order of the simplicity of their projects and teaching techniques. The first is primarily for use with elementary school children. Its projects are clever, original, simple, and full of imagination. Any teacher or craft leader could use it as a starting point, from which children will take over with pleasure.

The second presents a combination of simple paper cutting and paper sculpture, leading into free space designs. This book, too, can be used by leaders fairly inexperienced in this medium.

Both books are well illustrated with photographs and include many directions showing the necessary steps.

The third book is something else again. It is one of the "Studio How-To-Do-It" series, and its author is an artist, outstanding in England for his imaginative and novel paper sculpture, sought after by stores, manufacturers and decorators. It deals with professional paper sculpture, and would be extremely valuable to college or other art classes seriously interested in this area of art work.

It is fascinating to read; the photography is superb. The section on the outstanding paper sculptors, their styles and photographs of their work is fascinating. Anyone can enjoy this book, but only a trained artist could make use of the instructional material in it.

EDITOR'S NOTE: In considering doing more in paper work, don't forget *How To Make Shapes In Space* by Toni Hughes, reviewed in RECREATION, April 1957.

## The Outdoor Encyclopedia\*

Ted Kesting. A. S. Barnes and Company, 232 Madison Avenue, New York 16. Pp. 433. \$7.50.

This is advertised as "a complete

guide to outdoor adventure." It is just that, and a marvelous reference book and work tool for your professional library. It contains chapters on outdoor accessories, photography and equipment, nature, pack trips, first aid, cooking, travel, public lands, camp grounds, and camping, cabin building, maps of the Appalachian Trail, Pacific Crest Trailway, among the many subjects covered. Even weather is not left out. Some of the sports included are: winter, underwater, mountain climbing, archery, boating. Material is presented with an imaginative flair and makes interesting reading. Profusely illustrated. This is a *must* for recreation leaders..

## Christmas Songs and Their Stories

Edited by Herbert H. Wernecke. Westminster Press, Witherspoon Building, Philadelphia 7. Pp. 128. \$2.50.

A collection which is primarily interesting for the inclusion of the too-little-known facts about each Christmas song. Words are given for fifty-four songs and carols, but no music. For use in program planning, a special listing classifies the songs in national and racial groups. It reveals that they come from the United States, Bohemia, England, France, Germany, India, Ireland, Scotland, Sicily, Silesia, and Wales.

## The Seventeen Book of Young Living

Enid A. Haupt. David McKay Company, Inc., 55 Fifth Avenue, New York 3. Pp. 237. \$4.95.

This book does not fit into the usual pattern of books reviewed here, but we felt that it was too good not to call to the attention of our readers. It is written specifically for young people—but anyone working with young people will find it very revealing, and useful in understanding and helping that difficult-to-work-with group.

It is written with wit, informality, realism and sympathy. Its contents will be the answer to many teen-agers finding the growing-up process full of problems.

Recreation leaders will be particularly interested in those chapters dealing with parties for girls, mixed parties, getting along with adults, manners, and an entire section on entertaining. Leaders can also use this book as a basis for special charm or better-grooming classes.

And, finally, any leader with a teenage daughter or niece or friend will find it an excellent gift idea for Christmas, a birthday, or any other occasion.

\* Available from the NRA Recreation Book Center, 8 West Eighth Street, New York 11.



# Recreation

January-December 1957

Index to Volume L

\* Short item or article of less than one page

|                                                                                                                                                                      | Month     | Page |                                                                                                                                                             | Month     | Page |
|----------------------------------------------------------------------------------------------------------------------------------------------------------------------|-----------|------|-------------------------------------------------------------------------------------------------------------------------------------------------------------|-----------|------|
| <b>Administration</b>                                                                                                                                                |           |      |                                                                                                                                                             |           |      |
| Arizona State Parks Board Created*                                                                                                                                   | September | 246  | Forty-Five Thousand Swimming Pools*                                                                                                                         | March     | 80   |
| Business Procedures in Pool Operation, <i>C. P. L. Nicholls</i>                                                                                                      | May       | 180  | Here and There with Swimming Pools, <i>George D. Butler</i>                                                                                                 | May       | 177  |
| Concession vs. Direct Operations, <i>Ralph M. Hileman</i>                                                                                                            | April     | 150  | Recent Experimentation*                                                                                                                                     | April     | 154  |
| Court Decisions Affecting Swimming Pools                                                                                                                             | June      | 232  | Topeka's New Pool Pays its Way, <i>Muriel E. McGann</i>                                                                                                     | May       | 178  |
| Current Comments, <i>W. C. Sutherland</i>                                                                                                                            | December  | 379  | Unique Pool Feature*                                                                                                                                        | October   | 303  |
| Danger Spots*                                                                                                                                                        | April     | 133  | (See also: Administration; Camping; Parks and Conservation; Playgrounds; Schools; Sports)                                                                   |           |      |
| Evaluation in Recreation - Playgrounds*                                                                                                                              | April     | 149  | <b>Arts and Crafts</b>                                                                                                                                      |           |      |
| "Grass Roots" Recreation, <i>Charles H. Odgaard</i>                                                                                                                  | December  | 362  | Christmas Classes and Crafts                                                                                                                                | November  | 328  |
| Here and There with Swimming Pools, <i>George Butler</i>                                                                                                             | May       | 176  | Display and Decoration Ideas, <i>Mary Frances Sargent</i>                                                                                                   | October   | 294  |
| Latest Agency Information                                                                                                                                            | January   | 26   | How To Do It! <i>Frank A. Staples</i>                                                                                                                       |           |      |
| Legal Notes and Court Decisions                                                                                                                                      | November  | 335  | Lacquer Batik                                                                                                                                               | January   | 22   |
| Los Angeles Recreation and Park Bond Issue*                                                                                                                          | June      | 198  | Decorative Painting on Wood                                                                                                                                 | February  | 50   |
| Milestones*                                                                                                                                                          | December  | 360  | Bone Carving                                                                                                                                                | March     | 102  |
| Newspapers and Recreation, <i>W. H. Wallace</i>                                                                                                                      | January   | 14   | Carving with Plaster of Paris                                                                                                                               | May       | 182  |
| Notes for the Administrator                                                                                                                                          | April     | 152  | Making a Banjo                                                                                                                                              | June      | 224  |
|                                                                                                                                                                      | June      | 231  | How to Make a Mosaic                                                                                                                                        | October   | 298  |
|                                                                                                                                                                      | October   | 303  | A Mobile                                                                                                                                                    | November  | 332  |
|                                                                                                                                                                      | November  | 335  | Printing With Plaster of Paris                                                                                                                              | December  | 372  |
|                                                                                                                                                                      | December  | 379  | Inexpensive Nature Materials for Crafts                                                                                                                     | March     | 103  |
|                                                                                                                                                                      | June      | 228  | Last Minute Holiday Hints                                                                                                                                   | December  | 366  |
| Park Acreage to Population                                                                                                                                           | June      | 228  | May Party—On Rubber Wheels, <i>A. Lucy Muir</i>                                                                                                             | May       | 183  |
| Per Capita Expenditures for Recreation and Parks in 1955, <i>Muriel E. McGann</i>                                                                                    | February  | 57   | Maypole Dance, <i>The, Olga Kulbisky</i>                                                                                                                    | April     | 140  |
| Personal Touch in Day Camping, <i>The, Patrick J. Carolan</i>                                                                                                        | March     | 74   | Nature Crafts Year 'Round, <i>Alice Howenstine</i>                                                                                                          | September | 264  |
| Planning for Recreation Parks in California—A Guide (Book Review), <i>George Butler</i>                                                                              | January   | 25   | People-to-People International Friendship Activities*                                                                                                       | April     | 114  |
| Playground Facts and Fun                                                                                                                                             | April     | 124  | Pick Up Your Sketch Book, <i>Norman Garbo</i>                                                                                                               | May       | 172  |
| Playground for Mentally Handicapped Children, <i>The, Harold W. Perry</i>                                                                                            | April     | 128  | Playground Indian Village, <i>A*</i>                                                                                                                        | April     | 142  |
| Policy, A Matter of                                                                                                                                                  | September | 268  | Programs on Exhibition, <i>Catherine Simpson</i>                                                                                                            | January   | 21   |
| Public Relations in Recreation, <i>Richard M. Baker</i>                                                                                                              | October   | 300  | We Celebrate Hallowe'en—But Do We Know Why?                                                                                                                 | October   | 287  |
| Recreation Developments in 1956, <i>Charles E. Reed</i>                                                                                                              | June      | 212  | <b>Athletics</b>                                                                                                                                            |           |      |
| Recreation in the Age of Enjoyment, <i>Paul F. Douglass</i>                                                                                                          | November  | 312  | (See: Safety and Health; Sports)                                                                                                                            |           |      |
| Recreation Space in Subdivisions                                                                                                                                     | February  | 55   | <b>Audio-Visual Materials and Program</b>                                                                                                                   |           |      |
| Regional Recreation Perspectives, <i>Robert D. Carpenter</i>                                                                                                         | November  | 333  | Films and Filmstrips:                                                                                                                                       |           |      |
| Safety Program Recommendations, <i>James E. Bonaboom</i>                                                                                                             | April     | 149  | Adventuring in the Handicrafts*                                                                                                                             | March     | 93   |
| School Building Expenditures*                                                                                                                                        | March     | 80   | Planning Recreation Facilities*                                                                                                                             | September | 246  |
| Selected Planning Trends*                                                                                                                                            | October   | 304  | Song Slides Available*                                                                                                                                      | March     | 72   |
| Some Yardsticks—For Relating Participation to Costs, <i>H. C. Hutchins</i>                                                                                           | January   | 23   | Taking Piano Lessons from Films*                                                                                                                            | May       | 168  |
| Survey Leads to Action, <i>A, Pat Perkinson</i>                                                                                                                      | February  | 53   | UNICEF Hi Neighbor Program*                                                                                                                                 | May       | 168  |
| Teen-Agers at Work*                                                                                                                                                  | April     | 152  | Uphold the 97, To*                                                                                                                                          | June      | 215  |
| Topeka's New Pool Pays Its Way, <i>Muriel E. McGann</i>                                                                                                              | May       | 178  | Work, Learn, Serve*                                                                                                                                         | March     | 93   |
| Town Meeting With Delinquents, <i>A, Robert L. Smith</i>                                                                                                             | April     | 131  | <b>Radio:</b>                                                                                                                                               |           |      |
| What You Can Do About Encroachment*                                                                                                                                  | June      | 206  | "Action for Peace in Our Town" Contest*                                                                                                                     | May       | 168  |
| (See also: Areas, Equipment, Facilities, Layout; Camping; Handicapped; Parks; Personnel; Playgrounds; Program Planning; Public Relations; Research; Schools; Sports) |           |      | <b>Automation and Increased Leisure</b>                                                                                                                     |           |      |
| <b>Aging</b>                                                                                                                                                         |           |      |                                                                                                                                                             |           |      |
| Activities in the Golden Years                                                                                                                                       | February  | 43   | Automation*                                                                                                                                                 | February  | 34   |
| Adapting Dancing for Senior Citizens, <i>Cyrus S. Grossman</i>                                                                                                       | October   | 289  |                                                                                                                                                             | November  | 317  |
| Community Self-Evaluation*                                                                                                                                           | November  | 316  | Challenge to the Nation*                                                                                                                                    | April     | 122  |
| Christmas Tour for Golden-Agers*                                                                                                                                     | December  | 367  | Danger of Uniformity, The*                                                                                                                                  | June      | 200  |
| Danger Spots*                                                                                                                                                        | April     | 133  | Four-Day Week, The                                                                                                                                          | June      | 200  |
| Location of Facilities for Senior Citizens Clubs, <i>Ronald D. Johnson</i>                                                                                           | September | 266  | New Dimensions in Recreation, <i>Joseph Prendergast</i>                                                                                                     | June      | 199  |
| Senior Citizen Month*                                                                                                                                                | April     | 114  | Outsider Looks at Recreation, <i>An, Harold W. Williams</i>                                                                                                 | November  | 318  |
| Three Thousand a Day*                                                                                                                                                | April     | 133  | Recreation in the Age of Enjoyment, <i>Paul F. Douglass</i>                                                                                                 | November  | 312  |
| <b>Areas, Equipment, Facilities, Layout</b>                                                                                                                          |           |      |                                                                                                                                                             |           |      |
| Brighten that Dark Corner, <i>Mary Frances Sargent</i>                                                                                                               | February  | 52   | <b>Boats and Boating</b>                                                                                                                                    |           |      |
| Chemical May Save Water*                                                                                                                                             | October   | 278  | Books, Libraries and Reading                                                                                                                                |           |      |
| Chicago Chess Pavilion*                                                                                                                                              | October   | 288  | Book Fair for Book Week*                                                                                                                                    | September | 246  |
| "Dennis the Menace" Playground, <i>Charles P. Warren, Hank Ketchum and This Week Magazine</i>                                                                        | April     | 136  | Children's Book Fair*                                                                                                                                       | November  | 317  |
| Drag Strips vs No Drag Strips                                                                                                                                        | June      | 210  | Children's Book Week, 1957*                                                                                                                                 | March     | 72   |
| Effective Acquisition Plans*                                                                                                                                         | June      | 231  | Do Our Children Read?*                                                                                                                                      | November  | 317  |
| Fairway in the Desert*                                                                                                                                               | April     | 133  | "Explore with Books"                                                                                                                                        | November  | 324  |
| Foresight to the Future*                                                                                                                                             | June      | 214  | Feature Stories on Recreation*                                                                                                                              | December  | 348  |
| How Golden Gate Park Was Saved                                                                                                                                       | June      | 208  | Stories at Christmas Time, <i>Mary Swang</i>                                                                                                                | November  | 326  |
| Importance of Land, The                                                                                                                                              | June      | 226  | Story Telling on the Playground, <i>Gladys Conklin</i>                                                                                                      | April     | 146  |
| Junior Museums*                                                                                                                                                      | November  | 323  | "Tree is Nice, A"*                                                                                                                                          | June      | 214  |
| Land Grab for Building Purposes, <i>The, George D. Butler</i>                                                                                                        | June      | 205  | <b>Book Reviews</b>                                                                                                                                         |           |      |
| Let's Save Our Recreation Lands, <i>Walter H. Blucher</i>                                                                                                            | June      | 197  | (See: New Publications; Personnel; Research)                                                                                                                |           |      |
| Location of Facilities for Senior Citizens Clubs, <i>Ronald D. Johnson</i>                                                                                           | September | 266  | <b>Camping</b>                                                                                                                                              |           |      |
| Loss of Local Park Lands to Highway Planning, <i>The, D. Donaldson</i>                                                                                               | June      | 201  | Campfire, <i>The, S. Theodore Wool</i>                                                                                                                      | March     | 97   |
| Magic Square "120"*                                                                                                                                                  | April     | 152  | Camping for Tomorrow, <i>Reynold E. Carlson</i>                                                                                                             | March     | 83   |
| Milestones*                                                                                                                                                          | June      | 213  | Campsite Selection, Layout and Development, <i>Lewis C. Reisman</i>                                                                                         | March     | 85   |
| Multiple-Use Area*                                                                                                                                                   | April     | 152  | Contests for a Woodsmen's Weekend                                                                                                                           | March     | 99   |
| Nautical Elbow Room*                                                                                                                                                 | November  | 323  | Creativity in Camp Music                                                                                                                                    | March     | 94   |
| New Chemical Control for Pond Algae*                                                                                                                                 | January   | 6    | Flag Ceremony*                                                                                                                                              | March     | 96   |
| New Waterland*                                                                                                                                                       | April     | 132  | For Successful Nature Hikes, <i>William R. Overlease</i>                                                                                                    | June      | 222  |
| Parks and Recreation Structures*                                                                                                                                     | January   | 6    | Mentally Retarded at Camp, <i>The, Roland Larson</i>                                                                                                        | March     | 77   |
| Playgrounds for Creative Play, <i>Liselott Diem</i>                                                                                                                  | April     | 151  | Nature Study in a Playground Day Camp*                                                                                                                      | March     | 84   |
| Playground for Mentally Handicapped Children, <i>The, Harold W. Perry</i>                                                                                            | April     | 128  | Nature Tools, <i>Betsy Breese</i>                                                                                                                           | March     | 92   |
| Potential Threat to Park and Recreation Lands*                                                                                                                       | June      | 231  | New Horizons for Camping, <i>T. R. Alexander</i>                                                                                                            | March     | 70   |
| Recreation at the South Pole, <i>Muriel McGann</i>                                                                                                                   | March     | 81   | Operation Outdoors*                                                                                                                                         | February  | 54   |
| Recreation Development, <i>A, William J. Duchaine</i>                                                                                                                | March     | 91   |                                                                                                                                                             | October   | 304  |
| Recreation Space in Subdivisions                                                                                                                                     | February  | 55   | Personal Touch in Day Camping, <i>The, Patrick J. Carolan</i>                                                                                               | March     | 74   |
| Season in the Snow                                                                                                                                                   | December  | 356  | Professional Role of the Camp Director, <i>The, Hedley S. Dimock</i>                                                                                        | March     | 88   |
| Selected Planning Trends*                                                                                                                                            | October   | 304  | Westward Ho! <i>Harvey G. Segal</i>                                                                                                                         | March     | 82   |
| Services in School Plant*                                                                                                                                            | December  | 376  | What are Today's Campers Missing? <i>Eugene L. Swan, Jr.</i>                                                                                                | March     | 73   |
| Study of Biotic Communities*                                                                                                                                         | September | 270  | Wilderness Adventuring*                                                                                                                                     | March     | 79   |
| They Built a Park                                                                                                                                                    | January   | 10   | (See also: Areas, Equipment, Facilities, Layout; Nature; Parks and Conservation; Personnel; Playgrounds; Program Planning; Schools; special group headings) |           |      |
| <b>Swimming Pools:</b>                                                                                                                                               |           |      |                                                                                                                                                             |           |      |
| Business Procedures in Pool Operation, <i>C. P. L. Nicholls</i>                                                                                                      | May       | 180  | <b>Clubs</b>                                                                                                                                                |           |      |
| Court Decisions Affecting Swimming Pools                                                                                                                             | June      | 233  | Able-Disabled, <i>The, Patricia Morris</i>                                                                                                                  | May       | 186  |
|                                                                                                                                                                      |           |      | Activities in the Golden Years, <i>Norma Heinrich, Marjorie Welch, and The Detroit News</i>                                                                 | February  | 43   |
|                                                                                                                                                                      |           |      | Adapting Dancing for Senior Citizens, <i>Cyrus S. Grossman</i>                                                                                              | October   | 289  |

|                                                                       | Month     | Page |
|-----------------------------------------------------------------------|-----------|------|
| Boys, Bikes—And Safety, <i>S. Preston Douglas</i>                     | May       | 188  |
| Dug-Out—A Youth Center That Serves, <i>The, Edgar W. Nell</i>         | January   | 6    |
| Junior Gardeners, <i>Ann Albert</i>                                   | May       | 169  |
| Know Your Adolescents, <i>Carol H. Weiss</i>                          | November  | 320  |
| Rhythm Groups in Rehabilitation, <i>Leo Shatin and Wallace Kotter</i> | September | 263  |
| Softball is Dead? Not in Saginaw! <i>Malcolm Elliott</i>              | June      | 220  |
| Sure-Fire Safety in Riflery                                           | September | 256  |
| Teaching Baseball to Beginners, <i>Mickey McConnell</i>               | May       | 173  |
| Young Citizens Improve Recreation Areas, <i>B. D. Mott</i>            | June      | 221  |

**Colleges and Universities**

|                                                                                     |           |     |
|-------------------------------------------------------------------------------------|-----------|-----|
| Graduate Assistants Stipends Increase*                                              | September | 246 |
| NRA-Columbia University Collaborate*                                                | March     | 109 |
| On the Campus                                                                       | January   | 27  |
|                                                                                     | December  | 381 |
| Recreation Education in the World of Higher Learning, <i>Charles K. Brighitbill</i> | December  | 374 |
| Recreation in the Age of Enjoyment, <i>Paul F. Douglass</i>                         | November  | 312 |
| Social Welfare Today*                                                               | February  | 45  |
| SOS! Danger Ahead! <i>W. C. Sutherland</i>                                          | September | 272 |
| Taking Piano Lessons from Films*                                                    | May       | 168 |
| Training*                                                                           | December  | 382 |

(See also: Personnel)

**Community Action and Program**

|                                                                         |           |     |
|-------------------------------------------------------------------------|-----------|-----|
| All America Cities Awards*                                              | March     | 79  |
| Citizens' Organizations*                                                | October   | 303 |
| Drag Strips vs No Drag Strips                                           | June      | 210 |
| Dug-Out—A Youth Center That Serves, <i>The, Edgar W. Nell</i>           | January   | 16  |
| Fairway in the Desert*                                                  | April     | 133 |
| Family Recreation—Foe of Juvenile Delinquency, <i>Charles A. Bucher</i> | February  | 46  |
| How Golden Gate Park Was Saved                                          | June      | 208 |
| Public Recreation in Long Beach, <i>Duane George</i>                    | September | 252 |
| Recreation on Parade                                                    | October   | 292 |
| Softball Is Dead? Not in Saginaw! <i>Malcolm Elliott</i>                | June      | 220 |
| Survey Leads to Action, <i>A, Pat Perkinson</i>                         | February  | 53  |
| They Built a Park                                                       | January   | 10  |
| What You Can Do About Encroachment*                                     | June      | 206 |

(See also: Administration; Areas, Equipment, Facilities; Layout; Holidays and Special Occasions; Parks and Conservation; Program Planning; Schools; Sports; Youth)

**Dancing**

|                                                                |           |     |
|----------------------------------------------------------------|-----------|-----|
| Adapting Dancing for Senior Citizens, <i>Cyrus S. Grossman</i> | October   | 289 |
| Dance in Psychotherapy*                                        | June      | 225 |
| Easy Ways to Change Partners, <i>Jane A. Harris</i>            | September | 261 |
| Folk Dancing—The Old and the New, <i>Sarah Gertrude Knott</i>  | October   | 284 |
| Maypole Dance, <i>The, Olga Kulbitsky</i>                      | April     | 140 |
| Pima Squares Off*                                              | March     | 80  |

(See also: Music; Program Planning; Servicemen and Servicewomen; Special Activities and Events; Youth)

**Drama, Dramatics and Theatre**

|                                                               |       |     |
|---------------------------------------------------------------|-------|-----|
| Campfire, <i>The, S. Theodore Wool</i>                        | March | 97  |
| Christopher Cheesemore (A Story), <i>Ruth H. Norris</i>       | April | 147 |
| Dump and a Dollar, <i>A, Michael Solomon</i>                  | April | 145 |
| Girl in the Blue Denim Skirt, <i>The, Connie Bloomquist</i>   | April | 139 |
| Lively Ideas for the Summer Play, <i>Pamela Prince Walker</i> | April | 148 |
| Storytelling on the Playground, <i>Gladys Conklin</i>         | April | 146 |
| Water Dramatics for Young Swimmers, <i>Betsy DuBois</i>       | March | 104 |

(See also: Holidays and Special Occasions; Playgrounds; Program; Special Activities and Events; Youth)

**Editorials**

(See: Philosophy and Theory)

**Education**

|                                                                                     |          |     |
|-------------------------------------------------------------------------------------|----------|-----|
| Recreation Education in the World of Higher Learning, <i>Charles K. Brighitbill</i> | December | 374 |
| Uprooting Prejudice*                                                                | December | 361 |

(See: Colleges and Universities; Personnel; Philosophy and Theory; Schools)

**Games and Contests**

|                                                            |          |     |
|------------------------------------------------------------|----------|-----|
| All Army "Operation Service Club" Contest*                 | October  | 288 |
| Boys, Bikes—And Safety, <i>S. Preston Douglas</i>          | May      | 188 |
| Bridge, Anyone?*                                           | November | 323 |
| Contests for a Woodsmen's Weekend                          | March    | 99  |
| Drag Strips vs No Drag Strips                              | June     | 210 |
| Global Baseball*                                           | June     | 214 |
| High School Photo Contest (1957)*                          | March    | 80  |
| Irish Fair, <i>An, Patrick J. Heneghan</i>                 | February | 49  |
| Junior Table Tennis Contestants*                           | November | 316 |
| May Party on Rubber Wheels, <i>A, Lucy Muir</i>            | May      | 183 |
| Musical Games and Their Creative Use, <i>Leah M. Jaffa</i> | January  | 19  |
| New High School Photo Contest (1958)*                      | November | 316 |
| Outboard Boating Club Contest*                             | November | 316 |
| Softball is Dead? Not in Saginaw! <i>Malcolm Elliott</i>   | June     | 220 |
| Sports Quiz Program                                        | November | 331 |
| Swimming Pool Awards*                                      | December | 360 |

(See also: Camping; Handicapped; Holidays and Special Occasions; Sports)

**Girls and Women**

(See: Program Planning; Sports; other activities headings)

**Handicapped**

|                                                                           |           |     |
|---------------------------------------------------------------------------|-----------|-----|
| Able-Disabled, <i>The, Patricia Morris</i>                                | May       | 186 |
| May Party on Rubber Wheels, <i>A, Lucy Muir</i>                           | May       | 183 |
| Mentally Retarded at Camp, <i>The, Roland Larson</i>                      | March     | 77  |
| New Vistas in Recreation for Patients, <i>Maurice E. Linden, M.D.</i>     | September | 259 |
| Playground for Mentally Handicapped Children, <i>The, Harold W. Perry</i> | April     | 128 |
| Recreation Club Leadership of, by and for the Handicapped*                | June      | 225 |
| Recreation for the Handicapped*                                           | December  | 361 |
| Recreation Services for the Handicapped*                                  | June      | 225 |
| Recreational Care for Mentally Ill and Retarded*                          | March     | 109 |

|                                                                       | Month     | Page |
|-----------------------------------------------------------------------|-----------|------|
| Rhythm Groups in Rehabilitation, <i>Leo Shatin and Wallace Kotter</i> | September | 262  |

(See also: Arts and Crafts; Camping; Clubs; Hospital Recreation; Mental Health; Program Planning)

**Hobbies**

(See: Arts and Crafts; Camping; Clubs; Program Planning; special activities headings)

**Holidays and Special Occasions**

|                                               |          |     |
|-----------------------------------------------|----------|-----|
| For Your February Parties                     | February | 51  |
| Irish Fair, <i>An, Patrick J. Heneghan</i>    | February | 49  |
| Your Program Calendar*                        | February | 56  |
| We Celebrate Halloween—But Do We Know Why?    | October  | 287 |
| <b>Christmas:</b>                             |          |     |
| Christmas—1957, <i>Robert E. Kresge</i>       | December | 346 |
| Christmas Classes and Crafts                  | November | 328 |
| Christmas Customs in Many Lands               | December | 359 |
| Christmas Tour for Golden-Agers*              | December | 367 |
| Last Minute Holiday Hints                     | December | 366 |
| Santa Goes to School                          | December | 373 |
| Stories at Christmas Time, <i>Mary Strang</i> | November | 326 |
| <b>Easter:</b>                                |          |     |
| Easter Greeting, <i>An*</i>                   | April    | 122 |
| Easter Idea Hunt*                             | March    | 107 |
| Easter Legend, <i>An*</i>                     | April    | 122 |
| Thoughts of Easter*                           | April    | 122 |

(See also: Special Activities and Events)

**Hospital Recreation**

|                                                                       |           |     |
|-----------------------------------------------------------------------|-----------|-----|
| Hospital Capsules, <i>Beatrice H. Hill</i>                            | January   | 29  |
|                                                                       | March     | 109 |
|                                                                       | June      | 225 |
|                                                                       | December  | 382 |
| In a Children's Hospital*                                             | March     | 80  |
| New Vistas in Recreation for Patients, <i>Maurice E. Linden, M.D.</i> | September | 259 |
| Recreation, Medicine and the Humanities, <i>Joseph B. Wolfe, M.D.</i> | December  | 364 |
| Rhythm Groups in Rehabilitation, <i>Leo Shatin and Wallace Kotter</i> | September | 262 |

(See also: Handicapped)

**Industrial Recreation**

|                                                                |         |     |
|----------------------------------------------------------------|---------|-----|
| Converting Increased Leisure Into an Asset*                    | April   | 122 |
| Four-Day Work Week, <i>The*</i>                                | June    | 200 |
| Recreation Development, <i>A, William J. Duchaine</i>          | March   | 90  |
| Recreation Facilities Influence Location of Industrial Plants* | April   | 114 |
| They Built a Park                                              | January | 10  |

(See also: Aging; Parks and Conservation; Philosophy and Theory)

**Institutional Recreation**

|                               |          |     |
|-------------------------------|----------|-----|
| Volunteers in Prison Program* | December | 348 |
| Young Folks in Homes*         | December | 361 |

(See: Handicapped; Hospital Recreation)

**International**

|                                                                                     |          |     |
|-------------------------------------------------------------------------------------|----------|-----|
| Board of Directors, International Recreation Association*                           | January  | 13  |
| Christmas Customs in Many Lands                                                     | December | 359 |
| Easter Idea Hunt*                                                                   | March    | 107 |
| Folk Dancing—The Old and the New, <i>Sarah Gertrude Knott</i>                       | October  | 284 |
| International Projects in Rehabilitation*                                           | December | 348 |
| Global Baseball*                                                                    | June     | 214 |
| Launching of the International Recreation Association, <i>The, Thomas E. Rivers</i> | January  | 12  |
| Mallery, <i>Otto Tod</i>                                                            | January  | 4   |
| Pan-American Week*                                                                  | February | 38  |
| People-to-People International Friendship Activities*                               | April    | 114 |
| Sadry, <i>Dr. Abolfazl—In Memoriam*</i>                                             | January  | 15  |
| UNICEF Hi Neighbor Program*                                                         | May      | 168 |
| UNICEF Program Ideas for Halloween*                                                 | October  | 278 |
| UNICEF Youth Recreation Kit*                                                        | February | 38  |
| World Neighboring*                                                                  | October  | 278 |

(See also: Holidays and Special Occasions; National Recreation Association; National Recreation Congress; People)

**Juvenile Delinquency**

|                                                                         |          |     |
|-------------------------------------------------------------------------|----------|-----|
| City Agency to Oust Families*                                           | April    | 114 |
| Fact Finding Survey*                                                    | January  | 6   |
| Family Recreation—Foe of Juvenile Delinquency, <i>Charles A. Bucher</i> | February | 46  |
| New York State to Prosecute Parents*                                    | April    | 114 |
| Philadelphia Agency Develops Program*                                   | January  | 6   |
| Town Meeting with Delinquents, <i>A, Robert L. Smith</i>                | April    | 131 |

(See also: Youth)

**Mental Health**

(See: Handicapped; Hospital Recreation)

**Music**

|                                                                       |           |     |
|-----------------------------------------------------------------------|-----------|-----|
| Creativity in Camp Music                                              | March     | 94  |
| Easy Ways to Change Partners, <i>Jane A. Harris</i>                   | September | 261 |
| Musical Games and Their Creative Use, <i>Leah M. Jaffa</i>            | January   | 18  |
| Music Week*                                                           | April     | 114 |
| Playground Songaree*                                                  | April     | 142 |
| Rhythm Groups in Rehabilitation, <i>Leo Shatin and Wallace Kotter</i> | April     | 262 |

(See also: Audio-Visual Materials and Program; Special Activities and Events)

**National Recreation Association**

|                                    |          |     |
|------------------------------------|----------|-----|
| Affiliated Societies of NRA*       | January  | 6   |
|                                    | February | 44  |
|                                    | March    | 72  |
|                                    | June     | 198 |
|                                    | December | 349 |
|                                    | December | 378 |
| Blanket Activities Insurance Plan* | June     | 198 |
| Cited for Anti-Litter Leadership*  | February | 44  |
| Hospital Recreation Study*         | January  | 29  |

|                                                           | Month    | Page |
|-----------------------------------------------------------|----------|------|
| Job Referrals*                                            | March    | 72   |
| NRA Citations*                                            | December | 360  |
| NRA—Columbia University Collaborate*                      | March    | 109  |
| NRA Expansion*                                            | December | 360  |
| NRA—U.S. Census Bureau to Provide Recreation Information* | June     | 198  |
| One Hundred Per Cent Affiliation*                         | March    | 72   |
| Personnel Notes*                                          | January  | 29   |
| Recreation and Park Yearbook, 1956                        | January  | 6    |
| Recreation Developments in 1956, Charles E. Reed          | June     | 212  |
| Recreation Service for the Handicapped*                   | June     | 225  |
| Regional Recreation Perspectives, Robert D. Carpenter     | November | 333  |
| Talk, Hoyer and Poke, To                                  | April    | 132  |
| <b>National Recreation Month:</b>                         |          |      |
| National Recreation Month*                                | January  | 6    |
|                                                           | June     | 198  |
|                                                           | March    | 72   |
|                                                           | May      | 168  |
|                                                           | October  | 292  |

Recreation on Parade  
(See also: Hospital Recreation; International; National  
Recreation Congress; People; Personnel; Public Relations;  
Research)

### National Recreation Congress

|                                                                           |           |     |
|---------------------------------------------------------------------------|-----------|-----|
| Congress Briefs                                                           | December  | 354 |
| Congress-by-the-Sea*                                                      | April     | 120 |
| Formal Agreement Reached*                                                 | January   | 6   |
| Going to Long Beach?                                                      | May       | 175 |
| Highlights of the National Recreation Congress                            | September | 250 |
| Long Beach Beckons*                                                       | March     | 71  |
| Planning for Thirty-Ninth National Recreation Congress*                   | February  | 44  |
| Recreation Congress Story—1957, The, Dorothy Donaldson                    | December  | 349 |
| Scenes from the Thirty-Ninth Recreation Congress                          | December  | 368 |
| Second National Institute for Recreation Executives,*<br>W. C. Sutherland | June      | 234 |
| What to Do and See in Long Beach                                          | June      | 216 |

### Nature

|                                                               |           |     |
|---------------------------------------------------------------|-----------|-----|
| Ever the Same*                                                | February  | 34  |
| For Successful Nature Hikes, William R. Overlease             | June      | 222 |
| Junior Museums*                                               | November  | 323 |
| Inexpensive Nature Materials for Crafts                       | March     | 103 |
| Nature Crafts Year Round, Alice Hownestine                    | September | 264 |
| Nature Study in a Playground Day Camp*                        | March     | 84  |
| Nature Tools, Bettye Breaser                                  | March     | 92  |
| (See also: Camping; Parks and Conservation; Play-<br>grounds) |           |     |

### New Products

(See: Regular Features—Market News)

### New Publications

|                                                                                       |           |     |
|---------------------------------------------------------------------------------------|-----------|-----|
| Act It Out, Bernice Wells Carlson                                                     | June      | 239 |
| American Mountain Songs, Ethel Park Richardson                                        | March     | 112 |
| Believe and Make-Believe, Lucy Sprague Mitchell and<br>Irma Simonton Black            | September | 276 |
| Bird Biographies of John James Audubon, The, Alice Ford                               | May       | 192 |
| Bird Watchers, The, Marjory Bartlett Sanger                                           | December  | 389 |
| Butterflies Come, The, Leo Politi                                                     | November  | 340 |
| Camp Nurse, The                                                                       | March     | 93  |
| Camp Reference and Buying Guide—1957                                                  | March     | 112 |
| Camping, Barbara Ellen Joy                                                            | June      | 239 |
| Candle Book, The, Carl Laklan                                                         | February  | 63  |
| Christmas Songs and Their Stories, Edited by Herbert H.<br>Wernecke                   | December  | 389 |
| Clinical Application of Recreation Therapy, Dr. John Davis                            | June      | 225 |
| Community Bicycle Safety Program, A                                                   | March     | 80  |
| Contribution to the Heritage of Every American, Nancy Newhall                         | October   | 307 |
| Craziest Halloween, The, Ursula von Hippel                                            | November  | 340 |
| Creative Crafts for Campers, Catherine T. Hammett and<br>Carol M. Horrocks            | April     | 160 |
| Dance in Psychotherapy, Elizabeth Rosen                                               | June      | 225 |
| Dear Garbage Man, Gene Zion                                                           | December  | 389 |
| Dramatics and Ceremonies for Girl Scouts                                              | January   | 32  |
| Education and Art, Edwin Ziegfeld                                                     | June      | 239 |
| Equipment and Supplies (General Bulletin #39), Association<br>for Childhood Education | December  | 361 |
| Essentials of Social Group Work Skill, Helen U. Phillips                              | February  | 63  |
| Family Camping and Places to Camp in the North Central States,<br>George T. Wilson    | June      | 240 |
| Flower Show Themes and Classes, Dorothy Biddle                                        | March     | 112 |
| Folk Dancing, Grace L. Fox and Kathleen Gruppe Merrill                                | October   | 308 |
| Forms and Patterns in Nature, Wolf Sirache                                            | November  | 340 |
| Free Diving, Dimitri Rebikoff                                                         | January   | 32  |
| Fun-Time Puppets, Carrie Rasmussen and Caroline Storck                                | January   | 32  |
| Games to Build                                                                        | November  | 340 |
| Golfers Own Book, The, Dave Stanley and George G. Ross                                | March     | 111 |
| Home Aquarium Handbook, Griffith and Lillian Borgeson                                 | May       | 192 |
| Home Play for the Preschool Child, Jane Johnson                                       | May       | 192 |
| Horizons for Older People, George Gleason                                             | January   | 31  |
| How the Grinch Stole Christmas!, Dr. Seus                                             | December  | 389 |
| How to Forecast the Weather, Louis D. Rubin                                           | March     | 93  |
| How to Make Good Tape Recordings, C. J. LeBel                                         | March     | 111 |
| How to Make a Miniature Zoo, Vinson Brown                                             | November  | 340 |
| How to Make Shapes in Space, Toni Hughes                                              | April     | 160 |
| How to Plan and Conduct Workshops and Conferences,<br>Richard Beckhard                | February  | 64  |
| How to Survive on Land and Sea                                                        | June      | 240 |
| If you Live with Little Children, Carolyn Kauffman and<br>Patricia Parrell            | October   | 308 |
| Illustrated Games, Rhythms and Stunts for Children,<br>Frank H. Geri                  | May       | 192 |
| Inspirational Poetry for Camp and Youth Groups, H. Jean Berger                        | June      | 240 |
| Lady of the Lighted Schoolhouses, The, Lela B. Stephens                               | January   | 32  |
| Laughter is a Wonderful Thing, Joe E. Brown                                           | December  | 388 |
| Methods and Materials in Recreation Leadership,<br>Maryhelen Vannier                  | January   | 31  |
| Modern Dance Building and Teaching Lessons, Aileen Lockhart                           | October   | 308 |
| New Complete Hoyle, The, Albert H. Morehead                                           | February  | 64  |
| New Psychology for Leadership, The, Donald A. and<br>Eleanor C. Laird                 | February  | 63  |
| New Understandings of Leadership, Murray G. Ross and Charles<br>E. Hendry             | December  | 388 |
| Oil Painting, James Bateman                                                           | November  | 340 |

|                                                                                | Month     | Page |
|--------------------------------------------------------------------------------|-----------|------|
| Omnibus of Fun, Helen and Larry Essenberg                                      | January   | 31   |
| 101 Money Making Ideas for Clubs, Nellie Zetta Thompson                        | December  | 388  |
| Outdoor Encyclopedia, The, Ted Kesting                                         | December  | 389  |
| Outdoor Horizons, Lawrence M. Brings                                           | March     | 112  |
| Paper Figures Based on Children's Artwork, Anna Pauls and<br>Margaret S. Mizzi | December  | 389  |
| Paper Sculpture and Construction, J. V. Miller                                 | December  | 389  |
| Parade and Float Guide, L. F. Vaughn                                           | May       | 192  |
| Personnel Standards in Community Recreation Leadership                         | January   | 27   |
| Pilot Study of Swimming for the Severely Mentally Retarded, A                  | February  | 63   |
| Planning for Recreation and Parks in California—A Guide                        | January   | 25   |
| Plans for a Medium-Sized Ramp                                                  | March     | 93   |
| Play Activities for Boys and Girls, Richard Kraus                              | September | 276  |
| Praying Mantis, Harriet E. Huntington                                          | December  | 389  |
| Proof of the Pudding: What Children Read, The, Phyllis Fenner                  | March     | 111  |
| Public Recreation and Parks in California                                      | December  | 348  |
| Public Relations for Social Agencies, Harold P. Levy                           | June      | 240  |
| Quantity Cookery, Nola Treat and Lenore Richards                               | January   | 32   |
| Recreation and the Local Church, Frances Clemens                               | March     | 111  |
| Recreation and Park Yearbook, 1956                                             | January   | 6    |
| Recreation in the Age of Automation (The Annals,<br>September, 1957)           | October   | 307  |
| Recreation Leadership, W. C. Sutherland                                        | January   | 27   |
| Rules of Games According to Hoyle, Richard L. Frey                             | February  | 64   |
| Schools for the New Needs                                                      | September | 276  |
| Science of Skin and Scuba Diving                                               | December  | 388  |
| Sculpture in Paper, Bruce Angrave                                              | December  | 389  |
| Seed on the Wind, Bill Geagan                                                  | May       | 192  |
| Seven Steps to Creative Children's Dramatics, Pamela Prince<br>Walker          | December  | 388  |
| Seventeen Book of Young Living, The, Enid A. Haupt                             | December  | 388  |
| Ship of Peace, The, Elsie Denean Hunt                                          | March     | 111  |
| Singing Games and Dances, David S. McIntosh                                    | April     | 160  |
| So You're Gonna Ride a Bus, Jerry Witovsky and Mort Schrag                     | March     | 111  |
| Social Growth Through Play Production, Jack Simos                              | September | 276  |
| Sunset Ideas for Family Camping                                                | June      | 240  |
| Terry's Ferry, Marion Belden Cook                                              | November  | 340  |
| True-to-Life Stories for Campers, R. W. Eschmeyer                              | February  | 64   |
| Volleyball Official Guide                                                      | January   | 32   |
| Water Skiing for All, Walter N. Prince                                         | March     | 111  |
| Wee Tree's Christmas, The, James W. Hatch                                      | November  | 340  |
| Young Folks in Homes                                                           | December  | 361  |

### Organizations

|                                                                                 |          |     |
|---------------------------------------------------------------------------------|----------|-----|
| Launching of the International Recreation Association, The,<br>Thomas E. Rivers | January  | 12  |
| <b>News Items:</b>                                                              |          |     |
| Amateur Softball Association*                                                   | April    | 133 |
| American Friends Service Committee*                                             | December | 348 |
| American Institute of Park Executives*                                          | May      | 168 |
| American Medical Association*                                                   | March    | 72  |
| American Playing Card Manufacturers*                                            | November | 323 |
| American Public Health Association*                                             | December | 348 |
| American Recreation Society*                                                    | May      | 168 |
|                                                                                 | November | 322 |
|                                                                                 | December | 349 |
|                                                                                 | December | 360 |
| American Youth Hostels*                                                         | June     | 215 |
|                                                                                 | November | 322 |
| Association for Childhood Education*                                            | December | 361 |
| Association of Casualty and Surety Companies*                                   | March    | 80  |
| B'nai B'rith*                                                                   | April    | 133 |
| Eastman Kodak*                                                                  | March    | 80  |
|                                                                                 | November | 316 |
|                                                                                 | March    | 79  |
| Explorers' Caravan*                                                             | April    | 133 |
| Ford Foundation*                                                                | January  | 6   |
| Health and Welfare Council of Philadelphia*                                     | January  | 6   |
| Keep America Beautiful*                                                         | February | 44  |
|                                                                                 | June     | 198 |
|                                                                                 | November | 316 |
| Look Magazine*                                                                  | March    | 79  |
| Michigan Recreation Association*                                                | January  | 27  |
| Museum of Natural History*                                                      | March    | 79  |
| National Association of Home Builders*                                          | June     | 198 |
| National Association of Recreation Therapists*                                  | March    | 79  |
| National Conference of Christians and Jews*                                     | February | 34  |
| National Conference on Social Welfare*                                          | March    | 72  |
| National Education Association*                                                 | May      | 168 |
| National Industrial Recreation Association*                                     | November | 316 |
| National Municipal League*                                                      | March    | 79  |
| National Safety Council*                                                        | March    | 72  |
| National Swimming Pool Institute*                                               | March    | 80  |
| National Wildlife Foundation*                                                   | March    | 72  |
| Outboard Boating Club of America*                                               | November | 316 |
|                                                                                 | December | 348 |
|                                                                                 | November | 322 |
| Parents' Magazine*                                                              | April    | 114 |
| People-To-People*                                                               | April    | 114 |
| Senior Citizens of America*                                                     | December | 360 |
| Swimming Pool Age Magazine*                                                     | February | 38  |
| UNICEF*                                                                         | May      | 168 |
|                                                                                 | October  | 278 |
|                                                                                 | April    | 114 |
| United Auto Workers of America*                                                 | November | 316 |
| United States Table Tennis Association*                                         | November | 322 |
| United States Volleyball Association*                                           | December | 361 |
| Workshop for Cultural Democracy*                                                | December | 361 |
| (See also: National Recreation Association; National<br>Recreation Congress)    |          |     |

### Parks and Conservation

|                                             |           |     |
|---------------------------------------------|-----------|-----|
| All American Cities Awards*                 | March     | 79  |
| Among the Missing*                          | June      | 215 |
| Are Your Parks Threatened, Too?*            | February  | 34  |
| Citizens' Organizations*                    | October   | 303 |
| Court Decisions Affecting Recreation Lands* | June      | 230 |
|                                             | November  | 336 |
|                                             | December  | 376 |
| Developing Parks*                           | June      | 231 |
| Effective Acquisition Plans*                | February  | 38  |
| Federal Legislation and Surplus Property*   | November  | 322 |
| First County Park Restudied*                | September | 255 |
| Hats-Off Department*                        |           |     |

|                                                                                         | Month     | Page |
|-----------------------------------------------------------------------------------------|-----------|------|
| How Golden Gate Park Was Saved                                                          | June      | 208  |
| Importance of Land, The                                                                 | June      | 226  |
| Land Grab for Building Purposes, The, <i>George D. Butler</i>                           | June      | 204  |
| Latest Agency Information                                                               | January   | 26   |
| Legal Notes and Court Decisions                                                         | November  | 335  |
| Let's Save Our Recreation Lands, <i>Walter H. Blucher</i>                               | June      | 197  |
| Loss of Local Park Lands to Highway Planning, The, <i>D. Donaldson</i>                  | June      | 201  |
| New Dimensions in Recreation, <i>Joseph Prendergast</i>                                 | June      | 199  |
| Officials Exceed Authority*                                                             | April     | 152  |
| On the Plus Side*                                                                       | June      | 214  |
| Operation Outdoors*                                                                     | February  | 54   |
|                                                                                         | October   | 304  |
| Park Acreage to Population                                                              | June      | 228  |
| Park Practice*                                                                          | September | 246  |
| Parsons Memorial Gardens*                                                               | June      | 213  |
| Per Capita Expenditures for Recreation and Parks in 1955, <i>Muriel E. McGann</i>       | February  | 57   |
| Planning for Recreation Parks in California—A Guide (Book Review), <i>George Butler</i> | January   | 25   |
| Potential Threat to Park and Recreation Lands*                                          | June      | 231  |
| Recreation Development, A, <i>William J. Duchaine</i>                                   | March     | 90   |
| Recreation Space in Subdivisions                                                        | February  | 55   |
| Regional Recreation Perspectives, <i>Robert D. Carpenter</i>                            | November  | 333  |
| Survey Leads to Action, A, <i>Pat Perkinson</i>                                         | February  | 53   |
| Talk, Hover and Poke, To*                                                               | April     | 132  |
| Teen-Agers at Work*                                                                     | April     | 152  |
| Tennessee Qualified to Purchase Government Surplus Property* They Built a Park          | October   | 278  |
|                                                                                         | January   | 10   |
| U.S. Opens Twenty-Ninth National Park*                                                  | February  | 38   |
| Washington State's Twenty-Five Year Plan*                                               | June      | 198  |
| Ways and Means*                                                                         | November  | 323  |
| Westchester County's State Park*                                                        | February  | 58   |
| What You Can Do About Encroachment*                                                     | June      | 206  |
| Young Citizens Improve Recreation Areas, <i>B. D. Mott</i>                              | June      | 221  |

### Parties

|                                                                                                                                                                            |          |     |
|----------------------------------------------------------------------------------------------------------------------------------------------------------------------------|----------|-----|
| Christmas Classes and Crafts                                                                                                                                               | November | 328 |
| Display and Decoration Ideas, <i>Mary Frances Sargent</i>                                                                                                                  | October  | 294 |
| For Your February Parties                                                                                                                                                  | February | 51  |
| May Party—On Rubber Wheels, A, <i>Lucy Musz</i>                                                                                                                            | May      | 183 |
| We Celebrate Halloween—But Do We Know Why? (See also: Holidays and Special Occasions; Program Planning; Servicemen and Servicewomen; Special Activities and Events; Youth) | October  | 287 |

### People

|                                    |           |     |
|------------------------------------|-----------|-----|
| <b>Awards, Honors, Retirement:</b> |           |     |
| Achievement Awards*                | November  | 322 |
| Allen, F. Ellwood*                 | December  | 360 |
| Boyce, Dorothy*                    | November  | 322 |
| Brown, Joe E.*                     | December  | 360 |
| Bunker, Alta Sims*                 | December  | 360 |
| Cannon, Madolin*                   | December  | 360 |
| Cranford, Charles*                 | December  | 360 |
| Curtis, Joseph E.*                 | June      | 213 |
| Dittmar, James C.*                 | April     | 132 |
| Douglass, Dr. Paul F.*             | December  | 360 |
| Eisenhower, Dwight D.*             | June      | 215 |
| Evans, Lou*                        | September | 255 |
| Fowler, Walter L.*                 | September | 255 |
| Garman, Horace B.*                 | February  | 45  |
| Goethe, C. M.*                     | December  | 360 |
| Gustafson, Col. Arthur W.*         | December  | 360 |
| Hale, Marion*                      | April     | 132 |
| Hartson, Charles*                  | September | 255 |
| MacDonald, Keith A.*               | February  | 45  |
| Randall, Josephine D.*             | April     | 132 |
| Rensvold, Mrs. Verna*              | October   | 288 |
| Reynolds, Jesse A.*                | December  | 360 |
| Sabino, Frank*                     | November  | 322 |
| Scott, Walter L.*                  | June      | 213 |
| Sliker, Col. Roland E.*            | October   | 288 |
| Wilsey, L. C.*                     | April     | 132 |
| Winans, Sterling*                  | December  | 360 |

### NRA Board and Staff:

|                                   |          |     |
|-----------------------------------|----------|-----|
| Bob Gamble Goes to IRA*           | February | 44  |
| Cited for Anti-Litter Leadership* | February | 44  |
| Frame, Mrs. Howard A.*            | June     | 213 |
| Langhammer, Dave M.*              | December | 360 |
| Madison, James E.*                | April    | 132 |
|                                   | October  | 288 |
| Menninger, Dr. William C.*        | November | 322 |
| NRA Board Elections*              | June     | 213 |
| NRA News Notes*                   | February | 44  |
| NRA Welcomes and Bids Farewell*   | March    | 79  |
| Tapply, Richards*                 | December | 360 |
| Todd, Arthur*                     | October  | 288 |
| Walker, Grace*                    | October  | 288 |

### In Memoriam:

|                            |         |     |
|----------------------------|---------|-----|
| Hoyt, Raymond E.*          | May     | 168 |
| Mallery, Otto Tod          | January | 4   |
| Sadry, Dr. Abolfazl*       | January | 15  |
| Shippis, Guy L.*           | June    | 215 |
| Weller, Charles Frederick* | June    | 215 |

### Recent Appointments:

|                     |          |     |
|---------------------|----------|-----|
| Holiber, Joel C.*   | November | 322 |
| Jeffrey, Howard*    | May      | 168 |
| Madar, Olga M.*     | April    | 132 |
| McCarthy, Dennis*   | November | 322 |
| Moser, Lawrence P.* | April    | 132 |
| Romney, G. Ott*     | April    | 114 |
| Welborn, Dr. Gene*  | January  | 27  |

### Personnel

|                                                  |          |     |
|--------------------------------------------------|----------|-----|
| Adolescence Will be Like This, <i>Helen Rapp</i> | February | 41  |
| Campfire, The, <i>S. Theodore Wool</i>           | March    | 97  |
| Evaluation in Recreation—Playgrounds*            | April    | 149 |

|                                                        |          |     |
|--------------------------------------------------------|----------|-----|
| Jobs for Volunteers*                                   | November | 317 |
| Notes on a Summer Experiment, <i>Betty Yurina Keat</i> | April    | 143 |

### Leadership and Training:

|                                                                 |           |     |
|-----------------------------------------------------------------|-----------|-----|
| Current Comments, <i>W. C. Sutherland</i>                       | December  | 379 |
| "Grass Roots" Recreation, <i>Charles H. Odegaard</i>            | December  | 362 |
| Great Lakes Park Institute*                                     | January   | 27  |
| High School Class*                                              | October   | 303 |
| Join Forces for Better Training, <i>William H. Radke</i>        | April     | 156 |
| New Personnel Publications*                                     | January   | 27  |
| NRA-Columbia Collaborate*                                       | March     | 109 |
| Outsider Looks at Recreation, Aa, <i>Harold W. Williams</i>     | November  | 318 |
| Personnel Notes*                                                | January   | 29  |
| Professional Role of the Camp Director, <i>Hedley S. Dimock</i> | March     | 88  |
| Public Recreation in Long Beach, <i>Duane George</i>            | September | 252 |
| Recreation Developments in 1956, <i>Charles E. Reed</i>         | June      | 212 |
| Recreation in the Age of Enjoyment, <i>Paul F. Douglass</i>     | November  | 312 |
| SOS Danger Ahead! <i>W. C. Sutherland</i>                       | September | 272 |
| Students Conduct Workshop*                                      | January   | 27  |
| Training*                                                       | December  | 382 |

### Recruitment and Placement:

|                                                                               |          |     |
|-------------------------------------------------------------------------------|----------|-----|
| Jobs for Volunteers*                                                          | November | 317 |
| Recreation Personnel Review—1956, <i>W. C. Sutherland</i>                     | February | 59  |
| Recruiting, <i>Marilyn Jensen</i>                                             | March    | 106 |
| Second National Institute for Recreation Executives,* <i>W. C. Sutherland</i> | June     | 234 |

(See also: Administration; Camping; Clubs; Handicapped; Hospital Recreation; Program Planning; Youth)

### Philosophy and Theory

|                                                                                     |           |     |
|-------------------------------------------------------------------------------------|-----------|-----|
| Automation*                                                                         | February  | 34  |
|                                                                                     | November  | 317 |
| Basic Leadership Requirements for Today's World*                                    | February  | 45  |
| Beautiful World, A*                                                                 | June      | 200 |
| Brainstorming in Recreation, <i>Mary Frances Sargent</i>                            | June      | 218 |
| Brotherhood Week*                                                                   | February  | 34  |
| Challenge to the Nation*                                                            | April     | 122 |
| Christmas—1957, <i>Robert E. Krasge</i>                                             | December  | 346 |
| Danger of Uniformity, The,*                                                         | June      | 200 |
| Ever the Same*                                                                      | February  | 34  |
| Family Recreation—Foe of Juvenile Delinquency, <i>Charles A. Bucher</i>             | February  | 46  |
| Fiftieth Candle, The, <i>Joseph Prendergast</i>                                     | April     | 117 |
| Folk Dancing—The Old and the New, <i>Sarah Gertrude Knott</i>                       | October   | 284 |
| Influence of Rural Environment on Children, The, <i>Anne S. Hoppock</i>             | April     | 129 |
| Launching of the International Recreation Association, The, <i>Thomas E. Rivers</i> | January   | 12  |
| Let's Save Our Recreation Lands, <i>Walter H. Blucher</i>                           | June      | 197 |
| Mallery, Otto Tod                                                                   | January   | 4   |
| My Philosophy of Recreation, <i>Charles P. Weckwerth</i>                            | May       | 164 |
| New Dimensions in Recreation, <i>Joseph Prendergast</i>                             | June      | 199 |
| New Horizons for Camping, <i>T. R. Alexander</i>                                    | March     | 70  |
| No Longer Separate Entities*                                                        | June      | 200 |
| Outsider Looks at Recreation, An, <i>Harold W. Williams</i>                         | November  | 318 |
| Personal Touch in Day Camping, The, <i>Patrick J. Carolan</i>                       | March     | 74  |
| Physical Fitness*                                                                   | November  | 316 |
| Recreation Education in the World of Higher Education, <i>Charles K. Brigbill</i>   | December  | 374 |
| Recreating for Fitness, <i>Shane MacCarthy</i>                                      | September | 244 |
| Recreation in the Age of Enjoyment, <i>Paul F. Douglass</i>                         | November  | 312 |
| Recreation, Medicine and the Humanities, <i>Joseph B. Wolfe, M.D.</i>               | December  | 364 |
| Recreation Policy of the United States Air Force, <i>Col. Roland E. Sliker</i>      | October   | 282 |
| Season of Renewal*                                                                  | April     | 122 |
| Some Yardsticks—for Relating Participation to Costs, <i>H. C. Hutchins</i>          | January   | 23  |
| Weeping Willow, The,* <i>Jane Gielman</i>                                           | April     | 130 |
| What are Today's Campers Missing? <i>Eugene L. Swan, Jr.</i>                        | March     | 73  |
| What is the Point of Sport? <i>Arnold Kaech</i>                                     | December  | 358 |
| "Why" of Recreation, The, <i>Sherwood Gates</i>                                     | February  | 40  |
| World Neighboring*                                                                  | October   | 278 |

(See also: Administration; Automation and Increased Leisure; Community Action and Program; College and Universities; National Recreation Association; Personnel; Program Planning; Research)

### Photography

|                                       |          |     |
|---------------------------------------|----------|-----|
| High School Photo Contest (1957)*     | March    | 80  |
| New High School Photo Contest (1958)* | November | 316 |

(See also: Hobbies; Playgrounds; Special Activities and Events)

### Playgrounds

|                                                                                                |           |     |
|------------------------------------------------------------------------------------------------|-----------|-----|
| "Dennis the Menace" Playground, <i>Charles F. Warren, Hank Ketchum, and This Week Magazine</i> | April     | 136 |
| Dump and A Dollar, A, <i>Michael Solomon</i>                                                   | April     | 145 |
| Evaluation in Recreation—Playgrounds*                                                          | April     | 149 |
| "Explore with Books"                                                                           | November  | 324 |
| Girl in the Blue Denim Skirt, The, <i>Connie Bloomquist</i>                                    | April     | 139 |
| Lively Ideas for the Summer Play, <i>Pamela Prince Walker</i>                                  | April     | 148 |
| Magic Square "120"*                                                                            | April     | 152 |
| Multiple-Use Area*                                                                             | April     | 152 |
| Musical Games and Their Creative Use, <i>Leah M. Jaffe</i>                                     | January   | 18  |
| Nature Crafts Year 'Round, <i>Alice Houmstine</i>                                              | September | 264 |
| Nature Study in a Playground Day Camp*                                                         | March     | 84  |
| Nature Tools, <i>Bettya Breeser</i>                                                            | March     | 92  |
| Notes on a Summer Experiment, <i>Betty Yurina Keat</i>                                         | April     | 143 |
| Playground Facts and Fun                                                                       | April     | 124 |
| Playgrounds for Mentally Handicapped Children, The, <i>Harold W. Perry</i>                     | April     | 128 |
| Playgrounds for Creative Play,* <i>Lislot Diem</i>                                             | April     | 151 |
| Playgrounds on Parade, <i>John Meahan</i>                                                      | April     | 134 |
| Public Recreation in Long Beach, <i>Duane George</i>                                           | September | 252 |
| Recent Experimentation*                                                                        | April     | 154 |
| Story Telling on the Playground, <i>Gladys Conklin</i>                                         | April     | 146 |
| Try a New Idea                                                                                 | April     | 142 |
| Westward Ho!* <i>Harvey G. Segal</i>                                                           | March     | 82  |

(See also: Administration; Areas, Equipment, Facilities, Layout; Arts and Crafts; Clubs; Personnel; Program Planning; Special Activities and Events; Youth)

**Prayers and Verse**

Easter Greeting, An (Poem), *Robert Kresge* ..... April 122  
 For the New Year (Prayer), *St. Francis of Assisi* ..... January 6  
 Now We Are Fifty (Poem), *Muriel McGann* ..... April 116  
 Thanksgiving Prayer ..... November 317  
 Woodfire and Candle-Light (Poetry), *Mary Edgar* ..... March 98

**Pre-School**

(See: Areas, Equipment, Facilities, Layout; Playgrounds; Program Planning; Schools; Youth)

**Program Planning**

**Activities:**  
 (See under all activities headings and special group headings; also under: Camping; Holidays and Special Occasions; Special Activities and Events)

**Cooperation:**  
 (See under Administration; Audio-Visual Materials and Planning; Community Action and Programs; Industrial Recreation; Personnel; Philosophy and Theory; Volunteers)

**Idea of the Month:**

Able-Disabled, The, *Patricia Morris* ..... May 186  
 Brainstorming in Recreation, *Mary Frances Sargent* ..... June 218  
 Brighten That Dark Corner, *Mary Frances Sargent* ..... February 52  
 Campfire, The, *S. Theodore Wool* ..... March 97  
 Programs on Exhibition, *Catherine Simpson* ..... January 21

**Planning:**

Creativity in Camp Music ..... March 94  
 Evaluation in Recreation—Playgrounds\* ..... April 149  
 For Successful Nature Hikes, *William R. Overlease* ..... June 222  
 "Grass Roots" Recreation, *Charles H. Odgaard* ..... December 362  
 Lively Ideas for the Summer Play, *Pamela Prince Walker* ..... April 148  
 Musical Games and Their Creative Use, *Leah M. Jaffa* ..... January 18  
 Nature Tools, *Betty Brester* ..... March 92  
 Notes on a Summer Experiment, *Betty Yurina Keat* ..... April 143  
 Playground Facts and Fun ..... April 124  
 Playgrounds on Parade, *John Meehan* ..... April 134  
 What Are Today's Campers Missing? *Eugene L. Swan, Jr.* ..... March 73  
 Your Program Calendar\* ..... February 56

**Public Relations**

How Golden Gate Park Was Saved ..... June 208  
 Newspapers and Recreation, *W. H. Wallace* ..... January 14  
 Personal Touch in Day Camping, The, *Patrick J. Carolan* ..... March 74  
 Public Recreation in Long Beach, *Duane George* ..... September 252  
 Public Relations in Recreation, *Richard M. Baker* ..... October 300  
 Swimming Pool Awards\* ..... December 360  
 What You Can Do About Encroachment ..... June 216  
 (See also: Administration; Program Planning)

**Radio**

(See: Audio-Visual Materials and Program)

**Regular Features**

Books and Pamphlets Received, Periodicals, Magazine Articles  
 (Listings) ..... Each Issue  
 Editorially Speaking ..... February 34  
 ..... April 122  
 ..... June 200  
 ..... November 317  
 Hospital Capsules, *Beatrice H. Hill* ..... See Hospital Recreation  
 How To Do It! *Frank A. Staples* ..... See Arts and Crafts  
 Idea of the Month ..... See Program Planning  
 Index of Advertisers ..... Each Issue  
 Letters ..... Each Issue  
 Market News ..... January 28  
 ..... February 60  
 ..... March 108  
 ..... May 190  
 ..... June 236  
 ..... December 384  
 New Publications ..... Each Issue  
 On the Campus ..... See Colleges and Universities  
 Personnel ..... February 59  
 ..... March 106  
 ..... April 115  
 ..... June 234  
 ..... September 272  
 ..... December 379  
 Reporter's Notebook ..... February 44  
 ..... March 79  
 ..... April 132  
 ..... June 213  
 ..... September 255  
 ..... October 288  
 ..... November 322  
 ..... December 360  
 Research Reviews and Abstracts, *George D. Butler* ..... See Research  
 Things You Should Know ..... Each Issue

**Research**

Community Self-Evaluation\* ..... November 316  
 Concession vs Direct Operations, *Ralph M. Hileman* ..... April 150  
 Changing County, The\* ..... November 335  
 Court Decisions\* ..... November 335  
 Developing Parks\* ..... December 376  
 Court Decisions Affecting Swimming Pools ..... June 232  
 Drag Strips vs No Drag Strips ..... June 210  
 Evaluation\* ..... October 303  
 First County Park Restudied\* ..... November 322  
 Government Body Studies Recreation Boating\* ..... March 72  
 Great Smokies Travel Study\* ..... November 316  
 Half-Mile Radius ..... April 152  
 Here and There with Swimming Pools, *George D. Butler* ..... May 176  
 IBM in Recreation\* ..... March 80  
 Know Your Adolescents, *Carol H. Weiss* ..... November 320  
 Land Grab for Building Purposes, The, *George D. Butler* ..... June 204

Latest Agency Information ..... January 26  
 Legal Notes and Court Decisions ..... November 336  
 Location of Facilities for Senior Citizens Clubs, *Ronald D. Johnson* ..... September 266  
 Loss of Local Park Lands to Highway Planning, The, *D. Donaldson* ..... June 201  
 Outlying Recreation Lands\* ..... June 213  
 Park Acreage to Population ..... June 228  
 Per Capita Expenditures for Recreation and Parks in 1955, *Muriel E. McGann* ..... February 57  
 Recreation and Park Yearbook, 1956 ..... January 6  
 Recreation at the South Pole, *Muriel McGann* ..... March 81  
 Recreation Developments in 1956, *Charles E. Reed* ..... June 212  
 Recreation in Hospitals Study\* ..... January 29  
 Recreation Space in Subdivisions ..... February 55  
 Report Writing\* ..... November 335  
 Research Notes, *Muriel E. McGann* ..... December 378  
 Research Reviews and Abstracts, *George D. Butler* ..... September 270  
 ..... October 304  
 ..... September 272  
 Survey Leads to Action, A, *Pat Perkinson* ..... February 53  
 Swimming Poll\* ..... December 348  
 United States Population\* ..... December 348  
 (See also: Administration; Areas, Equipment, Facilities, Layout; Colleges and Universities; Parks and Conservation; Personnel)

**Rural Recreation**

Dug-Out—A Youth Center That Serves, The, *Edgar W. Nell* ..... January 16  
 "Grass Roots" Recreation, *Charles H. Odgaard* ..... December 362  
 Influence of Rural Environment on Children, The, *Anne S. Hopcock* ..... April 129  
 Weeping Willow, The,\* *Jane Gitelman* ..... April 130  
 (See also: Administration; Community Activities and Program; Parks and Conservation; Program Planning)

**Safety and Health**

Bicycle Safety Plan\* ..... March 80  
 Boys, Bikes—And Safety, *S. Preston Douglas* ..... May 188  
 Christopher Cheesmore (A Story), *Ruth H. Norris* ..... April 147  
 Court Decisions\* ..... November 335  
 Court Decisions Affecting Swimming Pools ..... June 232  
 Drag Strip Check, The\* ..... March 72  
 Drag Strip vs No Drag Strips ..... June 210  
 Guideposts for Safe Water Skiing, *Harold M. Gore* ..... March 99  
 Here and There with Swimming Pools, *George Butler* ..... May 176  
 Information on Drownings\* ..... September 270  
 Join the Safety Campaign\* ..... February 45  
 Research Notes (Frequency of Accidents), *Muriel E. McGann* ..... December 378  
 Safety Afloat Campaign\* ..... June 213  
 Safety Program Recommendations,\* *James E. Bonaboom* ..... April 149  
 Season in the Snow ..... December 356  
 Sure-Fire Safety in Rifery ..... September 256  
 Thumbs Down Means Don't Clown\* ..... June 198  
 (See also: Areas, Equipment, Facilities, Layout; Handicapped; Hospitals; Sports; Youth)

**Schools**

Able-Disabled, The, *Patricia Morris* ..... May 186  
 Annual Career Day\* ..... April 157  
 High School Class\* ..... October 303  
 Personnel Recruiting, *Marilyn Jensen* ..... March 106  
 Planning for Recreation Parks in California—A Guide (Book Review), *George Butler* ..... January 25  
 Public Recreation in Long Beach, *Duane George* ..... September 252  
 Recreation Services and the Department of Education ..... December 376  
 Salute to Youth\* ..... April 133  
 School Building Expenditures\* ..... March 80  
 Services in School Plant\* ..... December 376  
 (See also: Administration; Areas, Equipment, Facilities, Layout; Colleges and Universities; Community Action and Program; Philosophy and Theory; Sports)

**Servicemen and Servicewoman**

All-Army "Operation Service Club" Contest\* ..... October 288  
 April Is USO Month\* ..... March 72  
 Current Comments, *W. C. Sutherland* ..... December 379  
 Display and Decoration Ideas, *Mary Frances Sargent* ..... October 294  
 Fairway in the Desert\* ..... April 133  
 In Making a Better Citizen\* ..... February 45  
 Recreation at the South Pole, *Muriel McGann* ..... March 81  
 Recreation Policy of the United States Air Force, *Col. Roland E. Sliker* ..... October 282  
 (See also: Dancing; Program Planning; Special Activities and Events; Youth)

**Special Activities and Events**

Brotherhood Week\* ..... February 34  
 Contest for a Woodsmen's Week-End ..... March 99  
 National Folk Festival\* ..... June 214  
 National Recreation Month\* ..... January 6  
 ..... June 198  
 National Wildlife Week\* ..... March 72  
 Nature Study in a Playground Day Camp\* ..... March 84  
 Pan-American Week\* ..... February 38  
 Playground Songaree\* ..... April 142  
 Recreation on Parade ..... October 292  
 Westward Ho!\* *Harvey G. Segal* ..... March 82  
 Youth Appreciation Week\* ..... September 246  
 (See also: Clubs; Holidays and Special Occasions; Handicapped; Parties; Program Planning; Servicemen and Servicewomen; Youth)

**Sports**

About Face\* ..... June 214  
 Bicycle Safety Plan\* ..... March 80  
 Boys, Bikes—and Safety, *S. Preston Douglas* ..... May 188  
 Contests for a Woodsmen's Week-End ..... March 99  
 Drag Strip Check, The\* ..... March 72  
 Drag Strips vs No Drag Strips ..... June 210

|                                                                                                                           | Month     | Page |
|---------------------------------------------------------------------------------------------------------------------------|-----------|------|
| Liability*                                                                                                                | April     | 152  |
| Physical Fitness*                                                                                                         | November  | 316  |
| Skating. Anyone?*                                                                                                         | February  | 45   |
| Sports Quiz Program                                                                                                       | November  | 331  |
| Sure-Fire Safety in Rifflery                                                                                              | September | 256  |
| What is the Point of Sport? <i>Arnold Kaech</i>                                                                           | December  | 358  |
| <b>Ball:</b>                                                                                                              |           |      |
| Global Baseball*                                                                                                          | June      | 214  |
| Research Notes (Midget Football Survey), <i>Muriel E. McGann</i>                                                          | December  | 378  |
| Softball is Dead? Not in Saginaw! * <i>Malcolm Elliott</i>                                                                | June      | 220  |
| Softball Recommendations*                                                                                                 | April     | 133  |
| Teaching Baseball to Beginners, <i>Mickey McConnell</i>                                                                   | May       | 173  |
| <b>Water:</b>                                                                                                             |           |      |
| Government Body Studies Recreation Boating*                                                                               | March     | 72   |
| Guideposts for Safe Water Skiing, <i>Harold M. Gors</i>                                                                   | March     | 100  |
| Proposed Legislation on Boating*                                                                                          | December  | 348  |
| Safety Afloat Campaign*                                                                                                   | June      | 213  |
| Swimming Poll*                                                                                                            | December  | 348  |
| Water Dramatics for Young Swimmers, <i>Betsy DuBots</i>                                                                   |           |      |
| <b>Winter:</b>                                                                                                            |           |      |
| Season in the Snow                                                                                                        | December  | 356  |
| Techniques of Ski Teaching—for Beginners' Groups                                                                          | December  | 370  |
| (See also: Administration; Areas, Equipment, Facilities, Layout; Safety and Health; Special Activities and Events; Youth) | March     | 104  |
| <b>Volunteers</b>                                                                                                         |           |      |
| Jobs for Volunteers*                                                                                                      | November  | 317  |

|                                                                                                                                                                        | Month     | Page |
|------------------------------------------------------------------------------------------------------------------------------------------------------------------------|-----------|------|
| Social Welfare Today*                                                                                                                                                  | February  | 45   |
| Volunteers in Prison Program*                                                                                                                                          | December  | 348  |
| (See also: Clubs; Personnel; Youth)                                                                                                                                    |           |      |
| <b>Youth</b>                                                                                                                                                           |           |      |
| Achievement Awards*                                                                                                                                                    | November  | 322  |
| Adolescence Will Be Like This, <i>Helen Rapp</i>                                                                                                                       | February  | 41   |
| Boys, Bikes—And Safety, <i>S. Preston Douglas</i>                                                                                                                      | May       | 188  |
| Dug-Out—A Youth Center That Serves, <i>The, Edgar W. Nell</i>                                                                                                          | January   | 16   |
| Family Recreation—Foe of Juvenile Delinquency, <i>Charles A. Bucher</i>                                                                                                | February  | 46   |
| High School Photo Contest (1957)*                                                                                                                                      | March     | 80   |
| Junior Gardeners, <i>Ann Albert</i>                                                                                                                                    | May       | 169  |
| Know Your Adolescents, <i>Carol H. Weiss</i>                                                                                                                           | November  | 320  |
| New High School Photo Contest (1958)*                                                                                                                                  | November  | 316  |
| Salute to Youth*                                                                                                                                                       | April     | 133  |
| Sure-Fire Safety in Rifflery                                                                                                                                           | September | 256  |
| Teen-Agers Adopt Conduct Guide                                                                                                                                         | May       | 170  |
| Teen-Agers at Work*                                                                                                                                                    | April     | 152  |
| Town Meeting with Delinquents, <i>Robert L. Smith</i>                                                                                                                  | April     | 131  |
| Wilderness Adventuring*                                                                                                                                                | March     | 79   |
| Young Citizens Improve Recreation Areas, <i>B. D. Moss</i>                                                                                                             | June      | 221  |
| Youth Fitness Benefits*                                                                                                                                                | June      | 215  |
| (See also: Camping; Colleges and Universities; Juvenile Delinquency; Personnel; Playgrounds; Program Planning; Safety and Health; Servicemen and Servicewomen; Sports) |           |      |

## INDEX OF ADVERTISERS AND EXHIBITORS FOR 1957

\* RECREATION Magazine Advertiser

† National Recreation Congress Exhibitor

\*† Advertiser and Exhibitor

Page numbers for 1957 issues: JANUARY 1-32; FEBRUARY 33-64; MARCH 65-112; APRIL 113-160; MAY 161-192; JUNE 193-240; SEPTEMBER 241-276; OCTOBER 277-308; NOVEMBER 309-340; DECEMBER 341-396.

### ATHLETIC FIELD, PARK, PLAYGROUND, POOL, RINK AND GYMNASIUM EQUIPMENT

| Advertiser and Product                                                                                                                                                                       | Page |
|----------------------------------------------------------------------------------------------------------------------------------------------------------------------------------------------|------|
| AMERICAN PLAYGROUND DEVICE COMPANY, Anderson, Indiana *†<br><i>Playground, Pool, Dressing Room and Picnic Equipment</i><br>1, 37, 69, April Inside Front Cover, 165, 193, 235, 299, 315, 345 |      |
| BELTZ ENGINEERING LABORATORIES, 11021 Whittier Avenue, Detroit 24, Michigan *<br><i>Ice Skating Rinks</i> ..... 191, 193, 265, 302, 337, 345                                                 |      |
| THE J. E. BURKE COMPANY, Van Dyne Road, Fond du Lac, Wisconsin *<br><i>Playground, Park, Picnic Equipment</i> ..... 33, 127, 207, 273, 305                                                   |      |
| PETER CARVER ASSOCIATES, 70 East 45th Street, New York 17, N. Y. *†<br><i>Ice Skating Rinks</i> ..... Inside Front Cover April, 260, 299                                                     |      |
| CLIFFCO, INC., 457 Lakeview Way, Redwood City, California†<br><i>Pay Stoves</i>                                                                                                              |      |
| CHAMPION RECREATION EQUIPMENT, INC., P. O. Box 474, Highland Park, Illinois *<br><i>Swing Seat</i> ..... 9                                                                                   |      |
| COMMERCIAL LIGHTING EQUIPMENT COMPANY, 10015 South Broadway, Los Angeles 3, California †<br><i>Floodlights</i>                                                                               |      |
| HANCOCK IRON WORKS, 56 West Pike Street, Pontiac, Michigan *<br><i>Park and Picnic Stoves</i> ..... 189                                                                                      |      |
| JAMISON MANUFACTURING COMPANY, 8800 South Mettler Street, Los Angeles 3, California *†<br><i>Playground and Athletic Field Equipment</i> .... 9, 39, 109, 144, 167, 215, 251, 307, 337, 383  |      |
| L. A. STEELCRAFT PRODUCTS, INC., 1951 Lincoln Avenue, Pasadena, California †<br><i>Maintenance Equipment</i>                                                                                 |      |
| MCDONOUGH STEEL COMPANY, 800—75th Avenue, Oakland 11, California †<br><i>All-Steel Swimming Pools</i>                                                                                        |      |
| MIRACLE EQUIPMENT COMPANY, Grinnell, Iowa †<br><i>Playground Equipment</i>                                                                                                                   |      |
| PACKER, LITCHFIELD, Michigan †<br><i>Physical Fitness and Play Equipment</i>                                                                                                                 |      |
| PLAY SCULPTURES, INC., 5 University Place, New York 3, New York †<br><i>Sculptured Playground Equipment</i>                                                                                  |      |
| PLAYGROUND ASSOCIATES, INC., 286 West 11th Street, New York 11, New York †<br><i>Modern Playground Equipment</i>                                                                             |      |

|                                                                                                                                            |  |
|--------------------------------------------------------------------------------------------------------------------------------------------|--|
| THE J. E. PORTER CORPORATION, Ottawa, Illinois *<br><i>Playground, Swimming Pool and Gymnasium Equipment</i><br>January Inside Front Cover |  |
| J. B. SERRELL CORPORATION, 300 South Los Angeles Street, Los Angeles 13, California †<br><i>Pool Maintenance Equipment and Supplies</i>    |  |
| UNION METAL MANUFACTURING COMPANY, Canton 5, Ohio *<br><i>Floodlighting and Area Lighting Poles</i> ..... 249                              |  |
| WELLS INDUSTRIES CORPORATION, 6880 Troost Avenue, N. Hollywood, California †<br><i>Pool and Playground Equipment and Accessories</i>       |  |
| WISE ENGINEERING COMPANY, 165 Delancy Street, Newark 5, New Jersey<br><i>Playground Equipment</i> ..... 185, 281                           |  |
| FRANK J. ZAMBONI AND COMPANY, Paramount, California †<br><i>Ice Machine for Skating Rinks</i>                                              |  |

### ATHLETIC, SPORTS, AND GAMES EQUIPMENT

| Advertiser and Product                                                                                                                                                             | Page |
|------------------------------------------------------------------------------------------------------------------------------------------------------------------------------------|------|
| ALL-AMERICAN TABLE TENNIS COMPANY, 20 East Jackson Boulevard, Box 501, Chicago 4, Illinois *<br><i>Table Tennis Equipment</i> ..... 337                                            |      |
| ALL-METAL TENNIS TABLE COMPANY, 760 George Street, Teaneck, New Jersey *<br><i>Aluminum Tennis Tables</i> ..... 7, 107, 127, 193, 297, 347                                         |      |
| AMERICAN SHUFFLEBOARD COMPANY, 210 Paterson Plank Road, Union City, New Jersey †<br><i>Shuffleboard Equipment and Supplies</i>                                                     |      |
| BOLCO ATHLETIC COMPANY, 1725 North Eastern Avenue, Los Angeles 22, California †<br><i>Bases, Base Anchors, Table Games</i>                                                         |      |
| NORMAN BUCK MANUFACTURING COMPANY, 2332 Eastlake, Seattle 2, Washington †<br><i>Aluminum Diving Board</i>                                                                          |      |
| CASTELLO FENCING EQUIPMENT, 30 East 10th Street, New York 3, New York *<br><i>Fencing Equipment</i> ..... 37, 245, 297, 313                                                        |      |
| CHICAGO ROLLER SKATE COMPANY, 4406-58 West Lake Street, Chicago 24, Illinois *†<br><i>Roller Skates</i> ..... 5, 33, September Back Cover, October Back Cover, November Back Cover |      |
| COSOM INDUSTRIES, INC., 6012 Wayzata Boulevard, Minneapolis 16, Minnesota †<br><i>Games and Balls</i>                                                                              |      |

|                                                                                      |                                                                                                                                          |
|--------------------------------------------------------------------------------------|------------------------------------------------------------------------------------------------------------------------------------------|
| D. M. R. LOOP TENNIS COMPANY, INC., P. O. Box 481, Tallahassee, Florida *            |                                                                                                                                          |
| Loop Tennis Equipment .....                                                          | 91, 155                                                                                                                                  |
| DAISY MANUFACTURING COMPANY, Plymouth, Michigan †                                    |                                                                                                                                          |
| Air Rifles and Club Organization .....                                               |                                                                                                                                          |
| DAYTON RACQUET COMPANY, 747 Albright Street, Arcanum, Ohio *                         |                                                                                                                                          |
| Steel Racquets .....                                                                 | 123                                                                                                                                      |
| DIMCO-GRAY COMPANY, 205 East Sixth Street, Dayton 2, Ohio * †                        |                                                                                                                                          |
| Shuffleboard Equipment .....                                                         | February Inside Front Cover, 91, 127, 165                                                                                                |
| DONALD F. DUNCAN, INC., 835 North Wood Street, Chicago 22, Illinois †                |                                                                                                                                          |
| Yo-Yo Return Tops .....                                                              |                                                                                                                                          |
| W. D. GRIFFIN COMPANY, 5927 Euclid Avenue, Cleveland 3, Ohio *                       |                                                                                                                                          |
| Wood Table Games .....                                                               | 265                                                                                                                                      |
| HAMMATT AND SONS, Route #5, 11356 Orangewood, Anaheim, California †                  |                                                                                                                                          |
| Table Games and Sporting Goods .....                                                 |                                                                                                                                          |
| HANNA MANUFACTURING COMPANY, Athens, Georgia †                                       |                                                                                                                                          |
| Baseball and Softball Bats .....                                                     |                                                                                                                                          |
| HARVARD TABLE TENNIS COMPANY, 60 State Street, Boston 9, Massachusetts *             |                                                                                                                                          |
| Table Tennis Equipment .....                                                         | 241, 283, 309                                                                                                                            |
| HILLERICH AND BRADSBY COMPANY, 434-36 Finzer Street, Louisville, Kentucky * †        |                                                                                                                                          |
| Baseball Bats, Golf Clubs .....                                                      | March Inside Front Cover, 155, May Inside Front Cover, June Inside Front Cover, September Inside Front Cover, October Inside Front Cover |
| HOPPY TAW CORPORATION, 927 South State Street, Salt Lake City, Utah * †              |                                                                                                                                          |
| Games and Playground Equipment .....                                                 | 159, 181, 207                                                                                                                            |
| JAYFRO ATHLETIC SUPPLY COMPANY, P. O. Box 1065, New London, Connecticut * †          |                                                                                                                                          |
| Basketball, Tetherball and Shuffleboard Equipment, Multi-Purpose Standard .....      | 1, 39, 69, 144, 171, 239, 273, 315, 382                                                                                                  |
| KALAH GAME COMPANY, Holliston, Massachusetts * †                                     |                                                                                                                                          |
| "Kalah" Table Games .....                                                            | 275                                                                                                                                      |
| THE MACGREGOR COMPANY, 4861 Spring Grove Avenue, Cincinnati 32, Ohio * †             |                                                                                                                                          |
| Sports Equipment .....                                                               | 39, 96, April Inside Front Cover, 185, 273, 330                                                                                          |
| NATIONAL SPORTS COMPANY, 370 North Marquette Street, Fond du Lac, Wisconsin *        |                                                                                                                                          |
| Bases .....                                                                          | 29, 39, 109, 166                                                                                                                         |
| NISSEN TRAMPOLINE COMPANY, Cedar Rapids, Iowa * †                                    |                                                                                                                                          |
| Trampolines .....                                                                    | 7, 123, 247, 286, 327, 347                                                                                                               |
| PENNSYLVANIA ATHLETIC PRODUCTS, Box 951, Akron, Ohio †                               |                                                                                                                                          |
| Balls and Swimming Equipment .....                                                   |                                                                                                                                          |
| RAWLINGS SPORTING GOODS, 2307 Lucas Street, St. Louis 3, Missouri * †                |                                                                                                                                          |
| Sports Equipment .....                                                               | 61, 103, 159, 181, 251, 299                                                                                                              |
| THE SEAMLESS RUBBER COMPANY, New Haven, Connecticut †                                |                                                                                                                                          |
| Rubber Athletic Products and Trainees' Supplies .....                                |                                                                                                                                          |
| SUN AIRED BAG COMPANY, 8669 Fenwick Street, Sunland, California †                    |                                                                                                                                          |
| Clothes-Checking Bags, Tennis Nets, Table Tennis Equipment .....                     |                                                                                                                                          |
| SUPERIOR INDUSTRIES CORPORATION, 565 Barry Street, New York 59, New York *           |                                                                                                                                          |
| Table Tennis and Pool Tables, Shuffleboard Equipment .....                           | 91, 144, 167, 207, 267, 305, 337, 345                                                                                                    |
| TABLE SOCCER, LTD., P. O. Box 684, Madison, Wisconsin †                              |                                                                                                                                          |
| Table Soccer Game .....                                                              |                                                                                                                                          |
| W. J. VOIT RUBBER CORPORATION, 2945 East 12th Street, Los Angeles 54, California * † |                                                                                                                                          |
| Rubber and Rubber Covered Athletic Balls and Equipment ....                          | 5, February Inside Front Cover, 91, 152, 179, 242, 305, 339, 347                                                                         |
| WEST COAST NETTING, 1020 Unruh Avenue, Puente, California †                          |                                                                                                                                          |
| Rubberized Sport Nets .....                                                          |                                                                                                                                          |
| WILSON SPORTING GOODS COMPANY, 2233 West Street, River Grove, Illinois †             |                                                                                                                                          |
| Athletic and Recreation Equipment and Clothing .....                                 |                                                                                                                                          |

### AUDIO-VISUAL EQUIPMENT AND SUPPLIES

Advertiser and Product Page

|                                                                      |               |
|----------------------------------------------------------------------|---------------|
| ASSOCIATION FILMS, INC., 347 Madison Avenue, New York 17, New York * |               |
| Movies .....                                                         | 167, 196, 267 |

|                                                                                   |                              |
|-----------------------------------------------------------------------------------|------------------------------|
| AUDIO EQUIPMENT COMPANY, Great Neck, New York *                                   |                              |
| Electronic Megaphone .....                                                        | March Back Cover             |
| FILMS, INC., 1150 Wilmette Avenue, Wilmette, Illinois *                           |                              |
| Movies .....                                                                      | 113                          |
| MAL'S RECORDING SERVICE, Box 37, Rockaway Park 94, New York *                     |                              |
| Recording Tapes .....                                                             | 302                          |
| NATIONAL STUDIOS, 42 West 48th Street, New York 36, New York *                    |                              |
| Song Slides .....                                                                 | 114, 165                     |
| NEWCOMB AUDIO PRODUCTS COMPANY, 6824 Lexington Avenue, Hollywood 38, California * |                              |
| Hi-Fi Equipment .....                                                             | 153, 166, 235, 242, 314, 344 |
| SQUARE DANCE ASSOCIATES, 33 South Grove Street, Freeport, New York * †            |                              |
| Recordings and Teaching Aids .....                                                | 89, 127, 171, 194, 280, 339  |

### CRAFT SUPPLIES

Advertiser and Product Page

|                                                                                     |                      |
|-------------------------------------------------------------------------------------|----------------------|
| CLEVELAND CRAFTS COMPANY, 4705 Euclid Avenue, Cleveland 3, Ohio *                   |                      |
| Handcraft Supplies .....                                                            | 89, 155, 167         |
| COPPER SHOP, 2185 East 14th Street, Cleveland 15, Ohio *                            |                      |
| Enamel on Copper Supplies .....                                                     | 9, 39, 109, 123, 191 |
| DENNISON MANUFACTURING COMPANY, 300 Howard Street, Framingham, Massachusetts * †    |                      |
| Crepe Paper, Craft and Decorating Accessories, Craft and Party Publications .....   | 1, 251               |
| DEXTRA CRAFTS AND TOYS, INC., 1246 Commonwealth Avenue, Boston, 34, Massachusetts * |                      |
| Craft Kits, Materials, Tools .....                                                  | 29                   |
| DUO-KILN MANUFACTURING COMPANY, 2185 East 14th Street, Cleveland 15, Ohio *         |                      |
| Craft Kilns .....                                                                   | 189, 193             |
| DREMEL MANUFACTURING COMPANY, Racine, Wisconsin *                                   |                      |
| Power Jig Saws .....                                                                | 207                  |
| J. C. LARSON COMPANY, 820 South Tripp Avenue, Chicago 24, Illinois *                |                      |
| Handcraft Supplies .....                                                            | 1, 91, 165, 194, 273 |
| MAGNUS CRAFT MATERIALS, 108 Franklin Street, New York 13, New York †                |                      |
| Handcraft Supplies .....                                                            |                      |
| HAZEL PEARSON HANDICRAFTS, Box 193, Temple City, California †                       |                      |
| Handicraft Supplies .....                                                           |                      |
| PLUME TRADING AND SALES COMPANY, INC., Box 585, Monroe, New York †                  |                      |
| American Indian Crafts and Supplies .....                                           |                      |
| PYROTEX COMPANY AND PURITAN PLASTIC COMPANY, INC., Leominster, Massachusetts †      |                      |
| Craft Lace .....                                                                    |                      |

|                                                                    |                                           |
|--------------------------------------------------------------------|-------------------------------------------|
| THE SHADOW BOX, 1378 East 8th Street, Brooklyn 30, New York *      |                                           |
| Yarn Craft .....                                                   | 239                                       |
| X-ACTO, INC., 48-99 Van Dam Street, Long Island City 1, New York * |                                           |
| Craft Knives, Tools, and Craft Kits .....                          | 39, 91, 123, 187, 207, 255, 305, 315, 347 |

### PERSONNEL

Advertiser and Product Page

|                                                                                            |                                      |
|--------------------------------------------------------------------------------------------|--------------------------------------|
| ARKANSAS STATE HOSPITAL, Little Rock, Arkansas *                                           |                                      |
| Job Opportunities .....                                                                    | 165                                  |
| ARMY SPECIAL SERVICES, Washington 25, D. C. *                                              |                                      |
| Job Opportunities .....                                                                    | 273                                  |
| CALIFORNIA STATE PERSONNEL BOARD, 801 Capitol Avenue, Sacramento, California *             |                                      |
| Job Opportunities .....                                                                    | 59, 69, 123, 215, 274, 302, 337, 382 |
| CAMP TAMARACK, 9999 Broadstreet, Detroit 4, Michigan *                                     |                                      |
| Job Opportunity .....                                                                      | 302                                  |
| EL CAJON CIVIL SERVICE COMMISSION, City Hall, El Cajon, California *                       |                                      |
| Job Opportunity .....                                                                      | 337                                  |
| LOS ANGELES CITY CIVIL SERVICE COMMISSION, Room 5, City Hall, Los Angeles 12, California * |                                      |
| Job Opportunity .....                                                                      | 61, 382                              |
| LUBROCK DEPARTMENT OF PARKS AND RECREATION, City Hall, Lubbock, Texas *                    |                                      |
| Job Opportunity .....                                                                      | 59                                   |

NEW YORK DIABETES ASSOCIATION, 104 East 40th Street, New York 16, New York \*  
*Job Opportunity* ..... 361

NEW YORK UNIVERSITY SCHOOL OF EDUCATION, Washington Square, New York 3, New York \*  
*Recreation and Camping Courses* ..... 127, 334

**PUBLICATIONS**

| <i>Advertiser and Product</i>                                                                                                                            | <i>Page</i>                                     |
|----------------------------------------------------------------------------------------------------------------------------------------------------------|-------------------------------------------------|
| AMERICAN ASSOCIATION FOR HEALTH, PHYSICAL EDUCATION AND RECREATION, 1201—16th Street, Washington 6, D. C. *<br><i>Books</i> .....                        | 267                                             |
| AMERICAN SQUARES, 1159 Broad Street, Newark 2, New Jersey *<br><i>Magazine</i> .....                                                                     | 307                                             |
| ASSOCIATION PRESS, 291 Broadway, New York 7, New York *<br><i>Books on Recreation and Related Areas</i><br>103, April Inside Front Cover                 |                                                 |
| THE ATHLETIC INSTITUTE, 209 South State Street, Chicago 4, Illinois *<br><i>Athletic, Recreation, and Physical Education Publications</i> ....           | 194                                             |
| CITADEL PRESS, 224 Fourth Avenue, New York 3, New York *<br><i>Books</i> .....                                                                           | 37                                              |
| CROWN PUBLISHERS, 419 Fourth Avenue, New York 16, New York *<br><i>Square Dance Guide</i> .....                                                          | 248                                             |
| EXPOSITION PRESS, 386 Fourth Avenue, New York 16, New York *<br><i>Publishers</i> .....                                                                  | 302, 337, 345                                   |
| GREENWICH BOOK PUBLISHERS, 489 Fifth Avenue, New York 17, New York *<br><i>Publishers</i> .....                                                          | 167, 193, 274, 315, 383                         |
| HANDWEAVER AND CRAFTSMAN, 246 Fifth Avenue, New York 1, New York *<br><i>Magazine</i> .....                                                              | 7, 154, 237                                     |
| MCGRAW-HILL BOOK COMPANY, INC., 330 West 42nd Street, New York 36, New York *<br><i>Books</i> .....                                                      | 61, 159, 237, 275                               |
| NATIONAL CATHOLIC CAMPING ASSOCIATION, 1312 Massachusetts Avenue, N.W., Washington 5, D.C. *<br><i>Directory</i> .....                                   | March Inside Front Cover                        |
| PACK-O-FUN, 741 Devon Avenue, Park Ridge, Illinois *<br><i>Scrapcraft Magazine</i> .....                                                                 | 36                                              |
| PARK MAINTENANCE, P. O. Box 409, Appleton, Wisconsin *<br><i>Magazine</i> .....                                                                          | February Inside Front Cover, 155, 191, 194, 307 |
| PARKS AND RECREATION, Oglebay Park, Wheeling, West Virginia *<br><i>Magazine</i> .....                                                                   | 275, 299, 330, 345                              |
| PORTER SARGENT PUBLISHER, 11 Beacon Street, Boston 8, Massachusetts *<br><i>Directories and Guides</i> .....                                             | 237                                             |
| THE RONALD PRESS COMPANY, 15 East 26th Street, New York 10, New York *<br><i>Books on Health, Physical Education, Recreation and Related Areas</i> ..... | 5, 107, 153, 185, 235, 271, 297, 339, 383       |
| SCHOOL ACTIVITIES PUBLISHING COMPANY, 1041 New Hampshire, Lawrence, Kansas *<br><i>Magazine</i> .....                                                    | February Back Cover                             |
| SIMON & SCHUSTER, Educational Division, Department Recreation, 136 West 52nd Street, New York 19, N. Y. *<br><i>Books</i> .....                          | 341                                             |
| SKATING REPORTER, 65 Shadyside Avenue, Dumont, New Jersey *<br><i>Magazine</i> .....                                                                     | 337                                             |
| SPEED-A-WAY, % Marjorie Larsen, 1754 Middlefield, Stockton 4, California *<br><i>Game Film and Guide Book</i> .....                                      | 305                                             |
| SQUARE YOUR SETS, 3302—15th Street A, Moline, Illinois *<br><i>Magazine and Books</i> .....                                                              | 37                                              |

**MISCELLANEOUS**

| <i>Advertiser and Product</i>                                                                                       | <i>Page</i> |
|---------------------------------------------------------------------------------------------------------------------|-------------|
| AMERICAN CAMPING ASSOCIATION, Bradford Woods, Martinsville, Indiana *<br><i>Camping Programs and Services</i> ..... | 9, 89       |

|                                                                                                                                                    |                                           |
|----------------------------------------------------------------------------------------------------------------------------------------------------|-------------------------------------------|
| AMERICAN JUNIOR BOWLING CONGRESS, 1913 West 103rd Street, Chicago 43, Illinois †<br><i>Bowling Ideas and Promotion</i>                             |                                           |
| THE COCA-COLA COMPANY, 515 Madison Avenue, New York 22, New York †<br><i>Beverages</i>                                                             |                                           |
| FIHE ENTERPRISES, 1023 Victory Place, Burbank, California †<br><i>Develop and Promote Inventions (Games)</i>                                       |                                           |
| FRED. GRETSCH MANUFACTURING COMPANY, 60 Broadway, Brooklyn 11, N. Y. *<br><i>Drums and Musical Instruments</i> .....                               | 7                                         |
| GRISWOLD DUPLICATING PRODUCTS, INC., 1598 American Avenue, Long Beach 13, California †<br><i>Duplicating Machines</i>                              |                                           |
| H. & R. MANUFACTURING COMPANY, Los Angeles 34, California *<br><i>Dry Line Markers</i> .....                                                       | 33, 110, 192, 271, 302, 313               |
| BART HAIGH, 123-35 82nd Road, Kew Gardens 15, New York *<br><i>Square Dance Caller</i> .....                                                       | 271                                       |
| HILLYARD CHEMICAL COMPANY, St. Joseph, Missouri *<br><i>Floor Treatments</i> .....                                                                 | 65, 121, 161, 269, 277                    |
| IDEAL SPECIALTIES, 250 W. 57th Street, New York 19, New York *<br><i>Novelties and Advertising Specialties</i> .....                               | 265                                       |
| INERTOL COMPANY, INC., 27 South Park, San Francisco 7, California †<br><i>Pool Enamels, Chemicals and Supplies</i>                                 |                                           |
| MITCHELL RUBBER PRODUCTS INC., 2114 San Fernando Road, Los Angeles 65, California †<br><i>Safety Surf and Safety Matting</i>                       |                                           |
| MONROE COMPANY, 181 Church Street, Colfax, Iowa *<br><i>Folding Tables</i> .....                                                                   | 29, 63, 109, 144, 187, 227, 265, 307, 341 |
| W. R. MOODY COMPANY, 702 North Mariposa Street, Burbank, California †<br><i>Trophies</i>                                                           |                                           |
| NATIONAL RIFLE ASSOCIATION, 1600 Rhode Island Avenue, Washington 6, D. C. * †<br><i>Rifle and Pistol Shooting Membership Association</i> .....     | 247                                       |
| NATIONAL TROPHY SALES, INC., 75 West Van Buren Street, Chicago, Illinois *<br><i>Trophies</i> .....                                                | 157, 185, 231                             |
| NOXAL PRODUCTS COMPANY, 1107-09 East Garvey Avenue, P. O. Box 147, Monterey Park, California †<br><i>Antiseptics, Disinfectants and Deodorants</i> |                                           |
| PEPSI-COLA COMPANY, 3 West 57th Street, New York 19, New York †<br><i>Beverages</i>                                                                |                                           |
| PERIPOLE PRODUCTS, INC., 2917 Avenue R, Brooklyn 29, New York †<br><i>Musical and Rhythm Instruments</i>                                           |                                           |
| PRIOR JEWELRY AND AWARD COMPANY, 220 Fifth Avenue, New York, New York *<br><i>Trophies</i> .....                                                   | 234                                       |
| PROGRAM AIDS COMPANY, 550 Fifth Avenue, New York 36, New York †<br><i>Posters, Charts, Awards, Coaching Aids</i>                                   |                                           |
| THE SEVEN-UP COMPANY, 1300 Delmar Boulevard, St. Louis 3, Missouri †<br><i>Beverages</i>                                                           |                                           |
| JAMES SPENCER AND COMPANY, 22 North 6th Street, Philadelphia 6, Pennsylvania *<br><i>Golden-Age Club Pins</i> .....                                | 29, 62, 109, 144, 179, 193, 337, 383      |
| HOWARD STEVEN COMPANY, 7015 Sunset Boulevard, Hollywood 28, California *<br><i>Ant Farms</i> .....                                                 | 382                                       |
| T. F. TWARDZIK AND COMPANY, INC., Shenandoah, Pennsylvania *<br><i>Table Tennis Ball Meter</i> .....                                               | 315, 341                                  |
| VOGEL-PETERSON COMPANY, 1121 West 37th Street, Chicago 9, Illinois *<br><i>Checkroom Equipment</i> .....                                           | 1, 89, 271, 297, 315                      |
| R. T. WATERS, 1383 East 26th Street, Brooklyn 10, New York *<br><i>Butterflies, Arrowheads, Tribal Pieces</i> .....                                | 33, 39                                    |



# Recreation Leadership Training Courses

Sponsored by the National Recreation Association

and

Local Recreation Agencies

**December, 1957; January, February, 1958**

|                                         |                                           |                                                                                 |
|-----------------------------------------|-------------------------------------------|---------------------------------------------------------------------------------|
| RUTH G. EHLERS<br>Social Recreation     | Lebanon, Pennsylvania<br>January 21       | Lisle C. Wochner, Chief, Special Service, Lebanon Veterans Hospital             |
|                                         | Lawrence, Massachusetts<br>February 11-14 | Miss Evelyn Stults, Executive Director, YWCA                                    |
|                                         | State of North Carolina<br>February 24-27 | Miss Virginia Gregory, North Carolina Recreation Commission, Raleigh            |
| ANNE LIVINGSTON<br>Social Recreation    | Cicero, Illinois<br>February 3-6          | William C. Kouns, Cicero Youth Commission                                       |
|                                         | State of North Carolina<br>February 10-13 | Miss Virginia Gregory, North Carolina Recreation Commission, Raleigh            |
| GRACE WALKER<br>Creative Recreation     | Poughkeepsie, New York<br>January 13-16   | Rupert J. Tarver, Jr., William W. Smith Community Center                        |
|                                         | Bozeman, Montana<br>January 20-24         | Miss Geraldine G. Fenn, Associate State 4-H Club Leader, Montana State College  |
| ELLIOTT M. COHEN<br>Hospital Recreation | Perry Point, Maryland<br>November 26-27   | William A. Putland, Chief, Recreation Service, Veterans Administration Hospital |
| FRANK A. STAPLES<br>Arts and Crafts     | Industry, New York<br>December 9-12       | John B. Costello, Superintendent, State Agricultural and Industrial School      |

Miss Dauncey will be conducting social recreation courses at the following Air Force Bases: January 13-16, Keesler Air Force Base, Biloxi, Mississippi, (for further details, communicate with the Air Force Regional Representative, Wayne Shields, USAF Office of Community Services, University of Georgia, Athens); January 20-23, Lackland Air Force Base, San Antonio, Texas; January 27-30, Sheppard Air Force Base, Wichita Falls, Texas; February 3-6, Amarillo Air Force Base, Amarillo, Texas, (for further details, communicate with the Air Force Regional Representative, Ray Morrison, 248 Casa Blanca, Fort Worth 7, Texas); February 10-13, Lowry Air Force Base, Denver, Colorado; February 24-27, Warren Air Force Base, Cheyenne, Wyoming, (for further details, communicate with the Air Force Regional Representative, Howard Beresford, 3055 Bellaire, Denver, Colorado).

Mr. Staples will be at the following Air Force Bases conducting two-week arts and crafts courses: January 6-16, Chanute Air Force Base, Rantoul, Illinois; January 20-30, Scott Air Force Base near St. Louis, Missouri (for further details, communicate with the Air Force Regional Representative, Howard Beresford, 3055 Bellaire, Denver, Colorado); February 3-13, Amarillo Air Force Base, Amarillo, Texas; February 17-28, Lackland Air Force Base, San Antonio, Texas, (for further details, communicate with the Air Force Regional Representative, Ray Morrison, 248 Casa Blanca, Fort Worth 7, Texas).

Attendance at training courses conducted by National Recreation Association leaders is usually open to all who wish to attend. For details as to location, contents of the course, registration procedure and the like, communicate with the sponsor of the course as listed above.

## The First Workshop on RECREATION for the HOMEBOUND ILL and HANDICAPPED

Co-sponsored by the National Recreation Association and New York University School of Education

**JANUARY 29 • 30 • 31, 1958**

Outstanding speakers and panelists will include: MRS. KATHERINE OETTINGER, Chief, Children's Bureau, U.S. Department of Health, Education and Welfare

DR. HOWARD A. RUSK, Associate Editor, *The New York Times*

TOPICS: Programs existing for the homebound ill and handicapped; government's role; techniques for developing recreation outlets and pursuits; motivating the patient; adapting activities for special handicaps; use of music, arts and crafts; help for the homebound from family and friends; recruiting, training, screening and placing volunteers; insurance coverages; service activities for homebound; trend toward day hospital treatment.

**Registration Fee: \$5.00 for three days, \$2.00 for one day**

For further information: Mrs. Beatrice H. Hill, Hospital Recreation Consultant  
National Recreation Association

8 West Eighth Street, New York 11



## *“Christmas! Bah! Humbug!”*

The man in the wheel chair leaned into the microphone. “Christmas!” he snarled. “Bah! Humbug!” And, as they had in Christmases past, millions of young listeners chilled at the mental picture of the baleful Scrooge.

It was a Christmas institution, back in the Forties, this annual reading of Charles Dickens’ classic. Its reader was something of an institution himself. In his turbulent lifetime he had been an unsuccessful painter but a good amateur second-baseman, a composer whose music was played by the New York Philharmonic, and a model for Frederick Remington.

To most people, though, he was Lionel Barrymore, the actor, and they loved him.

He was both crusty and kindly (he loved reading “A Christmas Carol”), adventurous, stubbornly independent in thought and outlook. And game as they come. Although an accident in 1936 imprisoned him in a wheel chair, he went resolutely on—working in motion pictures and making public appearances for nearly twenty years more.

No question but that Lionel Barrymore was one-of-a-kind. Yet the qualities so richly combined in him exist in a large measure among all the 170 million of us who call ourselves Americans.

They’re why we are what we are, why our country is one of the strongest on earth. And why there is no wiser investment than an investment in America—through U. S. Savings Bonds, which guarantee the safety of your savings, up to any amount, and the rate of your return. Start buying Bonds today, through Payroll Savings or where you bank. And hold onto them!

**Now Savings Bonds are better than ever!** Every Series E Bond purchased since February 1, 1957, pays 3- $\frac{1}{4}$ % interest when held to maturity. It earns higher interest in the early years than ever before, and matures in only 8 years and 11 months. Hold your *old* E Bonds, too. They earn more as they get older.



PART OF EVERY AMERICAN'S SAVINGS BELONGS IN U.S. SAVINGS BONDS

*The U. S. Government does not pay for this advertisement. It is donated by this publication in cooperation with the Advertising Council and the Magazine Publishers of America.*





# Recreation

## A GUIDE TO BOOKS ON RECREATION

An annotated list of over 850 selected titles

Library of the University of Illinois  
Urbana-Champaign  
Urbana, Illinois

### Recreation

SEPTEMBER 1957

Vol. L No. 7

in two parts

**PART II**

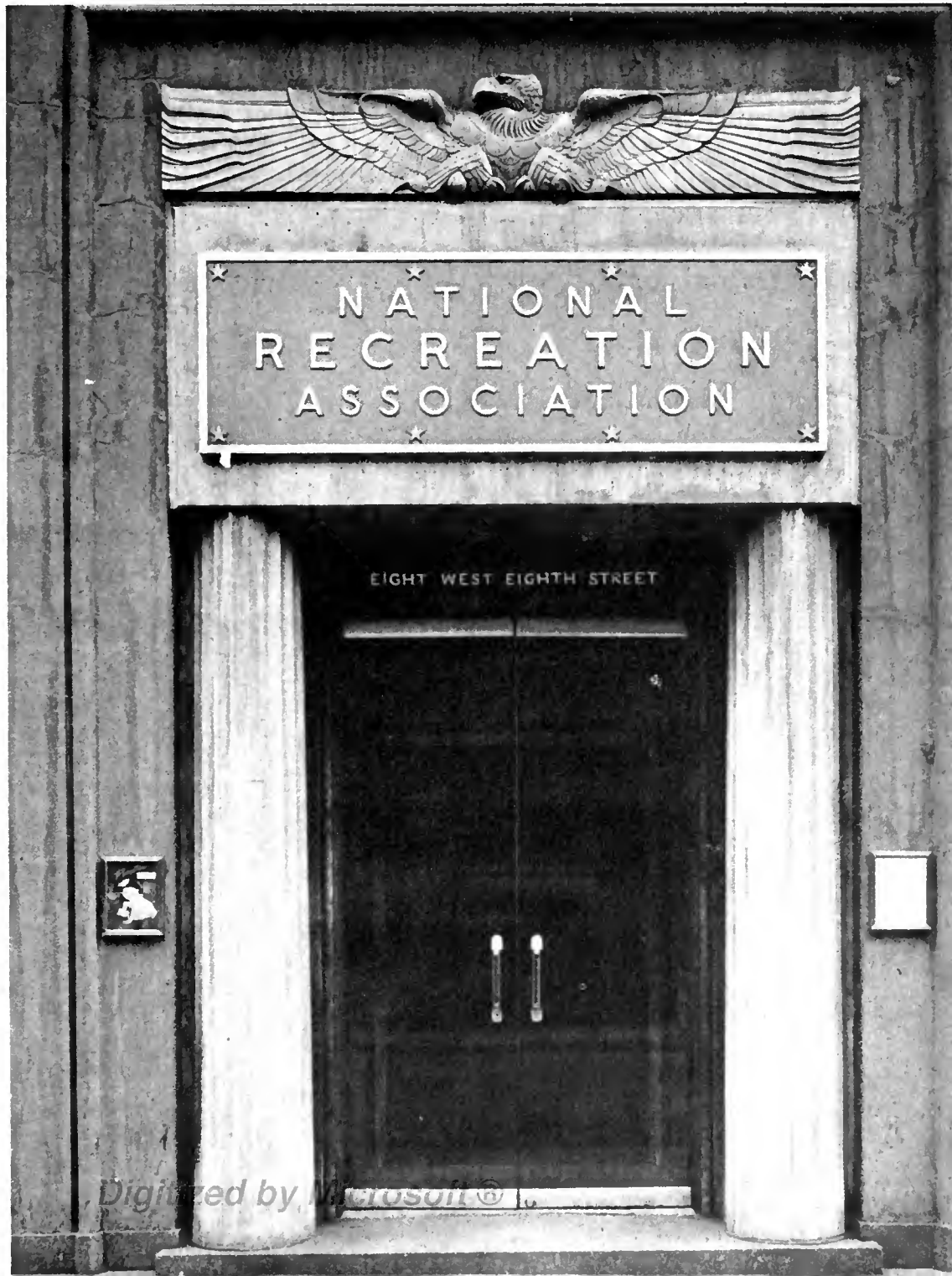

### Recreation

the magazine of the recreation movement, is published monthly by the National Recreation Association, except July and August. It is on file in public libraries and is indexed in the *Reader's Guide*.

# Contents

|                                                                                                                            |    |
|----------------------------------------------------------------------------------------------------------------------------|----|
| ACTIVITIES FOR SPECIAL GROUPS                                                                                              | 3  |
| Church Recreation                                                                                                          | 3  |
| <i>See also Drama, Parties &amp; Entertainment, Program Planning</i>                                                       |    |
| Family Fun                                                                                                                 | 3  |
| <i>See also Games &amp; Puzzles, Parties &amp; Entertainment</i>                                                           |    |
| Recreation for the Ill & Handicapped                                                                                       | 3  |
| Senior Citizens                                                                                                            | 4  |
| ARTS & CRAFTS                                                                                                              | 4  |
| CAMPING                                                                                                                    | 8  |
| <i>See also Arts &amp; Crafts, Drama, Nature, Parties &amp; Entertainment, Program Planning</i>                            |    |
| Organization & Administration                                                                                              | 8  |
| Leadership                                                                                                                 | 8  |
| Program                                                                                                                    | 8  |
| COMMUNITY RECREATION                                                                                                       | 9  |
| <i>See also Facilities, Layout, Equipment, Leadership, Organization &amp; Administration, Philosophy, Program Planning</i> |    |
| DANCING                                                                                                                    | 9  |
| DRAMA                                                                                                                      | 10 |
| <i>See also Dancing, Holidays, Parties &amp; Entertainment, Puppets</i>                                                    |    |
| Children's Theatre                                                                                                         | 10 |
| Collections                                                                                                                | 11 |
| Production & Techniques                                                                                                    | 12 |
| FACILITIES, LAYOUT, EQUIPMENT                                                                                              | 12 |
| <i>See also Arts &amp; Crafts, Camping, Community Recreation</i>                                                           |    |
| GAMES & PUZZLES                                                                                                            | 13 |
| <i>See also Music, Parties &amp; Entertainment</i>                                                                         |    |
| HOBBIES                                                                                                                    | 14 |
| <i>See also Arts &amp; Crafts, Nature, Photography</i>                                                                     |    |
| HOLIDAYS & SPECIAL DAYS                                                                                                    | 15 |
| <i>See also Arts &amp; Crafts, Drama, Travel</i>                                                                           |    |
| INDIAN LORE                                                                                                                | 15 |
| LEADERSHIP                                                                                                                 | 16 |
| <i>See also Camping, Community Recreation, Organization &amp; Administration</i>                                           |    |
| MUSIC                                                                                                                      | 17 |
| <i>See also Camping, Dancing, Drama, Games &amp; Puzzles</i>                                                               |    |
| NATURE                                                                                                                     | 19 |
| <i>See also Arts &amp; Crafts, Hobbies</i>                                                                                 |    |
| Astronomy                                                                                                                  | 20 |
| Gardening                                                                                                                  | 20 |
| ORGANIZATION & ADMINISTRATION                                                                                              | 20 |
| <i>See also Camping, Community Recreation, Leadership</i>                                                                  |    |
| PARTIES & ENTERTAINMENT                                                                                                    | 21 |
| <i>See also Dancing, Drama, Holidays, Program Planning</i>                                                                 |    |
| PETS                                                                                                                       | 22 |
| PHILOSOPHY OF RECREATION                                                                                                   | 23 |
| PHOTOGRAPHY                                                                                                                | 23 |
| PROGRAM PLANNING                                                                                                           | 23 |
| <i>See also Arts &amp; Crafts, Camping, Drama, Parties &amp; Entertainment</i>                                             |    |
| PUPPETS                                                                                                                    | 24 |
| SAFETY                                                                                                                     | 24 |
| SPORTS                                                                                                                     | 24 |
| General                                                                                                                    | 24 |
| Baseball                                                                                                                   | 25 |
| Boating                                                                                                                    | 26 |
| Fishing & Hunting                                                                                                          | 26 |
| Golf                                                                                                                       | 26 |
| Judo                                                                                                                       | 27 |
| Skiing                                                                                                                     | 27 |
| Swimming & Water Activities                                                                                                | 27 |
| Tennis                                                                                                                     | 27 |
| TRAVEL                                                                                                                     | 27 |

# Introduction

**W**E are proud to present the second edition of A GUIDE TO BOOKS ON RECREATION which has come to be known as AGBOR.

This catalog has been revised by the staff of the National Recreation Association. In addition to the majority of titles included in the 1956 AGBOR, 360 new titles have been added. One hundred twenty-five publishers have cooperated to make this listing possible.

A copy of each title is on display in the RECREATION BOOK CENTER at our national headquarters. We stock all books listed and fill orders promptly. An order blank is included for your convenience. We hope you will use this service to keep your recreation library up-to-date or to start a library if you do not now have one.

A cordial invitation is extended to you to visit us not only to examine the books in the RECREATION BOOK CENTER but to become better acquainted with the many services available through the National Recreation Association.

JOSEPH PRENDERGAST  
*Executive Director*

## NATIONAL ADVISORY COMMITTEE OF PUBLISHERS

*Chairman: Virgil Gentilin, Simon and Schuster, Inc.*  
*Secretary: Rose Jay Schwartz, National Recreation Association*  
*Harry D. Brown, McGraw-Hill Book Company*  
*Josephine T. Lees, Ronald Press*  
*Julien McKee, Houghton, Mifflin Company*  
*John Lowell Pratt, A. S. Barnes & Company*  
*James Rietmulder, Association Press*  
*Carol Woodward, The Macmillan Company*

*For complete list of Cooperating Publishers,  
see inside back cover.*

*Copyright by National Recreation Association, Incorporated.*  
*Printed in U.S.A.*

*Additional copies of this section are available at 25c postpaid.*  
*Quantity rates on application.*

*Prices are subject to publishers' changes.*

*Please use numbers when ordering.*

# A GUIDE TO BOOKS ON RECREATION

## Activities for Special Groups

### CHURCH RECREATION

See also *Drama, Parties & Entertainment, Program Planning*

752. BIBLE GAMES FOR YOUNG AND OLD. Flora Gilliss.

A new way to learn and understand Bible stories and lessons while playing over 300 original games based on them. \$1.00

753. CHORAL READINGS FOR FUN AND RECREATION—Selections for Young People of All Ages. H. Heltman and H. Brown, Eds.

A collection of 60 selections in 7 different categories, ranging from sheerest nonsense to thoughtful, inspirational poetry for group reading aloud. \$1.00 each

754. CHORAL READINGS FOR WORSHIP AND INSPIRATION. H. Heltman and H. Brown, Eds.

An anthology of poetry, hymns and Bible selections, arranged for choral reading. \$1.00 each

755. CHORAL READINGS FROM THE BIBLE. H. Heltman and H. Brown, Eds.

Gives young people and adults the experience of reading aloud some of the best known and most inspiring passages of the Bible. \$1.00 each

756. CHRISTIAN FELLOWSHIP GAMES. Robert Adell.

Bible quizzes, riddles, contests, and scores of other interesting, educational suggestions for the social gathering or recreational hour. \$1.00

757. GOLDEN BOOK OF CHURCH PLAYS. Lawrence M. Brings.

Designed to appeal to all Christian denominations as well as non-sectarian groups. Plays present moral and spiritual truths in an entertaining way. \$4.50

758. THE GROUP WORSHIP WAY IN THE CHURCH. Paul F. Douglass.

In non-technical language, this manual gives new ways to involve laymen in roles that promote their spiritual growth and the mission of their church. \$4.00

653. HOW TO PLAN INFORMAL WORSHIP. Winnifred C. Wymal.

Planning aids for interfaith and interdenominational worship. Several examples of services and suggested resources for workshop materials. \$1.00

655. RECREATION AND THE CHURCH. National Recreation Assn.

Information on facilities, leadership, program organization and directions for many different activities. \$.65

759. RECREATION AND THE LOCAL CHURCH. Frances Clemens, Robert Tully and Edward Crill, Eds.

A valuable tool to aid the local church in bringing organized recreation to an ever-widening circle. \$2.75

656. SERVICES FOR THE OPEN. Laura I. Mattoon and Helen D. Bragdon.

An interfaith sourcebook of 29 complete services, 83 hymns and songs, worship materials, responsive readings. clo. \$2.50; pa. \$2.00

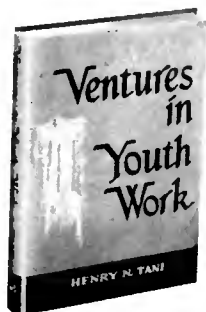

760. VENTURES IN YOUTH WORK. Henry N. Tani.

How to approach teenagers in the local church with the Christian gospel. Contains bibliographies of pertinent books, pamphlets and audio-visual aids. \$2.75

658. WORSHIP WAYS FOR CAMP. Clairce M. Bowman.

Prayers, graces, Scriptural aids, poetry, devotions, graded by age level and arranged for easy reference and use. \$3.00

### FAMILY FUN

See also *Games & Puzzles, Parties & Entertainment*

761. ART FOR THE FAMILY. Victor D'Amico, Frances Wilson and Moreen Maser.

Suggests through pictures and text creative activities such as painting, constructions and mobiles. \$2.95°

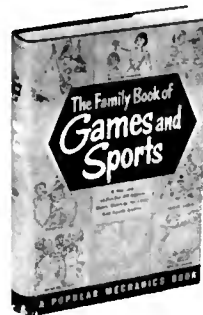

681. THE FAMILY BOOK OF GAMES AND SPORTS. Helen Joseph.

Outdoor sports for children and adults, indoor games, stunts, card and board games, ideas for indoor and outdoor parties. Complete rules, directions and strategy. \$2.95

562. THE FAMILY FUN BOOK. Helen and Larry Eisenberg.

Hundreds of ideas for outdoor fun, rainy day fun, fun on trips, hobby suggestions. For all ages. \$2.95

762. THE FAMILY PLEASURE CHEST. Helen and Larry Eisenberg.

Hints on family parties, dates at home, indoor games, family camping and picnics, games to play while traveling and backyard games. \$1.00

344. HOME PLAY. National Recreation Assn.

A 95-page booklet covering places to play in the home and active and quiet activities for the family. \$.75

763. SUNSET IDEAS FOR FAMILY CAMPING.

Accurate, tested information on how to plan your trip, what to take and how to get there. Includes camping in the mountains, desert, or at the beach. \$1.75

187. YOUNG ADULT AND FAMILY CAMPING. John A. Ledlie, Ed.

Program practices in adult resident camps, trip camping, short-term adult and family camps, program development and supervision. \$1.25

### RECREATION FOR THE ILL & HANDICAPPED

764. ADAPTED PHYSICAL EDUCATION—Principles and Practice of Physical Education for Exceptional Students. Arthur S. Daniels.

A manual of techniques used in teaching camping and aquatics to the handicapped. Emphasis on adjustment problems. \$6.00°

765. CLINICAL APPLICATIONS OF RECREATIONAL THERAPY. John E. Davis.

Discusses recreation in relation to mental health. Value of physical exercise and activity as adjunctive therapy in modern psychiatric treatment. \$3.75°

766. DANCE IN PSYCHOTHERAPY. Elizabeth Rosen.

An account of a pioneering attempt to use dance as a therapeutic activity in the treatment of the mentally ill. \$4.50°

5. A HANDBOOK OF HOSPITAL PSYCHIATRY: A Practical Guide to Therapy. Dr. Louis Linn.

A comprehensive approach to the treatment and rehabilitation of the mental patient, interpreting the roles of the social worker, nurse, attendant, etc. \$10.00°

767. HOW TO HELP THE SHUT-IN CHILD. Margery D. McMullin.

313 tested ways to entertain and encourage sick, housebound or invalid boys and girls. \$2.75

**Activities for Special Groups, Recreation for the Ill and Handicapped (Cont.)**

768. **MUSIC AND YOUR EMOTIONS.** Emil A. Gutheil, M.D., etc.

How to use music as a means of controlling and directing our emotional responses. The value of music in therapy. Pa. \$2.00, cl. \$3.00

769. **OCCUPATIONAL HANDICRAFTS.**

A guide to crafts of therapeutic value for those working with the physically handicapped. Included are raffia work, rug weaving, stencilling, papier-maché, etc. \$7.50

11. **RECREATION FOR THE HANDICAPPED.** Valerie V. Hunt.

Discusses problems encountered by handicapped persons in satisfying their needs through recreation; the psychophysical aspects of various disabilities. \$5.00°

12. **RECREATIONAL ACTIVITIES FOR CRIPPLED CHILDREN.** Lois Perrin.

Games, crafts and activities suitable for children of various stages of illness or disability. Illustrated with photographs, diagrams and patterns for making toys. \$1.00°

771. **REHABILITATION OF THE PHYSICALLY HANDICAPPED,** 2nd Ed. Henry H. Kessler, M.D.

Deals with the problems involved in restoring the crippled child, the injured worker, the disabled veteran and the chronic disabled. \$4.00

13. **SECOND HOSPITAL RECREATION INSTITUTE PROCEEDINGS,** 1956. National Recreation Assn.

Proceedings of Institute jointly sponsored by New York University School of Education and the National Recreation Assn. \$1.00

15. **STARTING A RECREATION PROGRAM IN A CIVILIAN HOSPITAL.** Beatrice Hill.

A 50-page booklet covering all phases of hospital recreation. With a bibliography. \$1.00

772. **THERAPEUTIC AND INDUSTRIAL USES OF MUSIC.** Doris Soibelman.

A comprehensive review of the literature on the medical uses of music with an appraisal of claims of various experts in the field. \$3.25°

**SENIOR CITIZENS**

773. **FUN FOR OLDER ADULTS.** Virginia Stafford and Larry Eisenberg.

A source of games, ideas and projects selected especially for this age group. Includes a bibliography of books and materials. \$1.00

4. **GROUP WORK WITH THE AGED.** Susan H. Kubie and Gertrude Landau.

Two experienced psychiatric social workers recount their experiences in setting up and working in a recreational day center for the aged. \$3.50°

774. **NEW GOALS FOR OLD AGE.** George Lawton, Ed.

A collection of essays aimed to illustrate the more recent ideas concerning the nature and needs of older people. \$3.00

775. **PLANNING THE OLDER YEARS.** Wilma Donahue and Clark Tibbitts, Eds.

Deals with the emotional, social and financial needs of older people. The role of the community is also discussed. \$3.50

10. **RECREATION FOR THE AGING.** Arthur M. Williams.

Activities for older people based on successful programs used by churches, civic, social, community center groups. \$3.00



14. **A SOCIAL PROGRAM FOR OLDER PEOPLE.** Jerome Kaplan.

Specific suggestions for organizing creative activity groups, planning suitable programs. Discusses senior age camping and the role of homes for the aged. \$3.00

**Arts & Crafts**

776. **ACTIVITIES IN CERAMICS.** Vernon D. Seeley.

Methods and projects in clay sculpturing with 145 photographs showing how to proceed. Also, how industry makes functional and decorative pottery. \$1.50

777. **AMERICA'S ARTS AND SKILLS.** Eds. of Life Magazine.

Over 230 full-color pictures of American design from Colonial hand tools, Georgian mansions, clipper ships, to skyscrapers and modern plastics. \$13.95



778. **ANTOINETTE POPE SCHOOL CANDY BOOK,** 2nd Ed. Antoinette and Francois Pope.

Up-to-date methods for making the choicest of candies in the home, from peanut brittle to chocolate creams. \$3.50

16. **ANYONE CAN PAINT.** Arthur Zaidenberg.

For anyone who can draw, a clear and effective instruction book for painting in oil, water color, tempera, etc. Includes 15 color plates, 200 other illustrations. \$3.95

17. **ART ACTIVITIES ALMANAC.** Art Education Alumni Assn., Wayne University, Eds.

Collection of 88 simple craft projects, each complete on a sheet with detailed illustrations. Published as a packet of loose worksheets. \$2.50

18. **THE ART AND CRAFT OF HAND WEAVING:** Including Fabric Design. Lili Blumenau.

A fully illustrated book, for beginner or expert, on yarns, looms, tools, weave and structure, design and procedure of fabric making. \$2.95

19-29. **ART INSTRUCTION BOOKS.** Charles X. Carlson.

Self-teaching books for beginners on various aspects of drawing, painting and decoration. Step-by-step instruction, illustrations.

19. **Charcoal Drawing.** \$1.00

20. **Figure Drawing - Constructive Method.** \$1.00

21. **Ink, Pen and Brush.** \$1.00

22. **Junior Artists, ABC of Drawing.** \$1.00

23. **Landscape Painting.** \$1.00

24. **Oil Painting.** \$1.00

25. **Pastel Painting.** \$1.00

26. **Pencil Drawing.** \$1.00

27. **Pictorial Decoration.** \$1.00

28. **Watercolor Painting.** \$1.00

29. **Simplified Color Mixing.** \$1.50

31-32. **ARTS AND CRAFTS SERIES.** Frank A. Staples.

Manuals for leaders, with comprehensive project outline covering all age groups. Accompanying workbook. Set \$3.00

31. **Arts and Crafts Program Manual.** \$2.50

32. **How To Do It—Arts and Crafts Projects for the Recreation Program.** \$1.00

33. **BLOCK PRINTING ON FABRICS.** Florence Harvey Pettit.

How to select materials and tools, make designs and blocks, mix colors, with 89 helpful illustrations. \$5.00

34. **BOATS, AIRPLANES, AND KITES.** A. J. LaBerge.

How to build sailboats, motor boats, several kinds of planes and kites. Well illustrated, for boys and girls, or leaders. \$2.75

35. **THE BOOK OF ARTS AND CRAFTS.** Marguerite Ickis and Reba Selden Esh.

More than 1000 items to be made from wood, metal, plastics, leather, clay, cloth and other materials. \$4.95

39. **THE BOY MECHANIC.** Eds. of Popular Mechanics.

A new and revised handbook containing over 500 interesting and useful projects for young craftsmen. \$3.95

41. **BUILD IT YOURSELF BOOK FOR BOYS.** Eds. of Popular Mechanics.

Some 60 projects that boys, with limited craft experience, can build - airplane models, water skis, kites, raft, bobsled, bird house, etc. Illustrated. \$2.50

779. **THE CANDLE BOOK.** Carli Laklan.

The first and complete book on candles and candlecraft as a hobby or for money-making. \$3.50

42. **CARVING ANIMAL CARICATURES.** Elma and W. H. Waltner.

A pictorial presentation - large photographs show every detail of carving for two of the figures. Photographs of every new technique on others. Structural lines shown in drawings. pa. \$2.00

43. **CERAMICS.** Harry Zarchy.

For boys and girls aged 12 and over, clear text explaining every aspect of ceramics. Illustrated with drawings and photographs by the author. \$3.00

\* Not subject to NRA membership discount.



**44. CERAMICS BOOK.**

Complete book for the beginner or the skilled craftsman. Clear, step-by-step photographs and easy to follow directions show slip casting, glazing, firing, pieces to make, etc. \$1.75; de luxe ed. \$3.00

**46. CERAMICS FOR THE ARTIST POTTER.** F. H. Norton.

A complete book for beginners. Each operation clearly explained and fully illustrated with photographs and diagrams. \$7.50\*

**48. CHILDREN CAN MAKE IT.** Experiences in the World of Materials, No. 28.

Things children can make—furniture, toys, models, musical instruments, etc. Illustrated. \$.75\*

**49. THE COMPLETE BOOK OF FURNITURE REPAIR AND REFINISHING.** Ralph Kinney.

Step-by-step directions for restoration, repairs, refinishing, revising of old finishes, with tips on proper maintenance. \$3.95.

**780. THE COMPLETE GUIDE TO CARTOONING.** Gene Byrnes.

157 top cartoonists explain how to progress from the fundamentals to the professional level. \$3.95



**50. CONTEMPORARY HANDWEAVING.** Ruth Overman and Lula Smith.

For beginning and advanced weavers. Step-by-step instructions for the 4-harness loom; progress of weaving as a craft; problems encountered. Illustrated. \$7.50

**781. COURSE IN BEGINNING WATERCOLOR.** John B. Musacchia, etc.

Describes and illustrates the basic operation involved in composition, selecting subjects, using materials and equipment. \$3.95

**782. COURSE IN PENCIL SKETCHING.** Ernest W. Watson.

Step-by-step instructions and demonstrations plus actual assignments in three volumes. \$2.95 ea., \$7.50 set.

Book 1—Buildings and Streets.

Book 2—Trees and Landscapes.

Book 3—Boats and the Harbor.

**53. CRAFTS PROJECTS FOR CAMP AND PLAYGROUND.** National Recreation Assn.

Simple projects that can be made from inexpensive and readily available materials. \$50

**783. CREATIVE CRAFTS FOR CAMPERS.** Catherine T. Hammett and Carol M. Horrocks.

An emphasis on outdoor arts and crafts in organized camps and for handcrafters of all ages. 175 projects making use of Nature's designs and materials. \$7.95

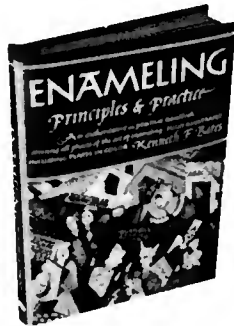

**55. CREATIVE HANDICRAFT.** Ira C. Madden.

Complete course in elementary craftwork, especially for grade school and junior high ages. Wide variety of project material — both wood and metalwork. \$3.75

**56. CREATIVE HANDICRAFTS.** M. R. Hutchins.

A book for the beginner covering elementary pottery, metalcrafts, leathercrafts, weaving, basketry, rug-making, wood carving, block printing, bookbinding, quilting. \$.75

**57. CREATIVE HANDS.** Doris Cox and Barbara Warren.

Detailed instructions for making dozens of decorative articles for use and wear. Photographs of each article, in addition to helpful drawings and diagrams. \$6.95

**59. DO-IT FUN FOR BOYS AND GIRLS.** Mary and Dale Goss.

Puzzles, games, ornaments, etc., that can be made from simple, handy materials. Humorous drawings explain every step clearly. For boys and girls from the ages of 7 to 12. \$2.75

**62. DOLLS TO MAKE FOR FUN AND PROFIT.** Edith F. Ackley.

Practical craft book for girls, or for anyone interested in doll-making as a hobby, or to sell. With illustrations by Telka Ackley. \$3.25

**784. DRESS ACCESSORIES AND GIFTS YOU CAN MAKE.** Marie I. Moore.

Over 150 easy-to-make patterns and instructions for stoles, collars, handbags and other items for fun and profit. \$1.50

**65. ELLISON ON MODEL RAILROADS.** Frank Ellison.

For advanced railroad hobbyists. Clearly written, many photographs and diagrams. \$2.00

**66. ENAMELING FOR FUN AND PROFIT.** Mary Larom.

Many illustrations and clear text give careful description of the enameling process for the beginner. \$3.00

**785. ENAMELING: PRINCIPLES AND PRACTICE.** Kenneth F. Bates.

A practical guide for the beginner and an authoritative reference for the craftsman illustrating the various methods and techniques of making enamels. \$3.95

**786. EXPLORING THE HAND ARTS.**

Basic tools and suggested projects in paper, prints, bookbinding, wood metal, glass, leather, clay and needlecraft. \$.65\*

**72. FUN IN THE BACK YARD.** Arthur Lawson and Mary Breen.

How to make the most of play space for both children and adults. Building instructions, with diagrams, for outdoor fireplaces and picnic equipment. \$3.00

**73. FUN-TIME CRAFTS.** James Schwalbach.

Crafts for children of third to sixth grade level, many ideas for making delightful things with materials readily at hand. \$2.80

**76. FUN WITH BEADS.** Joseph Leeming.

Easy-to-follow directions and diagrams show how to weave, embroider and sew with beads. For making or decorating articles. \$3.00

**787. FUN WITH BOXES.** Joseph Leeming.

How to make various articles from boxes. Diagrams by Charles E. Pont. \$3.00

**77. FUN WITH CLAY.** Joseph Leeming.

A complete book for beginners on clay modeling with self-hardening and over-baked clays. Illustrations by Jessie Robinson. \$3.00

**788. FUN WITH FABRICS.** Joseph Leeming.

96 pages full of ideas on how to make decorations, clothing and other items from fabrics. \$2.75

**789. FUN WITH PAPER.** Joseph Leeming.

Another "Fun" book for enthusiastic hobbyists. Illustrated by Charles E. Pont. \$3.25

**78. FUN WITH PLASTICS.** Joseph Leeming.

Simple directions and designs for making jewelry, vases, toys, and many other things from plastics. With illustrations by Jessie Robinson. \$3.00

**790. FUN WITH PENCIL AND PAPER.** Joseph Leeming.

Fascinating ideas for hobby enthusiasts and craftsmen who want to work with simple materials. Age 9 up. \$2.95

**79. FUN WITH WIRE.** Joseph Leeming.

Simple and clever designs for many articles, from flower pots to jewelry, that can be made from wire. Clear directions, illustrations for each object by Jessie Robinson. \$3.00

**791. FUN WITH WOOD** Joseph Leeming.

Every detail of woodworking, from design to finishing the final product. For all ages. \$3.00

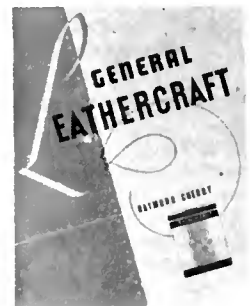

**80. GENERAL LEATHER-CRAFT.** Raymond Cherry.

Especially for the beginner, clear instruction and 365 photographs for every detail from laying out and cutting to putting in zippers. \$1.50

**792. HANDICRAFT — Simplified Procedure and Projects,** 9th Ed. Lester Griswold.

Over 600 photographs and line drawings illustrating things to make. Designed to stimulate the impulse to "learn by doing". \$5.50\*

**Arts & Crafts (Cont.)**

**81. HAND WEAVING WITH REEDS AND FIBERS.** Osma C. Gallinger and Oscar H. Benson.

Covers important principles of hand weaving in simple language and logical order. Shows several hundred useful articles to be made from inexpensive material. \$3.95

**83. HANDMADE RUGS.**

Step-by-step instructions for hooking, braiding, lacing, weaving and knitting rugs. Fresh, new designs, plus 25 projects. Includes directions for cleaning various types of rugs. \$1.75; de luxe ed. \$3.00

**793. HOBBY TOOLS AND HOW TO USE THEM.** Robert Gorman.

Fully illustrated, step-by-step introductory projects in ship modeling, whittling, model airplane building, leathercraft, metalwork, silk screen, etc. \$.75\*

**85. HOMEMADE TOYS FOR FUN AND PROFIT.** Arthur Lawson.

How to make interesting, inexpensive toys for fun, or to make extra money. \$3.00

**86. HOW TO BUILD MODEL RAILROADS AND EQUIPMENT.** Barton K. Davis.

Over 100 detailed scale drawings and clear text give directions for making exact replicas of rolling stock, bridges, trestles, signals, layouts. \$3.95

**88. HOW TO DO WOOD-CARVING.** John Lacey.

All directions thoroughly illustrated, hundreds of step-by-step photographs. \$2.00

**89. HOW TO DRAW.** Victor Perard.

Practical, self-teaching book covering shading, pencil, pen and brush technique, line composition, perspective, figures, details. Many illustrations. \$3.75

**794. HOW TO FIND YOUR OWN STYLE IN PAINTING.** Ray Bethers.

What style is and how the kind of person you are will influence your style. Outlines in lucid text and pictorial diagrams the basic principles of color, pattern and space. \$3.50

**90. HOW TO MAKE AND PLAY A SHEPHERD PIPE.** National Recreation Assn.

Simple directions for construction with inexpensive materials, together with playing instructions. \$.60

**91. HOW TO MAKE DOLL CLOTHES.** Emily R. Dow.

Suitable for girls 10 to 13, directions and patterns for doll clothes, adaptable for puppets. Simple enough for beginners, original enough for experienced sewers. Illustrated by author. \$2.50

**795. HOW TO MAKE MOBILES.** John Lynch.

Easy-to-follow directions for making intriguing mobile sculpture from metal, wood, glass and other materials. \$3.00\*

**92. HOW TO MAKE MODERN JEWELRY.** Charles J. Martin and Victor D'Amico.

175 plates illustrate 18 carefully graded projects intended to develop a mastery of technique and a feeling for design. bds. \$2.50\*; pa. \$1.50\*

**93. HOW TO MAKE OBJECTS OF WOOD.** Kendall T. Bassett and Arthur B. Thurman.

A series of projects to help the beginner design and make objects of wood with hand and power tools. Includes 220 plates. bds. \$2.50\* pa. \$1.50\*

**94. HOW TO MAKE PAPER FLOWERS AND PARTY DECORATIONS.** Natalie Morgan.

Complete instructions for hundreds of flowers, gift wrappings, costumes, table decorations, holiday trimmings. Over 600 illustrations. \$2.98

**95. HOW TO MAKE POTTERY AND CERAMIC SCULPTURE.** Julia Hamlin Duncan and Victor D'Amico.

Projects in pottery and ceramics based on hand construction, with minimum of tools. bds. \$2.50\*; pa. \$1.50\*

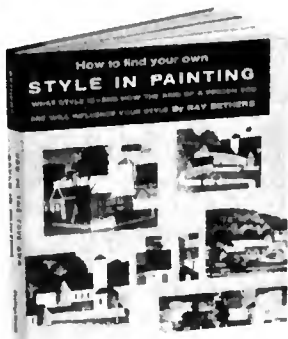

**96. HOW TO MAKE POTTERY AND OTHER CERAMIC WARE.** Muriel P. Turoff.

A practical book, with many illustrations, showing how to make and handle clay, tools, technique, sources of supply. \$2.95

**796. HOW TO MAKE SHAPES IN SPACE.** Toni Hughes.

Explicit diagrams, photographs and simple instructions for making three-dimensional posters, ornaments, cards and decorations for home, school or professional use. \$4.95

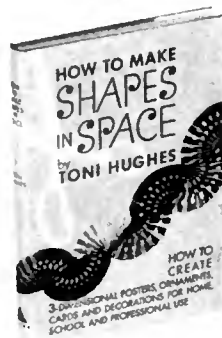

**797. HOW TO PLAN AND BUILD YOUR OWN FIREPLACE.**

How to build or remodel the fireplace you now have. 300 photographs and drawings. Tipped-in blueprint. \$2.00

**99. JEWELRY MAKING FOR FUN AND PROFIT.** Helen Clegg and Mary Larom.

Step-by-step instructions and graphic illustrations for making jewelry. Designed especially for use by clubs and groups. \$3.25

**101-107. KNOPF JUNIOR ACTIVITY BOOKS.**

Elementary art and craft books for boys and girls from 7 to 11. Easy to follow text, helpful illustrations.

101. Leathercraft. Roger Lewis. \$1.50

102. Metalcraft. Roger Lewis. \$1.50

103. Puppets and Marionettes. Roger Lewis. \$1.50

104. Sculpture: Clay, Soap and Other Materials. Roger Lewis. \$1.75

105. Weaving. Roger Lewis. \$1.50

106. Woodworking. Roger Lewis. \$1.50

107. Sewing. Jeanette Zarchy. \$1.50

**108. LEATHER CRAFT BOOK.**

Clear instruction and illustrations for the beginner in leatherwork. Includes 22 beautiful, practical projects with directions and patterns that can be traced from book. \$1.75; de luxe ed. \$3.00

**109. LINOLEUM BLOCK PRINTING.** Francis J. Kafka.

Step-by-step directions in several techniques of making and using linoleum blocks. Well illustrated, presentation simple enough for beginners to be successful. \$1.50

**110. McCALL'S GIANT GOLDEN MAKE-IT BOOK.** John Peter.

A thousand things for boys and girls to do and make. Patterns and instructions for masks and mobiles, costumes, toys and games, indoor gardens, candy, cookies. All illustrated in color. \$2.95; (Goldencraft \$3.19\*)

**798. METAL SCULPTURE.** John Lynch.

New forms and new techniques, wire designs, mobiles, soldered and welded sculpture are fully discussed. \$4.50\*

**799. A METHOD FOR CREATIVE DESIGN.** Adolfo Best-Maugard.

This book describes a practical method for teaching the principles of design. \$3.00

**800. MOBILE DESIGN.** John Lynch.

Here are eight new designs to copy and assemble, including patterns and instructions. \$3.95\*

**115. MODEL RAILROAD BOOK.** Warren F. Morgan.

Hundreds of pictures. An outstanding feature: how to combine toy train equipment with scale model equipment. \$2.00

**801. MODELLING.** Maria Petrie.

Relief work, simple pottery, clay modelling, and casting, for the beginner in this craft. 14 illustrations. \$2.30

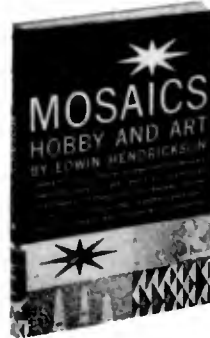

**802. MOSAICS: HOBBY AND ART.** Edwin Hendrickson.

The essentials of a new hobby requiring no special artistic talent or age limit. Details and photos on how to make many functional objects of different designs and color schemes. \$3.50

**803. MOST POPULAR ARTS AND CRAFTS.**

Crafts projects for younger boys on beginner's level. Description of each project includes materials, tools and equipment, cost and instructions. \$2.25

**118. THE NATURAL WAY TO DRAW.** Kimon Nicolaides.

For both beginners and advanced artists. The author's technique stresses a definite emotional connection between the artist and the object he draws. \$5.00

**119. NATURE CRAFTS FOR CAMP AND PLAYGROUND.** National Recreation Assn.

A wide variety of group and individual craft projects. \$5.50

**804. NEW AND INEXPENSIVE ARTS AND CRAFTS.**

Inexpensive crafts projects, some with accompanying drawings. Description of each project includes instructions for making and appropriate age group. \$2.25

**805. OFFSET PRINTING—A Guide for Amateurs.** Louis Heitner.

How to prepare art work, mechanicals, etc., for offset printing. \$1.50

**806. OIL PAINTING.** Stephen Bone.

A practical guide to painting still-lives, landscapes, and portraits from nature, sketches or from memory. \$4.00

**807. OIL PAINTING IS FUN.** Alois Fabry.

Ten simple projects for Sunday painters and beginners of all ages. Includes color plates showing how to mix tones and a selection of work done by amateurs. \$2.95\*

**808. 101 GAMES TO MAKE AND PLAY.** Horth.

A selection of popular games, such as table tennis, badminton, croquet and dominoes, with instructions for making them from odds-and-ends and inexpensive materials. \$1.00

**809. 103 EASY JIG SAW PROJECTS.** Floyd Mix.

Gives full-size patterns and construction details for making novelties, gifts, ornaments and useful gadgets with hand or power saw. \$1.50

**121. ORIGINAL LITHOGRAPHS OF THE HUMAN FIGURE.** L. A. Doust.

Eight sections of original lithographs showing studies of various aspects and positions of the male and female figure. Spiral binding. \$2.50

**810. PAPER CRAFT.** Joseph Leeming.

How to make toys, favors and other useful articles. Drawings by Jessie Robinson. For Junior High School boys and girls. \$2.95

**811. PAPER FIGURES.** Anna Pauli and Margaret Mitzet.

Photographs show how to make human and animal forms of paper with moving heads, arms and legs. \$2.00



**812. PAPER SCULPTURE AND CONSTRUCTION.** Josephine V. Miller.

This illustrated booklet tells how to give paper character, how to use light, shadow, space designs and color values to produce decorative results. \$1.50

**122. PICTORIAL GUIDE TO MACHINE SHOP PRACTICE.** H. Grisbrook and C. Phillipson.

Graphic presentation of the foundations of machine shop practice. Hundreds of pictures showing right and wrong methods. \$2.50

**123. PLANNING YOUR HOME FOR PLAY.** Albert A. Ostrow.

How to create a safe backyard playground, or convert your basement into a family activity room. Hints on using attic, garage, roof space to best advantage. \$3.50

**813. PLYWOOD PROJECTS FOR THE HOME CRAFTSMAN.** Robert Scharff.

Plywood from A to Z. Planning, designing, constructing, and finishing discussed in text and pictures. \$3.95

**124. PRACTICAL CARPENTRY.** Floyd Mix and Ernest H. Cirou.

Easy-to-understand cyclopedia of building information. Stresses proper technique, accepted carpentry practices and the use of modern building materials. \$5.00

**814. PULL UP AN EASEL.** Norman Garbo.

By using a nontechnical approach, this book helps any novice master the fundamentals of this enjoyable hobby. \$3.75

**815. QUILTING.** Elizabeth King.

This book gives instructions and diagrams on planning, cutting and making a quilt. Details on applique. New and old patterns; also tufting quilted garments and shadow quilting. \$6.00

**127. SCULPTURE IN WOOD.** John Rood.

A noted sculptor gives step-by-step instructions in wood sculpture, describes tools needed, qualities of various woods and how to finish them. With 133 plates. \$5.00

**816. SCULPTURE: PRINCIPLES AND PRACTICE.** Louis Slobodkin.

The methods of sculpture described and demonstrated in over 300 progressive photographs, drawings and charts. \$7.50

**128. SEE AND SEW.** Mariska Karasz.

The art of sewing made attractive and easy to learn through clear pictures and simple text. Illustrated with drawings by Christine Engler. \$3.00

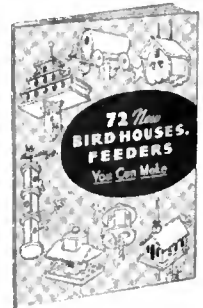

**817. 72 BIRD HOUSES AND FEEDERS YOU CAN MAKE.** Hi Sibley.

Simplified instructions for making one-family Wren houses to 58-room hotels for Martins. Individual parts of each house are dimensioned separately for easy construction. \$1.50

**131. SILK SCREEN PRINTING.** James Eisenberg.

Details of silk screen printing shown in detail in 159 illustrations. Covers five popular methods and includes suggestions for making equipment and tools. \$1.50

**818-819. DOUST SKETCH BOOKS.** L. A. Doust.

Simple, direct information on basic principles of drawing. Hints on how to increase your skill with examples illustrating the text.

818. Simple Sketching. \$1.50

819. Sketching the Country-side. \$1.50

**133. A SIMPLIFIED GUIDE TO GIFT WRAPPING.** Adelaide and Josephine Shaw.

A spiral bound book, fully illustrated. \$1.00

**134. STEP-BY-STEP COOK BOOK FOR GIRLS AND BOYS.** Julia Kiene.

Complete menus, tested and selected by children, nearly 100 recipes, fully detailed, with over 500 illustrations by William Sayles. Ages 8 to 14. bds. \$2.95; (Golden-craft \$2.99\*)

**136. TECHNIQUE OF OIL PAINTING.** Leonard Richmond.

A standard work on oil painting for beginner or experienced artist. Color illustrations cover every stage from palette to the finished picture. \$10.00

**820. WATERCOLOR MADE EASY.** Herb Olsen.

A how-to-water-color book, full of professional instructions about painting landscapes, seascapes and the human figure. \$7.95

**139. WATER COLOR PAINTING IS FUN.** Frank A. Staples.

Simple instructions in the techniques of painting with water colors for the amateur. With illustrations. \$4.00

**140. WEAVING HAND-CRAFT.** Marthann Alexander.

Picture presentation of 15 simple ways to weave, using inexpensive, easy-to-build tools and equipment. How to weave many practical, useful articles. \$1.50

**821. WHY NOT PAINT A WATERCOLOR.** Frank Stearn.

A practical handbook which provides the novice with illustrated step-by-step procedures. Describes materials and equipment, their selection and use. Instructions on matting and framing. \$7.75

**142. WOOD CARVING BOOK.**

Easy to follow instructions for beginners in incised, chip, relief, and carving in the round, with 25 projects, all beautifully illustrated \$1.75; de luxe ed. \$3.00

**144. THE WORKSHOP BOOK.** Martha Lincoln and Katherine Torrey.

General directions on working with children, many plans for toys, puppets, furniture, etc. Every object illustrated with diagrams; many photographs. \$5.00

## Camping

See also *Arts & Crafts, Drama, Nature, Parties & Entertainment, Program Planning*

### ORGANIZATION & ADMINISTRATION

145. ADMINISTRATION OF THE MODERN CAMP. Hedley S. Dimock, Ed.

Outlines functions, principles and procedures of camp management for the director and staff. Articles from 11 contributors. \$4.00°

147. BETTER CAMPING. Ralph D. Roehm.

Outlines the procedures for national recognition in camping; desirable practices for all camps. A complete revision of "Toward Better Camping." \$.75°

822. THE CAMP NURSE.

Designed as a guide to help the nurse in any camp program serve youth and their needs. Helpful to the director in providing a sound health program. \$.50°

823. CAMP SITE DEVELOPMENT.

Modern camp planning and building with data on water supply, roads, electric lines, and all camp facilities. For camp directors and building committees. \$4.00°

824. DIRECTORY OF CAMPS AFFILIATED WITH THE AMERICAN CAMPING ASSN.

A guide to summer camps throughout the U.S. for parents seeking selection of proper camp for their children. Specializing camps also listed. \$.50°

162. EDUCATION THROUGH SCHOOL CAMPING. Helen Manley and M. F. Drury.

To encourage administrators and teachers to undertake a program of school camping. Discusses advantages to education of such an outdoor program. \$3.25°

165. HANDBOOK OF YMCA CAMP ADMINISTRATION. John A. Ledlie and Ralph Roehm, Eds.

Drawn from the experiences of hundreds of camp directors, this handbook covers every aspect of camp operation. \$4.50°

178. SCHOOL CAMPING. George Donaldson.

A basic statement of the philosophy and methods of school-sponsored year-round camps. Camping as education and recreation. \$2.25°

825. THE SUCCESSFUL CAMP. Lewis C. Reimann.

For camp administrators, camp committeemen and students. Covers every aspect from the selection of the site to the building of camper and staff morale. Publication, January 1958. \$4.75°

185. WESTERN CAMPSITE DIRECTORY.

A book of complete information on all national, state, and county campsites in the West. Describes facilities of 33,914 campsites at 1887 Western campgrounds. \$1.00

### LEADERSHIP

149. CAMP COUNSELING. A. Viola Mitchell and Ida B. Crawford.

Complete, up-to-date guide to camping—how to handle problem campers, instructions for teaching crafts, music, sports, etc. \$4.75°

826. CAMP COUNSELOR TRAINING WORKBOOK. Marie Hartwig and Florence Petersen.

Useful as a textbook on counselor training or as a guide to a pre-camp session, this book combines camping theory with practice. \$2.50°

151. CAMP COUNSELOR'S MANUAL. John A. Ledlie and Francis W. Holbein.

A camp counselor's daily job, his qualifications, relationships to campers and directors. Section on record keeping. \$1.00

155. CAMPING — A GUIDE TO OUTDOOR SAFETY AND COMFORT. Arthur H. Des-Grey.

Practical information for inexperienced campers and those going on their first trip. Can serve as text for counselor training courses. \$3.00°

156. CAMPING AND CHARACTER. Hedley S. Dimock and Charles E. Hendry.

Covers leadership training, appraising results of camp experience, some typical problems, social controls in camp. \$4.00°

164. HANDBOOK OF TRAIL CAMPCRAFT. John A. Ledlie, Ed.

Complete guidebook for camper-counselor training in campcraft. Suggestions for every phase of hiking from cook-out to two-week trip. \$4.95

167. IT'S FUN TO BE A COUNSELOR. Emily H. Welch.

Enthusiastically tells qualities, values and relationships that make for happy counselors and campers. \$1.00

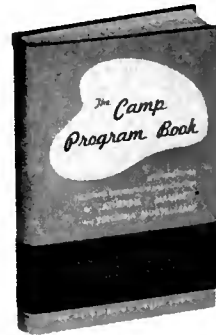

180. SO YOU WANT TO BE A CAMP COUNSELOR. Elmer F. Ott.

The opportunities and responsibilities of a camp counselor, what is expected of him at all times, attitudes and techniques to help him do his job. \$1.00

181. SOLVING CAMP BEHAVIOR PROBLEMS. J. Kenneth Doherty.

Emphasizes underlying causes of such problems as homesickness, stealing, timidity, poor eating, showing off, etc. \$1.00

182. SPIRITUAL VALUES IN CAMPING. Clarice M. Bowman.

Shows how the whole camping experience can add to the spiritual growth of young people, with reference to overall program of daily activities. \$3.00

184. TALKS TO COUNSELORS. Hedley S. Dimock and Taylor Statten.

Fifteen vivid talks on what the modern camp counselor needs to know. Applies psychology, mental hygiene, and sociology to the counselor's job. \$.75

### PROGRAM

827. ABC'S OF CAMP MUSIC. Janet E. Tobitt.

A reference book for counselors of songs suitable for campers of all ages as well as dramatized ballads and song dances. \$.75°

828. BARBEQUE COOK BOOK.

How to use a barbeque to best advantage. 250 recipes for grilling, skewering, roasting and preparing sauces. \$1.95, de luxe ed. \$3.50

829. CAMP CRAFT. Barbara E. Joy.

A wealth of specific information on materials, procedures and organizing activities. It gives directors and counselors a wider appreciation of camping opportunities. \$2.75°

152. THE CAMP PROGRAM BOOK. Catherine T. Hammett and Virginia Musselman.

A one-volume camping encyclopedia covering program planning, outdoor living, sports, arts and crafts, specific programs, pageants. \$5.00

153. CAMP SONGS 'N' THINGS.

A book of 120 pages containing the words and music for camp songs and some stunts. Paperbound. \$.30

830. CAMPCRAFT ABC'S.

Suggestions for making camp implements from pot hooks to lean-to's. A guide to such skills as knotcraft, fire-building, tent-pitching and cooking. \$1.25°

154. CAMPFIRE AND COUNCIL RING PROGRAMS. Allan A. Macfarlan.

Handbook of campfire games and stunts, council ring pageants, plus Indian ceremonies and magic demonstrations. \$2.50

831. CAMPING. Barbara E. Joy.

Covers basic philosophy, administration, leadership, program, sanitation, camp craft and counselor-camper relations. For camp director or counselor. \$2.75°

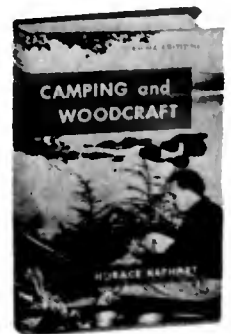

157. CAMPING AND WOODCRAFT. Horace Kephart.

An encyclopedia of outdoor living. Nearly 900 pages give answers to the problems arising on a camping trip. Over 300 illustrations. \$4.95

159. CAMPING HANDBOOK. H. Burke, Ed.

For beginning and experienced campers, every subject needed to be safe and comfortable in forest and field. \$2.00

832. HOW TO BUILD OUT-DOOR FIREPLACES. Bill Baker.

The construction methods for fireplaces to suit every landscape requirement with 200 photographs. \$2.00



166. HOW TO BUILD YOUR HOME IN THE WOODS. Bradford Angier.

Profusely illustrated book telling how to build log cabins, camping shelters, rustic furniture for vacation or year-round living. \$3.50

JAEGER BOOKS FOR CAMP AND TRAIL. Ellsworth Jaeger.

Fully illustrated guides, useful and practical for perfecting camping and woodcraft skills.

168. Wildwood Wisdom. \$3.95

171. Woodsmoke. \$2.95

172. Land and Water Trails. \$2.95

833. Council Fires. \$2.95

834. Tracks and Trailcraft. \$3.95

175. OUTDOORSMAN'S COOKBOOK. Arthur Carhart.

Revised edition of standard camper's guide. Covers latest developments: aluminum foil, dehydrated foods, plastic utensils, meat preservation. Includes recipes. \$2.95

176. PROGRAM HELPS FOR CAMP LEADERS. Chapman, Gaudette and Hammett.

Packet of 20 sheets of pictorial suggestions on nature, campcraft, dramatics, crafts and program planning. \$.50\*

183. SUMMER MAGIC. Kenneth B. and Susan H. Webb.

What camping is all about. Includes a checklist of points parents should observe in choosing a suitable camp for their children. \$2.50

## Community Recreation

See also *Facilities, Layout, Equipment; Leadership; Organization and Administration; Philosophy; Program Planning*

196. THE ABC'S OF PUBLIC RELATIONS FOR RECREATION. National Recreation Assn.

A 64-page booklet on techniques for creating public interest in community recreation. \$.85

197. A BRIEF HISTORY OF PARKS AND RECREATION IN THE UNITED STATES. Charles Doell and Gerald B. Fitzgerald.

History of the parks and recreation movement as a distinct product of our culture. \$1.50

200. COMMUNITY RECREATION, 2nd Ed. Harold D. Meyer and Charles K. Brightbill.

An introduction to the study of organized recreation in the U.S. for students and teachers, a guide for professional recreation workers. \$6.00\*

201. A COMMUNITY YOUTH DEVELOPMENT PROGRAM. Robert J. Havighurst, etc.

Describes a community program for fostering gifted children and guiding potentially maladjusted children. \$1.50\*

835. EXPLORING THE SMALL COMMUNITY. Otto G. Hoiberg.

An account of the opportunities and problems of organizing community recreation in a small, rural town. Describes goals, procedures and leadership necessary to produce this result. \$3.50

203. INTRODUCTION TO COMMUNITY RECREATION. George D. Butler.

Discussion of recreation as a function of local government. Deals with types of recreation that require a large degree of organization. \$6.00

208. 1956 RECREATION AND PARK YEARBOOK. National Recreation Assn.

A report of public recreation and park agencies, local county, state and federal. Includes data on the Managing Authority, Areas, Personnel, Indoor and Outdoor Centers, Facilities, Finances, and Activities. \$2.00

209. RECREATION FOR COMMUNITY LIVING.

Outlines principles, practices and policies which recreation agencies can follow to make their programs most effective. \$1.25

210. SCHEDULE FOR THE APPRAISAL OF COMMUNITY RECREATION. National Recreation Assn.

A guide to help check and evaluate facilities, personnel, programs and services against a standard. \$.75

213. STUDYING YOUR COMMUNITY. Roland L. Warren.

A working manual for laymen and those engaged in community service. Suggests organizational, planning and action programs for community betterment. \$3.00

## Dancing

See also *Music, Parties and Entertainment*

836. THE AMERICAN SQUARE DANCE. Margot Mayo.

Descriptions of folk dances from all sections of our country. Popular dances with calls and choruses. Discusses music and instruments. \$.95



837. AND PROMENADE ALL. Bert Lyle and Mary Lib McDonald.

Square dance calls and full piano accompaniments for simple folk games. Explains the meaning of terms and how to get the dancing started. \$1.00

214. BALANCHINE'S COMPLETE STORIES OF THE GREAT BALLETS. George Balanchine.

Stories of 131 ballets, sections on enjoying ballet, history of ballet, selection of recordings. Illustrated with photographs and drawings. \$5.95

838. THE BALLET COMPANION. Olga Maynard.

A how to look and how to listen guide to The Nutcracker, La Sylphide, Le Pas de Quatre and Cinderella. Age 8 and up. \$3.50

215. BALLET FOR BEGINNERS. Felicity Gray.

Useful guide to students of ballet, as well as an introduction to the ballet world from the "inside." Over 100 photographs by Gordon Anthony. \$3.50

839. BALLET FOR BEGINNERS. Margaret F. Atkinson and Nancy Draper.

Basic ballet positions and practice methods, how a ballet is created and how this art form began. Synopses of ballets especially appealing to children. \$3.75

840. THE BALLET - STUDENT'S PRIMER. Kay Ambrose.

An illustrated book for beginners in ballet which can be used with confidence by all students at the elementary stage. \$2.50

218. BETTY WHITE'S DANCING MADE EASY. Betty White.

A social dance book on an adult level. Covers all the popular dances from the waltz and foxtrot to the samba and conga. Illustrations by Robert Burns. \$3.95

219. BETTY WHITE'S TEEN-AGE DANCE BOOK. Betty White.

A gay, stream-lined guide to modern dancing. Illustrated with diagrams and 150 drawings by Robert Burns. \$3.95

841. BETTY WHITE'S TEEN-AGE DANCE ETIQUETTE. Betty White.

Presents the accepted social practices for teen-agers at an informal dance, prom or ball. Illustrated by June Kirkpatrick. \$2.50

220. THE BOOK OF BALLET. James Audsley.

Development of ballet described fully for children. Some of the most famous classical ballets explained. Color illustrations. Boards \$1.25

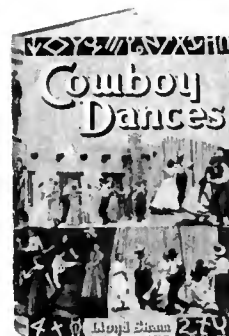

222. COWBOY DANCES. Lloyd Shaw.

A collection of cowboy dances with full instructions in text, photographs and diagrams. Dances of pioneer to modern times. \$5.00

223. DANCE A WHILE. Harris, Pittman and Swenson.

Representative dances from a wide range of folk, square and social dances. Of particular value to the new or inexperienced teacher. Spiral bound. \$3.50\*

**Dancing (Cont.)**

842. DANCE IN ELEMENTARY EDUCATION. Ruth Lovell Murray.

A practical presentation of the devices, music and games for developing rhythmic skills, approaches to making new dances, analysis and procedures for teaching dance steps. \$4.00\*

225. EUROPEAN FOLK DANCE: Its National and Musical Characteristics. Joan Lawson.

Exact instructions, with scores and illustrations, for almost every kind of folk dance known. Background of how the dances have developed. \$8.50

226. FESTIVALS AND PLAYS OF CHILDREN. Arnold.

A series of rhythmic plays and dances arranged by the seasons of the year. \$2.50

227. THE FIRST BOOK OF THE BALLET. Noel Streatfeild.

Basic exercises and steps presented through the lessons of a young dancer. Diagrams of steps, pictures of great ballets and ballerinas. \$1.95

843. FOLK DANCE GUIDE, 1957. Paul Schwartz.

A source of information on the various facets of folk dancing in the U.S. including a Calendar of Annual Events and a Directory of Instruction Groups. \$1.00\*

228. FOLK DANCES AND SINGING GAMES. Elizabeth Burchenal.

Complete directions for performing 26 folk dances of the U.S., Denmark, Sweden, Russia, Hungary, Finland, Italy, Czechoslovakia, England and Scotland. Many illustrations. Boards. \$3.50

230. FOLK DANCES FROM OLD HOMELANDS. Elizabeth Burchenal.

A collection of 33 folk dances from Belgium, Czechoslovakia, Denmark, England, Finland, France, Germany, Ireland, Lithuania, Poland, Portugal, Russia, Spain, Sweden, U.S. \$3.50

844. HI, SQUARE DANCERS. Kenneth Fowell.

For square dancers with a bit of experience and for groups of various sizes, this book offers a selection of American squares and round dances. \$1.50

233. HONOR YOUR PARTNER. Ed Durlacher.

A square dance encyclopedia of 81 American Square, Circle and Contra Dances explained in detail, both instructions and music. Each dance illustrated, calls included. \$8.50

234. HOW TO BECOME A GOOD DANCER. Arthur Murray.

America's most famous dancing instructor sets forth the principles that have been successful in teaching more than three million people how to dance well. \$3.95

845. HOW TO IMPROVE YOUR SOCIAL DANCING. Beale Fletcher.

A new "count system" method of home instruction in the basic and advanced steps in ballroom and social dances. Illustrated. \$3.75

235. LET'S DANCE WITH MARGE AND GOWER CHAMPION. Bob Thomas.

The secrets of all the popular dance steps for the beginner and the experienced dancer. With step-by-step diagrams, charts and photographs. \$1.00

846. LET'S SQUARE DANCE. Kenneth Fowell.

A guidebook for beginner dancers and call-teachers in American squares and round dances. \$1.00

237. MIXERS TO MUSIC FOR PARTIES AND DANCES. Virginia Musselman.

Suggestions for musical games and dances for parties. \$.65

847. PARTNERS ALL—PLACES ALL! Miriam H. Kirkell and Irma K. Schaffnit.

Designed for dance enthusiasts and leaders. Contains music, "calls" and coaching instructions arranged together for easy use. \$3.95



240. RHYTHMIC ACTIVITIES. Frances R. Stuart and John S. Ludlam.

Two indexed packets, each containing 50 dances and folk games. Simple music scores. Series I, kindergarten through grade 3; series II grades 3 through 6. ea. packet \$2.25\*

242. THE ROUND DANCE BOOK. Lloyd Shaw.

Presents the technique of basic steps, such as the waltz, polka, mazurka, etc. and traces their origin and history. For beginners or leaders. Illustrated. \$5.00

244. SINGING GAMES AND DANCES FOR SCHOOLS AND PLAYGROUNDS. Carl Ziegler.

For schools and playgrounds, traditional games and simple folk dances adapted for the primary ages. Classified and graded. \$.80

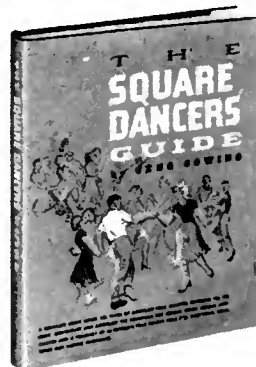

848. THE SQUARE DANCERS' GUIDE. Gene Gowing.

A complete book about all types of American folk dancing; the essentials for leaders and callers; 50 dances with directions, calls, tunes. \$3.95

247. SQUARE DANCES OF TODAY AND HOW TO TEACH AND CALL THEM. Richard Kraus.

Wide selection of calls, directions for teaching many dances, appropriate music for each. Illustrations; 31 musical scores. \$3.25\*

849. SQUARE DANCING FOR EVERYONE. Gene Gowing.

Simple directions for over 15 dances such as the Alabama Jubilee and the Texas Star. 80 photos and diagrams. \$1.00

**Drama**

See also *Dancing, Holidays, Parties & Entertainment, Puppets.*

**CHILDREN'S THEATRE**

255. CHILDREN'S THEATRE MANUAL. Seattle Junior Programs, Comp.

Practical booklet of detailed advice on creating and maintaining a children's theatre organization for the community. \$.75\*

259. CREATIVE DRAMATICS FOR CHILDREN. Frances Caldwell Durland.

A guide to the values of creative dramatics in education, including scripts written and presented by children's groups. clo. \$2.75; pa. \$1.50

850. PLAYMAKING WITH CHILDREN, 2nd Ed. Winifred Ward.

For classroom teachers, specialists in speech education and religious education leaders who want to use creative drama to help children to express their ideas. \$3.50\*

851. SEVEN STEPS TO CREATIVE CHILDREN'S DRAMATICS. Pamela Walker.

How to set up a dynamic children's theatre and instructions for producing a play. Includes three original scripts. \$3.00

294. STORIES TO DRAMATIZE. Winifred Ward, Ed.

Anthology of 100 stories for use in Creative Dramatics. Each story introduced by suggestions for its use. Material grouped by age level. For children and young people 5 through 14. \$4.75\*

297. SUPPLEMENTARY MATERIALS FOR USE IN CREATIVE DRAMATICS WITH YOUNGER CHILDREN. Agnes Haaga and Patricia A. Randles.

Describes actual sessions with children, role of dramatics in recreation, materials used. \$2.00\*

300. THEATRE FOR CHILDREN. Winifred Ward.

Covers every detail of organizing and operating a children's theatre. Revised from earlier edition to cover present children's groups in U.S. Expanded play list. Illustrated. \$3.50\*

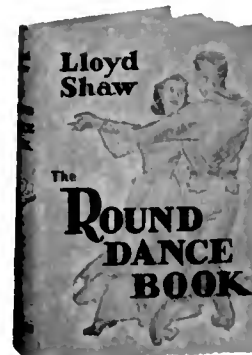

302. TWENTY-ONE YEARS WITH CHILDREN'S THEATRE. Charlotte B. Chorpensing.

Covers the author's experience in writing, directing and staging for children's theatre. Discusses children's acting and the child audience \$3.50\*

\* Not subject to NRA membership discount.

**COLLECTIONS**

**253. 20 BEST EUROPEAN PLAYS ON THE AMERICAN STAGE.** John Gassner, Ed.

Contains 20 full-length Continental plays which have been important in the American theatre. The translation included is the one by which the play became known here. \$5.75

**853. BLUE-RIBBON PLAYS FOR GRADUATION.** Sylvia E. Kamerman, Ed.

A variety of one-act plays suitable for graduation programs including a pageant on growth of America. Junior and Senior High School. \$3.50\*

**854. THE CASE OF THE MISSING HANDSHAKE.** Nora Stirling.

A 30-minute play for parents, designed to stimulate discussion on the "inconsistency" of behavior of pre-teen-agers. \$1.00\* ea. Producing packets (6 scripts), \$4.50\*

**855. CHRISTMAS PLAYS FOR YOUNG ACTORS.** A. S. Burack, Ed.

Comedies, fantasies, histories, biographies, serious dramas about the Christmas theme. \$3.50\*

**856. EASY ARENA PLAYS.** Louis J. Huber.

17 short plays and skits to be played in an open area, indoors or outdoors. \$1.00

**281. EASY STUNTS AND SKITS.** National Recreation Assn.

Sixteen brief stunts and skits of various types, all easy to produce. \$5.00

**262. FACE YOUR AUDIENCE.** William Hodapp.

Collection of over 50 readings from one-minute excerpts to an original half-hour TV script. Also summary of techniques and approaches for the actor. \$3.95

**857. FOUR-STAR PLAYS FOR BOYS.** A. S. Burack, Ed.

A collection of 15 one-act plays for all-boy casts offering a wide range of settings and a variety of characters. Easy to produce. \$3.50\*

**265. THE HANDBOOK OF SKITS AND STUNTS.** Helen and Larry Eisenberg.

Complete instructions for 400 easily staged skits and stunts. Includes some longer skits requiring rehearsal. \$2.95

**858. HOLIDAY PLAYS FOR TEEN-AGERS.** Helen Louise Miller.

These 21 one-act comedies for celebrating holidays offer a calendar of entertainment. Each play brings out the ideals and traditions of a particular holiday. \$4.00\*

**859. HOLIDAY PLAYS FOR YOUNG ACTORS.** Grace Sorenson.

Plays about special events suitable for the intermediate and upper grades. Appeals to an audience of youngsters and adults alike. \$1.00

**266. INDIVIDUAL AND DUAL STUNTS.** Hugo Fischer and Dean Shawbold.

Stunts for all ages, clearly photographed on cards, indexed and filed in a handy container. 175 cards, each showing one or more stunts. \$2.50\*

**860. INTERNATIONAL FOLK PLAYS.** Samuel Selden.

A collection of 9 plays written by students of dramatic art at University of North Carolina. \$5.00

**288. IT'S TIME TO GIVE A PLAY.** Elizabeth Hough Sechrist and Janette Woolsey.

A collection of 26 original non-royalty plays dramatizing historical events, holiday observances, lands and people, etc. Especially for children 6 to 9. \$3.50

**269. JUNIOR PLAYS FOR ALL OCCASIONS.** Mildred Hark and Noel McQueen.

Collection of 43 one-act, non-royalty plays for holidays, special occasions and general entertainment. For lower and middle-grade age groups. \$4.00\*



**271-274. THE LIBRARY OF BEST AMERICAN PLAYS.** John Gassner, Ed.

A boxed set of four volumes containing 79 complete plays, covering the period 1917-1951. ea. \$5.75; set \$21.50.

**271. Twenty-five Best Plays of the Modern American Theatre: Early Series.**

**272. Twenty Best Plays of the Modern American Theatre.**

**273. Best Plays of the Modern American Theatre: Second Series.**

**274. Best American Plays: Third Series.**

**861. MELODRAMAS AND FARCES FOR YOUNG ACTORS.** Earl J. Dias.

12 old-fashioned melodramas and modern farces complete with villains, heroes and heroines and plenty of stage business to enliven these half-hour dramas. \$4.00\*

**276. MINIATURE PLAYS.** Madge Miller.

Collection of 4 short plays: Pinocchio, Snow White and Rose Red, Robinson Crusoe, Puss in Boots, for small cast and modest scenery. Illustrated with production photographs. \$3.00\*



**862. THE MODERN TREASURY OF CHRISTMAS PLAYS.** Lawrence M. Brings.

Compilation of 22 one-act plays carefully edited to meet the needs of churches and schools, suitable for adults and teen-agers. Emphasis on the real spirit of Christmas. \$4.50

**863. MYSTERY PLAYS FOR YOUNG PEOPLE.** John Murray.

16 one-act thrillers utilizing simple settings, every-day dress, and exciting atmosphere. \$4.00\*

**277. NEW PLAYS FOR RED LETTER DAYS.** Elizabeth Hough Sechrist and Janette Woolsey.

Collection of original plays for holidays, special weeks, historical dates, stressing simplicity of setting and dramatic appeal. For ages 9 to 13. \$3.50

**864. ONE-ACT PLAYS FOR ALL-GIRL CASTS.** Marjorie Paradis.

12 one-act comedies for teen-age girls with crisp dialogue, amusing situations, modern settings. \$3.00\*

**279. 100 NON-ROYALTY ONE-ACT PLAYS.** William Kozlenko, Compiler.

A varied collection including pageants, religious and holiday plays, children's plays, all-boy casts, all-women casts. \$3.95

**280. PAGEANTS AND PROGRAMS FOR SCHOOL, CHURCH AND PLAYGROUND.** National Recreation Assn.

For almost any occasion, but particularly appropriate for patriotic holidays or Brotherhood Week. \$5.00

**281. PATRIOTIC PLAYS AND PROGRAMS.** Aileen Fisher and Olive Rahe.

A collection of royalty-free plays, playlets, group readings, spelldowns and recitations suitable for young people from lower grades through high school. \$4.00\*

**865. PRIZE PLAYS FOR TEEN-AGERS.** Helen Louise Miller.

24 popular one-act plays including holiday plays and comedies. Simple settings and everyday costumes. \$5.00\*

**289. RADIO PLAYS FOR CHILDREN.** Katherine Williams Watson.

Adaptations, especially for radio, of popular children's stories of the past and present. \$2.50\*

**866. RADIO PLAYS OF FAMOUS STORIES.** Lewy Olsson.

15 classic stories adapted for royalty-free performance in classrooms, assemblies, and over radio stations or school loudspeaker systems. \$3.75\*

**867. ROUND - THE - YEAR PLAYS FOR CHILDREN.** Alice Very.

35 short plays for important holidays and festivals. Adaptations of folk tales and legends, nature plays and dramatizations for the 4 seasons. \$3.50\*

**868. SPECIAL PLAYS FOR SPECIAL DAYS.** Mildred Hark and Noel McQueen.

24 one-act plays, both traditional and modern, for major holidays. Middle grades through Junior High. \$3.75\*

**295-296. STUNTS SERIES.** National Recreation Assn.

Stunts that require few properties and costumes that can be easily improvised. ea. \$5.00

**295. Six New Dramatic Stunts.**

**296. Six More Dramatic Stunts.**

**298. TALL TALES AND TALL MEN.** Nellie McCaslin.

A collection of 12 original one-act plays based on American legends. All non-royalty, requiring a minimum of scenery and costuming, suitable for junior high school ages. \$3.50

**Drama (Cont.)**

869. TEEN-AGE SKETCHES. W. F. Miksch.

Plays and skits for teenagers. Suitable for assemblies, special programs, entertainments. Themes deal with the every-day experiences of young people. \$1.00

301. TREASURY OF RELIGIOUS PLAYS. Thelma S. Brown, Ed.

For teens and adults, 20 easily-staged plays on basic religious themes. Casts from 2 to 18 characters, length from 10 to 60 minutes. \$3.00

870. TWENTY-FIVE PLAYS FOR HOLIDAYS. Mildred Hark and Noel McQueen.

A selection of one-act plays for special occasions for youngsters of junior and senior high school age. \$4.00\*

871. UNITED NATIONS PLAYS AND PROGRAMS. Aileen Fisher and Olive Rabe.

The aims and accomplishments of the UN are dramatized in a collection of original program material for young people of all ages. \$3.75\*

**PRODUCTION & TECHNIQUES**

250. THE ABC'S OF PLAY PRODUCING: A Handbook for the Nonprofessional. Howard Bailey.

Every stage of production covered in concise detail. Appendix of classified, recommended plays. Illustrated with diagrams. 3.95

252. ACTING. Toby Cole, Comp.

A handbook on the art of acting, based on the famous method developed by Stanislavski and now widely used in many theatre groups. \$3.50

254. BIBLICAL COSTUMES FOR CHURCH AND SCHOOL. Virginia Wilk Elicker.

Basic garments necessary for Biblical plays, materials, patterns and directions for making. How to vary the basic garments for different times and places. \$3.00\*

258. THE COSTUME BOOK FOR PARTIES AND PLAYS. Joseph Leeming.

Simple directions and designs for making period and fancy costumes from inexpensive materials. Illustrated by Hilda Richman. \$3.00

872. COSTUME THROUGHOUT THE AGES. Mary Evans.

An interesting and informative discussion of the sociological, historical and decorative importance of clothing. \$5.00

263. THE FIRST BOOK OF STAGE COSTUME AND MAKE-UP. Barbara Berk.

How to costume a show simply and inexpensively. Covers headgear and artificial hair, padding out a figure, collecting and using make-up material, etc. \$1.95



286. HOW TO PRODUCE A PLAY. Jack Stuart Knapp.

Guide for the inexperienced play producer on all phases of dramatic presentation. \$5.00

270. LET'S GIVE A SHOW. Bill and Sue Severn.

A guide to simple, easy, home theatre craft for boys and girls 8 to 12. For living room, backyard, camp and club entertainment. Illustrated with drawings and diagrams. \$2.50

873. LIGHTING THE STAGE. P. Corry.

Designed for producers, designers, and all others who are concerned with the esthetic use of light on the stage. \$4.50

874. PRINCIPLES OF THEATRE ART. H. Albright, etc.

A complete and balanced treatment of every phase of drama with emphasis on principles underlying theatre practices and techniques. \$6.50\*

852. SOCIAL GROWTH THROUGH PLAY PRODUCTION. Jack Simos.

This book shows how older adolescents and adults can be helped to grow socially through direct participation in formal, traditional dramas, creatively produced and directed. \$3.75

292. STAGE TECHNIQUE MADE EASY. Selma Paley Morosco and Athea Lounsbury.

In simple language, with charts and diagrams, two experienced coaches tell how to walk, to turn, to speak to another person, how to conduct oneself on stage. \$2.50

293. STAGE CRAFT AND SCENE DESIGN. Herbert Philipp.

A comprehensive, fully illustrated coverage of every element of the modern theater. Useful to the beginner or to the designer-technician. Includes 45-page glossary. \$4.50\*

875. TEEN THEATRE. E. and N. Gross.

This book gives complete descriptions of all the jobs associated with the production of a play, with six royalty-free plays to test them on. \$3.25

876. THEATRE SCENECRAFT. Vern Adix.

Over 350 drawings and photographs with simple text make this book a handy sourcebook of all areas of stagecraft. \$6.50\*

877. WORKING UP A PART. H. Albright.

A sound and practical approach to acting for the beginner, moving from analysis of a role, through rehearsal, to performance. Creative exercises included. \$3.50\*

**Facilities, Layout, Equipment**

See also *Arts & Crafts, Camping, Community Recreation*

878. EASY-TO-MAKE OUTDOOR PLAY EQUIPMENT. Reginald R. Hawkins.

Describes 40 playthings the amateur carpenter can make with common hand tools. Cooperative projects for parents and children. \$2.95

304. HANDBOOK FOR SCHOOL CUSTODIANS. Alanson D. Brainard.

Handbook covering recent developments in techniques for the care and maintenance of school buildings and grounds. Paper bound. \$1.75

879. MAKE YOUR OWN OUTDOOR SPORTS EQUIPMENT. John Lacey.

Twenty projects for building economical sports equipment with instructions and diagrams. Ages 11 and up. \$2.75

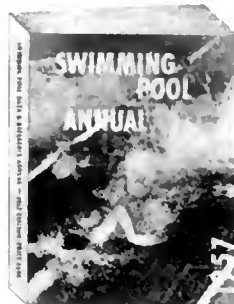

308. OUTDOOR SWIMMING POOLS. George D. Butler.

Information on planning, basic design features and construction. \$.75

310. PLANNING FACILITIES FOR HEALTH, PHYSICAL EDUCATION AND RECREATION.

A guide for school boards, park and recreation leaders, city planners, etc. \$2.50

312. RECREATION AREAS—THEIR DESIGN AND EQUIPMENT, 2nd Ed. George D. Butler.

Outlines of planning principles, design suggestions, details of structure and equipment. Well illustrated with 169 photographs and diagrams. \$6.00



880. RECREATION PLACES. Wayne R. Williams.

Essentials of designing recreational facilities for individuals, families, neighborhoods, businesses and industries. 400 photographs, plans and drawings. \$12.50

313. SCHOOL-CITY COOPERATION IN THE PLANNING OF RECREATION AREAS AND FACILITIES. George D. Butler.

A discussion of cooperative planning methods in various cities. \$.75

314. STANDARDS FOR MUNICIPAL RECREATION AREAS. George D. Butler.

Contains specifications for play lots, play fields, playgrounds, parks and special areas. With a brief bibliography. \$.50

881. SWIMMING POOL DATA & REFERENCE ANNUAL.

Contains the newest pool designs, building, maintenance and sanitation know-how. A 400 page directory of equipment, supplies, and services. \$5.00

882. TAKE THE GUESSWORK OUT OF POOL PLANNING.

Written by experienced authorities for those considering the promotion and construction of a pool. \$5.00

883. TOWARD NEW TOWNS FOR AMERICA. Clarence S. Stein.

A revised edition written by a Fellow of the American Institute of Architects covering city development and urban design. 160 half-tones, plans and drawings. \$12.50

\* Not subject to NRA membership discount.



## Games & Puzzles

See also Music, Parties and Entertainment

**316. ACTIVE GAMES AND CONTESTS.** Bernard S. Mason and Elmer D. Mitchell.

A collection of 1800 games and contests of a vigorous nature. Traditional and well-known forms of games together with newer approaches. \$4.75\*

**884. AMERICAN NONSINGING GAMES.** Paul G. Brewster.

Presents over 150 folk games from all parts of the U.S. Clearly and simply described with diagrams and information about the origin of each game. \$3.75

**317. THE BOOK OF GAMES.** G. Sherman Ripley.

Omnibus collection of favorite games, stunts, tricks, entertainment for ages 7 through 17. \$3.00

**318. THE BOOK OF GAMES FOR BOYS AND GIRLS: HOW TO LEAD AND PLAY THEM.** Evelyne Borst.

Indoor games, playground games, games needing no equipment, simple equipment, games for festive days, how to plan picnics. \$4.00\*

**319. BOOK OF GAMES — FOR HOME, SCHOOL, PLAYGROUND.** William Forbush and Harry R. Allen.

A revised collection of over 400 games for children and young adults, arranged according to age groups. \$3.00

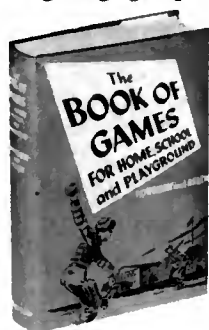

**885. CAN YOU NAME THEM?** Ray Bethers.

A pictorial, informational quiz book designed for teen-agers and adults. A visual question-and-answer game. \$1.75

**320. CHAMPIONSHIP CHESS AND CHECKERS FOR ALL.** Larry Evans and Tom Wiswell.

Illustrations and expert advice for beginning and less experienced players. \$3.75

**321. CHESS.** C. H. O'D. Alexander.

Primarily for beginners and weak players. New edition thoroughly revised and brought up to date. Some notable recent contests included in the Illustrative Games section. \$2.20

**886. CONTRACT BRIDGE COMPLETE.** Charles H. Goren.

Contains detailed information on the point-count method, all modern bridge conventions, complete bidding and play, plus laws and quizzes. Illustrated and thumb-indexed. \$4.50

**325. CONTRACT BRIDGE FOR BEGINNERS.** Charles H. Goren.

A leading bridge authority outlines for the beginner all the rules for bidding and playing contract bridge. pa. \$1.00

**887. ENCYCLOPEDIA OF GAMES.** Doris Anderson.

686 active games and quiet games for young people, adults, social, church and family gatherings. \$2.95

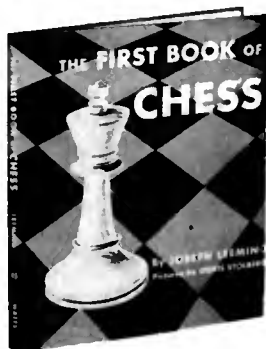

**328. THE FIRST BOOK OF CHESS.** Joseph Leeming.

Step-by-step instructions for beginning players. Striking diagrams in two colors show how each piece moves and captures. Eleven practice games, glossary of special chess terms. \$1.95

**329. FOSTER'S COMPLETE HOYLE.** R. F. Foster.

An encyclopedia of all card games, including the Regency Club rules for Canasta and the latest revised laws for Contract Bridge. A new edition, revised and enlarged. \$3.95

**888. FUN WITH PUZZLES.** Joseph Leeming.

A wonderful indoor sport for children of all ages and for every member of the family. \$3.00

**334. GAMES FOR BOYS AND MEN.** National Recreation Assn.

Active and quiet games, stunts, contests and other ideas. \$1.25

**335. GAMES FOR CHILDREN.** Marguerite Kohl and Frederica Young.

Over 250 tested games, indoor and out, active or quiet. Age groups 4-6, 7-9, and 10-12. \$2.50

**336. GAMES FOR THE ELEMENTARY SCHOOL GRADES.** Hazel A. Richardson.

File of 160 cards with 137 individual games with variations. Classified by grade and indexed for playground, gym and classroom. \$2.25\*



**889. GAMES FOR JUNIOR AND SENIOR HIGH SCHOOL STUDENTS.** Hazel A. Richardson.

171 selected games, where they can be played, number of players, and equipment needed on 4 x 6 cards for handy use. \$2.75\*

**338. GAMES FOR QUIET HOURS AND SMALL SPACES.** National Recreation Assn.

More than 160 games and stunts that can be played almost anytime, anywhere. \$75

**340-341 GAMES SERIES.** Muriel E. McGann.

Games for use in home, club, school and community center. ea. \$50

**340. Active Games for the Live Wires.** For 6 to 14 age group.

**341. Singing Games.** For 5 to 7 age group.

**890. GAMES TO BUILD.**

Instructions and drawings, tools, equipment, materials needed for making board, box, floor, wall and table games and puzzles. Age groups and rules for playing each game. \$2.50

**343. HANDBOOK OF ACTIVE GAMES.** Darwin A. Hindman.

Over 800 games described, every recognized major and minor athletic or gymnastic game. Complete and well classified. \$5.00\*

**345. HOW TO PLAY BETTER CHESS.** Fred Reinfeld.

A champion chess player tells how to increase skill and pleasure in the game. Thoroughly covers the three parts of the game, with special attention to opening theory. \$2.95

**346. HOW TO PLAY CHESS.** Emanuel Lasker.

A new and revised edition of one of the best books on chess. Particularly good for beginners in the game. \$1.00

**347. AN INVITATION TO CHECKERS.** Millard Hopper.

An American checker champion gives a play by play guide to better checker playing. Includes diagrams and descriptions of championship games. \$2.95

**348. AN INVITATION TO CHESS.** Irving Chernev and Kenneth Harkness.

A picture guide to make chess enjoyable for the beginner. Directions are given by means of hundreds of pictures of actual games played. \$2.95

**349. LEARN CHECKERS FAST.** Tommie Wiswell.

Tips for beginners, model games on the basic seven openings, introduction to three-move checkers, and other information for players of varying skill. \$2.50

**350. LEARN CHESS FAST!** Sammy Reshevsky and Fred Reinfeld.

A writer and a leading American chess player collaborate on a clear and simple guide to the game. Many illustrations, every fundamental detail explained in diagram style. \$2.75

**891. MAH JONG FOR BEGINNERS.** Shozo Kanai and Margaret Farrell.

Clear and precise. Gives rules and procedures, strategy and hints for winning. Illustrated. \$1.00

**352. MATH IS FUN.** Joseph Degrazia.

Brain-teasing problems and puzzles, cryptograms, speed puzzles, problems of arrangement. Answers included. No knowledge beyond high school mathematics required. \$2.75

**892. THE NEW COMPLETE HOYLE.** Albert Morehead, Geoffrey Mott-Smith and Richard Frey, Eds.

From fan-tan and mah-jong to Scrabble and Calypso, this revised Hoyle gives the full history, official rules and play of over 600 games. \$3.95

**354. NEW GAMES FOR "TWEEN-AGERS.** Allan A. Macfarlan.

Emphasis on games requiring little or no equipment. Covers 158 new, unusual games for pre-teen and teen-age boys and girls. Games graded for age appeal. \$3.00

**Games & Puzzles (Cont.)**

893. THE PLEASURE CHEST. Helen and Larry Eisenberg.

Basic handbook for fun leaders for parties, active games, group games, suggestions for teen groups, activities for children and adults. \$1.00 pa., \$1.50 cl.

355. POINT COUNT BIDDING IN CONTRACT BRIDGE. Charles H. Goren.

One of the country's leading authorities on contract bridge outlines his simple and accurate new system of bidding in bridge. \$1.00

356. SCARNE ON CARDS. John Scarne.

An advanced book to improve skill and success at cards. Includes mathematics of all games, clearly stated rules, pointers from successful players. Illustrated. \$3.95

**Hobbies**

See also *Arts & Crafts, Nature, Photography*

894. ADVENTURE BOOK OF MONEY. Eva Knox Evans.

Early history, myths, and legends, mint-marks, rare coins, collecting and trading. Complete picture guide of important coins. \$2.95

895. AMERICAN DOLLS. Ruth Freeman.

Describes every named American doll from the 1850's on with chapters on doll types and copies of original patent drawings. \$3.00

896. ART OF FLOWER ARRANGEMENT. Tatsuo Ishimoto.

A clear, authoritative book on the art of arranging flowers for decorative and esthetic effect. 150 photographs. \$2.95

897. THE ART OF KNOTTING AND SPLICING. Cyrus Day.

Hundreds of step-by-step pictures and explanatory text covering every aspect of this field. \$4.00

898. BETTER FLOWER ARRANGEMENTS FOR HOME AND EXHIBITION. Elizabeth Bear.

From simple home arrangements to the fine art of Oriental arranging. Also, principles of line, color, texture, harmony and balance. \$1.50

899. BOOK-COLLECTING AS A HOBBY. P. H. Muir.

A handbook for beginners that will also delight and inform the experienced book-collector. \$3.00

900. THE BOOK OF KNOTS, TIES, AND SPLICES. J. Irving.

Clearly written and easy to understand. Indispensable to sailors, yachtsmen and all who handle ropes, with particular interest for Boy and Girl Scouts. \$2.25

901. THE BOYS' FIRST BOOK OF RADIO AND ELECTRONICS. Alfred Morgan.

The history of radio, scientific discoveries, detailed plans for building simple radio-receivers, amplifiers, etc. Presents basic facts about radio, TV and electronics. \$3.00

188. CARE AND FEEDING OF HOBBY HORSES. E. E. Calkins.

How to get the most benefit from leisure time. Explains hundreds of popular and practical hobbies for recreational programs. \$.60

190. THE COMPLETE BOOK OF COLLECTING HOBBIES. William Paul Bricker.

How and where to select first items, how to display them, etc. Covers china, furniture, stamps, shells, buttons, books, clocks, photographs and more. Illustrated. \$3.50

902. CREATIVE HOBBIES. Harry Zarchy.

Clear text and more than 300 explanatory diagrams simplify the procedures in woodcarving, stagecraft, lamp making, whitening, bookbinding, weaving, shellcraft, etc. \$3.50

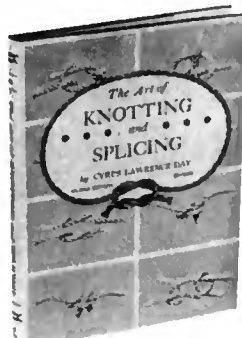

903. FLOWER ARRANGEMENT ART OF JAPAN. Mary Cokely Wood.

Thoroughly covers the theory, practice and philosophy of Japanese flower arrangement. Over 100 illustrations. \$1.50, de luxe ed. \$2.75

904. FLOWER ARRANGEMENT FOR CHURCHES. Adelaide B. Wilson.

Arrangements and ideas for every season, every type of church, every occasion in the church calendar. Color and black and white photos. \$4.00

68. FLOWER ARRANGING. Loret Swift.

How to buy flowers, necessary background and equipment, tools, and an Album of Arrangements. \$2.00

69. FLOWER ARRANGING FOR JUNIORS. Virginia Stone Marshall.

A simple and clear explanation of the basic principles of flower arrangement, especially for young people. With illustrations by the author. \$2.75

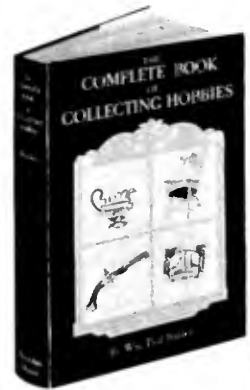

905. FLOWERS: THEIR ARRANGEMENT. Gregory J. Conway.

Illustrated with more than 180 photographs, this is a useful and authoritative book that every flower lover will enjoy. \$3.95

191. FUN FOR YOUNG COLLECTORS. Joseph Leeming.

Excellent for young hobbyists. Describes 32 different types of collections, with suggestions for sources of supply, display, etc. \$2.85

906. HAMMOND'S GUIDE TO NATURE HOBBIES. E. L. Jordan.

How to begin a nature hobby, where to find specimens and how to add to your knowledge and to your collection. \$2.95

907. HERE'S YOUR HOBBY. Harry Zarchy.

Ceramics, archery, painting, photography, fishing and sailing are covered by an experienced arts and crafts instructor. All ages. \$3.00

908. HOW TO DECORATE AND LIGHT YOUR HOME. E. W. Commery and C. Eugene Stephenson.

Hundreds of ideas for brightening up the home. Contains photos in black and white and full color. \$6.75

909. HOW TO MAKE CUT FLOWERS LAST. Victoria R. Kasperski.

Hints for every amateur flower arranger and professional florist. With illustrations. \$2.95

910. JUNIOR FLOWER ARRANGING—For 8 to 12 Year Old Arrangers and All Senior Helpers. Katherine N. Cutler.

Ideas for adults attempting to introduce children to gardening and arranging as an art. \$3.95

193. LET'S START A STAMP COLLECTION. John S. Turner.

A simple introduction to philately for the youngest collectors, with maps, cuts and excellent stamp identification tables. \$2.25

911. THE MAGIC WORLD OF FLOWER ARRANGING. Myra J. Brooks, Mary Alice and John P. Roche.

Projects for the experienced exhibitor, the professional decorator and the home-maker. Well-coordinated photographic illustrations. \$10.00

1034. NUMISMATICS. Lewis M. Reagan.

A 16-page booklet on coin-collecting as a hobby plus information on choosing this field as a career. \$1.00

912. STAMP COLLECTOR'S GUIDE. Harry Zarchy.

An easy-to-follow guide for the beginning stamp collector. Photographs and diagrams by the author. Ages 12 to 16. \$3.50

194. STAMP COLLECTING. Roger Lewis.

A Knopf Junior Activity Book for 7 to 11-year-olds with information on an absorbing hobby. With illustrations and photographs. \$1.50

913. WHY NOT WRITE? William J. Redgrave.

Tells how to get ideas for stories and articles, where to obtain background material and how the novice writer can sell his manuscripts. Lists many little-known literary markets. \$1.00

\* Not subject to NRA membership discount.

## Holidays & Special Days

See also *Arts & Crafts, Drama, Travel*

### 362. THE AMERICAN BOOK OF DAYS.

George W. Douglas. Gives information on the history, origin and customary observance of holidays, church feasts and fast days, anniversaries of historical events, and local festivals, in America. \$6.00°

### 364-367. CHRISTMAS BOOKLETS.

A series of booklets covering all phases of preparation for the Christmas season: programs, activities, games, decorations.

364. The Christmas Book. Marguerite Ickis. \$.75

365. Christmas Crafts and Decorations. National Recreation Assn. \$.75

366. Games for the Christmas Season. National Recreation Assn. \$.65

367. Plays, Pageants and Ceremonials for the Christmas Season. National Recreation Assn. \$.65

### 368. CHRISTMAS EVERYWHERE.

Elizabeth Hough Sechrist. The observance of Christmas in Mexico, India, Japan, Persia, Turkey and many other lands. For ages 8 to 12. With five-color illustrations by Guy Fry. \$2.95

### 914. CHRISTMAS IDEA BOOK.

Dorothy Biddle and Dorothea Blom. Hundreds of decorations and useful items for homemakers and garden-club members to make for Christmas. 121 photographs and two in color. \$3.50

### 370. DECORATING FOR JOYFUL OCCASIONS.

Marjorie W. Young. Unique decorating ideas for Christmas, showers, weddings, receptions, other celebrations. Fully illustrated. Brief sketch of history of some of the holidays. Flower arrangements. \$1.50

### 915. EASTER IDEA BOOK.

Charlotte Adams. A variety of ideas for recipes, parties, menus and useful Easter gifts to sew, crochet, or paint. Illustrated. \$3.50

### 916. THE FIRST BOOK OF HOLIDAYS.

Bernice Burnett. Clearly written text and pictures by Marjorie Glaubach giving the origins and explanations of best-loved American holidays and how to celebrate them. \$1.95

### 917. GOOD THINGS FOR MOTHER'S DAY.

Beatrice Marie Casey. Appropriate plays, dialogues, recitations, monologues and exercises for the primary to upper grades. \$2.75

### 373. HEIGH-HO FOR HALLOWE'EN!

Elizabeth Hough Sechrist. A complete book about everything connected with Halloween — plays, stories, songs, poems, games, parties, costumes and customs. For boys and girls 8 to 14. Illustrated. \$2.95

### 918. THE HOLIDAY BOOK.

Marguerite Kohl and Frederica Young. Hundreds of new ideas to enliven the traditional gaiety of religious, national and personal holidays. Covers refreshments, decorations, favors, games. \$3.00

### 919. HOLIDAY CANDY AND COOKIE COOK BOOK.

J. H. Degros. Recipes for making extra-special goodies for all holidays and instructions for basic candies and cookies with countless variations listed. \$2.00

### 920. HOLIDAY CRAFT AND FUN.

Joseph Leeming. A valuable craft book, full of clever ideas for party materials, favors, games for 17 important holidays all around the year. \$2.95

### 921. HOLIDAY PROGRAMS FOR BOYS AND GIRLS.

Aileen Fisher. Classroom and assembly material including plays, poems, skits, group readings and recitations. \$3.75°

### 922. HOLIDAY ROUND UP.

Lucile Pannell and Frances Cavanah. A collection of 52 stories for 27 holidays with special selections for birthdays and the Sabbath. Origins of the holidays. Age 8 to 13. \$3.75

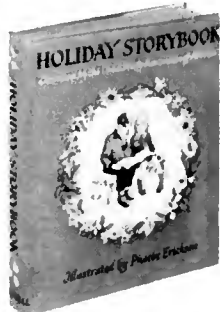

### 374. HOLIDAY STORYBOOK.

Child Study Assn. of America. A collection of 43 stories and verses celebrating America's important holidays. Religious, patriotic and family celebrations. Excellent for reading aloud. Illustrated. \$3.50°

### 375. IDEAS FOR CHRISTMAS.

To help make Christmas a more complete family holiday. Covers story of Christmas, customs, carols, decorations, parties, gifts, food, etc. Illustrated. \$2.00

### 376. LET'S CELEBRATE CHRISTMAS — Parties, Plays, Legends, Carols, Poetry, Stories.

Horace J. Gardner. For family, club, group leaders, low-budget ideas for Christmas festivities. Customs in other lands, decorations, refreshments, materials for readings. Illustrated. \$3.50°

### 923. MAKE YOUR OWN MERRY CHRISTMAS.

Anne Wertsner. A guide to handmade Yuletide decorations using readily obtainable materials. 30 illustrations. \$2.50

### 377. PLANNING FOR HALLOWEEN.

Muriel E. McGann. A comprehensive handbook suggesting activities and programs suitable for large and small groups, and for community-wide celebrations. \$.65

### 378. PLANNING FOR PATRIOTIC HOLIDAYS.

Muriel E. McGann. Games, skits, program outlines and historical background material for all major patriotic holidays. \$.65

### 379. RED LETTER DAYS: A Book of Holiday Customs.

Elizabeth Hough Sechrist. Traces the origin of American holidays and details the customs traditional for their celebration. For ages 8 to 12. Illustrated by Guy Fry. \$2.95

### 924. SHOWERS FOR ALL OCCASIONS.

Germaine Haney. Suggestions for invitations, menus, decorations, refreshments, entertainment, etc. for every type of shower-giver. Illustrated. \$2.75

### 925. TRUE BOOK OF HOLIDAYS.

Purcell. An introduction to the origins and significance of many of the special days we celebrate told in simple story-telling form. \$2.00

### 926. WEDDING ANNIVERSARY CELEBRATIONS.

Beatrice Plumb, Mabel Fuller, etc. Entertainment ideas for each anniversary including toasts, skits, monologues and burlesque weddings. \$2.75

### 927. THE YEAR 'ROUND PARTY BOOK.

William P. Young and Horace J. Gardner. Complete directions for party programs covering the red letter days of the year. Delicious party recipes included. \$2.50

## Indian Lore

### 928. THE AMERICAN INDIAN.

Sydney E. Fletcher. Everything about the customs, dress and warfare of Indian tribes. With illustrations by the author. \$2.95

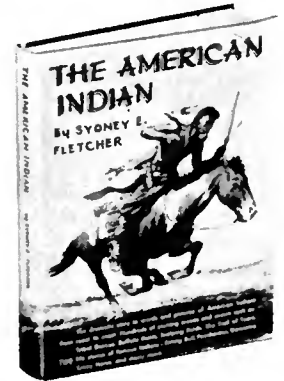

### 383. THE BOOK OF INDIAN-CRAFTS AND COSTUMES.

Bernard S. Mason. A thorough study of the customs and ways of life of the Indian. Illustrated. \$5.00

### 929. ECHOES OF THE RED MAN.

Irvin M. Peithmann. An archaeological and cultural survey of the Indians of Southern Illinois and their role in American history discussed and evaluated. \$3.00

### 385. THE GOLDEN BOOK OF INDIAN CRAFTS AND LORE.

W. Ben Hunt. Patterns and diagrams for making costumes, beaded decoration, tom-toms, peace pipes, totem poles. Directions for ritual dances. \$1.50; (Goldencraft \$2.19°)

### 930. INDIAN ACTION SONGS.

Densmore. A collection of 13 descriptive songs of the Chippewa Indians with directions for dramatizations. Words and music. Elementary grades. \$75

### 931. INDIAN AND FAMOUS SCOUT PLAYS.

Walter W. Anderson, et al. Included are 12 one-act plays on Indian lore designed for use in boys' and girls' summer camps and recreation centers. \$1.00

**Indian Lore (Cont.)**

932. INDIAN GAMES AND CRAFTS. Robert Hofsinde.

Detailed instructions for making the simple equipment needed for twelve Indian games and how to play them. \$2.50



387. INDIAN SIGN LANGUAGE. Robert Hofsinde.

How to form more than 500 words in Indian sign language, explained in clear text and over 200 drawings by the author. For boys and girls aged 10 and over. \$2.50

388. THE INDIAN'S SECRET WORLD. Robert Hofsinde.

Attractive, understanding presentation of Indian symbols and ceremonies by a painter and student of Indian lore. For ages 10 and over. Illustrations by the author. \$3.95

933. INDIAN TALES. Jaime de Angulo.

A book of American Indian folklore, legends and songs, written by a man who lived among the Pit River Indians of California for 40 years. \$4.25

934. THE INDIAN TIPI—Its History, Construction, and Use. Reginald and Gladys Laubin.

For those interested in camping, the out-of-doors, and Indian lore, as well as the historian and ethnologist. \$3.95

935. TREASURY OF AMERICAN INDIAN TALES. Theodore Whitson Ressler.

44 traditional stories from 27 tribes dealing with Indian adventure, hunting and fishing, customs, heroism and character. For children from 6 to 12. \$3.95

390. THE TRUE BOOK OF INDIANS. Teri Martini.

Shows small children, up to 10, how the Indians lived in their various environments of woodland, seashore, desert, plains. Full color pictures by Charles Heston. \$2.00

391. WAR WHOOPS AND MEDICINE SONGS. Charles Hofmann.

Contains Indian lullabies, game songs, the ceremonials, Indian flute melodies, work songs and songs of war. With illustrations. Boards. \$2.50\*

**Leadership**

See also *Camping, Community Recreation, Organization & Administration*

936. THE CHALLENGE OF CHILDREN. Cooperative Parents' Group of Palisades Pre-School Division and Mothers' and Children's Educational Foundation, Inc.

Parents must be mature and emotionally stable and understanding of themselves before they can guide their children to full development. \$3.75



937. THE CHILDREN WE TEACH. Nina Ridenour.

A pamphlet to help teachers and parents understand the personality development of children. Covers the shy child, the unpopular child, the emotionally disturbed child, etc. \$.40\*

394. COUNSELING WITH YOUNG PEOPLE. C. Eugene Morris.

Summarizes basic needs of young people, methods of appraising personality, how to help youngsters with their personal problems. \$3.00

395. CREATIVE GROUP EDUCATION. S. R. Slavson.

The function of the group in personality development. How the leader can fit the individual into group relationships. \$3.00\*

396. DYNAMICS OF GROUPS AT WORK. Herbert A. Thelen.

Discusses theory and practical experience in the functioning of six different types of working and learning groups. \$6.00\*

397. FOUNDATIONS OF PHYSICAL EDUCATION. Charles A. Bucher.

New edition including new sections on health, recreation, camping and outdoor education. Also discusses the philosophy of education. \$5.75\*

938. GROUP LEADERSHIP AND DEMOCRATIC ACTION. Franklyn S. Haiman.

A study of the practical group leadership and of discussion leadership as a part of the larger social scene. \$3.25\*

399. GROUP-CENTERED LEADERSHIP. Thomas Gordon.

A detailed description of the role of the leader and the actual situations he faces in helping a group to become self-directing and self-responsible. \$5.00\*

939. A GUIDE FOR CHAIRMEN. Harold C. Peterson.

Simplified explanation of the duties and responsibilities of the chairman, especially designed for the novice. \$.60

940. HOW TO ATTEND A CONFERENCE. Dorothea F. Sullivan.

Tells how to prepare yourself as a delegate, what to say, whom to meet, what to record for your report-back, and how to make that information help your organization. \$1.00

401. HOW TO BE A MODERN LEADER. Lawrence K. Frank.

Types of leadership, problems, purposes and aims of a group, meaning of an organization, leadership as personal development. \$1.00

402. HOW TO DEVELOP BETTER LEADERS. Malcolm and Hulda Knowles.

Practical ways for training and improving leadership in all kinds of organizations. Non-technical and concise. \$1.00

403. HOW TO HELP FOLKS HAVE FUN. Helen and Larry Eisenberg.

For new and experienced leaders of teen and adult recreation programs. Stunt plans, informal fun, music and refreshment ideas, etc. \$1.00

404. HOW TO HELP PEOPLE. Rudolph M. Wittenberg.

Using mental hygiene to help people. The leader and how he affects his group, the importance of an individual's family experience, patterns of reaction peculiar to people. \$1.00

941. HOW TO PLAN AND CONDUCT WORKSHOPS AND CONFERENCES. Richard Beckard.

Tells how to increase interest, participation, relevancy to group objectives and effectiveness of planning, programming and running a workshop, meeting or conference. \$1.00

942. HOW TO USE AUDIO-VISUAL MATERIALS. John W. Bachman.

Non-technical explanations of advantages, disadvantages, proper selection and effective use of 25 different audio-visual materials. \$1.00

406. IN-SERVICE EDUCATION FOR COMMUNITY CENTER LEADERSHIP. Donald B. Dyer.

The philosophy and procedures of in-service programs. \$.85

407. IN-SERVICE TRAINING FOR PARKS AND RECREATION: Objectives and Resources. National Recreation Assn.

A booklet prepared by representatives of the American Institute of Park Executives and the National Recreation Association. \$.50

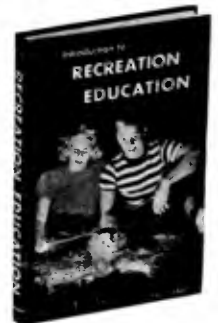

408. INTRODUCTION TO RECREATION EDUCATION. John H. Jenny.

Basic introductory discussions for beginning courses in recreation: its general principles, specific activities, industrial and hospital recreation, facilities and financing. \$4.50\*

943-945. JOBS IN CAMP AND CONFERENCE BOOKLETS. Fred D. Wentzel and Edward L. Schlingman.

Three descriptions outlining leadership requirements necessary to conduct a Christian summer camp. Compiled by the Board of Christian Education. \$.75 ea.

943. The Counselor's Job.

944. The Director's Job.

945. The Recreation Job.

409. LEADERSHIP IN RECREATION. Gerald B. Fitzgerald.

Discusses the principles, techniques and tools of effective leadership. Describes present types of professional recreation jobs; outlines methods of recreation leadership. \$4.00\*

410. LEADERSHIP OF TEEN-AGE GROUPS. Dorothy Roberts.

How to organize and be a good leader of young people's groups. Describes the teenager as he really is, what concerns and interests him. \$3.00

\* Not subject to NRA membership discount.

411. **A MANUAL OF INTER-GROUP RELATIONS.** John P. Dean and Alex Rosen.

A basic handbook giving concise, practical details essential for successful work in intergroup relations. \$3.75

946. **MENTAL HEALTH THROUGH PHYSICAL EDUCATION AND RECREATION.** Emma McCloy Layman.

A guide for recreational workers who need to understand mental hygiene principles and their application in activity programs. \$4.00\*

412. **METHODS AND MATERIALS IN PHYSICAL EDUCATION AND RECREATION.** Charles A. Bucher.

A compilation of the best methods and materials available for teaching physical education and conducting recreational programs. \$4.00\*

413. **METHODS AND MATERIALS IN RECREATION LEADERSHIP.** Maryhelen Vannier.

Help on organizing activities for people of every age and type. Discusses equipment, gives step-by-step instructions for each activity. Illustrated. 4.25\*

415. **ON CALL FOR YOUTH.** Rudolph M. Wittenberg.

A realistic approach to the average adolescent's perplexing growing pains. Will aid counselors in helping teenagers with their normal problems. Case illustrations. \$3.50

947. **PARTNERS WITH YOUTH: How Adults and Teen-agers Can Work Together.** Dorothy M. Roberts.

29 case histories of adult-teen cooperation for civic betterment on the neighborhood, community, state and national levels. \$3.50

948. **PERSONNEL STANDARDS IN COMMUNITY RECREATION LEADERSHIP.** National Recreation Assn.

Leadership positions, standards, salary recommendations prepared by National Advisory Committee on Recruitment, Training and Placement of Recreation Personnel. \$2.00

417. **PLAYGROUND LEADERS - THEIR SELECTION AND TRAINING.** National Recreation Assn.

How to select and employ playground leaders; how to prepare and conduct training courses. \$.85

949. **POCKET PRIMER OF PARLIAMENTARY PROCEDURE.** Fred G. Stevenson.

Designed for officers and members of various clubs and organizations who want a brief, non-technical, quick-reference manual on rules of order. Cl. \$2.50, pa. \$1.25

419. **RECREATION AS A PROFESSION IN THE SOUTHERN REGION.** National Recreation Assn. and Southern Regional Education Board.

Report of a 2-year study of recreation leadership and training needs in 14 southern states. \$3.75

421. **RECREATION LEADER'S HANDBOOK.** Richard Kraus.

For use with groups of various sizes and different ages. Discusses objectives of leadership and covers many activities—games, dances, dramatics, singing programs. \$5.75

422. **RECREATION LEADERSHIP.** H. Dan Corbin.

History of the recreation movement, psychological basis for leadership activities, complete discussion of problems facing the profession. Section on delinquency. \$5.50\*

950. **RECREATION LEADERSHIP.** W. C. Sutherland.

An accurate handbook of qualifications, opportunities, salaries, etc. for careers in the field of recreation. \$1.00

423. **SO YOU WANT TO HELP PEOPLE.** Rudolph M. Wittenberg.

A mental hygiene primer in everyday language. Scientific knowledge translated into usable material for anyone who works with people. \$3.00

424. **SOCIAL GROUP WORK PRACTICE.** Gertrude Wilson and Gladys Ryland.

Stimulating book to help the group worker develop attitudes and understanding for skillful leadership in any group situation. \$5.75\*

427. **TRAINING VOLUNTEERS FOR RECREATION SERVICE.** National Recreation Assn.

Outlines for training workers in arts and crafts, social recreation, day camping and other activities. \$.50

428. **UNDERSTANDING BOYS.** Clarence G. Moser.

A veteran YMCA leader gives practical information on the physical, mental, social and emotional development of boys at every stage of growth. \$2.50

951. **UNDERSTANDING GIRLS.** Clarence G. Moser.

A guidebook for parents, teachers and group leaders of girls from 6 through 17 who need help in meeting the normal problems of growing up. \$3.50

## Music

See also *Camping, Dancing, Drama, Games & Puzzles*

952. **ADVENTURES IN SINGING.** Leavitt, et al.

A collection of familiar songs in unison and two-parts for ages 10 and up. Cowboy, spirituals, patriotic songs. Easy piano accompaniments. Pa. \$1.50, cl. \$2.25



430. **AUTOHARP ACCOMPANIMENTS TO OLD FAVORITE SONGS.** Fox.

Collection of old favorite songs with notations for accompaniment on the autoharp. \$1.50

953. **A AMERICAN FOLK SONGS FOR CHRISTMAS.** Ruth Crawford Seeger, Ed.

Words and music to folk songs about the Yuletide season in simple arrangements to sing and play. \$3.00

954. **A BOOK OF NEGRO SONGS.** Janet E. Tobitt.

A compilation of Negro spirituals and folk songs with notes on their origin and presentation. Words and music for individual and choral arrangements. \$.60\*

432. **CHILD LIFE IN MUSIC.** Arnold.

Collection of plays, marches, skips, dances, toy games, prayer and quiet music for kindergarten, primary grades and the home. \$2.50

433. **THE CHILD'S UNFOLDMENT THROUGH MUSIC.** Ida C. Knapp.

Teaching methods and materials for use with pre-school children, covering singing, rhythmic, dancing, speech orchestras, the toy orchestra, and other topics. \$1.00

434. **COMMUNITY AND ASSEMBLY SINGING.** Augustus D. Zanzig.

A 64-page guide for those who conduct community singing. \$.75

436. **DISCOVERING MUSIC.** Wadley-Allison.

Rhythm games, tone games, pitch games, piano games, etc. for the child from 3 to 6. \$1.50\*

955. **THE DITTY BAG.** Janet E. Tobitt.

A compilation of 177 songs from thirty countries. Contains words and music and also some hints for song leaders. \$1.00\*

437. **FAVORITE AMERICAN SONGS.** Margaret Bradford Boni.

Selection of the most popular songs from the de luxe Fireside Book of American Songs, illustrated in color by Aurelius Battaglia. Piano arrangements by Norman Lloyd. pa. \$1.50

438. **FIRESIDE BOOK OF FOLK SONGS.** Margaret B. Boni, Ed.

Words and music for 147 folk songs, ballads, carols, love songs, sea songs, arranged for piano and voice by Norman Lloyd. Illustrated in color. \$5.00



956. **FOR YOU.** Elizabeth Crowninshield.

A book of stories, songs, rhythm, and dramatization for kindergarten and the lower grades, as well as the home. Colored board cover with jacket. \$3.00\*

440. **FOLLOW THE MUSIC.** Lottie Elsworth Coit and Ruth Bampton.

A collection of musical games and acting-out songs for children of kindergarten and primary ages. Illustrated in color. \$2.00

441. **FORTY APPROACHES TO INFORMAL SINGING.** Seibolt H. Frieswyck.

Helpful suggestions for informal group singing. \$.60

442. **FUN FOR EVERYDAY.** Bobby and Kathleen Wrenn.

Collection of 24 appealing little tunes for children about the fireman, the milkman, the balloon man, etc. \$.60

**Music (Cont.)**

957. **THE GOLDEN SONG BOOK.** Katharine Tyler Westsells.

60 well-loved childhood songs include rounds, nursery songs, lullabies, hymns and carols, all attractively illustrated by Gertrude Elliott. Goldenkraft \$1.89\*

958. **HOW TO HELP CHILDREN LEARN MUSIC.** Madeleine Carabo-Cone and Beatrice Royt.

A fresh, workable method of teaching the fundamentals of music to children by means of games. \$3.50

445. **HOW TO LEAD GROUP SINGING.** Helen and Larry Eisenberg.

Planning for group singing, selection of music, teaching the song, how to accompany, special attention to folk songs, acting-out songs, etc. \$1.00

959. **HOW TO MAKE MUSIC ON THE HARMONICA.** P. V. Planta.

Types of harmonicas, how to read music, elementary harmony, special effects. \$.95

446. **LAND OF PRETEND.** Johnson.

For the primary ages, easy musical plays and games, with patterns for paper costumes and properties. Illustrated. \$1.00

447. **LEARN TO READ MUSIC.** Howard Shanet.

A key to the language of music: staves, clefs, notes, expression marks. Clear, easy exercises to enable anyone to read a simple melody and pick it out on the piano. \$2.95

960-961. **LET'S READ MUSIC SERIES.** Laura Bryant and Katherine Knapp.

Textbooks for children in the primary grades who are learning to read music. Music for songs with simple vocabulary. \$.50 ea.

960. Let's Read Music. Grade 2.

961. Let's Read More Music. Grade 3 and 4.

448. **MERRY MUSIC MAKERS.** Elizabeth Sherman.

An introduction, for kindergarten through grade 4 age groups, to various musical instruments. Many sketches, 12 full-color pictures. \$2.30

449. **MOTHER GOOSE SONGS AND OLD RHYMES.** Ethel Crowninshield.

A collection of the original nursery rhymes and melodies for nursery school and kindergarten. \$2.00

450. **MUCH ADO ABOUT MUSIC.** Kathleen Lowance.

A story about people and music slanted toward the teen-ager and expressed in his idiom. \$3.95

452. **MUSIC IS MOTION.** Edna C. Buttolph.

Rhythms, games and songs used to create free expression in bodily movement. Includes folk music, music of the great composers, etc. \$1.00

453. **THE NEW SONG FEST.** Dick and Beth Best.

The International Outing Club Assn.'s collection of words and music for 300 songs: folk songs, work songs, college songs, drinking songs, chanties, rounds, etc. Illustrated. clo. \$2.75; pa. \$1.95

454. **NEW SONGS AND GAMES.** Ethel Crowninshield.

Simple songs for tone-matching, for the beginnings of rhythm. New games for nursery school, kindergarten and playgrounds. Boards. \$1.50\*

455. **THE OBSERVER'S BOOK OF MUSIC.** Freda Dinn.

Pocket-size guide to the world of music. Information on instruments, musical terms, composers, etc. Over 200 illustrations, some in color. Fully indexed. \$1.25

456. **PIANO TECHNIQUE.** Sidney Harrison.

Practical book for music students, special reference to scales, arpeggios, phrasing, relaxation, cure of nervousness, etc. With supplementary musical illustrations. \$3.50

962. **PLAY AND SING BOOK.** Slind.

A booklet of easy songs with descants and simple accompaniments to play as desired on the autoharp, tonette, bells, drum or piano. Intermediate grades. \$1.00

457. **THE PLAY PARTY BOOK.** Ed Durlacher.

Includes 37 singing games most popular throughout the country, intended for nursery and kindergarten ages. Musical arrangements, illustrations and directions. \$3.00

963. **PLAYTIME WITH MUSIC.** Marion Abeson and Charity Bailey.

This book has songs which stimulate the kind of dramatic activities of children which lend themselves to creative and imaginative play. Age 3 and up. \$2.75

964. **RHYTHM AND RHYME 'ROUND THE YEAR.** Evelyn Van Sicle Schelhas.

How children can develop imagination, awareness and expression through interpretive actions, singing and responding to rhythms of nature, poetry and music. \$2.50\*

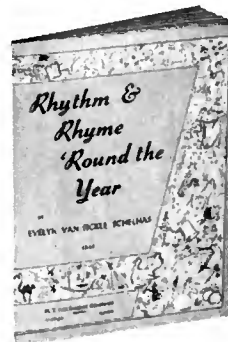

965. **ROMP IN RHYTHM.** Seatter, Minnis and Wallace.

Interpretative stories and original piano pieces to familiarize children with the simple rhythms. For kindergarten and the primary grades. \$2.00

460. **ROUND AND ROUND AND ROUND THEY GO.** Daniel.

A collection of 99 rounds, with words and music, including some old favorites and some new ones. Illustrated. \$1.00

463. **THE SING AND PLAY BOOK.** Ethel Crowninshield.

Selection of songs with easy accompaniments for use in nursery schools and kindergartens. All the songs lend themselves to creative rhythm and dramatic play. \$1.50\*

966. **SING AND PLAY TOGETHER.** Louise and Betty Dawson.

Very easy children's songs for voices, piano 4 hands, three violins, tonettes (or flutes), bells and rhythm instruments. \$1.25

465. **SINGING AMERICA.** Augustus D. Zanzig.

A song and chorus book featuring music of South America, Canada, Central America and the U.S., music of the great composers, folk songs, etc. for group singing. Vocal ed. \$.60; piano accompaniment ed., \$2.50

466. **SINGING GAMES.** Alice Hamlin and Margaret Guessford.

A collection of old favorite singing games with piano accompaniments. For children of nursery school through grade 3, for home, school or playground. \$2.00

967. **SINGING GAMES AND DANCES.** David S. McIntosh.

Words and music for over 50 folk games and dances. A classified index with suggested age brackets for each activity. \$3.00

467. **SONGS AND STORIES ABOUT ANIMALS.** Ethel Crowninshield.

Rhythmic music, with stories that may be dramatized and easily retold by the child. Illustrated by children. Boards. \$3.00\*

469. **SONGS FOR LITTLE CHILDREN.** Gaynor.

Original one-stanza songs. Tuneful and easy for the child to remember. The texts are of great variety. \$1.50

470. **SONGS FOR THE NURSERY SCHOOL.** Laura Pendleton MacCarteney.

For children through age six, 159 songs with activities. Tone games, finger plays, songs about animals, the seasons, nursery rhymes, etc. \$2.50

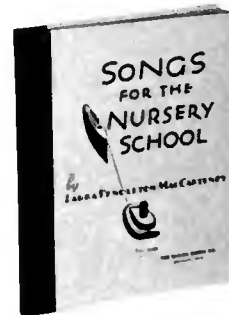

471. **SONGS FOR THE SEASONS.** Stephens Porter.

A supplementary rote-song book — tuneful pictures, especially for the early grades. \$.75

472. **STARTING AND DEVELOPING A RHYTHM BAND.** Augustus D. Zanzig.

Discussion of materials and methods for a rhythm band, plus sources for music and instruments. \$.50

474. **STORIES THAT SING.** Ethel Crowninshield.

Short stories and sentence songs for small children. Helpful for children with speech difficulties. Each story illustrated by the children in the author's school. \$2.50\*

968. **STUDIES IN BASIC RHYTHMS FOR YOUNG CHILDREN.** Lillian Brown.

A song and activity book for the kindergarten and pre-school teacher with simple piano parts. \$1.50

476. **TWENTY LITTLE SONGS.** Carter.

Tuneful melodies with simple words for young children from age 4 to 7, with a number of suggested activities to accompany the songs. \$.75

\* Not subject to NRA membership discount.

477. TWICE 55 GAMES WITH MUSIC — THE RED BOOK. Dykema.

A collection of games with music, including all directions. \$.50; piano accompaniment edition. \$1.00

478. WALK THE WORLD TOGETHER. Ethel Crowninshield.

A book of forty songs on many subjects. Recommended for kindergarten, lower grades and church schools. Boards. \$2.50°

480. ZOO SONGS TO PLAY AND TO SING. Farrell and Ward.

Amusing, simple tunes for children about the animals in the zoo. Full page illustrations of the animals that can be colored. \$.50°

## Nature

See also *Arts & Crafts, Camping, Hobbies*

969-973. THE ADVENTURE BOOKS.

A series of books designed to help beginners learn about, identify and collect samples from nature. Illustrated. \$2.95 ea.

- 969. Birds. William A. Jerr.
- 970. Insects. Alice Gray.
- 971. Rocks. Eva Knox Evans.
- 972. Shells. Eva Knox Evans.
- 973. Trees. Charlotte Howard and Helen Ludwig.

481. ADVENTURING IN NATURE. Betty Price.

A 95-page booklet of ideas for nature activities for all seasons of the year. \$1.25

482. THE AMATEUR NATURALIST'S HANDBOOK. Vinson Brown.

A pocket-size manual with 204 illustrations. Excellent for camping and hiking. \$3.50

484. THE BIRD BOOK. Leon Augustus Hausman.

Illustrations of 362 birds, complete description, habits, habitat. A bird-watcher's manual. \$2.00

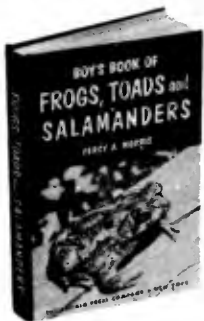

974. BOY'S BOOK OF FROGS, TOADS AND SALAMANDERS. Percy A. Morris.

A slightly technical handbook for boys who like to collect amphibians in streams and ponds. Ages 10 to 16. \$3.50

486. THE BOY SCIENTIST. Eds. of Popular Mechanics.

An introduction for boys to the world of light, sound, atomic energy, chemistry, electricity, space, time, motion, gravity, astronomy, all clearly explained. \$3.95

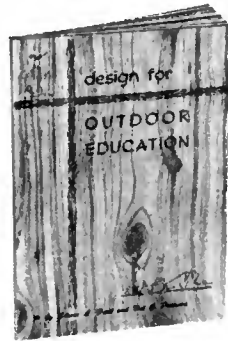

975. DESIGN FOR OUTDOOR EDUCATION. Edwin L. Friet and Del G. Peterson.

A manual for teachers and administrators who wish to establish a program of school camping and organized nature study. \$1.50

976. DISCOVERING NATURE THE YEAR ROUND. Anne Marie Jauss.

Accurate information and illustrations by the author of wildlife observable in each of the four seasons. Age 10 up. \$2.50

977. FIELD BOOK OF NATURE ACTIVITIES. William Hillcourt.

A broad outline of all the possible activities in the field of nature study, and a wealth of ideas for every conceivable nature hobby. Illustrated. \$3.95

978. FIELD GUIDE FOR BIRDS, WILD FLOWERS AND NATURE STUDY. Leon A. Hausman.

Identifies 400 birds, flowers, trees, fishes, mammals, insects, plants, rocks and minerals, clouds, stars. Reference index. \$1.00

490. A FIELD GUIDE TO THE BIRDS. Roger Tory Peterson.

A new kind of bird guide, a streamlined volume emphasizing the characteristics of birds when seen at a distance, making quick, accurate identification possible in the field. \$3.95

979. THE FIRST BOOK OF CONSERVATION. F. C. Smith.

An account of how rivers, forests, wildlife and the earth depend on nature's interrelationships. How man damages and restores his natural resources. \$1.95

980. THE FIRST BOOK OF SURPRISING FACTS. Frances N. Chrystie.

Surprising facts about the world we live in; nature, people, customs. Large type and fully illustrated. \$1.95

981. THE FIRST BOOK OF WEATHER. Rose Wyler.

Simple and lively explanations of weather phenomena. Easy experiments and directions for reading and making weather maps and instruments. \$1.95

THE GOLDEN NATURE GUIDES.

Excellent nature guides, each written by experts in the field and edited by Herbert S. Zim. Each book illustrated with 115 to 150 handsome color pictures accurate in every detail. cl. \$2.50 ea., pa. \$1.00 ea.

- 494. Birds. Ira N. Gabrielson.
- 495. Flowers. Alexander C. Martin.
- 496. Insects. Clarence Cottam.
- 497. Trees. Alexander C. Martin.
- 498. Stars. Robert H. Baker.
- 499. Mammals. Donald F. Hoffmeister.
- 500. Seashores. Lester Ingle.
- 501. Reptiles and Amphibians. Hobart M. Smith.
- 502. The American Southwest. Natt N. Dodge.
- 982. Fishes. Hurst H. Shoemaker.
- 983. Weather. Lehr and Burnett.

984. HAMMOND'S NATURE ATLAS OF AMERICA. E. L. Jordan.

A comprehensive reference book of the rocks, trees, wildflowers, birds, mammals, reptiles, fishes and insects prevalent in North America. 320 illustrated species. \$7.50

985. HANDBOOK OF ATTRACTING BIRDS. Thomas P. McElroy, Jr.

A complete guide on attracting, nesting, feeding and caring for birds found all over the United States. \$3.00

505. HOW TO MAKE A HOME NATURE MUSEUM. Vinson Brown.

Directions for classifying, mounting, labeling and displaying collections to make your own museum. \$2.75

986. HUNTING WITH THE MICROSCOPE. Johnson and Bleifeld.

Beginner's guide to exploring the world of microscopic plant and animals. Includes gathering specimens, preparing cultures and slides. 8 pages of photomicrographs. \$.95

510. AN INTRODUCTION TO NATURE. John Kieran.

Kieran's three great introductions in one sumptuous volume, with accurate, full-color paintings of wildflowers, birds and trees. Informal, but scholarly discussions of nature. \$6.00

987. THE JUNIOR BOOK OF INSECTS. Edwin Way Teale.

A complete, up-dated edition of the art of identifying and studying insects. With photographs and drawings. \$3.75

511. THE MACMILLAN WILDFLOWER BOOK. Clarence Hylander and Edith Johnston.

Over 200 original paintings of wildflowers, showing their colors, pattern and texture. Brief and informative text. Covers over 500 plants. \$8.95

988. NATURE IS YOUR GUIDE—How To Find Your Way Without Map or Compass on Land and Sea. Harold Gatty.

The art of pathfinding by natural methods. Color and monochrome plates, line drawings, diagrams and maps. \$4.95

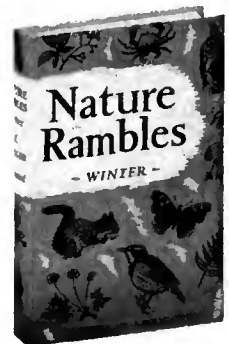

512. NATURE RAMBLES. Oliver Perry Medsger.

A series of four volumes on nature, in woods, ponds, streams, and fields, especially for boys and girls. Each volume covers a season of the year. ea. \$1.50; boxed set \$6.00

513. NATURE WAS FIRST! Walter C. Fabell.

An amusing and informative book for young children, showing how Nature got ahead of man in inventing. \$2.75

514. NORTH AMERICAN TREES. Richard J. Preston, Jr.

Complete, easily used field manual. Concise, accurate descriptions of some 568 species with 160 full-page drawings, clarifying maps and a comprehensive glossary. \$3.75

**Nature (Cont.)**

989. **THE OUTDOOR ENCYCLOPEDIA.** Ted Kesting, Ed.

A complete guide to outdoor living and recreation, designed not only for the sportsman but for the whole family. Illustrated by William N. Ronin. \$7.50

990. **PALMER'S FIELDBOOK OF MAMMALS.** Laurence Palmer.

A concise, pocket-size fieldbook of mammals of America and the world. 320 pages illustrated with pictures and nature diagrams. \$3.75

516. **THE POND BOOK.** Albro Gaul.

Nature study for boys and girls aged 7 to 11. The formation and value of ponds and the story of the creatures who live in and visit them in each of the four seasons. Illustrated with photographs. \$2.75

522. **THE TRUE BOOK OF BIRDS WE KNOW.** Margaret Friskey.

For children through fourth grade level. Helps the child identify particular birds and stimulates interest in bird lore. Color by Anna Pistorius. \$2.00

524. **THE TRUE BOOK OF INSECTS.** Illa Podendorf.

For children through fourth grade age level, descriptions and colorful illustrations of the familiar, and some unfamiliar insects. \$2.00

525. **THE TRUE BOOK OF PEBBLES AND SHELLS.** Illa Podendorf.

For children up to grade 5, pictures and descriptions of shells and pebbles found along the shore. Illustrations by Mary Gehr. \$2.00

526. **THE TRUE BOOK OF TREES.** Illa Podendorf.

Beautiful full color pictures by Richard Gates supplement text of this nature book for small children through fourth grade level. \$2.00

527. **THE TRUE BOOK OF WEEDS AND WILDFLOWERS.** Illa Podendorf.

Full color pictures and descriptions of weeds and flowers of roadside, garden, fields and woods. For small children through age 10. \$2.00

528. **UNDERSTANDING THE WEATHER.** T. Morris Longstreth.

Shows the amateur how to become an accurate weather forecaster by learning how atmospheric changes produce good or bad weather. Illustrated. \$2.50

529. **WALT DISNEY'S THE LIVING DESERT.** Jane Werner.

Based on the film, a complete factual account of plant and animal life in the desert. Illustrated with kodachromes and drawings. \$3.50; (Goldencraft \$3.59<sup>o</sup>)

530. **WALT DISNEY'S THE VANISHING PRAIRIE.** Jane Werner.

A documentary account, based on the film, of America's Great Plains. Illustrated with color photographs and drawings. \$3.50; (Goldencraft \$3.59<sup>o</sup>)

992. **WHO LIVES THERE?** Carroll Colby.

A guide to the nests, dens, burrows and "homes" of birds, insects and other wildlife. \$1.00

993. **WHO WENT THERE?** Carroll Colby.

A handbook of the tracks and trails of mammals, birds and reptiles arranged by city, woods and fields, and forests. \$1.00

**ASTRONOMY**

994. **ASTRONOMY HANDBOOK.** Leon A. Hausman.

Descriptions of the universe, the Zodiac, the Milky Way, the positions of celestial bodies from January to December. Includes a cut-out star-finder slide rule for studying night skies. \$2.00

995. **BEGINNER'S GUIDE TO THE STARS.** Kelvin McKready.

A guide to help beginners in their earliest steps toward recognizing the stars and planets. Illustrated. \$2.00

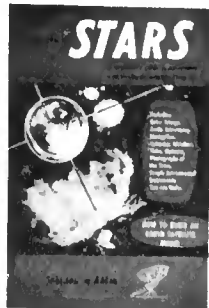

996. **DISCOVER THE STARS.** Johnson and Adler.

An enjoyable way to learn about astronomical phenomenon. How to make simple instruments, find latitude and longitude. \$1.95

997. **THE GOLDEN BOOK OF ASTRONOMY.** Rose Wyler and Gerald Ames.

Clear explanations about gravity, the seasons, the beginnings of our solar system, the tools of astronomy, the possibilities of space travel. Goldencraft \$3.99<sup>o</sup>

998. **HOW TO MAKE AND USE A TELESCOPE.** H. Percy Wilkins and Patrick Moore.

The step-by-step process of building a telescope in your home workshop. Hints on telescope photography for the beginner. \$3.95

521. **THE STARS.** H. A. Rey.

A new, practical method of star recognition, presenting the constellations in forms that correspond to their names. Series of star charts for any date and hour of the night, table giving position of the planets, etc. \$5.00

**GARDENING**

999. **BACKGROUND TO GARDENING.** W. O. James.

The whys and wherefores of gardening for the curious gardener, professional or amateur, who wants to know the reasons behind plant behavior. \$4.50

1000. **THE FIRST BOOK OF GARDENING.** Virginia Kirkus.

What to do, and how to do it for best results; tools, preparing the soil, choosing seeds, planting, setting out plants and seasonal care of a garden. \$1.95



1001. **FUN-TIME WINDOW GARDEN.** Emogene Cooke.

The magic of growing things is unfolded in this book, illustrated in two colors by the author. \$2.50

1002. **A LEADER'S GUIDE TO NATURE AND GARDEN FUN.** Ernestine S. Coffey and Dorothy F. Minton.

Tells how to teach horticulture, conservation, flower arranging, bird and insect lore, etc. \$2.75

1003. **THE OBSERVER'S BOOK OF GARDEN FLOWERS.** Arthuir King.

200 of the more popular annuals, biennials, and perennials. Notes on planting, cultivation and propagation. \$1.25

1004. **WINDOW BOX GARDENING.** Ruth Teuscher.

Plant combinations, soils, fertilizers, watering methods, and complete directions for plants grown in boxes. \$3.95

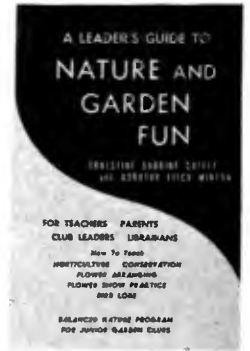

1005. **YOUR OWN BOOK OF NATURE AND GARDEN FUN.** Ernestine S. Coffey and Dorothy F. Minton.

Fully illustrated, easy-to-follow directions for planting a garden, collecting and identifying leaves, making decorations. \$1.75

**Organization & Administration**

See also *Camping, Community Recreation, Leadership*

536. **ADMINISTRATION OF SCHOOL HEALTH AND PHYSICAL EDUCATION PROGRAMS.** Charles A. Bucher.

Concerned with administration as related to school programs of health and physical education, with implications for recreation. \$5.50<sup>o</sup>

537. **COMMUNITY ORGANIZATION AND AGENCY RESPONSIBILITY.** Ray Johns and David F. DeMarche.

A comprehensive picture of the field — the processes, problems and future of community organization for social welfare. \$3.75<sup>o</sup>

538. **COMMUNITY SPORTS AND ATHLETICS — ORGANIZATION, ADMINISTRATION, PROGRAM.** National Recreation Assn.

Deals with the problems involved in organizing and conducting a sports program for the whole community. \$5.00

539. **CONDUCT OF PLAY-GROUNDS.** National Recreation Assn.

Leadership, activities, program planning, administration, equipment and supplies. \$7.75

\* Not subject to NRA membership discount.



**540. CONDUCT OF SCHOOL COMMUNITY CENTERS.** National Recreation Assn.

Discussion of administration, finance, personnel. Description of 17 developments to illustrate types of systems currently in operation. \$5.00

**1006-1008. CRITERIA FOR THE EVALUATION OF A BOYS' CLUB.**

Standards and worksheets for determining the effectiveness and efficiency of a Boys' Club in various areas of activity. \$3.00 ea.

1006. Part I—Evaluation of a Boys' Club.

1007. Part II—Program Evaluation in a Boys' Club.

1008. Part III—Camp Evaluation.

**542. DEMOCRATIC ADMINISTRATION.** Ordway Tead.

How to translate democracy as a way of life into the operational phase of administration. \$1.75°

**543. EXECUTIVE RESPONSIBILITY.** Ray Johns.

Help for executives of large and small agencies in dealing with financial problems, building maintenance, staff, board and committee relationships, decision-making, etc. \$4.00°

**544. HOW TO BE A BOARD OR COMMITTEE MEMBER.** Roy Sorenson.

Explains the functions and duties of boards, methods of their organization, roles of the chairmen and committees, and how to work together. \$1.00

**545. HOW TO RUN A CLUB.** Harry Simmons.

Practical handbook covering every phase of successful club operation. Legal and financial problems, guest speakers, publicity, program planning. With illustrations. \$3.95

**546. HOW TO WORK WITH YOUR BOARD AND COMMITTEES.** Louis H. Blumenthal.

Help in building a partnership between board and staff, working with committees and volunteers. Division of responsibility between board and staff. \$1.00

**1009. INDUSTRIAL RECREATION.** J. M. Anderson.

A guide to directors of employee recreation programs and a documented aid to the organization and administration of such programs. Illustrated. \$5.00°

**1010. INFORMATION ON PERSONNEL POLICIES AND PRACTICES FOR GROUP WORK AND RECREATION AGENCIES.** Federation of Protestant Welfare Agencies, Inc.

A guide to the development of administrative policy for employed personnel. Kit of 6 copies. \$1.50

**1011. MANUAL OF BOYS' CLUB OPERATION.**

Official manual for Boys' Clubs of America stating history, philosophies, policies, programs, methods and procedures for establishing boys' clubs. \$4.50

**205. MUNICIPAL RECREATION ADMINISTRATION.**

Prepared by experienced recreation administrators, a practical book excellent for daily reference purposes. Used as a text for correspondence training course. \$7.50°

**549. PLAYGROUNDS: Their Administration and Operation.** George D. Butler.

Every aspect of playground operation — layout, equipment, personnel, programs, outings, awards, discipline, safety, public relations, finance. \$4.75

**550. RECREATION ADMINISTRATION: A GUIDE TO ITS PRACTICES.** Harold D. Meyer and Charles K. Brightbill.

Community recreation, organization, planning, personnel, areas and facilities, programs and services, finance. \$6.75°

**1012. RECREATION IN THE AMERICAN COMMUNITY.** Howard G. Danford.

A complete coverage of the operational problems in the organization and administration of public recreation programs, including playgrounds, community centers, and municipal athletics. \$5.00°

**551. RECREATION: TEXT AND READINGS.** Charles K. Brightbill and Harold D. Meyer.

Recreation in modern living—its meaning, place, problems and scope. Information on administrative problems. \$5.00°

**1013. STATE LAWS FOR PARKS AND RECREATION.** Betty van der Smissen.

A compilation of state legislation for the establishment of Public Park and Recreation Boards. Tables show steps necessary in the creation of such Boards. \$2.00°

**Parties & Entertainment**

See also *Dancing, Drama, Holidays, Program Planning, Music*

**555. AMERICAN GIRL'S TREASURY OF SPORT, HOBBIES AND PARTIES.** Pearl and Stanley Pashko.

Thousands of exciting ideas, projects and sports for girls, indoors and out, at home, on vacation, alone or in groups. \$1.49

**1014. CHALK TALK STUNTS.** Harlan Tarbell.

Variety of material for the person who draws with chalk while talking. 55 full-page illustrations with directions. \$1.00

**559. THE COMPLETE BOOK OF PARTY GAMES.** Alexander Van Rensselaer.

A fully illustrated collection of party stunts, dramatic games, writing games, magic effects, quizzes and hundreds of other entertainment ideas. \$2.49

**561. 88 SUCCESSFUL PLAY ACTIVITIES.** National Recreation Assn.

Rules and directions for many special events including kite contests, doll shows, pushmobile contests, marble tournaments and many others. \$75

**1015. THE END OF YOUR STUNT HUNT.** Helen and Larry Eisenberg.

About 20 stunts for all ages. Valuable for all party-planners. \$5.00

**1016. EVERYBODY'S BOOK OF MAGIC.** Will Dexter.

A program of tricks to perform contributed by famous amateurs and professionals. The history of magic and the mysterious doings of the Magic Circle. \$2.50

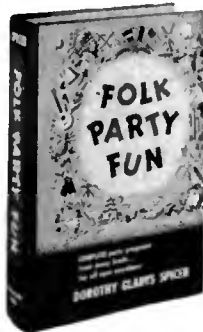

**563. FOLK PARTY FUN.** Dorothy Gladys Spicer.

Complete programs for 25 parties from 14 nations: Chinese Moon Festival, Hawaiian Beach Party, Indian Pow-Wow, etc. Everything fully planned. \$3.95

**564. FOR THE STORYTELLER.** National Recreation Assn.

How to select stories and how to tell them effectively. With a bibliography. \$85

**565-571. FUN AND FESTIVAL SERIES.**

Booklets of programs, festivals, games, songs, recipes, stories, authentic material about people around the world, how they live and play. ea. \$50

565. Fun and Festival Among America's Peoples.

566. Fun and Festival from China.

567. Fun and Festival from India, Pakistan and Ceylon.

568. Fun and Festival from Japan.

569. Fun and Festival from Southeast Asia.

570. Fun and Festival from the other Americas.

571. Fun and Festival from the U.S. and Canada.



**1017. FUN FOR PARTIES AND PROGRAMS.** Catherine Allen.

Quiet and active games, relaxers and stunts, songs and sample parties are included for anyone who wants to give a successful party. \$2.95° text ed.

**573. FUN TIME MAGIC.** Victor Havel.

Tricks that any child 7 or over can master. Provides hours of fun with easy directions and simple material readily available. \$2.80

**1018. FUN WITH CHALK TALK.** Harlan Tarbell.

29 stunts with "patter" illustrated by 60 full-page drawings. \$1.00

**1019. FUN WITH MAGIC.** Joseph Leeming.

A wide selection of stunts for the Junior High School grades. \$2.95

**574. FUN WITH SKITS, STUNTS AND STORIES.** Helen and Larry Eisenberg.

Hundreds of skits, stunts and stories, long and short, one-man entertainment plans. Emphasizes simple props, minimum preparation. \$2.95

**Parties & Entertainment  
(Cont.)**

1020. FUN WITH STUNTS. Effa E. Preston.

A collection of up-to-date stunts, skits, radio and television material, musical stunts, pantomimes to aid the program director. \$3.95

1021. GAMES AND STUNTS FOR ALL OCCASIONS. William P. Young and Horace J. Gardner.

A thoroughly practical manual for entertaining in small or large groups. Well indexed. \$2.50

575. GAMES FOR GROWN-UPS. Marguerite Kohl and Frederica Young.

All sorts of games for successful home entertainment, featuring handy charts to tell at a glance where to find the right game for the right time. \$2.50

576. GAMES FOR PARTIES. Kate Stevens.

Full descriptions and rules for new party games. Also includes many old favorites and variations on them. \$1.25

1022. A GRAB BAG OF FUN. Gertrude Crampton.

Stories, games, puzzles and things-to-do for rainy-day, indoor entertainment for boys and girls. \$2.50

578. HANDBOOK OF INDOOR GAMES AND STUNTS. Darwin A. Hindman.

Wide collection of non-athletic games, contests and stunts suitable for all ages. Classified according to their main principles. Illustrated. \$5.00\*

1023. HOW TO BE A SUCCESSFUL EMCEE. LeRoy Stahl.

How to plan a program, use a microphone, introduce speakers, announce sports, tell humorous stories effectively and handle round-table discussions efficiently. \$2.75

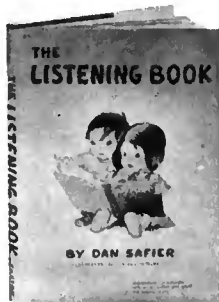

582. THE LISTENING BOOK. Daniel Edwin Safier.

For the story hour, for children from 3 to 8 years. Rhythm and sound used in quite a new way. Many illustrations. \$4.00

583. LITTLE GAMES AND PARTIES. Margaret Powers.

Expressly for children under the reading age. Complete directions, in pictorial form, for hundreds of little games for every occasion and for any number of children. \$2.50

584. LOOK, A PARADE. National Recreation Assn.

Directions for organizing a parade and how to make decorations for it. \$.50

585. MAGIC. Alexander Van Rensselaer.

A Knopf Junior Activity Book for 7 to 11-year-olds with 25 easy tricks for the youngest reader to perform. Illustrated with drawings. \$1.50

586. MAGIC FOR BOYS. G. Sherman Ripley.

A magic manual especially for teen-age boys and adults who lead and entertain them. Illustrations, easy-to-follow text, low-cost equipment. \$3.00

588. MANNERS CAN BE FUN. Munro Leaf.

A book of manners for children. Amusing illustrations in the author's well-known style will amuse the children while teaching them the essentials of good manners. \$2.25

1024. THE MASTER STUNT BOOK. Lawrence M. Brings.

A collection of stunts, pantomimes, skits and games selected to meet the requirements of clubs, schools, churches and youth groups. \$3.95

1025. MORE FUN WITH MAGIC. Joseph Leeming.

Simple, easy-to-follow directions and diagrams for magic stunts make this book entertaining and fun for all the family. \$2.95

589. OMNIBUS OF FUN. Helen and Larry Eisenberg.

Activities for every age — stunts, games, skits, quizzes, songs, party and banquet tips, holiday celebrations. Everything indexed. \$7.95

591. 100 HOUDINI TRICKS YOU CAN DO. Dunninger.

The famous Dunninger explains 100 magic tricks. \$2.00

593-594. PARTIES PLUS SERIES. Ethel Bowers, Ed.

How to plan successful parties, old and new ideas.  
593. Parties, Plus: Let's Plan a Party. \$.50  
594. Parties Plus: Stunts and Entertainments. \$.75

595-598. THE PARTY BOOK-LETS. Ethel Bowers, Ed.

Guides for planning all kinds of parties for any occasion. Details of planning and programming.

595. Parties—A to Z. \$.75

596. Parties—Plans and Programs. \$.70

597. Parties for Special Days of the Year \$.75

598. Parties—Musical Mixers and Simple Square Dances. \$.50

604. SCARNE'S MAGIC TRICKS: 200 Best Tricks That Anyone Can Do. John Scarne.

A book of magic without sleight-of-hand. Includes directions for 200 tricks anyone can perform, with 150 helpful illustrations. \$2.95

605. THE SEVENTEEN PARTY BOOK. Enid Haupt, Ed.

For teen-agers, detailed plans for showers, high school proms, birthday parties, box parties, and others. Decorations, menus, recipes, games. Illustrated. \$2.75



1026. SKIT HITS. Helen and Larry Eisenberg.

About 50 skits and stunts anyone can do. Step-by-step directions. \$.75

606. 72 SURE FIRE WAYS OF HAVING FUN: The Life of the Party. Menaker and Folsom.

Lively, stimulating games for a successful party. Twenty amusing illustrations. \$.75

609. TALES FOR TELLING. Katherine Williams Watson.

Timed stories adapted from old favorites and arranged under the following classifications: Christmas, Easter, fairy and folk tales, farm, Hallowe'en, humor, Indian, myths and legends, Thanksgiving. \$2.75\*

610. TEACH YOURSELF MAGIC. J. Elsdon Tuffs.

Many excellent illustrations and detailed instructions for card tricks, coin tricks, disappearing tricks, etc. Also tips on audience misdirection and use of assistants. \$2.50

**Pets**

1027. HOME AQUARIUM HANDBOOK.

Scores of fish illustrated and described with instructions for care and feeding and maintaining a balanced aquarium. What to do with sick fish and incompatible breeds. \$2.00

613. HOME-MADE ZOO Sylvia S. Greenberg and Edith L. Raskin.

Practical suggestions for the care of small pets. Illustrated with diagrams. \$3.50

614. THE HORSE. D. J. Kays.

Every major phase of horse care and handling presented in thoughtful detail. With illustrations. \$7.50

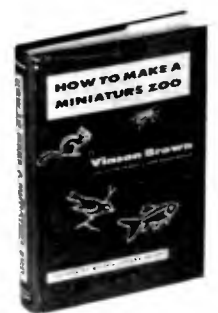

1028. HOW TO MAKE A MINIATURE ZOO. Vinson Brown.

An aid to individuals, schools and group leaders interested in the care and collection of small mammals, insects, amphibians, reptiles and keepable birds. Ages 10 and up. \$2.75

616. HOW TO TRAIN DOGS: For the Home, Stage and Motion Pictures. Henry R. East.

Covers complete training of a dog, to sit, lie, crawl, roll over, and many other tricks, each carefully explained and illustrated. \$2.50

617. OBEDIENCE FOR DOG AND MASTER. Harriet Schacht.

An outstanding authority on obedience training tells how to train your dog and how to train yourself. For the average dog owner or for training course specialists. \$3.50

618. TROPICAL AQUARIUMS, PLANTS AND FISHES. A. Laurence Wells.

How to set up, heat and maintain an aquarium, what plants to use. Tips on feeding, tending and breeding tropical fish. Drawings and color plates. \$2.50

1029. YOU TRAIN YOUR DOG. Frederick Reiter.

Sure and simple training methods to make a dog a well-behaved pet. \$4.00

\* Not subject to NRA membership discount.

## Philosophy of Recreation

619. DESIGNING EDUCATION IN VALUES. Roy Sorenson and Hedley S. Dimock.

How a large social agency modernized its methods. Shows how to develop and train leaders, interpret to boards and committees. \$5.75\*

1030. GROWING THROUGH PLAY. Ruth E. Hartley.

A case history illustrating an attempt to understand and interpret children's play in relationship to their reactions in other living problems. \$.75\*

621. LEISURE AND RECREATION—A Study of Leisure and Recreation in Their Sociological Aspects. Martin H. and Esther S. Neumeyer.

Informative treatment of the place of leisure and recreation in modern society. Emphasis on group aspects of recreation. \$4.50\*

1031. MOBILIZING COMMUNITY RESOURCES FOR YOUTH. Paul Bowman, etc.

Report on first half of a 10-year project studying and aiding maladjusted and talented children in a selected city of 50,000 population. \$3.50\*

1032. A NEW HORIZON OF RECREATION. Charles J. Vettiner.

Explains new and practical methods for organization and administration of recreation programs in small communities and counties. \$3.95

622. PHILOSOPHY OF RECREATION AND LEISURE. Jay B. Nash.

A study of what adolescents and adults do with their leisure time. \$2.50\*

623. PRINCIPLES OF RECREATION. John L. Hutchinson.

Full discussion of the recreation profession and the responsibilities and functions involved. Basic principles of leadership, administration, programming and evaluation. \$3.75\*

624. PROCEEDINGS, INTERNATIONAL RECREATION CONGRESS, 1958. National Recreation Assn.

Major addresses, summaries of discussion meetings and demonstrations. \$3.00

1033. RESEARCH IN RECREATION COMPLETED IN 1956. National Recreation Assn.

A listing of research projects in recreation. Copies of 1953-1954 report and 1955 report available at \$1.00 ea. or \$1.50 together.

628. A TREASURY OF LIVING. Howard Braucher.

Selections from the writings of the late president of the National Recreation Assn. Paper Ed. \$1.50; (limited Memorial Ed. \$10.00)

1035. UNDERSTANDING CHILDREN'S PLAY. Ruth Hartley, Lawrence Frank and Robert Goldenson.

Numerous case histories and psychologists' conclusions of interest to all parents, social workers, teachers and others who deal with children. \$3.50\*

## Photography

630. THE FIRST BOOK OF PHOTOGRAPHY. John Hoke.

How to take good pictures using basic inexpensive equipment. Suggestions for planning picture story records of vacation trips, holiday celebrations, etc. Photographs and drawings. \$1.95

631. FLASH PHOTOGRAPHY. Gordon Parks.

A simplified guide to better flash pictures. Techniques for natural lighting effects, single and multiple flash, charts, equipment. Over 100 illustrations. Paper bound. \$1.00

632. HOW TO DEVELOP, PRINT, AND ENLARGE PICTURES. Samuel Epstein and David W. DeArmand.

An easy, complete guide to equipment needed and how it can be made. How to make contact prints and enlargements. \$1.00

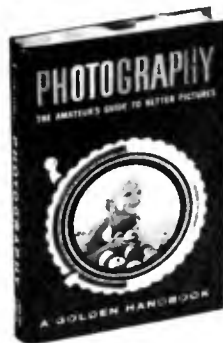

634. PHOTOGRAPHY. William P. Gottlieb.

A Knopf Junior Activity Book for 7 to 11-year-olds showing how to take good pictures with simple equipment. Illustrated with photographs and drawings. \$1.50

635. PHOTOGRAPHY: The Amateur's Guide to Better Pictures. Herbert S. Zim and R. Will Burnett.

Covers composition, lighting, focusing, film, color prints, various cameras, developing and enlarging. Illustrated with 392 photographs and diagrams. clo. \$2.50; pa. \$1.00.

636. PHOTOGRAPHY FOR FUN AND PROFIT.

A complete book for amateurs and professionals. Illustrated. \$2.50

637. PHOTOGRAPHY HANDBOOK.

Dozens of how-to articles by well-known photographers, plus a big portrait section. \$2.00

1036. PRACTICAL PHOTOGRAPHY. Robert A. McCoy.

A non-technical, illustrated guide for amateurs including 20 laboratory exercises for teaching or practicing the fundamentals of photography. \$4.00

638. SECRETS OF TAKING GOOD PICTURES. Aaron Knopf.

A clear, simple book on taking good snapshots. Choice of camera and film, avoiding mistakes, use of filters, etc. Over 250 examples illustrated. \$2.00

639. THIS IS PHOTOGRAPHY: Its Means and Ends. Thomas H. Miller and Wyatt Brummitt.

Complete, easily understood guide to every kind of photography, prepared by Eastman experts. Everything from choice of camera to color pictures. \$2.75

## Program Planning

See also Arts & Crafts, Camping, Drama, Parties & Entertainment.

1037. ALL ABOUT US. Eva Knox Evans.

The story of people and their backgrounds; why they are different and why they are alike. For children and adults. Illustrated. \$2.50

1038. DESIGN FOR JUVENILE DECENCY. Howard Gibbs and Alex Maleski.

Ten programs for boys' clubs aimed toward preventing and reducing delinquency by substituting juvenile decency. \$1.50

991. PEOPLE ARE IMPORTANT. Eva Knox Evans.

Why all the people in the world have different racial and cultural mores. \$2.50

1039. FAVORITE STORIES OLD AND NEW. Sidonie M. Gruenberg.

A new edition enriched with 26 stories covering such up-to-date interests as space ships and Davy Crockett. Illustrations by Kurt Wiese. \$3.95

1041. GOOD THINGS FOR EVERYDAY PROGRAMS. Beatrice M. Casey.

An invaluable source of dialogues, plays, exercises and drills for all ages. \$1.00

1042. GUIDE TO AMERICAN FOLKLORE. Levette J. Davidson.

Designed for teachers and students of folklore, and valuable to collectors, hobbyists and all others interested in the traditional culture of the U. S. \$2.00

1043. HOW TO PUT ON AN AMATEUR CIRCUS. Fred Haeker and Prescott Eames.

Directions for constructing animals, acrobatic acts and clown stunts; illustrated with production drawings and photographs. \$2.50

1044. HOW TO USE A TAPE RECORDER. Dick Hodgson.

Includes information on selecting the right recorder for your needs, servicing and repairs. \$4.95

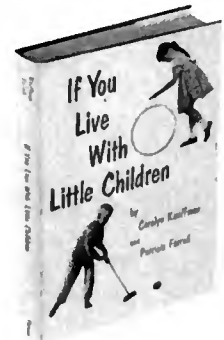

1045. IF YOU LIVE WITH LITTLE CHILDREN. Carolyn Kauffman and Patricia Farrell.

Designed to aid parents teach their children to entertain themselves, and to make life with small children fun. \$2.95

1046. McCALL'S COMPLETE BOOK OF BAZAARS. Harriet Hawes and Eleanor Edelman.

Contains every detail on organization, decorations and actual selling. \$2.95

640. OUTDOOR ACTIVITIES FOR IN-TOWN GROUPS. Chapman, Gaudette and Hammett.

For group leaders, a packet of 20 sheets of pictorial suggestions for planning outdoor activities. \$.50\*

**Program Planning (Cont.)**

6. PLANNING FOR GIRLS IN THE COMMUNITY RECREATION PROGRAM. National Recreation Assn.

Outline for a study of community resources, suggestions for activities, discussion of standards and leadership. \$6.65

1047. PLAYGROUND SUMMER NOTEBOOK. Virginia Musselman, Ed.

A collection of 12 bulletins covering all program phases of summer playgrounds. Informal, full of new ideas and suggestions. Published annually in May. \$2.50. (\$2.00 to NRA members)



641-644. PLAYGROUND SERIES. Virginia Musselman.

Leadership manuals for use in playground activities. ea. \$5.00

- 641. Informal Dramatics.
- 642. Playground Leader: His Place in the Program.
- 643. Storytelling.
- 644. Simple Puppetry.

1048. PLAY ACTIVITIES FOR BOYS AND GIRLS. Richard Kraus.

Designed to assist adults in guiding and encouraging better play activities and associations for children. \$4.95

1049. THE PROOF OF THE PUDDING — What Children Read. Phyllis Fenner.

A librarian's view of what books each age group prefers, and how children may be encouraged to read. Includes an annotated list of favorite titles. \$3.95

645. THE PROGRAM ENCYCLOPEDIA. Clement A. Duran.

More than 5000 program ideas: sports, fun, arts and crafts, hobbies, religion, world affairs, cultural activities, money raising projects, etc. \$7.95

646. THE RECREATION PROGRAM.

Represents the findings of an experienced group of recreation leaders. Covers all major kinds and forms of recreation activity. \$3.00

8. RECREATION ACTIVITIES FOR ADULTS. National Recreation Assn.

Over 300 activities for mixed groups at home, club, church and school. Writing games, stunts, outdoor games, etc. \$3.00

1050. TAKING HOLD OF TELEVISION. Roger S. Hall.

A how-to-do-it book on television. Covers: spots, use of film, interviews, panels, dramas, news programs. Explains TV scripts, props, station operations. \$2.00\*

1051. THEY KNEW PAUL BUNYAN. E. C. Beck.

Songs, anecdotes and stories told and retold by shantyboys and riverhogs from Maine to the Great Northwest. \$4.75

1052. VAUGHN'S PARADE AND FLOAT GUIDE. L. F. Vaughn.

Instructions for building every type of float illustrated with charts and diagrams. \$5.00

1053. WHAT CAN I DO NOW? Emily R. Dow.

Suggestions for games and handwork to be used indoors, outdoors, by individuals or groups. Things to draw, think about and collect. Age 9 up. \$2.50

1054. YOUR CHILD'S LEISURE TIME. Mildred Celia Letton.

Presents a balanced program of reading, hobbies, group experiences, both work and recreational, for children from 4 to 16. \$6.00\*

**Puppets**

74. FUN-TIME PUPPETS. Carrie Rasmussen and Caroline Storck.

Simple graphic directions for children, 7 to 11, on how to make stick, fist and hand puppets, hinged dolls, and puppet theaters from simple materials. \$2.80

1055. FUN WITH PUPPETS. Sylvia Cassell.

How to produce a puppet play and how to make them from household articles with simple directions for preparing stages, scenery and props. Regular ed. \$1.50. Leader's ed. \$2.25

1056. HAND PUPPETS AND STRING PUPPETS. Waldu S. Lanchester.

Describes the making of glove, wood and string puppets, and puppets with wire frame foundation. Suggestions for dressing marionettes, making controls and theatre. Illustrated. \$1.25

1057. PUPPETS AND PLAYS. Marjorie Batchelder and Virginia Lee Comer.

A book for novice as well as experienced puppeteers of all ages, it tells how to create, rehearse and present puppet plays. \$4.00



1058. PUPPETS GO TO SCHOOL. Helen V. Williams.

Simple, easy text describing how to make all varieties of puppets from easily obtainable materials. Suggestions for staging and actual plays are included. \$5.00

125. REMO BUFANO'S BOOK OF PUPPETRY. Arthur Richmond, Ed.

A history of puppetry. Covers both puppets and marionettes, with clear directions for making and using them, choosing and giving plays. \$3.50

**Safety**

659. ADVENTURES IN ARTIFICIAL RESPIRATION. Peter V. Karpovich.

Developed under a research grant from the U. S. Army. Details all known methods of artificial respiration. \$7.50\*

1059. HOW TO SURVIVE ON LAND AND SEA.

An illustrated manual of techniques used in the Naval Aviation Physical Training Program. \$4.00

1060. LIFE SAVING AND WATER SAFETY. American Red Cross.

This revised edition gives the Hoelger-Nielson method of resuscitation. Contains new illustrations which closely simulate actual conditions. \$7.75\*

174. OUTDOOR HAZARDS REAL AND FANCIED. A Guide to Out-of-Doors Safety for Campers, Hikers, Hunters, and Fishermen. Mary Hood.

A safety manual, pointing out the true hazards of the out-doors. \$3.95

717. YMCA WATER SAFETY AND LIFESAVING. Harold T. Friernood, Ed.

Qualifications for becoming a YMCA lifesaver, skills in lifesaving, written examination. \$5.50\*

**Sports**

**GENERAL**

661. ARCHERY HANDBOOK. Ed. H. Burke.

A complete book, heavily illustrated. Covers history, lessons, hunting, practice, cost, equipment. \$2.00

665. THE BASIC BOOK OF SPORTS. Seaton, Clayton, Leibel, and Messersmith.

Covers 28 popular sports — team sports and individual sports — practical and complete directions and up-to-date information. \$3.00\*

666. BASIC SKILLS IN SPORTS. David A. Armbruster.

To aid beginners in sports, or to improve performance of those beyond beginner stage. \$2.75\*

1061. BASKETBALL FOR GIRLS AND WOMEN. H. Lawrence and G. Fox.

Written for beginner and advanced players. A thorough discussion of teen tactics, player conduct, care and prevention of injury. 41 illustrations. \$4.25\*

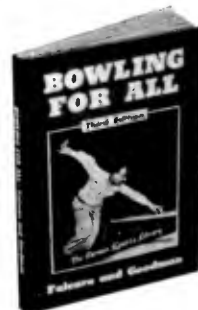

1062. BOWLING FOR ALL. Joe Falcaro and Murray Goodman.

For the average bowler who desires to learn about the skills and rules of ten-pin and duck-pin bowling. 62 illustrations and diagrams. \$2.95\*

671. BOWLING TO WIN. Buzz Fazio.

A beginner's book for the whole family, containing basic rules, how-to-do-it photographs, plus inside tips from a World Championship team. Special hints on team bowling. \$1.00

678. EDUCATION THROUGH PHYSICAL ACTIVITIES. Patric Ruth O'Keefe and Anita Aldrich.

Covers physical education activities for grades 1 through 7. Noon play periods, playground and gymnasium schedules. \$4.50\*

680. THE ENCYCLOPEDIA OF SPORTS. Frank G. Menke.

The only reference of its kind, covering every sport in every country. New and completely revised. \$10.00

\* Not subject to NRA membership discount.

682-686. **FIRST SPORTS BOOKS FOR THE YOUNG OUTDOORSMAN.** C. B. Colby.

Each of these introductory sports books contains over 100 illustrations by the author. ea. \$2.00

682. **First Boat: How to Pick it and Use it for Fun Afloat.**

683. **First Bow and Arrow: How to Use it Skillfully for Outdoor Fun.**

684. **First Camping Trip: How to Make it Easier and More Comfortable.**

685. **First Fish.**

686. **First Rifle: How to Shoot it Straight and Use it Safely.**

687. **FOOTBALL'S GREATEST COACHES: The Story of the Players and Plays that Made Them Famous.** Edwin Pape.

Detailed stories of the lives of 28 great football coaches. \$4.50

1063. **HAMMOND'S SPORTS ATLAS OF AMERICA.** E. L. Jordan.

A guide to hunting areas, fishing grounds, ski runs, hiking trails, golf courses, etc. throughout the U.S. and Canada plus cities featuring spectator sporting events. \$2.95

1064. **HORSEMANSHIP FOR BEGINNERS—Riding, Jumping and Schooling.** Jean Slaughter.

The basic rules of good horsemanship and the reasons behind them presented in easy-to-understand, readable style. Photos by Michael J. Phillips. \$3.75

694. **HOW TO COVER, WRITE AND EDIT SPORTS.** Harry E. Heath, Jr. and Lou Gelfand.

A new edition of effective writing tips, methods of covering the major sports, the development of sports writing in America. Includes chapter on sports photography. \$5.00

1065-1076. **HOW TO IMPROVE YOUR SPORTS SERIES.**

Basic fundamentals of twelve sports, fully illustrated. \$.50 ea. Complete set, \$6.00

1065. Archery.

1068. Badminton.

1067. Baseball.

1068. Basketball.

1069. Bowling.

1070. Golf.

1071. Softball.

1072. Tennis.

1073. Track and Field.

1074. Tumbling.

1075. Volleyball.

1076. Wrestling.

701. **INDIVIDUAL SPORTS FOR MEN.** John H. Shaw, Carl A. Troester, Jr., Milton A. Gabrielsen.

Covers archery, badminton, bowling, fencing, golf, handball, swimming, tennis and others, with latest rules, illustrations of technique and strategy. \$5.00\*

703. **INDIVIDUAL SPORTS FOR WOMEN.** Dorothy S. Ainsworth and others.

How to teach archery, badminton, bowling, fencing, golf, riding, swimming and tennis to women. Covers rules and strategy, equipment, technique. \$4.75\*

1077. **INTRODUCTION TO MOUNTAINEERING.** George Alan Smith.

This book describes fundamental principles and equipment in hiking, rock-climbing, and climbing on snow and ice. \$3.75

708-709. **KNOFF JUNIOR ACTIVITY BOOKS.**

Clear text, with illustrations, intended for boys and girls from 7 to 11. Ea. \$1.50

708. **Table Tennis.** William P. Gottlieb.

709. **Boxing for Boys.** Donald K. Silks.

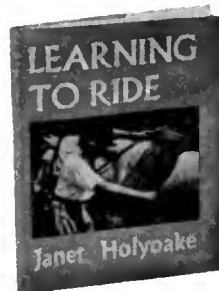

1078. **LEARNING TO RIDE.** Janet Holyoake.

Easy-to-follow instructions for the junior rider and safety measures for beginners. \$3.50

711. **MAJOR SPORTS TECHNIQUES ILLUSTRATED.** Ethan Allen, Jim Moore, Forrest Anderson and Don Canham.

A combination volume of 5 of the Techniques Illustrated series. \$6.00\*

1079. **A MANUAL OF PHYSICAL EDUCATION ACTIVITIES.** Hollis Fait, John Shaw, Grace Fox and Cecil Hollingsworth.

Complete techniques and rules are described for teaching 26 different sports for men and women. \$4.00\*

715. **MODERN VOLLEYBALL.** Curtis Emery.

Complete coverage of the game from fundamentals to precision plays. Practical pointers for coaches and players. Illustrated with 25 drawings and diagrams. \$2.95

1080-1090. **NAVAL AVIATION PHYSICAL TRAINING MANUALS.**

Illustrated guides to physical education compiled by the U.S. Naval Institute.

1080. **Basketball.** \$4.00

1081. **Boxing.** \$4.00

1082. **Conditioning Exercises.** \$4.00.

1083. **Football.** \$4.00

1084. **Gymnastics and Tumbling.** \$4.50

1085. **Intramural Programs.** \$4.00

1086. **Modern Fencing.**

1087. **Soccer.** \$4.00

1088. **Swimming and Diving.** \$4.50

1089. **Track and Field.** \$4.00

1090. **Wrestling.** \$4.00

724. **PHYSICAL EXERCISE PROGRAMS.** Seward Charley Staley.

Designed for leaders and teachers of physical exercise programs. Discusses improved methods of teaching and management, new exercises. \$3.50\*

1091. **RIDING TECHNIQUE IN PICTURES.** C. E. G. Hope and Charles Harris.

A collection of 440 photographs illustrating the steps from mounting a horse to the acquisition of a deep balanced seat to riding exercises to show jumping. \$6.50

726. **SELECTED TEAM SPORTS FOR MEN.** John H. Shaw and Others.

Practical guide on how to play and how to teach ice hockey, lacrosse, 6-man football, soccer, softball, speedball, touch football and volleyball. \$4.75\*

1092. **SKATING FOR BEGINNERS.** Barbara Ann Scott and Michael Kirby.

Ice-skating, ice-ballet, and figure skating presented by the former Olympic champion and her partner in clear text with illustrations. \$3.75

732. **SPORTS FOR RECREATION—AND HOW TO PLAY THEM.** Elmer D. Mitchell and Others.

Skills and techniques of 50 sports—historical background, description, equipment, basic rules. With many illustrations. \$5.00\*

733. **SPORTS IN AMERICAN LIFE.** Frederick W. Cozens and Florence S. Stumpf.

The growth of American sports since the beginning of the century and their relationship to our standard of living. \$5.00

738. **SUCCESSFUL WRESTLING—ITS BASES AND PROBLEMS.** Arnold W. Umbach and Warren B. Johnson.

Thorough coverage of amateur wrestling. Features drawings of wrestling maneuvers made from championship movies and photographs. \$3.50\*

745. **THE THEORY AND PRACTICE OF FENCING.** Julio Martinez Castello.

Complete and comprehensive guide for the beginner by one of the great fencing teachers. Suggestions on reviewing and checking details for advanced students. \$3.95

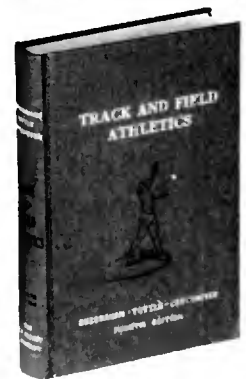

746. **TRACK AND FIELD ATHLETICS.** George T. Bresnahan, W. W. Tuttle and Francis X. Cretzmeyer.

Techniques of each event described step by step. Also daily schedules of practice, providing a pattern for the order in which techniques may be taught. \$5.50\*

1093. **TUMBLING TECHNIQUES ILLUSTRATED.** Ted Burns and Tyler Micolesau.

Series of stunts, with details of how to perform them, appear in a logical progression, the preceding stunts affecting those which follow. \$3.00\*

1094. **WINNING BADMINTON.** Kenneth R. Davidson and Lealand R. Gustavson.

A complete coverage of badminton including principles and skills, strategy and tactics, group instruction and club organization. For beginner and advanced players. \$3.00\*

## BASEBALL

662. **BASEBALL: Major League Techniques and Tactics.** Ethan Allen.

A thorough analysis of all aspects of the game, for players, coaches, fans. Illustrated with 350 photographs of players in action. \$3.95

**Sports (Cont.)**

663. **BASEBALL FOR YOUNG CHAMPIONS.** Robert J. Antonacci and Jene Barr. Handbook for the young baseball player. Discusses training rules, tips on how to play well, gives history of baseball and of scores and records. Action drawings. \$2.75

1095. **THE GAME PLAYS OF BASEBALL.** Al Niemiec.

Explains the fundamental plays by situations, describes moves of offense and defense by individual positions. With diagrams. To help coaches improve their teams. \$2.00

695. **HOW TO PLAY BASEBALL.** Mary Graham Bonner.

A practical guide for boys and girls 8 to 12 who want to master all aspects of baseball. Illustrations by Bernard Krigstein. \$2.00

697. **HOW TO PLAY CHAMPIONSHIP BASEBALL.** Oscar Fraley.

Over 400 action photographs showing how Major League players hit, pitch and play the various positions on the diamond. High-speed, split-sequence pictures by Charles Yerkow. Cl. \$2.95, pa. \$1.00

699. **HOW TO PLAY WINNING BASEBALL.** Arthur Mann.

Authoritative guide to every aspect of baseball—pitching, catching, infield, outfield, offensive, running, coaching, umpiring. Over 100 how-to-do-it diagrams. \$2.95

719. **THE OFFICIAL ENCYCLOPEDIA OF BASEBALL.** Hy Turkin and S. C. Thompson.

The most comprehensive book on baseball, including a record of every player ever to appear in a Major League game. \$5.95

1096. **THE PICTORIAL BASEBALL INSTRUCTOR.** Lamont Buchanan.

Shows by means of photographs just how each position is played in College play, Big League and Little League. \$2.95

**BOATING**

1097. **BOATING HANDBOOK.**

Photos, drawings and diagrams plus hints for happier and safer boating for beginners and experienced sailors. \$2.00

1098. **CANOEING—A-Z.** Ruth Elvedt.

Types of paddles, their care and repair; selection and care of canoes; safety skills; canoeing trips. \$1.50\*

677. **THE COMPLETE GUIDE TO SMALL POWER BOATS.** Howard Springer.

What to look for when you buy a boat, hints on repairing, caring for and storing boats, from outboard to 26-foot cruiser. Navigation tips. Illustrated. \$1.00

679. **THE ENCYCLOPEDIA OF OUTBOARD MOTORBOATING.** Hank Wieand Bowman.

A comprehensive illustrated volume covering all aspects and problems of the sport. \$5.75

1099. **HOW TO SAIL.** Samuel Carter III.

Recommended by the A.R.C. as a guide to sailing safety and enjoyment. Revised to include outboard motor boating and detailed information on navigation. \$.95

1100. **OUTBOARD BOATING HANDBOOK.** Hank W. Bowman.

The latest specifications for 1956 outboard motors, hulls, kit boats, outboard cruisers. Details of motor selection and maintenance. Over 400 photos, sketches and diagrams. \$2.00

725. **PRINCIPLES OF CANOEING.** Pierre Pulling.

Complete guide to the handling of a canoe. Explains basic paddling strokes for the beginner, ways of improving the experienced canoeist's technique. With illustrations. \$3.95

1101. **SAILING ILLUSTRATED.** Gabor Denes.

Complete information on handling a rowing dingy, sailing small boats, cruising, racing, maintenance, advice on ownership, amateur construction and where to sail. \$5.00

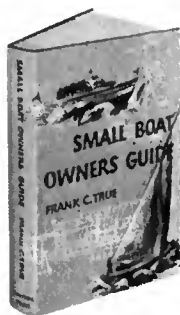

1102. **SMALL BOAT OWNERS' GUIDE.** Frank C. True.

Contains the information necessary to select and operate a small boat safely, economically, and enjoyably. With space provided for entering personal boating information. \$3.50

**FISHING & HUNTING**

672. **THE BOYS' BOOK OF RIFLES.** Charles Edward Chapel.

For boys 12 and over, complete instructions on marksmanship with a .22 caliber rifle. With illustrations by Dick Spencer. \$3.50

1103. **FLY-TYING.** William B. Sturgis.

A complete book of over a dozen types of artificial lures and their construction. Also includes discussion of live bait, equipment. 21 explanatory sketches and 4 photographs. \$3.95

1104. **GUNS AND HUNTING.** Pete Brown.

Practical information on guns and how to select them. Tips on game and how to best enjoy the sport of hunting. Illustrated. \$1.95

1105. **A HANDBOOK OF SALT-WATER FISHING.** O. H. P. Rodman.

A thorough, comprehensive, authoritative guide to fishing the entire American coast, for expert or novice. Illustrated in black and white. \$3.00

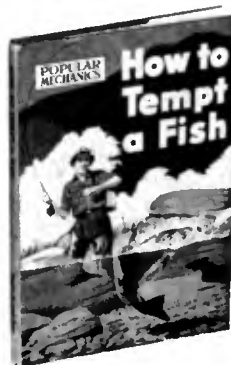

1106. **HOW TO TEMPT A FISH.** Eds. Popular Mechanics.

Basic information on all types of fishing, from small inland streams to salt water deep-sea fishing, with new methods of fly-fishing and using lures. \$2.50

1107. **OUTDOOR HORIZONS.** Lawrence M. Brings, Ed.

Articles on hunting and fishing written by wildlife experts, illustrated by original paintings in color by Roger Preuss and photographs by the author. Cl. \$7.50, de luxe \$10.00

1108. **OUTDOOR LIFE FISHING BOOK.** P. Allen Parsons.

Outlines basic principles for all rod and reel fans. Contains biographies and geographical habits of various species. \$1.00

1109. **OUTDOOR LIFE SHOOTING BOOK.** Jack O'Connor.

Covers completely rifles, handguns and shotguns. Also, selection, care and handling of guns. 150 illustrations and charts. \$1.00

1110. **SALT WATER ANGLING.** Michael Kennedy.

The basic principles of sea fishing including spinning, trolling, fly fishing, float fishing, ground fishing from boats, and surf casting. New ideas about rods and reels, lines and lures and terminal tackles. \$8.50

**GOLF**

668. **BEGINNER'S GUIDE TO GOLF.** Bob Toski.

How to make fast progress in golf, by the 1954 World Champion. Tips on improving your swing, plus hints on courtesy on the golf course. Paper bound. \$1.00

689. **GOLF FOR BOYS AND GIRLS.** Chick Evans.

A basic book describing the game, the course, how to practice, how to play in bad lies and bad weather, how to caddie. Hundreds of illustrations and action photographs. \$3.50

693. **THE GOLF SECRET.** H. A. Murray.

A doctor finds the elemental golf swing, one governed throughout by the left shoulder. Simple and very effective. Illustrated. \$2.50



700. **HOW TO PLAY YOUR BEST GOLF ALL THE TIME.** Tommy Armour.

Lessons to help you play a consistently good game, by a famous pro. Illustrated by Lealand Gustavson. \$3.50

716. **MORE GOLF SECRETS.** H. A. Murray.

A doctor studies the golf game: stance, ball position, chip shots, putting, etc. All shots made simpler to play by the use of a few fundamental principles. \$2.50

\* Not subject to NRA membership discount.

**JUDO**

707. **JUDO.** M. Feldenkrais.  
Covers the whole field of judo, giving some outstanding examples of every kind of technique. Suitable for beginners, valuable for the experienced. Fully illustrated. \$1.50

720. **OFFICIAL JUDO.** Charles Yerkow.

How to perform a fascinating sport that provides self-defense and develops self-confidence. Over 200 continuous action pictures teach basic holds, throws and defenses. pa. \$1.00

1111. **THE SPORT OF JUDO.** Kiyoshi Kobayashi and Harold E. Sharp.

Over 350 photographs graphically illustrate every phase of judo, from its training and practice to its most difficult techniques. \$2.50

**SKIING**

706. **INVITATION TO SKIING.** Fred Iselin and A. C. Spectorisky.

An illustrated guide to the sport for beginner skiers, by a writer and an internationally known ski champion and instructor. pa. \$1.95

713. **MODERN SKI SYSTEMS.** Hans Georg.

Internationally famous instructor shows how to master the best techniques, in vivid text, accompanied by more than 150 action photographs. \$3.75

714. **MODERN SKIING.** Robert S. Bourdon.

A practical new guide to good skiing by one of the country's top experts in the sport. Illustrated. \$2.95

727. **SKIING FOR BEGINNERS.** Conrad Brown.

A ski instructor outlines the fundamentals of the sport in concise text and clear photographs. Designed to teach boys and girls to ski correctly. \$2.50

1112. **SKIING ILLUSTRATED.** Frankie and Johnny O'Rear.

Step-by-step instructions in the preliminary techniques of skiing for young readers. \$3.00

**SWIMMING & WATER ACTIVITIES**

660. **AQUAFUN — WATER GAMES AND WATER CARNIVALS.** National Recreation Assn.

Many kinds of games, relays, stunts and carnivals for fun in the water. \$.50

1113. **AQUATIC GAMES, PAGEANTS, STUNTS.**

A file-sized brochure of water programs. Illustrated, with many suggestions on promotions and methods to build attendance. \$2.50

1114. **BASIC SWIMMING.** R. Kiphuth and H. M. Burke.

A manual of basic information for the beginner, the experienced swimmer and the teacher showing how to swim with the proper form and the minimum of tension. \$3.95

1115. **BEGINNING SYNCHRONIZED SWIMMING.** Betty Spears.

A completely illustrated book for beginners includes action analysis, swimming to accompaniment, teaching hints, and learning progressions. Tells how to put on a successful water show. \$2.50°

1116. **FREE DIVING.** Dimitri Rebikoff.

Covers techniques and equipment available for free diving with self-contained underwater breathing apparatus. \$5.75

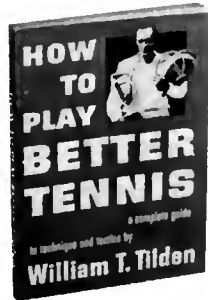

688. **FUN IN THE WATER.** Thomas K. Cureton.

Detailed instructions for over 250 aquatic games — individual stunts, dives, partner events and competitions. Illustrated. \$4.00

1117. **RHYTHMIC SWIMMING.** Katharine Whitney Curtis.

A source of material for stunts, synchronized swimming, routines, and pageants. Spiral bound and illustrated. \$2.50°

1118. **SWIMMING ANALYZED.** Gertrude Goss.

A book used as a text for beginning teachers and students. It includes all the basic strokes in addition to some diving and stunt swimming. Completely illustrated. \$2.50°

740. **SYNCHRONIZED SWIMMING.** Fern Yates and Theresa W. Anderson.

How to use unison swimming for programs, pageants and competitions. Illustrations of variations in standard strokes and 67 special stunts. Covers music, staging, program. \$4.25°

1119. **TEACHING BEGINNERS TO SWIM.**

A file-size brochure containing articles by many well-known swimming coaches. Practical hints on child psychology, overcoming fear, etc. \$2.50

748. **UNDERWATER SPORT.** Albert VanderKogel and Rex Lardner.

A lively encyclopedia of this popular sport, covering spear-fishing, skindiving, underwater photography, exploration. Information on equipment. With drawings and photographs. \$3.50

1120. **WATER STUNTS.** George Gordon Hyde.

A collection of 61 swimming tests and 115 water stunts. \$7.75

**TENNIS**

1121. **THE GAME OF DOUBLES IN TENNIS.** William F. Talbert and Bruce S. Old.

Features diagrams of court strategy, principles of team play, analysis of international doubles teams, and other technical points about the game. \$4.95

696. **HOW TO PLAY BETTER TENNIS.** William T. Tilden.

For the beginner or the experienced player, a great tennis star explains the winning techniques and psychology he uses on the court. Illustrated. Bds. \$1.95

698. **HOW TO PLAY CHAMPIONSHIP TENNIS.** Oscar Fraley.

Reveals the form and technique of the champions, explaining basic tactics of championship play. 400 continuous action pictures by Charles Yerkow. Cl. \$2.95, pa. \$1.00

744. **TENNIS FOR TEACHERS.** Helen I. Driver.

Covers mechanics and teaching progressions for 9 tennis strokes; footwork, tactics, court position and placement of shots. Illustrated. Contains official rules and wall chart. \$4.00°

1122. **TENNIS SELF-INSTRUCTOR.** Helen Driver.

A pocket-sized book for self-taught players who want to improve their strokes and strategy. Complete photographic and diagrammatic illustrations. \$2.00°

**Travel**

1123. **AMERICAN YOUTH HOSTEL HANDBOOK AND HOSTELERS' MANUAL.**

Lists hostels in America and gives data on international travel in 30 countries. Covers hiking, skiing, camping, cycling, canoeing and horseback trips. Tips on facilities, equipment, food. \$1.00

1124. **FESTIVALS EUROPE.** Robert Meyer, Jr.

A comprehensive guide to over 600 annual celebrations connected with religious festivals, sports, seasonal flowers, harvests, and cultural events in 21 European countries. \$.500

1125. **FESTIVALS U.S.A.** Robert Meyer, Jr.

A guide to over 1200 events that reflect the occupations, the interests and the heritage of the American people. Arranged by states, listed geographically. \$4.75

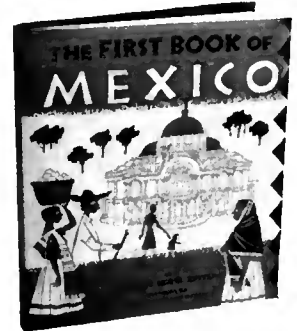

1126. **THE FIRST BOOK OF MEXICO.** Sam and Beryl Epstein.

A panorama of modern and ancient Mexico written for young children with illustrations by Bernice and Lou Myers. \$1.95

1127. **HAMMOND'S PICTORIAL TRAVEL ATLAS OF SCENIC AMERICA.** E. L. Jordan.

An illustrated travel directory to authentically describe in detail 100 travel-worthy scenic and historic places in the United States and Canada. \$7.50

1128. **HOW TO ENJOY YOUR WESTERN VACATIONS.** Kent Ruth.

An accurate and highly readable discussion of the vacation areas of the West, section by section. 470 pages; 48 pages of maps and illustrations. \$4.95

1129. **THE NATIONAL PARKS—What They Mean to You and Me.** Freeman Tilden.

A complete guide to the National Parks, National Monuments and historic sites of the U.S.A. \$5.00, pocket edition \$1.00

381. **YEARBOOK OF ENGLISH FESTIVALS.** Dorothy Gladys Spicer.

Eye-witness descriptions of traditional festivals in many parts of England. Map of countries of England, glossary, bibliography, indexes. \$5.00°

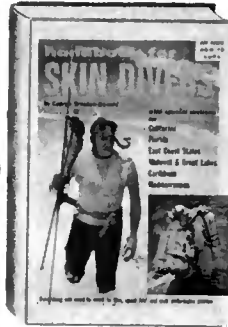

# INDEX

## A

|                                                                 |        |
|-----------------------------------------------------------------|--------|
| ABC's of Camp Music                                             | 8      |
| ABC's of Play Producing, The                                    | 12     |
| ABC's of Public Relations for Recreation, The                   | 9      |
| Abeson, Marion, and Charity Bailey                              | 18     |
| Ackley, Edith F.                                                | 5      |
| Acting                                                          | 12     |
| Active Games and Contests                                       | 13     |
| Activities in Ceramics                                          | 4      |
| Adams, Charlotte                                                | 15     |
| Adapted Physical Education                                      | 3      |
| Adell, Robert                                                   | 3      |
| Adix, Vern                                                      | 12     |
| Adler                                                           | 20     |
| Administration of School Health and Physical Education Programs | 20     |
| Administration of the Modern Camp                               | 8      |
| Adventure Book of Money                                         | 14     |
| Adventure Books, The                                            | 19     |
| Adventures in Artificial Respiration                            | 24     |
| Adventures in Singing                                           | 17     |
| Adventuring in Nature                                           | 19     |
| Ainsworth, Dorothy S., etc.                                     | 25     |
| Albright, H.                                                    | 12     |
| Albright, H., etc.                                              | 12     |
| Aldrich, Anita                                                  | 24     |
| Alexander, C. H. O'D.                                           | 13     |
| Alexander, Marthann                                             | 7      |
| All About Us                                                    | 23     |
| Allen, Catherns                                                 | 21     |
| Allen, Ethan                                                    | 25     |
| Allen, Ethan, Jim Moore, Forrest Anderson and Don Canham        | 25     |
| Allen, Harry R.                                                 | 13     |
| Amateur Naturalist's Handbook, The                              | 19     |
| Ambrose, Kay                                                    | 9      |
| American Book of Days, The                                      | 15     |
| American Dolls                                                  | 14     |
| American Folk Songs for Christmas                               | 17     |
| American Girl's Treasury of Sport, Hobbies and Parties          | 21     |
| American Indian, The                                            | 15     |
| American Nonsinging Games                                       | 13     |
| American Red Cross                                              | 24     |
| American Square Dance, The                                      | 9      |
| American Youth Hostel Handbook and Hostlers' Manual             | 27     |
| America's Arts and Skills                                       | 4      |
| Amst, Gerald                                                    | 7      |
| And Promenade All                                               | 9      |
| Anderson, Doris                                                 | 13     |
| Anderson, Forrest                                               | 25     |
| Anderson, J. M.                                                 | 21     |
| Anderson, Theresa W.                                            | 27     |
| Anderson, Walter W., et al                                      | 15     |
| Angier, Bradford                                                | 9      |
| Antoinette Pope School Candy Book                               | 4      |
| Antonacci, Robert J., and Jane Barr                             | 26     |
| Anyons Can Paint                                                | 4      |
| Aquafun—Water Games and Water Carnivals                         | 27     |
| Aquatic Games, Pageants, Stunts                                 | 27     |
| Archery Handbook                                                | 24     |
| Armbruster, David A.                                            | 24     |
| Armour, Tommy                                                   | 10, 17 |
| Arnold                                                          | 10, 17 |
| Art Activities Almanac                                          | 4      |
| Art and Craft of Hand Weaving, The                              | 4      |
| Art Education Alumni Assn., Wayne University                    | 4      |
| Art for the Family                                              | 3      |
| Art Instruction Books                                           | 4      |
| Art of Flower Arrangement                                       | 14     |
| Art of Knotting and Splicing, The                               | 14     |
| Arts and Crafts Series                                          | 4      |
| Astronomy Handbook                                              | 20     |
| Atkinson, Margaret F., and Nancy Draper                         | 9      |
| Audsley, James                                                  | 9      |
| Autograph Accompaniments to Old Favorite Songs                  | 17     |

## B

|                                                    |    |
|----------------------------------------------------|----|
| Bachman, John W.                                   | 16 |
| Background to Gardening                            | 20 |
| Bailey, Charity                                    | 18 |
| Bailey, Howard                                     | 17 |
| Baker, Bill                                        | 9  |
| Baker, Robert H.                                   | 19 |
| Balanchine, George                                 | 9  |
| Balanchine's Complete Stories of the Great Ballads | 9  |
| Ballet Companion, The                              | 9  |
| Ballet for Beginners (839)                         | 9  |

|                                                                  |               |
|------------------------------------------------------------------|---------------|
| Ballet for Beginners (215)                                       | 9             |
| Ballet-Student's Primer, The                                     | 9             |
| Bampton, Ruth                                                    | 17            |
| Barbeque Cook Book                                               | 8             |
| Barr, Jane                                                       | 26            |
| Baseball for Young Champions                                     | 26            |
| Baseball: Major League Techniques and Tactics                    | 25            |
| Basic Book of Sports, The                                        | 24            |
| Basic Skills in Sports                                           | 24            |
| Basic Swimming                                                   | 27            |
| Basketball for Girls and Women                                   | 24            |
| Bassett, Kendall T., and Arthur B. Thurman                       | 6             |
| Batchelder, Marjorie, and Virginia Lee Comer                     | 24            |
| Bates, Kenneth F.                                                | 5             |
| Bear, Elizabeth                                                  | 14            |
| Beck, E. C.                                                      | 24            |
| Beckard, Richard                                                 | 16            |
| Beginner's Guide to Golf                                         | 26            |
| Beginner's Guide to the Sters                                    | 20            |
| Beginning Synchronized Swimming                                  | 27            |
| Benson, Oscar H.                                                 | 6             |
| Berk, Barbara                                                    | 17            |
| Best, Dick and Beth                                              | 18            |
| Best-Maugard, Adolfo                                             | 6             |
| Bethers, Ray                                                     | 6, 13         |
| Better Camping                                                   | 8             |
| Better Flower Arrangements for Home and Exhibition               | 14            |
| Betty White's Dancing Made Easy                                  | 9             |
| Betty White's Teen-Age Dance Book                                | 9             |
| Betty White's Teen-Age Dance Etiquette                           | 9             |
| Bible Games for Young and Old                                    | 12            |
| Biblical Costumes for Church and School                          | 3             |
| Biddle, Dorothy, and Dorothea Blom                               | 15            |
| Bird Book, The                                                   | 19            |
| Bleifeld                                                         | 19            |
| Block Printing on Fabrics                                        | 4             |
| Blom, Dorothea                                                   | 15            |
| Blue-Ribbon Plays for Graduation                                 | 11            |
| Blumenau, Lili                                                   | 4             |
| Blumenthal, Louis H.                                             | 21            |
| Boating Handbook                                                 | 26            |
| Boats, Airplanes and Kites                                       | 4             |
| Bone, Stephen                                                    | 7             |
| Boni, Margaret Bradford                                          | 17            |
| Bonner, Mary Graham                                              | 26            |
| Book of Arts and Crafts, The                                     | 9             |
| Book of Ballet, The                                              | 13            |
| Book of Games, The                                               | 13            |
| Book of Games for Boys and Girls: How to Lead and Play Them, The | 13            |
| Book of Games—For Home School, Playground                        | 13            |
| Book of Indian Crafts and Costumes, The                          | 15            |
| Book of Knots, Ties, and Splices, The                            | 14            |
| Book of Negro Songs, A                                           | 17            |
| Book-Collecting as a Hobby                                       | 14            |
| Borst, Evelynne                                                  | 13            |
| Bourdon, Robert S.                                               | 27            |
| Bowers, Ethel                                                    | 22            |
| Bowling for All                                                  | 24            |
| Bowling to Win                                                   | 24            |
| Bowman, Claire M.                                                | 3, 8          |
| Bowman, Hank Wisand                                              | 26            |
| Bowman, Paul, etc.                                               | 23            |
| Boy Mechanic, The                                                | 4             |
| Boy Scientist, The                                               | 19            |
| Boys' Book of Frogs, Toads and Salamanders                       | 19            |
| Boys' Book of Rifles, The                                        | 26            |
| Boys' First Book of Radio and Electronics, The                   | 14            |
| Bragdon, Helen D.                                                | 3             |
| Brainerd, Alanson D.                                             | 17            |
| Braucher, Howard                                                 | 23            |
| Breen, Mary                                                      | 5             |
| Bresnahan, George T., W. W. Tuttle and Francis X. Cretsmeyer     | 25            |
| Brewster, Paul G.                                                | 13            |
| Briker, William Paul                                             | 14            |
| Brief History of Parks and Recreation in the U.S., A             | 9             |
| Brightbill, Charles K.                                           | 9             |
| Brings, Lawrence M.                                              | 3, 11, 22, 26 |
| Brooks, Myra J., Mary Alice and John P. Roche                    | 14            |
| Brown, Conrad                                                    | 27            |
| Brown, H.                                                        | 3             |
| Brown, Lillian                                                   | 18            |
| Brown, Pete                                                      | 26            |
| Brown, Thelma S.                                                 | 12            |
| Brown, Vinson                                                    | 19, 22        |
| Brummitt, Wyatt                                                  | 23            |
| Bryant, Laura, and Katherine Knapp                               | 18            |
| Buchanan, Lemont                                                 | 26            |
| Bucher, Charles A.                                               | 16, 17, 20    |
| Build It Yourself Book for Boys                                  | 4             |
| Burack, A. S.                                                    | 11            |
| Burchenal, Elizabeth                                             | 10            |

|                                |           |
|--------------------------------|-----------|
| Burke, H.                      | 8, 24, 27 |
| Burnett, Bernice               | 15        |
| Burnett, R. Will               | 19, 23    |
| Burns, Ted, and Tyler Micolcau | 25        |
| Butler, George D.              | 9, 12, 21 |
| Buttolph, Edna G.              | 18        |
| Byrnes, Gene                   | 5         |

## C

|                                                                      |        |
|----------------------------------------------------------------------|--------|
| Calkins, E. E.                                                       | 14     |
| Camp Counseling                                                      | 8      |
| Camp Counselor Training Workbook                                     | 8      |
| Camp Counselor's Manual                                              | 8      |
| Camp Craft                                                           | 8      |
| Camp Nurse, The                                                      | 8      |
| Camp Program Book, The                                               | 8      |
| Camp Site Development                                                | 8      |
| Camp Songs 'n Things                                                 | 8      |
| Campcraft ABC's                                                      | 8      |
| Campfire and Council Ring Programs                                   | 8      |
| Camping                                                              | 8      |
| Camping—A Guide to Outdoor Safety and Comfort                        | 8      |
| Camping and Character                                                | 8      |
| Camping and Woodcraft                                                | 8      |
| Camping Handbook                                                     | 8      |
| Can You Name Them?                                                   | 13     |
| Candle Book, The                                                     | 4      |
| Canham, Don                                                          | 25     |
| Canoeing—A-Z                                                         | 26     |
| Carabo-Cone, Madeleine, and Beatrice Royt                            | 18     |
| Care and Feeding of Hobby Horses                                     | 14     |
| Carhart, Arthur                                                      | 9      |
| Carlson, Charles X.                                                  | 4      |
| Carter                                                               | 18     |
| Carter, Samuel, III                                                  | 26     |
| Carving Animal Caricatures                                           | 4      |
| Case of the Missing Handshake, The                                   | 11     |
| Casey, Beatrice Marie                                                | 15, 23 |
| Castallo, Julio Martinez                                             | 25     |
| Cavanah, Frances                                                     | 15     |
| Ceramics                                                             | 4      |
| Ceramics Book                                                        | 5      |
| Ceramics for the Artist Potter                                       | 5      |
| Chalk Talk Stunts                                                    | 21     |
| Challenge of Children, The                                           | 16     |
| Championship Chess and Checkers for All                              | 13     |
| Chapel, Charles Edward                                               | 26     |
| Chapman, Gaudette and Hammett                                        | 9, 23  |
| Chernov, Irving, and Kenneth Hartness                                | 13     |
| Cherry, Raymond                                                      | 5      |
| Chess                                                                | 17     |
| Child Life in Music                                                  | 13     |
| Child Study Assn. of America                                         | 15     |
| Children Can Make It                                                 | 3      |
| Children We Teach, The                                               | 16     |
| Children's Theatre Manual                                            | 10     |
| Child's Unfoldment Through Music, The                                | 17     |
| Choral Readings for Fun and Recreation                               | 3      |
| Choral Readings for Worship and Inspiration                          | 3      |
| Choral Readings from the Bible                                       | 3      |
| Chorpenning, Charlotte B.                                            | 10     |
| Christian Fellowship Games                                           | 3      |
| Christmas Booklets                                                   | 15     |
| Christmas Everywhere                                                 | 15     |
| Christmas Ideas Book                                                 | 15     |
| Christmas Plays for Young Actors                                     | 11     |
| Christie, Frances N.                                                 | 19     |
| Cirou, Ernest H.                                                     | 7      |
| Clayton                                                              | 24     |
| Clegg, Helen, and Mary Laram                                         | 6      |
| Clemens, Frances, Robert Tully and Edward Crill                      | 3      |
| Clinical Applications of Recreational Therapy                        | 3      |
| Coffey, Ernestina S., and Dorothy F. Minton                          | 30     |
| Coit, Lottie Elsworth, and Ruth Bampton                              | 17     |
| Colby, C. B.                                                         | 25     |
| Colby, Carroll                                                       | 20     |
| Cole, Toby                                                           | 12     |
| Comer, Virginia Lee                                                  | 24     |
| Commyer, E. W., and C. Eugene Stephenson                             | 14     |
| Community and Assembly Singing                                       | 17     |
| Community Organization and Agency Responsibility                     | 20     |
| Community Recreation                                                 | 9      |
| Community Sports and Athletics—Organization, Administration, Program | 20     |
| Community Youth Development Program, A                               | 9      |
| Complete Book of Collecting Hobbies, The                             | 14     |
| Complete Book of Furniture Repair and Refinishing, The               | 5      |
| Complete Book of Party Games, The                                    | 21     |
| Complete Guide to Cartooning, The                                    | 5      |

|                                                                                                                      |            |
|----------------------------------------------------------------------------------------------------------------------|------------|
| Complete Guide to Small Power Boats, The                                                                             | 25         |
| Conduct of Playgrounds                                                                                               | 20         |
| Conduct of School Community Centers                                                                                  | 21         |
| Contemporary Handweaving                                                                                             | 5          |
| Contract Bridge Complete                                                                                             | 13         |
| Contract Bridge for Beginners                                                                                        | 13         |
| Conway, Gregory J.                                                                                                   | 14         |
| Cooke, Emogene                                                                                                       | 20         |
| Cooperative Parents' Group of Palisades Pre-School Division and Mothers' and Children's Educational Foundation, Inc. | 16         |
| Corbin, H. Dan                                                                                                       | 17         |
| Corry, P.                                                                                                            | 12         |
| Costume Book for Parties and Plays, The                                                                              | 12         |
| Costume Throughout the Ages                                                                                          | 12         |
| Cottam, Clarence                                                                                                     | 19         |
| Counseling with Young People                                                                                         | 16         |
| Course in Beginning Watercolor                                                                                       | 5          |
| Course in Pencil Sketching                                                                                           | 5          |
| Cowboy Dances                                                                                                        | 9          |
| Coz, Doris, and Barbara Warren                                                                                       | 6          |
| Cozens, Frederick W., and Florence Stumpf                                                                            | 25         |
| Crafts Projects for Camp and Playground                                                                              | 5          |
| Crampton, Gertrude                                                                                                   | 22         |
| Crawford, Ida B.                                                                                                     | 8          |
| Creative Crafts for Camping                                                                                          | 5          |
| Creative Dramatics for Children                                                                                      | 10         |
| Creative Group Education                                                                                             | 16         |
| Creative Handicraft                                                                                                  | 5          |
| Creative Handicrafts                                                                                                 | 5          |
| Creative Hands                                                                                                       | 5          |
| Creative Hobbies                                                                                                     | 14         |
| Cretsmeyer, Francis X.                                                                                               | 25         |
| Crill, Edward                                                                                                        | 3          |
| Criteria for the Evaluation of a Boys' Club                                                                          | 21         |
| Crownshield, Elizabeth                                                                                               | 17, 18, 19 |
| Curtson, Thomas K.                                                                                                   | 27         |
| Curtis, Katherine Whitney                                                                                            | 27         |
| Cutler, Katherine N.                                                                                                 | 14         |

## D

|                                                               |       |
|---------------------------------------------------------------|-------|
| D'Amico, Victor                                               | 5     |
| D'Amico, Victor, and Charles J. Martin                        | 6     |
| D'Amico, Victor, Frances Wilson and Moreau Maser              | 3     |
| Dance A While                                                 | 3     |
| Dance in Elementary Education                                 | 10    |
| Dance in Psychotherapy                                        | 3     |
| Daniel, Howard G.                                             | 21    |
| Danford                                                       | 18    |
| Daniels, Arthur S.                                            | 3     |
| Davidson, Kenneth R., and Lealand R. Gustavson                | 25    |
| Davidson, Lavetta J.                                          | 23    |
| Davis, Barton K.                                              | 6     |
| Davis, John E.                                                | 18    |
| Dawson, Louise and Betty                                      | 3     |
| Day, Cyrus                                                    | 17    |
| Dean, John P., and Alex Rosen                                 | 14    |
| De Angelo, Jaime                                              | 23    |
| De Armand, David W.                                           | 23    |
| Decorating for Joyful Occasions                               | 15    |
| DeGrazia, Joseph                                              | 13    |
| DeGros, J. H.                                                 | 15    |
| DeMarche, David F.                                            | 3     |
| Democratic Administration                                     | 21    |
| Dans, Gabor                                                   | 15    |
| Danzon                                                        | 15    |
| DasGray, Arthur H.                                            | 11    |
| Design for Juvenile Decency                                   | 23    |
| Design for Outdoor Education                                  | 23    |
| Designing Education in Values                                 | 27    |
| Deater, Will                                                  | 11    |
| Dias, Earl J.                                                 | 21    |
| Dimock, Hedley S.                                             | 8, 23 |
| Dimock, Hedley S., and Charles E. Hendry                      | 8     |
| Dimock, Hedley S., and Taylor Statton                         | 8     |
| Dinn, Freda                                                   | 18    |
| Directory of Camps Affiliated with the American Camping Assn. | 6     |
| Discover the Stars                                            | 20    |
| Discovering Music                                             | 17    |
| Discovering Nature the Year Round                             | 17    |
| Dirty Bag, The                                                | 17    |
| Dodge, Nat N.                                                 | 19    |
| Dougherty, Charles, and Gerald B. Fitzgerald                  | 9     |
| Doherty, J. Kenneth                                           | 9     |
| Do-It Fun for Boys and Girls                                  | 6     |
| Dolls to Make for Fun and Profit                              | 6     |
| Donahue, Wilma and Clark Tibbitts                             | 4     |
| Donaldson, George                                             | 8     |
| Douglas, George W.                                            | 15    |
| Douglass, Paul F.                                             | 13    |
| Doust, L. A.                                                  | 7     |







|                                                       |        |
|-------------------------------------------------------|--------|
| Social Growth Through Play Production                 | 12     |
| Social Program for Older People, A                    | 4      |
| Saibelman, Doris                                      | 4      |
| Solving Camp Behavior Problems                        | 8      |
| Songs and Stories About Animals                       | 18     |
| Songs for Little Children                             | 18     |
| Songs for the Nursery School                          | 18     |
| Songs for the Seasons                                 | 18     |
| Sorenson, Grece                                       | 11     |
| Sorenson, Roy                                         | 21     |
| Sorenson, Roy, and Hedley S. Dimack                   | 23     |
| Southern Regional Education Board                     | 17     |
| Spears, Betty                                         | 27     |
| Special Plays for Special Days                        | 11     |
| Spectorsty, A. C.                                     | 27     |
| Spicer, Dorothy Gladys                                | 21, 27 |
| Spiritual Values in Camping                           | 8      |
| Sport of Judo, The                                    | 27     |
| Sports for Recreation—and How to Play Them            | 25     |
| Sports in American Life                               | 25     |
| Springer, Howard                                      | 26     |
| Square Dancers' Guide, The                            | 10     |
| Square Dances of Today and How to Teach and Call Them | 10     |
| Square Dancing for Everyone                           | 10     |
| Stafford, Virginia and Lerry Eisenberg                | 4      |
| Stage Technique Made Easy                             | 12     |
| Stagecraft and Scene Design                           | 12     |
| Stahl, LeRoy                                          | 22     |
| Staley, Seward Charle                                 | 25     |
| Stamp Collecting                                      | 14     |
| Stamp Collector's Guide                               | 14     |
| Standards for Municipal Recreation Areas              | 12     |
| Staples, Frank A.                                     | 4, 7   |
| Stars, The                                            | 20     |
| Starting a Recreation Program in a Civilian Hospital  | 4      |
| Starting and Developing a Rhythm Band                 | 18     |
| State Laws for Parks and Recreation                   | 21     |
| Statten, Taylor                                       | 8      |
| Steern, Frank                                         | 7      |
| Stein, Clarence S.                                    | 12     |
| Step-by-Step Cook Book for Girls and Boys             | 7      |
| Stephenson, C. Eugene                                 | 14     |
| Stevens, Kate                                         | 22     |
| Stevenson, Fred G.                                    | 17     |
| Stirling, Nora                                        | 11     |
| Stork, Caroline                                       | 24     |
| Stories That Sing                                     | 18     |
| Stories to Dramatize                                  | 10     |
| Streetfield, Noel                                     | 10     |
| Stuart, Frances R., and John S. Ludlam                | 10     |
| Studies in Basic Rhythms for Young Children           | 18     |
| Studying Your Community                               | 9      |
| Stumpf, Florence                                      | 25     |
| Stunts Series                                         | 11     |
| Sturgis, William B.                                   | 26     |
| Successful Camp, The                                  | 8      |
| Successful Wrestling—Its Bases and Problems           | 25     |
| Sullivan, Dorothea F.                                 | 16     |
| Summer Magic                                          | 9      |
| Sunset Ideas for Family Camping                       | 3      |

|                                                                             |    |
|-----------------------------------------------------------------------------|----|
| Supplementary Materials for Use in Creative Dramatics with Younger Children | 10 |
| Sutherland, W. C.                                                           | 17 |
| Swenson                                                                     | 9  |
| Swift, Lorel                                                                | 14 |
| Swimming Analyzed                                                           | 27 |
| Swimming Pool Date & Reference Annual                                       | 12 |
| Synchronized Swimming                                                       | 27 |

**T**

|                                            |       |
|--------------------------------------------|-------|
| Take the Guesswork Out of Pool Planning    | 12    |
| Taking Hold of Television                  | 24    |
| Talbot, William F., and Bruce S. Old       | 27    |
| Tales for Telling                          | 22    |
| Talks to Counselors                        | 8     |
| Tall Tales and Tall Men                    | 11    |
| Tani, Henry N.                             | 3     |
| Tarball, Harlan                            | 21    |
| Teach Yourself Magic                       | 22    |
| Teaching Beginners to Swim                 | 27    |
| Teed, Ordway                               | 21    |
| Teels, Edwin Way                           | 19    |
| Technique of Oil Painting                  | 7     |
| Teen Theatre                               | 12    |
| Teen-Age Sketches                          | 12    |
| Tennis for Teachers                        | 27    |
| Tennis Self-Instructor                     | 27    |
| Teuscher, Ruth                             | 20    |
| Theatre for Children                       | 10    |
| Theatre Scenecraft                         | 12    |
| Thelen, Herbert A.                         | 16    |
| Theory and Practice of Fencing, The        | 25    |
| Therapeutic and Industrial Uses of Music   | 4     |
| They Knew Paul Bunyan                      | 24    |
| This is Photography                        | 23    |
| Thomas, Bob                                | 10    |
| Thompson, S. C.                            | 26    |
| Thurman, Arthur B.                         | 6     |
| Tibbits, Clerk                             | 4     |
| Tilden, Freeman                            | 27    |
| Tilden, William T.                         | 27    |
| Tobitt, Janet E.                           | 8, 17 |
| Torrey, Katherine                          | 7     |
| Toski, Bob                                 | 12    |
| Toward New Towns for America               | 12    |
| Track and Field Athletics                  | 25    |
| Training Volunteers for Recreation Service | 17    |
| Treasury of American Indian Tales          | 16    |
| Treasury of Living, A                      | 23    |
| Treasury of Religious Plays                | 12    |
| Trooster, Carl A., Jr.                     | 25    |
| Tropical Aquariums, Plants and Fishes      | 22    |
| True, Frank C.                             | 26    |
| True Book of Birds We Know, The            | 20    |
| True Book of Holidays                      | 15    |
| True Book of Indians, The                  | 16    |
| True Book of Insects, The                  | 20    |
| True Book of Pebbles and Shells, The       | 20    |
| True Book of Trees, The                    | 20    |
| True Book of Weeds and Wildflowers, The    | 20    |
| Tuffs, J. Elden                            | 22    |

|                                              |    |
|----------------------------------------------|----|
| Tully, Robert                                | 3  |
| Tumbling Techniques Illustrated              | 25 |
| Turkin, Hy, and S. C. Thompson               | 26 |
| Turner, John S.                              | 14 |
| Turoff, Muriel P.                            | 6  |
| Tuttle, W. W.                                | 25 |
| 20 Best European Plays on the American Stage | 11 |
| Twenty Little Songs                          | 18 |
| Twenty-Five Plays for Holidays               | 12 |
| Twenty-one Years with Children's Theatre     | 10 |
| Twice 55 Games with Music—The Red Book       | 19 |

**U**

|                                          |    |
|------------------------------------------|----|
| Umbeck, Arnold W., and Warren B. Johnson | 25 |
| Understanding Boys                       | 17 |
| Understanding Children's Play            | 23 |
| Understanding Girls                      | 17 |
| Understanding the Weather                | 20 |
| Underwater Sport                         | 27 |
| United Nations Plays and Programs        | 12 |

**V**

|                                      |        |
|--------------------------------------|--------|
| van der Smisson, Betty               | 21     |
| Van Rensselaer, Alexander            | 21, 22 |
| Van Sicle Schelhas, Evelyn           | 18     |
| VanderKogel, Albert, and Rex Lerdner | 17     |
| Vannier, Maryhelen                   | 27     |
| Vaughn, L. F.                        | 24     |
| Vaughn's Parade and Float Guide      | 24     |
| Ventures in Youth Work               | 3      |
| Very, Alice                          | 11     |
| Vettiner, Charles J.                 | 23     |

**W**

|                                     |        |
|-------------------------------------|--------|
| Wedley-Allison                      | 17     |
| Wells, The World Together           | 19     |
| Walker, Pamela                      | 10     |
| Wallace                             | 18     |
| Walt Disney's The Living Desert     | 20     |
| Walt Disney's The Vanishing Prairie | 20     |
| Waltner, Elma and W. H.             | 4      |
| War Whoops and Medicine Songs       | 16     |
| Ward, Winifred                      | 10, 19 |
| Warren, Barbara                     | 5      |
| Warren, Roland L.                   | 9      |
| Water Color Painting is Fun         | 7      |
| Water Stunts                        | 27     |
| Watercolor Made Easy                | 7      |
| Watson, Ernest W.                   | 5      |
| Watson, Katherine Williams          | 11, 22 |
| Weaving Handcraft                   | 7      |
| Webb, Susan H. and Kenneth B.       | 15     |
| Wedding Anniversary Celebrations    | 9      |
| Welch, Emily H.                     | 8      |

|                                            |        |
|--------------------------------------------|--------|
| Wells, A. Laurence                         | 22     |
| Wentzel, Fred D., and Edward L. Schlingman | 16     |
| Werner, Jane                               | 20     |
| Wertsner, Anne                             | 15     |
| Wessells, Katherine Tyler                  | 18     |
| Western Campsite Directory                 | 8      |
| What Can I Do Now?                         | 24     |
| White, Betty                               | 9      |
| Who Lives There?                           | 20     |
| Who Went There?                            | 20     |
| Why Not Paint a Watercolor?                | 7      |
| Why Not Write?                             | 14     |
| Wilkins, H. Percy, and Patrick Moore       | 20     |
| Williams, Arthur M.                        | 4      |
| Williams, Helen V.                         | 24     |
| Williams, Wayne R.                         | 12     |
| Wilson, Adelaide B.                        | 14     |
| Wilson, Frances                            | 3      |
| Wilson, Gertrude, and Gladys Ryland        | 17     |
| Window Box Gardening                       | 20     |
| Winning Badminton                          | 25     |
| Wiswell, Tom                               | 13     |
| Wittenberg, Rudolph M.                     | 16, 17 |
| Wood Carving Book                          | 7      |
| Wood, Mary Colely                          | 14     |
| Woolsey, Janette                           | 14     |
| Working Up a Part                          | 12     |
| Workshop Book, The                         | 3      |
| Worship Ways for Camp                      | 7      |
| Wrenn, Bobby and Kathleen                  | 17     |
| Wygol, Winifred C.                         | 3      |
| Wylar, Rose                                | 19     |
| Wylar, Rose, and Gerald Ames               | 20     |

**Y**

|                                          |            |
|------------------------------------------|------------|
| YMCA Water Safety and Lifesaving         | 24         |
| Yates, Fern, and Therese W. Anderson     | 27         |
| Year 'Round Party Book, The              | 15         |
| Yearbook of English Festivals            | 27         |
| Yerkow, Charles                          | 27         |
| You Train Your Dog                       | 22         |
| Young Adult and Family Camping           | 1          |
| Young, Frederic W.                       | 13, 15, 22 |
| Young, Marjorie W.                       | 15         |
| Young, William P., and Horace J. Gardner | 15, 22     |
| Your Child's Leisure Time                | 24         |
| Your Own Book of Nature and Garden Fun   | 20         |

**Z**

|                                      |        |
|--------------------------------------|--------|
| Zeidenberg, Arthur                   | 4      |
| Zenzig, Augustus D.                  | 17, 18 |
| Zerchy, Henry                        | 4, 14  |
| Zerchy, Jeanette                     | 6      |
| Ziegler, Carl                        | 10     |
| Zim, Herbert S., and R. Will Burnett | 23     |
| Zoo Songs to Play and to Sing        | 19     |

**COOPERATING PUBLISHERS**

See inside front cover for National Advisory Committee of Publishers.

- Addison-Wesley Publishing Co., Inc.
- American Camping Association, Inc.
- American Institute of Park Executives, Inc.
- American Youth Hostels, Inc.
- The Antioch Press
- Appleton-Century-Crofts, Inc.
- Arco Publishing Co., Inc.
- Association for Childhood Education International
- Association Press
- The Athletic Institute
- A. S. Barnes & Co., Inc.
- M. Barrows & Co.
- Beacon Hill Press
- Bellman Publishing Co.
- Chas. A. Bennett Co., Inc.
- C. C. Birchard & Co., Inc.
- The Boston Music Co.
- Boys' Clubs of America
- Brethren Publishing House
- Broadman Press
- Burgess Publishing Co.
- The Caxton Printers, Ltd.
- Century House
- Childrens Press
- The Children's Theatre Press
- The Christian Education Press
- Columbia University Press
- Coward-McCann, Inc.
- The Craftsman Press
- Thomas Y. Crowell Co.
- Crown Publishers, Inc.
- T. S. Denison & Co.

- The Devin-Adair Co.
- Doubleday & Co., Inc.
- H. I. Driver Co.
- E. P. Dutton & Co., Inc.
- Emerson Books, Inc.
- Exposition Press
- Federation of Protestant Welfare Agencies, Inc.
- H. T. FitzSimons Co.
- Kenneth Fowell, Publisher
- Friendship Press
- Fun Books
- Girl Scouts of the United States of America
- The Goodheart-Willcox Co., Inc.
- Gertrude Goss, Publisher
- Grosset & Dunlap, Inc.
- C. S. Hammond Co.
- Harian Publications
- Harper & Brothers
- Hastings House, Publishers, Inc.
- Hearthside Press, Inc.
- Hill and Wang, Inc.
- Henry Holt & Co., Inc.
- Houghton Mifflin Co.
- The International City Managers' Association
- International Universities Press, Inc.
- The Iowa State College Press
- Ives Washburn, Inc.
- The John Day Co.
- Alfred A. Knopf, Inc.
- Lane Publishing Co.
- Lantern Press

- Leisure Library
- J. B. Lippincott Co.
- Little, Brown & Co.
- Livwright Publishing Corp.
- McGraw-Hill Book Co., Inc.
- David McKay Co., Inc.
- McKnight & McKnight Publishing Co.
- The Macmillan Company
- Macrae-Smith Co.
- Mental Health Materials Center, Inc.
- William Morrow & Co., Inc.
- C. V. Mosby Co.
- The Museum of Modern Art
- National Publicity Council for Health and Welfare Services, Inc.
- National Recreation Association
- W. W. Norton & Co., Inc.
- Pitman Publishing Corp.
- Plays, Inc.
- Popular Mechanics Press
- Prentice-Hall, Inc.
- P. S. Printers, Inc.
- G. P. Putnam's Sons
- The Rafter Crafters
- Reimhold Publishing Corp.
- The Ronald Press Co.
- Russell Sage Foundation
- W. B. Saunders Co.
- Paul Schwartz, Publisher
- Charles Scribners' Sons
- Sentinel Books, Publishers, Inc.
- Sheridan House

- Simon & Shuster, Inc.
- Songs 'N Things
- State University of Iowa, State Services for Crippled Children
- The Swallow Press
- Swimming Pool Age
- Teachers College, Columbia University
- Charles C. Thomas, Publisher
- Charles E. Tuttle Co.
- United States Naval Institute
- The University of Chicago Press
- The University of Michigan Press
- University of Minnesota, University Press
- University of Nebraska Press
- The University of North Carolina Press
- University of Oklahoma Press
- University of Washington Press
- D. Van Nostrand Co., Inc.
- Charles Vettiner, Publisher
- Frederick Warne & Co., Inc.
- Franklin Watts, Inc.
- Wayne State University Press
- The Westminster Press
- Whiteside, Inc.
- John Wiley & Sons, Inc.
- The Willis Music Co.
- The H. W. Wilson Co.
- The John C. Winston Co.
- The World Publishing Co.
- X-Acto, Inc.
- Yale University Press
- Zondervan Publishing House



