

TJ 118
V2
19

LITTLEFIELD

COPYRIGHTED BY
W. H. VAN DERVOORT
1903

Composition, Printing, and Electrotyping
By MACGOWAN & SLIPPER
30 Beekman Street, New York, U. S. A.



PREFACE.

This book is the outgrowth of a series of articles prepared by the author for the students in machine shop practice at the University of Illinois; some of these articles having recently been published in "Machinery." An effort has been made to treat the subject in a clear and comprehensive manner, carefully avoiding all unnecessary matter and presenting to the apprentice and mechanic many points pertaining to the tools with which they come in daily contact, and about which they are often unable to obtain all the information necessary, in order that they may use these tools correctly and efficiently.

In treating on the various classes of small and machine tools, the author has endeavored to bring out much pertaining to the construction and care of these tools, as well as upon their uses.

The importance of the machinist having at least a limited amount of information on the subjects of Fastenings, Gearing, and Belting and Transmission Machinery has prompted the addition of chapters upon these subjects.

The author wishes to acknowledge his indebtedness to the publishers, the Industrial Press, and the tool manufacturers, who have so kindly assisted him in getting together many of the illustrations and tables used in this work.

March, 1903.

W. H. VAN DERVOORT.

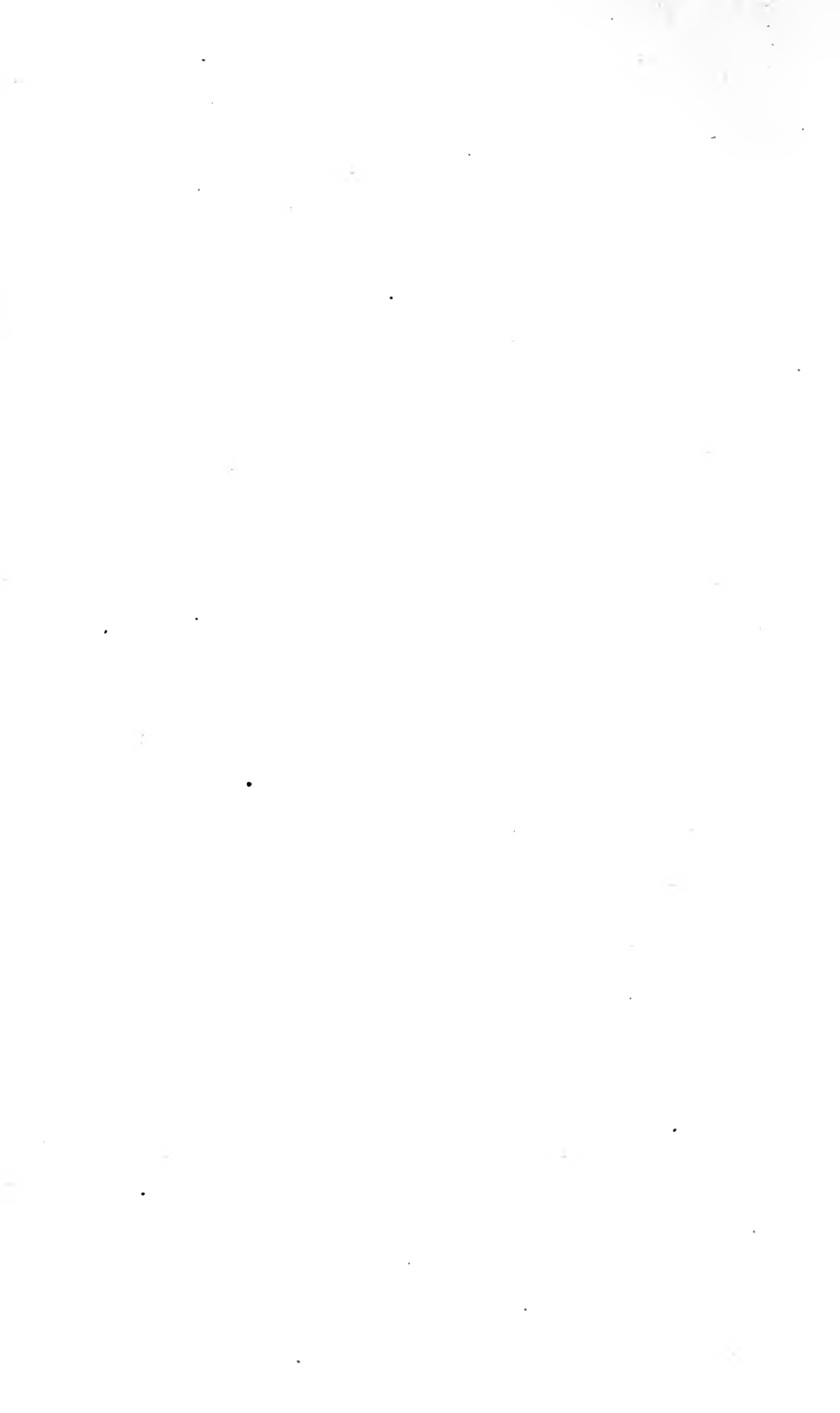

INTRODUCTION.

The correct manipulation of metal working tools comes perfectly natural to many of our young mechanics, and they easily become expert in their use. It seems to be born in them, and they make good workmen no matter how poor the tools with which they work and how bad the instruction they receive; but where one such man is found there will be a dozen others who can acquire the necessary skill to be called good machinists, only after careful study and close application of the most thorough instruction. The time required to accomplish this will depend entirely on the man and the conditions under which he works. Under favorable circumstances two to six years will be required. The more the apprentice reads and thinks the more quickly will he master his trade. Every apprentice should be a regular subscriber to at least one good paper treating on the subject and should READ it. He should never fail to look over the advertising pages of each issue, as these pages constitute a perfect index of progress along the line of his chosen occupation. The reading will create thought, will broaden the ideas and put the young man in a better position to appreciate what he sees and hears.

The young machinist must keep constantly before him the two requisites of a good mechanic—accuracy and rapidity. The first he must acquire, and if he would succeed in these days of close competition, he must couple with it the ability to produce such work quickly. He should, above all things, train his judgment, having it continually with him, and should learn as quickly as possible the strength of the materials with which he is to deal. This will come more by experience than by calculation and let good judgment and common sense aid in making the experience bill low.

“Observation is a great teacher.” Therefore he should learn to observe, noting carefully the ways in which the skilled mechanic performs his work. His thoughts must be kept continually on the work in hand, studying better and quicker ways to do it. He can gain the confidence of his employer in no better way

than by strict attention to his work, careful observance of all regulations pertaining to the management of the plant, and a sincere disposition to do at all times his very best. He should be perfectly free to ask questions; sensible ones, as the other kind will injure his cause. He must be cautious about making suggestions as they are usually not thankfully received. When the foreman gives precise instructions as to how to perform a piece of work, the instructions must be followed to the letter, even though he thinks he can do it in a better way. He is probably wrong, but if not the opportunity to do it his way will come soon, and in such a way as to please rather than provoke, by proving the better method.

He must learn to take a hint, as the foreman may at times suggest rather than tell him that it would be best to do the other way; and above all things he must not have to be told a second time. It is bad to duplicate accidents to tools or mistakes on work, and especially so when previously cautioned on these points.

He cannot be too neat and orderly, not only with his tools and work, but in his personal appearance.

The young mechanic should never lose an opportunity to visit other shops, as he will be sure to get some good ideas from them. More can often be learned in some poorly equipped, ill-managed concern than in a shop running under the most perfect system, as we are often more forcibly impressed with the how not to do it, than with the how. A careful perusal of the trade catalogues issued by all the leading machine and small tool builders cannot fail to be of value, as in those catalogues will be found many excellent cuts, with description of tools, and often valuable hints on their manufacture and uses.

Mechanics who learned their trade before the introduction of modern tools and methods frequently fail to appreciate the importance of their making an effort to familiarize themselves with the nicer points of detail of the later small and machine tools.

The successful working and tempering of high grade steels and the methods of grinding now employed have been the principal factors in the successful manufacture of the many excellent small tools now in use. Better tools, better methods, better workmen and the best of mechanical ability have evolved from the ill-designed and inefficient tools of but a few years ago the excellent ones of to-day.

Many mechanics, both old and young, fail to appreciate the finer points in a good tool; they fail to realize that every line, curve and angle in its construction represents the most careful study, and in most cases have been arrived at only after years of experimentation.

In taking up the subjects pertaining to machine shop tools, their construction and uses, two general subdivisions may be made, small tools and machine tools. Under the head of small tools may be placed all hand tools, measuring tools, cutting tools used in machine tools and jigs. The subdivision of the work commonly performed on metal-working machine tools may be briefly outlined as follows:

First—Turning and Boring; as performed in the lathe, screw-machine, turret-machine, vertical boring mill, etc., in which the work is usually made to rotate to a cutting tool or tools which, aside from feeds, are stationary. This operation usually produces curved or circular surfaces, both internal and external, but may, as in facing, produce a plane surface.

Second—Planing Operations; as performed on the planer, shaper, slotting machine or key-way cutter, where the work is given a straight line motion to a stationary tool, or, as in the three latter types of machines, the tool is given a straight line motion over stationary work. In the former case the feeds are given to the tool while in the latter the work usually receives one or both of the feeds. In the case of the traverse head shaper, however, the tool is given both feeds over perfectly stationary work.

Third—Milling Operations; as performed on the various types of milling machines where a rotating cutter produces plane, curved or formed surfaces on the work, the latter usually receiving the feeds.

Fourth—Drilling; the forming of circular holes in solid stock by means of a revolving tool at one operation, the tool usually receiving the feed. Drilling differs from boring in that the latter term applies to the enlarging and truing of a hole already formed.

Fifth—Grinding; these operations involve the removal of metal and finishing of the surface by an abrasive process, the material being ground rather than cut away. The universal and surface grinding machines correspond with the lathe and planer, a rotating wheel of emery or corundum taking the place of the cutting tool in the latter machines. Grinding operations, although neces-

sarily slow, make possible the accurate finishing of the hardest metals.

The scope of this work will not permit going too much into the details of machine tool construction. It is, however, hoped that the principal points of construction and methods of operation may be brought out clearly and in such a way as to aid the young mechanic in quickly becoming master of the several classes of machine tool operations above enumerated, and suggest some thought for the older mechanic.

CONTENTS.

CHAPTER I.

The Hammer and Cold Chisel..... 17 to 21

CHAPTER II.

The File and Filing..... 22 to 47

CHAPTER III.

Scrapers and Scraped Surfaces..... 48 to 54

CHAPTER IV.

Standards of Measure..... 55 to 63

CHAPTER V.

Calipers 64 to 81

CHAPTER VI.

Gauges and Indicators..... 82 to 92

CHAPTER VII.

Rules, Squares and Other Small Tools..... 93 to 102

CHAPTER VIII.

Drills 103 to 113

CHAPTER IX.

Reamers 114 to 124

CHAPTER X.

Taps and Dies..... 125 to 141

CHAPTER XI.

Drill and Tap Holders..... 142 to 153

CHAPTER XII.

Mandrels 154 to 162

CHAPTER XIII.

The Lathe..... 163 to 181

CHAPTER XIV.

The Lathe in Modified Forms..... 182 to 196

CHAPTER XV.

Lathe Tools..... 197 to 209

CHAPTER XVI.

Chucks and Drivers for Lathe Work..... 210 to 219

CHAPTER XVII.	
Lathe Work, Between Centers.....	220 to 247
CHAPTER XVIII.	
Lathe Work on Face Plate, Chuck and Carriage.....	248 to 263
CHAPTER XIX.	
Boring and Turning Mills.....	264 to 272
CHAPTER XX.	
Planing and Shaping Machines, Their Tools and Attachments	273 to 298
CHAPTER XXI.	
Planer and Shaper Work.....	299 to 305
CHAPTER XXII.	
The Slotting Machine and Key Seater.....	306 to 311
CHAPTER XXIII.	
Milling Machines.....	312 to 335
CHAPTER XXIV.	
Milling Machine Cutters.....	336 to 349
CHAPTER XXV.	
Milling Machine Work.....	350 to 378
CHAPTER XXVI.	
Gear Cutters and Gear Cutting.....	379 to 396
CHAPTER XXVII.	
Drilling Machines and Drilling Work.....	397 to 422
CHAPTER XXVIII.	
Grinding Machines and Grinding.....	423 to 439
CHAPTER XXIX.	
Hardening and Tempering.....	440 to 449
CHAPTER XXX.	
Fastenings	450 to 462
CHAPTER XXXI.	
Gearing	463 to 489
CHAPTER XXXII.	
Belting and Transmission Machinery... ..	490 to 516
CHAPTER XXXIII.	
Miscellaneous Shop Equipment and Conveniences.....	517 to 527
CHAPTER XXXIV.	
Useful Tables and Data	528 to 544

CHAPTER I.

THE HAMMER AND COLD CHISEL.

The hammer and cold chisel are a noisy pair with which the apprentice becomes acquainted early in his shop experience, and his aching arms and battered knuckles tell of the introduction.

The machinist hammer, as generally used, weighs from three-fourths to one and one-half pounds, exclusive of handle. It

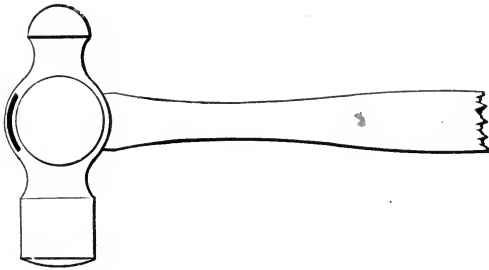

FIG. 1.

is made of high-grade steel, carefully tempered on head and pene and usually of the form shown in Fig. 1. The eye is left soft as it will, in that condition, better resist the shock without danger of cracking. The head is usually made cylindrical with

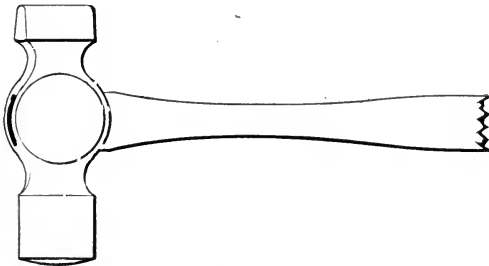

FIG. 2.

a slightly crowning face. For the ball pene is often substituted the straight pene, Fig. 2, and the cross pene, Fig. 3. The pene is used almost entirely for riveting purposes. The eye should

be enlarged slightly at each end; the handle can then be fitted in from one side and wedged to fill the enlargement of the eye on the other side. Hard, smooth wedges are not suitable for this purpose, as they jar loose too easily. Soft wood or roughed metal wedges serve the purpose well.

The handle should be of straight-grained, dry, second-growth hickory, twelve to sixteen inches long; depending on the weight of the hammer. The handle should not be too stiff in the shank, as too rigid a connection between hammer and hand causes undue shock, and consequent tiring of the hand. It should be so set in the eye that its length is at right angles to the axis of hammer head, and its long cross section parallel with this axis.

The face of the hammer should be kept true and smooth, by careful grinding and polishing. Should the edges become chipped

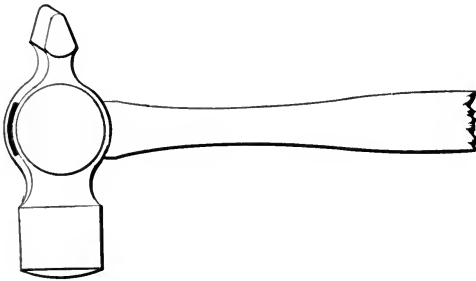

FIG. 3.

a good smith can dress and retemper the head, making it as good as new.

In its use the hammer should be grasped near the end of the handle, giving it a free arm swing and carrying the head through a nearly vertical plane. If the plane of the swing approaches a horizontal the weight of the hammer will produce a twisting effort on the fore arm which will be very wearing. The handle should be grasped with only sufficient force to safely control the blow.

Machinists' cold chisels, for ordinary shop uses, are generally made from seven-eighths or three-fourths inch octagonal steel, and when new should be about eight inches long. The flat surfacing chisel, as shown in Fig. 4, should be dressed about three inches back from the cutting edge. The flats AA should be plane surfaces symmetrical with the sides of the octagon. The

thickness of the bit at C should not exceed three-sixteenths inch for ordinary work and can usually be made somewhat thinner. Care must be exercised in the grinding of the facets c c. The angle of their faces with each other will depend on the hardness of the metal to be cut. For the softer metals, as copper, babbitt and lead, 25 degrees to 30 degrees will work well; for brass and

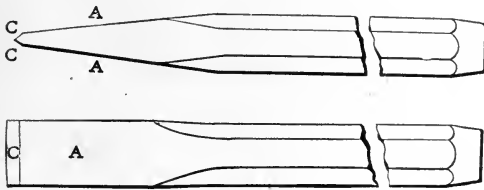

FIG. 4.

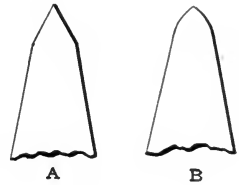

FIG. 5.

cast iron, 40 degrees to 55 degrees; and for steel, 60 degrees to 70 degrees. The smaller this angle the more nearly will the center line of the chisel approach the plane of the work and the greater will be the cutting resultant of the blow. It is therefore advisable to make this angle as small as the nature of the work will permit. These facets should be ground straight in their width, as shown at A, Fig. 5; not rounded as shown at B, as in that case the facet would not form a guide and it would be found difficult to

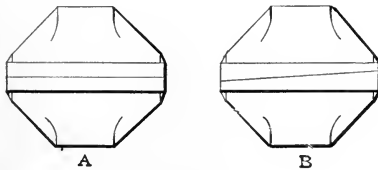

FIG. 6.

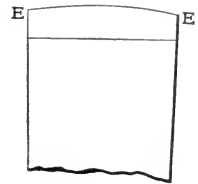

FIG. 7.

make a smooth, straight cut. The facets should also be ground at a uniform angle with the flats, thus bringing the cutting edge parallel with the flats, as shown in end view at A, Fig. 6, and not as shown at B. The cutting-edge formed by the intersection of these facets should be at right angles to the length of the chisel. For smooth chipping the cutting-edge should be slightly rounded in its length, as shown in Fig. 7. When ground straight the corners, e e, are likely to dig into the work and are more apt to break away than when ground rounding.

In forging, the cutting-edge should always be made wider than the diameter of the body of the chisel. When the tool is to be used on wrought iron or steel this width should exceed the diameter from one-thirty-second to one-sixteenth of an inch, Fig. 4; but when for use on the softer metals the excess may be as much as one-half of the diameter of the body, as shown in Fig. 12.

The flat chisel can be modified in form to suit special conditions, as for example, the cutting of the flat sides of a mortise requires a chisel the axis of which will follow a line nearly parallel to the work surface. Such a chisel is shown in Fig. 8, in

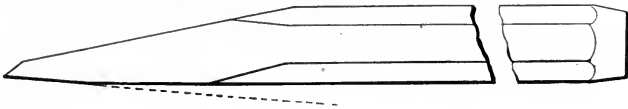

FIG. 8.

which one flat is parallel with the length of chisel having at the end a wide facet at a slight angle with the length, this in order to be able to guide and control the cutting-edge of the tool.

The cape chisel is used as a parting tool, for grooving and key waying. It is of the general form shown in Fig. 9. In this

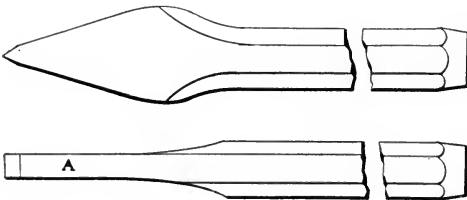

FIG. 9.

chisel the thickness at A must be less than the length of the cutting-edge in order that the tool can be given a small amount of side-motion in the groove it cuts, otherwise it would be difficult to guide the cutting-edge. This chisel, when made as shown in Fig. 10, forms the tool usually used for grooving straight oil ways

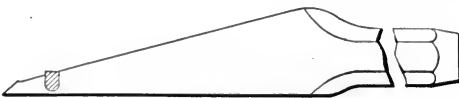

FIG. 10.

in loose pulleys and shaft-bearings. For cutting spiral grooves in half boxes this chisel should be forged with a curved instead of a straight bottom face.

The diamond-pointed chisel is shown in Fig. 11. This tool is

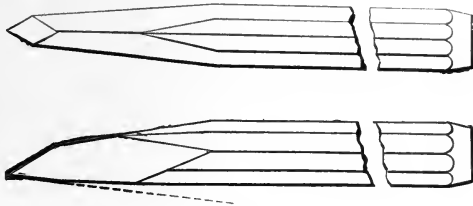

FIG. 11.

usually used for squaring corners, and is generally made as shown in figure.

The head of all chisels should be dressed round and somewhat reduced in diameter, as shown in figures. When the head becomes battered redress it, as small pieces of steel are apt to fly from a bushed chisel head, embedding themselves deeply in the hand holding the chisel.

In using the cold chisel grasp it near the head with the full hand, knuckles up. Do not hold it too tightly but with sufficient force only to guide and hold it to the work. When the surface of the work is difficult to get at the workman is justified in holding the chisel between thumb and fingers, or with palm of hand up.

The eye should follow the cutting-edge, not the head of the chisel, when delivering the blow, and light taps with the hammer should not be used before each heavy blow. It will require

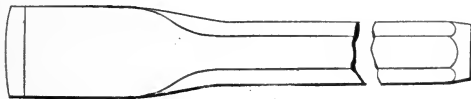

FIG. 12.

some practice before the beginner can accomplish this without disastrous results to his knuckles.

In tempering the chisel for general machine shop work it should be drawn nearly to a blue which gives a tough temper that will stand well on all, except chilled iron and hard steel work.

CHAPTER II.

THE FILE AND FILING.

A piece of high-grade crucible steel, forged to shape, ground, cut and carefully tempered, forms that tool so indispensable to the mechanic—the file.

The file maker is no longer compelled to forge his blanks from stock of unsuitable proportion, but receives from the steel manufacturers stock of the required cross-section to make all standard shapes. This reduces the forging to a minimum, it being only necessary to cut the stock to the required lengths, to draw down the point and form the tang, the latter operations being very rapidly performed under power hammers.

The National Association of File Manufacturers prescribe to

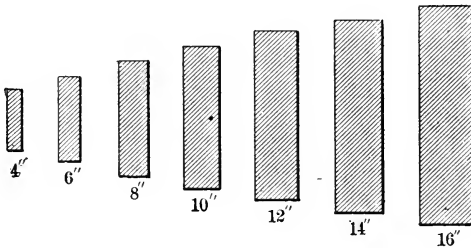

FIG. 13.

the steel makers the forms of cross-sections they require. Consequently, all makers of file steel can furnish any section correct to gauge. In Fig. 13 are shown the correct cross-sections of steel for flat files, even inch lengths, from 4 to 16 inches. In Fig. 14 are shown the cross-sections of file steel for all the shapes in general use. Each section is for an 8-inch file, full scale. The names of the files made from steel of these sections are, referring to the numbers of the figure: 1, "Hand"; 2, "Flat"; 3, "Mill"; 4, "Pillar"; 5, "Warding"; 6, "Square"; 7, "Round"; 8, "Half-round"; 9, "Three-square"; 10, "Knife"; 11, "Pit-saw"; 12, "Crossing"; 13, "Tumbler"; 14, "Cross-cut"; 15, "Feather-edge"; 16, "Cant-saw"; 17, "Cant-file"; 18, "Cabinet"; 19, "Shoe-rasp"; 20, "Rasp."

It will be noticed that many of these files are named from the form of their cross-section, and that those so named are the ones most used for general work; while the others receive their names from the special character of the work they are expected to be used upon. It will also be noted that the stock for files of rectangular cross-section may be classified as to thickness as follows: "Square," the thickest; "Pillar," "Hand," "Flat," "Rasp" and "Warding." As to width, "Hand" is the widest; "Flat," "Rasp," "Mill" and "Warding" are the same width; "Pillar" materially narrower, and "Square" the narrowest.

The "Half-round" is not a full semicircle, the arc being about

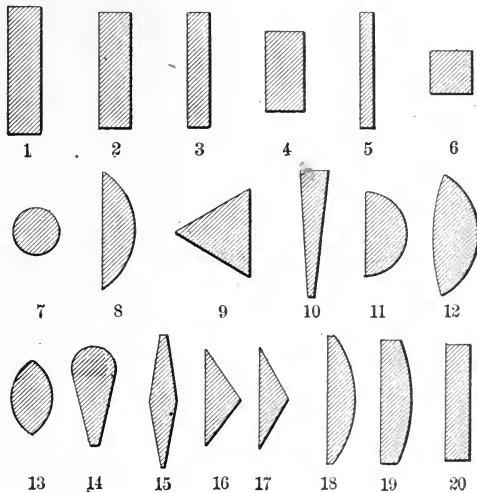

FIG. 14.

one-third of the full circle. On the other hand, the "Pit-saw" is a full half circle in section.

The "Three-square," "Cant-saw" and "Cant-file" differ in section in their angles, the former having equal angles, 60 degrees, and equal sides, the next 35—35 and 110-degree angles, and the latter 30—30 and 120-degree angles.

The length of the file is measured from point to heel, and does not include the tang. The tang is usually made spike shaped to receive a plain ferrule handle. Some makers modify the form of tang to fit patented handles.

As forged, the blank for a "Hand" file, Fig. 15, is parallel in

thickness from heel to middle and tapered from middle to point, making the point about one-half the thickness of the stock. The edges of the blank are usually left parallel. They are, however, sometimes drawn in slightly at the point.

The "Flat" file blank, Fig. 16, is parallel in both of its longitudinal sections from heel to middle and tapered in both sections from middle to point, the thickness of point being about two-thirds, and width about one-half that of the stock.

For the "Mill" file the blank is parallel in thickness from heel to point, and usually tapered to about three-fourths the width



FIG. 15.



FIG. 16.

of the stock. The "Mill" file is often made blunt—that is, of equal width and thickness throughout its length.

The blank for the "Warding" file is tapered in width from heel to point and is of uniform thickness. Aside from width, the "Pillar" file is similar to the "Hand" file. The "Pillar" file is also made in narrow and extra narrow patterns, the extra narrow approximating a square in section.

The "Three-square," "Square" and "Round" are also made in slim and blunt forms. The "Slim" is a file of regular length, but smaller cross-section, and the "Blunt" of equal cross-section from heel to point, being either "slim" or regular.

After forging, the blanks are thoroughly annealed in annealing

furnaces, the operation taking from twenty-four to thirty-six hours. When the blank comes from the furnace, it is twisted and scaly, and must be subjected to a straightening process, after which the scale is removed by grinding on very heavy grind-stones. The blanks are next draw-filed to make them perfectly smooth and even, after which they are ready for the cutting.

Files are classified under three heads—"Single-cut," "Double-cut" and "Rasp." The "Single-cut" file—or "Float," as its coarser cuts are sometimes called—has surfaces covered with teeth made by single rows of parallel chisel cuts extending across the faces at an angle of from 65 to 85 degrees with the length of the file. The size of this angle depends on the form of the file and the nature of the work it is to perform.

The "Double-cut" file has two rows of chisel cuts crossing each other. The first row is, for general work, at an angle with

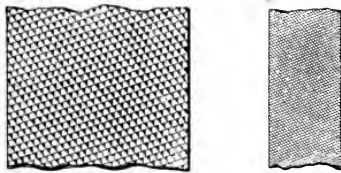

FIG. 17.

the length of the file of from 40 to 45 degrees, and the second row from 70 to 80 degrees. In the "Double-cut" finishing files the angle of the first cut is about 30 degrees, and the second from 80 to 87 degrees with the axis of the file. The "Double-cut" gives a broken tooth, the surface of the file being made up of a large number of small, oval-pointed teeth inclined toward the point, and resembling in shape the cutting end of a diamond pointed cold chisel.

In the rasp the teeth are entirely disconnected from each other. They are round on top, and are formed by raising, with a punch, small portions of stock from the surface of the blank. The machinist seldom has use for a rasp, as they are intended for filing the softer materials, as wood and leather.

The regular grades of cut upon which the coarseness of a file depends are "Rough," "Coarse," "Bastard," "Second-cut," "Smooth" and "Dead-smooth." The "Rough" file is usually

single cut and the "Dead-smooth" double cut. The other grades are made in both double and single cut. These grades of coarseness are, however, only comparable when files of the same length are considered, as the longer the file in any cut, the fewer the teeth per inch of length. This is shown in Fig. 17, where a 4-inch and 12-inch "Bastard" file are placed side by side for comparison.

The relative degrees of coarseness for the different cuts are

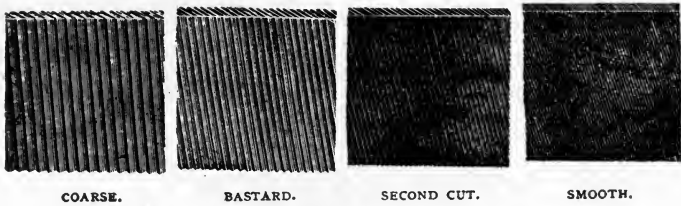

FIG. 18.

shown, for the "Single-cut" in Fig. 18, and the "Double-cut" in Fig. 19, a portion of an 8-inch file being taken in each case.

The value of a file depends entirely upon three things—quality of stock from which it is made, the form of its teeth and the temper. The stock should be of the very best, as tool steel is seldom put to any use where its lasting qualities are more severely taxed.

As to the forming of the teeth: It is only within the past few

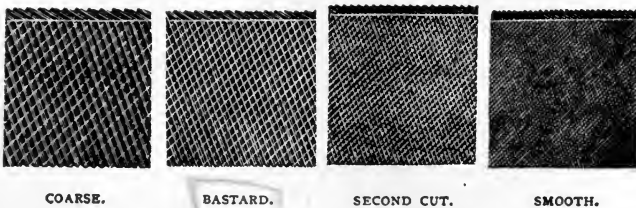

FIG. 19.

years that machine-cut files have come prominently upon the market, it being generally believed that a file to be first class must be hand cut. In Fig. 20 are shown portions of two 14-inch flat "Bastard" files; of these one is hand and one machine cut. The difference between these cuts is so slight that only an expert,

with the files rather than their pictures before him, could tell, with any degree of certainty, which was the hand and which the machine cut.

Up to the time of the perfecting of the increment cut file, the great trouble with machine-cut files was in the perfect uniformity of the teeth. In a hand-cut file the width and spacing of the teeth depend entirely upon the skill of the workman; and no matter how carefully he does the cutting, irregularities of a thousandth of an inch, more or less, will occur in the spacing and in the angle at which he holds the broad chisel that forms the teeth. These slight variations will cause the teeth to be of uneven height and irregular outline. These irregularities are now very faithfully reproduced in the increment, machine-cut file.

It is difficult to make a file having teeth of uniform height and

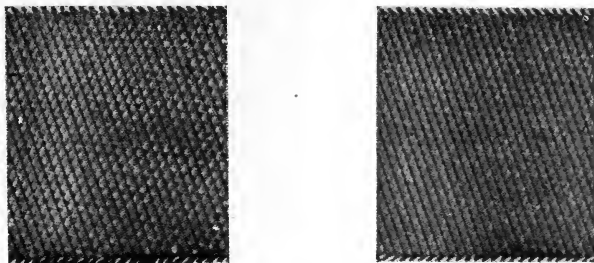

FIG. 20.

outline, as in the case of the ordinary machine-cut file, take hold of the work. The reason for this is that so many teeth present themselves to the work surface that the workman must exert great pressure on the file to make them bite. With the file having teeth of irregular height, fewer will come in contact with the work, and the pressure required to make them take hold will be correspondingly light. As these long teeth wear down, the shorter ones will begin to do work; but the file will, of course, not cut so freely as when new. Again, in using the file with teeth of uniform height, it will, when pushed to the work, produce, at the start, grooves which will grow deeper as the file is moved forward, and, due to the broad cut, will be quite certain to vibrate and "chatter." On the other hand, the uneven teeth of the hand and increment cut files, will so adapt themselves to the

surface of the work that only a few teeth at any particular point in the length of the file will cut. The metal left between these teeth will be removed by the teeth following, perhaps a dozen or more rows of teeth being required to finish the cut started by one. This is shown, for a "Single-cut" file, in Fig. 21, where

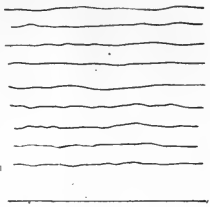

FIG. 21.

the several irregular lines represent as many tooth outlines drawn on an exaggerated scale. These teeth come successively to the work, and if all their high points were brought together they would form a straight line, as shown, which would be the outline of the resulting cut.

The cutting of an increment cut file consists in the forming of the teeth by a chisel operated in a machine, and so controlled that the spacing between teeth may be increased or decreased, the same being subject to a small amount of irregularity, as well as a slight variation in the angle of the teeth with each other. As manufactured by one company, the spacing of the teeth from point to middle is increased, and from middle to heel decreased. Another leading manufacturer increases the pitch from point to heel. It will be understood that the increment of space is very small. In a 12-inch "Bastard" file, having teeth spaced progressively wider from point to heel, the pitch of teeth at heel is about .01 of an inch greater than at the point, which makes the average increase per tooth about .00003 of an inch.

In machine-made files the cutting is very rapidly performed, the chisel receiving from 500 to 3,500 blows per minute, depending on the weight of the file being cut. The blank is cut from point to heel, and when turned over is placed on lead strips to protect the teeth already formed.

After cutting, the files are inspected and assorted as to quality. They are then tempered, any material change in shape due to hardening being rectified at the time of tempering, after which they are ready for final inspection. This consists of trying each file on a piece of hard steel and making sure that it is free from temper cracks. They are next coated with oil and wrapped in oiled paper, to prevent rusting, after which they are packed in boxes, ready for the market.

The teeth of a file remove metal by a shearing cut. This is most apparent in the "Single-cut" files, where the teeth have

lateral length; but is equally true of the pointed tooth of the "Double-cut" file.

A file bites freer on work having a narrow surface than a wide, because fewer teeth come in contact, at any point in the stroke, with the work surface, and consequently less pressure is required to make the file bite. On very thin work the teeth of a "Double-cut" file bite so freely that the danger of breaking them is great. For work of this character the long tooth of the "Single-cut" is best adapted, as its form gives it greater strength, and the shear of the cut is smoother, one tooth coming into cut as another leaves. On the broad surfaces, however, the teeth of the "Double-cut" have the advantage.

A file is "tapered" when it is thinner at the point than at the middle, and is "full tapered" when thinner at point and heel than at the middle. The reasons for thus tapering a file are, first to

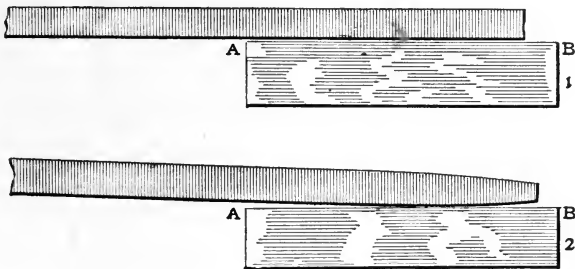

FIG. 22.

reduce the number of teeth that come in contact with the work, and, second, to enable the operator to file a straight or plane surface. The first reason is evident; the second is shown in Fig. 22. If the file is perfectly straight, as shown in 1, the motion in order to produce a plane surface on the work must be absolutely parallel to this surface. This the most expert mechanic can scarcely be expected to do, and the result will be work rounded at the edges A and B. If the file is tapered, its surface will be slightly convex, as shown in 2, and if moved entirely across the surface, straight work will result. The workman will experience little difficulty in accomplishing this, as he can allow the motion of the file to deviate slightly from a straight line, and still not cut away the edges A and B. If the file is not moved clear across the work, a concave surface will of course result.

The tempering is certain to distort the file somewhat, and it will, as a result, usually be found to have more "belly," as this convex quality is called, on one side than on the other. It is the side having the most "belly," and the highest part of that, that the careful mechanic will always select for use in his most particular work. This high point he readily finds by running his eye along the edge of the file from point to heel.

The file does not bite the cast metals as readily as it does the rolled, consequently a sharper file is required for cast iron and brass than for wrought iron and steel. For these reasons the new files should be first used on the cast iron and brass, and when they become too dull to work these metals efficiently, they may be used on the steel and wrought work. A new file will pin and tear the surface of these latter metals much worse than the file that has seen a moderate amount of duty on cast iron and brass. A new file will leave a smoother surface after it has been used for a few strokes, these strokes causing the high teeth to give down a little, which prevents the danger of their scratching the work.

The first dozen strokes of a new file on a tough piece of steel frequently lessens its cutting value as much as an hour's steady use on soft cast iron, yet not seriously injuring it for the steel work. Narrow surfaces are exceedingly hard on new files, and especially so on the double cuts, as but few teeth come in contact with the work, and they bite so freely that they are broken off by the excessive strain.

Not until the file becomes too dull to be used efficiently on the narrow steel work should it be used on the scale of cast iron or forgings, as this scale is frequently harder than the file.

The term "cross-filing" applies to those filing operations in which the file is pushed endwise across the work. When in cross-filing the character of the work requires a heavy file, it should be held in both hands, as shown in Fig. 23, the end of the handle abutting against the palm of the hand, thus giving a good bearing to receive the thrust on the work stroke. When held in this manner an extremely tight grip is not required, which makes it much easier on the fingers and enables the workman to more readily control the file.

When a very light file is being used on the work it is usually best to hold it with one hand, as shown in Fig. 24. In this case the thumb rests against the side of the file just ahead of the handle,

and the fore finger extends along the top, considerable downward pressure being exerted by this finger, as near as possible, over the working surface of the tool.

When the file is of medium size and thin, if held as shown in Fig. 23, the pressure at the ends will bend it down, making

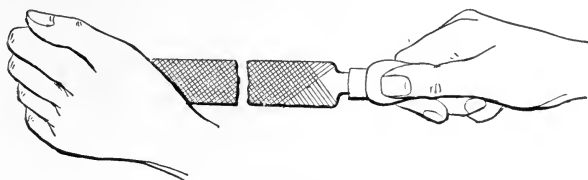

FIG. 23.

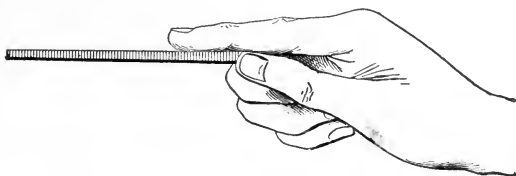

FIG. 24.



FIG. 25.

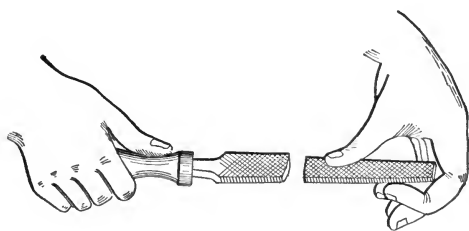

FIG. 26.

it concave on its under surface, which will cause it to cut away the metal at the edges, as shown in Fig. 25. If, however, it is held as shown in Fig. 26, the downward pressure of the thumb will spring the file in the opposite direction, and thus enable the

operator to move it across the work without cutting away the edges. When the thumb becomes tired, the position shown in Fig. 23 can again be taken, the ball of the thumb bearing down hard on the file and the fingers lifting at the point accomplish the same object. Either of these methods of holding is difficult to maintain for more than a few moments at a time, consequently a stiffer file, having considerable belly, is preferable on work of this character.

The value of a good file handle should be appreciated. It should be of good size, well formed, smooth, properly ferruled and, most important of all, so secured to the tang that its center line is parallel with the length of the file. Handles made of soft, tough wood are preferable, as they are lighter and less liable to crack when forced on the tang. The soft-wood handle, if provided with a hole for the reception of the tang of a diameter slightly greater than the thickness of the tang, can be driven on without danger of cracking. If of hard wood a good job requires heating the tang red hot and burning the hole in the handle to fit it. Care must be exercised, or the temper of the teeth near the heel will be drawn. A piece of wet waste wrapped around the heel will prevent this.

When the work surface is so broad that the file cannot be held, as shown in Fig. 23, on account of the handle striking against the edge of the work, a surface file holder must be used. In Fig. 27 is shown such a holder. The bottom of the handle is pro-

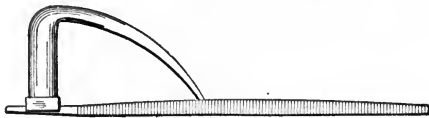

FIG. 27.

vided with a tapered, dove-tail slot to receive the tang, the outer point resting on the top of the file. Before applying the handle file the edges of the tang to approximately fit the dove-tail slot, as this may save a jammed set of knuckles. In using a file with this holder, the fingers of the left hand, resting on the top of the file, must give nearly all the pressure necessary to make it cut.

The form of surface file holder shown in Fig. 28 possesses the advantage of giving the operator a handle similar in shape and position to that used on ordinary narrow work. The rod en-

ables the left hand to so grasp the point of the file that the downward pressure may be applied with less fatigue to the hand than in the case shown in Fig. 27. When the handle is screwed tight against the shoulder, the rod draws up on the point, thus tending to give the file more curvature, an advantage of considerable moment in filing accurate plane surfaces.

Ordinarily the surface of the work on which the file is to be used should be held at the height of the workman's elbow, thus allowing the direction of motion of his forearm to be in a line parallel with the plane of the work surface. This position of the work allows the workman's arm to swing freely at the shoulder with the least possible amount of motion at the wrist and elbow. If the work surface is broad it should be held somewhat lower than the elbow, thus enabling the workman to more easily reach over the entire surface. If, on the other hand, the work is of a fine character, depending largely on the eyes and a delicate touch, it should be held much higher. For work of this character the file is usually held in one hand and the high position of



FIG. 28.

the work prevents the fatigue incident to a bent position over fine work.

For heavy cross-filing, which requires a considerable amount of pressure on the file, the workman should stand slightly back from the work with one foot considerably in advance of the other. On the forward, or work stroke, the pressure exerted on the file should relieve the weight on the forward foot, the rear foot bracing against the stroke. On the return stroke the forward foot should again take its portion of the weight, and the file should be relieved from all pressure, but not raised from the surface of the work. Only at such times as it is necessary to examine the condition of the surface being operated upon should the file be taken from the work, its removal for cleaning, however, being excepted.

The workman's body should, in heavy cross-filing, move back and forward with the strokes, thus making the back and legs do a part of the work that would otherwise come entirely on the

arms. When the work is of a lighter character and the quality of the finished surface rather than the quantity of metal removed must be considered, the workman should stand in an upright position, doing most of the work with his arms.

In cross-filing, and more especially where much metal is to be removed, the direction of the strokes should be varied frequently. This not only enables the production of truer work, but faster reduction of the metal. The file when pushed end-wise produces small grooves or channels in the direction of the stroke, and when the direction of the stroke is changed the file teeth come in contact with the tops of the ridges between the grooves, thus diminishing the area of tooth contact with the work surface, and consequently increasing the bite; that is, for equal pressures.

In cross-filing the file should be held at quite an angle with the direction of the stroke, which has the effect of giving the file a side motion as it is swept forward. This improves the

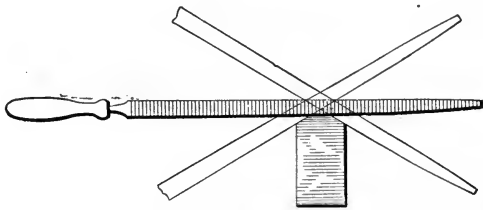

FIG. 29.

condition of the surface filed, prevents to a marked degree deep grooving and brings the file under more perfect control.

When the surface is narrow and a large amount of metal is to be removed quickly, the angle at which the file is held may be changed, as shown in Fig. 29. As the contact area is small in this case the bite is free. A new file should never be used for this purpose, as the teeth will take hold so freely that they will break off or at least lose their keen cutting edges very quickly. This is much more disastrous on the delicate points of the double cut than the long teeth of the single-cut files. Work of this character should be held close down to the top of the vise jaws, thus preventing chattering.

In selecting a file for any piece of work the form and position of the work surface must determine the shape and size of the file

to use. The hardness of the metal and the amount of stock to be removed, together with the quality of the finished surface that is desired will determine the degree of coarseness in the cut of the file used.

If the surface is a flat one, the hand file, the curvature of the sides of which makes it best suited to such a surface, or its immediate associates, the flat, mill or pillar files, will be used. The length will depend upon the extent of the surface, files shorter than 8 inches being used only on very light work and for the heaviest work seldom exceeding 18 inches in length.

If the surface is an interior one, as is the case with the walls of a mortise or key-way, the pillar or square file will usually be used. The pillar file provided with one safety edge it best suited to this work when the dimensions of the work will admit of its use. The extra narrow pillar can usually be used in any slot in which a square file of same length can be operated. If the

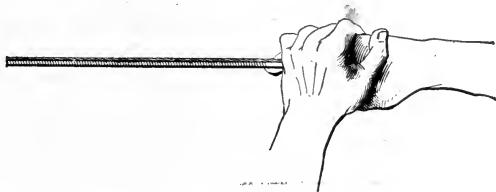

FIG. 30.

opening is very narrow a warding file may be advantageously used. As this file is very thin and of equal thickness from point to heel, the operator must depend on springing the file enough to give the required curvature for true filing.

In filing square or round holes as large a file as can be freely operated in the openings should be used, and if very small a slim square or round may be used, which gives the same file length, but smaller cross-section, thus enabling the use of the longest file possible. If the hole is short as compared with the length of the file, the latter may be held at point and handle and still allow enough length for a suitable stroke. When, however, the hole is a long one, the file must be held as shown in Fig. 30. If the round file is materially smaller in diameter than the hole it is enlarging, as shown in Fig. 31, it will be difficult to keep the hole even approximately round; but if larger, as shown dotted, better results can be obtained, inasmuch as the arc

of contact is very much greater. Ordinarily work of this kind does not require great circular accuracy.

When the curvature becomes too great to admit the use of the round file, the half round takes its place. With the larger circles it is not possible or even desirable to have the round side of the

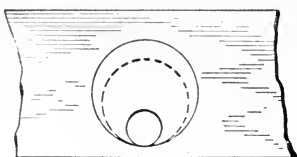

FIG. 31.



FIG. 32.

file fit the curve, but the results required are in such a case obtained by giving the file a side sweep on the forward stroke. Thus in Fig. 32, when the file is given only a back and forward motion, it is impossible to maintain the smooth curve, but if, as shown in Fig. 33, the file is swept sidewise on its forward

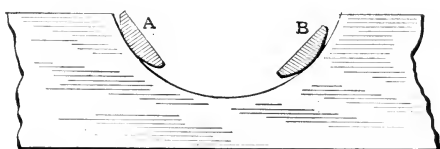

FIG. 33.

motion from A to B, and after every few strokes reversed, so as to give the sweep from B to A, thus causing the file marks to cross each other, true work can be obtained. The file should, as with the hand file, be well curved in its length, so that any portion of the surface may be brought into action. It should be

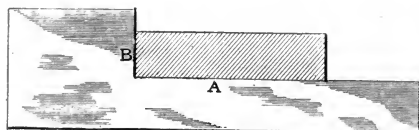

FIG. 34.



FIG. 35.

given a slight rotation in the hand as it is pushed forward in order that the same high spot may cut through the entire stroke.

A safety edge on a file is one having no teeth. The safety edge enables the mechanic to file one of two surfaces A, intersecting at right angles, without injuring the other B, as shown in Fig. 34. The safety edge on a new file should always be passed over

a grindstone or emery wheel before depending on its "safety," as in the cutting of the sides the stock is expanded over the edge, making a slight concave, as shown at A, in Fig. 35. While the points of the teeth do not, in cutting, form out full over the safety edge, the roots of the teeth do, and they are very apt to scratch the surface the edge is expected to protect. A very satisfactory safety edge is made by grinding the teeth from the edge of a full cut file.

As the teeth of files of rectangular cross-section are not fully formed at the corners, it is not possible to file a full square with them, since the rounded corners of the file leave a small fillet in the angle of the work. By grinding a safety edge on a full-cut file, teeth projecting to the extreme corner will be obtained, and the angle of the work can be completely formed. As these corner teeth are very delicate, they must be used only for the finishing strokes, which virtually limits this file to that one operation, as only the edge or the side opposite the safe edge can be used for other work without injury to the corner teeth. It will usually be found quite satisfactory to finish these corners with the edge of a small finely cut half-round file, used as shown in Fig.



FIG. 36.

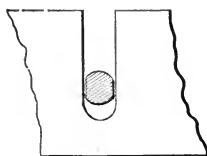
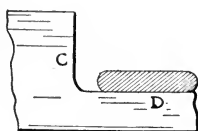

FIG. 38.

36. By canting the file slightly and using a reasonable amount of care, good results will be obtained in this way.

A carefully filleted corner, as shown in A, Fig. 37, is difficult to obtain. A flat or square file used on surface C and D is very apt to get into the fillet, and if a safety edge is used, leaving the work as shown in B, Fig. 37, considerable difficulty will be had



A

FIG. 37A.

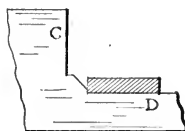

B

FIG. 37B.

in bringing down the corner with a round file without its cutting into the faces C and D. A flat file with rounded edges and the teeth ground from one side makes a good file for work of this character when the curvature of the file's edge conforms reasonably close with the curve of the fillet. The faces C and D after being finished will not be injured in the use of the safety side file. The faces will steady the tool, and its round edges will form the corners, it, of course, being worked in from each side of the angle.

When the end of a slot or mortise is to be filed circular the round file usually does the work. As there is difficulty in preventing the round file from cutting into the sides of the slot, it will be found advantageous when much of this work is to be done to take a round file somewhat larger in diameter than the width of the slot, and grind flats on opposite sides, making it narrow enough to work freely in the slot, as shown in Fig. 38. When, however, the ends of the slot are formed by a drill and reamer, and the sides filed down to the dotted lines, as shown in Fig. 39, the edges of the file should not only be safe, but rounded, as shown, to prevent the corner teeth from gouging into the curved ends.

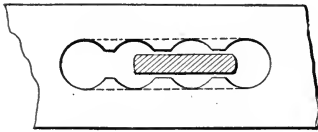

FIG. 39.

Correct methods of holding work for filing must not be overlooked. If the work is large and heavy, it will simply require suitable, rigid support to bring it to the proper height to be operated upon. A very large percentage of the work will be held in a vise. It is important that the work surface be as close down to the top of the jaws as possible, in order that it can be rigidly held.

If the work must be held by its finished surfaces, smooth vise jaws should be used. As it would be impossible to keep the jaws in this condition false jaws must be used between the work and the vise jaws. These can be made of soft copper or sheet lead, pounded into the proper form to fit nicely over the jaws. The spring vise jaw shown in Fig. 40 is well adapted to this purpose. Paper fiber faces applied to these jaws are excellent when the surface of the work caught is large enough to distribute the pressure over the face fairly well.

When a large amount of bevel filing is to be done some form

of jig or clamp should be used to hold the surface filed in a horizontal plane, as shown in Fig. 41.

If very thin work is to be filed on its faces, it will not be possible to hold it in the common vise, as the top edges of the jaws

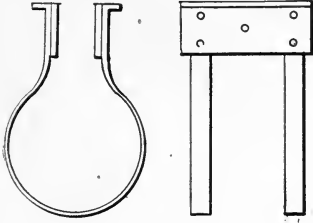

FIG. 40.

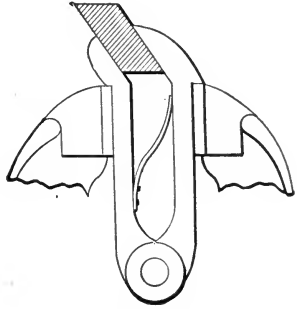

FIG. 41.

are usually worn rounding, and the work is frequently of irregular outline. It may be secured to a block of hard wood by bradding around its edges, and the block held in the vise. The brads will file down with the work, and the flat surface prevents the work from springing.

The term "draw filing" refers to that use of the file in which the direction of its motion over the surface of the work is at right angles to its length. In draw filing the file is grasped by its ends with both hands, as shown in Fig. 42. The handle is usually

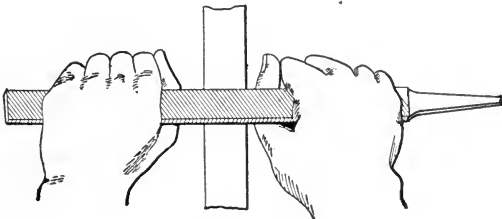

FIG. 42.

removed, as the file cannot readily be controlled when one hand grasps the handle.

As the belly of the file can be brought to bear on the high spots more readily and under better control than in cross filing,

more accurate results can be obtained by draw filing, even by a less skillful mechanic. For a given pressure, the file in draw filing does not cut so deep or remove so much metal as in cross filing. It is not, therefore, well adapted to the quick removal of large amounts of metal, but when an accurate surface or a finely finished one is required, it can best be obtained by draw filing. The grain or lay of the finish produced by draw filing will be in the direction of the strokes, and much finer than can possibly be obtained with the same file in cross filing.

When a surface is to be reduced wholly by filing, a second cut or a smooth file should be used in cross filing to remove the deep file marks made by the rough or bastard file, which is used to remove the bulk of the metal, thus producing a smooth surface for the final draw-filing operation. A file coarser than a second cut is not suitable for draw filing.

In modern practice nearly all surfaces that are to be finished are machined smooth, true and practically to size, so that draw filing alone will remove all tool marks and prepare the surface for polishing, or scraping, if it is to be an accurate bearing surface. In general, machined surfaces should be filed as little as possible in producing the required finish. If filed too much, the surface becomes untrue, and can be brought back only at the expense of much time and careful work. It is very important in machining surfaces that are to be accurately finished by filing to make the finishing cut a light one, with the cutting tool so adjusted as to leave a smooth, true surface, and thus requiring the minimum amount of filing.

After draw filing, the surface is usually given a finish by rubbing it down with fine emery cloth and oil. For this operation the emery cloth is secured to a narrow block of wood, or wrapped around the file. In either case it is given the same motion as for draw filing. When a very fine finish is desired the surface is first draw filed in the direction of the lay of the final finish, with a smooth file. The direction of the strokes is now changed to right angles, with the required finish, a dead smooth file being used. This latter cut serves to level off the tops of the small ridges left by the first filing. The final finish will be obtained by rubbing the fine emery and oil over the surface in the direction of the first filing. A piece of clean leather, charged with washed emery and oil, is excellent for this purpose.

When a concave surface is to be draw filed, the half round

smooth or second cut file should be used, as shown in Fig. 43. The file should be rotated slightly in the hands, so as to bring different portions of its surface into action. It is best to give it a small amount of end motion, just enough to cause the file marks to cross each other.

In draw filing convex or cylindrical surfaces, a flat file or the flat side of a half-round file will usually be used. Such surfaces are generally so filed to produce finish only, and when cylindrical truth is required must be very carefully done. As shown in Fig. 44 the file surface in contact with the work is very narrow, and consequently the pressure on the file must be very light. As shown by the dotted lines, the angle of the file with the horizontal should change slightly, yet a uniform amount, with each stroke.

In the draw-filing operations the work should be done on the

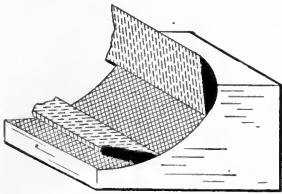

FIG. 43.

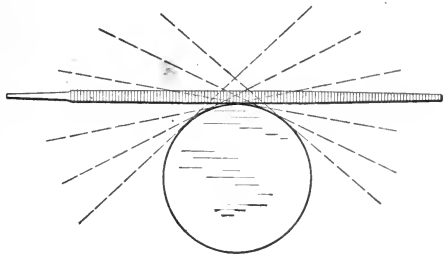

FIG. 44.

forward stroke, the file being relieved of all pressure, but not raised from the surface of the work, on the return stroke.

In the filing of rotating work, as between centers in a lathe, there is danger of too high a cutting velocity. This is especially true when the diameter of the work is large. The tooth of a file, like any other cutting tool, will give down if made to do its work too fast. As practically all filing of this class is upon work that has previously been machined round and smooth, files coarser than the second cut are little used, the smooth meeting most requirements.

This class of filing operation is for two general purposes; first, to reduce by a small amount the diameter of the work, and second, to finish or prepare its surface for finish. When accurate cylindrical truth is required, it is very important that only a small amount of filing be done on the work, as it is impossible to file

any considerable amount from its surface without throwing it out of round. The finishing cut in the machining should, therefore, be as smooth as possible, and very close to the exact finish diameter. The danger of filing work out of round increases as the speed of rotation decreases. That is, if the work is of small diameter and makes a number of revolutions per stroke of the file, the surface will be nearer round than when only a few turns are made per stroke. When the work diameter is large, making the rotation slow, it is practically impossible to file equal amounts from all parts of the surface, inasmuch as parts of the surface of the work are quite certain to come under the action of the file more frequently than others. It is best in filing this class of work to give the file a comparatively slow stroke, and as long a one as possible.

It must be remembered that, ordinarily, the motion of the file to the work in cross, or draw filing, is comparatively slow—say forty strokes per minute of perhaps eight inches each. As the file is cutting only about one-half of the time, the actual velocity of cut in such a case would be not far from fifty feet per minute. The intermittent motion of the cut prevents the teeth from becoming extremely hot.

In filing revolving work, the number of strokes per minute will not be so great, but the length of the stroke will be somewhat increased. This will give practically the same cutting speed, due to the motion of the file, as in cross filing. To this must be added the velocity of the work surface under the file, which will vary from fifty to one hundred feet per minute. In cross filing stationary work, only a short length of the file's surface is cutting throughout the stroke, which concentrates the work on relatively few teeth. In the filing of rotating work, however, nearly all of the file's length is brought into action at each stroke, which offsets largely the disastrous effect on the teeth, due to too high a cutting velocity.

The file must not be held stationary, allowing the work to revolve to it, as in that case a few teeth do all the cutting, and a grooved surface is quite certain to result. The file should be held as for cross filing, Fig. 23, and should, as it is moved forward over the surface of the work, be given a small amount of lateral motion. If a large amount of metal is to be removed the file should be pushed diagonally over the work, as shown in Fig. 45, the direction of the stroke being frequently changed,

thus causing the file marks to cross each other, which, as previously explained, causes the file to cut more rapidly and produce a truer surface than when continually moved in one direction. When, however, a nice finish is required, the stroke should be at

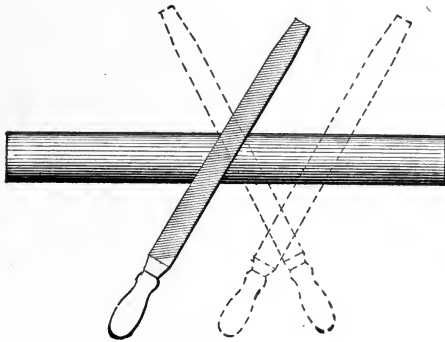

FIG. 45.

right angles to the axis of the work, as shown in Fig. 46, and should, as indicated by dotted lines, be kept parallel to this position, in its sweep from left to right.

In filing rotating work, as in the draw filing of cylindrical surfaces, the number of teeth in contact with the work surface at

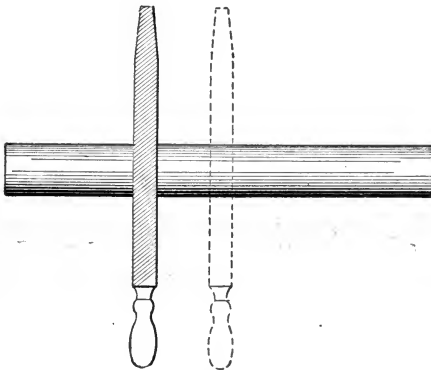

FIG. 46.

any instant is relatively small, consequently less pressure is required to make the file bite, other things being equal, than in the filing of plane surfaces. This feature also enables the use of files on rotating work, which, due to their concave surfaces, could

not be used on plane work. This affords an excellent opportunity for using up those files, or parts of files, which, owing to their warped condition, are unfit for careful work on plane surfaces.

In filing the face of a rotating disk the same care in the selection of the file must be used as for work on a stationary plane surface, only the high spots being available for this purpose. This, unlike the work on the cylindrical surface, concentrates the work on a small portion of the file's surface, and consequently the velocity of the work should be lower. For this class of filing the file must be held firmly, to overcome its tendency to move in and out on a radial line.

In the filing of all rotating work, and especially work having projections or irregularities, care must be exercised to prevent the file from catching in the work. For this purpose a file without a handle should not be used, as in the case of its catching it is very apt to drive back, forcing the tang into the operator's hand or wrist. Frequently, when the character of the work necessitates filing up close to the face plate, chuck, or driver, it will be found convenient to run the lathe backward, the operator standing at the back of the machine.

A file to do its work fast and well should be kept free from its cuttings. If the metal is of a non-fibrous nature, as with cast iron or brass, the cuttings pack solid between the teeth, thus holding the teeth out of the work and preventing the file from biting freely. A sharp blow of the file's edge against the vise back after every few strokes will remove most of these cuttings; if, however, too many strokes are taken before cleaning they lodge so finely that a file brush, as shown in Fig. 47, must be used



FIG. 47.

to remove them. These brushes are usually made of fine wire mounted in leather, and tacked to a light wooden back. A stiff bristle brush serves this purpose well, and for very fine-cut files is preferable to the wire.

In filing steel and wrought iron, the character of the ma-

terial reduces the disposition of the cuttings to pack between the teeth; but, under most conditions, a more serious trouble, that of "pinning" occurs. Cuttings "pin" when they lodge so firmly that they cannot be removed with the brush. Unlike the particles of cast iron, which crowd down below the cutting edges of the teeth, and do not injure the work, but simply retard the cutting of the tool, the pin usually stands well above the teeth and scores the work surface at every stroke. The "pin" can usually be removed by drawing the wire file brush firmly across the surface; those that resist this treatment being removed by the scorer. The scorer is simply a piece of soft wire flattened thin at the point, and carried broadside, rather than edgewise across the file surface. After a few strokes it becomes serrated and constitutes a short tooth comb, which picks out the pins quite easily.

Pinning may be somewhat reduced by chalking the surface of the file, which has also the effect of reducing its bite. A little oil on the file will frequently reduce the tendency to pin. It should be used, however, only on the fibrous metals, as it glazes the surface of the non-fibrous metals, making them harder to cut.

Chalk is usually applied to a file when a smooth, fine work surface is desired. The effect of the chalk is to prevent the teeth from cutting as freely as when it is not used, and thereby produces about the same result as would occur if a finer cut file had been used. It becomes necessary to rechalk the file after each cleaning, an operation requiring some time, and which can, by using the fine file, usually be avoided.

When oil has been used on a file it can readily be removed by thoroughly chalking and brushing two or three times, as the chalk soaks up the oil and leaves a dry surface.

In fine filing operations, where it is quite important to know the exact spot on the work surface where the file is cutting, the surface can be dimmed after every few strokes by passing the palm of the hand over it. The dry, soiled hand will deaden the surface enough to clearly show where the file cuts on its next few strokes, and will in no way injure the cutting of the tool.

Files are frequently injured by improper care while not in use. When boxed at the factory they are brushed over with oil and wrapped in oiled paper, which prevents them from rusting. When this oil has disappeared they will, if exposed to moisture, rust

readily. As there is a large exposed tooth surface the deterioration due to rust is rapid.

Files should never be thrown together in a drawer, or even allowed to come into contact with each other, or with other tools, as the delicate edges of the teeth are most easily broken down, and the value of the file seriously impaired. They should be kept in a drawer, separated from each other by low partitions, and arranged according to length, section, cut and condition, thus facilitating the selection of any desired file.

Any form of file rack, in which the file hangs from its handle, is satisfactory. The tendency is for files to accumulate, a large number that are nearly worn out littering up the file drawer or rack, injuring the good ones and doubling the time required in selecting a file for any piece of work.

A number of these partially worn files are quite necessary in the file drawer of the mechanic who is engaged on work of a general character, as he will very carefully avoid putting the new or better ones on the hard scale of castings or forgings.

The machinist should at all times exercise good judgment in the selection of the proper file for any piece of work as he cannot otherwise expect to get economical results from the files he uses. Except in cases where his work is all of one character he will experience little difficulty in so selecting that he will always be able to use his partially worn files to good advantage on much of his work, thus saving the new ones for the best work.

The broad surfaces of cast metals require the sharpness of the new file to properly cut them, while the narrow surfaces are readily cut by the somewhat dulled teeth of the file that has seen a moderate amount of service. Steel and wrought work will reduce the file to a condition where its further use is uneconomical except as it may serve to protect the better ones by being used for cutting thin, hard materials and removing fins and scale from castings and forgings.

Thin castings, and especially the fins on them, are quite apt to be chilled, making them harder than the file, a condition not conducive to the health of that tool. The sand must be thoroughly removed from castings before applying even the poorest file, as otherwise, the grindstone action will soon render the file absolutely useless.

The sand can be largely removed by brushing, but the scale only by a chemical treatment which softens rather than removes

it. This process, commonly known as pickling, consists in the washing or soaking of the castings in a blue vitriol solution, or dilute sulphuric acid. The length of time the casting should remain in contact with the pickling solution depends on the strength of the solution and the degree of softness required. They should be thoroughly washed off with water when taken from the bath and after drying the scale can be brushed with a wire scratch-brush or rattled off. When the castings so pickled are to be finished on any of their surfaces by painting, it is important that they are thoroughly cleaned, as otherwise the scale will eventually flake off, taking the finish with it. In such cases the castings when removed from the acid bath should be thoroughly soaked in a neutralizing bath of strong, hot soda or potash water. They can then be rinsed in hot water and dried.

Pickling operations should be performed in a well-ventilated room, or preferably in the open air, as the fumes are poisonous, and in the case of sulphuric acid, explosive when mixed with the proper proportions of air. The pickling vats if of iron must be lined with sheet lead. Vats of wood are frequently used, care being taken to protect the hoops or other iron fastenings from coming in contact with the solution. A wooden vat lined with sheet lead makes a very satisfactory combination. Vessels of glazed or vitrified earthenware are suitable when the work is suspended and not thrown into the solution.

For cleaning brass castings a solution of nitric and sulphuric acids with water is usually used. The common proportions are 1 part nitric acid, 2 parts sulphuric acid, and 2 parts water. The castings are left in the solution but a short time and then thoroughly rinsed first in cold, and then hot water, after which they are dried in sawdust.

CHAPTER III.

SCRAPERS AND SURFACE PLATES.

The scraper is a tool used by machinists for producing truer surfaces than can be produced by the ordinary planing and filing processes. It is strictly a tool to be used on stationary work, although the distinction between it and the hand turning tool used by the brass worker is not clearly drawn.

The flat hand scraper, as usually formed, is shown in Fig. 48.

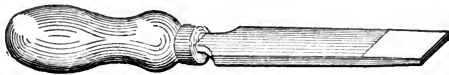

FIG. 48.

It is forged from a piece of flat steel of from $\frac{3}{4}$ to $1\frac{1}{4}$ inch in width by $\frac{1}{8}$ to $\frac{3}{16}$ of an inch in thickness. The point is drawn down so that the end is about $\frac{1}{16}$ of an inch thick, as shown in Fig. 49. The flats should be ground well back from the

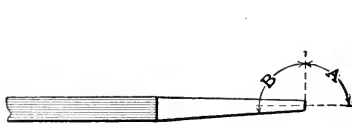

FIG. 49.



FIG. 50.



FIG. 51.

point and the end at right angles to the length of the tool, as shown at A, Fig. 49, thus making the angle of the cutting edges but slightly more than 90 degrees, as shown at B, same figure.

The end should be ground slightly rounding in its length to prevent the corners from digging into the work and the tools taking too broad a cut, which tends to produce a waved or chattered surface.

If the end is ground so as to give one side a keener cutting edge, as shown in Fig. 50, this edge will cut faster, but the surface produced will ordinarily not be so smooth as in the former case, it being difficult to prevent the tools chattering.

The scraper, including handle, should be from 10 to 12 inches long, depending on the size of stock and the character of the work on which it is to be used. If too long it will be springy and will not do good work. As the angle forming the cutting edge must be kept very sharp, a high temper is necessary, and the end faces after being ground must be oil-stoned often in order to make the tool cut properly.

The double ended scraper shown in Fig. 51 is a form frequently used. This scraper should be made somewhat longer than the one shown in Fig. 48, from 14 to 16 inches being about right. The central portion, which serves as a handle, should be enlarged and knurled, or twisted in the forging, so as to enable the hand to grip it firmly.

A form of scraper shown in Fig. 52 is sometimes employed on fine work. The disadvantages of this form arise from its hidden cutting edge while at work, and its having but one cutting edge, thus necessitating more frequent grindings than with the straight tool.

The scrapers shown above are suitable for use on plane or



FIG. 52.



FIG. 53.

convex surfaces. If a concave surface is to be worked upon, a scraper of semicircular cross section, as shown in Fig. 53, will be used.

Frequently in scraping circular surfaces, and more especially in the softer metals, as brass or babbitt, a three-cornered scraper can be used to advantage. Such a tool is shown in Fig. 54.

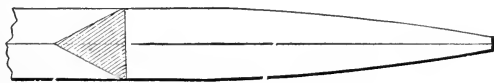

FIG. 54.

The cutting edges are long ones, formed by the intersection of the sides. In its use this tool is held in both hands, by the point and handle, when the nature of the work will permit, the cutting edges being swept over the surface of the work. This scraper should be tapered from the middle toward the point and parallel from the middle to the heel, thus giving curved and straight cutting edges, which may be used for taking narrow or wide cuts, as the work may require.

Work that is to have surfaces accurately fitted by scraping should be carefully planed. The finishing cuts should be very light ones, taken with a moderately fine feed, the work being clamped as lightly as possible, to prevent its springing when taken from the planer table. The surfaces should be filed only enough to bring them to approximate planes and to remove traces of tool marks.

The usual method of producing a plane surface is by compar-

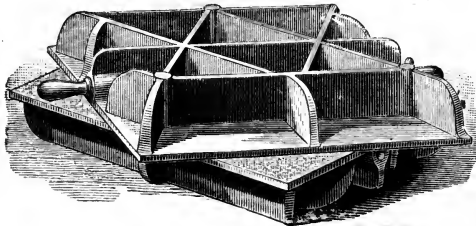

FIG. 55.

ing it with a standard plane. Such a standard is called a surface plate and bears the same relation to the testing of plane surfaces that the cylindrical gauges do to the testing of circular surfaces. In Fig. 55 is shown a pair of Brown & Sharpe standard surface plates.

After bringing the surface of the work to an approximate plane by planing and filing, and too much care cannot be exercised in these operations, the work is ready for the scraper. A thin coating of red marking is rubbed over the face of the surface plate. The material used for this marking is usually Venetian red mixed in oil. Red lead answers fairly well, but separates too easily from the oil and does not spread as evenly and thin as the former. The marking can be best applied to the surface with the fingers or the palm of the hand, as the hand

detects any dust or grit and spreads the marking thinner and more uniformly over the surface than can be done with a piece of rag or a brush. The work surface is now rubbed over the surface plate, the high points on the work being shown by the marking rubbed from the true surface of the plate. These high points, if small and few in number, may be reduced with a fine file until the work, when moved over the plate, will show fairly good contact. The file should be used up to that point in the operation at which more time would be required to make the file cut on the proper spots and sufficiently light to prevent pitting than would be required to remove the metal with a scraper. The workman's judgment must determine this point, and much time and hard work will be saved if his judgment is good. A file having considerable belly should be used for this purpose.

The thickness of the coating of marking will depend upon the condition of the surface, the nearer it approaches a plane the thinner the marking must be. If too thick false bearings will show, which lead to confusion and errors in the scraping. For the finest work it must be rubbed down so thin as to be scarcely visible, and the lark brown spots left on the work will then show true bearing points. The harder the surfaces are pressed together the plainer will the marks appear, the higher ones looking the brightest.

When the work is heavy and awkward to handle the surface plate may be rubbed over it. After each course with the scraper the surface must be remarked. For the first few courses the strokes of the scraper may be moderately long, never exceeding three-fourths of an inch, but as the surface becomes truer and the bearing points close together, the strokes must be made shorter, being careful not to overreach the marked points. Each course must be made at a considerable angle with the preceding one, thus preventing the waved surface that results from numerous cuts across the work in one direction.

The scraper should be held as shown in Fig. 56, and pressed firmly to the work. The pressure required depends upon the hardness of the metal being scraped and the condition of the cutting edge. This must be carefully considered in accurate finishing, since as the tool dulls the pressure must be increased in order to give cuts of equal depth.

The degree of accuracy required must in every case determine how far the process should be carried. For a strictly first class

job there should be contact over practically the entire surface, as shown by the extremely thin coat of marking. Such surfaces are comparatively expensive to produce.

When two plane surfaces are to move over each other, as so frequently occurs with machine parts, both may be trued to the surface plate, but usually the nature of the work will prevent the use of the plate on both, in which case one surface may be trued to the plate and the other fitted to this surface.

When two plane surfaces that are not intended to move over each other are to be fitted together one should, if possible, be trued to the plate and the other fitted to it, but frequently in such cases it is not possible to apply the plate to either surface, and usually motion of the one surface over the other cannot be

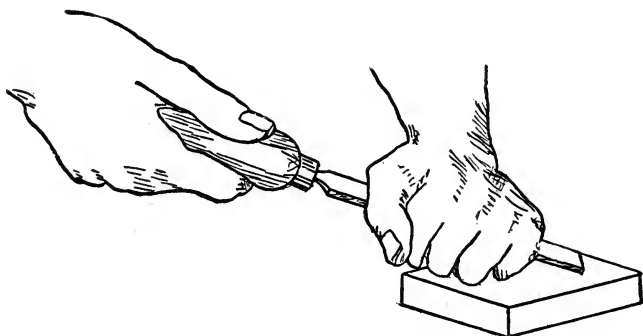

FIG. 56.

had. In such cases the process known as "bedding" must be used. When possible one surface will be trued to the plate, then covered with marking and placed in position over the surface it is to be fitted to, when a sharp blow with a mallet or soft hammer will cause it to mark the high spots on the latter surface. These spots can be scraped away and the process continued until the marks appear uniform over the entire surface. If neither of the parts can be applied to the plate, one must be machined and finished as true as possible and the other fitted to it. This will, of course, not give true plane surfaces, but in nearly all cases where motion between the surfaces is not expected, a uniform bearing is all that is necessary. As before, the coating or marking will depend upon the condition of the surfaces. If too heavy at any time the force of the blow will spread it into

the low spots, thus giving false bearings. Pedestal bearings, connecting rod brasses and similar parts, must usually be fitted in this manner.

Cylindrical surfaces, as shaft, spindle and pin bearings, also depend largely upon the scraper for bringing them to their true bearing surfaces.

In such cases the bearing is usually fitted to its spindle, the latter taking the place of the surface plate. It follows that if the spindle is not round a perfect bearing will not result. Since in machine construction the cylindrical truth of all spindles must be sufficiently exact to satisfactorily perform the operations for which the machine was intended, the bearings may be so fitted. In high grade machine construction the spindles are ground and lapped cylindrically true, thus enabling the skilled workman to scrape the bearings for these spindles as accurately as he could produce a plane surface from a standard surface plate.

In the absence of a standard plane a true plane surface may be originated in the following manner: Take three plates, the surfaces of which have been brought to approximate planes. Determine by means of the straight-edge which of these plates is the nearest true. Call this plate A and the others B and C. Assume A as a temporary standard, and fit B and C to it. The surface outline of A is shown to an exaggerated scale in Fig. 57. In Fig. 58 are shown B and C placed together after having



FIG. 57.



FIG. 58.

been fitted to A. If now B and C are fitted to each other, being careful to correct equally the error on each, it is evident that either B or C will be nearer a true plane than A. Now select one of these plates, say B, as a temporary standard and fit A and C to it. Then fit A and C to each other as before. Next select C as the standard and repeat the process. Each repetition of this operation will bring the surfaces nearer to true planes, and when they finally interchange, showing perfect contact between any two, the work has been completed.

Surface plates are designed to resist as much as possible the deflection due to their own weights. In large plates this is an extremely important point in their construction. For the final finishing the plates could be tested while standing on their edges, but if trued in this position they would sag in the center when turned down. It would, therefore, be necessary to apply them to the work in the same position in which they were finished, which would be extremely awkward.

A surface plate should always rest upon three points of support and should be kept in a substantial wooden box, from which the cover can be easily removed, exposing the surface when in use and protecting it when not in use from accidents due to articles falling on and marring the face, as well as from the dust. When not in use the surface should be kept oiled to prevent rusting, which would impair its accuracy.

The surface plates should be kept in a temperature as uniform as possible and not varying far from that at which the plate was finished, as the expansion due to changes of temperature is very apt not to be uniform and the truth of the plate thereby affected.

In using the plate, wipe any dust or grit from the face before applying the work, otherwise there is danger of scratching the surface. A careful workman tests small work on the edges of the plate rather than in the center, and thus prevents dishing the plate through wear.

CHAPTER IV.

STANDARDS OF MEASURE.

Modern methods of manufacturing interchangeable machine parts necessitate the extensive use of standard gauges. A standard gauge is a fixed caliper, the distance between the measuring surfaces representing a certain definite portion of the British Imperial yard, which is also the standard in the United States. This British yard is the distance between two very fine rulings on polished gold plugs inserted in a certain bronze rod commonly referred to as bronze No. 1, and carefully guarded within the walls of the Houses of Parliament.

As changes in temperature affect the length of the bar, the distance between the lines is standard at 62 degrees Fahrenheit. The rulings on the gold are so fine that they are hardly visible to the naked eye, necessitating the use of the microscope for making comparisons.

A number of copies of the British yard were made for distribution among the different governments and to preserve as reference in case of accident to the original standard. Of these only two, bronzes No. 19 and No. 28 were exactly standard, the others varying slightly from the original. Both of these are retained by the British government as exact representations of their standard of measure.

By act of the British Parliament, the Imperial yard was legalized in 1855, and the following year copy No. 11 was presented to the United States Government. At 62 degrees Fahrenheit No. 11 is .000088 of an inch shorter than bronze No. 1, and is exactly standard at 62.25 degrees. The temperature at which these bronzes are standard is usually referred to rather than the amount of their error at 62 degrees Fahrenheit.

The exact subdivision of this standard yard into its thirty-six equal divisions, each of which represents one inch, and the still further divisions to the fraction of an inch was a task of no small proportions. Sir Joseph Whitworth obtained the inch subdivision by making first three end measure test pieces, each equaling as near as possible one foot. Keeping these pieces continually of equal length they were worked down until the three when

placed end to end exactly equaled the standard yard. By continued subdividing the foot pieces were reduced to inches. For the fractional division of the inch he depended on the accuracy of a screw. The enormous amount of time and work required to make this subdivision can hardly be appreciated, and when completed the uncertainty of maintaining the test pieces as standards due to the wear on the measuring faces by the repeated trials necessary in the comparing of working test pieces renders the method unsatisfactory. These uncertainties were eliminated in the method proposed by Prof. William A. Rogers and so ably carried out by himself and the Pratt & Whitney Company. This method substituted for the end measure test pieces a graduated steel bar, thus making a line measure reference. As working gauges are made of tempered steel, it was important that the reference bar be made of the same material, since the effect of changes in the temperature affects to an unequal degree the expansion of different metals. As repeated comparison with the bronze standard would not be practical or even desirable, it was



FIG. 59.

decided by the Pratt & Whitney Company to construct a hardened steel bar, to be graduated and compared with the official standard, and that this bar, when its precise relation to the standard was established, might thereafter be used as a standard with which to compare steel gauges and tools necessary in the production of accurate interchangeable work.

Of the five bars graduated and compared with bronze No. 11 the shortest, a tempered steel bar, 6 inches long and $\frac{1}{2}$ inch square in cross section is the one about which manufacturing interests most center. The upper surface of this bar is ground and polished to a perfect plane, and 4 inches of its length graduated, as shown in Fig. 59. The subdivisions along one edge are inches, half inches, quarters, eighths and sixteenths, along the opposite edge, tenths and twentieths and through the center a series of lines representing the exact bottom diameter of U. S. standard thread gauges from $\frac{1}{4}$ to 4 inches, with a band of rulings immediately below of 2,500 per inch. These lines were cut

with a diamond, and are exceedingly fine, being not greater than 1-25,000 of an inch in width.

A complete description of the method employed for ruling and comparing these bars with the standard, bronze No. 11, together with a description of the Rogers-Bond comparator, is given in a book published by the Pratt & Whitney Company, entitled "Standards of Length and Their Practical Application."

The most careful investigation of this steel line-measure bar shows it to be but five millionths of an inch longer at 62 degrees Fahr. than 1-9 of the Imperial yard. The greatest error in any of the subdivisions does not exceed 1-50,000 of an inch. By means of microscopes provided with micrometer eye pieces the reading or comparing of lines on these finely ruled bars can be made with the greatest exactness, and at the same time not impair in any respect their accuracy by wear, as is the case when using end measure standards.

As a measuring machine, the essential features of this remarkable instrument and its working may be briefly stated as follows: Two accurately lapped surfaces corresponding to the anvil and measuring point of the common micrometer serve as caliper points, between which the articles to be measured are placed. The measuring point is secured in the end of a sliding plunger, which carries in a suitable position a small plate, upon which is ruled a very fine reference or setting line. Back of, and capable of motion, parallel with the plunger is a carriage mounted on suitable guides. Secured, adjustably, to this carriage are two powerful microscopes, each provided with micrometer eye pieces, by means of which variations in the setting as small as 1-60,000 of an inch may be read. The standard steel bar is so placed that one of the microscopes passes over its surface when the carriage is moved along its guides. A spiral spring attached to the measuring plunger in a suitable manner provides equal pressure of contact between point and work as between point and anvil.

In operating, the surfaces of the measuring point and anvil are brought into contact, the carriage is moved to the point at which one microscope shows exactly over the line on the plate on plunger, and the other microscope is adjusted to read exactly on the initial line of the standard bar. The plunger is now moved back, and the article to be measured placed between the points. The carriage is now moved along its way until the first

microscope again reads on the line on the plunger. The other microscope will have moved over the standard bar an amount equal to the distance between the measuring points, and the reading on the bar, with the aid of the micrometer eye piece for the minute subdivision, will give the exact measurement in terms of the standard.

Although desirable to maintain the temperature uniformly as near 62 degrees Fahr. as possible, it is not necessary in the measuring of hardened steel articles, as the coefficient of expansion

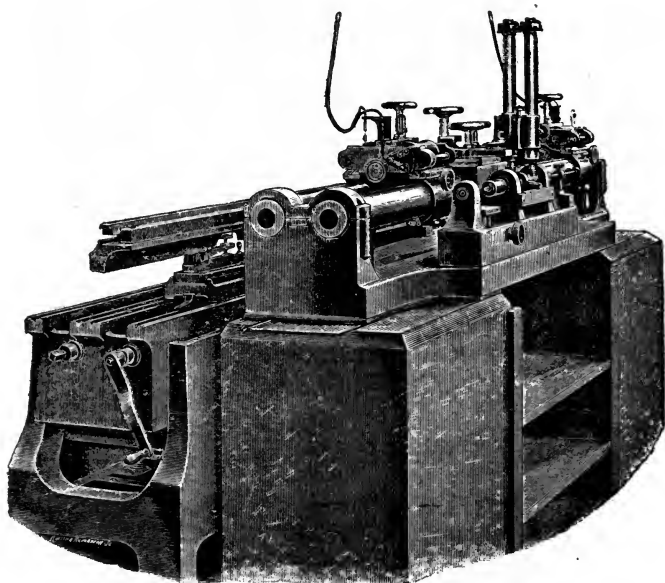

FIG. 60.

for these and the standard bar is the same. It is, however, very important that both the article being measured and the standard bar be at exactly the same temperature.

In Fig. 60 is shown a general view of the Rogers-Bond comparator, owned by the Pratt & Whitney Company.

With this machine measurements guaranteed correct to the 1-50,000 of an inch are continually being made in the production of the standard gauges of this company, and differences in dimensions as small as 1-100,000 of an inch readily indicated. It will be understood, however, that measuring and indicating are vastly different matters, as a difference in dimensions too

small to be read with any degree of accuracy can be readily detected. Thus we see that at great expenditure of time and labor a working standard, the reliability of which is beyond question, was produced.

Standard gauges cannot be classed as measuring instruments, as they do not determine the amount of variation when they do not fit the work. If the work is very nearly to size, however, the tightness of the fit will give an idea as to how much the work is over or under size; this based on the judgment of the operator, of course.

In Fig. 61 is shown a plug and ring gauge. The diameter of these gauges is, as stamped on them, $1\frac{1}{2}$ inches, as near as human skill can make them. The particular gauges shown are guaranteed correct to the 1-50,000 of an inch. It is perhaps difficult to conceive of a dimension so small. Take 1-100 of an inch, which is the smallest graduated space commonly put on the ordinary steel scale. Imagine this small distance divided into



FIG. 61.

FIG. 62.

ten equal parts, and then one of these portions into fifty equal parts, and you really have something small in the way of distance. Although so nearly of the same size, by skillful manipulation, the plug may be made to enter the ring. Both surfaces must be wiped perfectly clean and coated with fine oil. When entered the one will move over the other with great smoothness and surprising ease, but if the motion is stopped for only an instant they will set, and so firmly that nothing short of a sharp blow with a mallet will start them. There can certainly be but little room for lubrication between these surfaces, and the supposition is that when motion stops the little globules of oil flatten out so thin that the surfaces of the metal coming into contact grip each other. The effects of temperature are clearly shown by first cooling and then warming slightly the plug. In the first case it enters the ring readily and in the latter it cannot be induced to start. These gauges are made in any desired sizes, from $\frac{1}{4}$ to 6 inches.

In Fig. 62 is shown an end measure test piece. This little

piece of hardened steel measures exactly between faces the distance stamped on it. The small hole in the side is to receive a small wooden handle with which to manipulate it, as the heat from the fingers would otherwise affect its length.

The accuracy of the method of making and the final measuring of these test pieces were shown most conclusively by the severe test of the committee of the American Society of Mechanical Engineers appointed to investigate the subject of standards and gauges. The test consisted of the placing end to end in a groove planed in a heavy block of cast iron, Pratt & Whitney end test pieces of miscellaneous lengths aggregating a total length of 12 inches, between suitable stops which were so adjusted that a $\frac{1}{4}$ -inch end measure, used as a try piece, was held with just sufficient friction to allow it to move easily. Twelve

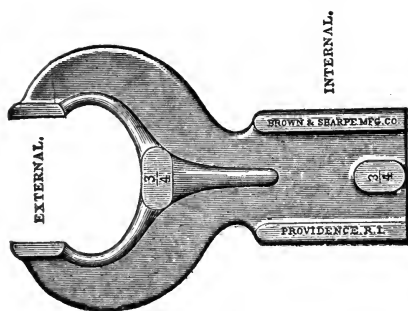

FIG. 63.

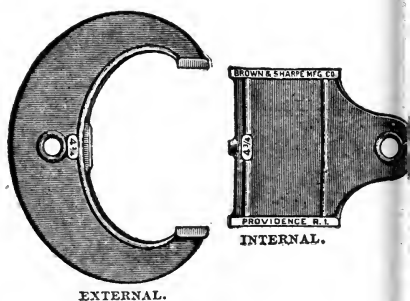

FIG. 64.

different sets, all of which had been resting on the block of iron sufficiently long to attain the same temperature were tried between the stops. Each set was made up of different combinations of lengths using in each case the same $\frac{1}{4}$ -inch try piece. With one exception these twelve sets were found to be of uniform length, the try-piece fitting with practically the same friction in each of the eleven sets. In one case where the try-piece was quite loose, it was found that the total length of the pieces was 1-10,000 of an inch short, most of this error being in one piece, which had been previously rejected because of a defective face.

Fig. 63 shows a form of caliper gauge, double end pattern, for gauging both internal and external dimensions. For the larger sizes the forms shown in Fig. 64 are used, as they make

lighter and more convenient tools. For general shop use, where constant reference is to be made to them, these gauges are preferable to the plug and ring forms, being lighter, cheaper and more convenient. With the ring gauge it must be applied to the end of the work, while the external caliper gauge can be used at any point in the length of the work.

Good judgment must be exercised in the use of all accurate gauges. They must never be forced, as in that case excessive wear results, and they soon become unreliable. A standard ring is not intended for measuring anything except work that by careful methods has been brought to the gauging diameter. It should move freely over the work without forcing, and yet close enough to show no shake. When it is considered that 1-2000 of an inch is the difference between a tight and a loose fit, the results possible with gauges of this character become evident.

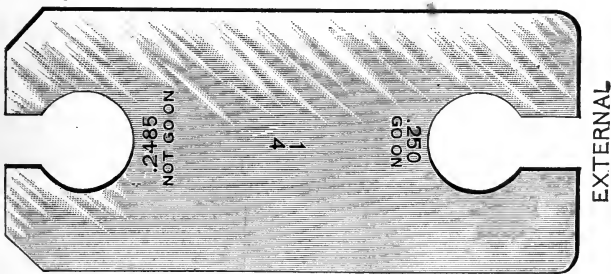

FIG. 65.

In using the external caliper gauge, if forced over the work not only wear to the faces, but springing of the jaws will result, both of which destroy the accuracy of the tool. Never attempt to use this or any other gauge on rotating work, as the faces will catch and draw over work several thousandths over gauge size.

In the machining of nearly all work, a certain amount of variation from the exact standard size is permissible, the amount of this variation depending on the nature of the work. If, for example, the variation allowed in the making of a large number of like parts was .001 of an inch from exact size, the economical production of these articles would not permit the loss of time in making them unduly accurate.

The gauges shown in Figs. 65 and 66 illustrate external and internal limit gauges. One end of the external gauge shown

must pass over work not exceeding $.250$ of an inch in diameter. The opposite end, which is but $.0015$ of an inch smaller, must not go over. In this case the limit is all under the exact size,

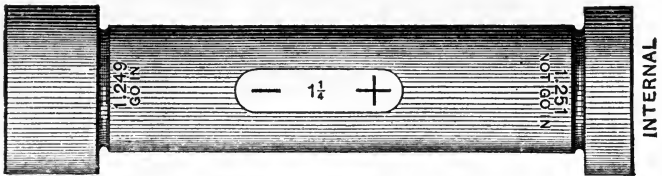

FIG. 66.

while in the internal gauge shown in Fig. 66 the limit of $.002$ is half below and half above the standard size.

In Fig. 67 are shown United States standard thread gauges,



FIG. 67.

external and internal. By an extremely accurate method, the threads of these gauges are ground after hardening, which leaves them highly finished and correct as to pitch and angle. The standard pipe gauge is illustrated in Fig. 68. The use of standard

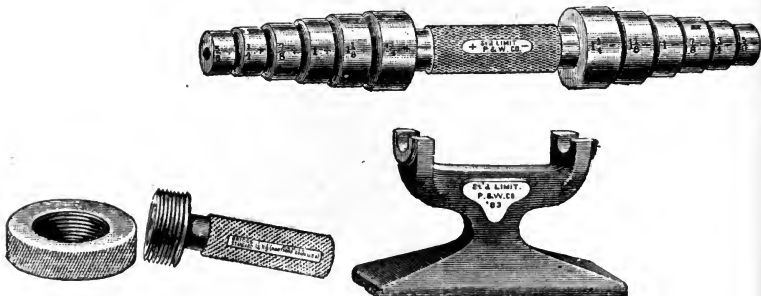

FIG. 68.

FIG. 69.

thread gauges enables the manufacturer of pipe, fittings, screws, etc., to maintain standard threads and sizes by referring all taps and dies to the standards.

The corrective gauge shown in Fig. 69 is used for testing the

correctness of caliper gauges. To insure against errors arising from the use of gauges which, through wear or accident, have become incorrect, it is important that they frequently be referred to the corrective gauge. Caliper gauges which have worn on the faces until they are oversize, can be brought up to standard by pening lightly the outer edge of the crescent.

The use of standard gauges and micrometers has done much to systematize, improve and lessen the cost of many lines of manufacture. With our present excellent systems of gauging it would be quite possible to build the many parts of a steam engine or machine tool in many different shops throughout the country and to assemble these parts into a perfect working machine.

In the manufacture of gauges the cost depends very largely on the degree of accuracy obtained. A set of cast iron plugs and rings for common work can be ground correct to one-fourth of a thousandth without much trouble. But when of tempered steel and the error reduced from 1-4,000 to 1-50,000 of an inch, the cost of production due to this great refinement increases many times.

Gauges that are to be finished to the highest possible degree of accuracy are, after being hardened, ground to nearly the required dimensions, and then stored away to "season." Gauges that are finished immediately after hardening will frequently crack open several months later. It has been found, however, that if the gauge is allowed to stand for about a year before the finishing work is done on it, it is not apt to crack thereafter. Gauges are made standard at 62 degrees Fahrenheit.

CHAPTER V.

CALIPERS.

Calipering tools may be classed under two heads—transfer and recording. The transfer class includes all calipers used to transfer scale dimensions to the work, work dimensions to the scale, or to receive and transfer from one piece of work to another a dimension without reference to its exact magnitude. The recording caliper is provided with a scale which gives the length of the dimension measured as well as forming a transfer instrument. This latter class includes the vernier and micrometer calipers. The large and heavy calipers of this class are called “bench micrometers.” Recording calipers are usually graduated to read to one-thousandth of an inch, which makes them sufficiently accurate for use on all ordinary mechanical operations. When, however, the tool is designed for greater accuracy, it becomes necessarily more delicate and expensive, and is not suitable for general shop work. Such instruments come under the class known as “measuring machines,” which are used as test instruments.

The transfer calipers are of three general forms: firm joint, lock joint and spring, the latter two usually being called adjustable calipers.

Calipers to be first-class should have well proportioned legs made of high grade steel, preferably tempered, with a carefully fitted joint having a uniform amount of friction at all positions of the legs, thus insuring a smooth, steady motion when setting.

In Fig. 70 are shown at A and B a pair each of outside and inside firm joint calipers, and at C a pair of inside lock joint calipers. In this tool a tapered socket joint enables the short arm A to be rigidly locked with the outside leg B by tightening the knurled nut C. The nut D, which is coned on the bottom, moves over a stud, which is secured in the middle leg, and moves through a slot in A. Secured to A is a small cone, against which the cone nut bears, thus forcing the middle leg away from A when D is tightened down. A stiff spring set in the under side of A resists the separation and holds the joint steady. This tool may be set to approximately the size desired, the joint locked

and the final adjustment obtained by turning the nut D. By adjusting C to give the correct friction this tool may be used as a firm joint caliper.

At D, Fig. 70, is shown a good example of the numerous forms of spring calipers in use. Its construction is clearly shown in the figure. They may be had with solid or slip nut on the screw, a slip nut being shown at E, Fig. 70. It is a split nut pivoted at A with a light spring in a recess inside the knurled head, which holds the halves together at the threaded end, the outside of which is coned to fit a recess in the post or caliper leg, which prevents the nut from opening when the tension of the joint spring is upon it. The slip nut saves time in setting the calipers,

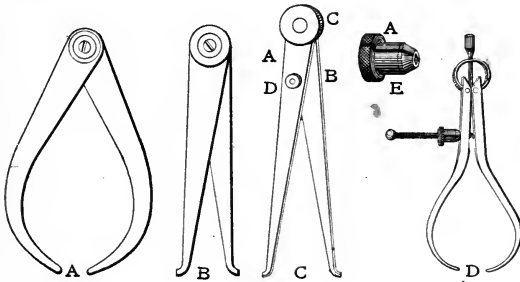

FIG. 70.

which is of material importance where numerous settings are to be made.

The skillful use of transfer calipers depends entirely on the good judgment and delicate touch of the operator. He must recognize contact, between the points of the caliper and the work, without pressure. The ability to make a sure calipered fit is an accomplishment that comes only with practice. In setting calipers to a scale care must be exercised, the chance for personal error being great. In setting the outside calipers the scale should be held vertically in the left hand, with the end of the little finger resting against the side at the bottom end to steady the lower point of the calipers over the end of the scale, the caliper being held in the right hand, as shown in Fig. 71. If the caliper is a "firm joint" it must be adjusted to the required dimension by tapping the legs against some solid body, the force of the blow diminishing until the proper adjustment is obtained. In setting the adjustable calipers, they should be

held in the right hand, as shown in Fig. 72, the thumb and fore-finger operating the adjusting nut. The upper caliper point rests against the side of the scale and over the graduations. The lower point rests against the end of the scale, but the eye must determine when the upper point coincides exactly with the required reading. The end of the scale should be square, only a

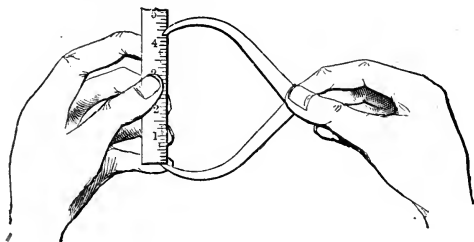

FIG. 71.

comparatively new steel scale being suitable, as an old one is frequently worn enough to make it appreciably short. When the caliper is heavy the little finger of the right hand should be pressed against the lower leg to steady and support it. The slight angularity of the points with the plane of the scale, due to dropping the lower point below the graduated surface, has

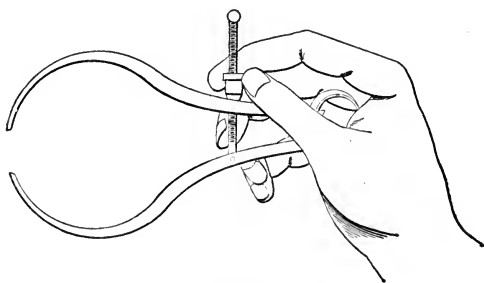

FIG. 72.

an appreciable effect on the accuracy of the setting only when adjusting for the smaller dimensions. This error may be avoided by slightly twisting the caliper so as to spring the legs sidewise enough to bring the points in planes parallel to the surface of the scale.

In setting the inside calipers to the scale the end of the scale should be placed against and held at right angles to a plane surface; one point of the caliper placed against this surface and the other adjusted to the required reading on the scale. It is very important that the scale be held perfectly at right angles, as a slight variation makes considerable error in the reading. It is not good practice to set both points to lines on the scale, as the chance for error is much greater than when the measurement is referred to one end of the scale.

In transferring a setting from one pair of calipers to another, the reference pair should be held in the left hand, with the lower point resting against the end of the little finger. The lower point of the pair being set should be brought in contact with this point, the end of the finger serving to steady the points. The upper point should then be so adjusted that it just makes contact with the upper point of the reference pair. The accuracy attained depends entirely upon the skill with which this adjustment is made, other than the slightest pressure between the points serving to distort the measurement.

Assume that a shaft is to be turned to $4\frac{3}{8}$ inches in diameter and a hub bored to fit this shaft. The outside caliper will be set to size, as shown in Fig. 71, involving the first chance for error. The bar will now be turned and finished to the caliper size, allowing a second chance for error. The third opportunity for error arises in the setting of the inside to the outside calipers, and finally the fourth in boring the hub to the dimension of the inside caliper. Of these the first two affect the diameter of the work and the last two the fit.

In using the outside calipers they must pass squarely over the work, just touching it. The lighter the touch the greater the accuracy attainable. For final calipering the work must be stationary, as a rotating piece will draw the calipers over long before they are down to size. When a number of pieces are to be turned to sample, it is permissible to set the calipers so that the contact will just sustain their weight, turning all of the pieces so the contact will be the same. This, however, can hardly be called calipering.

In setting the inside calipers to the outside, the contact between points should be, as near as a delicate touch can determine, the same as the contact between outside caliper points and the work. The work should then be bored to that diameter

which gives the same contact between the inside calipers and the walls of the hole as between the inside and outside calipers.

The caliper shown at A in Fig. 73 is technically known as a "transfer" caliper. Frequently it is necessary to caliper a piece of work the shape of which makes it impossible to remove the calipers without losing the setting. In this tool the leg A is secured to the blade B by the stud and nut C, the stud striking against the end of the small slot. The caliper is then set, for example, to the larger diameter of a chambered cylinder, and the joint nut tightened, securing D and B to each other. C can now be loosened and the leg A moved to allow the tool to be removed from the work. When moved back against its stop it will show the original setting. Only calipers of the very best construction should be depended upon for this kind of work.

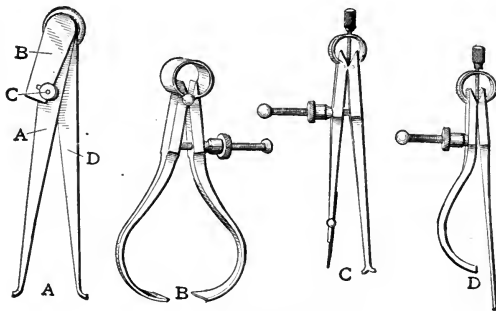

FIG. 73.

The thread caliper is shown at B in Fig. 73. It has wide, thin points for calipering both the top and bottom of screw threads.

At C, Fig. 73, is shown a hermaphrodite caliper, a tool having one caliper and one divider leg. The divider leg is preferably adjustable, and when caliper is of the spring pattern the caliper leg must have right and left feet, as the legs cannot pass by each other as with the firm or lock joint patterns. This caliper is a valuable tool for centering, and scribing purposes.

The key hole caliper, shown at D in Fig. 73, is a valuable tool on work the shape or position of which will not allow the use of two curved legs.

The vernier caliper, an example of which is shown in Fig. 74, is a form of beam caliper which depends for its setting on a graduated scale on the side of the beam, the subdivision of the

graduation on the beam being obtained by means of the vernier on the sliding jaw. This tool possesses the advantage of wide range and comparatively light weight. Its value as a measuring instrument depends on its accuracy of construction, cheap calipers of this class being of little value. The jaws should be of tool steel, carefully tempered, and the faces ground exactly parallel with each other. The sliding jaw is given its final adjustment by means of the small knurled nut and screw in the auxiliary slide. The graduations usually read to thousandths on the front side of the beam, and to sixty-fourths on the back. They may be used for either inside or outside measurements, but for inside readings on the vernier side a constant equal to the space occupied by the points must be added. On the back side of the instrument two zero lines are used, one for inside and one for outside measurements, thus avoiding the necessity of the addition for the inside readings.

In explanation of the use of the vernier; Referring to Fig. 74,

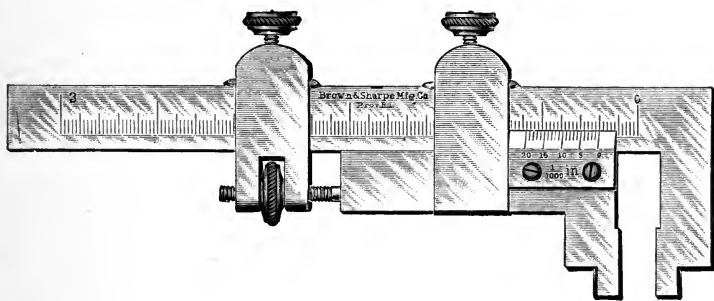

FIG. 74.

it will be noted that the scale on the beam is divided into inches, tenths and fiftieths, and that twenty divisions on the vernier cover exactly nineteen divisions on the scale. This makes each division on the vernier $\frac{1}{20}$ of $\frac{1}{50}$ less than a division on the scale, or $\frac{1}{1000}$ of an inch. In the figure the zero on the vernier stands at $.2$ inch; if, now, the sliding jaw was moved out until the 10 on the vernier coincided with the next line on the scale ($.4$ inch) it would have moved through $\frac{10}{20}$ of $\frac{1}{50} = \frac{1}{100}$ or $.01$ inch from zero; and in like manner if the fourteenth division on the vernier had moved to coincide with the third line

beyond 1.6 inches, as shown in Fig. 75, the reading would be 1 inch + .3 inch + $4.50 (.08)$ + $.014 = 1.394$ inches.

Other graduations than the one shown may be used; for example, if the beam is graduated into forty lines per inch and the vernier has twenty-five divisions covering twenty-four on the scale, then each division will be $1/25$ shorter than one on the scale and $1/25$ of $1/40 = 1/1000$ of an inch.

A magnifying glass is of great value in reading these instru-

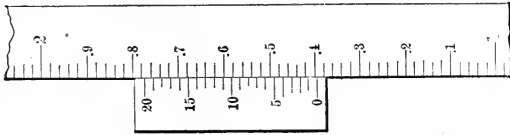

FIG. 75.

ments, especially so when many readings are to be made in a short space of time, it being very trying on the eyes.

The micrometer caliper, a skeleton view of which is shown in Fig. 76, is a tool that has come into very general use among mechanics employed on work requiring uniformity and accuracy. Its simplicity and relatively low cost make it an instrument that

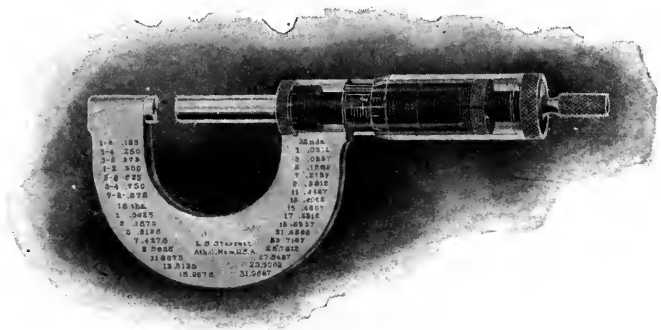

FIG. 76.

even the mechanic on comparatively coarse work can scarcely afford not to have in the caliper drawer of his tool chest.

These calipers may be divided into two classes, the yoke and the beam patterns, Fig. 76 illustrating the former. In this figure the construction is quite clearly shown. The shank of the yoke contains at its outer end a split nut, which for adjustment for

wear, may be closed onto the screw by advancing the nut toward the yoke, the stem being threaded on a slight taper. The graduated shell or thimble is attached to the end of the screw and rotates with it, moving along and over a shell on the shank. As the screw does not extend out of the yoke it is completely encased and protected from dust or injury for all positions of the measuring point within the range of the instrument. The small knurled extension to the thimble serves as a speeder for rapidly advancing the screw. The knurled nut in the yoke contracts a split bushing over the measuring stem, thus locking it in any desired position. The measuring point and the anvil against which it strikes are carefully hardened and ground, making the surfaces parallel planes.

The micrometers of this class are usually provided with a screw having forty threads per inch. The barrel is graduated to tenths and fortieths of an inch. Thus one revolution of the screw advances the thimble one division on the barrel, which equals $1/40$ of an inch or $.025$ inch. As the circumference of the thimble is divided into twenty-five equal parts, $1/25$ of one revolution of the screw advances the measuring point $1/25$ of $1/40 = 1/1000$ of an inch. When the end of the measuring point and the anvil come in contact, the zero points on barrel and thimble should coincide, thus avoiding the necessity of a correction for each reading. As the measuring faces and screw wear slightly, it is necessary to provide some means of adjustment in order to keep the zero reading correct. In this particular instrument the barrel may be rotated on the shank sufficient to bring the lines correct. In others the anvil may be forced ahead by means of a small screw in the yoke.

As these instruments are graduated to read decimally, a table of decimal equivalents is usually stamped on the sides of the yoke, eighths, sixteenths and thirty-seconds on one side, and sixty-fourths on the opposite.

In Fig. 77 is shown a micrometer caliper to take sizes between one and two inches. When the zero points coincide, the face of the measuring point is exactly one inch from the face of the anvil. A 1-inch reference disc, hardened, ground and lapped to size is furnished with each caliper with which to test the correctness of the setting.

Although a half, or even a fourth of one-thousandth can be quite readily approximated on the reading, which brings it within the accuracy limit of all ordinary work, it is frequently desirable

to get at these fine readings more closely. For this purpose the vernier is applied to the barrel, as shown in Fig. 78. It consists of ten parallel rulings on the barrel, occupying the same space as nine of the twenty-five divisions on the thimble, which makes the spaces on the barrel one-tenth shorter than those on the thimble,

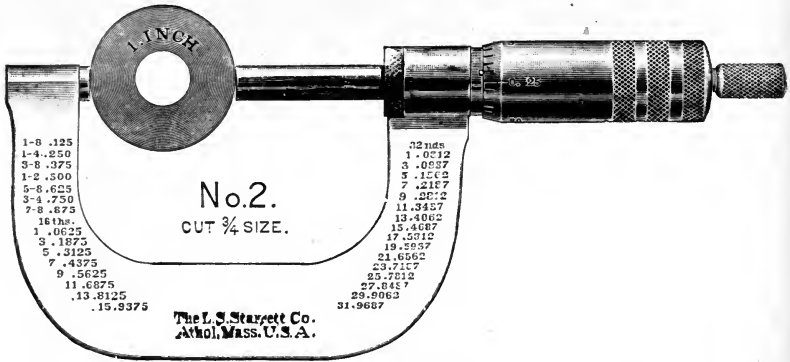

FIG. 77.

thus giving 1-10 of 1-25 of 1-40 = 1-10,000 of an inch. This refinement can be relied upon only when the greatest care is exercised in making the measurements, as the slightest excess of pressure on the screw over that at which the caliper is adjusted will spring the instrument more than the minute distance it is expected to indicate. Calipers graduated to ten-thousandths should

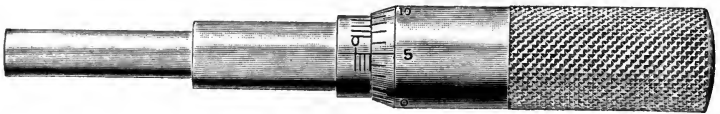

FIG. 78.

be used only where fine measurements are required as the wear due to common use will shortly impair their accuracy for the fine measurements.

In the use of the micrometer caliper it is important that the pressure of the measuring point against the work is the same as the pressure of the point against the anvil when the zero setting is made, as it is quite possible for a careless workman to force the screw enough to set the thimble zero two or three thousandths past

its zero position. For all ordinary work the following method will serve well: Adjust the caliper so the zeroes will coincide when the thimble is turned with just enough pressure to raise the yoke to a horizontal position. In calipering, hold the work in a vertical position, and with the caliper in the right hand adjust the measuring points onto the work until the yoke again comes up to the horizontal position, thus insuring practically the same pressure between point and work as between point and anvil when the zero setting was made.

For very fine work the application of the friction drive to the thimble is an advantage. In Fig. 79 is shown a micrometer head having such a device. The knurled extension contains a ratchet which, when the pressure reaches the desired point, slips. In



FIG. 79.

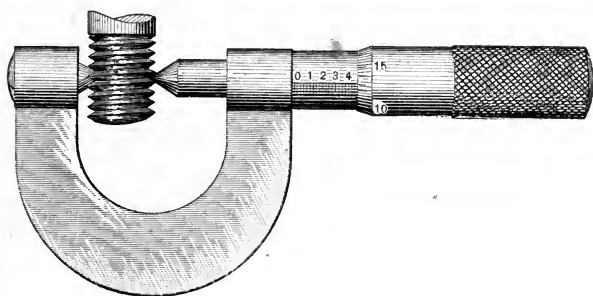

FIG. 80.

backing the screw the ratchet engages the pawl, making a positive drive. The advantage of the ratchet over a plain friction is that the screw can be backed more rapidly without slipping.

In Fig. 80 is shown the Brown & Sharpe thread-measuring micrometer used for the accurate measuring of United States S and V threads on screws, taps, thread gauges, etc. The end of the measuring point is a 60 degree cone and the "anvil" is V-shaped. Enough is cut from the end of the measuring point and the bottom of the V carried sufficiently deep to prevent a bearing on the top or bottom of the thread thus giving the bearing on the sides of the threads.

When the point and anvil are together as shown in Fig. 81, the line through the plane A B represents the zero position and moving the measuring point back any fixed distance separates by

that amount the position of the plane that cuts the movable point from the same plane in the anvil.

As a sharp V thread is in section an equilateral triangle, the sides of the threads are equal to the pitch of the thread and the depth of the thread is equal to the side multiplied by $.866 = \text{the pitch} \times .866 = .866/N$ where N equals the number of threads per inch.

As the pitch line is one-half the depth of the thread on each side, the pitch diameter is the whole diameter less the depth of one thread. The caliper reading is therefore in any case the full diameter less the depth of one thread, which is determined as above.

For the United States Standard threads the pitch diameter is greater than for the V thread, inasmuch as it is flattened at top and

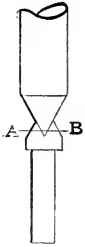

FIG. 81.

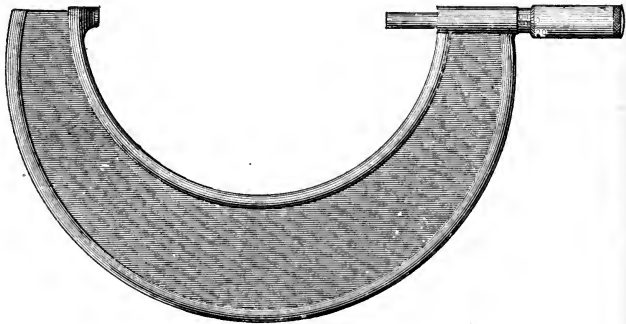

FIG. 82.

root an amount equal to one-eighth of the pitch, thus making its depth one-fourth less than with the V threads. In determining the caliper reading for the United States S thread the constant is three-fourths of $.866$, or $.6495$, which divided by the number of threads and subtracted from the normal diameter gives the caliper reading as before.

Micrometer calipers of greater capacity than 2 inches have until recently, been little used. The introduction of the reliable, moderate-priced caliper, shown in Fig. 82, has met a popular demand for a yoke caliper of large size. It is a much more convenient tool for the workman than fixed caliper gauges. The yoke section is a bulbed I, which gives light weight, strength and

an excellent grip for the fingers. All adjustments for wear are in the head. For the table of decimal equivalents usually stamped on the yoke the following is substituted: Every fifth graduation on the barrel (.125 inch) is extended, and beginning at the zero marked 1 to 8, inclusive, thus giving an inch graduation by eighths. On the thimble are stamped the decimal equivalents for 1-16 inch, 1-32 inch and 1-64 inch, thus giving a contracted conversion table, the application of which requires at most only a simple calculation, thus, $23\text{-}32$ inch = $\frac{5}{8}$ inch + 1-16 inch + 1-32 inch. Set to the 5 and add the sum of the decimal equivalents for 1-16 inch (.0625 inch) and 1-32 inch (.0312 inch) = .0937 inch, which should be set back from the $\frac{5}{8}$ in the ordinary manner. This does not interfere with reading the caliper decimally in the ordinary way.

This caliper is made in twelve sizes, from 1 to 12 inches. The

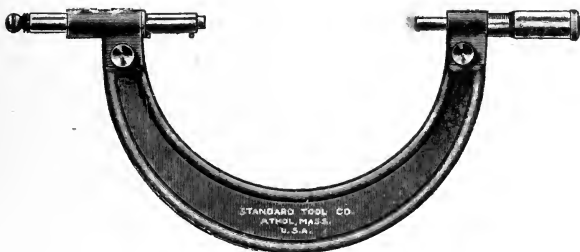

FIG. 83.

1-inch to 6-inch sizes have yokes made from drop forgings of bar steel, and the larger sizes have yokes made of steel castings, all neatly finished and japanned. The face of the anvil is formed by a hardened steel plug of same diameter as the end of the measuring point.

The measuring range of each size is 1 inch, and for adjustment of all sizes other than the 1-inch caliper, standard end measure test pieces are required.

In calipers of this class the yoke is frequently lagged with wood or hard rubber to prevent the expansion and consequent inaccuracies that arise from handling with the warm hand.

A form of yoke micrometer in which provisions are made for a wider range of measurements is shown in Fig. 83. It is made in four sizes having a range of from 0 to 12 inches. The anvil is mounted in the end of a spindle, which is provided with stops

exactly 1 inch apart. A slight turn of the anvil spindle when either stop is to be used brings it firmly against its seat, in which position it is securely clamped.

Beam micrometer calipers are illustrated in Figs. 84, 85 and 86.

In each case the regular micrometer head of one inch capacity

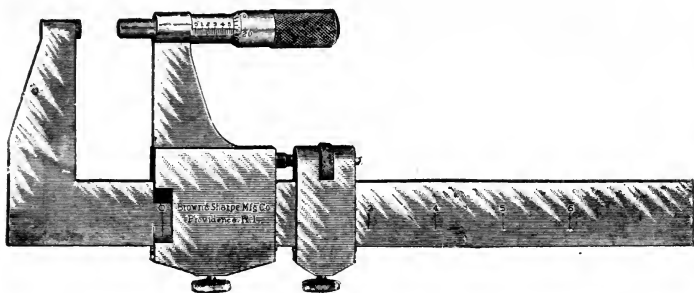

FIG. 84.

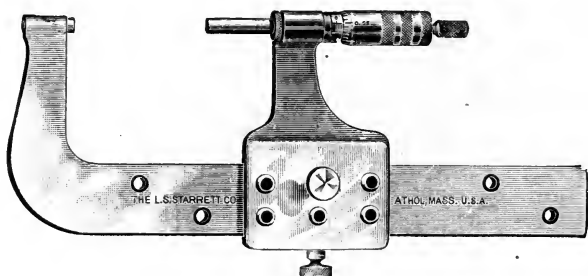

FIG. 85.

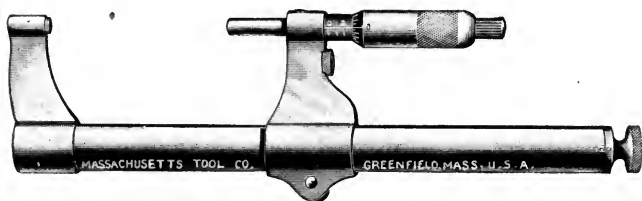

FIG. 86.

is mounted upon a suitable slide which moves over the beam of the instrument. Three distinct methods, however, of making the several inch settings are employed.

In Fig. 84 the inch settings are made to accurately graduated rulings on the beam.

In Fig. 85 these settings are made by inserting the tapered steel pin in the holes in the sliding jaw and their corresponding holes in the beam. A separate set of holes is used for each setting. The holes are bushed with hardened steel bushings ground and lapped to fit the tapering plug.

In Fig. 86 is shown a beam micrometer of six inches capacity. The sliding jaw carries a regular micrometer screw head of one inch range and moves over a cylindrical barrel in which is an accurately bored hole to receive three end measure test pieces, one, two and three inches long. An arm on the head extends into the bore through a radial slot in the cylinder, and by means of the test pieces enables the setting of the head at fixed distances

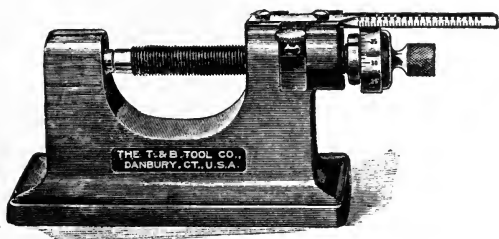

FIG. 87.

one inch apart. A zero mark on the cap and barrel determines the proper pressure on the test pieces for each setting.

The capacity of the beam micrometer for measuring flat work is limited only by the length of the beam. For round work the height of the jaws limits the diameter, usually to about 4 inches, since in order to keep the weight of the instrument within reasonable limits it is not advisable to make the jaws much greater than 2 inches high.

In Fig. 87 is shown a bench micrometer for measuring all sizes, from zero to 2 inches. It has a twenty-thread screw with fifty divisions on the dividing head, thus giving direct readings to 1-1000 of an inch. The zero adjustment is obtained by turning the head on the screw, it being held in position by a lock nut. As a bench machine its simplicity and convenience recommend it for general shop use.

The Pratt & Whitney standard measuring machine shown in Fig. 88 is an instrument of precision for originating and duplicating standard dimensions. It is a beam micrometer of the greatest refinement as to design and construction.

The bed is very heavy and rests upon three neutral points to overcome flexure and effects of changes of temperature. Resting on the side of the bed is a standard measurement bar in the surface of which are inserted hardened steel plugs at intervals of one inch. On the polished surface of each plug is a very fine ruling, the distance from ruling to ruling being one inch at 62 degrees Fahrenheit within a limit of error of 1-50,000 of an inch. To one end of the bed is secured a headstock which carries the

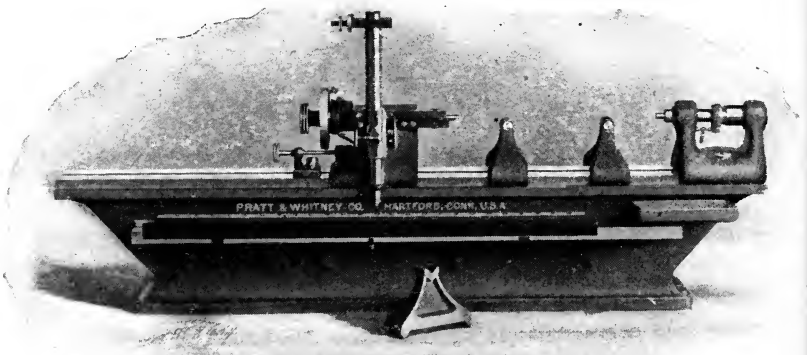

FIG. 88.

fixed measuring point. This point is secured in a plunger backed up by a light helical spring. Secured to the plunger is an auxiliary jaw which holds between its face and the face of another jaw secured in the head a small cylindrical plug gauge by friction alone. The tension of the spring is sufficient to hold the small gauge at an angle from the vertical.

The movable head carries the micrometer which consists of a 50-thread screw and a dial having 400 divisions with an adjustable zero arm. The microscope with micrometer eyepiece is secured to the movable head in such a position as to cause its line of sight to pass over the rulings on the plugs when the head is moved from end to end of the bed.

In obtaining the zero setting the micrometer screw is run all the way out and the zero on the dial made to coincide with the zero on the adjustable arm. The measuring points are next brought in contact, approximately by means of the fine adjusting screw shown at the rear of the movable head and exactly by a slight movement of the micrometer dial. When the pressure between the measuring points is just sufficient to allow the "sensitive piece" above referred to to drop to a vertical position but not to fall out, the zero on the adjustable arm is made to coincide with the zero on the dial and the hair line in microscope to coincide with the ruling on the first plug.

In making a measurement the movable head is carried back and the microscope made to read on the ruling on the plug which

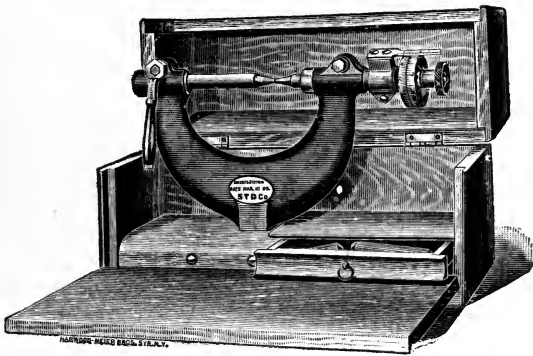

FIG. 89.

corresponds to the whole number of inches to be measured; the "sensitive piece" is inclined from the vertical; the piece to be measured is placed upon the supports shown and the measuring points adjusted against it with just the amount of pressure required to cause the "sensitive piece" to swing to the vertical position. The reading is then taken. The slightest excess of pressure will cause the "sensitive piece" to drop out.

The direct reading on the dial is 1-20,000 of an inch, and one-half of this amount can be quite readily approximated to. In dealing with such minute variations in dimensions the utmost care must be observed in the manipulation and especially in the effects of changes in temperature.

Fig. 89 shows the Sweet's measuring machine, which is made

in 4, 6 and 8 inch sizes, and may be classed under the head of bench micrometers. This instrument, which is intended for practical shop uses, reads as regularly furnished to 1-1000 and 1-1280 of an inch. When required a vernier is used on the head, which gives readings of 1-10,000 of an inch. The range of measuring screw is 1 inch, test pieces being furnished for setting the sliding anvil to the inch zero positions.

Fig. 90a shows a portion of the measuring head. A 1-10 inch pitch trapezoidal thread measuring screw is employed. This form of thread gives a square bearing on its work side, and the quick pitch facilitates rapid adjustment. The knurled thumb nut drives through a friction. The outer disc of the dial is divided to hun-

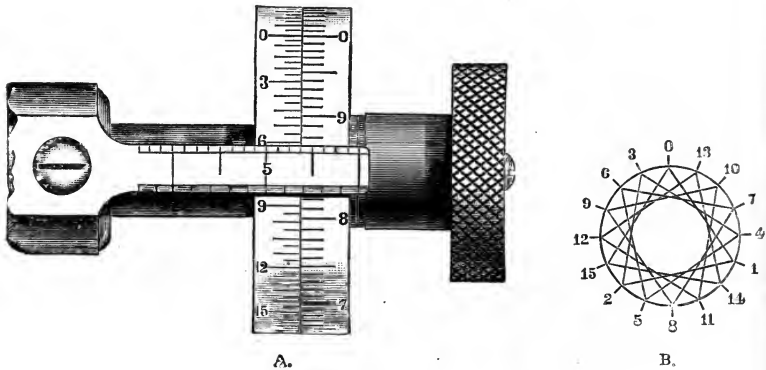

FIG. 90.

dredths, thus giving for each division 1-100 of 1-10 = 1-1000 of an inch. The reading is made on the front edge of the index bar.

For the fractional readings the left-hand disc is used. It is divided into 128 parts, and every eighth division numbered, as shown in Fig. 90a. One revolution of the screw equals 1-10 of an inch = 128 divisions on the dial, whence one division = 1-10 of 1-128 = 1-1280 of an inch. The upper edge of the index bar is graduated to sixteenths for convenience in getting the approximate setting. All readings are, however, made on the front edge of the bar.

Referring to Fig. 90b: Following the straight lines from 0 to 1, 2, 3, etc., back to zero (16) five complete revolutions are made, which carries the screw back $\frac{1}{2}$ inch. Then every five divisions are $\frac{5}{16}$ of 1-10 = 1-32 of an inch at the measuring point, and

every $2\frac{1}{2}$ divisions equals $1-64$ of an inch; and since each division is divided into eight equal parts on the disc, $1-128$, $1-256$ and $1-1280$ may be found by using 10, 5 and 1 of these small divisions, respectively. For example, in Fig. 90 the reading line is $6-32$ inch beyond the $16-32$ (.5) inch mark = $22-32$, and the 6 on the disc should nearly coincide with the $22-32$ division. Bring the 6 to read at the lower edge, and the measuring point will be $22-32$ inch from the anvil. If $23-32$ inch had been wanted, the 7 on the disc would have been brought around to the reading edge. If $47-64$ inch was required, the 7 would be carried past the reading edge twenty divisions and in like manner ten more divisions would make it read $95-128$ inch.

Any error in the pitch of the measuring screw which would

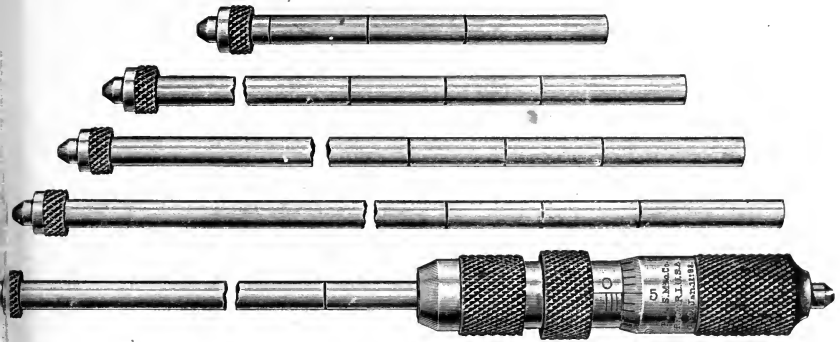

FIG. 91.

affect the number of turns per inch is corrected by setting the index bar at an angle with the axis of the screw. Assume, for example, that the ten turns of the screw advance the measuring point $1-1000$ inch too far. The screw is too long, and less than ten revolutions should be made by an amount equal to one of the divisions on the outer disc. The outer end of the index finger will be raised this amount above the inner end graduation. This corrects the error proportionately from end to end of the screw.

An example of the inside micrometer caliper is shown in Fig. 91. It is used for making inside measurements and reads to thousandths through a $\frac{1}{2}$ -inch range. The instrument shown with its extension rods makes any measurement between 3 and 6 inches. The nut and check nut on the extension rods may be adjusted down to compensate for any wear of the points.

CHAPTER VI.

GAUGES AND INDICATORS.

There is nothing more confusing to the young mechanic than the use of the several systems of gauges used in designating the sizes of wire, machine screws, drills and plate thicknesses. Unfortunately, most of these dimensions differ from each other for corresponding numbers by comparatively small amounts, yet an amount sufficient to cause error if the one is mistaken for the other. The following table gives for comparison values for only a few numbers under each of the several gauges in most common use:

No. of Gauge.	American or Brown & Sharpe Gauge.	English, Birmingham or Stubs' Wire Gauge.	Imperial Wire Gauge.	Stubs' Steel Wire Gauge.	Stubs' Drill Gauge.	United States Standard Plate Gauge.	Steel Music Wire Gauge.	Standard Machine Screw Gauge.
1	.2893	.3	.3	.227	.228	.28125	.0156	.071
5	.1819	.22	.212	.204	.2055	.21875	.0202	.124
10	.10189	.134	.128	.191	.1935	.14062	.027	.189
15	.05707	.072	.072	.178	.18	.07031	.0345	.255
20	.03196	.035	.035	.161	.161	.0375	.0434	.321

The dimensions are purely arbitrary. The American, or Brown & Sharpe gauge, was brought out in the production of a gauge to overcome the irregularities in spacing of the Birmingham wire gauge. In this gauge the dimensions increase by a regular geometrical progression. The largest dimension is No. 0000, which equals .46 of an inch. The next smaller number, 000, is obtained by multiplying .46 by the constant .890522. This product again multiplied by the same constant, gives the next smaller number, and in like manner each number is the product of the preceding number and this constant. A comparison of the English and American gauges is best shown in Fig. 92, where the peculiar irregularities of the former are plainly shown.

The Imperial wire gauge differs but little from the English. It was adopted by the English Board of Trade in 1884 as a substitute for the Birmingham gauge. The Stubs' steel wire gauge

differs materially from those above cited. Its range carries it from No. 1 to No. 80, variations in dimensions being indicated to the nearest thousandths of an inch. The difference between consecutive numbers differs in dimensions from one to at

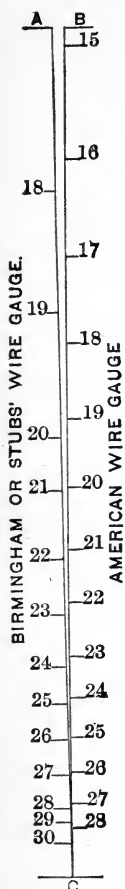
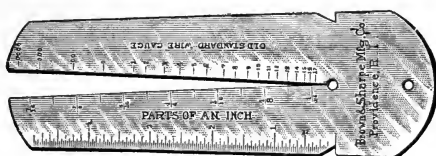

FIG. 92.



C.

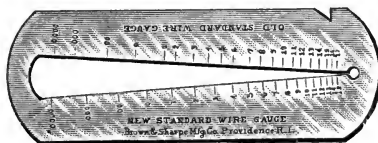
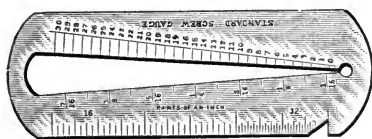

FIG. 93.

most only a few thousandths, the eighty numbers carrying it through but $.214$ of an inch.

It is extremely unfortunate that a single standard gauge could not be adopted and used to the exclusion of all others, at least in our own country, and thereby avoid all the confusion incident to the promiscuous use of the several so-called standards. Even

the manufacturers of brass and copper stock, who have adopted the American standard, do not confine themselves exclusively to this gauge, as much of their product is still gauged by the English system.

The Stubs' drill gauge varies from the Stubs' steel wire gauge by from 0 to 3 thousandths of an inch oversize, which is simply the average oversize, determined by a great number of measurements, of wire drawn through Stubs' wire gauge dies, and might be compared with a maximum limit gauge, as the dies, when worn to such an extent as to produce wire over the sizes indicated by the drill gauge, are replaced by new ones.

It will be noted that as the designating number of the gauge increases, the dimensions decrease for all except the steel music wire and machine screw gauges, which increase in diameter as the number increases. This also tends much toward confusion, and may be looked upon as another anomaly of the present gauge systems.

The gauges, or tools for indicating the gauge of wire or plates, are of two forms, the angular and the notch. The angular gauge is shown in Fig. 93. With this tool the measurement is made by passing the screw, wire or plate into the angular opening until it touches both sides; the reading opposite the point of contact giving the gauge of the material. When used for gauging plates, this gauge should be made with open end, as shown at C. On the one side is graduated the English and American standards, and on the other the machine screw gauge and parts of an inch. The notch gauge is shown at A in Fig. 94. In using this tool the article measured should just pass through one of the slots, the number opposite indicating the gauge. These gauges may be had with the decimal equivalent of each size stamped on the back of the tool, which will frequently be found a great convenience. Another form of notch gauge is shown at B in Fig. 94. This is called a rolling mill gauge, and is used for gauging sheet metals. They may be had either in the English or United States standard plate gauges.

As there is considerable wear upon gauges of this class, and especially those of the notch pattern, it is important that they should be made of good steel, carefully hardened and tempered. In order that tools of this character can be put upon the market at a reasonably low price, high accuracy requirements in their manufacture cannot be attempted. For all ordinary gauging they

will be found sufficiently accurate, and when greater exactness is demanded the micrometer caliper should be used, the decimal equivalent of the gauge required being taken from a table on the back of the gauge.

In Fig. 95 is shown a drill gauge, Stubs' drill sizes, from No. 1 to No. 60. A smaller size with holes from No. 61 to 80, is made. It may also be had with holes from 1-16 to $\frac{1}{2}$ inch, varying by 64ths, the latter being known as the "jobbers'" drill

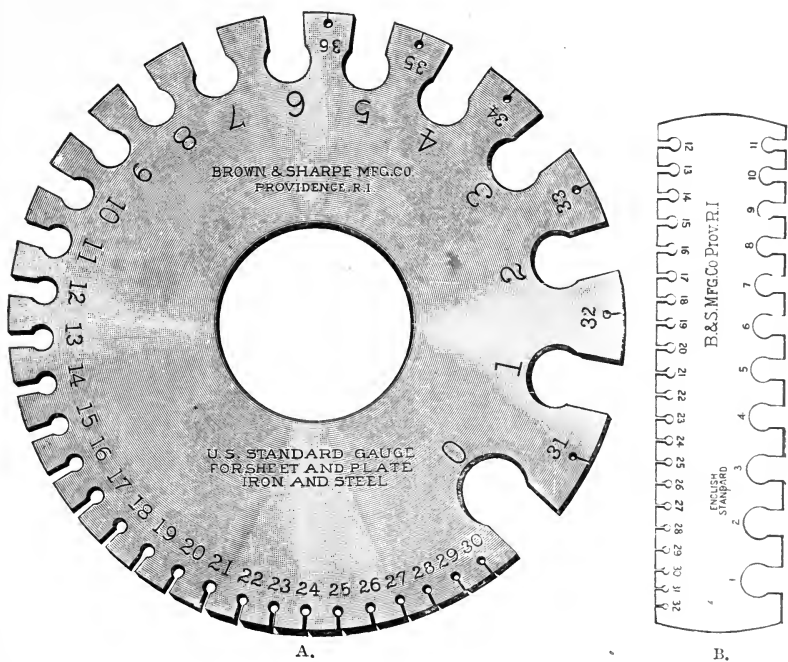

FIG. 94.

gauge. As it is not practical to attempt to stamp the sizes on very small drills, these gauges are quite necessary.

The nut and washer gauge shown in Fig. 96 is so graduated as to show readily the diameter of holes within its capacity. A very convenient feature in this gauge is the dimensions giving sizes of holes to tap United States standard threads. A gauge of this kind will be found excellent for measuring small holes or narrow slots, which are too small to be calipered, and frequently in inaccessible places where they cannot be scaled.

In Fig. 97 is shown a center gauge, which, as its name indicates, is used for gauging lathe and other machine centers, in turning or grinding them. It may also be used as a gauge for

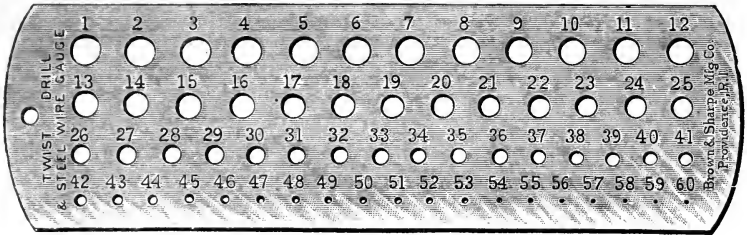

FIG. 95.

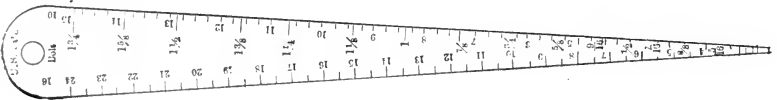

FIG. 96.

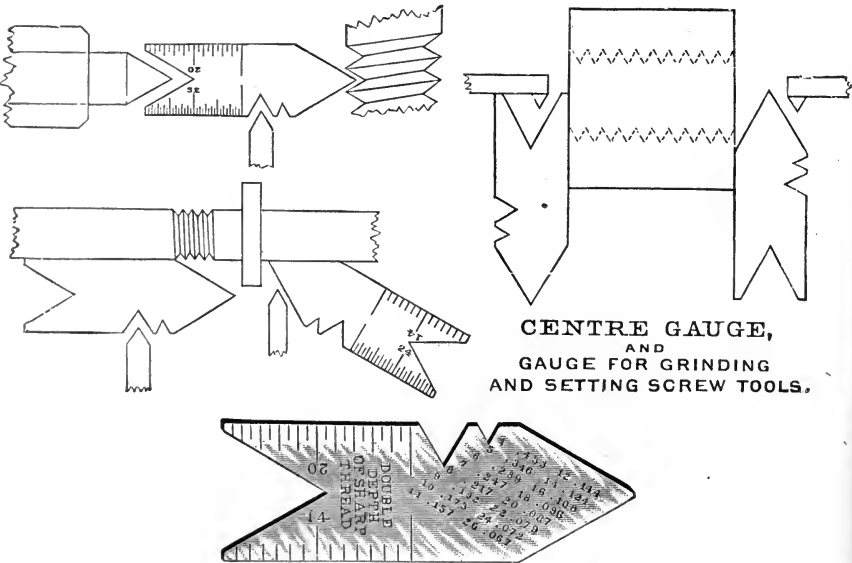

FIG. 97.

grinding and setting threading tools, a number of its uses in this connection being clearly shown in this figure. The angles are 60 degrees, and the table of equivalents shown is to determine the

proper diameter of hole for tapping full V threads. In this table the numbers in the first and third columns are threads per inch, and those in the second and fourth columns the double depth of V threads of the corresponding pitches. Thus the tap drill for



FIG. 98.

a $\frac{3}{4}$ tap, 10 threads per inch, would be $.75 - .173 = .577 = 37\text{-}64$ inch.

The screw thread gauge is shown in Fig. 98. The one 60

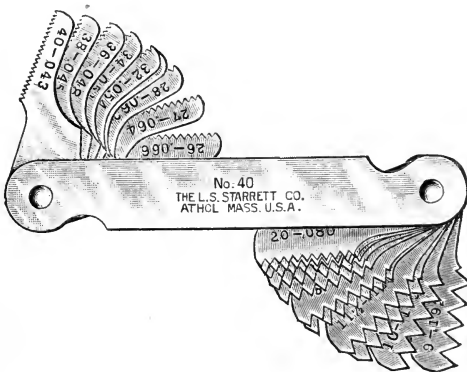

FIG. 99.

degree V notch will gauge all V threads; the others, however, are flattened at the root by the amount the top of the thread is cut off in the various pitches of the United States standard

thread. These gauges are for use in grinding threading tools, and may be had for worm, Whitworth and "Acme standard" threads.

The screw pitch gauge, Fig. 99, has a large number of thin blades, which fold up into a suitable handle. Each blade has two or more teeth, of the pitch corresponding to that stamped on the blade. By direct comparison with a screw thread the exact pitch may be determined without the danger of errors that arises when the threads are counted over the edge of a rule. The decimal following the pitch number on each blade is the double depth of the thread. The thickness gauge, shown in Fig. 100, consists of a number of thin steel leaves, varying by thou-

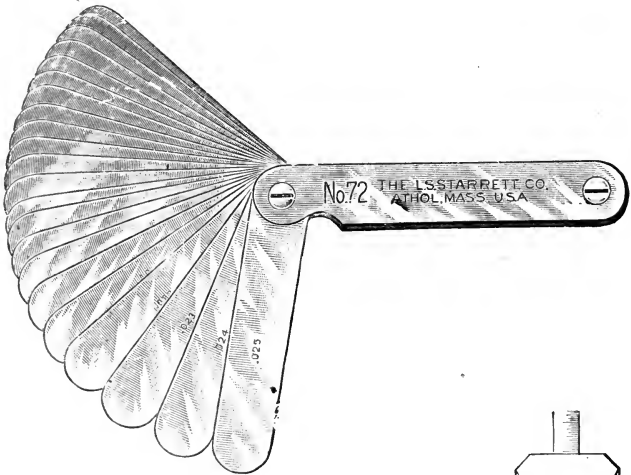

FIG. 100.



FIG. 102.

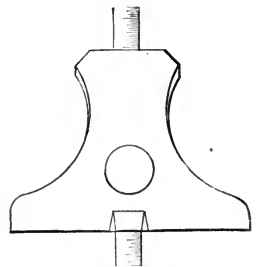

FIG. 101.

sandths in thickness. The leaves may be used singly or together, thus making any thickness desired within the limits of the tool. The value of a tool of this kind can only be learned by having one in the vest pocket, where its convenience to hand will find many chances for its use.

The depth gauge, an example of which is shown in Fig. 101, is used for measuring the depth of holes or recesses. The blade should be narrow, and for general work graduated on one edge to 64ths and on the other to 100ths. The beam or head, when six inches long, will meet most general requirements. This tool will be most highly appreciated by the man who has often attempted to measure carefully the exact depth of a recess by holding two

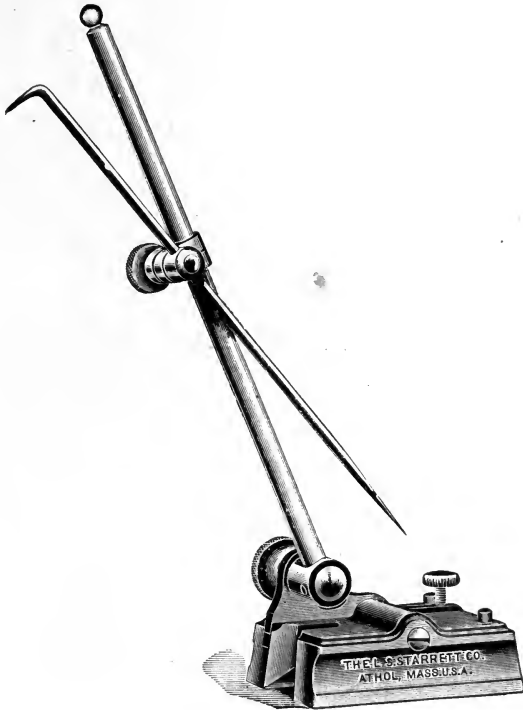

FIG. 103.

slippery steel rules at right angles to each other between his thumb and fingers, and attempted to read the one over the edge of the other. For very accurate depth measurements these gauges are made in a micrometer pattern, which is graduated to read directly to thousandths.

While on the subject of gauges we should not overlook the simple yet useful one shown in Fig. 102. The scratch gauge consists of an arm, preferably graduated, carrying a sliding guide, which can be clamped at any position on the arm, and provided

with a short, hard and sharp scriber at the end. This tool is used in ruling lines parallel with the edge of work.

In Fig. 103 is shown one of the many types of surface gauges. Although this tool comes last in the long list of useful gauges above illustrated, it is by no means the least important, as the machinist undoubtedly uses it more in general machine shop operations than all the others combined. The principal use of this tool is in determining the parallelism of one plane with another, usually the surface of the work with the machine table, housing, cross-rail or other reference planes. In testing, erecting and setting up work on machine tools the surface gauge is indispensable.

The simpler the gauge is made the better it is, as numerous

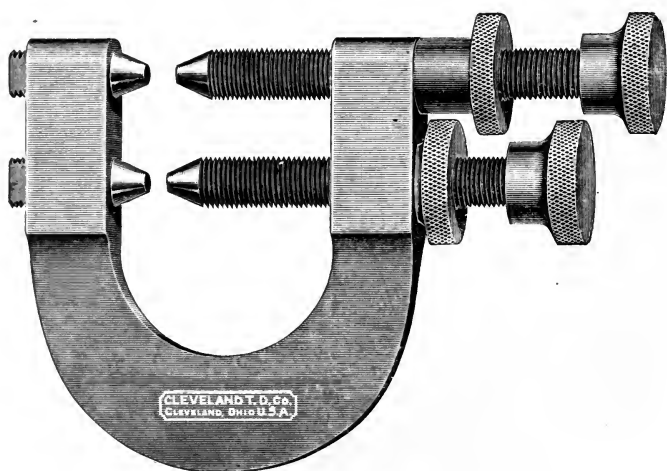

FIG. 104.

tricks and devices on a tool of this kind usually complicate and decrease rather than increase its value. In setting the point of the needle to a line or point the clamping screw should be so adjusted that the needle moves smoothly yet with considerable friction. The power applied to the needle to turn it should be on the opposite side of the fulcrum from the work, as in that case the spring of the needle is outside of the fulcrum and the point stays where placed. If the force is applied inside the fulcrum the spring will make it difficult to set the point as desired. When, as with the gauge shown, a screw adjustment is provided, the exact setting is made with this adjustment.

In Fig. 104 is shown a form of adjustable limit gauge. When used as a limit gauge the outer screw is adjusted to the maximum allowable dimension and the inner screw to the smallest allowable dimension. The work to pass inspection must pass through the outer gauge and not through the inner. This tool when used as a snap gauge is provided with but one screw. It is customary to set the gauge on a plug or other standard and by means of the jamb nut, lock the screw in position. The screws and anvils are hardened and ground.

A test indicator is a tool used in determining small variations from the true rotation of a cylindrical surface and irregularities or inaccuracies in its cylindrical truth. It can also be used in determining the inaccuracies of a plane surface, and small

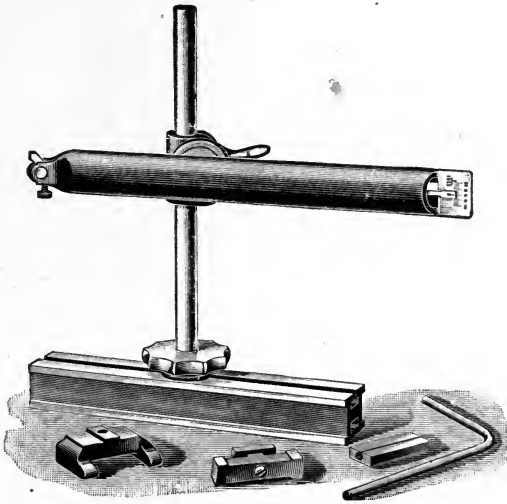

FIG. 105.

amounts of end or lateral motion, as for example, the end motion of a spindle or the deflection, give or wink between gibbed surfaces, etc. These tools are of two types; those which simply indicate, and those which give a reading that shows the exact amount of the error or untruth. In Fig. 105 is shown an instrument of the latter class. The adjustments of this tool are quite evident from the figure. The long pointer, the one end of which moves over a graduated arc with readings to one one-thousandth of an inch, as fulcrumed, bears the hardened point, which comes

in contact with the surface to be tested. The reading is magnified by the long pointer, and the zero of the scale is at the center of the arc, which reads ten-thousandths of an inch each side of this point. A light spring, secured to the pointer, and held between adjusting screws near the pivot, provides for the convenient adjustment of the pointer to the zero reading, no matter what the position of the arm.

Instruments of this character must be carefully made, and are of great value in the erection and testing of accurate machinery. When, however, only an indication of untruth is required, as in the chucking, centering or setting up of work, a much cheaper tool serves the purpose, as for example, the one shown in Fig. 106. In this tool the pointer is held in a universal socket, which is carried on the end of a bar of suitable form to clamp in the tool post of the lathe. If the point is brought against the rotating work, the amount of motion at the outer end of the pointer indicates

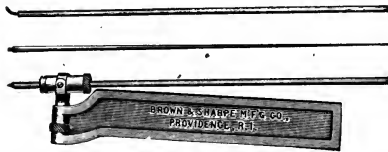

FIG. 106.

the extent to which the work is out and the way in which to move it in truing. It is a superior method of truing nice work, which will not injure its surface, as is so apt to be the case when trued to the point of a lathe tool.

One of the neat applications of this tool is in the centering of a piece of work, in the chuck or against the face plate, to a point. The sharp end of the indicator pointer is set in the point to be centered, and the work revolved. This causes the outer end of the pointer to describe a circle, the diameter of which determines how much the point is out of center. By properly setting the instrument this circle will be described around the tail center, and when the work is exactly centered the pointer remains stationary in front of the tail center.

The above serve to illustrate a few of the many applications of an exceedingly satisfactory, yet not extensively used, class of test tools.

CHAPTER VII.

RULES, SQUARES AND OTHER SMALL TOOLS

No tool in the machinist's kit is more often referred to than the steel rule. Upon it he depends in making all ordinary measurements and for the setting of his calipers and dividers. In Fig. 107 is shown a standard steel rule or scale. They are made in various lengths, from one to forty-eight inches, with any desired gradation, not exceeding 1-100 of an inch in fineness. For shop work the gradation most used is eighths, sixteenths, thirty-seconds and sixty-fourths, on the four corners of the scale. A scale graduated sixteenths, thirty-seconds, sixty-fourths and one-hundredths is convenient, as the 100th graduations will serve for measurements when required in decimals. Where all the work is measured by fractions, however, the former is the safest



FIG. 107.

ruling to use, as there is then no danger of inadvertently mistaking a tenth for an eighth division, etc. For this reason, rules graduated in twelfths and fourteenths should not find their way into the machinist's tool box, as he will not have occasion to use these divisions, and their presence will call for greater care in selecting the proper division, with the loss of time incident to changing ends with and turning over the rule in order to get at the division required. The end graduation, as shown in Fig. 108, is frequently very convenient in taking measurements in recesses where the length of the scale would prevent the use of the regular graduation.

Standard steel rules, as made by our leading makers, are remarkably accurate. To be sure, the length varies slightly with the changes in temperature, but these changes are not ordinarily great, and the material measured is usually affected about the

same amount in the same direction; so we may feel assured that any errors arising from this source are well within the limit of the personal error of the operator in making a measurement.

The late refinements in the manufacture of steel rules have enabled the production of very accurate tempered ones on comparatively thin steel. What we usually know as the standard rule, however, is graduated on thick steel, and is not tempered. The tempered rules possess the decided advantage of resistance to wear. An untempered rule is easily mutilated, and soon rounds its corners through wear, making its ends unfit for reference. The tempered rules may be classed as heavy, tempered, semi-flexible and flexible. The heavy are about one-tenth; the tempered, one-twentieth; the semi-flexible, one-fortieth, and the flexible one-eightieth of an inch thick. For general work the heavy or tempered will be found best suited. The flexible are

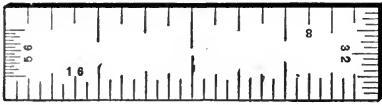

FIG. 108.

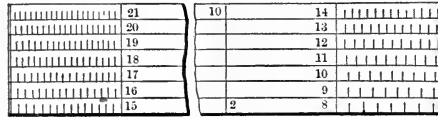

FIG. 109.

graduated on one side only, and are of value in measuring curved or irregular outlines.

In this connection it will be well to call attention to the gear rule shown in Fig. 109. Its application is in the sizing of gear blanks and where, by rule of thumb, two diametrical pitches are added to the pitch diameter of the gear in obtaining the whole diameter. Thus, if the pitch is No. 7 diametrical and the number of teeth 34, then the pitch diameter = $34 \div 7 = 4 \frac{6}{7}$ inches, and the blank or whole diameter = $4 \frac{6}{7} + 2 \div 7 = 5 \frac{1}{7}$ inches, which can be taken directly from the scale. This rule is of great convenience where many blanks for varying pitches and numbers of teeth are to be sized.

In Fig. 110 is shown a neat kink which will be found of value in taking measurements similar to the ones shown in the figure, as well as for setting inside calipers. The hook may be quickly removed. It is hardened, and in connection with a tempered rule forms a reliable tool.

In Fig. 111 is shown a standard steel square. This tool is

made of cast steel, tempered and accurately finished. The two sides of the angle are called the blade and the beam, the length of the blade being measured from the inside of the beam. The form shown in Fig. 112 is preferable when the length of the blade exceeds eighteen inches, as it can be more readily repaired in case of accident.

Either of the methods shown in Figs. 113 and 114 may be used by the machinist in testing the accuracy of a square, the latter being the more exact of the two. In Fig. 113 A is a plane plate

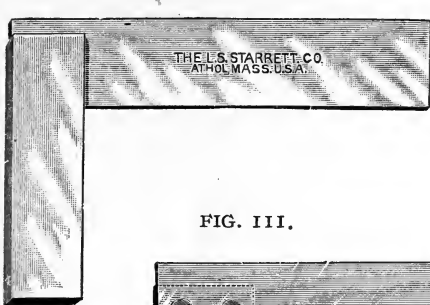

FIG. 111.

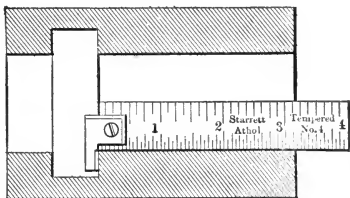

FIG. 110.

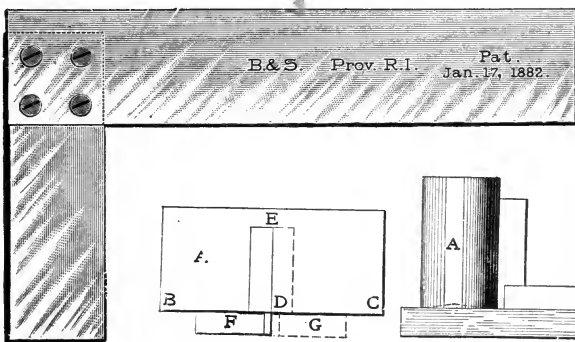

FIG. 112.

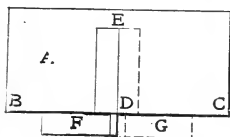

FIG. 113.

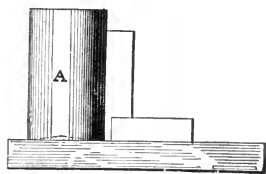

FIG. 114.

of iron with one edge, B C, perfectly straight. The surface A should be smooth and true. The square is first applied as shown at F and a fine line D E scribed along its edge. It is then reversed to position G, when, if the edge exactly lines with the ruling D E, the square is correct. If, however, the edge and line do not coincide, the square is inaccurate by one-half the variation as shown. Since this method depends for its accuracy on the eye of the operator it cannot be called an exact one. The method shown in Fig. 114 reduces the amount of the personal error, since the eye detects readily the ray of light that passes through an exceedingly small opening. In the figure the cylin-

der A, which has been ground accurately parallel and faced on the lower end slightly dishing, rests on a plane surface, a standard surface plate being best suited to this purpose. As the surface of the cylinder is at right angles to the surface of the plate the square can be compared with this angle by placing it as shown in the figure.

For most general work the thin steel squares shown in Fig.



FIG. 115.

115 serve very well. They are cut from sheet steel, carefully made but not hardened, and are usually graduated, as shown, on both sides.

The combination square shown in Fig. 116 is a satisfactory

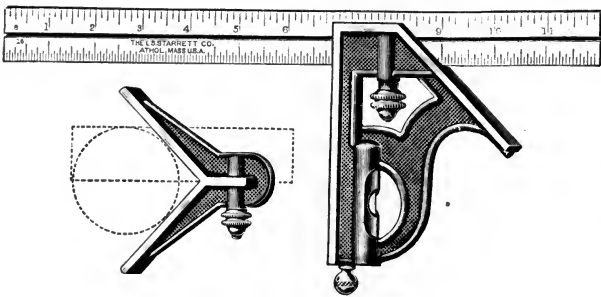

FIG. 116.

tool, which, with careful use, retains its accuracy. The blade is readily adjusted to any required length, which is of special value in transferring measurements. The 45 degree angle is of frequent value, as is the centering head which is used on the blade

as shown. The blade is a standard steel rule, splined to receive the key which draws the edge of the blade close to its seat in the beam.

In Fig. 117 is shown a box square, or as it is more commonly known, a key seat rule. With this tool lines upon a cylindrical surface parallel with the axis may be drawn. While it is intended for use on external surfaces, as shown at A, Fig. 118, it will at times serve a good purpose on internal, as shown at B,

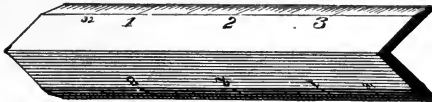
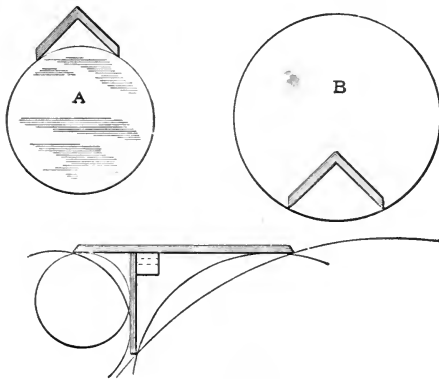

FIG. 117.



FIGS. 118 AND 119.

same figure. A form of box square, shown in section in Fig. 119, possesses the advantage of wider range than that of Fig. 117.

In Fig. 120 is shown a pair of key rule blocks attached to a common steel rule thus making a very simple and efficient key seat rule.

For a great deal of his work the machinist is satisfied with using the edge of a good steel rule to determine its straightness; but when he wants to know to a certainty that the work is straight it is a source of great satisfaction to be able to refer to a standard straight edge. Such a straight edge is shown in Fig. 121. It is a piece of steel of thickness depending on its length, nicely finished, with its two edges parallel with each other and

straight. They are regularly made up to six feet in length, such a tool being about three inches wide by three-eighths of an inch

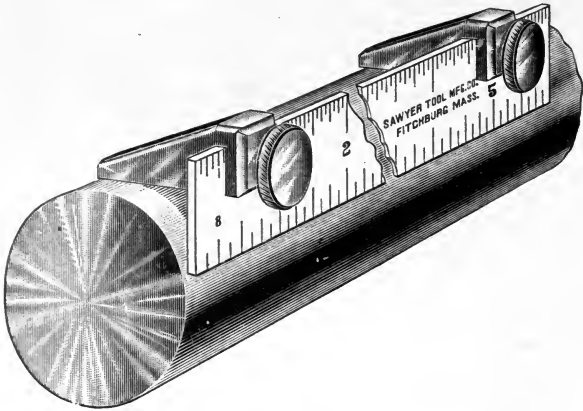

FIG. 120.

thick. Up to four feet in length they are frequently tempered on the edges.

A cast iron or surface straight edge is shown in Fig. 122.



FIG. 121.

These tools are designed for an entirely different class of work than the one shown in Fig. 121. The edge is wide and scraped to a true plane, with the body so formed as to best resist deflec-

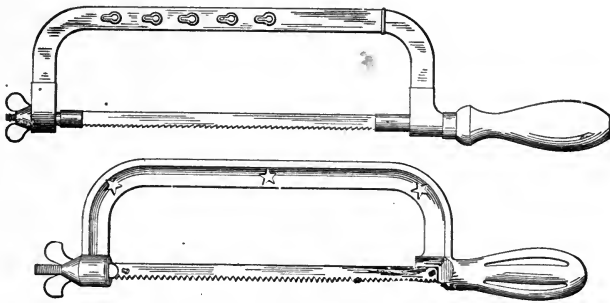

FIG. 122.

tion from its own weight and distortion due to changes in temperature. These straight edges are used in the production of long plane surfaces like planer bed V's and lathe shears, pre-

cisely as the surface plate is used in the production of broad plane surfaces, and they are generally much larger and heavier than the style shown in Fig. 121.

Hack saws are used for severing purposes, both by hand and power, the comparatively recent introduction of the power hack saw machine having increased many times the possible usefulness of the hack saw blade, a cut of which is shown in a hand frame in Fig. 123. The original Stubs' and German blades were soft enough to be sharpened by filing, were made of excellent material, and were high in price. Their expense and the trouble required to keep them properly sharpened limited their use to a narrow range. The bringing out of the modern hard blade, at a price sufficiently low to warrant throwing it away as soon as it became too dull to do satisfactory work, has practically super-



FIGS. 123 AND 124.

seded the old blade and made the hack saw one of the most important tools in the machinist's kit.

Hack saw blades are made with fourteen teeth per inch for general work. When, however, they are to be used on tubing or thin metal a greater number of teeth is advisable, as they will not bite so freely, and the danger of stripping the teeth is much less. For this purpose blades having twenty-five teeth per inch may be had.

As with a file, the fineness of the bite depends on the number of teeth in contact with the work. The judgment of the operator must, therefore, determine what pressure to apply on the saw for the varying conditions of cut. As with other cutting tools, the hack saw does more work and stands up to it better when the

pressure is sufficient to make the teeth cut free, rather than scrape and glaze the surface, as is the result when the pressure is too light. The blade must be strained in the frame to prevent its kinking. The strokes should be uniform, not exceeding forty per minute. Oil should not be used on the teeth, as it decreases their cutting efficiency. Blades are regularly made from six to eighteen inches long, those exceeding twelve inches being little used. For any work the blade should be as short as possible, as the cost of the blade and danger of breakage increases with its length. Blades longer than eight inches for hand and twelve inches for power frames are seldom required. The frame should be stiff. In this respect the non-adjustable, or solid one, shown in Fig. 124, is preferable. All hand frames should be so constructed that the blade can be faced at right angles to the position shown in the figure, which is quite necessary when a deep cut is to be taken near the edge of the work.

Everybody uses the screw driver, yet how seldom, even among mechanics, do we find it properly ground. In Fig. 125 is shown

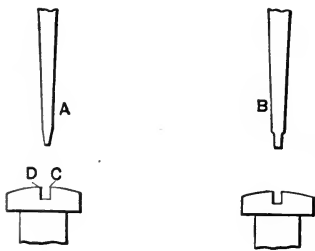

FIG. 125.

at A an edge view of the point of a screw driver, as usually ground; and at B a view showing how it should be ground. When the screw driver, A, is applied to the slot of the screw head it bears only at the center of the upper edges, C and D, of the slot, and the force required to turn the screw forces the driver out of the slot, which injures, if not completely ruins, the head of the screw. With B the

case is different. The parallel sides of the bit take squarely a hold of the sides of the slot and the screw is driven without injury, and with much less exertion than in the former case. The screw driver should be made of good tool steel and given a tough temper.

In Fig. 126 is shown that much used tool, the monkey wrench. This is a genuine wrench, and should only be used as such. It should never be used as a hammer; neither should it be expected to stand all the force a thoughtless workman can apply at the end of four feet of gas pipe slipped over the handle as an extension. It should, however, when properly closed on the flats of a nut,

stand safely all the average man would care to exert with both hands on the handle. As the nut often starts more easily with a quick jar or shock than by the application of a steady force; it is permissible to strike the end of the handle in the direction shown by the arrow with a rawhide or wooden mallet, or the end of a soft block of wood. The operator's judgment must determine how heavy a blow he can safely use.

The surfaces A B should be smooth, plane, and parallel with each other. These wrenches usually fail by bending at C. If the bend is slight, A can be most easily made parallel to B by filing, but when badly bent it should be carefully straightened.

The jaws of the wrench and the nut or square upon which it

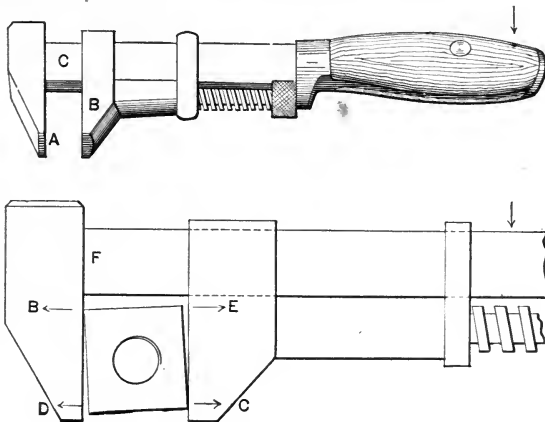

FIGS. 126 AND 127.

is being used will be least injured when the jaws are closed firmly on the work. This necessitates slackening them slightly and closing again every time the wrench is changed. By giving the hand a slight rolling motion around the handle, with the forefinger against the knurled head of the wrench screw, a sufficient amount of motion can be given to the sliding jaw to close on and release from the work without loss of time.

The sliding jaw, due to its long bearing on the shank, is much stronger than the fixed jaw, consequently the wrench should be operated in the direction of the arrow, Fig. 126. An examination of Fig. 127 shows that when turned as above indicated the maximum pressure comes at B and C, which places the shorter

leverage on the weaker jaw. If turned in the opposite direction the pressure comes at D and E, which increases the bending tendency at F, and also the pressure on the screw.

The great variety of combination wrenches on the market possess little merit. When we use a wrench we do not want to have a hammer, a screw driver, a nail puller, and a dozen other "useful tools" in our way at one time.

When finished standard nuts are to be turned the solid wrench is preferable to the adjustable, as it can be made to fit closely to the nut with less danger of injuring it. In Fig. 128 is shown a finished case-hardened, solid wrench. The angle of the open end is fifteen degrees with the length of the handle, which enables a hexagon nut to be turned when the wrench can be carried

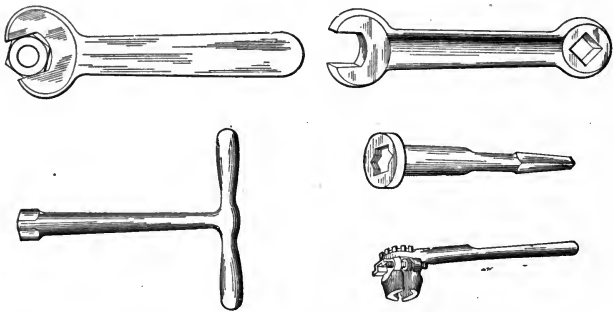

FIGS. 128 TO 132.

through thirty degrees only. These wrenches may be had double ended. The box wrench has a closed opening, as shown in Fig. 129. This particular form is commonly called a tool post wrench.

The socket wrench, shown in Fig. 130, is made for square and hexagon nuts and cap screws, which are to be operated upon in deep or inaccessible places. When a great many small nuts are to be quickly set, the socket wrench, in Fig. 131, operated in a bit brace, does the work rapidly.

It frequently happens that a nut must be turned which is in so inaccessible a place that the handle of the wrench can be carried through only a few degrees. In such cases, the ratchet wrench, shown in Fig. 132, serves its purpose well, the effect on the nut being much more satisfactory than when the set chisel and hammer are used. In the use of all solid wrenches they must fit the nut closely, as otherwise both nut and wrench will be injured, the nut rounding and the wrench spreading.

CHAPTER VIII.

DRILLS

The twist drill which has come into such universal use, has superseded the old, flat, forged drill which, for so many years, held without rival the first position as a tool for producing circular holes in metal. For the needs of its day, it served its purpose well. The advancements along mechanical lines demanded a better tool for this work, however, and the twist drill resulted, brought out in practically the same form as now used, the principal recent improvements being mostly in slight changes in form, and its more accurate production due to improved methods of manufacture.

The flat drill, as used for metal work, is generally of the form shown in Fig. 133. It is made from round stock, is forged thin at

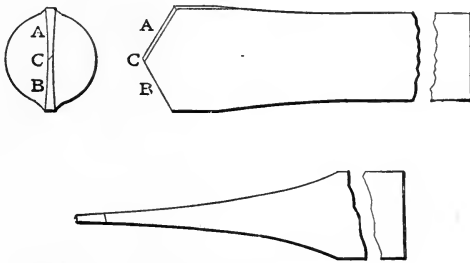

FIG. 133.

the lips, and ground as shown in the figure, with three cutting edges—A, B and C. This is a very accommodating sort of a tool, being capable of producing a number of holes of different diameters, yet, approximately equal to the width of the drill. The disadvantage of this adjustability, however, lies in the fact that the size of hole wanted cannot ordinarily be produced.

The flat drill has no lands, as that part of the twist drill between flutes is called, to steady and guide it in the work. Consequently, the hole drilled will usually not be round, and should the point of the drill strike the side of a small blow hole or soft spot in the metal being drilled, as frequently happens in working cast

metal, the point will drift toward this spot, thus making a hole that is neither round nor straight. This is shown at A in Fig. 134.

In order to drill holes approximately to size with the flat drill, it is necessary that the cutting lips be most carefully ground. The angle of the lips with the axis of the drill must be equal, otherwise one cutting edge will perform all the work, and will dull quickly, due to this double duty. The pressure on the cutting lip will crowd the point, causing it to revolve in a small circle about the center of revolution. This will cause the other flute to cut slightly at its outer end, thus producing a hole of larger diameter than the width of flat. This is shown at B, in Fig. 134.

The cutting lips should be of equal length, with their intersection in the axis of rotation of the drill. If one lip is longer than the other, the diameter of the hole drilled will depend on the

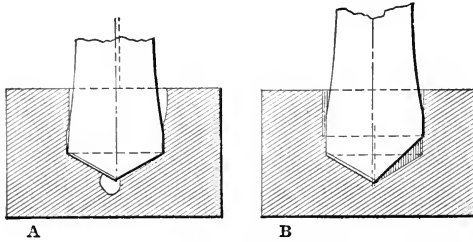

FIG. 134.

length of this long lip, as it will rotate about C, its central axis, as shown at A, in Fig. 135.

In case the intersection of the lips does not fall on the axis of the drill, the one lip is thereby made longer than the other, and the hole drilled will again be large, as the tool will spring an amount sufficient to allow it to revolve about C instead of its true axis, and the length of the long flute again determines the diameter of the hole drilled, as shown at B, in Fig. 135.

The first cost of the flat drill is small, and the results obtained by its use usually poor. Its only advantage lies in the fact that it can readily be forged and tempered to do work on extremely hard metals. The flat drill, ground thin and tempered hard, is a valuable tool for drilling hard steel or chilled iron, as it will in that form take hold of metal that the twist drill will not touch. It also makes a convenient extension drill, as it can be readily formed on the end of a long bar of steel.

The flat drill is not adapted to the drilling of deep holes, as it does not free itself of chips. It is largely used for roughing out cored holes, preparatory to boring, which work is very destructive, due to scale and sand, to the land clearances of twist drills. When so used in a lathe, the drill is held against the dead center and fed forward by the tail screw, the work revolving.

About 1860, twist drills, having milled flutes, were first placed

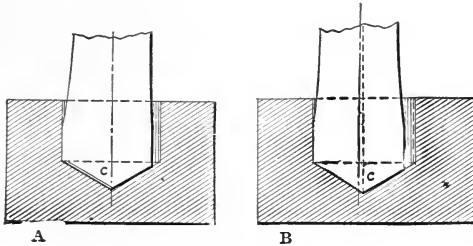

FIG. 135.

on the market. Previous to this date, however, drills with flutes produced by filing and the twisting of the flat stock had been used to a limited extent.

In Fig. 136 is shown a taper shank twist drill. A A are the flutes, B B the lands, C—the metal between the flutes—the web, D D the lips, E the shank and F the tang. The center or grinding line is the fine line running along the bottom of each flute, and



FIG. 136.

serves as a guide to the lips in grinding so their intersection will fall in the center of the drill.

The three clearances in the twist drill are: first, the "body clearance" of one-half to one-thousandth of an inch per inch of length of the fluted portion; second, the "land clearance" of about one-half of one circular degree as shown at A A in the end view, Fig. 137, and last, the "lip clearance" made by grinding back the ends G G of the lands, Fig. 137, to properly clear the cutting edges H H.

There are three cutting edges, H, H and C; of these C is the

least effective, as it is not a free cutting edge and grinds rather than cuts the metal. By reducing the thickness of the web at the point as shown in Fig. 138, thus making the cutting edge C short, the efficiency of the drill is materially improved. This is of greatest value with drills of large diameter where the webs are made thick to give the necessary strength. The points may be thus thinned by grinding on a small emery wheel.

The flutes of twist drills as usually manufactured are cut by milling from stock of round cross section. Numerous attempts have been made to produce a satisfactory hot rolled drill, in which the flutes are formed by passing the stock which is rectangular in cross section and heated to a forging point, through spiral rolls. A hot forged drill has recently been placed on the market. In

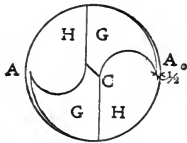

FIG. 137.

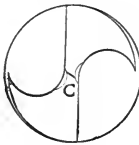

FIG. 138.

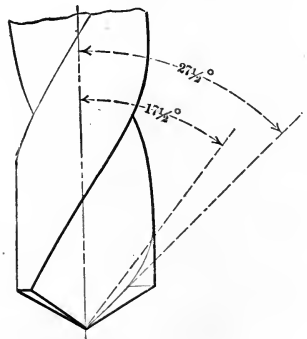

FIG. 139.

this tool the flutes and twist are produced by forging, and great strength and durability of cutting edges are the claims for it by the manufacturers.

In order to give the drill greater strength toward the shank, the web is increased in thickness from the point to the end of the flute. This thickening of the web is accomplished by gradually withdrawing the milling cutter from the blank as the cut advances. This makes the flute shallower at its upper end, with a gradually decreasing area of cross section from the point to the shank. This contraction of the flute area prevents the free delivery of the chips and consequent clogging of the drill. It is therefore necessary to make the flute area equal throughout its entire length. This is usually accomplished by making the pitch of the flute spiral uniformly greater from point to shank, and is

known as an "increase twist" drill. It is also produced by giving the flute a spiral of "constant angle," and increasing the width of flute toward the shank. This latter result is obtained by slightly changing the angle of the arbor carrying the flute cutting mill with the axis of the drill blank as the cut advances, and the mill is receded from the blank, in giving a web of increased thickness. This latter method makes the lands narrower at the shank end of the flute and thereby reduces somewhat the strength of the drill. On the other hand, it possesses the advantage of giving a constant angle of rake to the cutting lips as the length of the drill decreases. This is shown in Fig. 139, where the angle of rake is $27\frac{1}{2}$ degrees for either form of drill when the tool is new. When worn nearly to the shank, this angle in the "increased twist" drill is materially decreased, while for the "constant angle" drill, it remains the same.

For the small drills, the blanks are usually made from steel



FIG. 140.

wire. They are first cut in lengths and then given a body clearance by filing. The flutes are each cut separately. With the drills of larger diameter, the blanks are turned in a lathe and finished to exact diameter by filing. In cutting, they are held upright in a vertical machine, both flutes being cut at the same time. The clearance of the lands is made by either milling or grinding, and with the large drills both lands are relieved at the same time.

Drills are given a cutting temper the entire length of the flutes, and are carefully straightened after this process.

Twist drills are sometimes made slightly over size, and after tempering are ground perfectly straight. This adds little to the value over the properly straightened drill and increases considerably the cost.

Twist drills having more than two flutes are frequently used for enlarging drilled or cored holes. They are very efficient for this purpose, but as the lips do not intersect at the point, they cannot drill a hole from the solid stock. A three flute twist drill is shown in Fig. 140. They are regularly made in sizes from $\frac{1}{8}$ inch to 3 inches, varying by thirty-seconds. The straight flute

drill is one having the flutes cut parallel to the axis of the drill, and is in other respects similar to the twist drill. A straight flute drill is shown in Fig. 141. In Fig. 142 is shown a hollow drill which may be used to advantage in the drilling of deep or long holes, the chips passing out through the hollow shank.

Great care must be exercised in grinding the twist drill, as the



FIG. 141.

same troubles on a smaller scale as those shown in Figs. 134 and 135 for the flat drill will result from the improper grinding of the twist drill. The angle of lip clearance should be greater at the center than at the outer ends of the lips and must not be excessive, as in that case the drill bites too rank. If this angle is too small, however, the cut is not free and excessive heating re-

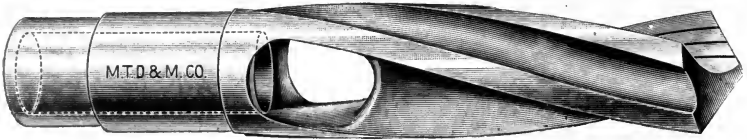

FIG. 142.

sults. The angle of the lip to the axis of the drill should be 59 degrees. This gives a straight cutting lip as shown in end view, Fig. 137. There are a number of drill grinders made that will grind drills satisfactorily. The experienced mechanic usually prefers to grind his drills by hand, depending upon his eye and

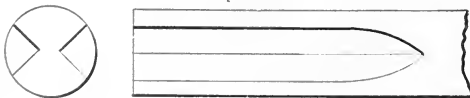

FIG. 143.

judgment for the proper angles and clearance. It is in this way that all new drills are ground before leaving the factory.

The standard shanks for drills are straight and taper. The taper shank is shown in Fig. 136. It is made in six sizes, and

known as the Morse taper, which is approximately $\frac{5}{8}$ inch per foot. The exact taper for the several sizes is given in the following table; also the limiting sizes of drills on which each taper is generally used:

TABLE OF MORSE TAPERS.

No. of Taper.	Taper per foot.	Smallest Drill using each Taper.	Largest Drill using each Taper.
1	.605	$\frac{1}{8}$	$\frac{1}{2}$
2	.600	$\frac{3}{16}$	$\frac{3}{4}$
3	.605	$\frac{5}{16}$	$\frac{1}{2}$
4	.615	$\frac{7}{16}$	2
5	.625	$\frac{1}{2}$	3
6	.634	Special.	Special.

In Fig. 143 is shown the shank of what is known as the grooved shank drill to be held in a special chuck. These grooves may also be applied to taper shanks. Drills are also made with square shanks to be held in ratchets and bit braces, also with shanks of various special forms.

Taper shank drills are made and carried in stock by 1-64 inch sizes from $\frac{1}{8}$ of an inch to $2\frac{1}{2}$ inches, and by 1-16 inch sizes from $2\frac{1}{2}$ inches to 3 inches. All sizes over 3 inches are special and made only to order. Straight shank drills are made by 1-64 inch sizes from 1-16 of an inch to $2\frac{1}{2}$ inches. A regular straight shank drill is the same length over all as a taper shank. What are known, however, as jobbers' sets, running from 1-16 of an inch to $\frac{1}{2}$ inch by 64ths, are considerably shorter than the regular lengths. The wire gauge sizes run from No. 80—the smallest twist drill regularly made—to No. 1. The No. 1 wire gauge drill is .228 or about 15-64 of an inch in diameter, while the No. 80 is but .0135, or a little more than 1-100 of an inch in diameter. This latter drill is an exceedingly delicate little tool, having flutes quite perfectly formed.

Drills are made in what are known as letter sizes, from A to Z, A being the smallest, .234 of an inch, and Z the largest, .413 of an inch. These drills are made with straight shanks. Millimeter sizes from 6 to 50 m.m. are made by most American makers. From 6 to 25 m.m. sizes increase by $\frac{1}{2}$ m.m. advances. The millimeter drills are made in both straight and taper shanks.

It has not been found practical to give drills smaller than No. 74 wire gauge, .0225 of an inch, land clearance, and many drills considerably larger than this are not so cleared.

Practice is somewhat at variance as to the best speeds at which to run drills. The later tendencies are to reduce the feeds and increase the number of revolutions, that is for the smaller sizes. For the larger sizes, the number of revolutions varies little from

TABLE OF DRILL SPEEDS.

Diameter of Drills.	Speed for Wrought Iron and Steel.	Speed for Cast Iron.	Speed for Brass.
$\frac{1}{16}$ inch.	1712	2383	3544
$\frac{1}{8}$ "	855	1191	1772
$\frac{1}{4}$ "	397	565	855
$\frac{3}{8}$ "	265	375	570
$\frac{1}{2}$ "	183	267	412
$\frac{5}{8}$ "	147	214	330
$\frac{3}{4}$ "	112	168	265
$\frac{7}{8}$ "	96	144	227
1 "	76	115	191
$1\frac{1}{8}$ "	68	102	170
$1\frac{1}{4}$ "	58	89	150
$1\frac{3}{8}$ "	53	81	136
$1\frac{1}{2}$ "	46	74	122
$1\frac{5}{8}$ "	40	66	113
$1\frac{3}{4}$ "	37	61	105
$1\frac{7}{8}$ "	33	55	98
2 "	31	51	92

the old practice. The above table gives the speed of drills in revolutions per minute as recommended by a leading manufacturer of drills.

A rule that is easily remembered and gives approximately the correct speed is, dividing 80, 110 and 180 by the diameter of drill, will give the number of revolutions per minute for work on steel, cast iron and brass respectively. The results will be rather low for the smaller sizes and high for the larger sizes.

The feeds for drills should vary with the diameter of the drill and the hardness of the metal being drilled, and will usually be 1-200 to 1-50 of an inch per revolution of the drill.

In drilling wrought iron or steel, the drill should be flooded with oil, or some suitable drilling compound, which lubricates the cutting edge and carries away the heat of friction. Cast iron and brass are drilled dry.

A drill with cutting lips having no angle of rake will work best in brass. A straight flute drill or twist drill with lips ground as shown in Fig. 144, is well suited to this work.

In drilling deep holes in steel, especially when the drill is held

in a horizontal position, it is difficult to properly lubricate the cutting edges of the drill. To overcome this, oil tube drills—one of which is shown in Fig. 145—are being very successfully used. In this drill oil is forced to the cutting lips, thus thoroughly lubricating them, at the same time helping to force out the chips and keep down the temperature. The usual method of making this drill is to mill small grooves in the lands parallel to the flutes and secure, by solder, in these grooves small tubes which, at the shank end, are usually made to open into a hollow in the shank from which suitable connection is made with the oil supply. One manufacturer uses the following unique method for producing these oil passages. Two small holes are drilled parallel to the axis in the stock from which the tool is to be made. The length of these holes is somewhat more than the length of the grooved portion of the finished tool, so as to connect with the hollow shank. After these holes are finished the stock is heated to a low forging temperature and then twisted

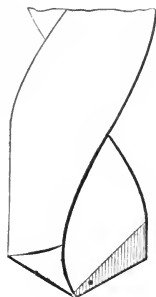

FIG. 144.

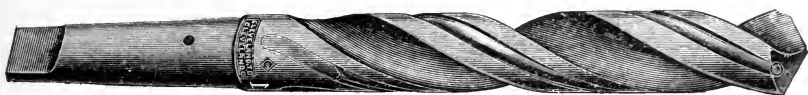

FIG. 145.

an amount such as to make the holes come parallel with the flutes when cut. A cut of this drill is shown in Fig. 146.

Oil tube drills are necessarily expensive to manufacture; their



FIG. 146.

use will, however, frequently more than double the output of the machine driving them.

The drilling of holes that are to be tapped requires a drill equal in diameter to the root diameter of the tap, and is called a tap

drill. The machinist soon fixes in his mind the proper tap drills for the taps he most uses. When there is any uncertainty as to the proper diameter, consult a table of tap drill sizes or caliper the end of the taper tap, and select a drill that will just allow the point of tap to enter; this will give a full thread. The following table gives the sizes of tap drills from $\frac{1}{4}$ of an inch to $1\frac{1}{2}$ inches for the V and United States Standard threads. The United States Standard number of threads per inch are those taken.

TAP DRILL TABLE.

Diameter of Tap.	No. of Threads.	Drill for U. S. S. Thread	Drill for V Thread.
$\frac{1}{4}$	20	$\frac{3}{16}$	$\frac{1}{8}$
$\frac{5}{16}$	18	$\frac{1}{4}$	$\frac{1}{8}$
$\frac{3}{8}$	16	$\frac{9}{16}$	$\frac{1}{4}$
$\frac{7}{8}$	14	$\frac{11}{16}$	$\frac{3}{8}$
$\frac{1}{2}$	13	$\frac{13}{16}$	$\frac{1}{2}$
$\frac{9}{16}$	12	$\frac{7}{8}$	$\frac{5}{8}$
$\frac{5}{8}$	11	$\frac{1}{2}$	$\frac{1}{2}$
$\frac{3}{4}$	10	$\frac{5}{8}$	$\frac{3}{4}$
$\frac{7}{8}$	9	$\frac{23}{32}$	$\frac{45}{64}$
1	8	$\frac{27}{32}$	$\frac{45}{64}$
$1\frac{1}{8}$	7	$\frac{11}{8}$	$\frac{13}{16}$
$1\frac{1}{4}$	7	$\frac{15}{8}$	$\frac{15}{16}$
$1\frac{3}{8}$	6	$\frac{9}{4}$	$\frac{3}{2}$
$1\frac{1}{2}$	6	$\frac{13}{4}$	$\frac{13}{4}$

The location of a hole to be drilled is usually indicated by a center punch mark; if the hole must be drilled exact to this center a circle of diameter equal to the diameter of the hole to be drilled should be described about the punch mark as a center, as shown at A in Fig. 147. A few light prick punch marks should be made,

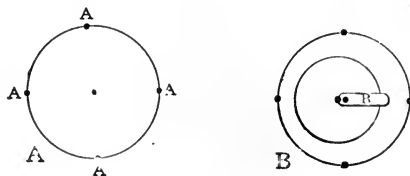

FIG. 147.

A A A A, on this circle. If the drill runs to one side as shown at B in Fig. 147, it can be drawn back by cutting away the wide edge with a cape chisel as shown at B; this chisel cut should run

to the center. The drill must be brought concentric with the circle A A A A in this manner before it begins to cut the full diameter, as it cannot then be readily shifted. When the surface upon which the holes are laid out is a machined one, it is often better to scribe a circle about the center mark slightly larger in diameter than the required hole and drill to the center of this circle. This leaves the laying out circle on the work and readily shows any inaccuracy in the drilling.

The laying out and drilling of holes in this manner when accurate location is necessary, requires care and skill and is usually an expensive operation. When many similar pieces are to be so drilled, it is usual to provide a suitable jig or drilling template, which insures accuracy and requires very much less time. The subject of jig drilling is taken up in Chapter XXVII. On a large amount of drilling work the hole in one part serves as a guide for drilling other holes in other parts of the work, and in many cases it is possible to use one piece of work, which has been carefully laid out and drilled, as a template for drilling other similar pieces.

When the point of the drill breaks through the work and the pressure is thereby greatly reduced, care must be exercised in the handling of the feeds to prevent the drill from worming or drawing through without cutting the full circle. In case this occurs, one of three things will certainly result: break the work, the drill, or stall the machine. A straight flute drill or a twist drill with lips ground as shown in Fig. 144 will not worm through and are good tools to use for drilling thin or sheet metals.

Keep the drill sharp by proper grinding.

CHAPTER IX.

REAMERS.

In order to produce holes as round, straight, smooth and uniform in diameter as is required in the construction of accurate machinery, a reamer must be used. As has been shown in a preceding article, the drill cannot be relied upon to produce holes possessing the above qualities.

A reamer is a sizing tool having two or more teeth either parallel or at an angle with each other, the latter forming what is known as a taper reamer. These teeth may be either straight or spiral; a spiral tooth producing a shearing cut, while a straight tooth gives a square cut.

As to their construction, reamers for producing parallel holes may be divided under two general heads—solid and adjustable. All taper reamers come under the solid class. A solid reamer is one having a shank and teeth made from a single piece of tool steel. The expansion reamer is a built-up tool, the usual form consisting of a shank and head, the head having suitable recesses in which are secured the cutting teeth. As adjustment to compensate for wear only is attempted, the amount of expansion is small.

The number of teeth, their form and spacing are the important considerations in the construction of this tool. Reamers having fewer than five teeth are not to be used where accurate cylindrical truth is desired. A reamer having three teeth cannot be depended upon to produce round holes, inasmuch as any irregularity in the hole being reamed affects the cutting of the tool. This is shown in Fig. 148, where a depression A exists in the drilled hole. When the tooth B comes to this point it drops in, thus decreasing the cutting of C and D, and produces a hole not round. The same effect to a lesser degree is produced in a reamer having four teeth, Fig. 149. When the cut is relieved at A, the pressure of the cut at C will crowd the tool toward E. Since the pressure of cut at B and D balance each other, any decrease of cut at C causes an increase at D, and B and C will overbalance D, the body of the reamer moving an appreciable distance toward

E. With five or more teeth this effect practically disappears. The more cutting edges, the more smoothly will the reamer work. The construction of adjustable reamers does not admit of as many teeth as can be formed on a solid reamer, yet the advantage of adjustability to a certain extent offsets this.

Reamers having an even number of teeth equally spaced do not produce as good results as those having an odd number of teeth. In the former, the teeth fall opposite each other, causing greater tendencies to vibration, and in the case of reaming irregular holes, the greatest cut will be carried on two opposite teeth; but with an odd number of teeth, the greatest cut must be carried on at least three teeth.

Reamers having an even number of teeth but irregularly spaced are very extensively made. A cross-section of such a tool is

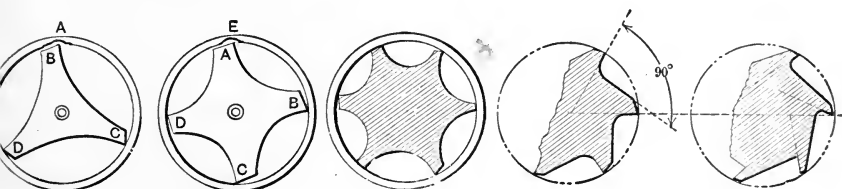

FIG. 148.

FIG. 149.

FIG. 150.

FIG. 151.

FIG. 152.

shown in Fig. 150. The effect is practically the same as having an odd number of teeth.

The form of tooth usually employed is shown in Fig. 151. The front face is on a radial line, the flute being well filleted at the root. If an angle of rake is given the tooth, as shown in Fig. 152, and specially so if the fillet at root is cut away, the tooth will spring out under the cut, producing an oversize hole.

The grinding of the clearance on top of the tooth is an important point in the construction of a reamer. The clearance should be sufficient to properly relieve the cutting edge. If too great clearance is given, the tooth will be weak and chatter in the work. As frequently produced, the cleared surface is slightly concave, the amount depending on the diameter of the emery wheel used in grinding it. As a plain surface is desirable, a wheel of large diameter which gives approximately such a surface, should be employed, or better still the face of a cup emery wheel which gives a straight clearance.

The angle of clearance will depend on the distance the axis of the emery wheel is set back of the axis of the reamer, as shown in Fig. 153. In no case must the wheel come in contact with the front face of the tooth being ground or the one next behind, and the guiding finger which steadies the reamer must always bear against the front face of the tooth being ground. When the diameter of the reamer is large and the pitch of the teeth so small that the necessary clearance cannot be given except by using too small an emery wheel, the wheel can be mounted on an axis at a considerable angle with the axis of the reamer, as shown in Fig. 154. This produces a plane surface; but due to the wear of the emery wheel is not as satisfactory as the use of the cup wheel. The wheel must be so placed as to cut its entire width, other-

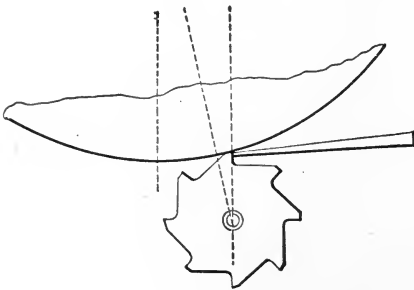

FIG. 153.



FIG. 154.

wise it will be grooved and the cutting edges of the tooth rounded off.

A hand reamer is a tool for hand use; while a chucking reamer is operated in a machine. Fig. 155 illustrates a standard solid



FIG. 155.

hand reamer. In its manufacture, the stock is first cut to length and then turned to a diameter about 1-64 inch over finish size.

The flutes and square on the end of shank are next cut by milling processes. Tempering is the next operation, from which it usually comes warped to a greater or less extent. After straightening, the centers are lapped out and the reamer ground in a grinding machine to diameter and cylindrically true. All standard reamers are made .0005 of an inch over size. This is because a new reamer, before being used, should have its cutting edges stoned slightly, which will just about bring it down to exact diameter. If this is not done, the edges will give down a little on the first few holes reamed; so that if the reamer was made to exact diameter it would fall below size too quickly. The shank is usually ground about .001 of an inch smaller than the fluted portion, and in its use serves as a gauge to indicate when the reamer has fallen, through wear, below .001 of an inch under size. The shank should not be marred in any way, as in that case the purpose for which it was so carefully brought to size is lost, and in cases where the reamer is passed through the work, damage to the hole is apt to result. The last operation previous to grinding the clearance and final inspection in the manufacture of a reamer is the buffing out of the flutes. This is done by passing them under a small vulcanized emery wheel, which has first been trued to the exact outline of the flute.

The hand reamers are regularly made in two lengths; what is known as the short reamer being considerably shorter both in the flute and shank than the regular or jobber's reamer. The diameter of the point is about 1-64 of an inch under size, the tool tapering to exact diameter at about one-fourth the length of the tooth from the point. The balance of the teeth are ground nearly parallel, the diameter at the shank end being from .0005 to .00075 of an inch small. This slight taper counteracts the tendency that all reamers have to ream a hole slightly over size at the top, which is due to the tool remaining longer in contact with the wall of the hole at the top than at the bottom. The limit of error allowed in their manufacture does not exceed .00025 of an inch.

When, for the parallel shank of the hand reamer, a taper shank is substituted, the reamer becomes adapted to use in a drill press or other machine. The form and length of flute is the same as for the regular hand reamer, except at the point, where the teeth instead of tapering for one-fourth of the length of the flute, run parallel to the point. This form is used because the reamer cuts

easier and faster, and as it is steadied by the spindle, no difficulty is experienced in starting it true.

In Fig. 156 is shown a spiral fluted reamer. They are always



FIG. 156.

cut with a left-hand spiral. They give a smooth shearing cut and are specially valuable for machine reaming on centers as they do not tend to draw into the work and off from the center. They are also made in shell and taper.

Fig. 157 illustrates a fluted chucking reamer with taper shank.

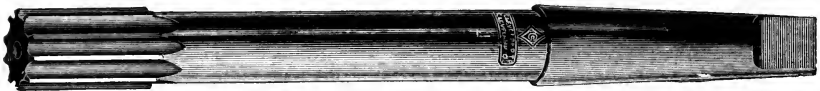

FIG. 157.

The total length of this tool is approximately the same as the length of a hand reamer. The teeth are short and slightly tapered at the point, which facilitates starting when used against the dead center of a lathe. It is also made with straight shank.

The rose chucking reamer, Fig. 158, is of the same length and



FIG. 158.

provided with the same forms of shank as a fluted chucking reamer. The head is ground cylindrical with cutting teeth on the end. The circular flutes do not form cutting edges, their office being to carry the lubricants to the point of the tool, and, especially when used in a horizontal position, to carry away the chips. It is therefore important that a flute be provided for each cutting lip. The head is given only a slight clearance in its length. The result is that holes produced with the rose reamer are usually round and straight, but not so smooth as those formed by longer

cutting edges. The lack of clearance in this tool makes it unsuitable for reaming deep holes, as a small amount of heat causes it to expand an amount sufficient to bind in the hole reamed.

In Fig. 159 is shown a three-flute chucking reamer. These



FIG. 159.

reamers have the shanks and fluted portion ground cylindrically true and are specially adapted to the reaming of deep cored holes.

The shell reamers, Figs. 160 and 161, are chucking or rose

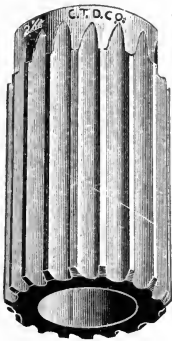

FIG. 160.

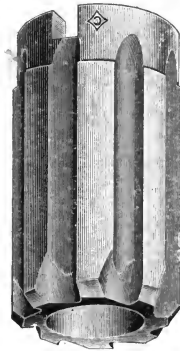

FIG. 161.

reamer heads, having round central tapered holes, the taper used being $\frac{1}{8}$ of an inch per foot for the reception of the arbor shown in Fig. 162. A rectangular slot or key-way is milled across the



FIG. 162.

shank end to receive the cross key of the arbor; several sizes of reamers fitting each size of shank. The first cost of a set of shell reamers and arbors is but little less than that of a set of regular rose or fluted chucking reamers.

In Fig. 163 is illustrated a taper hand reamer. The reamer shown is a standard taper pin reamer having a taper of $\frac{1}{4}$ inch per foot. The Morse taper reamers of approximately $\frac{5}{8}$ inch per foot and the Brown & Sharpe standard taper reamers of $\frac{1}{2}$ inch per foot are in all respects similar to the taper pin reamer shown.

When a solid reamer, through wear, falls below standard size an amount greater than the allowable limit of error, it can be brought up to standard size again only by drawing the temper, upsetting the teeth by driving against their front faces, retempering and regrinding. This is an expensive and unsatisfactory operation. It will usually be found best to grind it to about .005 under size and use it for a sizing reamer. In some cases it is possible to grind them to the next thirty-second or even sixteenth size smaller. This makes the teeth wide on top; but if the clearance is properly ground, the reamer will work well. In such cases,



FIG. 163.

care must be taken to obliterate the original size stamp, and replace with a new one to avoid errors.

It must not be inferred that a properly made solid reamer falls quickly below size when properly used. Its life as a standard tool depends upon the hardness of the metal reamed and the amount of cut it is required to take. It must be remembered that the standard reamer is a finishing tool, and must, as such, be capable of reaming a great many holes to practically the same diameter. To accomplish this the cut must be very light, never exceeding $\frac{1}{64}$ of an inch, and preferably not more than .005 to .01 of an inch. When great uniformity is required, a sizing reamer .005 to .007 of an inch under size, usually operated by power, is first passed through the hole. This leaves a true hole and equal cut for the finishing hand reamer.

There are numerous adjustable reamers on the market. Fig. 164 shows the Cleveland common-sense expansive reamer in which a screw in the point forces a tapered plug into the tapered hole in the center of the tool which expands the teeth, the slots parallel to the teeth and extending through to the bore, allowing the necessary amount of spring. It is evident that the teeth ex-

pand most at the center, but as the amount of expansion necessary to preserve standard diameter is very small, this will have little effect on the working of the tool. The cylindrical portion of the point is called the "guide" or the "pilot" point, and is usually ground .005 to .007 of an inch under size, which of course limits the amount of stock left for finishing. This reamer is made from $\frac{3}{8}$ of an inch to $2\frac{1}{2}$ inches in diameter, and is strictly an expansive reamer.

A form of Morse adjustable blade reamer is illustrated in Fig. 165. It consists of a suitable number of blades or chasers, fitting

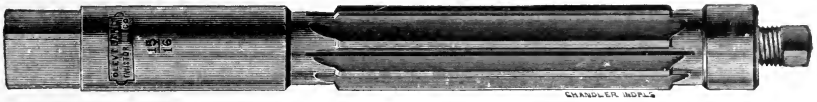

FIG. 164.

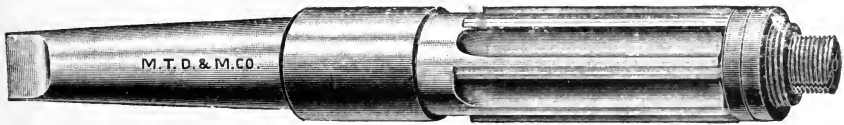

FIG. 165.

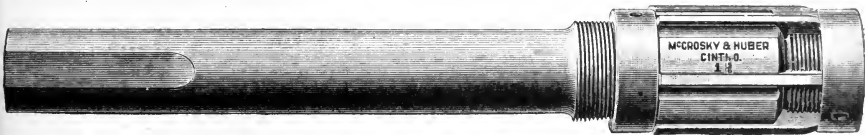

FIG. 166.

milled slots and abutting against a ground tapered plug in the center of the head, the end of which is threaded into the shank. By screwing the plug in, the blades are forced out the required amount, and when adjusted, the dished-head nut engages the beveled ends of the blades, holding them firmly in position. These reamers have an adjustment of about 1-32 of an inch, and are regularly made in sizes from $\frac{3}{4}$ of an inch to 2 inches.

Fig. 166 illustrates an adjustable reamer in which the blades, which are unequally spaced, are fitted in radially tapered grooves. Cupped collars engage the beveled ends of the blades, holding them firmly in position. The adjustment is made by slacking the upper collar and forcing the blades toward the shank by the

lower collar. A reamer of this class with steep taper to the bottom of the grooves and long threaded portions can be adjusted for several sizes. This, however, is not considered good practice, the adjustment being simply to maintain one size. This adjustment, however, is great enough to allow for several regrindings.

Those classes of adjustable blade reamers in which each blade is set out independently should be reground after each adjustment, as it is almost impossible to set the blades out equally.

In using the reamer it should be turned continually forward, both on the advance and on the withdrawal. Turning it backward while in the work is quite apt to injure the tool, due largely to small particles of cuttings lodging between the clearance surfaces and the wall of the hole. In hand reaming the tool can usually be passed through the work. Oil should be used freely in reaming steel or wrought iron. Cast iron and brass are usually reamed dry. A small amount of oil will, however, frequently improve the quality of the work in these metals.

The preparation of the holes for taper reaming is of great importance. As a reamer should not remove all the metal that would be left if a drill the size of the point of the reamer were passed through the work, several drills of different diameters may be used, producing a stepped hole, as shown in Fig. 167. If

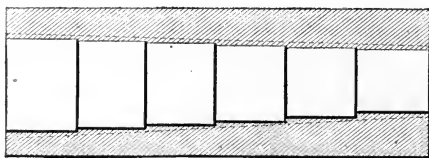

FIG. 167.

the work is done in a lathe, the taper attachment or compound rest can be advantageously used, using a boring tool to enlarge the drilled hole. If the lathe has neither of these attachments, the hole can be stepped out, as in Fig. 167, with the boring tool. A roughing reamer, Fig. 168, is well suited to the preparation of a hole to be taper reamed.



FIG. 168.

A simple form of reamer shown in Fig. 169 will frequently obviate the expense of a special reamer when only a few holes are to be sized. The tool can be made at slight expense, and when carefully constructed will produce very good results.

The taper pipe reamer, Fig. 170, is a roughing reamer of standard pipe tap taper for sizing a drilled or bored hole before tapping with pipe tap.

The reamers used for reaming center bearings in work to be

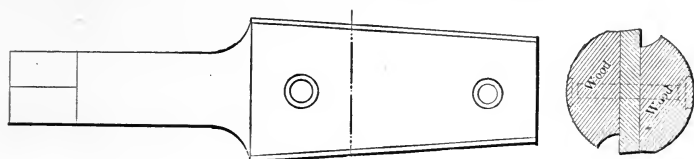

FIG. 169.

machined between centers are shown in Fig. 171. A is the "old Hartford" reamer with one cutting edge. It cannot be relied upon to produce a true conical hole. A "new Hartford" center reamer is shown at B. It has three cutting edges, and will produce a true hole. These reamers are intended to follow a small drilled center hole, and are made with 60-degree, 72-degree and

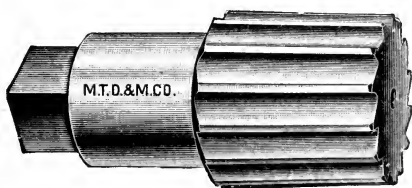

FIG. 170.

82-degree angles, 60 degrees being the standard. They are also made in several sizes from $\frac{1}{4}$ to $\frac{3}{4}$ of an inch, largest cutting diameters. A form of combination center reamer and drill, in which the drill and reamer blades are held in a suitable shank, is shown at C. At D is shown a combination center drill and reamer that has come into general use. It is admirably adapted to its work, being efficient, simple and inexpensive. The drill steadies the reamer, which makes it cut smoother, and insures its coming central with the drilled hole. This is of special value

when the surface of the work is uneven. The countersink is similar to the center reamer, having, however, a greater number of teeth.

When reaming either taper or parallel in a lathe, the work rotating and the reamer held against the dead center, true work must not be expected, if the reamer is allowed to follow directly after the drill, as it is practically impossible to so start a drill that the drilled hole will be exactly concentric to the axis of the lathe spindle. This will cause the point of the reamer to move in a small circle around the center of the rotation, producing a tapered instead of a parallel hole. If true holes are required, the drill

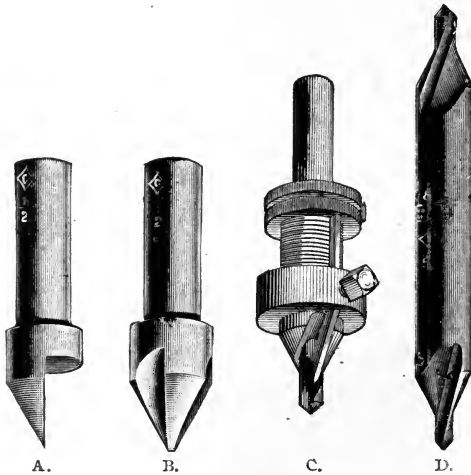

FIG. 171.

used should be enough smaller than the reamer to allow for the truing of the hole with the boring tool, which will bring it concentric with the axis of rotation before the reamer finishes it to exact diameter.

When the reamer is used in a drill press, correct results will be obtained only when the hole reamed is exactly concentric with the drill spindle, otherwise the reamer will be held against one side of the hole, making it elliptical in cross-section at the top. These difficulties in producing perfect reamed holes by machine-driven reamers, compel the extensive use of the hand reamer, the holes having been previously sized with an undersize reamer.

CHAPTER X.

SCREW THREADS, TAPS AND DIES.

As to their uses, screw threads may be divided into two classes; first, those used for fastenings; and second, those used for communicating motion. The term "fastenings" is applied to any device used to hold together two or more pieces, either holding them rigidly together or constraining any relative motion between them. The important position that the screw thread holds under this head becomes forcibly apparent when we consider a machine, as a lathe, for example, and wonder how we would manage to hold its numerous parts together without the use of this device. The lead and cross feed screws in a lathe are examples of screws used to communicate motion.

In Fig. 172 are shown the three forms of threads used for fastening.

In the V thread the angle of the sides with each other is 60 degrees, the top and root of the thread being sharp.

The United States standard thread, or as it is often called, the Sellers or the Franklin Institute thread, is the same as the V, with the top cut off and the root filled in. The amount taken from the top and added to the root is one-eighth of the height of the V thread, thus making the United States standard thread three-fourths the depth of the V thread. The United States standard form of thread was recommended by the Franklin Institute in 1864. This system was devised by Mr. William Sellers, and has become the acknowledged standard thread in the United States. Its points of superiority come from the fact that it does not cut so deep into the stock as does the V thread, thus leaving a stronger root, while the small amount cut from the top and bottom of the V thread has little strength value. It is more cheaply produced, as threading tools with flattened points stand up under their work much better than those with sharp points, and the filled root does not form a distinct fracture line as does the sharp root of the V thread. This form of thread is well adapted for interchangeable work, being used by the leading builders, and its complete adoption should be urged by all.

In the Whitworth or English standard thread the tops of the threads are rounded off and the roots filleted in. The angle of the sides with each other is 55 degrees, and the amount taken from the top and added to the root is one-sixth of the height of the V thread, having sides at a 55 degree angle with each other.

Each of the threads shown in Fig. 172 is to scale for standard one and one-quarter inch bolts, and the dimensions given will facilitate comparison.

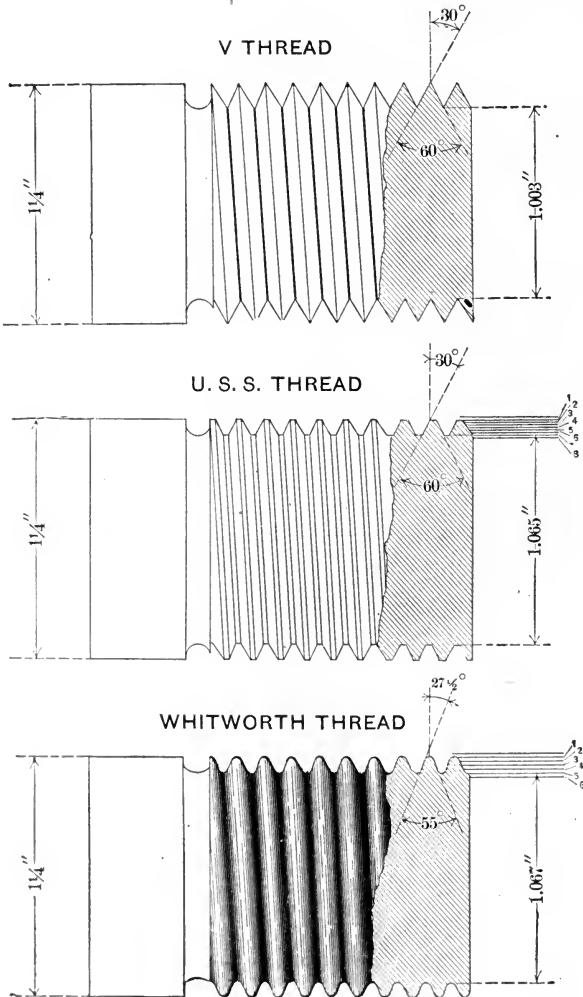

FIG. 172.

In Fig. 173 are shown three forms of screw threads used for communicating motion.

The pitch of the screw is the distance it advances in making one revolution; thus, the pitch of a screw having eight threads per inch is one-eighth of an inch. It is usual to refer to the number of threads per inch, rather than to the pitch. For example, in Fig. 172 it is seven threads per inch, rather than .143 of an inch pitch.

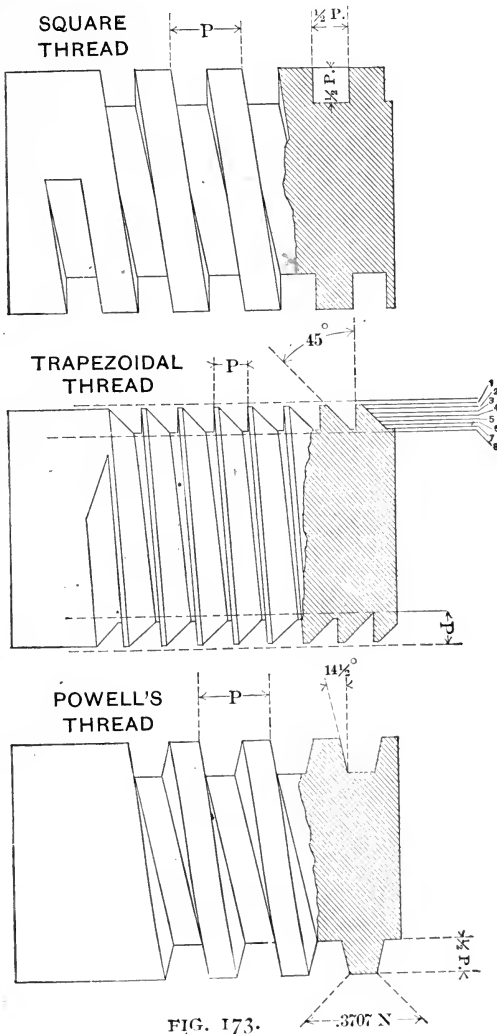

FIG. 173.

All screw threads may be either right or left handed. Fig. 174 illustrates a left hand screw. The left hand screw enters its nut by turning it counter clockwise.

When a steep pitch is desired and the diameter of the stock would be too small to permit the use of a single thread, two or more parallel threads, dividing the pitch into two or more parts, may be used. Such are known as double, triple and quadruple threads. A triple thread is shown in Fig. 175, with single thread of same pitch shown dotted.

The United States standard admits of no oversizes and specifies

LEFT-HAND THREAD

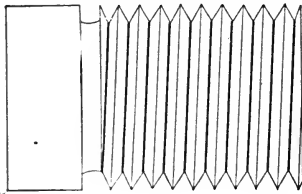

FIG. 174.

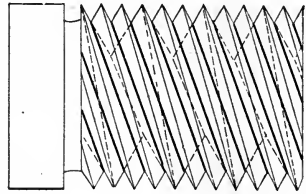

FIG. 175.

the number of threads per inch for each size, as well as prescribing the form of thread. For special work, however, it is frequently advisable to use a different number of threads per inch from that specified in this system, but such will, of course, not be standard, and must always be looked upon as special. The following table gives the principal diameters and corresponding numbers of threads, as determined in the United States standard system:

TABLE OF SCREW THREADS.

Diameter of Bolts.	Number of Threads per Inch.	Diameter of Bolts.	Number of Threads per Inch.
$\frac{1}{4}$	20	$1\frac{1}{8}$	7
$\frac{5}{16}$	18	$1\frac{1}{4}$	7
$\frac{3}{8}$	16	$1\frac{3}{8}$	6
$\frac{7}{16}$	14	$1\frac{1}{2}$	6
$\frac{1}{2}$	13	$1\frac{3}{4}$	5
$\frac{9}{16}$	12	2	$4\frac{1}{2}$
$\frac{5}{8}$	11	$2\frac{1}{2}$	4
$\frac{3}{4}$	10	3	$3\frac{1}{2}$
$\frac{7}{8}$	9	$3\frac{1}{2}$	$3\frac{1}{4}$
1	8	4	3

The screw threads with which the machinist has to deal are

produced by cutting processes, in which the thread is formed from the solid stock. Cut threads are produced either by means of a single pointed cutting tool or a chaser used in a lathe, or by means of taps and dies. In the first case the pitch of the screw being cut is dependent on the lead screw of the lathe, while in the latter case the pitch is dependent on the lead of the tap or die. Screws used for communicating motion, or where accuracy is desired, are cut in the lathe, while those used for fastenings are usually cut by the other method.

The tap is a tool used to produce internal threads, and the

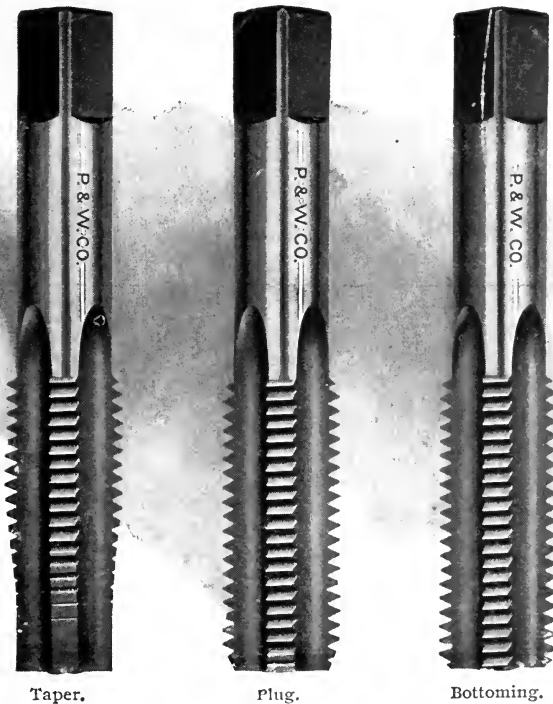

FIG. 176.

die is a tool used in cutting the external threads. Hand taps and dies are those intended to be used by hand, while machine taps and dies are those operated by power in a machine.

The hand tap is shown in Fig. 176. It should be made of a high grade steel, and of a temper specially suited to the severe work it is called upon to perform. It is provided with a round

shank, with milled square to receive the tap wrench. This shank is frequently turned to the exact diameter of the root of the thread, and used to gauge the final settings of the single pointed threading tool, with which the thread of the tap is finished, it having been previously roughed down with a chaser. This work is done in a lathe having an accurate lead screw, the accuracy of the tap depending largely upon this screw.

Hand taps are made in sets, three taps comprising what is known as a tap set. These are called the taper, plug and bottoming, as shown in Fig. 176. As manufactured by the Pratt & Whitney Company, the only difference between these taps is in the form of the point. They all have the same thread parallel at the root, and if passed entirely through the work will produce similar threads. The taper tap is parallel on the point for a distance equal to one-fourth the diameter of the tap. This point is made the diameter of the roots of the teeth, which is the correct size of the hole to be tapped in order to produce a full thread. The teeth at the shank end are parallel for a length equal to the diameter of the tap, and the balance of the teeth are tapered to the parallel portion at point. This gives a number of teeth between which the cutting duty in forming a full thread is divided.

The taper taps manufactured by some makers have teeth, in which the root diameter is small at the point, increasing on a uniform taper to the parallel portion near the shank end, and thus dividing the taper between the top and root of the teeth.

In the plug tap the first three teeth are tapered off, as shown, while in the bottoming tap the teeth extend full to the point. The fractional teeth at the point, which would be very apt to break, are ground away.

The taper tap is best suited to the starting of a thread, but unless the hole passes clear through, a complete thread will not be formed. The plug tap makes a full thread nearly to the bottom of a hole, which may be finished to the very bottom with the bottoming tap. The bottoming tap should be used, however, only to finish out the thread, as practically all the cutting is done by the four point teeth, which severely taxes their strength. When possible, it is best to drill the holes sufficiently deep to allow the plug tap to finish the required length of thread.

The plug tap is best suited to general work, but requires greater care in starting it axially true with the hole than the taper tap. Machine taps are usually made of the plug pattern, but as they are

held true to the work, no difficulty is experienced in starting them straight.

Four grooves are ordinarily milled in the tap, thus forming four sets of cutting edges. The form of this groove varies somewhat, but has little effect on the cutting qualities of the tap. It is usually so formed as to bring the cutting faces of the teeth on a radial line, as shown in Fig. 177, and should be only deep enough to allow room for chips and oil when tapping deep holes. If the groove area is made too large the strength of the tap is seriously impaired. It will be noticed in Fig. 177 that the teeth are comparatively short, less than one-third of the circumference having teeth. The shorter the teeth the less will be the frictional resistance and the weaker will be the tooth. As tap teeth are shortened by grinding from the front face, the teeth must not be made too short when new.

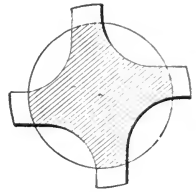

FIG. 177.

Hand taps and all others that are backed out of holes tapped are not given thread clearance. As standard taps do not admit of oversizes, a relieved thread tap would, if standard when new, fall below proper diameter when ground on the front faces in sharpening. A tap having relieved teeth will, when backed out of the thread it is cutting, allow the cuttings to wedge between thread and teeth, seriously injuring both work and tap. The backing of such a tap while in the work will frequently shale off the front face of the teeth.

Taps that pass through the work by driving continually forward, as with nut taps, are given relieved teeth; they cut freer and there is less friction between tap and thread, but should not be turned backward in the thread. The relief on these teeth is produced with uniformity and rapidity on machines specially designed for this purpose.

Standard taps are made from one to five one-thousandths of an inch oversize to allow for the wear on the top of the teeth. This means that a little less than the one-eighth is taken from the top of the teeth; the root diameter and sides of the teeth being correct, this does not affect the fit of the thread.

In Fig. 178 is shown a pulley tap used largely for tapping the holes for set screws in pulley hubs, a hole being drilled in the rim sufficiently large to allow the tap and shank to pass through. It is a regular plug tap with a long shank; the diameter of the shank

is the same as the diameter of the tap. It may be had with any reasonable length of shank, and will be found a very convenient tool for tapping holes in inaccessible places.

The stay-bolt tap, as shown in Fig. 179, is a combined reamer and tap, used by boiler makers for reaming and tapping the holes for stay-bolts. The taps are made long, as the plates are often widely separated, and must be tapped together, as otherwise the stay-bolts will not enter the second plate without springing the plates a fraction of the pitch. These taps are sometimes made as long as five feet. They run from three-quarters to one and one-half inches in diameter.

A hob, or master tap, is one used for cutting the threads in dies. Fig. 180 shows a hob for cutting pipe dies.

The pipe tap shown in Fig. 181 has full teeth to the point, the standard pipe taper being three-quarters of an inch per foot. The following table gives the number of threads per inch and tap drills for standard pipe taps:



FIG. 178.

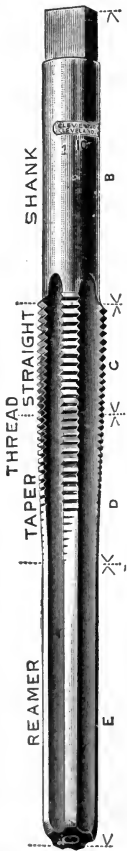

FIG. 179.



FIG. 180.



FIG. 181

Diameter of Pipe.	Number of Threads.	Tap Drill.
$\frac{1}{8}$	27	$\frac{21}{64}$
$\frac{1}{4}$	18	$\frac{29}{64}$
$\frac{3}{8}$	18	$\frac{41}{64}$
$\frac{1}{2}$	14	$\frac{19}{32}$
$\frac{3}{4}$	14	$\frac{27}{32}$
1	11 $\frac{1}{2}$	$\frac{15}{16}$
1 $\frac{1}{4}$	11 $\frac{1}{2}$	1 $\frac{1}{8}$
1 $\frac{1}{2}$	11 $\frac{1}{2}$	1 $\frac{3}{8}$
2	11 $\frac{1}{2}$	1 $\frac{5}{8}$
2 $\frac{1}{2}$	8	2 $\frac{3}{8}$
3	8	2 $\frac{11}{16}$
3 $\frac{1}{2}$	8	3 $\frac{5}{16}$
4	8	3 $\frac{13}{16}$
		4 $\frac{5}{16}$

In case a pipe reamer is not used for sizing ahead of the tap the holes may be drilled 1-64 inch larger for the small sizes and 1-32 inch for the large sizes.

Fig. 182 shows a machine or nut tap. It is provided with a long easy taper on the threaded portion and a long shank somewhat smaller in diameter than the root of the thread.

A combination drill and pipe tap, shown in Fig. 183, is in quite general use. It is a valuable tool for drilling and tapping gas and water pipes under pressure.

A collapsing tap is one in which the teeth or chasers, after cutting the thread, are carried toward the center enough to allow them to clear the threads so that the tap can be removed without backing. This not only saves time, but the wear on the teeth incident to backing them out of the threaded hole. A form of collapsing tap manufactured by the Geometric Drill Company is shown in Fig. 184.

The mechanism is such that when the two side stops come in contact with the work the lead or draw of the tap releases a clutch in the head which unlocks the mechanism and the chasers are instantly collapsed. The setting of the stops determines the depth of the threaded hole. The chasers are then expanded again and locked in position for the next operation by means of the handle shown on the body of the tap. A graduated adjustment provides for slight variations in the diameter of the tap.

The advantages of the collapsing tap over the solid lies in the saving of time due to being able to allow the machine to run continuously forward, thus saving the time required with the solid tap to back out. The backing out not only injures the tap

but is quite apt to injure the thread. Again, the possibility of changing slightly the diameter of the tap is frequently of value.

A limited number of different sizes may be tapped with each size of head by substituting different sets of chasers.

Taps are tempered hard and are consequently brittle. They give no warning before they break, therefore care and judgment must be exercised in their use. In using hand taps, a wrench which fits closely the square on the shank, and having opposite handles of equal length, should be used. The pull on the handles should be uniform and equal. This produces a torsional strain in the tap, which, if working under proper conditions, it will safely resist. Any excess of pressure on one handle will produce a transverse strain which endangers the tap.



FIG. 182

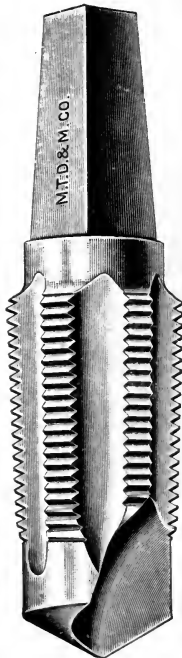

FIG. 183.

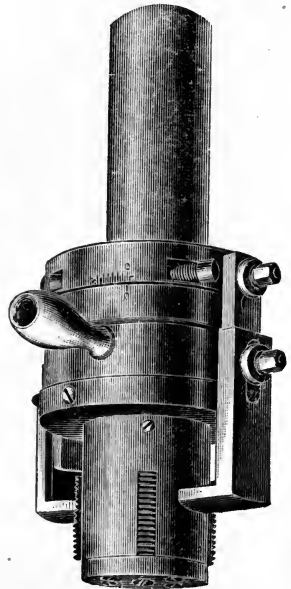

FIG. 184.

It frequently is necessary from the nature of the work to use a single handle. In such cases the operator must grasp the head of the tap and wrench with his left hand and balance the transverse moment of the pull at the end of the handle, allowing only the turning effort to be received by the tap.

In tapping full threads in tool steel great care must be exercised, especially if the stock is not thoroughly annealed. If much of this work is to be done two taps should be used, the first one through removing only a part of the stock, and the second finishing. In tapping double threads, two, or even three taps, should be used. This becomes necessary from the fact that with a double thread twice the amount of stock must be removed per revolution of the tap as with a single thread of the same depth. Taps for square threads should also be used in pairs, unless made extra long with a long tapered portion.

When a thread is to be tapped at right angles to the surface,

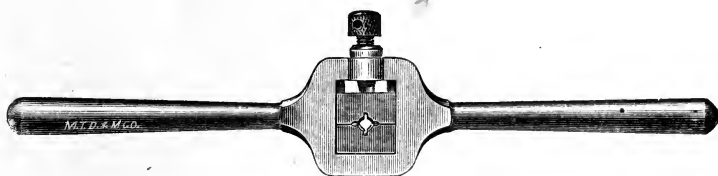

FIG. 185.

do not depend on the taps following the drilled hole, but in starting test the angle by squaring to the shank of the tap. A tap started crooked must be squared up while the first two or three threads are being cut; an attempt to square it later may result disastrously to the tap, and will produce a threaded hole enlarged at the opening.

Dies may be divided into two general classes; the first should include all dies requiring to be passed over the work several times in the production of a finished thread; the second, those that produce a finished thread at once over.

The first class, example of which is shown in Fig. 185, consists of a stock in which cutting dies are held. These dies are capable of sufficient separation to enable them to be passed over the work upon which the thread is to be cut. By means of a set screw or threaded handle the dies may be closed an amount sufficient to make them cut a full thread.

In the manufacture of these dies they are threaded with a hob tap, the diameter of which is twice the depth of the thread greater than the diameter of the work the die is to be used upon. This makes a die with teeth, the tops of which fit the work when the thread is started. This is shown in Fig. 186. It greatly facilitates the starting of a true thread. The conditions at the finishing of the thread are shown in Fig. 187, in which A A are the cutting edges. When the thread is started these edges have no clearance,

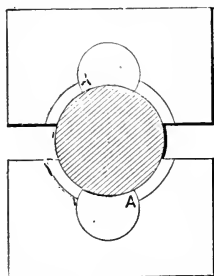

FIG. 186.

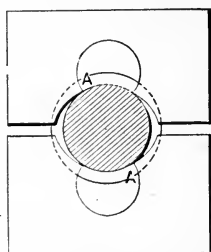

FIG. 187.

but as the dies are forced toward the center an increasing clearance is formed. This is clearly shown in the figures.

The dies are chamfered off on the advancing side for two or three teeth, so that these teeth do the most of the cutting, those following simply sizing. If desired to cut a full thread close up to a shoulder the die is turned over.

Under the second class we consider first the screw plate, shown in Fig. 188. This is a thin plate of tempered steel, in which a



FIG. 188.

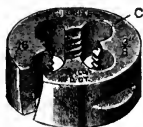

FIG. 189.

number of holes of varying diameters, threaded with different pitches and provided with opposite notches to form cutting edges, have been produced. It is a primitive tool, suited only for work of small diameter, where correct threads are not required.

Dies of the second class are usually made adjustable to compensate for wear. In Fig. 189 is shown a form of die largely used

for small sizes, one-sixteenth to one-quarter of an inch. It is given a spring temper at C, and is held in a wrought ring, not shown in the figure. A small set screw passing through the ring and engaging the notch shown in the die edge, serves to spring the die together, when through wear it becomes over-size.

Fig. 190 illustrates the Grant adjustable die, in which the four chasers are held in a cast-iron collet surrounded by a wrought ring. The chasers are beveled off on the outer ends, which engage with corresponding beveled grooves in the ring. By forcing the ring down, the chasers are moved toward the center. The



FIG. 190.

amount of adjustment in this die is one-thirty-second of an inch. The chasers are numbered, with corresponding numbers on the side of the grooves in which they belong. This prevents the possibility of putting together incorrectly when the chasers have been removed for grinding.

This die is sharpened by grinding back the front face of the chasers. They should be ground only a short distance back of the tooth root, so as not to interfere with the bearing in the collet.

In Fig. 191 is shown the lightning adjustable die. The stock is bored out to receive the two halves of the die. The taper head screws B B fix the size and the binding screws A A A A hold the

parts firmly together. A separate stock is provided with each size of die.

In Fig. 192 is shown a solid machine or bolt die. It is made of

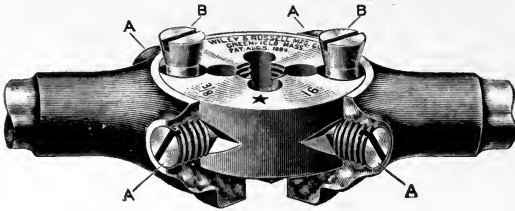

FIG. 191.

the same form as the solid pipe die and may be used in either a hand or power holder.

The spring die shown in Fig. 193 is for use in a machine and where smooth, accurate threads are desired should be used in pairs, one for roughing and one for finishing. A clamp collar fitted over the end of the die prevents its spreading. This form of

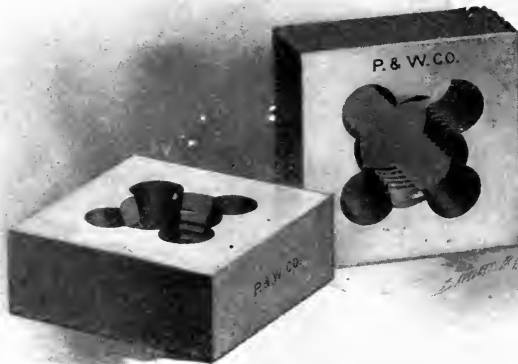

FIG. 192.

die can be sharpened by passing a thin emery wheel through the grooves.

Self-opening and adjustable dies are for machine threading very generally used. The advantages are the same as for the collapsing tap. Fig. 194 illustrates the Geometric Drill Com-

pany's self-opening die. This tool is usually mounted in the turret of a chucking machine or screw machine. The chasers are set up for the cut by turning the head until the mechanism locks



FIG. 193.

them into position. Pulling forward on the chasers unlocks the head and a spring throws the dies out. In operation the die is moved forward over the work until the end of the thread is

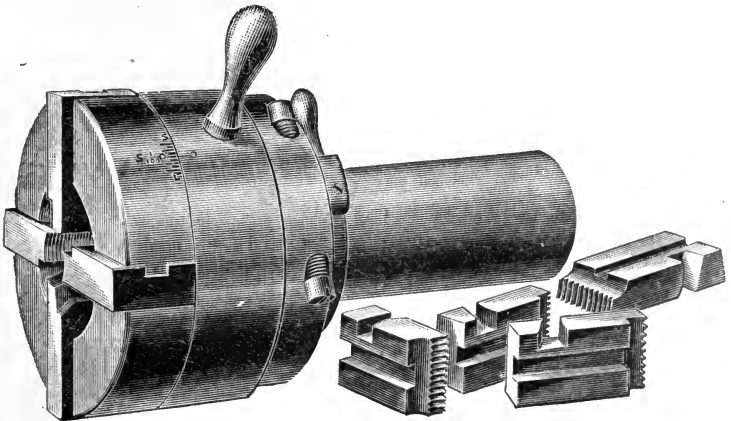

FIG. 194.

reached, when by stopping the carriage the forward lead or draw of the die unlocks it and the chasers spring open.

By means of the two screws and graduations shown on the

side of the tool a micrometer adjustment, which controls all the chasers, is quickly made, thus making it possible to make a tight or loose fitting screw as desired. The die head shown is provided with a roughing and finishing attachment controlled by the small lever at the back. In using this attachment the chasers are held out for the first cut over about 1-100 of an inch, which is taken at the second cut. This is necessary only when extremely uniform and accurate threads are required. The chasers may be very quickly removed for sharpening or changing from one size to another.

For pipe threading opening dies are very extensively used.

The advancing edge of the die chasers in all forms that produce a finished thread at one cut, is chamfered off for two or three teeth, which divides the cutting duty and facilitates starting the thread. The die should not be run bottom side up on the work, as in that case the first tooth does nearly all the cutting duty. Only in unusual cases is a workman justified in this procedure.

Oil should always be used liberally on the tap or die when cutting steel or wrought iron; a little oil on the tap when cutting cast iron or brass makes it run easier and does no injury to the thread or the tool. Sperm or lard oil is best for this purpose.

In threading steel or wrought iron by hand the tap or die should, after every two or three turns forward, be given a slight turn back. This facilitates the removing of the cuttings and allows the oil to find its way to the points of the teeth.

No matter how accurately a tap or die is cut the hardening process will distort it somewhat. If this distortion followed any fixed law, allowance could be made in the threading that would offset this variation, but as the distortion is variable, even when the conditions are the most uniform possible, it is difficult to make allowance for it. As a general thing the taps contract in length, thus decreasing the pitch, and expanding in diameter.

A die of standard diameter must not be used to thread stock that is one-thirty-second of an inch oversize, as the strain on the die parts is too great.

The practice of rolling iron one-thirty-second of an inch oversize is to be condemned as the cause of mistakes, lack of interchangeability and general confusion, at the same time having no advantages. It is not practical to roll ordinary bolt stock to exact sizes, yet the variation need not be great and can be taken care of by the standard dies.

The speed at which threads may be cut with taps and dies in power machines depends very largely upon the character of the work, quality of the thread required and the conditions under which the work is performed. Cast iron and brass can be threaded at much higher speeds than steel. For equal diameters fine pitches may be cut at higher speeds than coarse pitches. Smooth, accurate threads require comparatively slow speeds. For rough work a speed of from 15 to 20 feet per minute is satisfactory when the work and cutters are flooded with good screw cutting oil. A speed of 10 feet per minute is quite fast enough when smooth, accurate threads must be had. When the work has been heated up by a preceding operation the speed for threading cannot be as high as if the work was perfectly cold. This is usually the case on the screw machines where the threading follows a heavy turning operation. As the threading requires but little time as compared with the turning it is common to sacrifice speed in threading for higher efficiency in turning, all of which tends toward truer and better threads.

To determine the diameter of hole required to give a full thread, caliper the root diameter of the tap, the point of the taper tap, or consult a table of tap drills. The number of threads per inch is always plainly stamped on the tap or die. Remember that United States standard for five-eighths of an inch is 11, not 10, and for half an inch is 13, not 12 threads per inch. Always keep die and tap threads sharp by grinding from the front faces of the teeth. When dull they jam rather than cut the stock and require excessive power to operate them.

CHAPTER XI.

DRILL AND TAP HOLDERS.

Drivers adapted to the proper holding of drills and taps while in use are quite essential to their long life. Very frequently the shank end of these tools gives out while the cutting end remains in good condition. This usually comes from not having the proper holders in which to drive them, but very frequently through the sheer carelessness of the operator.

A mechanic is always annoyed when he finds the drill he wishes to use with the shank mutilated and the tang twisted. Workmen cannot be blamed for not using what their employers will not furnish, yet very frequently they will not use them, or rather use them properly when they are provided. A dog tightened onto the shank of a taper shank drill, with a bar of iron resting on the shank and under the tail of the dog, will hold the drill from rotating when held against the tail center of the lathe and operating on chucked work. At least it will hold it part of the time, the rest of the time it is slipping under the dog screw, which plows up the surface in fine shape. Of course, the operator who would use a taper shank drill in this manner has not the time to smooth up the shank when he finishes with the drill, but leaves it for the other fellow to do. The other fellow is also in a hurry, and jams the drill into the taper, tearing the drill press spindle, growls because it won't run true, and finally when he twists the tang off, declares that taper shank drills are not fit to drill lead with, and all because the taper, due to its roughed condition, not fitting properly in the bearing in the spindle, threw the entire load on the tang, which should not be expected to carry it.

Drills are usually held in sockets or chucks, depending on whether they have taper or straight shanks. As has already been explained in a preceding article, the shanks of taper shank drills are turned to standard tapers. While great refinement is not exercised in producing these tapers, they will be found to vary but little from the exact taper. This is of importance because the socket shown in Fig. 195 should drive the drill not by the tang alone, but largely by the friction between the surfaces of

the shank and bearing in the socket. For the larger drill sizes under each taper the tang is the weakest part of the drill. Thus the tang of the No. 1 taper on a one-fourth inch drill will break the drill before it will twist, but on a nine-sixteenths-inch drill, which has the same tang, the tang will twist rather than break the drill—that is, assuming that the drills are driven by their tangs alone.

In the socket the tapered bearing should not extend beyond



FIG. 195.



FIG. 196.



FIG. 197.



FIG. 198.

the bottom of the shank or mortise through the shank, and the slot should be but slightly wider than the thickness of the tang. This gives the tang a good bearing well down toward its base. The slot must be sufficiently long to allow the taper drift or key, shown in Fig. 198, to be inserted over the end of the tang to force the drill out. If the shank or bearing in the socket is jammed, the former will not enter the bearing the proper depth, the tang will catch on the point, the frictional drive between shank and bearing surfaces will be decreased and a twisted or

broken tang will usually result. Frequently, in twisting, the tang will force the drill out of the socket an amount sufficient to allow it to turn in the bearing, the tang cutting out the sides of the slot at the bottom and thus ruining the socket.

In Fig. 199 is shown the new Cleveland drill socket and a drift. The design of this socket is to prevent the battering and upsetting of the drill tangs, the drift seating squarely upon the end of the tang as shown.

When sockets are to be fitted to spindle or turret bearings having other than a Morse taper, they may be obtained with

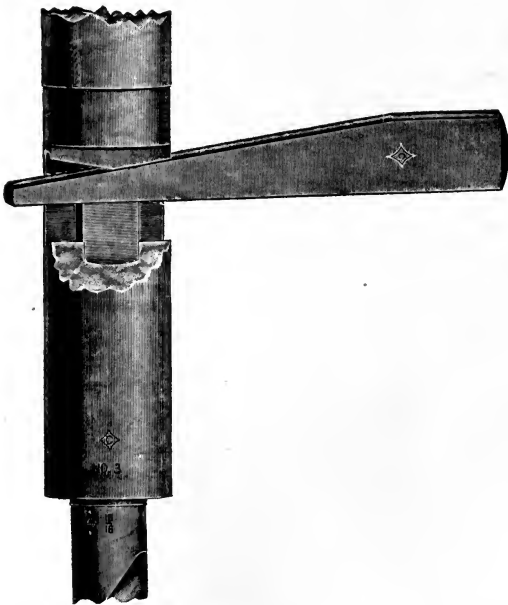

FIG. 199.

rough shanks, which can be turned to the desired size or taper. Such a socket is shown in Fig. 196.

When it is desired to bush the bearing in the drill spindle or socket to a smaller size, the bushing or sleeve shown in Fig. 197 is used. It is the same as the socket, except the shank is made to envelop the bearing, thus decreasing the length of the connection. Sleeves are not as convenient as sockets when the drill is to be frequently removed, as it is necessary to remove the sleeve before the drill can be forced out. In such cases it

is best to bush the spindle bearing to the size larger than the drill taper, and then use a socket for the last reduction.

In Fig. 200 is shown a sectional view of the Cleveland grip

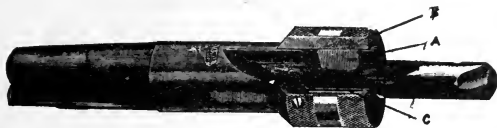

FIG. 200.

socket. The object of this socket is to provide a stronger drive for the drill, and thus avoid the twisting of the tang. A key-way is milled in the shank of the drill, into which the key A of the socket is forced by rotating the collar B through about one-fourth of a revolution. The collar is recessed as shown at C, the recess being eccentric to the socket. When the collar is turned so that the deep part of the recess is opposite the key, forcing the drill out crowds the key back out of way. When the key-way is properly milled, the key so fits it that the drive is entirely removed from the tang. This makes it possible to use drills which have had their tangs twisted off. This collar and key, when applied to the end of the drill press spindle, will hold the drill from worming into the work and pulling out of the spindle when the point of the drill strikes through. It will also prevent boring bars from pulling out of the bearing when used for under-cutting, a feature appreciated by those who have much of this kind of work to do.

When the taper shank drill is to be used in the lathe for work on chucked pieces, the holder shown in Fig. 201 is excellently

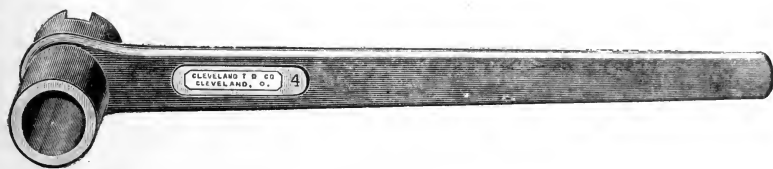

FIG. 201.

adapted. It is virtually a sleeve having a long handle attached, which may be allowed to rest on the carriage of the lathe, the shank end of the drill being steadied on its own center against

the tail center of the lathe. Another holder for this purpose, Fig. 202, is made in which a center in the holder is used rather than the drill center. In Fig. 203 is shown a sleeve holder in which the sleeve is kept from rotating by means of the two screws, which have points turned to fit the slot in the sleeve.

Another form of lathe socket is shown in Fig. 204. By putting a bar through the round hole it may be used between centers and becomes similar to the holder shown in Fig. 202. It is, however, usually used in the tail spindle bearing, the outside taper



FIG. 202.

being the same as on the dead center. When so used it is much safer than when used between centers, as the drill or reamer it holds cannot pull off center.

The holder used for driving the Graham grooved shank drill is shown in Fig. 205. It is made in four sizes, holding from 2½-inch drills down to 3-32-inch drills. By means of reducers, one of which is shown in the figure, small drills may be held in the large chucks. These holders are very compact, being but



FIG. 203.

little larger in diameter than the common socket. As the grooves in the drill are cut parallel with each other, taper shank drills may be grooved to fit correctly in these holders, which, as with the socket shown in Fig. 200, makes a good method for reclaiming drills that have lost their tangs.

The above are all positive drive holders, which, in the case of

sudden stopping of the drill will break it if the machine does not stall. To overcome this, numerous friction drive holders have been devised, one of the best being shown in Fig. 206. In this holder the socket A is held by friction between the end of the



FIG. 204.

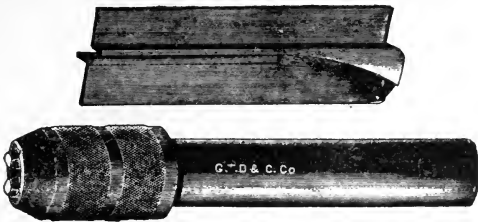

FIG. 205.

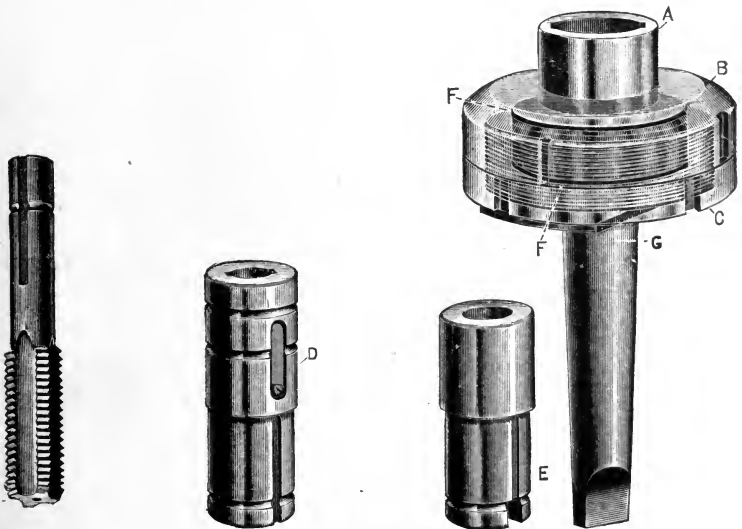

FIG. 206.

shank G and the collar B. FF are fiber washers between the sliding surfaces, which gives a smooth motion when slipping occurs, and enables the operator to more easily adjust the tool to the proper grip. The collar C forms a lock nut to preserve adjustment. The bushings E, which carry the drills, fit in A, being driven by two keys. In its use the collar B is adjusted up until the friction will just nicely drive the drill. This tool, which is made in two sizes, is provided with the necessary bushings for holding drills and taps up to $1\frac{1}{4}$ inches in diameter. Although bushings for holding the ordinary square shank taps may be had, the tap with special shank as shown in the figure is best adapted to use in this holder. In machine tapping, and especially where more than one size of drill is to be used, much time may be saved by the use of this holder. Take, for example, the drilling and tapping of engine boxes, where two drills are used, one the diameter of the stud through the cap, and the other the tapping size for the stud. Each drill is placed in a holder, E. The changes from stud drill or tap drill and to tap are made by slipping out the one holder and putting in another, all of which may be done without stopping the spindle.

Another form of friction tap holder is shown in Fig. 207. In this holder the upper half of the clutch is keyed to the shank, the lower half turning free on the end of the shank. The jaws of the clutch are beveled on their edges, the spring, which is readily adjusted for tension, holding the halves in contact. When the drive on the tap becomes too heavy, the beveled edges force the clutch halves apart, thus allowing the machine spindle to rotate without turning the tap.

The frictional drive tap holders shown in Figs. 206 and 207 require a reversing spindle machine in which to operate them. In Fig. 208 is shown the "Star" tapping attachment which contains a reversing mechanism, thus adapting it to tapping work on machines without reversible spindle. As with the others it is provided with an adjustable friction drive which can be adjusted to the required tension to drive any size of tap the tool will operate.

In its operation the body of the tool is held from rotating by securing the chain shown to some fixed part of the drilling machine. In driving the tap forward the upper spindle, which is independent of the lower, is engaged with the lower by allowing the weight of the body to engage the clutch, which is keyed to the upper spindle, to lock with the lower. The upper bevel gear

runs idle on the upper spindle. When the tap has passed through the work or bottomed as the case may be, raising the drilling spindle first disengages the clutch from the lower spindle, and then clutches it with the upper gear, thus driving the lower spindle through the bevel gears in the reverse direction at an increased velocity due to the increased ratio in the gearing. When a number of holes are to be tapped to the same depth the stop



FIG. 207.

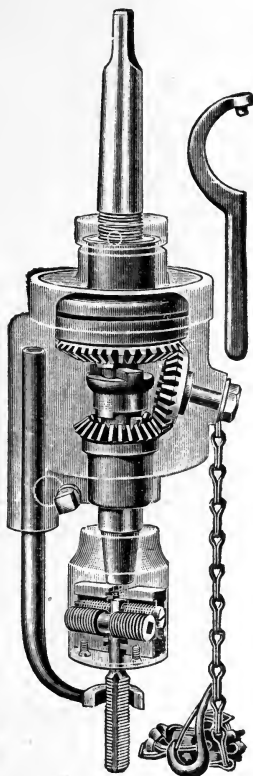

FIG. 208.

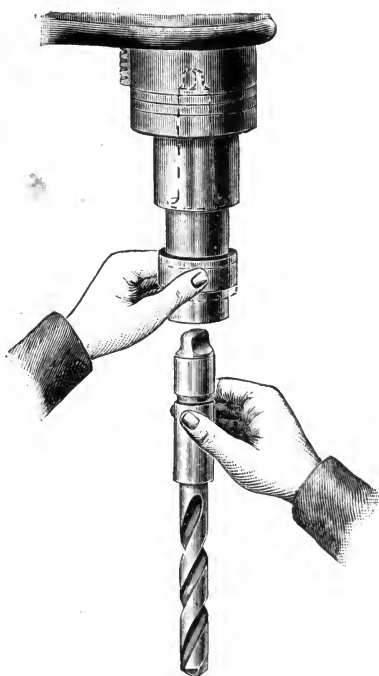

FIG. 209.

shown is used. When this stop comes in contact with the surface of the work, the body of the tool stops and the tap and its spindle draws away from and disengages the clutch. A slight upward movement of the driving spindle engages the gears and the tap is backed out.

The "Presto" drill chuck, Fig. 209, is a positive driven holder provided with an assortment of drill sleeves which may be se-

cured in the holder without stopping the rotation of the machine spindle. The sleeves are driven by a tang and held in position by two pins in the body of the holder which engage the groove shown in the sleeve. The collar, which rotates upon the body of the holder, when down locks the pins into the groove and when held up allows the pins to throw back, releasing the sleeve. A marked saving in time is effected by the use of holders of this character on work requiring various sizes of drills especially when the drilling machine is provided with but one spindle.

Straight shank drills must be held in drill chucks, of which there are a large variety on the market. In Figs. 210 and 211 are shown two well-known chucks for this purpose. They are examples of the two general classes, Fig. 210 showing a chuck in which the jaws have a radial motion, and Fig. 211 one in which

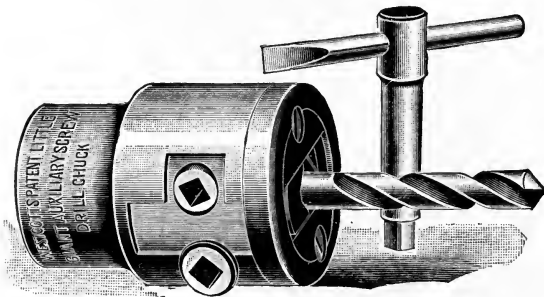

FIG. 210.

the radial motion is due to another motion along the axis of the chuck.

Chucks of the class shown in Fig. 210 are made in sizes to hold from 0 to 2 inches, while those of the class shown in Fig. 211 are not made beyond $\frac{5}{8}$ -inch capacity.

The drill chuck shown in Fig. 212 is regularly made in two sizes holding drills to $\frac{1}{2}$ inch. It consists of a shank, sleeve nut and taper split bushings. The bushings are hardened and hold but one size of drill, separate bushings being required for each size. The compactness of this chuck makes it a very convenient tool for light work. By using a split steel sleeve parallel on the outside and tapered to fit the drill shank on the inside, taper shank drills may be satisfactorily held in the parallel jaws of the drill chuck. In the Pratt chuck, a bar through the chuck has a

rectangular hole, which receives the tang of the taper shank drill, thus making a positive drive.

In using drill chucks, it would be well to bear in mind that the keys and spanners furnished with them will grip the jaws sufficiently tight upon the drill without the assistance of a 12-inch monkey wrench or two feet of gas pipe. Overstraining a chuck destroys its accuracy. Always remove a chuck from the spindle

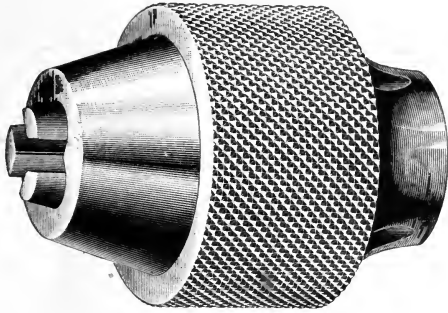

FIG. 211.

the same as you would a drill or socket—with the drift. Don't feel that because it has a large hub you are expected to knock it out with a hammer.

Before inserting the shank of a drill, socket or chuck in its bearing, wipe both surfaces to free them of oil and dirt, thus making them hold better and preventing injury to the surfaces.

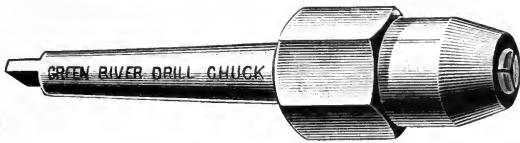

FIG. 212.

In using the drift, a light upward blow on the underside of the outer end will usually start the drill easier than a heavier blow on the end in the direction of its length.

The solid tap wrench, an example of which is shown in Fig. 213, is provided with one or more square holes to fit the squares on the end of the taps. The principal objection to the solid tap wrench is that each hole will properly fit but one size of tap

shank, thus requiring a number of wrenches to meet general requirements. When more than one hole is made in this wrench, the handles become of unequal length when using any but the central hole, which results in an unbalanced pressure on the opposite sides of the tap, producing a transverse strain, in the resistance of which the tap is weak. Good judgment on the part



FIG. 213.

of the operator will, however, enable him to balance these pressures. Again, the tendency is to use these wrenches on taps the squares of which are too small to properly fit in the holes, thus rounding and twisting the tap squares.

In Fig. 214 is shown an adjustable tap wrench. These



FIG. 214.

wrenches adjust to fit a wide range of sizes. Of the particular wrench shown, five sizes take all taps from the smallest to $1\frac{1}{2}$ inch. The dies forming the squares are carefully hardened and fitted in the body of the wrench, thus preserving a true square,



FIG. 215.

which fits nicely the square on the tap to which they should be closely adjusted.

The T-handled tap wrench, Fig. 215, is an excellent tool for holding small and medium-sized taps in the tapping of holes in inaccessible places. It is virtually a split chuck having four

slots cut in the shank which engage the four corners of the square on the tap shank. It is an excellent wrench for driving pin reamers.

Frequently the nature of the work prevents the use of a tap wrench having two handles. In such cases the single handled wrench is used. The handle is preferably attached to the shank through a ratchet, which enables the operator to take shorter strokes than would be necessary with the solid end wrench. Sometimes a common monkey wrench is used for this purpose. It should be a good wrench, having square, true jaws, which should be carefully tightened onto the tap shank each time the wrench is put on. In using a single-handle tap wrench, the workman must steady the shank with the left hand, so as to offset the side pull on the tap.

CHAPTER XII.

MANDRELS.

The term mandrel is applied to that class of tools upon which work that is to be machined between centers is usually held. It is frequently called an arbor, although the distinction between the two may be quite clearly defined. A mandrel is designed to carry work that is to be operated upon by a cutting tool, while on the other hand the arbor carries and drives a cutting tool, as with the milling machine and saw arbors.

Mandrels may be classed under two heads, solid and expanding. The solid mandrel is made slightly tapering, in order that it may be forced to a tight fit in the bore of the work. The amount of this taper varies with the class of work the mandrel is to be used on, it being but slight at the most.

A bar of common round iron or steel centered and turned to the required diameter constitutes the mandrel in its simplest form. Such a tool, as is usually found in the average jobbing shop, is shown in Fig. 216. It is hardly worthy the name man-



FIG. 216.

drel, and although a solid one might fairly come under the expanding, or rather shrinking class, as it is brought down by turning and filing to fit the bore of every new piece of work that comes along. It has one quality, however, that can always be depended upon, and that is untruth. With mandrels of this class accurate results cannot be expected.

Since a mandrel must be rigid, it should be as short as the nature of the work will permit, and made of as stiff a material as possible. Its centers should be carefully formed, and the body finished cylindrically true upon them. The centers, at least, should be tempered or case hardened, to prevent their wear-in out of true. In Fig. 217 is shown the correct construction for the end of a mandrel. The end for a length about equal to the

diameter of the tool is reduced slightly in diameter and provided with a flat on one side, against which the screw of the dog or driver is set. As the dog is very apt to mutilate somewhat the ends, this reduction in diameter is quite necessary. Since the accuracy of the mandrel depends so much on its centers, it is necessary to protect them as much as possible from injury while forcing the mandrel into the bore of the work. This is best

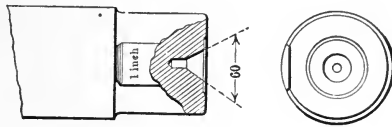

FIG. 217.

accomplished by recessing the ends around the center bearing as shown in the figure. The angle of the bearing should be 60 degrees, with a small hole drilled at the bottom. The object of this drilled hole is to prevent strain being thrown onto the delicate point of the machine center, and to form a small oil reservoir to aid in lubricating the bearing.

In Fig. 218 is shown a hardened and ground steel mandrel. These tools are made for general shop work, the length increasing with the diameter from $3\frac{1}{4}$ inches for a $\frac{1}{4}$ -inch mandrel to 17 inches for a 4-inch. These lengths are, of course, arbitrary



FIG. 218.

and may for special uses be materially increased or decreased. As manufactured by the several makers, these mandrels differ but little in length and details of design. They should be made of a good grade of tool steel, carefully hardened with the centers lapped true after the hardening, and the body ground cylindrically true upon these centers, it being rotated upon stationary or dead centers for this last operation.

When the greatest possible accuracy is required it is considered best to make these mandrels of tough, unannealed tool steel, with the ends only hardened. This arises from the fact

that the steel if hardened throughout changes somewhat in form and receives temper strains, which, although relieved in the grinding, does not allow the tool to immediately take its permanent set. For this reason a mandrel that has been hardened throughout should be first rough ground, leaving a small amount for final finishing. This finishing should not be done for some time after the rough grinding, thus allowing the tool to season and to acquire permanent set. The set will not be appreciably altered if only a very small amount is left for the final finish.

Hardening makes the mandrel stiffer and less liable to surface injury than in the case of the unhardened one. It is not, however, for the purpose of allowing careless workmen to run their cutting tools into its surface with the idea that it will not be injured thereby. Cutting tools are usually made of a higher grade steel than the mandrel, and often tempered harder, in which case the mandrel suffers if the tool comes in contact with it.

These mandrels are usually tapered about one-hundredth of an inch to the foot, the diameter being exact at the center. The size is stamped on the flat at the larger end. They will fit holes reamed with standard reamers, although the taper prevents uniform grip on the work at the two ends of the bore. In forcing these mandrels into the bore, good judgment must be exercised, as they constitute a wedge, which will produce enormous pressure if forced too hard, resulting in bursting the work if hard and brittle, or if soft in permanently enlarging the bore and giving it a taper corresponding to that of the mandrel.

The use of the hardened and ground mandrel does much toward the preserving of uniformity in the size of holes, in the work of shops, where these tools are used. A hole only a few thousandths of an inch under or over size prevents, in the first case, the mandrel from entering, and in the latter allows it to fall through. Its slight taper makes it a good comparative gauge by means of which minute differences in diameter of bores may be compared by the relative distance to which the mandrel enters.

Expansion mandrels, while possessing the decided advantage over the solid ones of a parallel grip in the bore of the work, have too often the disadvantage of complication of parts, which makes them unsuitable for the most accurate work, and especially so after they have become somewhat worn. These objections, however, can hardly be said to exist in the case of the mandrel shown in Fig. 219. This mandrel consists of a cast-iron bushing, having a

tapered bore, which fits accurately the taper of the mandrel. The bushing, which is ground externally, parallel and to exact diameter, is split partly through at two points, and entirely through at a third, thus allowing for a slight expansion when the mandrel is driven in. Three bushings varying by sixteenths for the smaller and eighths for the larger sizes may be used on each size of mandrel. The taper used is $\frac{1}{2}$ inch per foot, the bearing surfaces being accurately ground. It is evident that the allowable amount of expansion is small, yet sufficient to grip firmly in an accurately

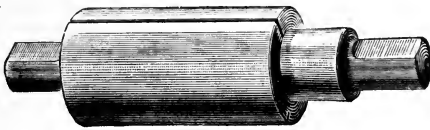

FIG. 219.

sized hole. An attempt to expand this bushing in an oversized hole would result in cracking it; a thing that would happen before the bushing, due to its expansion, would throw the mandrel appreciably out of true. The bushings are regularly listed from $\frac{3}{8}$ inch to $3\frac{3}{8}$ inches in diameter, requiring eleven mandrels for the complete set.

The expanding mandrel, Fig. 220, consists of a hardened and

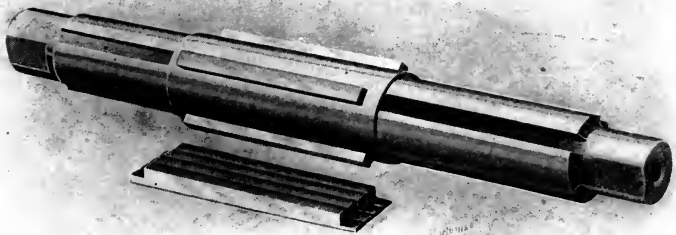

FIG. 220.

ground mandrel with four splines milled at an angle with the axis, four jaws and a containing band of seamless drawn steel

tubing. The jaws fit the slots in the band nicely and are carefully seated on the bottom of the grooves in the mandrel.

The outer edges are ground parallel. Forcing the mandrel through the jaws expands them. These tools are regularly made in eleven sizes, taking from $\frac{3}{4}$ inch to 7 inches. On those running between 1 inch and $2\frac{1}{2}$ inches two sets of jaws are furnished for each mandrel, and above $2\frac{1}{2}$ inches three sets.

The mandrel of Fig. 221 consists of three stepped jaws, capable of end motion in three splines, which are milled in the body of the mandrel at a considerable angle with the axis. The head A, which moves over a parallel portion, E, of the mandrel is recessed at C to receive the notched ends of the jaws, thus holding them in the same relative position. In operating, the jaws are moved to the small end of the mandrel, the work placed

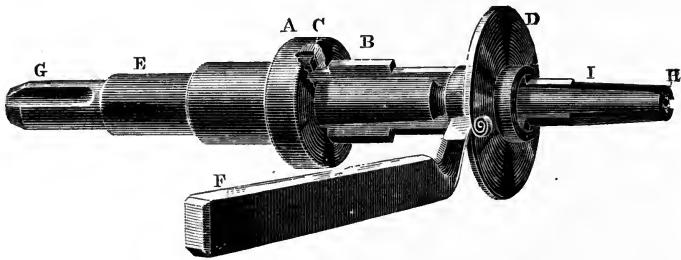

FIG. 221.

on the proper step and the mandrel forced through, the jaws expanding to the bore of the work. This tool is made in four sizes, fitting all bores from $\frac{1}{2}$ to 4 inches.

When it is necessary to face a piece of work that is being driven on a mandrel close down to the bore, the expanding types, as shown above, have the advantage over the solid mandrel, since the work can be left projecting slightly over one end of the bush or jaws, which allows room for the cutting tool to pass over the edge of the bore.

Frequently it becomes necessary to machine work, the bore of which is other than cylindrical, on a mandrel. When the cross-section of such bores is circular, a cone mandrel can be used to advantage. Such a tool is shown in Fig. 222. It is strictly a special tool, as its range of adaptability is small. It is necessary that the faces, A A, of the work be machined at right angles to the bore before placing on the mandrel, as otherwise the work

will not be held concentric with its axis. The coning bush, B, may be shrunk on, pinned or threaded to the mandrel, and C should be keyed and backed up with a nut. These bushes should be turned in place on the mandrel centers.

For mandrels of large diameter the form shown in Fig. 223 is frequently used. Here the draw bolts, A A, two to four in number, take the place of the nut in the preceding figure. As be-

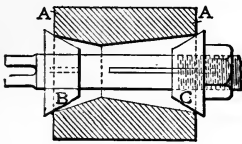

FIG. 222.

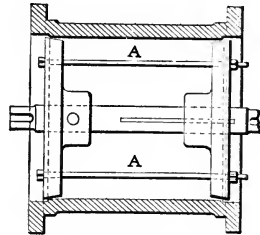

FIG. 223.

fore, one disk is secured to the mandrel and the other keyed but capable of motion over it.

In Fig. 224 is shown a kink in mandrels that for some classes of work can be used to advantage. As with all tools of this class it should be reasonably well made, accurately finished as to diameter and parallel. A short piece of round drill rod serves for the roller which lies in a milled groove that is a few thousandths of an inch deeper at the back than the diameter of the roller. In

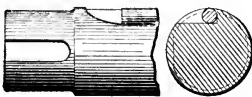

FIG. 224.



FIG. 225.

operation, the first start of the work to turn wedges the roller between the slot and the wall of the bore, holding the work firmly from turning. A slight backward turn releases it, and the mandrel can be slipped out without pounding. The bore of the work must fit the mandrel exactly, as the slack is all taken up on one side, which will throw the work out of true if loose. This mandrel would not be suitable for work on which the pressure of the cut was in the direction of its axis, as in most milling and planing between centers.

When the bore of the work is threaded, the mandrel must be provided with a thread to fit the bore, and a radial face, against which the work screws to a stop. This is commonly known as a nut mandrel, and in its simplest form is shown in Fig. 225. Work that is to be finished on this mandrel should at the time of threading, if possible, have one face turned at right angles to the bore, so that it may seat squarely against this face. This, however, is not possible when the work is tapped, as is the case with nuts. Since, for rapidity of manipulation, the mandrel should not fit the thread of the work too closely, an untrue seat cocks the work, and it is not faced squarely. The ball seat face of the mandrel shown in Fig. 226 overcomes this difficulty very nicely.

In finishing round, smooth machine parts on a screw or nut mandrel, they usually tighten under the pressure of the cut so firmly against the face, that it is difficult to remove them without



FIG. 226.

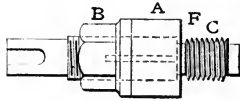

FIG. 227.

injuring their finish. The mandrel shown in Fig. 227 is a valuable tool on work of this character. The collar A forms the bearing face F and is keyed to the mandrel, the spline allowing it to slip back when the nut B is slacked, and thus relieves the pressure between F and the face of the work. By using a finer pitch thread in B than the mandrel thread, C, or a left-hand thread in B, when C is right hand, the collar may be omitted. This makes a cheaper mandrel, but is not so good, as the nut and work lock so firmly that considerable force is usually necessary to start the former. When the work is to be faced the threaded portion of the mandrel should be somewhat shorter than the thickness of the work, thus allowing the cutting tool to reach the tops of the threads in the bore without injuring the mandrel threads.

A stub mandrel is one used in the end of a piece of work, as shown, for example, at A in Fig. 228. These generally fit a tapered seat, and are special in character.

Mandrels will usually drive the work by friction. If the work is large in diameter for the size of the bore, it should be driven,

if possible, from a point near the circumference, independent of the mandrel. A mandrel the surface of which has been oiled slightly, will drive nearly as well as if dry; and the chances of abrasion, in case of slipping, with its certain injury to tool and work, materially decreased.

Mandrel center bearings are often made too small to wear well, as the intense pressure between the machine center and the bearing prevents proper lubrication and increases the chances of breaking off the center. A shallow trench, cut to the point of the machine center on the top side, improves the chances of getting oil to the bearing and does not injure the center, the pressure on it being generally from the under side. When rotating between rigidly clamped centers, the slight expansion of



FIG. 228.

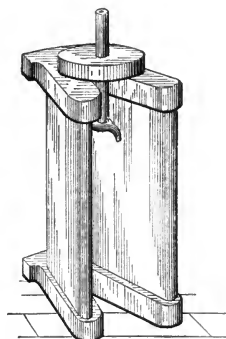

FIG. 229.

the mandrel, due to the heating of the work, will frequently increase the pressure between centers and bearing sufficient to force out all lubrication, and cause abrasion of the surfaces, which is certain to ruin the bearing. This trouble is most likely to occur when the work is rotating at a high rate, as for filing or polishing. This bearing should, therefore, be of liberal size and well lubricated.

Since the value of a mandrel depends largely upon the condition of its center bearings, it is very important that they be carefully protected from injury in driving. Nothing harder than a copper hammer should be used on the mandrel ends. A babbitt hammer or raw-hide mallet is preferable. If these are not available, a block of tough wood, end grain, must be used under the common hammer. The mandrel block shown in Fig.

229 forms a solid support for the work while the mandrel is being driven in or cut.

The best practice dispenses entirely with driving and presses the mandrel into the bore. A press designed for this purpose is shown in Figs. 230 and 231.

The smaller press, Fig. 230, is for light work, handling mandrels up to $1\frac{1}{2}$ inch in diameter. It is arranged to clamp to the bed of the lathe or on a bench. For the heavier work the press shown in Fig. 231 is suitable. It is mounted on its own column and

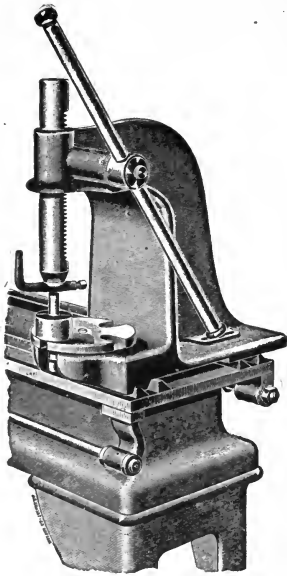

FIG. 230.

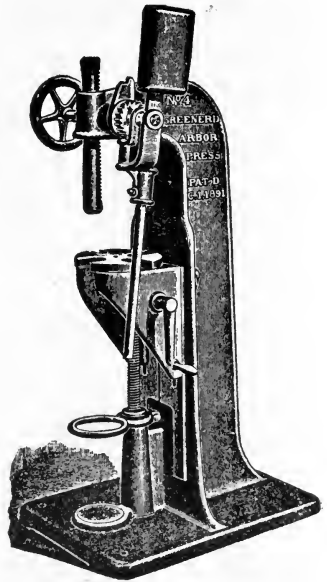

FIG. 231.

provided with an adjustable knee. The plunger and lever are counter-weighted and a ratchet lever adjustment provided on the pinion shaft. When the lever is up the pawl is disengaged and the plunger can be quickly adjusted to any required height by turning the hand wheel. A lead pad on the base of the column prevents injury to the mandrel should it fall in pressing out. The loop shown prevents the mandrel from falling on its side. With these presses mandrels may be forced squarely without injury to them or the work.

CHAPTER XIII.

THE LATHE.

That most important of all machine tools, the lathe in its several forms, naturally comes first for our consideration. The great variety of work that can be performed on the lathe, and the efficient way in which it is done, are the conditions upon which its importance depends. The young mechanic, when com-

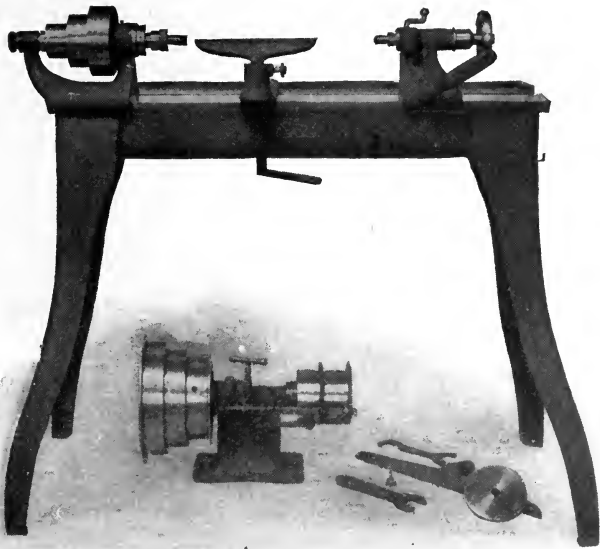

FIG. 232.

plete master of the lathe, as used in general work, will have learned nearly all the principles involved in the operating of the other classes of ordinary machine tools.

For special work the lathe is so modified to meet the particular conditions that its identity is almost lost. For example, the turret lathe, the screw machine, the pipe threading machine, the cutting off machine and even the vertical boring mill are all

modifications of the lathe in which the principle of rotating the work to a stationary cutting tool is carried out.

The speed, or hand lathe, an example of which is shown in Fig. 232 is the simplest form of metal turning lathe. It is a single geared lathe which means that the cone is secured to the spindle, the number of changes in spindle speed depending upon the number of steps on the cone. The tool rest is adjustable in all directions, but not provided with feeds. These lathes, when provided with foot-power mechanism, may be driven by the operator. They are, however, usually furnished with a countershaft and driven from some other source of power. The hand lathe is used for all classes of turning operations in which a hand tool is used. They are also used for drilling, filing and polishing rotating work. When used largely for drilling, the lever operated tail stock spindle, as shown in Fig. 233, is of value, as



FIG. 233.

it provides for a quick movement of the spindle and is more sensitive than the wheel and screw feed. In the tail-stock shown the spindle, screw and hand-wheel are mounted in a quill which fits the bearing in the body casting. A segment of a gear pivoted at the back of the body casting engages a rack cut on the quill. Turning the segment by means of the lever moves the quill and spindle. Locking the segment secures the quill, and the ordinary screw feed can be used independent of the lever.

The standard engine lathe as shown in Fig. 234, and so extensively used for general shop work, is in the smaller and medium sizes a double-gearred screw-cutting lathe. In the larger sizes triple, or quadruple gearing is used instead of double, the term double, triple and quadruple referring to the number of speed reductions in the back gearing. The term self-acting implies that the cutting tool is automatically actuated in all of its feeds.

The lathe primarily consists of four elements:—bed, head-stock, tail-stock and carriage. The bed is the foundation upon

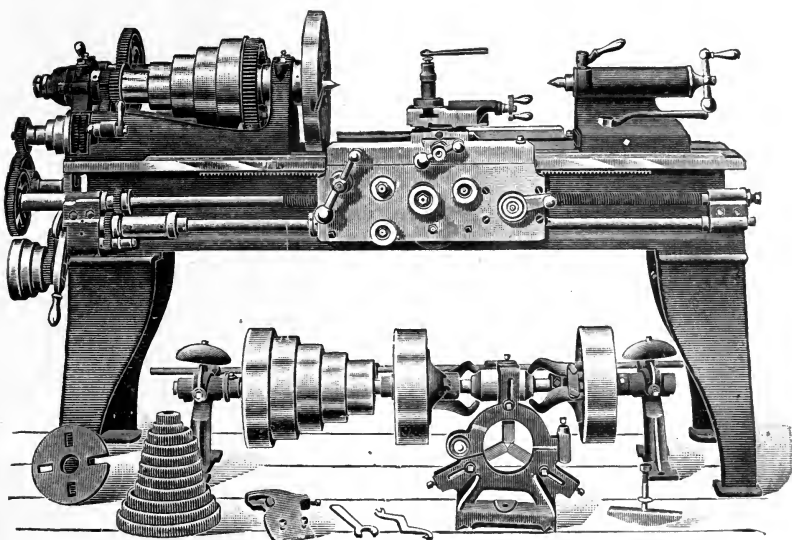

FIG. 234.

which the other elements operate over accurately planed and fitted shears. It should be well designed, heavy and rigid. The deflection due to its own weight and the pressure of the cut must be within very narrow limits. The form of shears used, on engine lathes, almost without exception, is shown in the cross section of bed, Fig. 236. The head and tail-stocks rest upon the inside pair and the carriage on the outer pair. This view also shows the cross section of bed usually employed. It consists of two parallel I's tied at frequent intervals by the cross girts shown. Beds, when short, are supported on legs at the ends, as shown in Fig. 234, but when the length becomes excessive and ma-

terial deflection due to its own weight would result, one or more intermediate supports are introduced.

The head-stock contains the mechanism that receives and transmits the power through the spindle to the work. Its important features are the retaining head and spindle bearings, spindle, cone, feed, screw and back-gearing. The retaining head should be so formed as to best resist the heavy strains to which it is subjected. It should be properly fitted to the inner shears and clamped in place. The live spindle and spindle bearings are the most important elements in the lathe, as the accuracy of the work produced depends very largely upon the accuracy of the spindle. It should be cylindrically true, accurately fitted in its bearings and its center of rotation exactly parallel with the shears. The threaded nose and center bearing must be exactly concentric

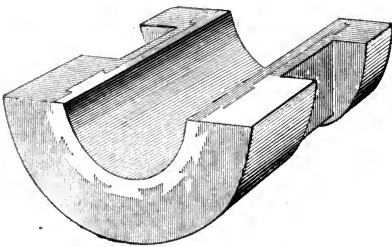

FIG. 235.

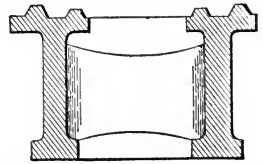

FIG. 236.

with the bearing parts of the spindle. The cone should be given a nice bearing fit on the spindle and the back gears properly cut and pitched. The feed and screw cutting gear should be reliable and powerful. The head-stock of the lathe shown in Fig. 234 illustrates the general form as used in double geared lathes.

The live spindle bearing is usually made of bronze or genuine Babbitt metal. When the latter material is used it is, after being cast in the casing, peaned sufficiently to fill out any shrinkage as well as to intensify the metal, after which it is bored, reamed and carefully bedded by scraping to an accurate fit on the spindle. The Babbitt bearing as used on the lathes by the F. E. Reed Co. is shown in Fig. 235. In order to reduce the wear to a minimum the spindle bearings should be large. Provisions for taking up the wear are, however, always necessary. The end thrust of the spindle is usually taken at the end bearing, an adjustable thrust screw receiving the pressure. The



modern engine lathe is usually provided with a hollow spindle, the size of the hole often being as large as the diameter of the spindle will safely permit. This is frequently a point of great value in working up stock that will pass through the spindle. All back-gearled lathes may be run as single geared lathes by locking the cone with the spindle gear. The purpose of the back-gear is to reduce the speed of the spindle and correspondingly increase its pull. Thus, with a five step cone running single geared, five changes of speed can be had, the speed reducing and the leverage increasing as the belt is shifted from the smaller to the larger steps. If, for example, the smallest step is 6 inches and the largest 18 inches in diameter and the countershaft cone has steps of the same diameter, as is commonly the case, then, if the belt is running on the large step of the spindle cone, which is making say twenty-five revolutions per minute, a shift to the smallest step will give, if the belt continues to run at the same speed, $3 \times 25 = 75$ revolutions per minute, but in shifting to the small step on the spindle cone, the belt goes to the large step of the counter cone, which, since the counter runs at a constant number of revolutions per minute, increases the belt velocity in the ratio of 6 to 18, or three times, and consequently the spindle will revolve $3 \times 3 \times 25 = 225$ times per minute. If now the back gear is thrown in, five more reductions in speed may be had. In Fig. 237 is shown an outline of the double gear arrangement. The cone, when back-gear is in, is disengaged from the spindle gear D, which allows it to rotate free on the spindle. Gear A of say 30 teeth is secured to the cone, revolving with it. A gears with B of 80 teeth, B and C rotate together, C of 20 teeth gears with D of 90 teeth, and since D is keyed to the spindle the latter is driven by the cone through the chain, A, B, C and D. If we assume as before that the belt is on step F and the spindle makes 25 revolutions per minute, putting in the back gear decreases the rotation of the spindle by the amount of the back gear ratio $= 30 \cdot 80 \times 20 \cdot 90 = 1 \cdot 12$, which would give $25 \times 1 \cdot 12 = 2 \cdot 12$ revolutions per minute. If on the small step of the cone, it would be $225 \times 1 \cdot 12 = 18\frac{3}{4}$ revolutions.

In outline, Fig. 238, is shown the usual triple gear arrangement. Let A, B, C, D, F, G represent the same values as in Fig. 237. If I and J are thrown out by moving them through their bearings in the direction of the arrow, and C thrown into gear with D, we would have the same conditions as in Fig. 237.

When arranged as shown in the figure, however, H corresponds to C, and I to D, J rotates with I and gears with the internal gear on the back of the face-plate and thus gives a second geared reduction. The velocity ratio would then be $30\text{-}80 \times 30\text{-}60 \times 40\text{-}200 = 3\text{-}80$ or for the 25 revolutions of the cone in the former example the spindle would revolve $25 \times 3\text{-}80 = 15\text{-}16$ of one revolution.

In large lathes performing very heavy duty, the application of the power to the circumference of the face-plate steadies the cut and removes the excessive torsional strain that would be thrown upon the spindle if all the power was transmitted through it.

The tail-stock, or foot-stock, as it is frequently called, is accurately fitted to the inner shears. It can be moved along the

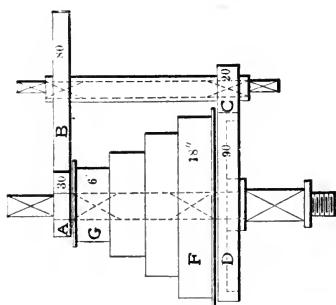

FIG. 237.

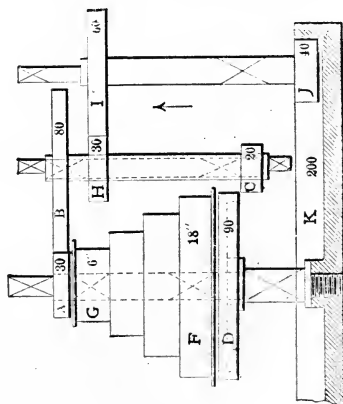

FIG. 238.

shears and clamped firmly to them at any point. The function of the tail-stock is to carry the tail or dead spindle. This spindle fits its bearing closely, can be moved in or out through a considerable range and clamped in any position. The axis of the dead spindle extended should be coincident with the axis of the live spindle. The dead spindle is always provided with a cross adjustment commonly called the set over and much used for turning external tapers on work held between centers, as well as for making the close adjustment necessary to bring the center exactly in line for parallel turning.

A form of tail stock largely used in Europe is shown in Fig. 239. It is becoming quite popular among American builders.

Its leading advantage is in its use on a lathe having a compound rest, as it allows the rest to swing around parallel with the shears and still get in reasonably close to the center when the tail-stock is close up to the carriage. It is commonly called the "cut-away" tail-stock.

The carriage is the tool carrying device and stands next to the head-stock in importance. It rides, as shown in Fig. 240, on the

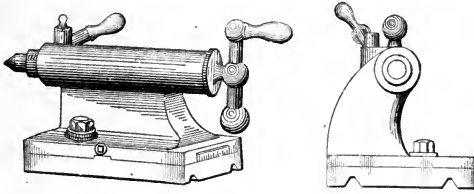

FIG. 239.

outer shears and is gibbed front and back to the outer under faces directly below the shears. Gibbing to the inner under faces and weighting the carriage have given over to the better practice above referred to. The old weighted carriage in which a heavy weight, suspended from the bottom, held it to the shears precluded the possibility of cross girts to stiffen the bed and increased the

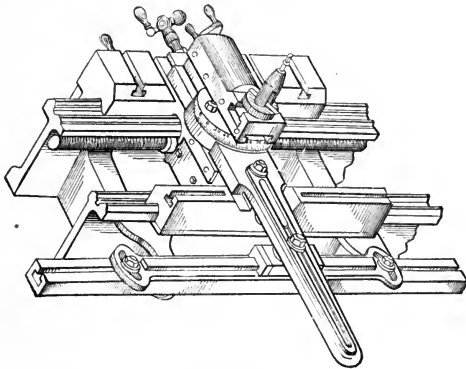

FIG. 240.

wear between shears and carriage. The apron on the front side of the carriage contains the feed mechanism and, with the exception of the make of lathe of which Fig. 240 shows the carriage, the lead screw and lead nut. The details of the apron vary considerably, all however, being intended to accomplish the same results. In general, motion is transmitted from the splined feed

rod through a keyed sleeve which slides over the rod and carries a bevel gear which connects through a clutch and suitable train of gears to the pinion which engages the rack on the under front edge of the top of bed. In a similar manner the motion is communicated to the pinion on the cross-feed screw. By engaging either clutch the feed that it controls will operate.

A suitable clamp for securing the carriage to the shears for cross-feed work is always provided. The most common method is to pinch either the front or back gib, the square head screw shown on the top right-hand side of carriage in Fig. 234 being for this purpose.

The slide rest which carries the cutting tool is gibbed to a cross shear which is exactly at right angles to the spindle. In its simplest form the slide rest is a single piece carrying the tool post or clamp. This forms the most rigid rest, it having but the one gibbed joint. The raise and fall rest is shown in Fig. 241. It

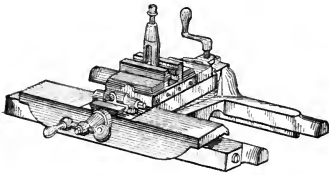

FIG. 241.

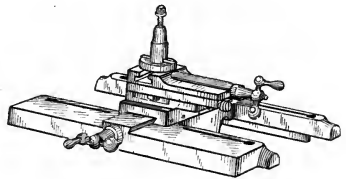

FIG. 242.

is a form of elevating rest. In Fig. 242 is shown a compound rest. This form, while not as rigid as the plain rest, has become very popular among machinists, because of its points of convenience. It has the regular automatic cross-feed and the auxiliary feed which can be operated at any required angle with the spindle. This latter feed for the larger lathes is frequently made automatic. The manner in which it is accomplished by the Putnam Machine Company, on lathes from 22 to 42 inch swing is shown in Fig. 243. Here the splined cross-feed screw carries a sleeve, which, by means of an eccentric operated by the handle at the left, can be clutched with one of the four bevel gears that transmit the motion to the nut.

The slide rest shown in Fig. 244 is for use on speed lathes as shown in Fig. 232 for light turning work. It may be clamped in any desired position on the bed. It is provided with hand

feeds only, and as the slides are mounted on a graduated base it may be set at any desired angle for taper turning.

In all engine lathes the carriage is moved over the shears by means of the lead screw or the feed rod and their connections. The former constitutes a positive drive without possibility of

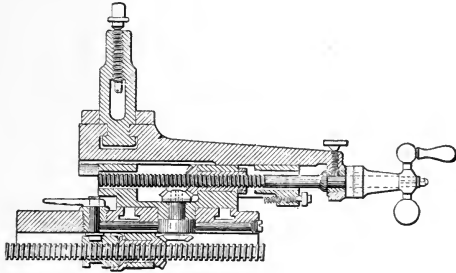

FIG. 243.

slippage, while the latter is a purely friction drive. The independent feed rod is frequently dispensed with in small lathes, and the lead screw made to do its work. In such cases the lead screw is splined and the feed mechanism is driven from a collar which has a feather engaging the spline and slides over the lead

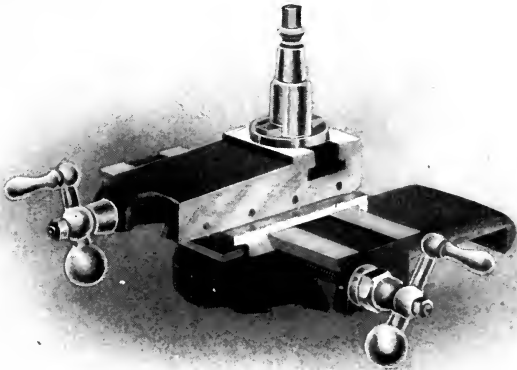

FIG. 244.

screw. As the feed is engaged by means of a clutch this also forms a frictional driver.

The feed rod is driven by belt and provided regularly with three changes of speed. Since it is frequently desirable to have

feeds finer or coarser than these three changes can give, it is now quite common to provide either a change gear connection with the feed rod as shown in Fig. 245 or provisions for connecting the feed rod with the change gear mechanism of the lead screw as

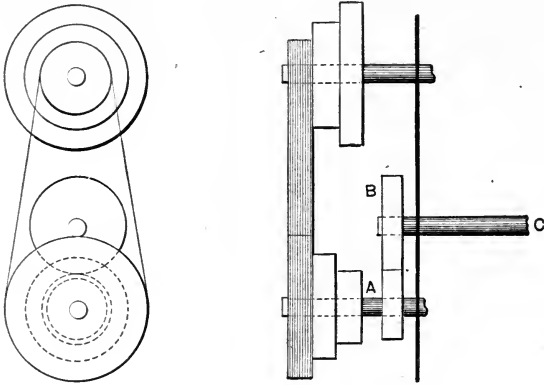

FIG. 245.

shown in Fig. 246. In Fig. 245, by changing places with gears A and B, or substituting others any desired speed of feed rod C can be obtained. In Fig. 246 when gear E is in dotted position the feed rod is driven by belt in the usual manner. When, how-

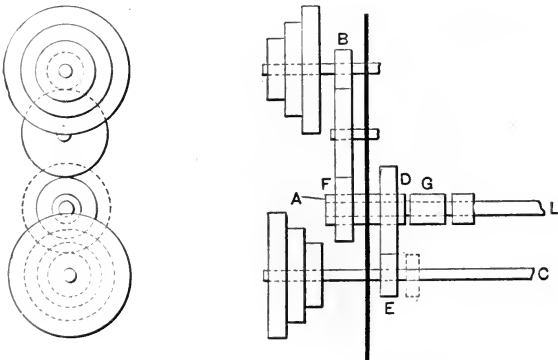

FIG. 246.

ever, change-gear feeds are required E is in position shown and is driven by the gear D which is secured on the sleeve A and receives its motion through the change gears F and B. The clutch G, which slides over a key in the lead screw L, is dis-

engaged from the sleeve A, thus preventing the lead screw from turning while the feed is in operation.

As the carriage must be capable of feed in either direction, a change in direction of motion of feed mechanism must be provided for. This is usually accomplished by interposing an idle gear either in the mechanism of the apron and allowing the feed rod to rotate constantly in one direction, or in the head-stock gearing. The latter is the more common method, inasmuch as a change in direction of lead screw rotation is necessary and that cannot be accomplished in the apron. In Fig. 247 is shown the arrangement of gears usually employed. Gear A is secured to the spindle of the lathe. When A gears with B, the direction of rotation of the feed cone is as shown by the arrow. B and C rotate on studs secured in a plate which turns about the axis of D. By throwing the handle H down and C into mesh with A, B becomes in-

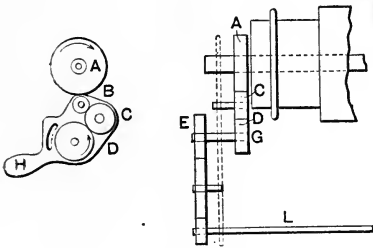

FIG. 247.

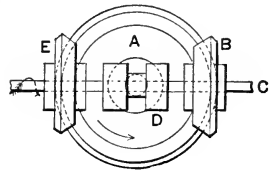

FIG. 248.

operative and the direction of rotation of D is changed. The stud G also carries one of the change gears E. The diameter of gears B and C is immaterial, inasmuch as they are simply idlers between A and D, and do not affect the velocity ratio. When gear D is of the same diameter as gear A the stud and spindle have the same rate of rotation. D is, however, frequently made smaller than A, giving the stud a higher rate of rotation.

The mechanism shown in Fig. 248 is frequently employed for reversing the feed in lathes and other machine tools. The feed rod C carries two bevel pinions B and E and the clutch D. D slides over a key in C and engages either E or B, both of which run loose upon C and mesh with the bevel gear A. When D and E are locked the rotation of A will be as shown by arrow, B turning free on the shaft, and when B and D engage the direction of A is reversed.

The lead screw is one of the most important parts of the lathe, as accurate screw threads cannot be produced with an inaccurate lead screw. The builders of first class lathes use great care in the production of their screws, the lathe used for cutting them being provided with a carefully cut master screw which is used only for the cutting of lead screws, used on that lathe. The wear on this master screw is therefore very slight, and as soon as the lead screw shows signs of inaccuracy the master screw is substituted and a new lead screw for the lathe cut. In this way the standard of the master screw is very closely maintained.

The lead screw draws the carriage, the force being applied at the nut. It is, therefore, best to take hold of the carriage as close as possible to the shears and thus avoid the tendency to cramp the carriage. In the lathes manufactured by the American Tool

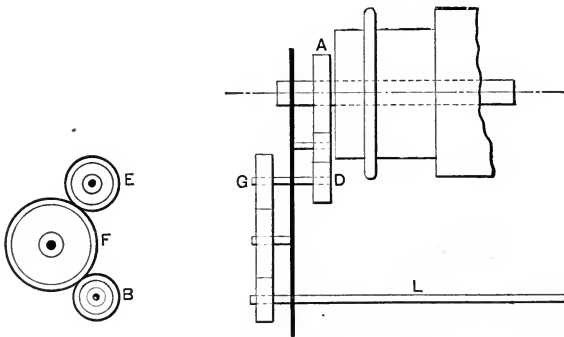

FIG. 249.

Works Company, the lead screw is placed inside the shears, as shown in Fig. 240, in such a manner as to get the most direct pull on the carriage.

The lead screw nut is made in halves usually of brass and so mounted in the apron that it can be readily closed onto the screw.

In order to cut threads of different pitches with the same lead screw a set of change gears must be provided for the lathe, so that the advance of the screw, carriage and tool per revolution of the spindle may be exactly equal to the pitch of the thread being cut. In Fig. 249 is shown the common arrangement of change gear, generally called a single gear. Gears A, D, and E, and the stud G, correspond to the same parts in Fig. 247. L is the

lead screw, B the gear on screw, and F an idler of any convenient size.

In cutting any number of threads per inch the point of the tool must move along the work an amount exactly equal to the pitch of the required thread for each revolution of the work, thus if the pitch of the lead screw is 1-6 of an inch and the pitch of thread to be cut is 1-10, it is evident that the lead screw will make less than one revolution while the work is making one. The tool has advanced 1-10 of an inch and the lead screw must have rotated through 6-10 of one revolution. If, therefore, the work and the screw were geared together the ratio 6-10 would represent the ratio of $\frac{\text{teeth in gear on spindle.}}{\text{teeth in gear on screw}}$. This direct ratio cannot usually be used as the gears A and D are generally of different diameters.

Assume A as having 40 teeth and D 20, then the stud G makes two revolutions for one of the spindle and work. Assume the lead screw as having six threads per inch, to determine the number of teeth in gears E and B to cut any required number of threads per inch on the work. If six threads are required the screw must make one revolution to the work one, and since gear E rotates twice as fast as the work it should have one-half as many teeth as gear B.

The following general expressions give the ratio of teeth on stud to teeth on screw in problems similar to the above:

$$\frac{\text{Teeth in gear on stud}}{\text{Teeth in gear on screw}} = \frac{\text{spindle rotation}}{\text{stud rotation}} \times \frac{\text{threads on screw}}{\text{threads on work}}$$

With same condition as above, required to cut $12\frac{1}{2}$ threads:

$$\frac{\text{Teeth in stud gear}}{\text{Teeth in screw gear}} = \frac{1}{2} \times \frac{6}{12\frac{1}{2}} = \frac{6}{25}$$

As 6 is too low a number of teeth for practical use both terms of the ratio must be multiplied by some number that will give gears of reasonable size. In the present case use 3 which gives 18 teeth in stud gear and 75 in screw gear.

Frequently when very wide ranges of screw cutting are desired a compound system of gearing similar to that shown in Fig. 250 is used, thus avoiding the use of excessively large or very small gears. In this arrangement H is the intermediate stud, I the

first gear on stud and K the second. This gives two gear reductions in place of one in the single gear shown in Fig. 249. The calculations for determining the proper number of teeth in each gear to cut any thread with the compound gearing involves one more ratio than with the single.

Assuming the velocity ratio of the stud G and the spindle the same as in Fig. 249, and the lead screw $\frac{1}{8}$ pitch, we first determine the velocity ratio between the stud G and the lead screw necessary in cutting the required number of threads per inch on the work. For example, to cut 100 threads per inch we would find the ratios between the stud and screw = $\frac{1}{2} \times 8-100 = 1-25$. As we would not care to use a gear having fewer than fourteen

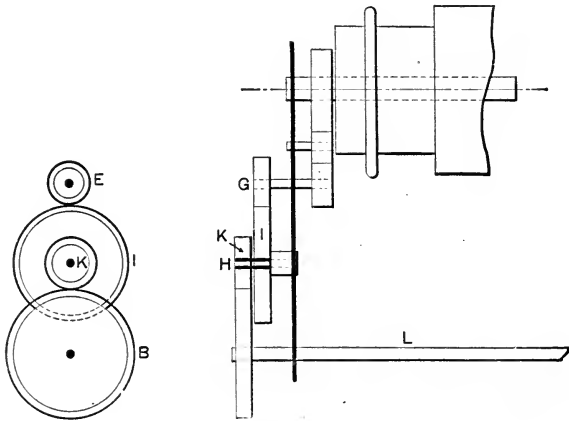

FIG. 250.

teeth on the stud, a gear of 350 teeth would be required on the screw if single geared. With the compound gearing, however, we are enabled to divide this ratio into factors $1-5 \times 1-5 = 1-25$. We could therefore use fifteen teeth on gears E and K, and 75 teeth on gears I and B. In like manner if 70 threads were to be cut $\frac{1}{2} \times 8-70 = 8-140 = 4-70$, as ratios between stud and screw = $2-10 \times 2-7$, which would give 15 and 75 teeth for one pair and 20 and 70 teeth for the other pair.

Any pair of gears, in which the teeth have the required ratio, may be used, it of course being desirable to so select the change gears that the greatest possible number of required pitches may be cut with as small an assortment of change gears as possible.

In order to avoid the time lost in changing gears where large

varieties of different pitch threads are to be cut, several builders have brought out lathes in which the change gears are all mounted, a change from one to the other being made by a simple lever movement. In Fig. 251 is shown this class of change gear mechanism as applied to the Hendey-Norton lathes. It will be noticed that the change gears are all mounted on the lead screw and that the auxiliary shaft A is driven through the gear mechanism from the spindle at a fixed velocity ratio with the spindle. Gear B is an idler mounted on the shifting lever and communicates the motion from A to any gear on the lead screw. In this manner twelve changes in pitch may be obtained without changing gears and for each change in size of gear on A twelve more pitches may be cut.

In this particular lathe the reversing mechanism of Fig 248 is applied in the head as clearly shown in cut. By a suitable combination of levers the operating of the reverse is controlled by a lever in the apron thus allowing the work to run in one direction all the time.

In a mechanism of this character the gears must be rigidly mounted and accurately cut and pitched, as otherwise in such long trains the spring and back lash is excessive.

The form of thread usually used on lead screws has sides of about 15 degree angle, as this form allows for taking up the wear in the nut by closing it onto the screw. The United States standard thread is not well adapted as the steep angle of its sides forces the nut, which is necessarily made in halves, apart.

The lead screw and nut should never be used for ordinary feeds as the screw would soon lose its accuracy through wear. Unfortunately for the accuracy of the screw a comparatively short portion of its length usually does most of the leading for threads cut in the lathe, and as a result that portion becomes worn and inaccurate while the balance remains in good condition.

The size of a lathe is commonly determined by its swing and the length of the bed, the swing referring to the greatest diameter of work, when held on the face plate or in a chuck, that the lathe will turn over the shears. Thus, an 18-inch by 10 foot lathe means one that has a bed 10 feet long and will swing work 18 inches in diameter. The builder usually allows from $\frac{1}{8}$ to $\frac{1}{2}$ inch over the rated swing, thus making it possible to actually finish a piece of work of the same diameter as the normal swing of the lathe. The swing over the carriage and greatest distance between

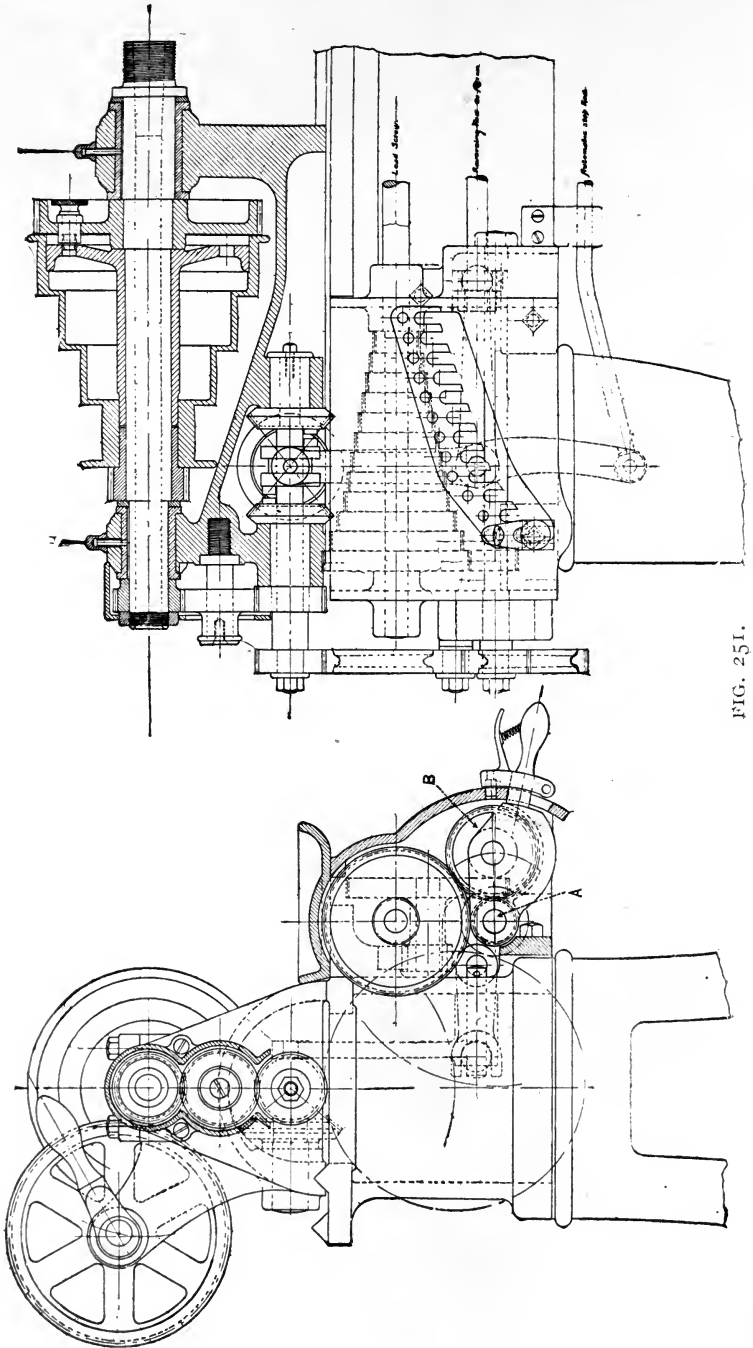

FIG. 251.

centers are also important dimensions. The former is usually from one-half to two-thirds the normal swing of the lathe.

The lathe should be well and accurately built, of ample weight, with operating parts conveniently arranged. Weight is desirable and usually indicates a first-class tool. This is not necessarily true, however, as frequently a badly designed machine will have certain parts excessively heavy with other parts correspondingly light, the whole often making an unusually heavy machine—not so good as the lighter machine in which good judgment on the part of the designer has led to proper proportions for all the parts.

Lathe builders carefully test the accuracy of their lathes before sending them out. As it is frequently desirable for the mechanic to test his lathe as to accuracy of alignment, or in making repairs on lathes that have become inaccurate through wear, the following methods, commonly employed for this purpose, may be of value.

To determine if the center bearing in the live spindle is axially true with its spindle: Turn up, on accurately ground centers, the test bar shown in Fig. 252. The shank S should fit the center bearing nicely and the collars A and B should be exactly of the same diameter. Place the test bar in the live center bearing, leaving it unsupported at the outer end, and cause the spindle to rotate. If the outer end of the bar runs perfectly true, then the bearing must be concentric with the spindle. By using the test indicator Fig. 105, the exact amount of the untruth, if any, may be determined.

To test the parallelism of the live spindle and the shears: If the center bearing has been found exactly concentric, place the test bar in the bearing as before. Put a fine pointed tool or scriber in the tool post and so adjust that it will just touch the top of the collar A. Now move the carriage until the pointer is over the collar B. If it touches it with the same degree of contact as on A, the spindle must be horizontally parallel with the shears and line of motion of the carriage. In like manner test the front side of the collars A and B with the scriber, and if as before the degree of contact is the same on both, the spindle must be vertically parallel with the shears.

To test the carriage cross shears at right-angles to the spindle: Take a very light cut over the large face plate and test with a standard straight edge. If perfectly plane, the alignment is cor-

rect. If the face plate is perfectly true and it is not desirable to take a cut over it, a smooth ended tool held in the tool post can be brought up to the face of the plate, near the center, just close enough to pinch a piece of paper lightly. Now move the rest out to the outer edge of the plate without allowing the tool or carriage to shift along the bed, and if the paper is still pinched to the same degree the alignment must be correct.

Assuming the face plate as true both on its face and circumference, to test the alignment of the tail spindle: Make a stub A to fit the tail spindle bearing as shown in Fig. 253. Bring the

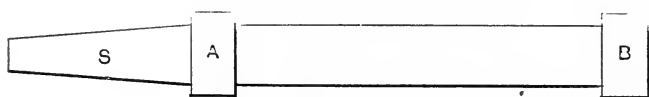

FIG. 252.

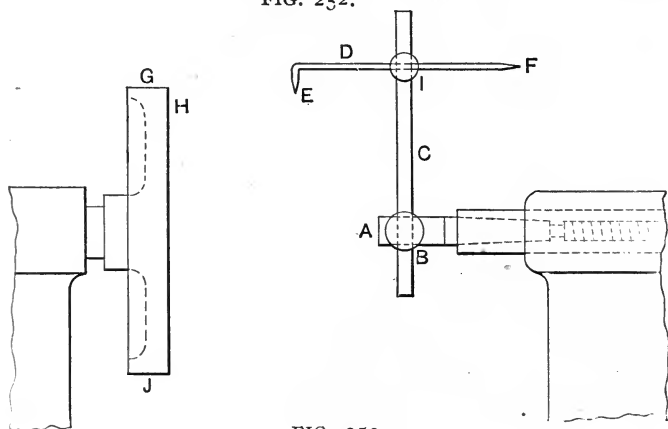

FIG. 253.

spindle back until the tail screw starts to expel the stub center A, and so adjust the screw that when A bears against its point a smooth turning fit between A and the spindle bearing results. C is an arm passing through A and secured by the thumb screw B. D is a pointer which passes through the arm C and is held by the thumb screw I. Adjust the point E so it touches the upper surface of the circumference of the face plate at G. Next swing the arm around until point E comes on the bottom of the plate at J. If E touches at J with same degree of pressure as at G, then the tail spindle must be at the same height as the live spindle, and in like manner if it bears equally on the two sides of the plate the cross adjustment must be right.

In order to determine whether the center line of the tail spindle is coincident with that of the live spindle we can reverse the point of D and bring F into contact with the face of the plate at H. If it maintains uniform pressure of contact while the arm C is revolved entirely around, then the dead spindle is central and parallel with the live spindle.

If the tail spindle has been set over for turning taper and it is desired to bring it back central, first set it as near to the correct position shown by the lines as possible, then place a long bar between centers, similar to the one shown in Fig. 252, and take a very light cut over the collars A and B without changing the transverse position of the tool. Caliper the diameters of A and B accurately. If they are not alike, make another set-over adjustment of the tail stock and repeat, continuing to do so until they caliper exactly alike. Two trials will usually be found sufficient.

To test the truth of the live center, place a bar between centers and turn a small portion up as close to the live spindle as the dog or driver will permit; then reverse ends with the bar and test the turned spot for truth of rotation. If perfectly true the live center is running true. The centers in the test bars should always be carefully reamed and lapped or worn down to true surfaces.

It is difficult to keep the lathe centers in good condition and accurate work demands that they be so kept. The dead center must be true and hard in order to wear well. The live center need not be so hard, inasmuch as there is no wear between it and the bearing in the work. The live center should be ground in position by means of a center grinder. After being ground the live center should be removed from its bearings in the spindle only when absolutely necessary, as it is practically impossible to put it back and have it perfectly true. A small prick punch mark on the nose of the spindle and a corresponding one on the center will enable the operator to put the center back as nearly as possible in its correct position. It is advisable, where nice work is to be done, to always grind the live center after it has been removed. The center should always be ground to an angle of exactly 60 degrees.

CHAPTER XIV.

THE LATHE IN MODIFIED FORMS.

In Fig. 254 is shown the Pratt & Whitney 10-inch tool-maker's lathe; a tool specially designed and equipped for tool-room work. The greatest refinements in lathe manufacture enter into the construction of this tool. The equipment that usually accompanies this lathe is very complete, consisting of a set of drawback collets

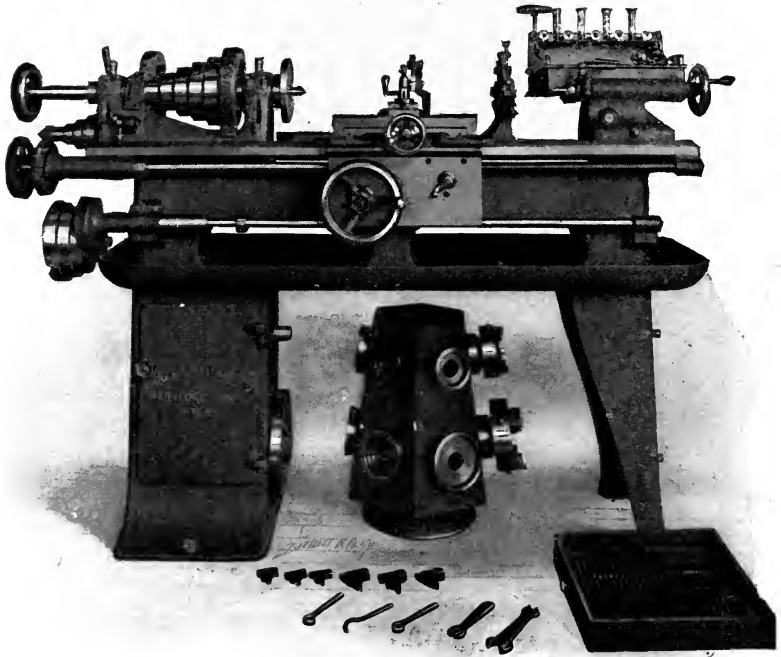

FIG. 254.

from $\frac{1}{8}$ to $\frac{5}{8}$ inch, step and combination chucks, and a complete set of turning, threading and knurling tools.

In many shops, and especially those doing a line of jobbing work, it frequently becomes necessary to turn a piece of work too large for the largest lathe in the shop. The time-honored practice in cases of this kind is to use a set of raising blocks under

head and tail stocks of the largest swing lathe in the shop. These blocks are planed together and to fit the shears, thus giving the same elevation to both stocks and proper alignment.

The McCabe two-spindle lathe is a tool designed to meet these conditions. A front view of this machine is shown in Fig. 255 and a rear view in Fig. 256. The general construction of the

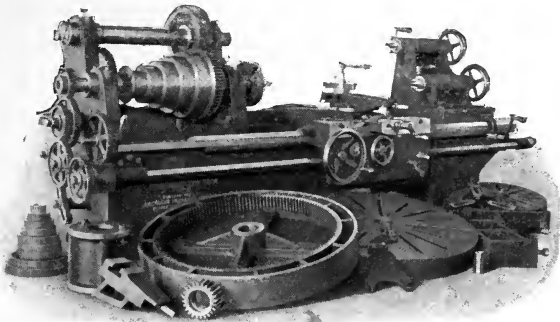

FIG. 255.

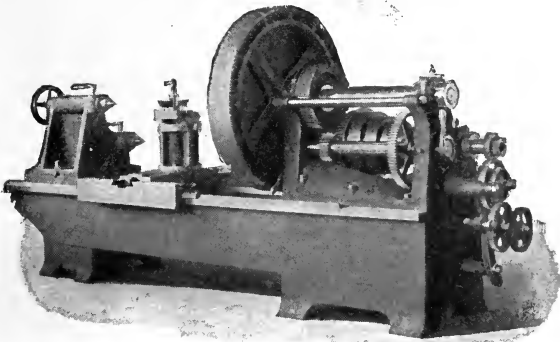

FIG. 256.

tool is quite clearly shown in the cuts. The lower spindles constitute a standard 26-inch engine lathe suitable for all work that would ordinarily be performed on such a lathe. By placing the pinion shown in Fig. 255 on the nose of the lower spindle and the large internal geared face plate on the upper spindle a 48-inch triple-gear lathe is obtained. The elevating tool block shown takes the place of the compound rest when using the upper spindle.

A very wide heavy bed is used, extending well out under both sets of spindles. The upper spindles set back of the lower ones, which with a short extension on the front of the carriage cross shear allows the tool to be set sufficiently back from the center to operate correctly upon the largest work the upper spindle will swing.

Still another form of lathe intended for the occasional turning of work larger than the normal swing will permit is shown in Fig. 257. This is known as a gap lathe. The tool shown swings 16 inches with gap closed and $32\frac{1}{2}$ inches with gap open. The construction is quite clearly shown. An auxiliary bed carrying the carriage and tail stock is accurately fitted to the main bed and

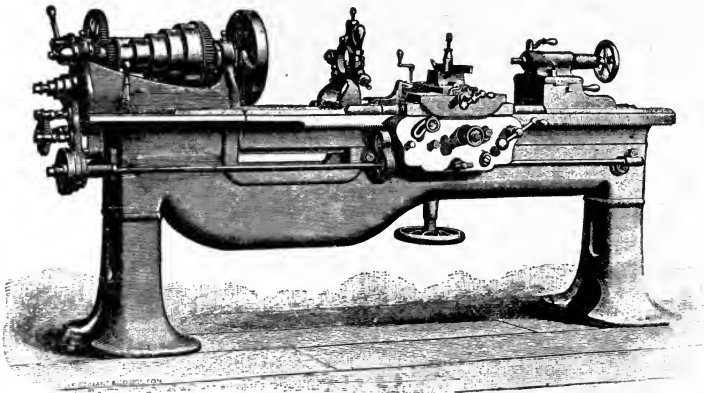

FIG. 257.

may, by means of a rack and pinion and the hand wheel shown, be moved away from the face plate an amount sufficient to allow the large-diameter work to swing through the gap.

The wheel lathe shown in Fig. 258 is a tool specially constructed for the turning of locomotive driving wheels in place on their axle. The two heads are geared together. The work is carried on centers and by means of suitable drivers is driven from each plate. Both wheels are operated upon at the same time by tools held in separate rests. The rests are compound and provided with automatic feed, actuated from overhead rock shaft and ratchets on the feed screws.

A pit lathe is one used for the turning of pulleys and balance wheels of large diameter. It usually consists of a powerfully

geared head, an outboard bearing or support, and a tool rest. The bed is built up of masonry with a pit between the head and outboard bearing in which the wheel operated upon may swing. The tool rest is mounted upon a cross rail which is supported upon

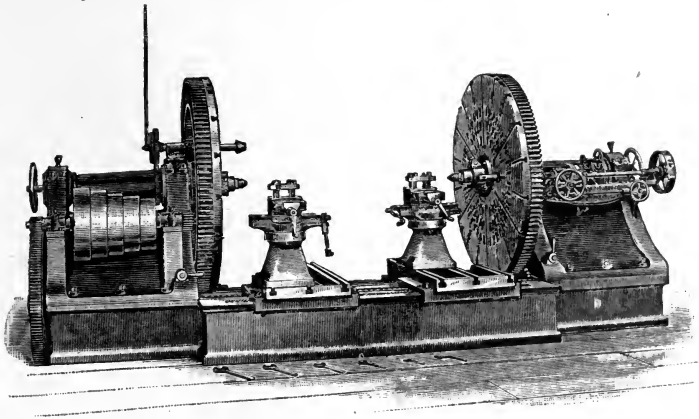

FIG. 258.

plates resting on the pit walls. The tool is provided with a ratchet feed automatically operated.

Pulley lathes, an example of which is shown in Fig. 259, are especially designed for this one class of work. They are usually

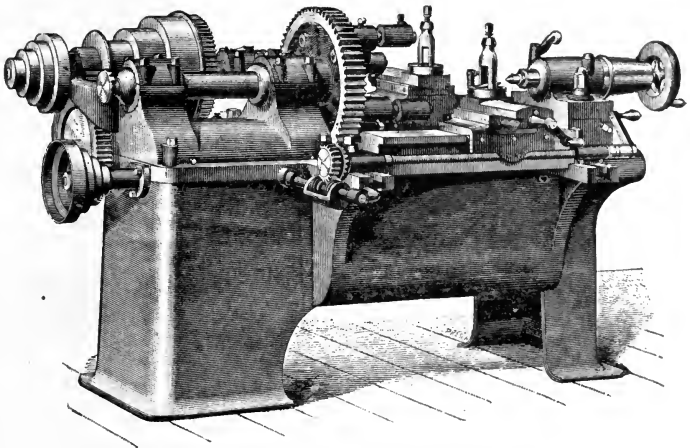

FIG. 259.

provided with two tool rests and a revolving tail spindle for boring the hub at the same time the rim is being turned, the pulley being held in a chuck. It is frequently found advisable, especially on smaller pulleys, to bore the hub in a chucking lathe and turn it in the pulley lathe on a mandrel between cen-

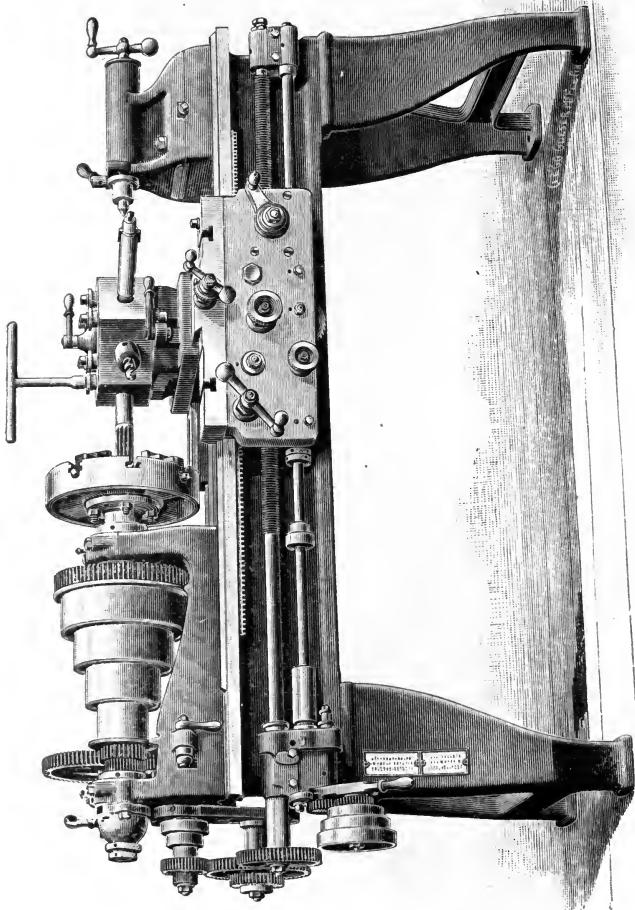

FIG. 260.

ters. Special carriers attached to the face plate should be used for driving; the drive being taken on the arms at a point as near the rim as possible.

When a number of similar pieces, requiring several operations, are to be machined in an engine lathe, much time is

necessarily lost in changing from one cutting tool to another. The application of the turret head to a standard engine lathe as shown in Fig. 260 has done much to reduce the cost of production on work of this class. The turret takes the place of the tool block, and consequently may be given both feeds of the carriage.

When equipped with drills, reamers, boring and facing tools, it may be used to good advantage on a wide range of chucked

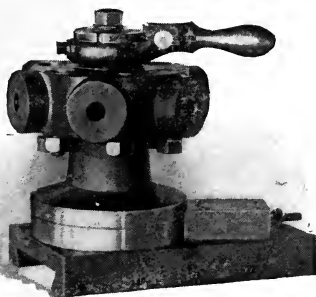

FIG. 261.

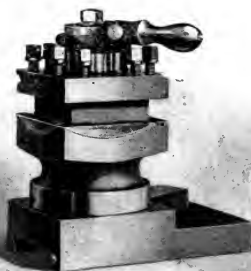

FIG. 262.

work. When equipped with box turning tools, hollow mills, self-opening dies and cut-off slide, it becomes well adapted to rod work on steel and brass. A tapered stop pin locates the turret central with the spindle, and a tempered and ground index ring divides exactly the rotation about the vertical axis.

Other forms of carriage turrets are shown in Figs. 261 and 262. That of Fig. 262 is arranged to carry common lathe tools in order to preserve settings on duplicate work.

In Fig. 263 is shown an engine lathe with an automatic revolving turret on the shears and a friction back gear. The turret is provided with automatic feed actuated by an independent feed rod at the back of the bed. The turret is usually operated by a

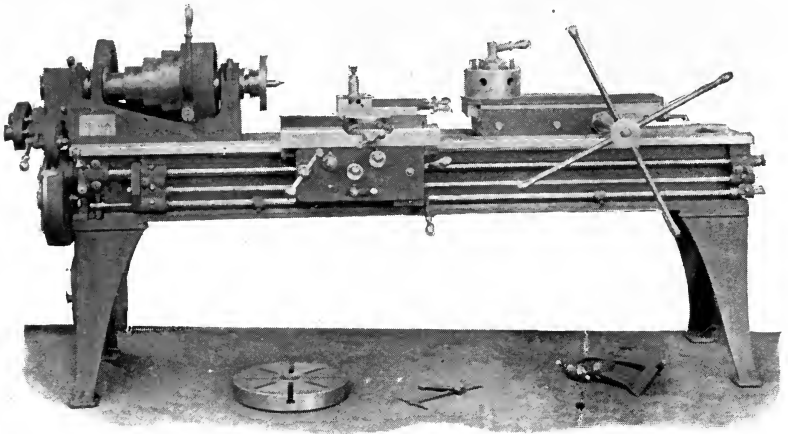

FIG. 263.

turnstile as shown, the mechanism being such that the head is rotated through one division by the last portion of the slide's stroke in carrying it back from the work. This arrangement of

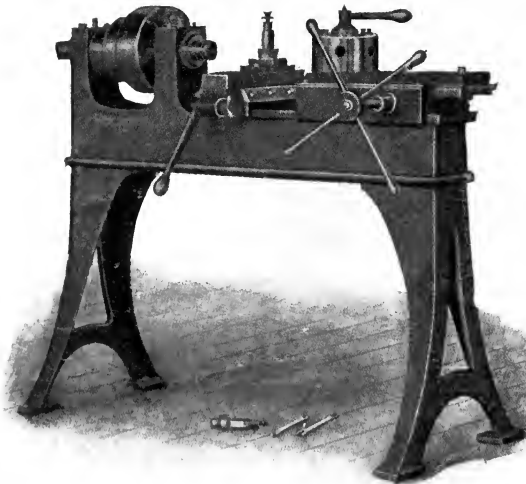

FIG. 264.

turret leaves the carriage free for operations upon the work simultaneously with the tools in the turret.

In Fig. 264 is shown a plain turret machine. The turret is hand rotating and hand feed. The usual hand-operated cross-slide for cut-off and forming tools is provided. This constitutes the turret machine in what is termed its simplest form.

As a large percentage of lathe work is held in the chuck and requires only short tool travel, classes of lathes for this character of work, with short beds fitted with turret heads and known as monitor and chucking lathes, are made. Fig. 265 illustrates a monitor lathe. The turret slide is operated with a lever or screw and provided with a cross adjustment for facing. A

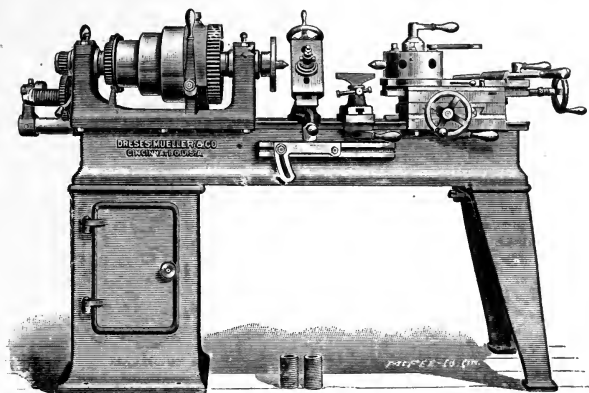

FIG. 265.

suitable stop on the cross shear enables the turret to be readily brought back to a central position. These lathes are made either with or without back gears. The inclined chaser head, which carries an inverted tool used for forming, boring and threading, is carried on a rigid chaser bar mounted on the rear of the bed. The bar slides endwise and also rotates in its bearings, thus allowing the head to be turned back out of the way when not in use. For threading purposes, the end of the chaser bar carries what is known as the "follower," which engages the threaded "leader" shown at the left of the head stock. The leader may be of any desired pitch and need not be long, as the character of the threads cut does not require it. As many of the threads cut in a lathe of this class are pipe threads, some provision must be made for cutting them on a taper. In the ma-

chine shown, the lever rest on the front of the lathe will, when set at an angle with the top of the shears, throw the lever and tool out as it advances over the cut, thus producing a tapered thread. By raising the lever at the end of the cut, the follower is disengaged, and the tool can be quickly returned for another cut,

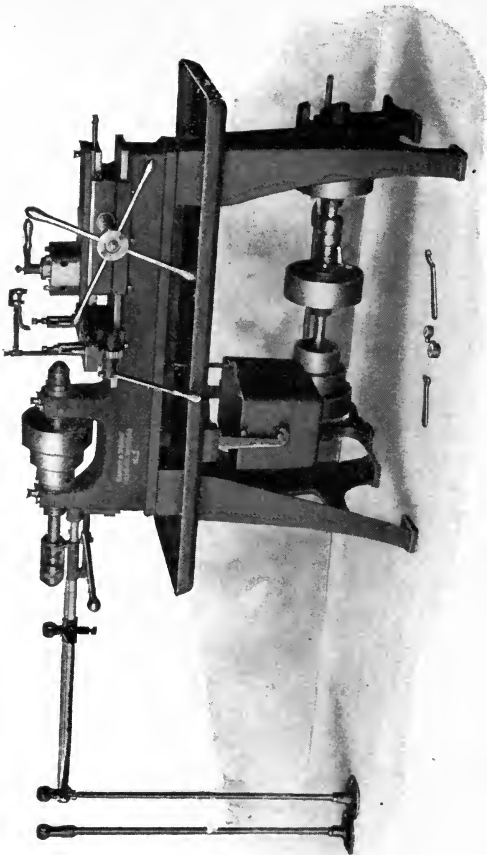

FIG. 266.

being adjusted to its cut in the ordinary manner. These lathes are usually furnished with a simple tool rest for hand turning. The chaser head can be used for cutting-off purposes. A cut-off tool can be held inverted in rear tool post and a chamfering or rounding tool held in the other. A forward motion to the lever brings the cutting-off tool into action. After the work is cut off

the chamfering tool is brought into action by an outward motion of the lever. The monitor lathe is strictly a brass finisher's lathe and very largely used upon all classes of valves and fittings.

In Fig. 266 is shown a plain turret screw machine with wire feed. This is a plain turret lathe intended for operating upon rod stock. It is equipped with wire feed and chuck, which are so constructed that the operator may feed the stock forward the required amount for the operation, grip it in the chuck; and when finished release the stock in the chuck without stopping the machine.

Automatic feed is often applied to the turret slide with a

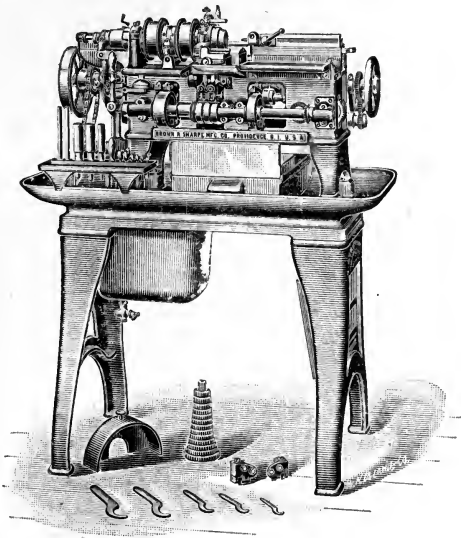

FIG. 267.

stop to knock off the feed at any desired point. The larger machines are usually back geared; the friction-gear head, which permits throwing in the back gear without stopping, being the form quite generally used. An automatic oil pump supplies a flood of oil for lubricating the cutting tools and carrying away the heat.

The automatic screw machine, an example of which is shown in Fig. 267, is a machine designed for the automatic production of machine screws and a large variety of small work that can be cut from the end of bar stock. All movements are entirely

automatic and controlled by quick-moving cams. All dead movements, as the setting up of the stock, the return of the turret slide and the rotation of the turret, are made very quickly by shafts

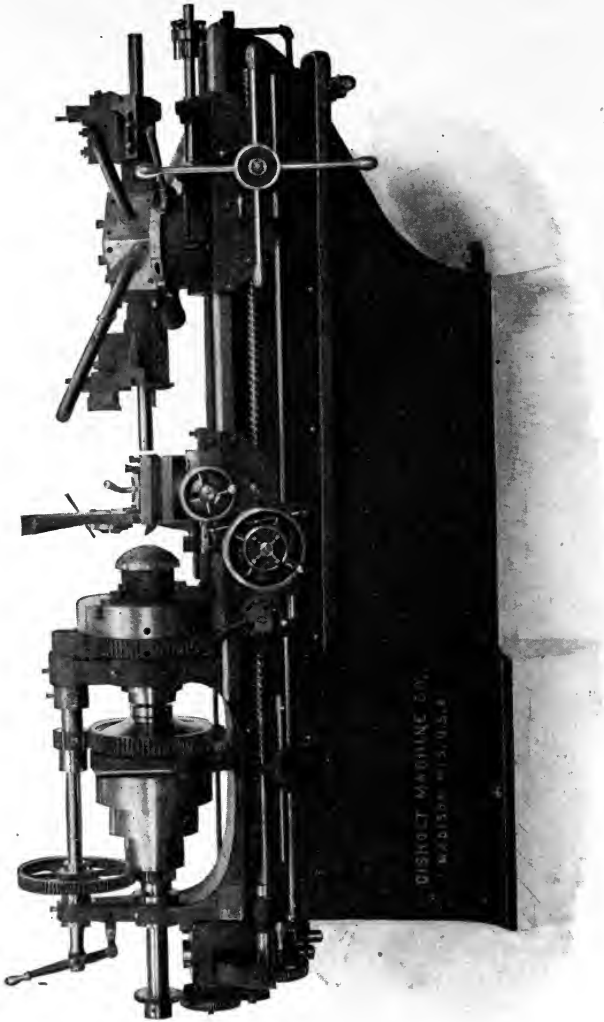

FIG. 268.

running at constant speeds and irrespective of the speeds used for the work movements.

In Fig. 268 is shown a view of the Gisholt turret chucking

lathe. This is a massive tool powerfully geared and capable of producing large quantities of duplicate work. A heavy cross carriage and inclined turret are mounted on the shears. External operations are largely performed by broad-faced tools, held in the cross carriage and the boring and other internal operations by tools mounted in the turret. Bushings in the nose of the spindle are used for steadying the boring bars. All the formed cutters are provided with hardened and ground extension or pilots,^f which fit bushings in the chuck, spindle, or work, thus steadying the tool and adding much to its efficiency. These lathes are regularly equipped with taper attachments and screw-cutting gear.

The double-turret manufacturers' lathe shown in Fig. 269

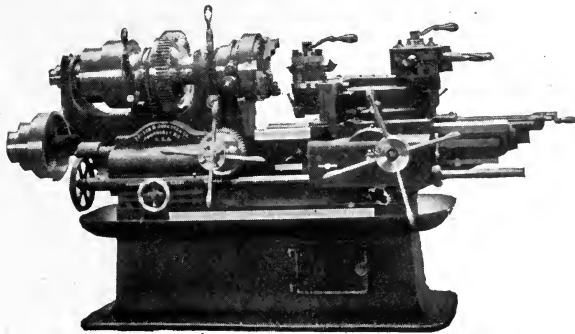

FIG. 269.

is also a tool for operating upon chucked work that is to be produced in duplicate. In this tool two turrets, one a boring and facing turret, the other a turning turret, are mounted upon a revolving plate in such a manner that either may be brought into operation as desired. The machine is equipped with a lever operated scroll chuck, which permits of putting in and removing work without stopping the spindle.

In Fig. 270 is illustrated an automatic chucking machine. This machine is designed to perform automatically the several operations required in the finishing of a great variety of chucked work. The time of the operator is required only for chucking and truing each piece operated upon. It is therefore possible for one man to operate several machines. As with the automatic screw machine, all dead movements are made at very quick speeds.

In Fig. 271 is shown the "flat-turret" lathe, a tool specially adapted to the rapid production of a great variety of work cut from bar stock. The capacity of the machine is 2 inches in

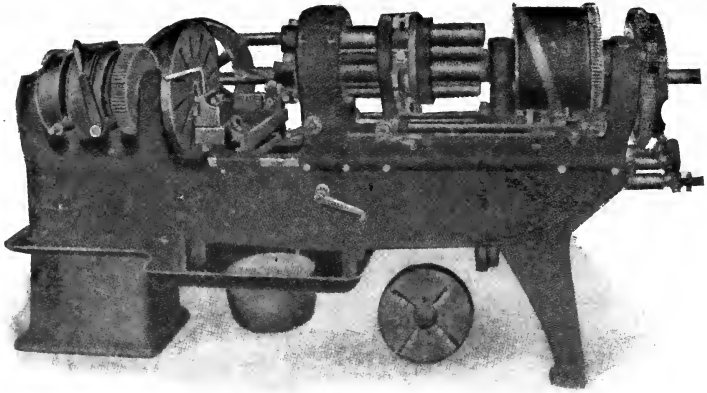

FIG. 270.

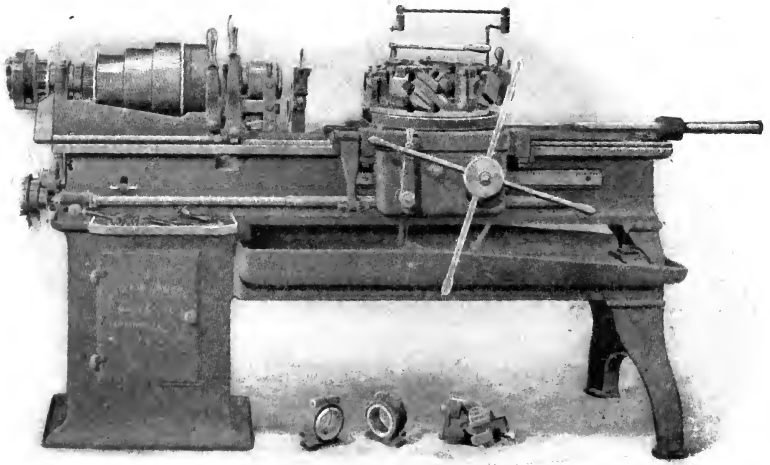

FIG. 271.

diameter by 24 inches long, the arrangement of the tools on the flat turret being such as to allow the work to pass through a distance not exceeding 24 inches.

In Fig. 272 is shown a top view of the turret, showing the tools in place. The bearing of the turret, which is gibbed at its outer edge, is large. The tools do not overhang and are consequently very rigid. The automatic chuck used on this

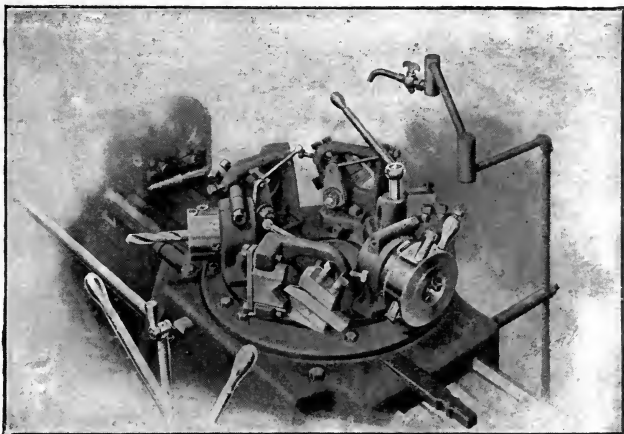

FIG. 272.

machine is shown in section in Fig. 273. It is shown in the closed position. By moving the outside collar to the right the jaws are released, and the work by means of an ingenious roller feed is advanced for the next operation. The chuck jaws may be removed and replaced by others of any desired size or form within the capacity of the chuck.

The "hollow hexagon turret" lathe is shown in Fig. 274. In this lathe the tools are secured to the sides of a hollow hexagon, thus allowing the work to pass through. The maximum capacity of the machine is 2 inches diameter by 24 inches in length. The bed rests upon a three-point support to prevent twisting when standing on an uneven foundation. Many valuable features characteristic of the other tools by its builders enter into the construction of this lathe.

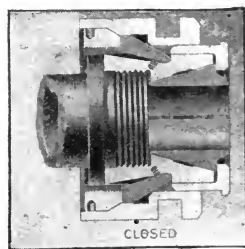

FIG. 273.

The pipe-threading machine and cutting-off machine are

special forms of turning lathes designed for their particular class of work. The accelerated speed cutting-off machines are operated by a variable drive so arranged that as the cutting-off blades approach the center of the bar the speed of rotation increases and thus maintains a nearly constant cutting speed from outside to center of the work.

Lathe countershafts, and in fact all machine tool countershafts, are important adjuncts to the machine which unfortunately do not always receive the proper amount of thought on the part of the designer or care in their construction. Many excellent tools are sent out with inferior countershafts, and as they

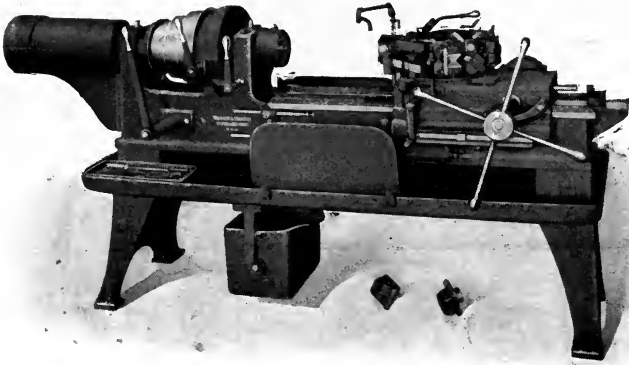

FIG. 274.

are quite apt to be neglected by the user, especially in breaking in, they very soon give trouble. The boxes should be self-oiling and the loose pulleys provided with means for proper lubrication. When tight and loose pulleys are used, it is desirable to have the loose pulley somewhat smaller in diameter than the tight, thus relieving some of the belt tension when on the loose pulley. A smooth, reamed pulley bore and a smooth-finished and carefully fitted shaft will, when properly oiled, give desired results. Clutch pulleys especially for reversing countershafts are much used. They should be simple and admit of proper lubrication and adjustment.

CHAPTER XV.

LATHE TOOLS.

On the subject of cutting tools for the lathe we will consider only the more general points, as practice alone can bring out the details of proper form and setting.

The common lathe tool as shown in Fig. 275 is a short bar of tool steel of rectangular cross section having a cutting edge formed on one end by forging and grinding.

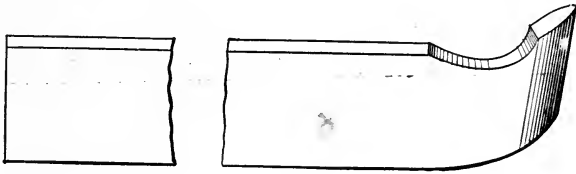

FIG. 275.

must be hardened and tempered in order that they may properly cut the metals upon which they operate. The form of the cutting edge depends upon the kind and hardness of the metal to be cut, the amount of metal to be removed and whether the cut is to be a roughing or a finishing one. These tools when new are made from six to twelve inches long, their length depending

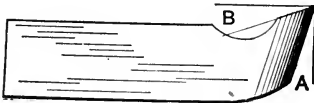

FIG. 276.

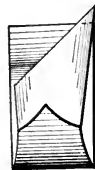

FIG. 277.

upon the size of the lathe in which they are to be used. As the edges wear and are ground away they are redressed, thus gradually using up the stock and finally leaving a short stub, that is, as a lathe tool, of no further value.

The cutting edge of the lathe tool, as shown in Fig. 276, has

what we term an angle of clearance A and an angle of rake B. The angle of clearance has the greatest strength value, as the smaller this angle the greater the support given the cutting edge. For facing, the tool must have some clearance as otherwise the cutting edge is held away from the work. On cylindrical work if set somewhat below the center, it will clear the body of the work but will not properly clear the feed.

The greater the angles of rake and clearance the more acute will be the cutting edge and the finer and smoother the cut. If the edge is too acute, however, it will not stand up to the work properly. The angle of rake has the greatest cutting value, as strength of cutting edge prevents excessive clearance.

A tool may have front rake as in Fig. 278, or side rake as in Fig. 277. It is usual, however, to grind it with both front and side rake as shown in Fig. 278. A tool without rake requires

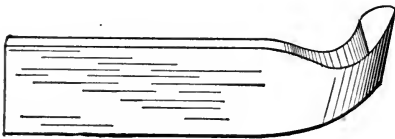

FIG. 278.

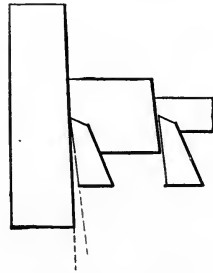

FIG. 279.

greater force to drive it through the cut as it tears rather than cuts the metal. It does not leave a smooth surface and springs the work unduly.

For general practice the angle of clearance should be small, only enough to properly clear the cutting edge, from 5 to 15 degrees usually being sufficient. The angle of rake, on the other hand, should be as great as the character of the tool and hardness of the work will permit. The small clearance angle gives good support to the cutting edge and prevents its dipping into the work. The large angle of rake gives keenness to the cutting edge, making a tool that cuts smoothly and free. For these acute cutting edges the temper cannot be too hard, as in that case the edge chips off. As the hardness of the metal operated upon increases, the angle of rake must be reduced and the hardness of the cutting edge increased.

The above does not apply to the working of brass, as that metal should be worked with a tool having slight clearance and no rake.

For the same rate of feed a tool operating upon work of small diameter must have a greater angle of clearance than is necessary when used on work of large diameter, as the same feed gives a greater pitch angle in the former case. This is clearly shown in Fig. 279.

It is always desirable when a heavy cut is being taken to have that part of the cutting edge presented to the work as short as the strength and durability of the edge will permit. A straight cutting edge, A, Fig. 280, at right angles to the axis of the work presents the shortest possible length of cut, but the delicate point of such a tool will not stand up well. If rounded somewhat as shown at B, we get a cutting length but slightly

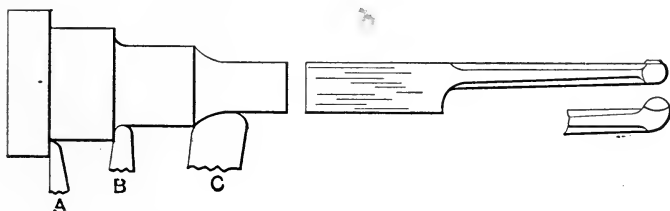

FIG. 280.

FIG. 281.

greater and of a durable form. If the point is too broad, as shown at C, undue resistance is offered owing to the long line of cutting action.

That portion of the cutting edge which lies parallel to the axis of the work produces the finish while the portion at right angles to the axis removes the metal. The finishing portion of the cutting edge should be considerably longer than the rate of feed, thus producing a smooth finished surface. If the cut is light and the edge parallel to the axis is long, the tendency for the tool to dip or dig into the work is great and especially so when the angle of clearance is excessive and the cutting edge set high above the center.

In general a tool works best when set for height at or slightly above the center. When above the center any spring in the tool or work causes the tool to dip into the work and leave an untrue surface. Soft spots in the metal or irregular depth of

cut will increase this trouble. As the spring comes from the tool post block and points below the cutting edge, setting the tool down to the center of the work reduces but does not overcome this difficulty. If the tool rest was perfectly rigid, then a tool having its cutting edge dropped to a line even with the bottom of the tool at point of support would, owing to its own deflection, swing out rather than into the work when set at or below the center. In all cases the tool should be held as firmly as possible and well back in the tool post.

In setting a tool for a heavy cut it should when possible be set raking back rather than ahead as in case of its slipping in the tool post it will swing out of the work rather than into it. This, of course, cannot be done when it is necessary to take the cut close up to the dog or driver.

Cutting-off tools work free and smooth when given a small amount of top rake. As with other tools, however, when used on brass they should have no top rake and will frequently be found to work better with a small amount of negative rake.

The boring tool as commonly forged from bar steel is shown in Fig. 281. The diameter and length of the stem depend upon the size and depth of the bore in which the tool is to be used. This tool is necessarily a springy one and should, therefore, be as short and heavy as possible, thus requiring a large assortment of sizes for any range of work.

Tungsten or self-hardening steel has come into quite general use for lathe tools. It is an "air hardening" steel, and after forging must be kept from water. As it is "hot short" it is exceedingly difficult to forge into any other than the most simple forms. Its great value over ordinary tool steel lies in its hardness and temper-holding quality, which makes it possible to use higher cutting speed without injury to the cutting edge due to the heating. It is several times more expensive than the best grades of ordinary tool steel, and for this reason and also on account of the difficulties met with in forging it, numerous forms of holders for its efficient and economical use have been introduced. In all such tools only the cutting portion is of the self-hardening steel, the holder being a drop forging of mild steel. The cutting portion is of such form that it can be kept in proper condition for work by simply grinding it, thus avoiding the expense of forging. In Fig. 282 is shown an Armstrong tool holder of this class with straight body. It is also made right

and left, a left-hand holder being one with the cutting point offset so as to make an angle to the right and a right-hand holder having the cutter pointing to the left. A right-hand holder is shown in Fig. 283.

As several cutting points may be used in one holder, a tool



FIG. 282.

of this character frequently takes the place of a number of forged tools. They possess many points of superiority over the common forged lathe tool and are being extensively used in many of the best shops. For very heavy high-speed turning they are not as good as a heavy tool forged from self-hardening steel,



FIG. 283.

due to the fact that the small quantity of steel used will not conduct away the heat as will the larger body in the forged tool. For this reason it is always advisable to use as large a holder for any job as its nature and the size of the lathe will permit.

An inserted blade cutting-off tool by the same maker is shown in Fig. 284. In tools of this class the blade is securely



FIG. 284.

clamped in the holder and may be extended an amount just sufficient to make the required depth of cut, thus insuring the maximum strength of blade in every case. The blades are carefully ground to thickness, given the necessary clearance and sharpened by grinding from the end and top.

The Hill bent cutting-off tool shown in Fig. 285 is a simple and reliable tool. The blade is firmly held in the holder by the clamp bolts shown. The blades are of self-hardening steel.

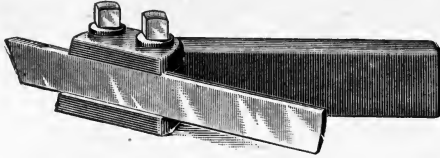

FIG. 285.

A modification of this tool as shown in Figs. 286 and 287 has made a unique and substantial side-cutting tool. These tools are made right and left hand.

They have self-hardening blades and should be ground mostly

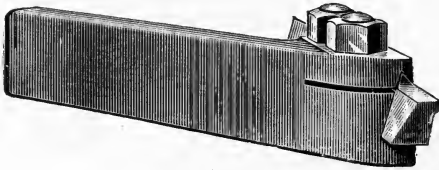

FIG. 286.

from the end, the side and top grinding giving the clearance and rake. They are a very satisfactory substitute for the forged side tool on all classes of work.

The Mingst ring-cutting tool, Fig. 288, is a box holder in

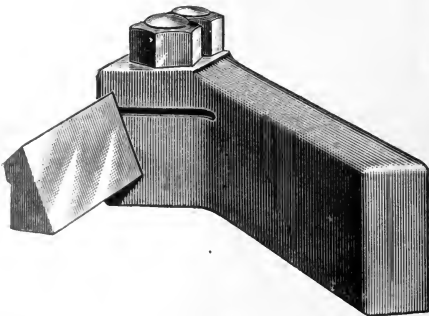

FIG. 287.

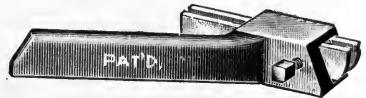

FIG. 288.

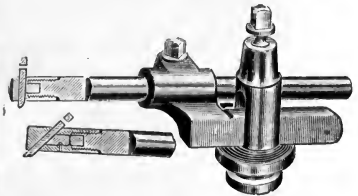

FIG. 289.

which two cutting-off blades may be held. By using distance blocks between them, rings of any width within the capacity of

the tool may be cut to uniform width. The first cutter is usually set slightly in advance of the second and serves more as a guide than a cutting tool. It is frequently desirable to convert the first blade into a side-cutting tool and let it give a truing cut over the edge of the ring and ahead of the cutting-off blade.

The tool shown in Fig. 289 is one of the several patent tools which meet the requirements of a first-class boring tool very

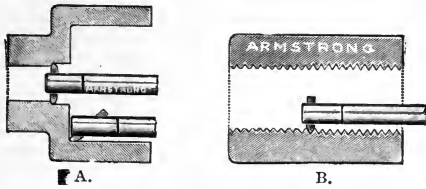

FIG. 290.

nicely. The stem which carries a small cutting point of self-hardening steel can be extended for any required depth of bore within the limits of the tool. It is provided with two cutter-holding tips as shown. At A and B, Fig. 290, are illustrated examples of work this tool is adapted to.

A simple tool of this class is shown in Fig. 291. The bent

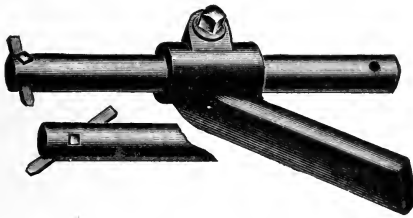

FIG. 291.

shank is frequently a point of convenience, especially when it is necessary to use a small size of holder in a large tool post.

The same rules for angles of rake and clearance apply to the boring tool as for tools on external work.

A threading tool, although a simple tool to forge, is a difficult one to grind and get correct in angle, clearance and lead. The patent threading tools that can be ground without changing their form have as a result come into very general use. The tool shown in Fig. 292 has a bent holder with a cutter, capable

of rotation, attached to it. The cutter is correctly ground in its angle and is sharpened by radial grinding on the top of the cutting surface. The upper portion of the cutter is serrated, allowing the set screw together with the clamp bolt to hold it firmly in position. The form is such that the angular surfaces approach the center as the cutting face is ground back, thus main-



FIG. 292.

taining proper clearance. The plane of the cutter is slightly inclined from that of the holder, to accommodate the tool to the average lead of the pitches cut.

The Pratt & Whitney threading tool, Fig. 293, has a straight cutter correctly ground in the angle and firmly clamped in the holder. One corner of the cutter is provided with threads which engage the threads on the small locking screw shown. This



FIG. 293.

cutter is ground from the top face. The offset cutter shown in the figure is used for cutting close up to a shoulder. This holder is also used for holding chasers and formed cutters of various outlines.

The Rhodes square-threading tool, Fig. 294, is a form of tool holder for the cutting of square threads. Blades for any de-

sired pitch of thread to be cut are clamped as shown. The form of the blade and the angle of the groove in the holder give the proper clearance and average lead for cutting right-hand threads

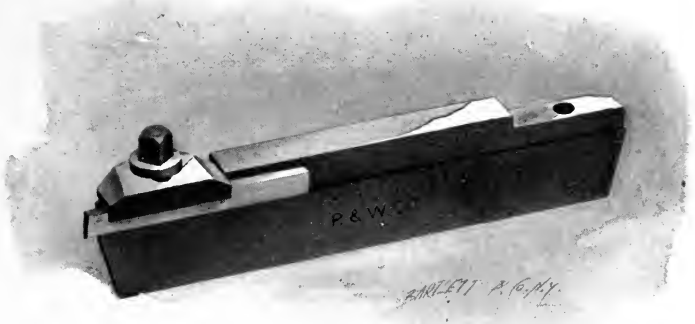

FIG. 294.

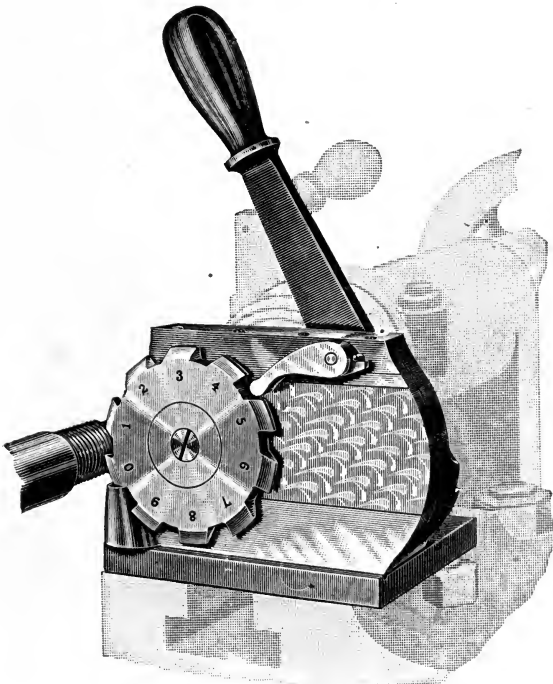

FIG. 295.

when clamped as shown, and for left-hand threads when clamped in the other end of the holder.

The Rivett-Dock thread-cutting tool shown in Fig. 295 is a tool which cuts a thread in an entirely different manner from the regular formed tools. It consists of a round cutter, resembling somewhat a gear cutter, mounted upon a slide and controlled by a lever. There are ten teeth in the cutter, all correctly formed

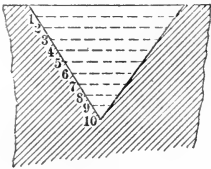

FIG. 296.

in the angle, but each tooth is of a height to cut deeper than the preceding one. In Fig. 296 is shown by the dotted lines the successive cuts made by the teeth from 1 to 10. The cutter is drawn back from the work and the next tooth turned into position for its cut by means of the hand lever. The bottom of the cutting tooth

rests upon a substantial support.

It will be noted that the teeth remove the stock almost entirely by an end cut, the full width of the thread being finished by each tooth. The effect of this method is to prevent tearing up the sides of the thread, as so often happens with the common threading tool, where the cut is entirely on the sides.

The knurling tool, Fig. 297, is a lathe tool in which two



FIG. 297.

knurling mills are mounted upon pivots in a head pivoted in the holder, the object of the latter adjustment being to allow the mills to bear with equal pressure against the work.

Tools for lathes of the turret class are largely made up of standard small tools, as drills, boring bars, taps and reamers for

the inside work with special forming and box tools for the exterior surface work.

In Fig. 298 is shown a forming block and formed cutter. This tool is securely bolted to the carriage block or cut-off rest. The cutter is firmly attached to the block and is of such a form

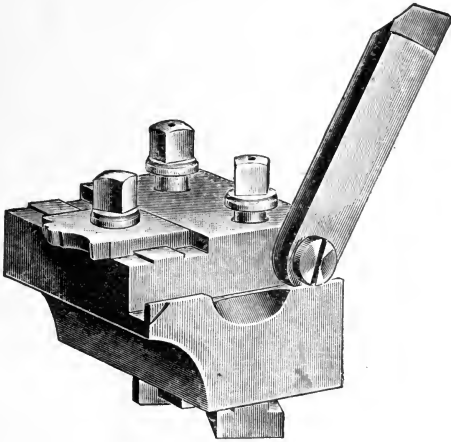

FIG. 298.

as to produce the required irregular outlines. The top of the cutter should be at the height of the lathe spindle. A swinging cut-off tool is usually attached, as shown, for cutting off the stock after it is formed up.

A box milling tool or turner is shown, front and back view, in Fig. 299. These tools are secured to the turret. They consist

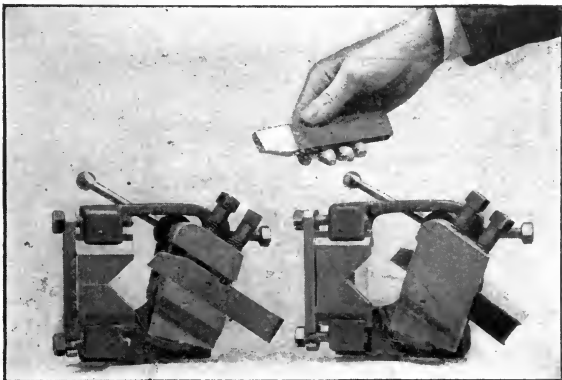

FIG. 299.

of a hardened adjustable back rest and holder in which the cutting tool is secured. The tool and holder may be adjusted for obtaining proper depth of cut. The holder in this tool may, by means of a cam and lever, be thrown back when the tool is removed from the work, thus preventing the cutter from scratching the finished surface.

A pointing box tool is shown in Fig. 300. It is designed for pointing up or crowning the end of bar work.

In Fig. 300 A is shown an adjustable lathe or box mill. This



FIG. 300.

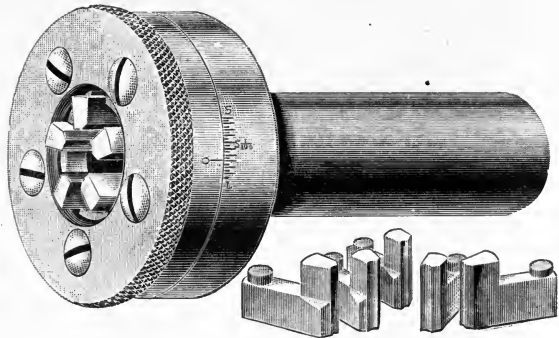

FIG. 300 A.

tool is carried in the turret and works over the end of bar stock. The cutters are mounted in such a manner that they may be adjusted to turn any diameter within the range of the tool. The cutters cut from the end, the inner portion serving to guide and steady the work. In setting to a required diameter the cutters may be set down onto a standard hardened plug gauge of that diameter.

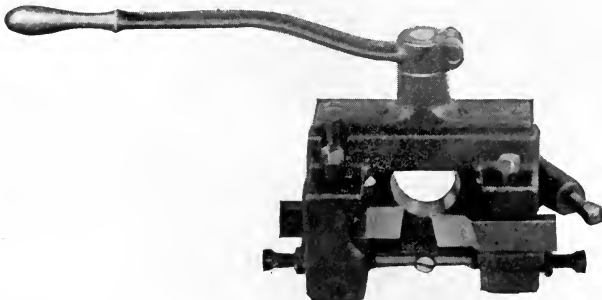

FIG. 301.

The box cut-off slide as used on the turret is illustrated in Fig. 301. It consists of a substantial back in which the tool-carrying frame is gibbed. A pinion pivoted in the back engages a rack on the frame, and by means of the lever on the pinion shaft a steady movement of the cut-off tool may be had. Suitable stops make it possible to cut to an exact depth on any number of pieces.

A mechanic's success as a lathe hand depends very largely upon the skill and judgment he exercises in the grinding and setting of the cutting tools. They must at all times be kept in proper condition. A dull or improperly formed tool will not do satisfactory work and is frequently the cause of serious injury or accident to the work.

CHAPTER XVI.

CHUCKS AND DRIVERS FOR LATHE WORK.

The dog or driver connects the work with the spindle of the lathe, and in its common form is shown in Fig. 302. For all ordinary work this device serves its purpose well; for very accurate work, however, the effect of its leverage must be taken into consideration. As shown at A in the figure, the distance between the dotted lines represents the lever-arm, which acts on the center as a fulcrum, and produces, or tends to produce, a deflection in the work. Again, the force being applied at D, and the

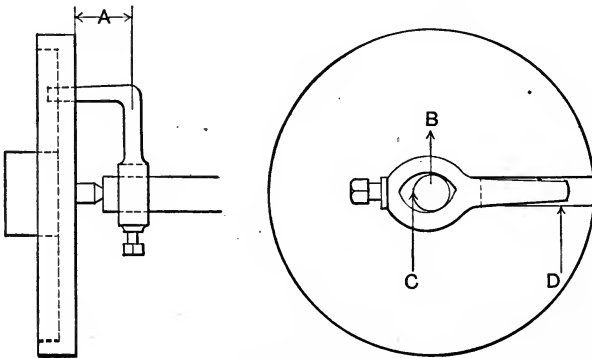

FIG. 302.

pressure of the cut at C, the tendency to bend the work will be greater than when the point D has moved round 180 degrees, or on the same side as the tool. The first of these objections is overcome by using the straight-tail dog, as shown in Fig. 303, with a stud or driver bolted on the face plate, and the second, by using a double-ended dog and driving from opposite sides, as shown in Fig. 304. The use of the double-ended dog is usually not altogether satisfactory, as it is very difficult to so adjust the drivers that the pressure against each will be uniform. Double-ended dogs are frequently made adjustable. The usual way, however, is to adjust the driver pins rather than the dog.

As the dogs above shown depend on a screw to hold them securely on the work, care must be exercised or the work is very

apt to be injured. The screw should always have a hardened flat or oval point. While such a point does not hold as firmly as the cupped point, it does not cut into the work as badly. When used on finished work a ferrule of sheet brass, or preferably, copper should be put on the work under the dog to prevent any

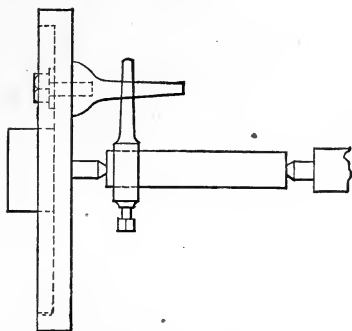

FIG. 303.

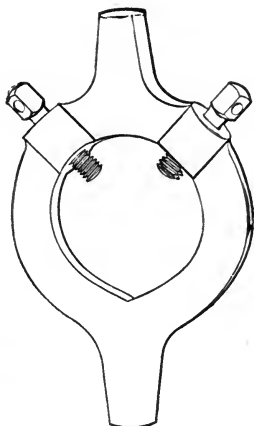

FIG. 304.

injury to the work surface. The screw should be tightened enough to safely drive without slipping. If the dog slips it is quite certain to injure the surface.

For many cases, and more especially on finished work, the die

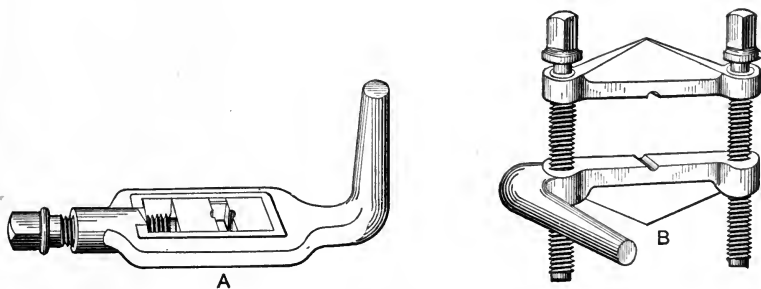

FIG. 305.

and clamp dogs, shown at A and B respectively, Fig. 305, are excellent. These dogs are very nicely made of forged steel and hardened.

In Fig. 306 is shown a form of clamp dog very well adapted to the holding of tapered work.

In Fig. 307 is shown a bolt dog. This tool is clamped to the face-plate so as to receive the head of the bolt. It will drive

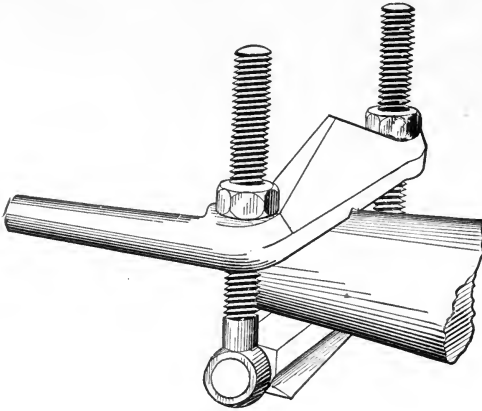

FIG. 306.

square or hexagon head bolts, and, where a number are to be operated upon, will save the time that would be required to put on and take off the common dog.

When a dog must be used on the threaded end of a bolt or

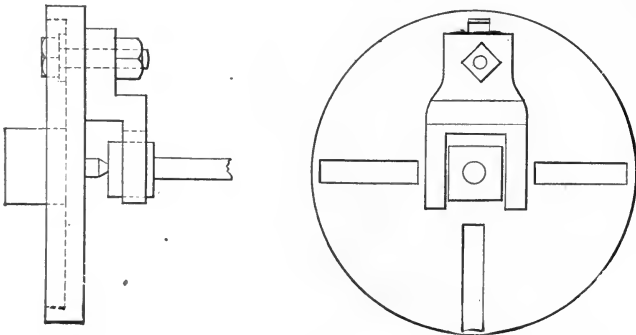

FIG. 307.

spindle it is necessary to protect the thread, or it will be injured by the dog screw. If the work to be driven does not require the screw to be tightened very hard, a heavy piece of brass over the thread will usually be found satisfactory. A common practice

in cases of this kind is to jamb two nuts on the thread and place the dog on the outer nut. In Fig. 308 is shown a very satisfactory form of dog for use in such cases. It should be made of forged steel, tapped the required thread, and split as shown. The clamp screw locks it securely on the thread.

A hexagon nut tapped and split through on one side may be locked on threaded work by clamping under the screw of the common lathe dog, thus making a safe driver for threaded work.

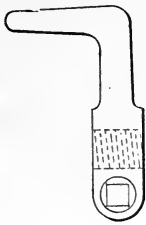

FIG. 308.

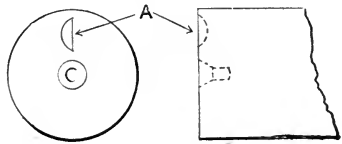
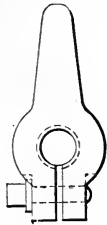

FIG. 309.

Very light work is frequently driven from the center without the use of a dog, thus enabling the work to be machined all over without changing ends. When an exact center is not required in the finished work the square center may be used to drive it. Instead of making a round center bearing on the live center end of the work, a pyramidal or square center is formed with a punch.

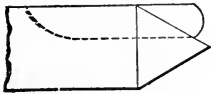

FIG. 310.

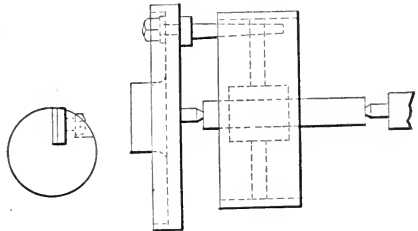

FIG. 311.

This bearing fits over a square live center, which drives the work. A square center is a difficult one to keep in proper shape.

Another method of driving light work from the center consists in milling a thumb-nail notch in the live center end of the work, as shown at A in Fig. 309 and using a live center with a driver, as shown in Fig. 310. In this case true round centers are used.

A great deal of work done between centers does not require a dog, as a face-plate stud or driver will engage some part of the work as shown, for example, in the case of a pulley in Fig. 311. The driver in such cases should be placed as far from the center as possible, thus making it firmer and steadier. The face-plate driver should be a stiff, substantial one. A bolt strung full of nuts and washers will answer after a fashion, but the one shown at A of steel, or at B of cast iron, in Fig. 312, will be found much more satisfactory. Two or three lengths will usually meet all requirements. Lathes are usually provided with two face-plates, one of large diameter and one of small. The small plate is the one usually used for driving the dog on work held between centers. It is generally a round plate with one or four notches. The plate shown in Fig. 313 is sometimes used, but

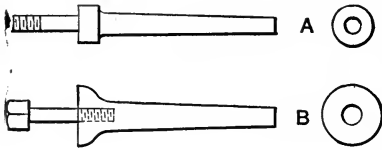

FIG. 312.

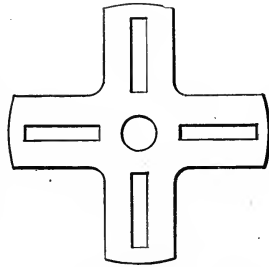

FIG. 313.

for reasons of safety is not as good as the round one. At least one notch in each plate should extend well down to the center, thus enabling the use of the smaller dogs when operating on light work.

Lathe work not held between centers can be classified under the head of center-rest, carriage, face-plate and chuck work, the distinction between the two last classes being narrow. Center-rest work includes all in which the center-rest carries one end of the work and the live spindle the other. Carriage work includes such classes as are operated upon by a rotating cutter while secured to the carriage of the lathe. Chuck and face-plate work covers that wide range of operations upon work rigidly secured on the live spindle.

The lathe chuck is a device for holding work more firmly and adjusting it more accurately than is conveniently possible when clamped or bolted to the face-plate. Chucks are classified as in-

dependent, universal and combination. In Fig. 314 is shown an independent four-jawed lathe chuck. These chucks are made with two, three or four jaws fitted accurately in radial ways in a substantial plate or body. Each jaw is operated independently

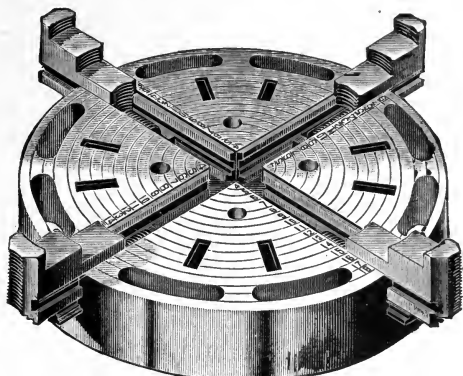

FIG. 314.

by a square-thread screw. The jaws may, in order best to conform to the character of the work, be reversed. The two-jawed chucks of this class are usually employed on special work; the

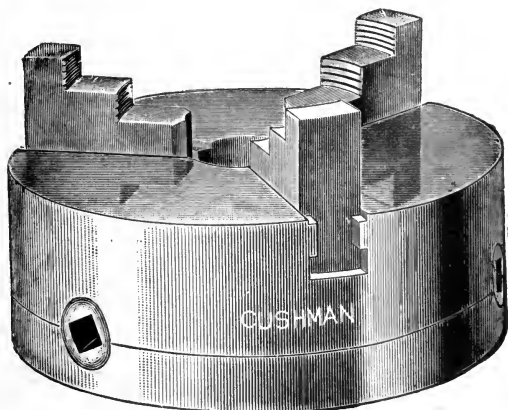

FIG. 315.

jaws being so formed as to receive special formed faces for holding work of plain or irregular outline.

The universal chuck, an example of which is shown in Fig. 315, is usually a three-jawed chuck, although they may be had

with two or four jaws. In this style of chuck the jaws all move together. The mechanism of the three and four-jawed universal chucks usually consists of a geared scroll as shown in front and back views, Figs. 316 and 317. In the two-jawed universal the

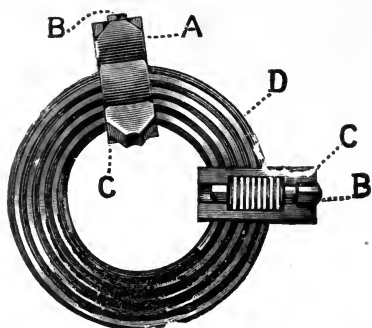

FIG. 316.

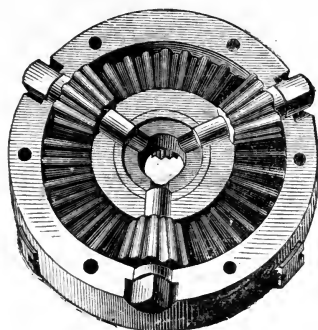

FIG. 317.

jaws are connected by a right and left screw. The universal chuck is used—mostly on milling and grinding machine heads, screw machines, cutting-off machines and other places where it is desired to quickly center round work. When new, first-class

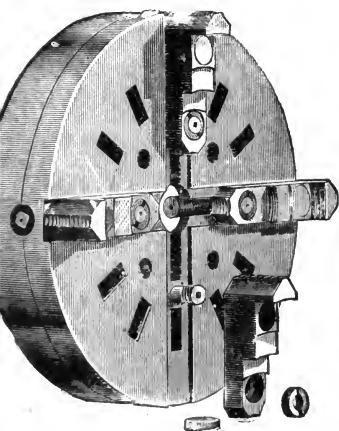

FIG. 318.

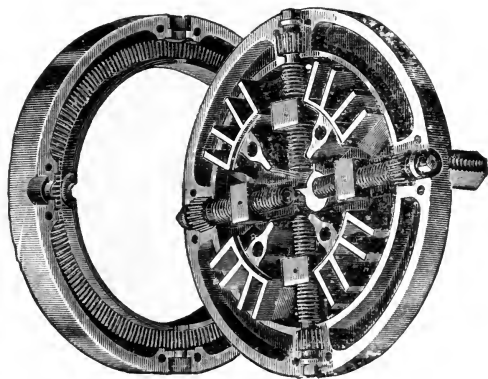

FIG. 319.

universal chucks center work very accurately; but after they become somewhat worn they should not be relied upon for exact centering.

The combination chuck involves both the universal and inde-

pendent characteristics, as by a slight adjustment it may quickly be changed from one to the other. In many places a chuck of this character is very well adapted, but for general, every-day lathe work the independent four-jawed chuck is more suitable. A combination chuck is shown front and sectional views in Figs. 318 and 319.

A combination scroll chuck is shown in section at X, Fig.

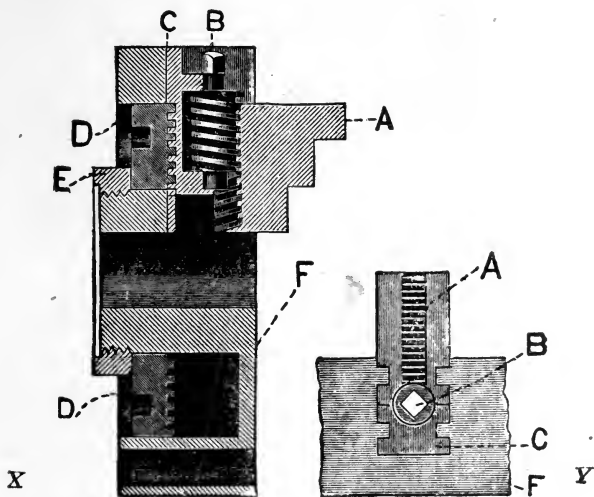

FIG. 320.

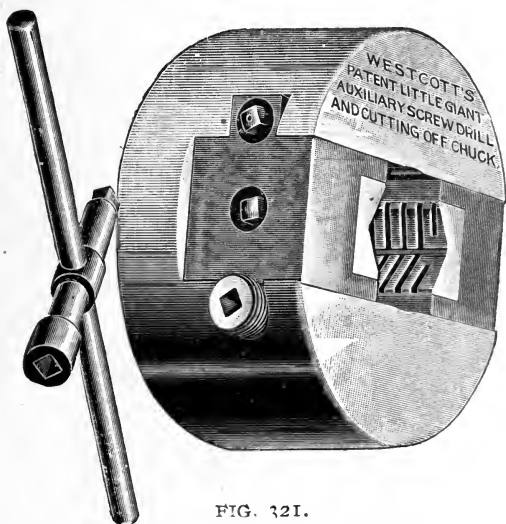

FIG. 321.

320, with an end view of the jaw A and carrier C at Y. In this chuck the scroll is operated by a spanner wrench engaging the holes D D in its back. The carriers C engage the scroll and move together. The screws B move the jaws A independently.

A universal two-jawed chuck for holding firmly bar work is shown in Fig. 321. This is known as an auxiliary screw chuck. The details of the jaws are shown in Fig. 322. They are oper-

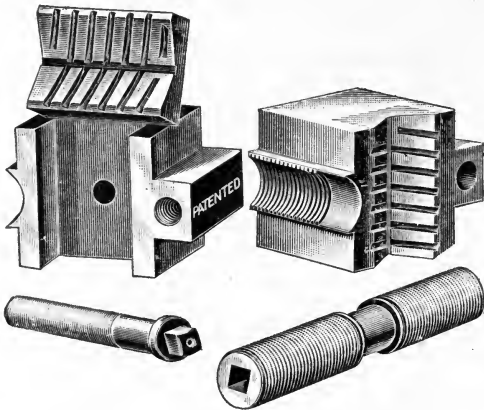

FIG. 322.

ated by the right and left screw, which engages half nuts on the side of the jaws. The auxiliary screw passes through one of the jaws on the opposite side from the main screw and threads into the other jaw. After closing the jaws onto the work with the double screw, tightening the auxiliary screw, which has a fine pitch thread, not only evens up, but increases the pressure of the jaws upon the work.

In Fig. 323 is shown a face-plate jaw. These jaws, which

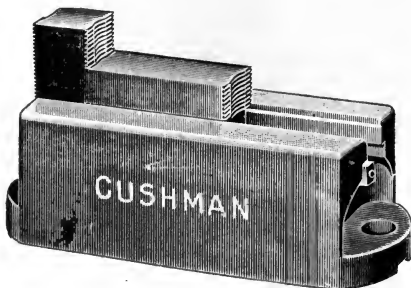

FIG. 323.

are self-contained, may be attached to a face-plate, and as such constitute a first-class independent chuck. They make a very satisfactory substitute for the larger sizes of chucks, and are frequently applied to very large face-plates.

For special work, as the finishing of cocks, valves and fittings,

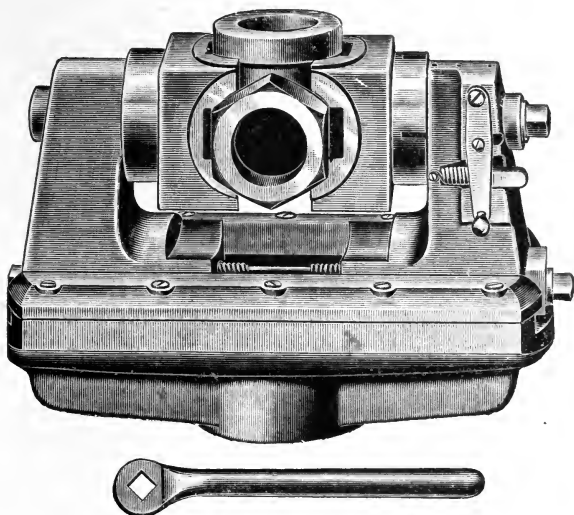
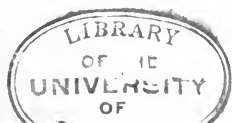

FIG. 324.

a revolving chuck of the character shown in Fig. 324 is used. Special jaws hold the work, and a suitable indexing arrangement provides for exact division and rotation about an axis at right angles to the work spindle.



CHAPTER XVII.

LATHE WORK—BETWEEN CENTERS.

One of the first and simplest jobs the beginner does in the lathe is to turn a plain spindle. He can begin, even on this job, to exercise his judgment. For example, he is given a bar of round steel 2 inches in diameter and is to make a plain, straight and true spindle $1\frac{7}{8}$ inches in diameter by 2 feet long. In cutting this bar he must make the necessary allowance for squaring up the ends. If cut in a cutting-off machine, 1-32 inch will do; if in the power hack saw 1-16 inch should answer if the saw is running reasonably true, while $\frac{1}{8}$ inch or even $\frac{1}{4}$ would usually be required if haggled off in the blacksmith shop. Having cut the bar and made the required allowance in length, he next centers it with punch and hammer.

The proper locating and forming of centers in work to be machined between centers is of importance. When considerable stock is to be removed from the work, and it is therefore not necessary to use great care in locating the center, the careful workman can, if the diameter of the work is not great, usually spot the center sufficiently near by eye.

When the ends of the work are cut reasonably square, the bell center punch can be advantageously used as shown in Fig. 325. The punch should be held squarely over the work as shown at A. If the work is not sawed reasonably square this tool should not be used, as it will not show a true center as illustrated at B. In Fig. 326 is shown a form of bell centering tool in which a conical recess in the base holds the lower end of the work true, while the bell which moves over a vertical guide locates the upper center. This tool is very nicely adapted to the centering of a large variety of small work. The caliper-dividers (hermaphrodite calipers) are perhaps more used for this work than any other tool. The legs are adjusted, as shown in Fig. 327, to approximately the radius of the work, which has previously been chalked on the end to more readily show the marks. Three or four arcs are then scribed from about equi-distant points on the circumference which intersect, as shown at A and B. The

center of the small triangle in A and square in B are the approximate centers.

For work of large diameter the center-head square as shown in Fig. 328 is nicely adapted. A line is scribed along the straight edge a b; the head is then carried about one-fourth around the work and another line c d scribed; the intersection of these lines gives the center.

By placing the work upon a plane surface the center can readily be found by means of the surface gauge, as shown in Fig. 329.

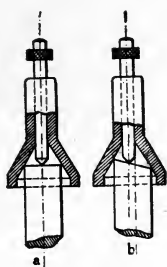

FIG. 325.

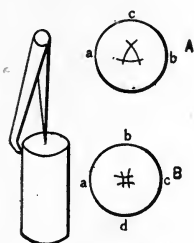

FIG. 327.

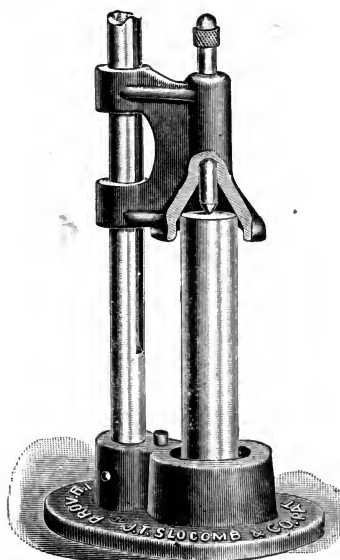

FIG. 326.

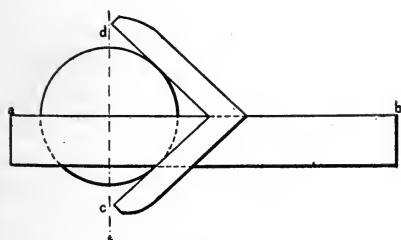

FIG. 328.

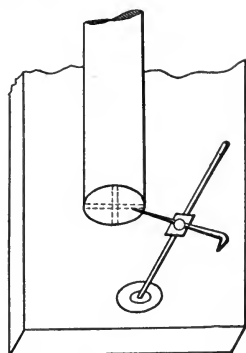

FIG. 329.

Place the pointer at approximately the height of the center and scribe four lines, the work being rotated about 90 degrees for each line. The center of the small inclosed rectangle will be the approximate center of the work. A pair of dividers can be used in place of the surface gauge if desired. Having located and prick-punched the centers, they should next be drilled and reamed. If there is a small amount of stock requiring close centering, the work should be placed between centers and rotated on the light center-punch marks to determine whether they are sufficiently accurate. This is determined by giving the work fast rotation by drawing the hand over it quickly and holding a piece of chalk against it to show the high spots.

If too badly out, the punch mark can be drawn over the required amount before drilling the center. The form of center bearing should be as shown at B, Fig. 330. A hole of from 1-32

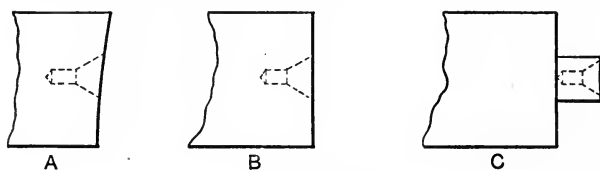

FIG. 330.

to $\frac{1}{4}$ inch in diameter, depending on the diameter of the work, is first drilled and then counterbored with the 60-degree counter reamer shown at A and B in Fig. 171. The hole must be drilled deep enough to prevent the lathe center from reaching the bottom. At C in Fig. 171 is shown a most excellent combination drill and center reamer for this purpose. The drill steadies the reamer and insures a true bearing and drilled hole of proper depth.

The drilled hole not only protects the delicate point of the center, but serves as an oil reservoir to aid in lubricating the center bearing. It should be filled with oil before putting the work on the center.

In large center bearings on very heavy work it is frequently desirable to cut with a small cape chisel one or more narrow grooves through the bearing portion to facilitate the oiling of the center.

Where a large amount of centering is done, a machine for

that work is frequently employed. It is provided with a self-centering chuck for the work, which obviates the necessity of previously center-marking it.

He now squares off the ends with a side cutting tool, and how easily he gets them square to the very center by slacking back slightly on the tail spindle and allowing the tool to cut into the center. He must be particular about getting the bar to exact length in this operation, and when finally to length the ends must look as shown at B in Fig. 330. To leave an end as shown at C is unpardonable, even on the roughest kind of work. When left as shown at B a reliable center can be had at any time should it ever become necessary to place the spindle between centers again.

He should next rough to within about $1/32$ inch of the finished diameter for a length of from three to four inches from the tail center. In doing this the center bearing at that end becomes worn down to a nice, true bearing. The work is now changed end for end and the balance first roughed down and then finished. It should be here noted that no part of the work should receive its final finishing cut until it has all been roughed over. The reasons for this are, first, that the centers should be worn down to true bearings, and second, because of the springing due to removing the fiber strains in the metal. If a part be given the final finish before the balance is roughed down, that part will usually be found out of true after the last roughing. Not only is this the case with the rolled metals, but with the cast as well, where the removal of the skin or scale usually causes the work to change somewhat in form.

The required quality and truth of the finished surface must determine the number of cuts to take. For the roughest work a single cut will frequently do, and for general work two cuts, the first a roughing leaving only enough for a finishing cut. The latter cut should always be a light one. When a very nice, true surface is desired three cuts are advisable; a roughing, a sizing and a finishing cut.

In turning the above bar the young mechanic should learn a lesson in cutting speeds. Mild steel can be machined at from 20 to 100 feet cutting speed per minute, depending on its hardness and the quality of the cutting tool.

The beginner usually runs way below speed, and as he has no experience upon which to base his judgment in speeding the

work, he should make a simple calculation in each case until his eye tells him the proper speed without figuring it.

As the circumference of the work is approximately three times the diameter, he would in the present case have the work moving to the tool about six inches per revolution. At a cutting speed of say 25 feet per minute, the work should make about fifty revolutions per minute. Chalking a spot on the face-plate and counting the revolutions will determine quickly whether or not the speed is correct.

This matter of speed is of very great importance, not only in its effects upon the output of the lathe, but upon the workman himself, as he quickly becomes tuned with his machine and loses that snap and vigor at his work which comes from seeing everything move along at a quick, business-like pace.

The young mechanic should familiarize himself at the beginning with all the details of construction and manipulation of the lathe itself. He will necessarily do work slowly at first, but he must learn accuracy from the beginning. The speed will come as he improves in skill and gains in confidence.

He must learn early the power of the machine, the strength and wearing qualities of the cutting tools and the strength of the materials upon which he operates. He will then not overtax the machine and break or injure the tools and work; neither will he take three cuts over a piece of work when two would have answered quite as well.

If the surface is to be a polished one, he must make some allowance for filing and finishing with emery. This is a matter of judgment, and the beginner's judgment is usually poor, as he leaves altogether too much to remove with the file, which takes up time and injures the truth of the work. It is very difficult to file much on rotating work and keep it cylindrically true. The finishing cut should therefore leave the surface smooth, true and within one to five thousandths of an inch of finished size, depending on the degree of accuracy required.

When the spindle is very long and its diameter relatively small, it becomes necessary to support it at some intermediate point or to provide some form of support immediately back of the cutting tool, as otherwise it would, owing to its own weight and the pressure against the cut, spring excessively, causing it to chatter and leave an untrue surface. In such a case, the cut would have to be very light to prevent the work from bending

or climbing up on the point of the tool, which is a very exasperating accident that frequently happens even when the greatest care is exercised, and it usually results in spoiling the work.

The center or steady rest in its general form is shown at A in Fig. 331. Its construction is plainly seen from the figure. The foot is clamped to the shears of the lathe at any convenient point, and the three sliding jaws are so secured that they can be adjusted upon a portion of the work's length that has previously been turned true and smooth. If the bar is to be turned over its entire length, this spot is usually taken just off the middle point

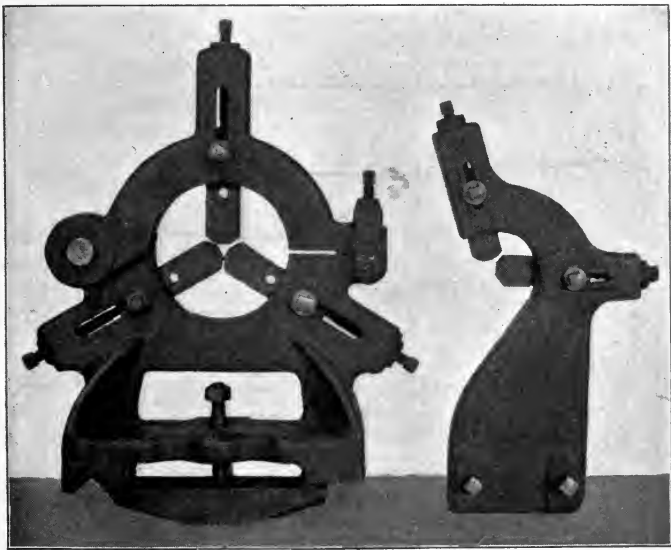

A.

FIG. 331.

B.

and a little closer to the live center than the dead one. This enables the operator to turn from the dead center toward and somewhat past the middle. The work can then be reversed, the jaws adjusted to the turned portion and the balance of the spindle machined. Truing the spot is usually slow, as light cuts must be taken in order to get a round section that is concentric with the axis of rotation. It is also difficult to properly set the jaws of the center rest upon the spot without throwing the work center out of the line between the centers of the lathe. It is usually best to adjust the two bottom jaws first and thus

relieve the work of the deflection due to its own weight. The jaws, if set too tight upon the work, will heat and score it. Oil should always be used and the ends of the jaws kept in good condition. If the work is to be machined only at points on its length, then the center rest should be set as near as possible to the point where the work is being done, and thus give the greatest amount of rigidity.

Frequently it becomes necessary to steady a bar for turning that is not and cannot be made round at the point where the center rest is to be applied. In such cases the device shown in Fig. 332, and commonly known as a cat head, may be used. It is

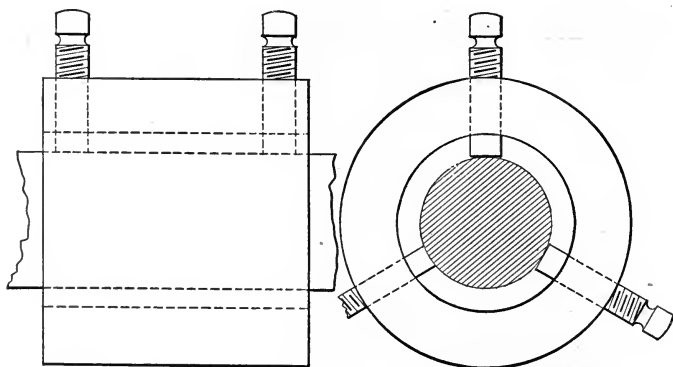

FIG. 332.

simply a collar turned round on its outer surface and provided with suitable set screws for centering it upon the work. This gives a round bearing which, as before, is made to run within the jaws of the center rest. The cat head must be so adjusted that it runs perfectly true on the outside or otherwise the work will not run true when the head is removed after turning. The effect of crowding the work, with one of the jaws out of its true axis of rotation, is to turn the work tapering. Thus, if the work is crowded by the center rest toward the tool, it will be turned smaller in the center than at the ends and in like manner larger at the center if crowded away from the tool. Vertical motion does not affect the diameter to so great an extent, since, if the tool is set at the height of the center, the work can be raised or depressed quite a distance without making much change in the

diameter. If, however, the tool sets above or below the center, a material taper will be given to the work. For example, if the tool sets above the center and the work is depressed at the center rest, it will be turned larger in diameter at the rest than at the dead center. Very often it is desirable to support the work right at the tool for the entire length of the cut. This is accomplished by using the follow rest, an example of which is shown at B in Fig. 331. It is quite similar in its most general form to the center rest, having two jaws, one behind and the other on top of the work. It is secured direct to the carriage and consequently moves with the tool. If the work is in the rough, the rest follows after the tool, but if it has been previously trued, the rest may be set ahead of the tool. It is, however, usually preferable to have the rest follow rather than lead the cutting-tool. For work of small diameter a single jaw with a V-end serves well.

The producing of satisfactory results in the use of the follow rest requires good judgment on the part of the operator. It should be set as soon as possible after the cut has left the dead center and while the work is rigid and true. Any irregularities in the work surface over which the follow rest passes serve to reproduce these same irregularities throughout the length of the work, and it is, therefore, very important to start exactly right. In the cutting of threads on long light rods the follow rest is indispensable. It is also of value in steadying work that is being operated upon by a cutting-off tool. It is superior to the center rest for this purpose, inasmuch as it can be set so much closer to the point where the cut is being taken.

An example of center rest work is shown in Fig. 333. Here, as is frequently the case, it is required to operate on the end of the work which precludes the possibility of running that end on the center. The center rest carries the outer end, the tail stock is moved back out of the way and the carriage is given ample room to get the tool at the work surface. The work must be firmly secured to the head spindle. When a center bearing can be had in that end of the work, it is best to carry it on the live center. This requires some method for clamping it to the face-plate to prevent it from drawing off the center. When the work has a convenient shoulder near the outer end, the inner faces of the jaws of the center rest may be made to bear against the shoulder and thus prevent the work from drawing away from

the live center. A collar can be clamped on the work to accomplish this result, but this method is not satisfactory except, perhaps, in the case of very light work, as the center rest is not rigid against a side pressure and the cramp of the dog or driver is quite certain to crowd the work off the center. A clamp, as shown in Fig. 334, slipped over the work behind the dog and drawn, by means of bolts, firmly against the face-plate will be found quite satisfactory. It is necessary that the clamp be drawn up squarely, as otherwise the truth of the work, especially if light, will be affected.

In cases where there is no center bearing in the live center end of the work, and one cannot conveniently be arranged for, that end can be carried in a chuck. If the chuck is an inde-

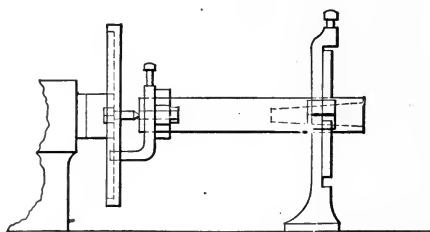

FIG. 333.

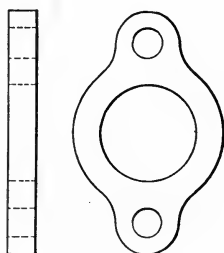

FIG. 334.

pendent one, the work must be very carefully centered in it. If a universal chuck is used and exact centering of the work is required, it is equally necessary to test the truth of the work, as universal chucks, after being somewhat worn, lose their accuracy for exact centering. The work should be caught close to the ends of the jaws, except in cases where the jaws and surface of the work gripped are known to be absolutely true; otherwise the outer end of the work will be thrown out of the center of rotation and, if brought back by the center rest, a spring in the length of the work must result. It is, in any case, difficult to set the center rest so that it will hold the axis of the work exactly coincident with the line of the centers. If not so held, the work will run true, but all cuts will be tapering. If it is much out in this adjustment, it will cause the live center end of the piece being machined to work on the centers or in the chuck jaws, the usual

result being the loss of the grip. The stiffer the work, the more noticeable this action.

The turning of external tapers can be accomplished in several different ways. As above indicated, in center rest work, if the rest holds the end of the work so that its center is back or ahead of the line of centers, tapered work results. In like manner, where the work is carried on both centers, if the dead center is moved across the bed, the center line of the work will be at an angle with the direction of motion of the carriage and tool, and tapered work results. As all engine lathes are provided with a set-over adjustment in the tail-stock, this method of turning tapers is always available. As the amount of side adjustment is limited to a small range, only slight tapers can be produced in this manner, and especially so in cases where the work is long. Thus, if the tail center can be set over one inch and the work is four feet long, then, as shown in Fig. 335, it will be turned two inches

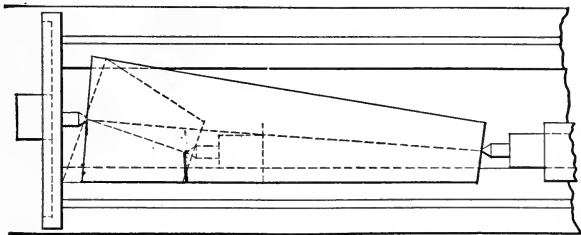

FIG. 335.

smaller at the dead center end than at the live center end, which would give a taper of one-half inch per foot. If the work was one foot long, as shown by the dotted lines, it would have a taper of two inches per foot. The above indicates the method for determining the amount to set the tail center over to produce any taper per foot within the limits of the adjustment. Thus, if the work is eighteen inches long and a taper of five-eighths of an inch per foot is required, at one foot the offset would be one-half the required taper or five-sixteenths of an inch, and at one and one-half feet it would be $1\frac{1}{2} \times 5-16$, or 15.32 of an inch.

This is, of course, only an approximate method for determining the proper amount of set-over, as the exact amount must, in nearly every case, be found by trial. It will, however, serve bet-

ter than a guess for the first trial. The principal objection to this method of taper turning is that the centers of the lathe no longer point toward each other, and the center bearings in the work do not, therefore, bear properly upon them. This frequently causes excessive wear on the bearings and sometimes throws the work out of true. The ends of the work must be faced off perfectly square, or otherwise the work will be sure to run somewhat out when held on offset centers. Since in this class of turning the work does not stand at right angles to the

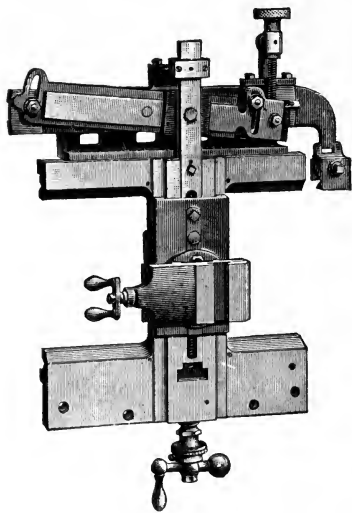

FIG. 336.

face-plate, it is necessary to allow for some in-and-out motion for the arm of the dog or driver through the face plate. When the lathe is provided with taper attachment, as shown in Fig. 336, external tapers may be turned without offsetting the dead center. This leaves the true bearings on the centers and does not necessitate the difficulty of having to adjust the dead center for parallel turning each time after a taper job has been done. Taper attachments are given a much wider range than can be obtained by offsetting the center and are equally as useful in boring tapered

holes as in turning external tapers.

In all taper attachments the mechanism is such as to operate the tool rest direct from a guide set at any required angle, within its limits, with the shears of the lathe and independent of the cross-feed screw, yet at the same time retaining the in-and-out adjustment of the cross-feed screw. As several parts and consequent joints are required in such combinations, a considerable amount of back lash usually exists. The effect of this back lash is to let the tool start on a parallel cut until the back lash is taken up, when it starts off on the required taper. This can usually be overcome by carrying the tool enough beyond the end of the work to allow the slack to take up by the time the tool is brought up to the cut. It will be understood that it is not necessary to let the feed bring the tool up to the cut, as it can

be advanced quickly by hand, the only point being to carry it far enough to take up the slack by the time the tool reaches the work. On work of small diameter, where the tool strikes the side of the center if moved beyond the end of the work, the back lash can generally be taken up by pulling out or pushing sharply in on the tool post, depending on the direction of taper the attachment is set to turn. Thus, if it is set to turn an increasing taper from the dead center toward the live, the angle of the guide will be such that its end nearest the head stock will be the closest to the shears and the inside face of the block will be forcing the tool back from the center of rotation. It would then be necessary, in taking up the back lash at the beginning of the cut, to push the tool toward the center. The maximum range usually given the taper attachment is four inches per foot.

It is seldom necessary to turn or bore steeper tapers than can be bored with the taper attachment. When, however, such are required, a lathe with a compound rest can be used. Examples of the compound rest are shown in Figs. 242 and 243. Its construction is such as to allow the upper slide which carries the tool to be set and secured at any angular position with the cross slide, thus enabling the turning or boring of any taper. Although the range is small, steep tapers are usually short, and it is consequently seldom that the tool must be reset in turning any ordinary taper.

When a lathe is to be kept continually on taper work, a positive taper-turning lathe is superior to one having a taper attachment. In lathes of this character the head and tail stocks are mounted upon an auxiliary bed or platen which is pivoted at the center and clamped at each end of the main bed. The axial alignment of the head and tail spindles is maintained, thus allowing the work to bear squarely upon the centers. A suitable graduation at one end of the bed enables the operator to set the line of centers at any desired angle, within the range of the machine, with the shears and line of travel of the tool. This arrangement not only possesses all the good features of the taper-turning attachment, but eliminates the troubles arising from back lash.

In all taper turning it is necessary to set the point of the cutting tool at the height of the center in order to obtain the taper indicated by any setting. If the tool is set above or below center, the resulting taper will be less and slightly concave.

In turning an external taper to fit a tapered bore the correct taper must be obtained before the work is brought down to exact size. In making the preliminary setting for the first cut too great rather than too small a taper should result, as the measurement will be taken at the small end, and if the taper is too small the work, while large enough at the small end, will be under size at the large end. In getting the exact taper the work should be tried in the bore after each cut. As long as the difference in taper is considerable the sense of feeling may be depended upon to determine which way to vary the taper in order that it may correspond with the taper of the bore. When too close to note the error by that means, draw three lines with chalk lengthwise on the surface and at approximately equal distances apart. Place the work in the bore and turn it carefully through a complete revolution. Upon removing it, if the chalk marks have been

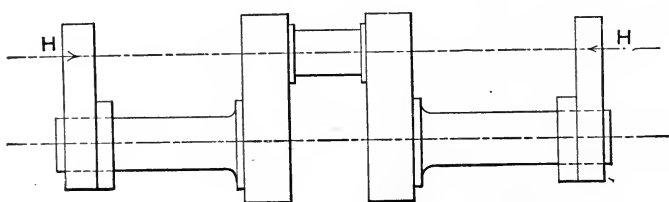

FIG. 337.

rubbed apparently equal their entire length, the taper is correct. If, however, the marks have rubbed at one end and not at the other, a further adjustment must be made and another cut taken. For very accurate work a marking of Prussian blue is used instead of chalk. It is applied with the finger and rubbed down until the coating is very thin. In testing, the work should be turned in the opposite direction to that in which it rotated in machining, as the feed of the tool leaves a thread-like surface which tends to worm the work tight into the tapered bore.

After the correct taper has been obtained, the work can be turned down to exact size, calipering at the small end.

What is commonly known as offset turning between centers is illustrated by the example shown in Fig. 337. In this case it is required to turn the pin of the crank shaft, the shaft proper having been turned or preferably roughed down nearly to size.

The offsets are at a distance from the center of the shaft equal to one-half of the required throw of the crank. By means of a surface gauge and plane table upon which the crank rests, the centers of the shaft, the offset centers and the center of the crank pin are brought into the same plane. By now placing the shaft on the offset centers, the center of the crank pin falls in the center of rotation, and by means of a long tool that will reach the pin through the throat of the crank, it is readily turned.

A sufficient counterweight should be placed on the face-plate opposite the shaft to balance it and thus make the lathe rotation smooth. As it is not possible to use a center rest on work of this kind, and as danger of springing the shaft is great, considerable care must be exercised in turning the pin. In turning the shaft, a center rest can be used. It is usual to place a block firmly in the throat opposite the ends of the shaft to prevent springing the arms together. The finishing cut should be a light one taken with the block removed and the centers very lightly adjusted, thus insuring a true running shaft when completed. Eccentric turning comes under exactly the same head. The center of the eccentric, however, usually comes inside the bore and the offset centers can therefore be placed in the mandrel itself.

When a number of crank pins are to be turned, a face-plate fixture and floating tail center offset, as shown in Fig. 338, proves a very efficient tool. The shafts are all turned to the same diameter, which should be enough over size to allow for a finishing cut after the pins are finished. As the shaft is firmly held in the long jaw, a much heavier cut can be taken over the pin than when held as shown in Fig. 337. The tail offset carries an eccentric or floating center which can be adjusted to the tail center and clamped in position.

In screw cutting between centers the proper change gears are adjusted on the lathe to give the required pitch, as described in Chapter XIII. The cutting tool is firmly clamped in the tool post with its center line at right angles to the axis of the work. The center gauge, shown in Fig. 97, may be advantageously used for setting the tool. The height of the tool should be such that its top face lies in a radial line drawn from the center of the work. If set above or below this position the angle of the thread cut will not correspond with the angle of the tool, nor will the sides of the threads be straight. The nut is next closed onto the

lead screw and the tool set in for the first cut. If the thread to be cut is right-handed, the lead screw is given right-hand rotation with the lathe spindle running forward, thus leading the carriage and tool from the tail spindle toward the head. When the thread is to be left-handed, the direction of rotation of the lead screw is reversed, the tool is set at the face-plate end of the work and the lead is from the live toward the dead center. For each succeeding cut the tool is advanced slightly until the full depth of the thread has been formed. The first cuts should be as heavy as the nature of the work will permit. The last cuts

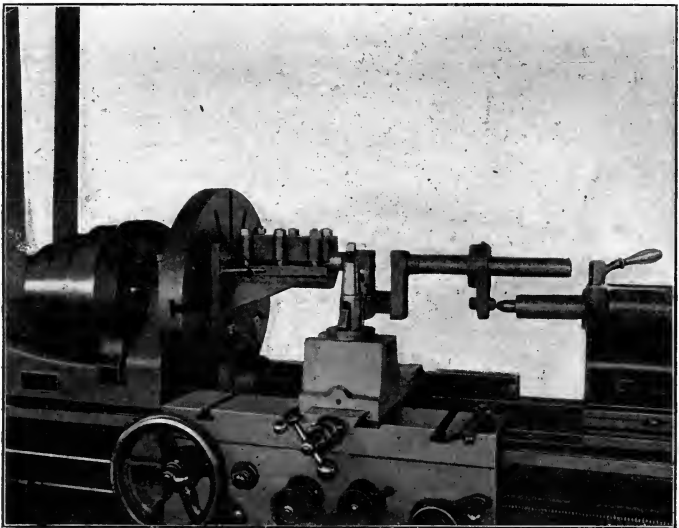

FIG. 338.

should be light, in order that the thread may be finished smooth and true. If the threads are being cut on steel or wrought-iron, a liberal supply of thread-cutting oil should be kept constantly at the cutting edges.

The amount of tool advance for each cut is usually gauged by means of a graduated dial on the lathe cross-feed screw, or a threaded stop screw which can be turned back slightly for each cut, thus allowing the tool to be set in a corresponding amount.

When thoroughly practised in thread-cutting work the operator usually gauges the amount of each cut instinctively by the position of the cross-feed screw crank.

After each cut over the work, it is necessary to draw the tool out from the cut before reversing the work for returning the tool to the point of starting. This is due to the back lash in the long train connecting the tool and spindle. The tool should be carried slightly beyond the point of starting in order that the back lash will be taken up by the time it enters the cut. If it become necessary for any reason to remove the tool from the tool post before the thread is completed, great care must be exercised in resetting it. The lathe should be run forward one or two revolutions, which takes up the back lash and starts the carriage forward, after which the tool can be set to the groove already cut. After the thread is started, the driver should not be removed, and if the work is removed for testing, it is necessary to put it back on centers with the dog or driver engaging the same notch in the face-plate. For this reason it is preferable to use for threading a small single-notch face-plate. If the work is long and springy, the follow rest B, Fig. 331, should be used to support it.

In cutting double threads it becomes necessary after the first thread has been completed to advance the cutting tool an amount equal to one half the pitch, as shown in Fig. 339. This may

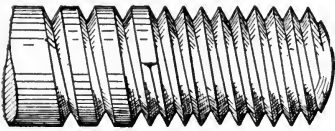

FIG. 339.

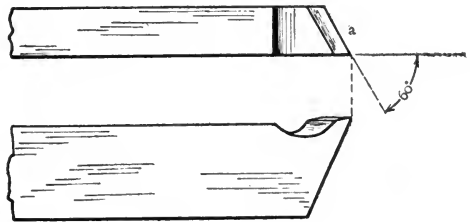

FIG. 340.

readily be accomplished as follows: In lathes where the ratio between stud and spindle is one, mark a tooth on the stud gear and the corresponding tooth-space on the intermediate gear. Drop the intermediate gear out of mesh and turn the spindle until one-half of the number of the teeth in the stud gear have passed the marked space on the intermediate gear. Throw the gears into mesh and proceed with the cutting. It is, of course, necessary that the stud gear have an even number of teeth in the above case. If the ratio between stud and spindle is other than one,

the stud gear must be rotated an amount proportional to that ratio. The better and more convenient method, however, is to have milled notches in the face-plate accurately indexed. Remove the work and place the tail of the dog or driver in the notch diametrically opposite the one in which it was while the first thread was being cut. For triple and quadruple threads the above methods are equally applicable.

As the common thread-cutting tool cannot be given any top rake it is not free cutting. The strain upon it is consequently great, and it at once becomes a hard tool to keep sharp and in proper condition. When the lathe has a compound rest the tool shown in Fig. 340 may be used for cutting V threads. The compound rest is set at 60 degrees with the axis of the work as shown in Fig. 341, and the tool set with the thread gauge in the usual

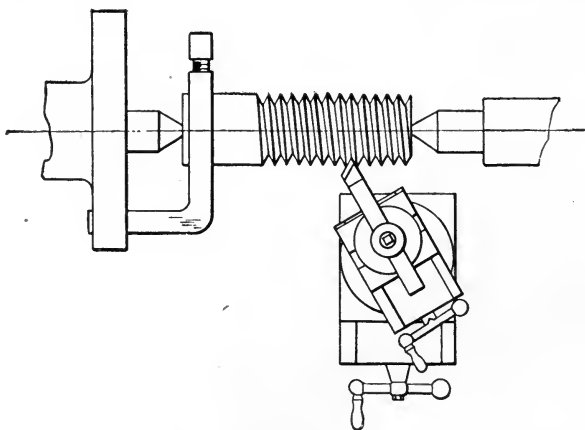

FIG. 341.

manner. The tool is given top rake and cuts a clean chip from the end *a*, it being advanced to the work by the compound slide.

For cutting square threads, the tool used resembles a cutting-off tool with the plane of the blade set at the angle of the pitch of the thread, as shown in the end view, Fig. 342. The amount of this angle varies for all pitches and diameters, but the side clearance is usually sufficient to allow some variation in diameters without changing the center angle.

For all classes of work on center it is very important that the centers be kept true and smooth. They are turned in the head-spindle to the correct angle, tempered and ground. The tail or

dead center is ground first and the live center is then ground in place, and preferably not removed from its bearing after grinding. The live center should be marked close up to the nose of the spindle with a corresponding mark on the spindle, thus making it possible to always put it back in the same position.

Before putting centers into their bearings, both surfaces should be carefully wiped clean and dry.

In Fig. 343 is shown a form of lathe center that can be very easily kept in shape without excessive grinding.

In most threading work on the lathe the nut is not opened from the lead screw after the thread is once started; the lathe after each cut being reversed and the tool run back to the be-

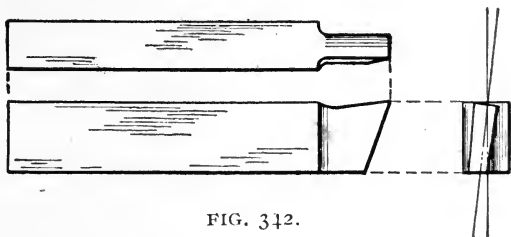

FIG. 342.

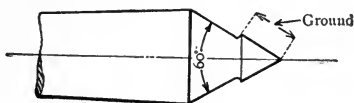

FIG. 343.

ginning of the thread. When the thread is a long one much time is lost by following this method, and the nut should be disengaged and the tool moved quickly back to the beginning of the thread. In all cases where the number of threads per inch being cut is a multiple of the number of threads per inch on the lead screw, they may be cut simply by engaging the nut at any position on the screw; thus, if the lead screw has six threads per inch, 6, 12, 18, 24, 30, etc., threads per inch may be cut by catching the thread at any point, it being impossible to catch the tool in any position other than the right one. The reason for this is evident from the following consideration. Assume the carriage and tool in the correct position and the nut engaged, the lead screw having say six threads per inch; if now we open the nut and move the carriage in either direction, the nut cannot catch until the car-

riage has moved a distance equal to the pitch of the lead screw or a sixth of an inch. For six threads this of course catches the next thread; for twelve threads it misses one and catches the second; for eighteen it misses two and catches the third, etc.

For threads of which the number on the lead screw is a multiple, as 1, 2 and 3 with a six-pitch lead screw, the nut can readily be caught by inspection. Thus, if cutting one thread per inch the nut will catch exactly right on every sixth thread; in cutting two threads it catches on every third thread, and in cutting three on every second thread. Inspection must determine whether it has caught the right thread before setting the tool into the cut. Other threads, as 8 or 10, may be caught by inspection; thus on the six-thread lead screw, moving the nut three threads moves

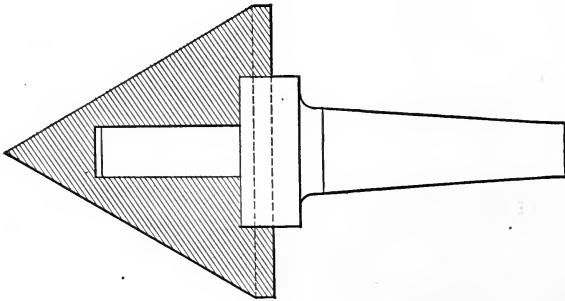

FIG. 344.

the point of the tool $\frac{1}{2}$ inch, which just catches the fourth thread on the eight-thread work, or the fifth thread on the ten-thread work. For any pitch other than those for which the above is applicable set the tool for the cut slightly beyond the end of the work and mark the position of the carriage in any convenient way. A stop clamped to the bed against which the carriage may be brought is very convenient. Next mark the face-plate and note the position of this mark with reference to some fixed point on the lathe. After each cut open the nut, move the carriage to the stop and bring the face-plate to the mark, when the nut can be engaged with the lead screw, all parts being in the same position as when the thread was started.

It is frequently desirable to run a rough or cored hole on the dead center. This would quickly cut the center and ruin it for accurate work until reground. The hole in work of that char-

acter is usually too large to run on the regular center, if such were desirable, and either a large center must be provided to carry it or the hole plugged and a center bearing put in the plug. If the hole is concentric with the surface to be machined the large center is the cheapest and most convenient method. It is, of course, not adapted to the most accurate work, but for ordinary operations serves its purpose well. As it is necessary for the center to revolve with the work, to prevent its being cut, a special device is required. In Fig. 344 is shown such a center, commonly known as a pipe center. The construction is evident; the cone revolves on a stud and backs against a collar having a simple bearing surface to take the thrust. It is also provided with suitable channels for its proper lubrication.

In Fig. 345 is shown an attachment secured to the carriage

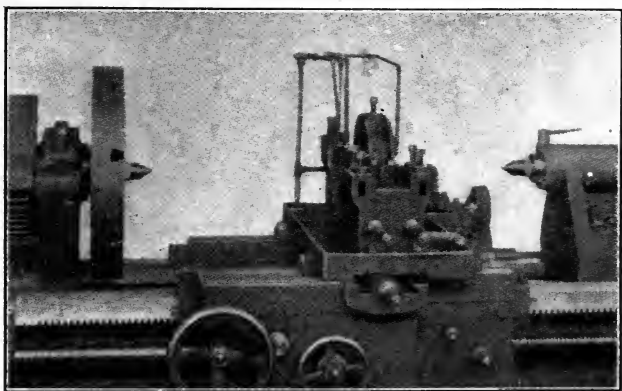

FIG. 345.

of an engine lathe for turning shafting. With this device the shaft is roughed down by two tools set opposite to each other, which serves to balance the pressure of the cut and reduce the spring to a minimum. After the roughing cuts, it passes through a suitable bushing held in the head and receives the final sizing and finishing cut from the tool shown at the back of the attachment. The device is simply a follow rest carrying three tools instead of one.

In Fig. 346 is shown a device used on the lathe for the turning of cross-head pins or other surfaces the nature of which prevents the possibility of complete rotation of the work. In this

device a sleeve carrying two gears is secured on the nose of the lathe spindle. The gear next to the spindle bearing is keyed to the sleeve and rotates with the spindle. The second gear which carries the work driver rotates freely upon the sleeve. The first gear meshes with a larger one that is carried on a bracket secured to the back of the head stock. A wrist pin in the face of the large gear drives the rack which, as shown, gears with and drives the loose gear and thus causes the work to rotate independent of the spindle rotation. By properly proportioning the diameter of the gears and the stroke of the rack, the work can be made to oscillate back and forward through any desired part of the revolution, while the spindle has continuous forward

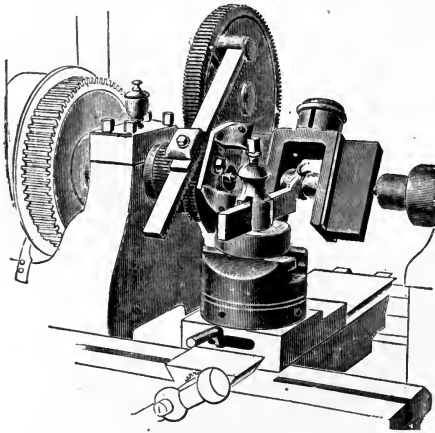

FIG. 346.

rotation. Thus in the turning of the cross-head pin shown, the cross-head moves through rather more than one-half of the full revolution, thus enabling the turning of a little more than one-half of the pin. The cross-head is then changed end for end on the centers and the other half turned. Frequently, with cross-heads to be used in single acting engines, where the pressure and wear are always on one side of the pin, a large flat can be machined on the non-bearing side of the pin and sufficient rotation obtained to completely finish the pin without changing ends with the work. It is, of course, possible to turn a pin of this character without any special attachment, by either pulling the belt backward and forward and driving the work in the ordinary

manner or by allowing it to rotate free of the centers and oscillating it by means of a wrench or lever. These latter methods are slow and require an extra workman.

An ingenious lathe attachment for backing off the teeth of milling cutters is shown in Fig. 347. In a device of this character either the tool or the work must be given a slight in-and-out motion for each tooth on the cutter being relieved. In the case shown, the tool is held in the tool post and advanced to its cut in the ordinary manner. The mandrel A of the attachment has its centers slightly eccentric, the amount of the eccentricity being

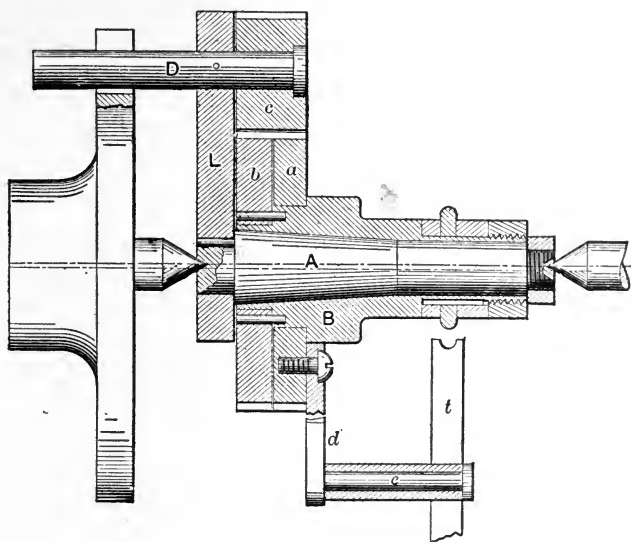

FIG. 347.

enough to produce the desired amount of relief on one tooth of the cutter if mounted directly on the mandrel. The arm L is secured to the mandrel and driven from the face-plate by the carrier D. The sleeve B, which carries the cutter being operated upon, revolves freely upon the mandrel. The gear b is secured to the sleeve and the gear a is loose on the sleeve, and is held from rotating by the arm d which is secured to it and rests upon the top of the tool; c is a pinion carried loose on the stud D and gears with a and b. Gear b has a smaller number of teeth than a, and as a does not rotate, the rotation of the pinion c around a advances b and the sleeve and cutter a certain fixed amount at

each revolution of the mandrel. The geared ratio is such for any given number of teeth in the cutter that the advance per revolution is exactly equal to the circular pitch of the teeth in the cutter. The turning is such as to bring a tooth to the tool when the center of the mandrel is farthest from the tool, thus giving the relief as the tooth advances to the tool. It is evident from the above that the space between the teeth must be at least equal to the length of the tooth. As this division of space and tooth in relieved milling cutters is not usual, it is necessary to allow the cutter blank to stand still while the mandrel is moving through a part of its revolution. This is accomplished by making the circular pitch of the teeth on about one-half the circumference of *b* equal to that of the teeth on *a* and the teeth on the balance of *b* of somewhat greater circular pitch. For that portion where the teeth are the same on *a* and *b*, the pinion simply turns around both and the sleeve remains stationary. During the balance of the revolution, however, the sleeve will advance an amount equal to the circular pitch of the cutter's tooth.

With the regular tools and feeds on the engine lathe, plane, cylindrical and conical surfaces are readily machined. If the surface is spherical or of irregular outline, a forming tool or some special attachment must be used on the lathe to produce the required outline. If the work is of circular section, the forming tool can usually be used to excellent advantage, as illustrated in Fig. 348. In this case the tail-stock cap shown in the figure is first chucked, bored at *A*, faced at *B* and threaded at *D*. It is then placed on a threaded mandrel and driven on the centers. The forming tool *E*, which is secured in the ordinary tool-post, forms the bead and is set in until the proper diameter at *F* is obtained. The tool *G*, held in like manner, forms the hub and rounded end of the cap, the tool being set in until the diameter at *H* is equal to that at *F*. A common tool is then used to produce the cylindrical surface *I*. If the length *I* is short it would be possible to combine the two forming tools into one. As the cutting edge is a long one it is, in any event, desirable to rough off the scale and true up the casting before applying the forming tools. This can be done by operating the regular feeds by hand. If the work does not run true when the forming tool is set to the cut, it will be difficult to produce satisfactory results, as the spring of tool and work will vary at different points in the revolution. The length of cutting edge that can be employed de-

depends in any case upon the stiffness of the work and the rigidity of the lathe in which the work is to be done. Another illustration of this system of forming is shown in Fig. 349. Here the rim of a hand wheel rounded by the forming tool is shown. If the section of the rim is a full circle, as at A, two settings of the tool are required, one of which is illustrated in the figure. It is here even more important than in the example shown in Fig. 348 to first rough the stock until it runs true, as the heavy cut of the forming tool will otherwise spring the work so that it will not run true when finished. For roughing out the rim a side-cutting tool can be used to good advantage, setting it at different angles to produce a section similar to that shown in the figure at B. If the tools are carefully made and kept in good condition,

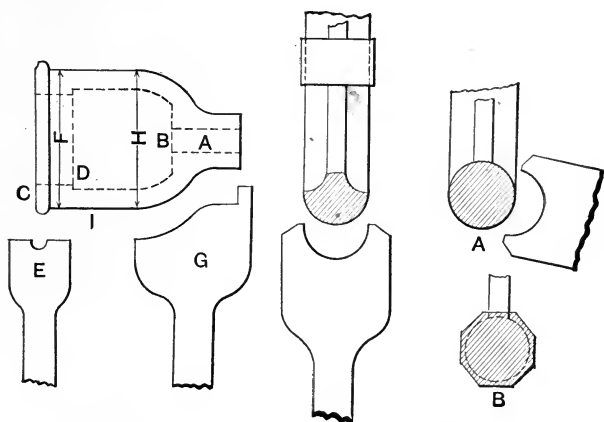

FIG. 348.

FIG. 349.

very satisfactory results can be obtained upon a wide range of work, similar to the above examples.

The tools should be so made that they can be sharpened by grinding from the top surface. If the tool is carefully made and the scale removed from the stock, it will do a larger amount of work before dulling materially. Forming tools of this character are not expensive to make, and, when any considerable amount of similar work is to be produced, will pay for themselves very quickly.

The tool shown in Fig. 349 may be used for turning balls from stock held between centers or in a chuck, as shown in Fig. 350.

If the stock is held in the chuck, the ball will not be disfigured with the center bearing. A small tip will, however, remain where cut from the body of the stock. In forming balls in this manner it is necessary to caliper the diameter carefully, advancing the tool only far enough to produce a true sphere. This method will be found very convenient in the forming of balls on the ends of handles, the ball in such cases not being cut from the body of the stock, and perfect spheres not being necessary. In Fig. 351 is shown a simple ball-turning device. The shank of the cutter holder is round and fits in a suitable bearing which is clamped to the tool block. On the outer end of the shank is secured a long lever or preferably a worm and gear mechanism for rotating

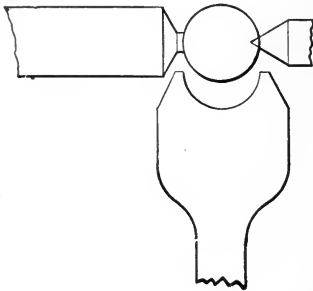

FIG. 350.

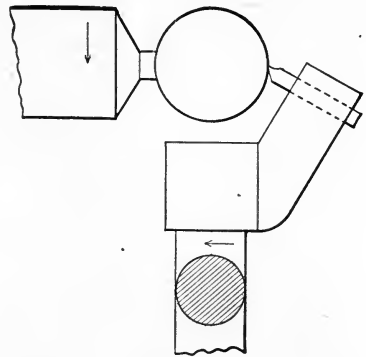

FIG. 351.

the cutter head and tool to the work. Although a truer sphere can be obtained with this device than by the use of the forming cutter shown in Fig. 350, the surface will not be as smooth as with the latter. The more elaborate device shown in Fig. 352 is better adapted to the turning of larger balls than either of the methods above referred to. While this attachment can be provided with a shank and held in the tool-post, it is much more rigid when secured directly to the tool-block or in the place of the compound rest. The construction of the device is clearly shown in the figure. In order to produce a true sphere the center of rotation of the cutter-carrying disk must be exactly under the center of rotation of the work, and the distance of the point of the tool from the center of rotation then determines the radius of the ball. By setting the tool with its point past the center of

the disk and bringing the center of the disk back from the center of rotation of the work a concave section can be produced in the work, the character of the section depending upon the relative position of centers and tool point. With work held in the chuck and the center of the disk under the center of rotation of the work, it is possible to produce on the end of the work either a convex or concave surface depending on whether the point of the tool is back or ahead of the center of rotation of the disk.

A convex or concave surface can readily be turned with a tool held in the common compound rest, the only difficulty being in the control of the feed. When the cuts are light, however, satis-

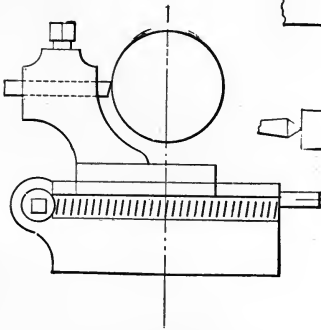

FIG. 352.

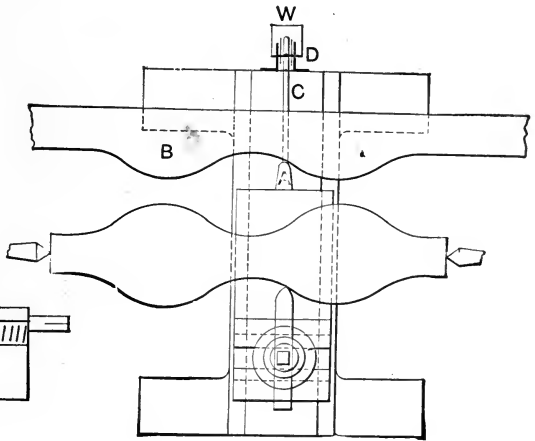

FIG. 353.

factory results can be obtained by moving the rest by hand, having its clamp bolts tightened just enough to steady the motion.

In cases where the outline is irregular and too long to be conveniently produced with the forming tool, a common tool may be made to do the work, its motion being controlled by a guide having the same outline as the one desired and controlling the tool on the taper-attachment principle. The general arrangement is shown in the top view of a lathe carriage, Fig. 353. In this case the slide is disconnected from the cross-screw. B B is the guide which is secured to the bed of the lathe and independent from the carriage. The finger A is secured to the slide and bears against the guide B B. A cord C is attached to the slide,

passes over the pulley D and carries the weight W which serves to hold the finger A to the guide at all times. The point of the cutting tool must travel with the finger A, and, tracing the outline of B B, produce the same outline on the work. In this arrangement the tool is usually set to the work by adjusting it through the tool-post. A threaded adjustment in the finger A makes a good adjustment for the finer tool settings. This method is applicable only when the cross-section of the work is round. If an irregular cross-section is required, a different arrangement involving the use of a pattern or dummy is generally employed. The dummy is a pattern of the same cross-section as that required on the work, and is mounted either on the same axis as that of the work rotation, or on a separate axis so geared as to make the same number of revolutions as the work. When the

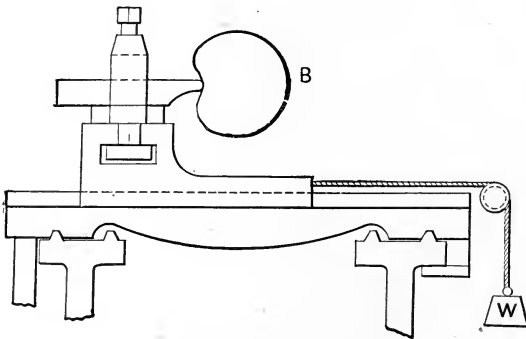

FIG. 354.

work is short and both it and the pattern can be mounted on the same axis, the former method is, owing to its simplicity, preferable. In Fig. 354 is illustrated the former method. As in Fig. 353, the cross-feed screw is disconnected from the cross-slide and a weight provided for holding the finger against the pattern B, which rotates with the work. A second tool-post, back of the one carrying the finger, holds the tool that operates on the work. It is evident that the motion of tool point and finger is the same and that the outline of the work will be the same as that of the pattern. If the two tool-posts cannot be set sufficiently far apart to allow for the required length of cut, the finger can be carried on a suitable bracket secured to the side of the tool-block. It is quite possible by careful adjustment to start the cut with the use

of the pattern, and allow the finger to lead from the pattern on to the work, thus enabling a long cut to be made with a short pattern. A careful readjustment of the finger is required for each cut in this case. It is not necessary that the pattern be of the same size as the work section, as it is frequently desirable to make it of a different size.

It is quite possible to adapt the method of Fig. 354 to internal work. In Fig. 355 the work is secured on the tool-block and the pattern on the boring bar. In this case the work moves with the pattern instead of the tool. The example shown illustrates the

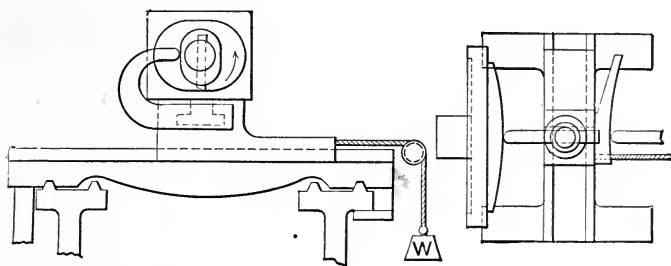

FIG. 355.

FIG. 356.

method of boring an elliptical hole. By using a movable head boring bar a thin pattern is all that is required. As a wide range of patterns can be used many forms of cams can be produced by the above method.

The same method shown in Fig. 353 is applicable to face work on stock held against the face-plate or in the chuck. In this case the weight is placed at the end of the bed, the guide is secured to the cross-slide and the finger to the tail-stock, all as shown in Fig. 356. Many outlines can readily be produced in this manner. The tool is operated by the regular cross-feed mechanism.

CHAPTER XVIII.

LATHE WORK ON FACE-PLATE, CHUCK AND CARRIAGE.

A large portion of the work done in the lathe may be classed as boring work as it comes under the following classifications: center rest, carriage, face plate and chuck work. An example of a boring operation under the first class was shown in Fig. 333. As work of this kind is usually performed on solid stock, a hole must first be drilled sufficiently large to allow the boring tool to enter. The drilling of this hole can be done to good advantage in the lathe by using a twist drill held on the tail center. The taper shank drill with holder, shown in Fig. 357, is best suited to this work as it clears itself readily of the cuttings and the holder prevents injury to the shank. In no case should the taper shank drill be held by a dog secured on the shank, as it is quite certain to slip and injure the tool. If a dog is to be used at all for this purpose, it should be in connection with a straight shank drill provided with a flat spot on the shank for the set-screw of the dog to seat upon. When considerable drilling of this kind is to be done in a lathe, it is advisable to have a set of drill sockets fitted to the bearing in the tail spindle. This not only makes a more satisfactory method for holding the drill, but overcomes the danger of the drill drawing off the tail center and being bent or broken by the cramp it would receive due to the single-handled holder.

When holes of a considerable depth are to be drilled in this manner in steel, it is difficult to properly lubricate the cutting edges of the drill, and often the work and tool begin to heat and the cuttings to fill up the flutes. The drill must, therefore, be frequently removed for oil and cleaning. These difficulties are almost wholly overcome by using the oil tube drill in places of this kind, as it provides for a constant and liberal supply of oil at the point, which not only improves the cutting and clearing of the chips, but carries away the heat of friction and thus enables the crowding of the drill to its full cutting capacity. As in this class of drilling the drill does not rotate, a common socket can be used in connection with the oil tube drill, it being simply necessary to tap for a small gas pipe connection in the side

of the socket over the supply hole in the shank of the drill. In an operation of this kind the important point is to get the drill started true. If the work has been centered for other operations previous to the drilling, this center forms a seat for steadying the point of the drill in starting. Even though this center runs perfectly true, it cannot be relied upon for starting the drill true. It is, therefore, necessary to steady the end of the drill in a different manner. In Fig. 358 is shown a common method. The steadying tool, which is held in the tool post, is made to bear against the front side of the drill, as close to the point as possible. The drill should be held so that one lip is on the back side of the work surface or opposite the steadying tool. As the cut is started, the drill is crowded slightly back of the center, making the one lip do all the cutting. This makes it virtually a rigid boring tool that cannot sway and produces a surface concentric with the axis of rotation. Just before the drill begins to cut a full diameter hole, the steady tool should be backed away and the point of the drill left free to follow the center of rotation. If this work is carefully performed, it is possible to start a drill almost exactly true. When the surface into which the drill is to enter is plane, the centering tool with flat drill point shown in Fig. 359, and held in the tool post, is used. It forms a good seat for the drill to start in.

For uniformly true and central holes the drill cannot be relied upon, and its use in the lathe is confined almost entirely to the opening up of the work previous to using a boring tool. For example, if a 1-inch hole is required in a piece of work held on a face plate or in a chuck, a 1-inch drill could not be depended upon for anything like a satisfactory result and a 63-64-inch drill followed by a 1-inch reamer would be almost as bad. The only correct way in such a case would be to first use, say, a 15-16-inch drill which would remove most of the stock and allow a boring tool to enter. It can then be bored with the boring tool to the proper diameter or, if it is to be finished with a reamer, it should be bored to within about 1-100 of an inch of the exact size, which trues the hole perfectly previous to the reaming. The reamer should be held on the tail center, which latter must be exactly central. If the tail center is offset, a tapered hole will necessarily result:

The size of drill to use for opening up previous to boring depends upon the nature of the work. If the finished hole is to

be small in diameter and deep, a drill as large as possible should be used, since the boring tool will be a long and springy one necessitating light cuts which will remove the metal more slowly than would the drill. If, on the other hand, the hole is to be of large diameter and not deep, a drill should be used that is only large enough to enable a short, stiff boring tool to readily enter, as the boring tool will remove the stock faster than the drill would. In using the boring tool, it is generally well to feed both ways through the work as this tends to equalize the effect of the wear on the cutting edge. In cases where accurate bores are required, it is quite necessary not to change the depth of cut after the cut has started, as the effect of the spring of the tool will be quite marked. A boring tool tends to make the mouth somewhat larger than the balance of the hole it is boring,

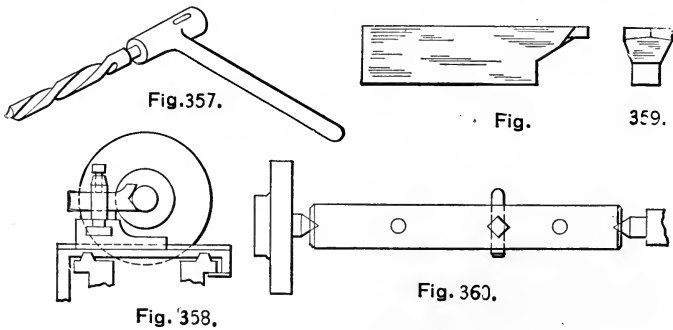

FIGS. 357 TO 360.

because the tool does not take its full spring until the cutting edge passes the end of the bore.

In the boring of parallel holes, the height of the cutting edge does not affect the parallelism of the bore. With tapered bores, however, it is necessary that the tool set at the height of the center, as a different taper than the one required will result if the cutting edge is above or below the center. The amount of taper in either case would be somewhat smaller than when the cutting edge is at the center. When the bores are long and of large diameter, the boring tool is no longer well suited to the work and what is known as a boring bar is used. These bars are of two kinds, those having a cutting tool fixed in its position on the bar, and those in which a cutting tool is secured in a movable head which traverses over the bar. The former are the least

desirable, inasmuch as they must be somewhat more than twice the length of the bore, while, with the latter, a length but slightly greater than the bore is all that is required.

In Fig. 360 is shown a plain boring bar of the former type. The cutting tool may be of flat steel secured in a mortise through the bar by suitable wedges, or it may be, as shown in the figure, of round steel, fitting nicely the hole through the bar and secured in position by a set-screw which seats on a flat spot filed on

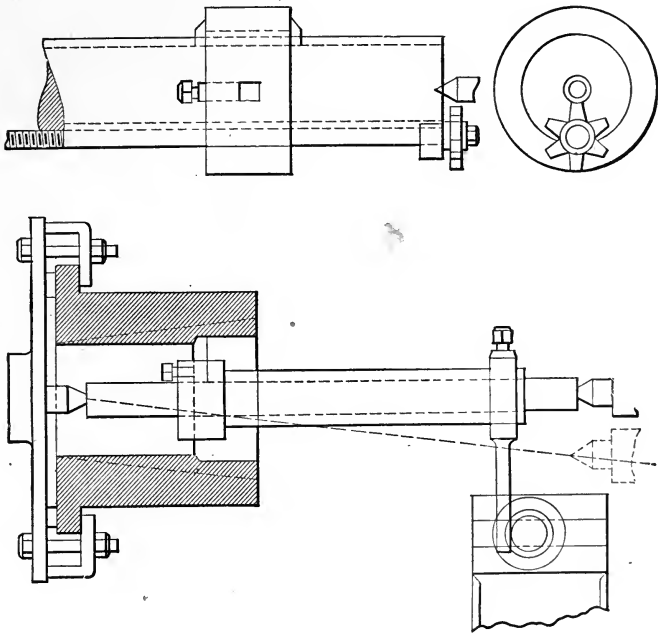

FIGS. 361 AND 362.

the tool. The set-screw should have a smooth, flat point so that, when moderately tightened, the tool can be driven under it in adjusting the cut. This class of boring bar is suitable only on work secured to the carriage, as the work must be given the feed over the cutting tool. In Fig. 361 is shown a traverse head boring bar. A tool-carrying head fits nicely upon this bar. It is splined to receive the key which is secured in the head. The feed or traverse of the head is accomplished by means of a screw usually driven by a star feed from one end. By substituting for

the star a spur gear on the screw and gearing this with a pinion, keyed on the lathe center, a smooth, steady screw feed results.

When the bar is of large diameter as compared with the head, the screw can be dropped into a suitable spline, thus getting it out of the way and protecting it from injury. Boring bars of moderate size are preferably made of a medium grade of tool steel, as this is much stiffer than mild steel. For large bars, mild steel or cast iron is suitable. When cast iron is used, the ends should be plugged with steel to receive the centers, as the cast iron wears too rapidly to retain an accurate center bearing. Movable head boring bars, in which the head is traversed by means of the regular carriage feed, can be used to good advantage in cases where the bar remains stationary and the work rotates. In Fig. 362 is shown a movable head bar of this class operating upon a cylinder secured to the face plate. The bar carries a long sleeve, one end of which terminates in the cutter. A dog or wrench secured to the outer end of the sleeve prevents it from turning and the tool post bearing against the arm of the dog transmits the regular carriage feed to the tool. By off-setting the tail center as shown by the dotted line, a tapered hole results which will be larger at the inner end of the bore, with the tool set as in the figure, but if the cutting tool is set at 180 degrees from the position shown, the bore will be larger at the outer end, as indicated by the dotted lines.

Unless the character of the work is such as to enable its outer end to be run in the center rest when the bore is long, rotating the work is not satisfactory, as its outer end is too far from the lathe spindle to be sufficiently rigid. When the work is clamped to the carriage, it is always preferable to feed the cutting tool rather than the work as the carriage can then be clamped rigidly to the bed. This insures a more accurate bore as the carriage, unless very closely gibbed, will lift on the up cut of the tool.

In Fig. 363 is shown a movable head bar operating upon a cylinder clamped to the lathe carriage. In this case, off-setting the tail center as the bar rotates will not enable the boring of a tapered hole. The tapered hole, however, can be obtained by off-setting one end of the boring bar as shown dotted in the figure. If desired, the offset can be put on the bar itself, in which case it can, as shown in Fig. 364, be offset at the tail center end. By making the center bearing adjustable, as shown in the figure, any desired taper within the limits of its adjustment may be obtained.

In boring work, it is very important to see that the work is properly secured on the carriage, face plate or in the chuck. It must be held sufficiently rigid to prevent its working loose and, at the same time, must not be sprung out of shape as, in such cases, when finished and removed from the lathe, it will be found out of true. In straight cylinder boring, more than one cutting

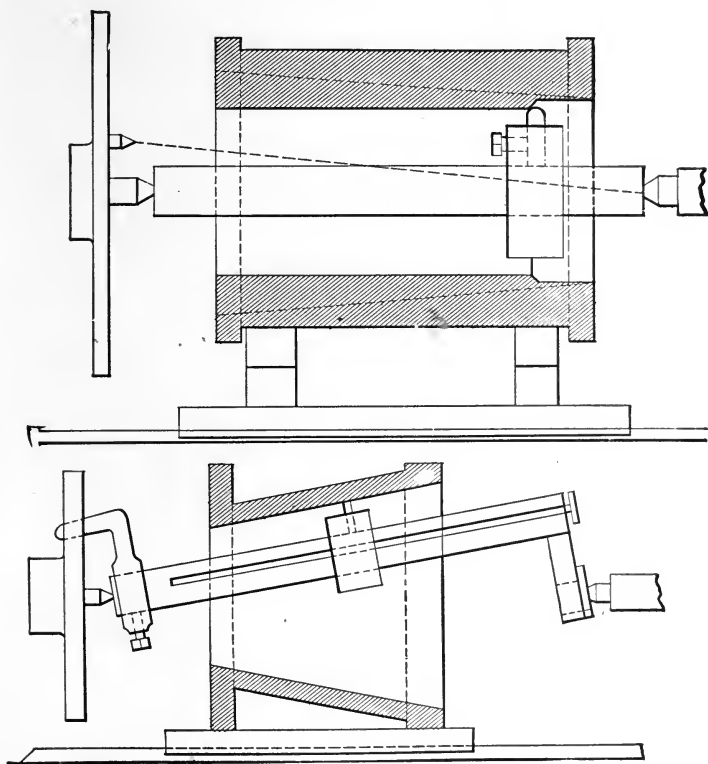

FIGS. 363 AND 364.

tool is usually employed as a single cutter springs the bar, thus requiring very light finishing cuts to produce satisfactory results. Three cutters steady the bar nicely, especially if care is exercised in setting the cuts about equal. A tool for finishing should not follow a roughing cutter, inasmuch as all the springing of the roughing cutter, due to its unequal work at different points of the bore, will be transmitted directly to the finishing cutter and

thus produce an untrue cylinder. To insure true work, the finishing cuts should always be light ones.

The chucking of most work requires thought and judgment. Fixed rules cannot be laid down, as each case must be considered from its own peculiarities. The surface to be machined, the character of the finish, the possible chances for gripping it in the chuck jaws, and the likelihood of the work's springing are all questions that arise with each case.

Frequently the form of the work is such that it cannot be held in the chuck. In such cases it is usually possible to clamp

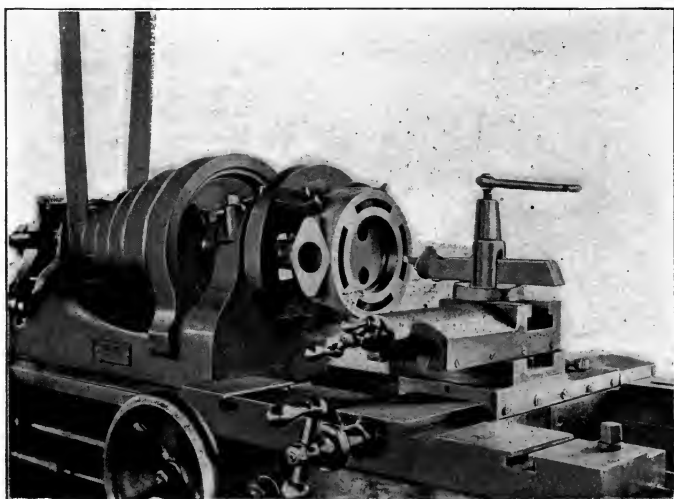

FIG. 365.

the work to the face-plate or to an angle-plate secured on the face-plate. Setting up work in this manner requires care and time. If there are many similar pieces to be operated upon, it usually pays to get up a special chuck for holding them. Take for example the cylinder head shown in Fig. 365. This head must be bored on the inside and faced on the bottom. The post on the top of the head is so high that the regular chuck jaws will not reach the body of the casting. If but a single head was to be finished, it would be secured to a knee-plate on the face-plate, as shown in Fig. 366. As large numbers are to be machined, however, the special chuck shown in Fig. 365 is employed. In a case

of this kind a set of special jaws could be used in the standard chuck. They would not be as convenient, however, as the special chuck.

It is usually best to chuck work from the outside rather than from the inside, as the danger of breaking is less. When the work is light, and it must for the roughing cuts be chucked firmly, it is certain to be somewhat distorted. In such cases the chuck jaws should be eased off slightly before taking the finishing cut. Small pulleys, gear blanks, etc., should when possible be

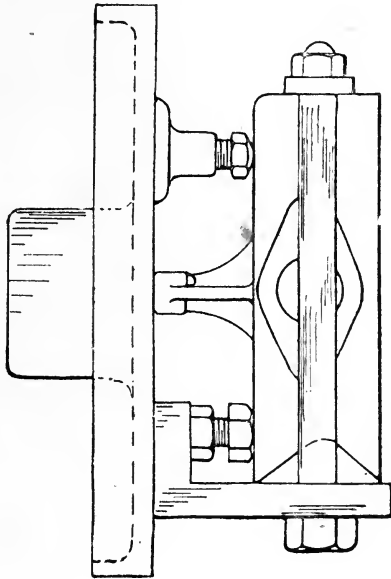

FIG. 366.

chucked on the hub. When so held and properly bored and turned, the finished work will run true. If the rim of the blank or pulley is heavy, as is the case with balance wheels, it should be chucked out upon the inside of the rim, setting the chuck jaws as close to the ends of the arms as possible. This allows the tool to be brought to operate upon the entire rim surface as well as upon the bore. Upon pulleys having light rims, and too large in diameter to chuck by the hub, carriers, as shown in Fig. 367, secured to the face-plate and clamped on the pulley arms near the rim, form excellent drivers.

When the work has a reamed bore upon which it can be finished, a split chuck can be used to excellent advantage. Such a chuck for smaller diameters is shown in Fig. 368. The taper shank fits the center bearing in the head spindle. The nose is drilled, tapped and split, as shown. A tapering screw fits the threaded bore, and when screwed in, expands the chuck enough

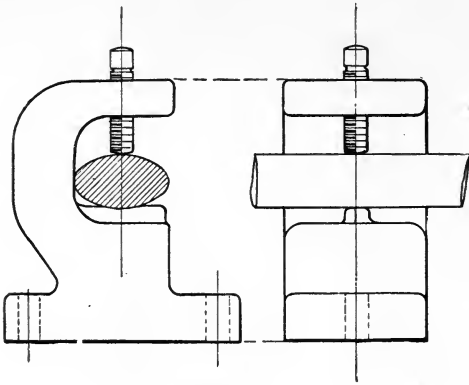

FIG. 367.

to grip in a close-fitting bore. These chucks should be tempered and ground perfectly true. Their advantage over a hardened mandrel on this class of work lies largely in the convenience in putting on and removing the work and in the ease with which the cutting tool may be brought to the edge of the bore without fear of running into the mandrel.

Nearly all turret machine operations are upon chucked work.

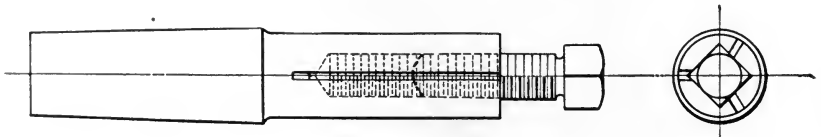

FIG. 368.

In the case of work upon bar stock some form of universal chuck is always used. The stock is of comparatively small diameter and the tools that operate upon it are brought successively into action, either by hand or automatically. A pointing box tool bevels the end; a roughing box tool passes over, taking the bulk of the stock; the finishing box tool reduces to exact diameter; the die

threads it, and the cut of slide with an inverted tool in the back holder chamfers the head, after which the tool in the front head cuts it off. For this class of work on steel a copious supply of thread-cutting oil must be constantly applied to the tool.

For bar work a comparatively small assortment of tools may be made to do a very wide range of work, but with turret machines operating upon cast work, this is not usually the case, as each particular job usually requires its own special tools. Boring in the turret lathe is usually performed with a bar having a pilot point and carrying suitable cutters, as shown in Fig. 369.

A suitable bushing in the nose of the spindle steadies the pilot end of the bar. A roughing cutter is used to remove the heavy stock, and this is followed by a sizing cutter in a second bar, or if the distance from the inner end of the bore to the nose of the

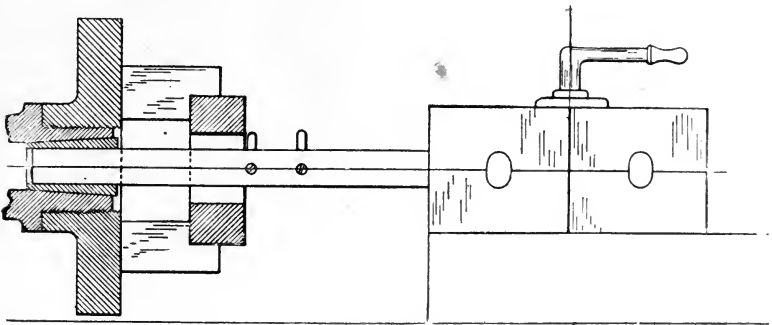

FIG. 369.

spindle is sufficient, a sizing cutter may be used in the first bar. It should be so located that it does not start its cut until after the roughing cutter clears the work, as otherwise the spring of the roughing cut will affect the truth of the finishing cut. It is usual to finish the hole to exact size with a reamer, carried also in the turret.

The above is a job for a plain turret lathe. If face surfaces are to be machined, and the number of pieces required will warrant making the tools, a facing cutter may be used as shown in Fig. 370. The hole having been reamed to size in the work, the pilot bar P steadies the work while it is operated upon by the face cutter C, which is secured in a heavy cast head H, which in turn is bolted to one of the flat faces of the hexagon turret. Heavy spindle power is required to drive cuts of this character.

When the cuts are long it is advisable to use two cutters, the first with serrated cutting edge to break up the scale before putting the finishing cutter into the work. The pilot bars should be hard-

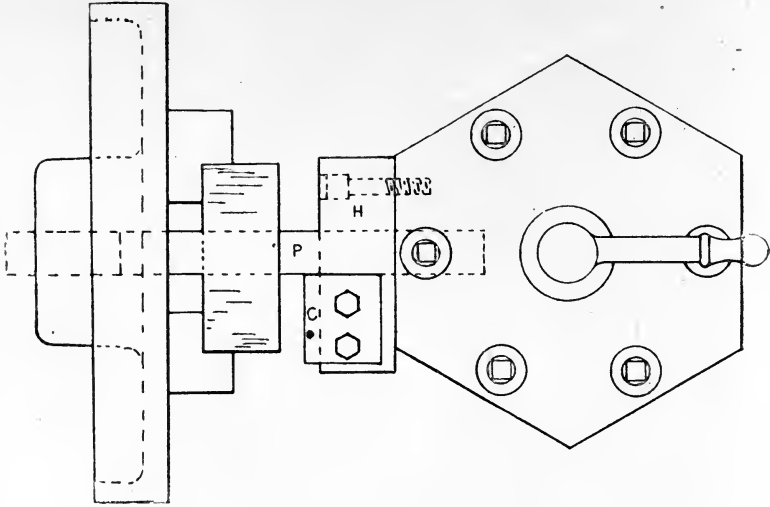

FIG 370.

ened and ground to correct size, as there is danger with soft bars of their seizing the surface of the bore.

With the turret lathes, Figs. 263 and 269, where an independent carriage is provided, operations on the face and circumference

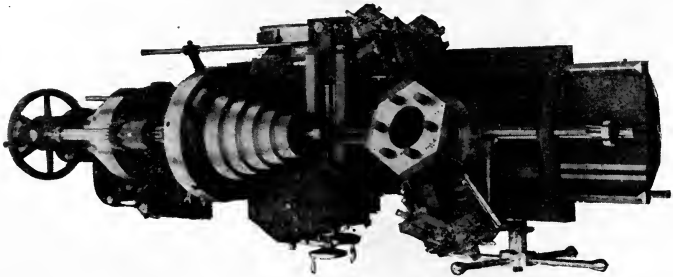

FIG. 371.

of the work can be carried on at the same time the turret tools are operating on the bore. In Fig. 371 is shown a Gisholt lathe operating on a stepped pulley. The bore having been finished, the long pilot bar is passed through it and entered into the bush-

ing in the nose of the spindle, thus forming a substantial support for the work. The heavy cast head secured to the carriage is provided with a cutting tool for each step of the cone, thus finishing all the steps in the time of the feed across one.

In Fig. 372 is shown a method of finishing cones and similar work in heavy plain turret lathes. The yoke YY is bolted to a flat on the turret. A stationary mandrel XX carries the work. A short hollow mandrel W is secured to the face-plate, exactly true with the spindle, and having a neat bearing in the yoke YY. XX fits the hole in W, and a suitable driver on the end of W engages the arms of the work, causing it to rotate upon a stationary spindle.

Feeding the turret forward advances the cutters across the

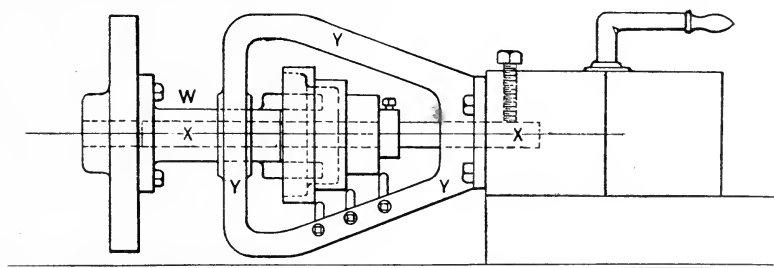

FIG. 372.

steps of the cone. These methods are, of course, applicable to a very wide range of work.

If it is required to bore a hole in a piece of work parallel to another hole that has been bored in the lathe, it is necessary to offset the work until the required bore is concentric with the axis of rotation. This involves very accurate chucking, and if the work is large, the swing of the lathe will frequently not permit sufficient offset. When enough work of this character is to be done to warrant its construction the attachment shown in Fig. 373 will be found very satisfactory. Its construction is simple, consisting of a suitable bearing that can be secured to the tool block and carrying a spindle or boring bar. A pulley for driving the bar can be attached directly to its outer end, or if the amount of use the attachment is to be put to will warrant it, it can be constructed as shown in the figure. The spindle in this case is provided with a taper bearing at F to receive a taper shank drill, an

end milling cutter or a short boring bar. The outer end of the spindle carries the gear B; gear C meshes with B and is carried on a radially adjustable stud. Gears B and C should be made to interchange or even be replaced by others, and thus provide for changes of speed on the spindle. The driving pulley E is carried loose on a suitable stud D, which clamps over the nose of the tail spindle. A pair of universal couplings with a telescoping shaft connects E and C and transmits the power. In the operation of this attachment belted power is transmitted to E and to the regular lathe feeds used for advancing the cutter to the work. The face plate must be blocked to prevent the work from turning. In Fig. 374 is shown a satisfactory method of blocking the face plate and, at the same time, of providing an adjustment for accurately locating the position of the bore. An attachment of this kind will frequently be found quite valuable

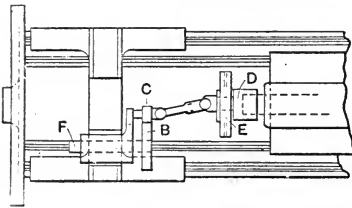

FIG. 373.

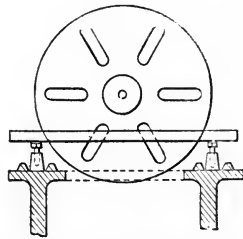

FIG. 374.

as, for example, in the boring of a crank disc for shaft and crank pin, the attachment boring the hole for the pin with reasonable certainty of getting it parallel with the bore for the crank shaft.

Fig. 375 serves to illustrate a class of attachments that can be advantageously used for performing milling operations on the lathe. The attachment shown is secured to the tool block in the place of the tool post. The construction is such as to provide for suitable vertical adjustment, and the milling cutter to be used is carried on an arbor held between the lathe centers. The attachment shown is suitable only for light milling operations, as it is not sufficiently rigid for heavy work. An attachment constructed along the same lines and attached to the carriage in place of the cross-slide can be made sufficiently rigid to enable heavy work

to be done upon it and will, in the absence of a milling machine, be found a most useful device.

The boring of spherical sockets can readily be accomplished by means of the special attachment shown in Fig. 376. The small gear is mounted on the flattened end of a stub center which

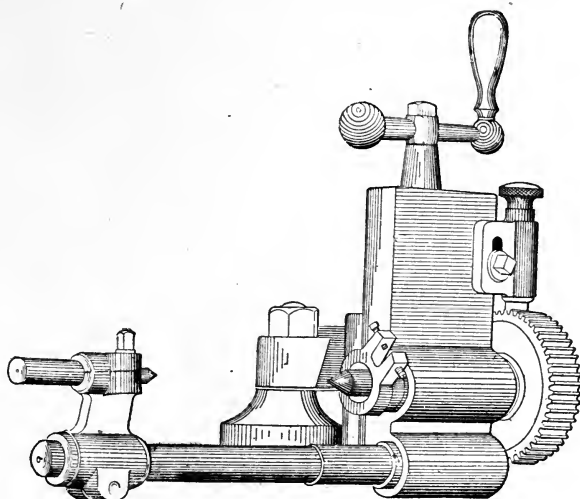

FIG. 375.

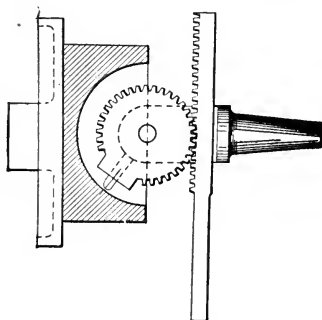

FIG. 376.

is fitted to the tail spindle bearing. The cutting tool is secured in the face of this gear and the gear caused to rotate by means of the rack which is carried in the tool-post and actuated by the regular cross-feed on the lathe. The cutting edge of the tool must be set at the height of the center.

When a piece of work is to be externally turned to fit a certain hole or bore the character of the fit must be specified as a working fit, which may be close or easy; a driving or forced, or a shrink fit. The working fit indicates that the one moves over the other, either by sliding or by rotation, and the niceness of the fit will depend on the accuracy required and the means of producing perfectly cylindrical surfaces. In all working fits the difference in diameter of cylindrical surfaces must be enough to allow a thin film of oil to cover the surfaces. When very accurately formed the difference in diameter can be extremely small and a perfect working fit maintained. If, however, the surfaces are not perfectly true and smooth more allowance must be made, as otherwise the motion of the one upon the other produces heat, which usually causes unequal expansion and consequent locking of the two parts, the lubricant being forced from the surface. If sliding or rotation is forced under these conditions, the surfaces will seize and abrasion occurs.

The larger the diameter the more allowance must be made for proper working fits. For small spindles accurately surfaced .00025 to .001 inch is sufficient, while with larger sizes from .005 to .01 inch must be given.

Driving and press fits are those in which the shaft or plug is finished slightly larger than the bore and forced into the bore by driving or by pressure. On small work the operator usually depends upon his judgment as to the proper allowance. A difference for each inch of diameter of the work of from .001 to .003 usually covers the range from medium to heavy forced fits. Shrink fits may be conveniently made on work of small or large diameter, as they involve only a means for heating up the ring or bore an amount sufficient to enlarge it, by expansion, enough to allow the shaft or center to enter easily. Driving fits are adaptable only to comparatively small diameters, as a hammer or sledge is usually employed to drive the parts together, while the forced fits involve some form of powerful press. Forced fits also are adaptable to comparatively small diameters; thus, the driving axle of a locomotive is forced into the hub of the driving wheel, but the tire of the wheel is always shrunk onto its center. In making forced fits the surfaces are coated with oil, which is of course not done in shrink fits.

In making a forced fit there is a tendency to swage the metal, while with the shrink fit the bore closes squarely down upon the

center. The strains produced in either case are enormous. With a press fit it is very important that the parts come together squarely. With a shrink fit the bore usually expands enough to allow the shaft to enter freely. The correct placing of the parts together must be quickly done, as otherwise they will lock. Should the spindle fail to enter readily or stick before it is in the proper position, it must be instantly driven out. This may result from having allowed too much for the fit or from not heating the ring a sufficient amount.

Forced fits being made with oil on the surfaces, which lubricates and preserves these surfaces, make it possible to remove by pressure the spindle when desired. With shrink fits this is not always possible, the surfaces are not lubricated and frequently the bore is heated an amount sufficient to cause a scale of oxide to form, which so roughens the surface that it clings firmly. If the bore is small the shaft can usually be moved by heating the ring and forcing under a powerful press. The shaft should be kept as cool as possible while the ring is being heated by application of cold water as close to the ring as possible. Care and judgment must be exercised, and even then the surfaces are quite certain to be injured by abrasion. When the work is of large diameter and the center can readily be kept cool as with the locomotive driving wheel the ring can be heated until it drops off from its own weight.

From the above it will be noted that for work of large and medium diameter the shrink fit is most applicable and for work of smaller diameter the forced fit is best. In fact on small diameters where there is any likelihood of ever wishing to separate the parts the shrink fit should not be used.

CHAPTER XIX.

BORING AND TURNING MILLS.

Boring and turning mills constitute a special line of machine tools made necessary by modern methods of manufacture where large numbers of similar parts are to be handled and machined in an economical manner. In Fig. 377 is shown a 30-inch boring

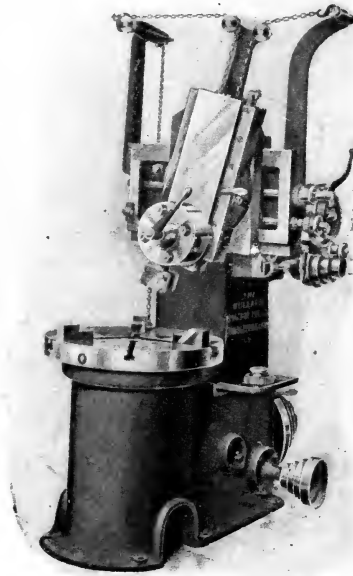

FIG. 377.

and turning mill of the vertical pattern. This represents the smallest size machine of this class regularly built.

A comparison of this machine with an engine lathe reveals the same characteristic elements in both. It is virtually a face plate lathe standing on end; the bed and upright corresponding to the head stock and bed of the lathe. The spindle, face plate and driving mechanism bear a close resemblance in both machines and the cross rail, frame and slider on the boring mill correspond

with the carriage and compound rest on the lathe. For heavy work the structural advantages of the boring mill are much superior to those of the lathe. The form of the machine gives greater rigidity and as the work rests upon a horizontal table more liberal bearings can be provided than is the case with the lathe, at the same time overcoming the heavy overhanging parts. The ease with which work can be set up and adjusted on the horizontal table is a great point of advantage.

In Fig. 378 is shown a sectional view of the spindle and table bearing on the mill, shown in Fig. 377. This large angular bearing has a self-centering tendency which tends to preserve align-

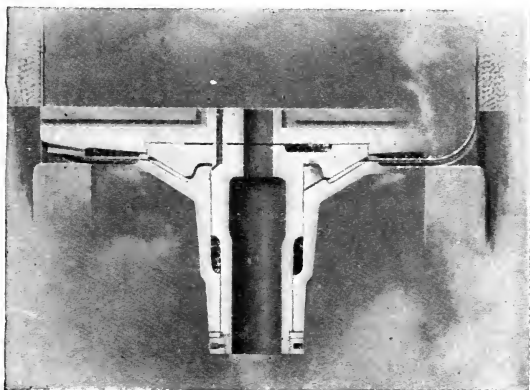

FIG. 378.

ment. This form of table bearing as well as the flat and V bearings employed on other machines of this class provides a very liberal bearing surface; the ordinary weight load due to table and work seldom exceeding 25 to 30 pounds per square inch of bearing surface. Where a flat bearing of large diameter is employed, some builders provide a means of raising the table, for fast running, from this bearing and running it in its spindle bearings, using the end of the spindle for a step bearing. The small sized machines are usually provided with turret heads, either plain or swivel. Automatic feed in all directions with feed knock off is usually provided.

In Fig. 379 is shown a vertical boring mill of the larger class. The tool shown swings fourteen feet in diameter. It is also made to swing twenty feet by using an extended base upon which

the housings are so mounted that they may be moved back from the center of the table. In the extended machines a radial arm mounted upon the cross rail, carries a boring bar which is used

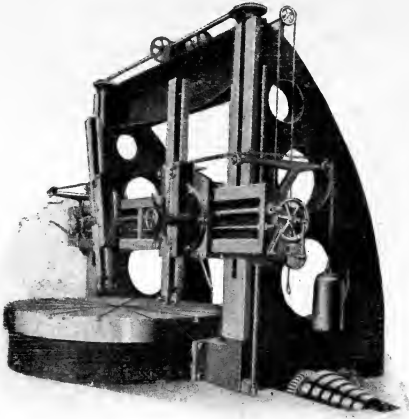

FIG. 379.

for the hub work while the other heads are operating on the outside portions of the work.

In Fig. 380 is shown a standard horizontal boring and drilling machine. The range of adaptability of these tools is large, making them excellent tools for general work. The work to be oper-

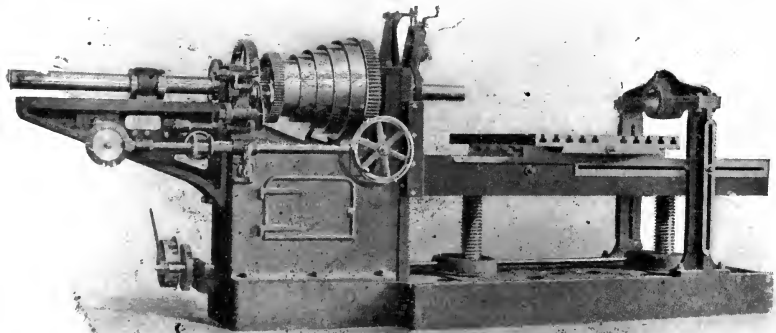

FIG. 380.

ated upon is secured to the table which is adjustable in three directions, thus making it possible to bring any part of the work surface into position to be operated upon by a tool held in the boring bar. Graduated dials on all of the table operating screws make exact spacings for holes in the work possible, a most valuable feature on many classes of work. For through work; as in the boring of cylinders, the bar is sufficiently long to extend through the outer support, a suitable cutter head being secured on the bar to carry the cutting tools. In the case of bores too small to allow the main boring bar to pass through, smaller bars fitted to the tapered bearing in the end of the main bar and fitting bushings in the outer support are used. The facing head shown at-

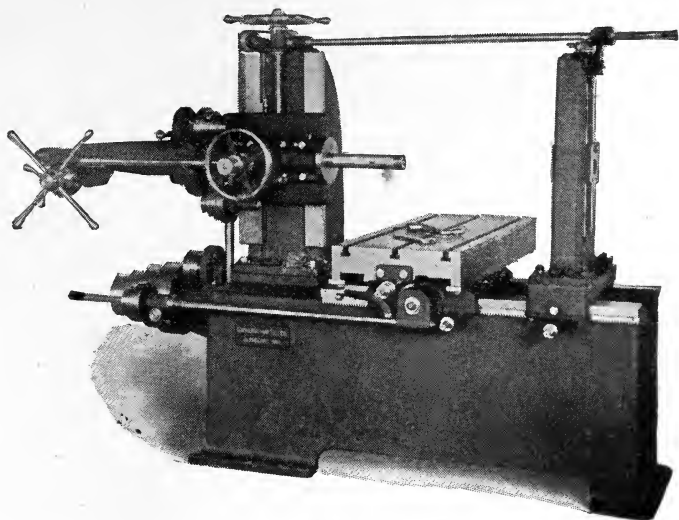

FIG. 381.

tached to the nose of the spindle may also be secured to the bar at any point, thus making it possible to face either end of work that the bar passes through. These machines may be advantageously used for heavy plain milling work.

Another form of horizontal boring and drilling machine is shown in Fig. 381. Here the work table is mounted upon the bed and the vertical adjustment is obtained by moving the spindle vertically over a substantial upright. The outer bearing is geared with the head, thus causing it to move with the spindle. Automatic table feed adds much to the convenience of this tool for general work.

For very heavy work it is frequently better to secure the work to a solid bed and give all adjustments to the spindle. Such a tool, commonly known as a floor boring, drilling and milling ma-

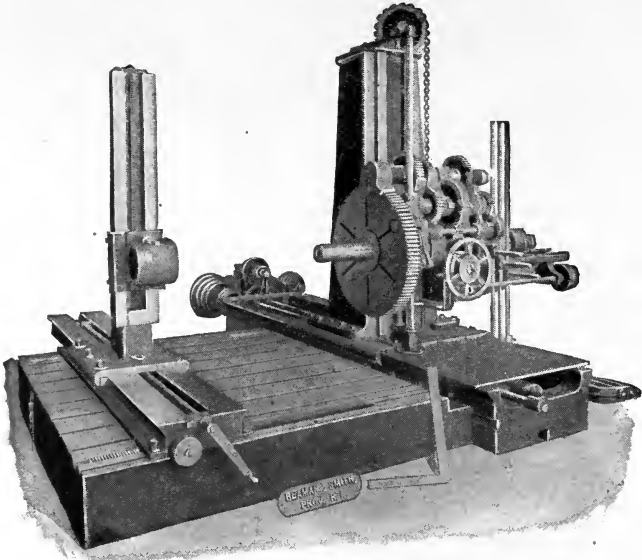

FIG. 382.

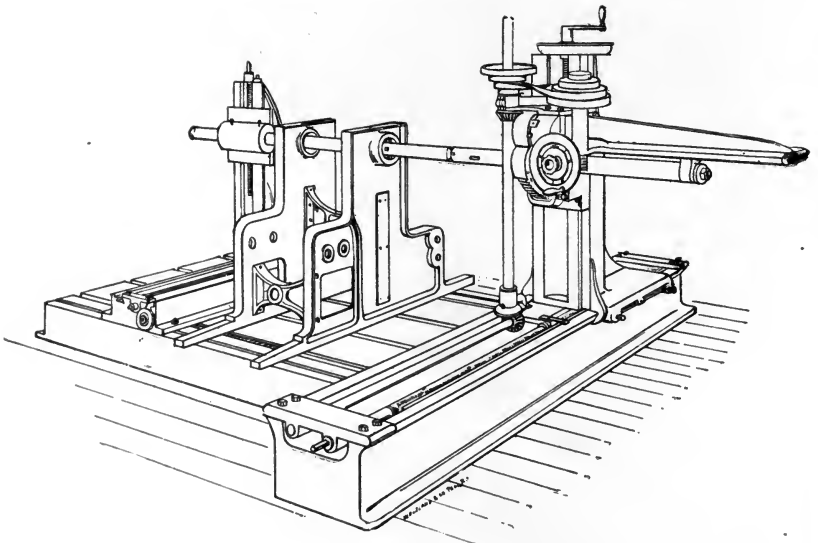

FIG. 383.

chine is shown in Fig. 382. The construction of the machine is evident from the figure. Automatic cross and vertical feeds are provided for milling. In Fig. 383 is shown an example of a floor boring mill at work on a machine frame.

In the floor boring and drilling machine of Fig. 384 a universal tilting table is provided. When fitted with a revolving table, operations can be performed on all sides and at any angle on a piece of work, the bottom excepted, without changing its setting.

Cylinders may be bored in the lathe in the vertical, horizontal

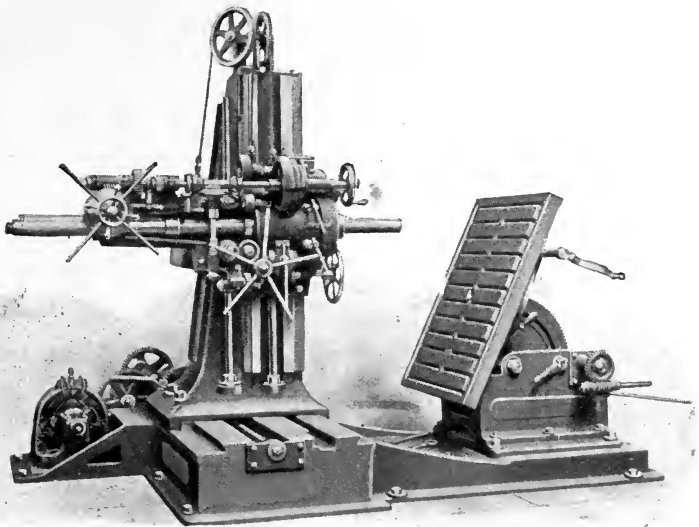

FIG. 384.

or floor boring machines, but when a large amount of that class of work is to be done, a special cylinder boring machine, an example of which is shown in Fig. 385, is generally employed. In this machine only those features of the horizontal mill necessary for the required work are retained. A heavy boring bar, rigid outer support, double facing head and no vertical adjustment are the usual characteristics of these tools. The work is usually held in a suitable jig which permits of rapid setting.

In securing work to the table of the vertical boring mill, the same care and methods are employed as with the lathe. When

possible the work is held in chuck jaws or in special drivers, as shown in Fig. 367. The latter method has the advantage of not tending to spring and affect the circular truth of the work and leaves, as in balance wheel turning, both edges of the rim free to operate upon. The turning and boring tools used in machines of

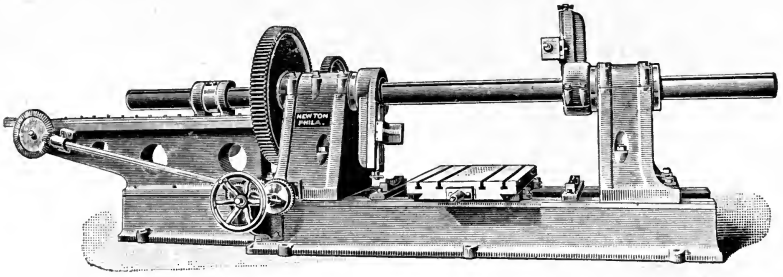

FIG. 385.

this class are quite similar to those employed in engine lathe work, the grinding of the cutting edges being the same for similar work. The same boring bars, reamers and formed facing tools used in turret lathes may be used in the vertical mill.

For cylinder boring work in the horizontal mill, the cutters are

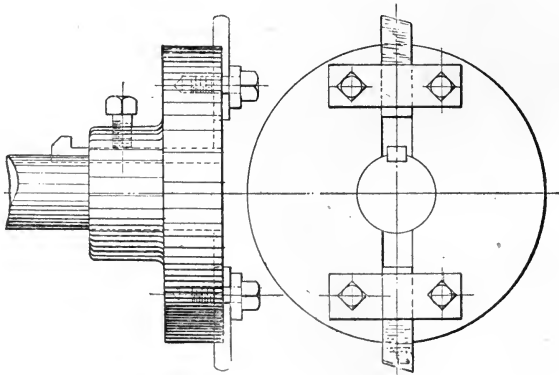

FIG. 386.

usually carried in a special head which fits over the main boring bar and may be keyed and clamped at any position in its length. A head of this description is shown in Fig. 386. The cutting tools, usually two or four in number are clamped in position and

should be supported as far out as possible. These tools are preferably of self hardening steel ground to proper form from the bar stock without forging.

In Fig. 387 is shown the method of boring and facing a gas engine cylinder in the horizontal boring mill. The yoke jigs or frames holding the work are securely bolted to the table and the work held by two set screws in each yoke. By means of these screws, and the table adjusting screws, the work can be trued

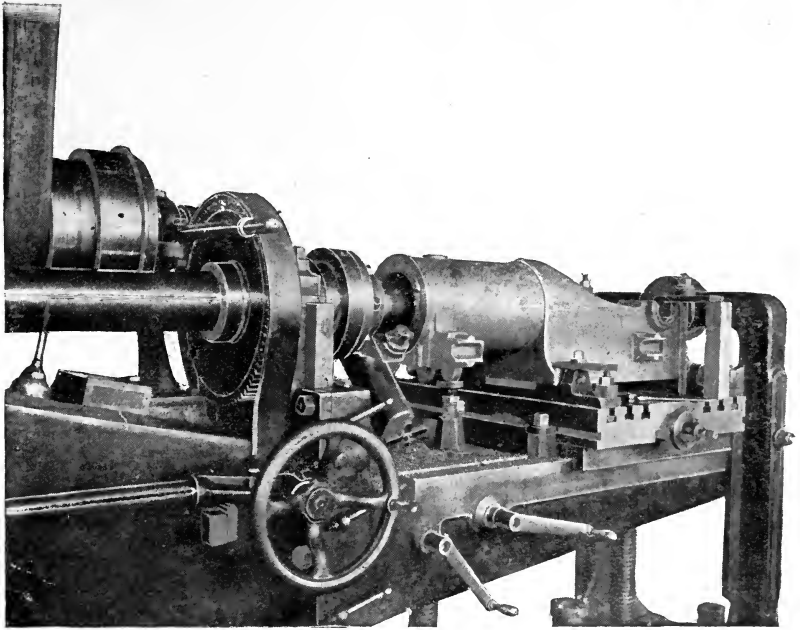

FIG. 387.

concentrically with the bar. The head shown in Fig. 386 is passed through the bore on a moderately fine feed and removes the most of the stock, the cut being divided between two or more cutters. A sizing cut is then taken back through the bore leaving only a small amount for the finishing cut. As the scale and sand has been removed by the first or roughing cut, a somewhat quicker speed can usually be employed on the sizing cut. As this cut is intended as a truing or sizing cut, the feed should not be too coarse.

The finishing tool is next placed in the head and passed

through on a coarse feed. This tool should have a broad cutting edge, very slightly rounded in its length; should be ground with very little clearance and stoned true and smooth. Its cut should be a light one and the cutting speed well within the safe limit for the steel employed. The object of the coarse feed is to distribute the cut over a greater length of tool edge and to perform the work with the fewest number of revolutions possible, thus reducing the wear on the cutting edge to a minimum and producing a parallel bore. Where a number of bores are to be finished to approximately the same diameter, it is advisable to have the finishing tool set in an independent head which can be substituted for the regular head. This virtually corresponds to a reamer and makes possible very close duplication of bores.

The end of the cylinder is next faced with the facing head shown, and if desired the holes for the cylinder head studs may be drilled and tapped by operating the cross and vertical table adjustments and using a drill and tap in the main bar. Where a number of cylinders are to be bored it is usually found more economical to do the drilling and tapping in a smaller machine.

CHAPTER XX.

PLANING AND SHAPING MACHINES.

Their Tools and Attachments.

The planer and shaper, with their modifications the slotting machine and key-seater, constitute a distinct class of machine tools, the office of which is to machine plane and irregular surfaces that can be most readily machined by a straight-line cut. Although a considerable amount of work that, until a few years ago, was classed as planer and shaper work has been turned over to the milling machine, there still remains a very wide range of work that must continue as planer and shaper work. These tools bear to the machining of plane surfaces practically the same relationship that the lathe does to the machining of round work. The cutting tools used on the planer and shaper are practically the same as those used on the lathe, and the general principles involved in the operating of the machines are quite similar.

The planer and shaper, although used on the same class of work, differ materially in design. In the planer the work moves to the tool, while with the shaper the tool moves over the work. In the planer the vertical and lateral feeds are given to the tool, while on the shaper the lateral feed is usually given to the work, the vertical feed, however, being given to the tool. In what is known as the traverse head shaper, both feeds are given to the tool and the work is held perfectly stationary.

In Fig. 388 is shown a standard modern planer. The bed is deep and heavy with the work table moving in inverted vees. The housings or uprights are secured firmly to the bed and cross-tied at the top. The cross rail is gibbed to the front of the housings and carries the tool head. The cross rail is adjustable vertically, being operated by the two elevating screws, by hand on the smaller machines, and by power on the larger ones. On the large machines, two heads are frequently used on the cross rail and one on the face of each housing, thus enabling several cuts to be taken on the work at the same time.

The important features of the planer are its table driving mechanism including reversing gear and the mechanism for operating

the feeds. In some of the earlier planers the table was driven by a quick-pitch screw with suitable gears and pulleys at the end of the bed. This method has been entirely replaced by the rack and

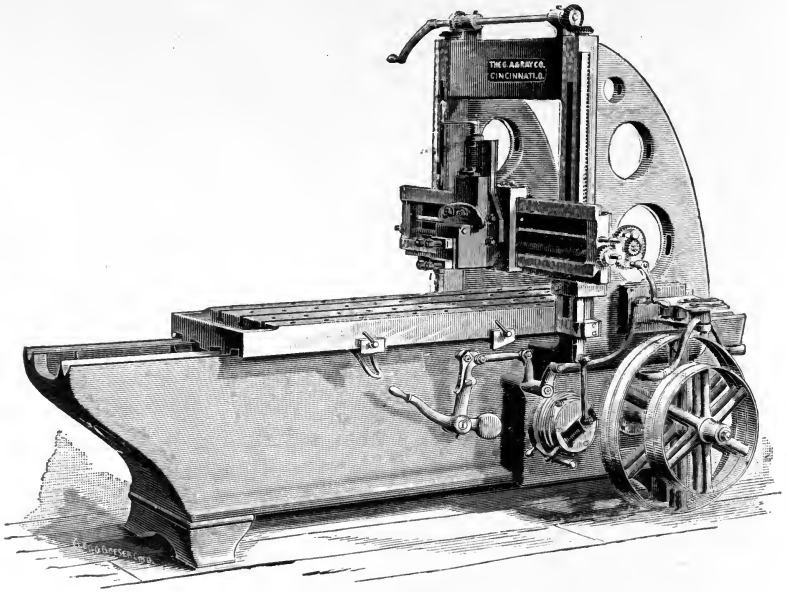

FIG. 388.

gear drive and the Sellers or spiral gear drive. In Fig. 389 is shown the gear arrangement as commonly used in the rack and

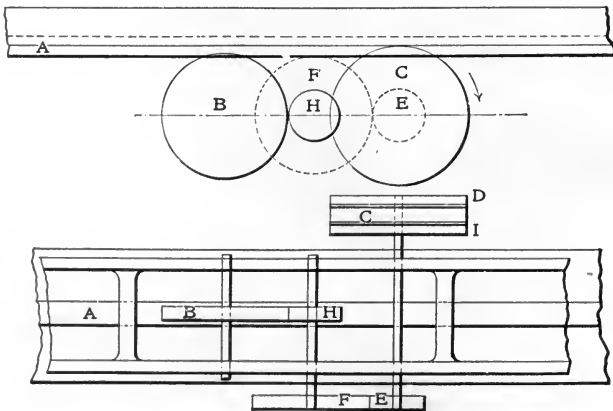

FIG. 389.

gear drive. The rack A is secured to the bottom of the table. The gear B meshes with the rack and is driven from the pulley C through the gear reductions E F and B H. D and I are loose pulleys carrying belts that run in opposite directions. When the belt running in the direction of the arrow is on the pulley C the table and work move toward the tool, and when the reverse belt is thrown upon C the table moves the work away from the tool. The backing belt is usually driven at about four times the velocity of the forward belt, thus giving the table what is termed a quick-return motion. The object of this is to get the table and work back and ready for another cut with the least possible loss of time. As applied to the planers by different makers, this mechanism differs somewhat in its arrangement, but in all cases is a simple geared reduction.

The reversing mechanism differs materially on the various machines. That used by the Gray Company on the planer shown in Fig. 388 illustrates one of the simpler methods. As quite clearly shown, the belt-shifting rings are attached to a pair of arms controlled by cams. The dogs, which clamp to the side of the table at any point in its length, engage the shipper lever on forward and return strokes, through the connecting rod, and move the cam plate and belt arms. The motion is such as to cause the belt driving to be shifted from the tight pulley before the other belt is shifted on, thus preventing both belts from getting on to the tight pulley at the same time. As these belts must be shifted very quickly and, when the table is making short strokes, very often, it is quite necessary that the belts be narrow and run at a high velocity. These belts will not shift properly if run too tight, and should always be of the best grade of double leather belting in order to stand the wear and pressure on the edges. As it is frequently necessary to run the work out from under the tool to take measurements, and it is not desirable to change the position of the dogs, the shipper lever is provided with a trip stop which can be raised, to allow the dog to pass over without changing its position. The planer cannot be depended upon to stop its table at exactly the same place each stroke. This variation may arise from changes in the pressure of the cut, but more frequently from changes in the speed of the belts, thus varying the time in which the inertia of the rotating parts is overcome each time the belt is shifted.

In Fig. 390 is illustrated a planer with a spiral geared or

Sellers drive, and the planer shown in Fig. 394 also has a drive of this description.

As shown in Fig. 391 the mechanism for driving the table is simple. A spiral pinion, usually having a quadruple thread, engages a rack, the teeth of which are at right angles to the length of the table. This throws the axis of rotation of the pinion away from the line of motion of the table an amount equal to the spiral angle of the teeth in the pinion and carries the pinion shaft at this angle through the side of the bed. This gives a broad bearing between the teeth of the pinion and rack and causes the line of pressure to come directly in the line of the table's motion. Suit-

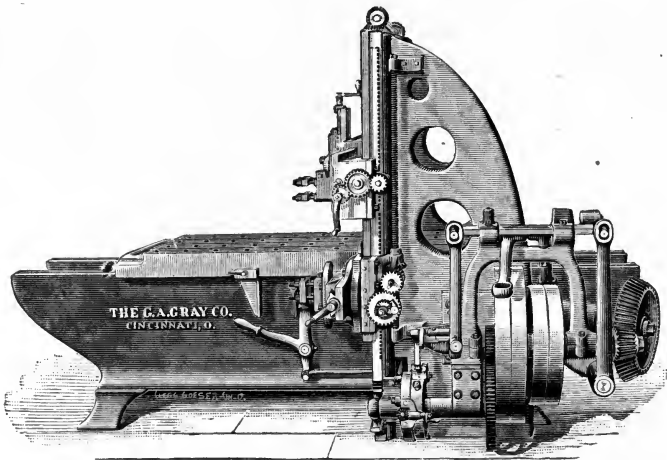

FIG. 390.

able bevel gearing and tight and loose pulleys on the outer end of the shaft complete the driving mechanism: This drive is noted for its smoothness of action, and freedom from the vibration frequently found in spur gear drives.

The mechanism for operating the feed is comparatively simple on most planers, the same mechanism usually operating both vertical and cross feeds on the cross rail head, or heads when more than one are used. As the amount of feed adjustment per stroke must be constant and as the length of the stroke varies, it is necessary that the feed-operating device give the full amount of feed adjustment during a relatively small amount of the table's stroke. In fact, the shortest stroke it is possible to have the table

make, should give the full feed adjustment for each stroke. In Fig. 388 the arrangement shown is simple and effective and in modified forms is largely used by the different builders.

The head which operates the feed is driven by the extended

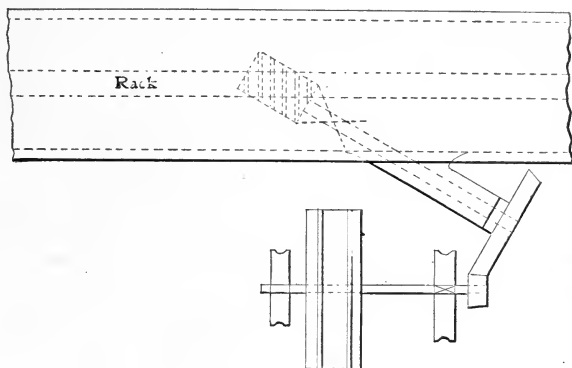

FIG. 391.

pinion shaft, the arrangement of parts being as shown in Fig. 392. The disc A is secured to the shaft and consequently rotates with the pinion, right or left handed rotation depending upon the direction in which the table is moving. The disc carries a casing B and cover C, the cover being held to B with the

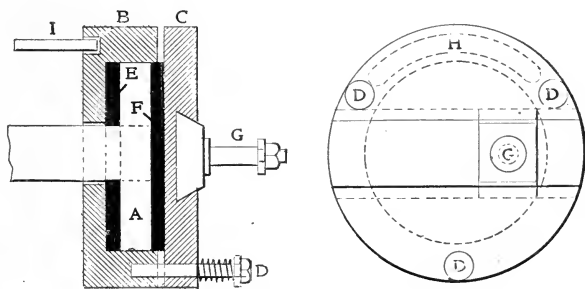

FIG. 392.

three studs D D D and against the friction washers E and F with a uniform pressure by the spiral springs under the nuts on the studs. If the casing is relieved, it and the cover C, together with the wrist pin G, rotate until the casing is again held. In the back of the casing is a slot H into which the stationary pin I extends.

The length of this slot is determined by the amount of casing rotation required. In action, the table starts on its stroke; B and G rotate until I strikes the end of the slot H and the rack has been moved up or down, depending upon which side of the center the pin G is. As the table continues its stroke, the disc A slips between the washers E and F, and G remains stationary. When the table starts on its return stroke, A rotates in the opposite direction, carrying with it B and G until the pin strikes the other end of the slot, the rack having received motion in the opposite direction to that given on the forward stroke. Thus the rack is moved up and down once each time the table moves forward and back, and the amount of the rack motion depends upon the distance B is from the center and is independent of the length

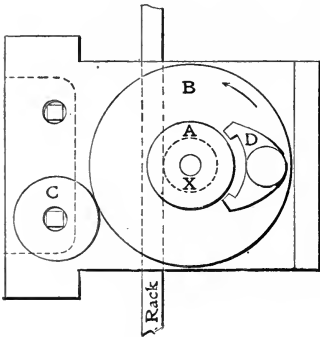

FIG. 393.

of the table stroke. A pinion X gears with the rack and through a shaft carries the gear A, Fig. 393. Gear B rotates free on the shaft, gears with C, and on its face carries the double pawl D. If the lower foot of this pawl, as it stands in the cut, is thrown in, it slips on the up stroke of the rack, but drives the gear B in the direction of the arrow on the down stroke. If the upper foot is thrown in it slips on the down stroke and carries gear B

in the opposite direction, the direction of feed being reversed. It is evident that with the wrist pin G, Fig. 392, on the same side of the center, the feed occurs at the beginning of the forward stroke when the feed is in one direction, and reversal of the feed makes it occur at the beginning of the return stroke. The wear on the feed mechanism is least when the feed occurs at the beginning of the return stroke, as it is not then necessary to move the tool while cutting. On the other hand, feeding on the return stroke makes the wear on the tool in dragging back somewhat greater. When the heads are attached to the face of the housings, they are given a vertical feed on the housing in a manner similar to that already described. By removing the gear C from the cross screw and putting it on the feed rod, the vertical feed is operated in a manner similar to that for the horizontal feed.

The size of a planer is determined by the length of its table, the distance between housings and the maximum distance between table and bottom of cross rail. The extension side planer is so constructed that the housing on the side opposite the driving and feed mechanisms can be extended out over the widened bed. In this tool, the capacity is increased by spreading the hous-

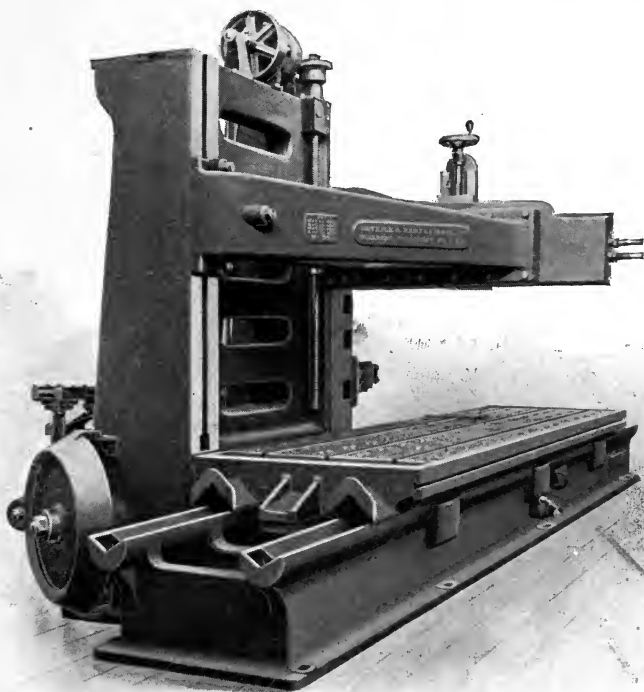

FIG. 394.

ings, an extra long cross rail, of course, being required. This class of planer is of value in shops where only a small per cent of the work done requires a wide planer. Another modification known as the open-side planer is shown in Fig. 394. In this tool one housing is dispensed with entirely. The cross rail being heavy, strongly braced and carried on heavy housings on the one side removes the width limit on the work to be machined.

When the work is very wide and overhangs the table by an excessive amount it is necessary to provide some form of out-board support for the outer portion of the work to rest upon.

On all planers the cross rail is elevated by two square-thread screws set in the face of the housings and geared together at the top. These screws are preferably right and left handed and must be very accurately cut, as otherwise the cross rail will not remain parallel to the table in its width at all positions. On the larger

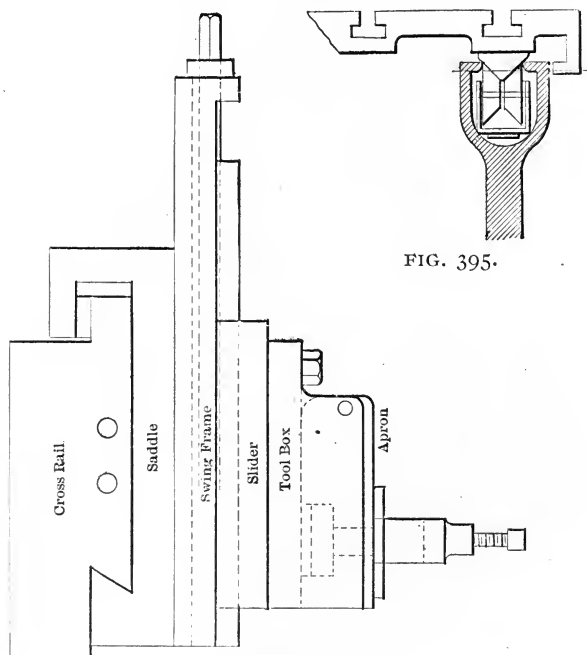

FIG. 395.

FIG. 396.

sizes where the cross rails usually carry two heads and are very heavy the elevating screws are operated by power belted from the countershaft.

The form of bed shown in Fig. 388 is the one known as the deep box bed and is now quite generally used. It is strongly ribbed and its form is such as to make it very strong and rigid. The form of table guide quite exclusively used on planers is known as the inverted "V." In any planer it is very important that these guides be most carefully fitted and suitable means pro-

vided for their lubrication. The bearing surfaces are usually grooved to retain and distribute the oil with suitable wipers provided to carry the lubricant to these surfaces. In Fig. 395 is shown a common and very efficient method. An oil well or pocket is cored in the bed near the center of the table's motion, and a pair of conical rollers carried in a suitable frame and held against the surface by a spring carries the oil from the well to the surface to be lubricated. The principal difficulty with this arrangement comes when the table is worked on short stroke for a considerable length of time, as in that case the portion over the rollers only is properly lubricated. On long strokes, however, the action is perfect.

The planer table is always provided with a large number of holes for stops and for bolting the work to the table, also with suitable T-slots. These holes should be drilled and reamed and the T-slots planed or milled in order that the bolt heads may move freely in them.

Fig. 396 shows a side view of a planer head. This same general form is used by all builders on both the planer and shaper. It is nothing more than the compound rest on the lathe, having in addition the tool box and apron. The cross rail corresponds to the carriage on the lathe. It is a rigid girder that contains the cross-feed screw and the vertical feed rod, and upon which the saddle travels, it being securely gibbed to the cross rail. The swing frame pivots at the center of the saddle's face and may be clamped at any desired angle, either side from the vertical, the amount of the angle being determined by graduations either on the edge of the frame or face of the saddle. The slider is gibbed to the swing frame and operated by the feed screw shown in the figure, either automatically or by hand. The automatic feed is accomplished in the same manner as for the compound rest, a section of which is illustrated in Fig. 243. The mechanism, of course, varies somewhat with the different builders. The tool box is pivoted to the slider and has a limited amount of adjustment each side from the center, being clamped rigidly in any desired position by the lock bolts shown. The apron, which fits neatly in the tool box, is pivoted to the box at the upper forward corner, thus allowing it to swing outward on the return stroke and prevent the tool from dragging heavily over the work surface. The tool post is secured to the apron. The office of the tool box is to allow the tool to swing out from the work on the return

stroke when machining side surfaces. It is evident that if the tool post was secured to an apron pivoted directly to the slider, the tool would swing straight out on the return stroke, which would be all right when machining top surfaces. If, however, side surfaces were machined, the tool, in swinging straight out, would drag up over the surface planed, injuring the tool and marring the surface. When, however, the apron pivots to a tool box that can be inclined somewhat away from the work surface, it is evident that the point of the tool will, upon the return stroke, swing out from the work; but if the top of the tool box be inclined toward the side of the work, the tool will swing into the work surface, causing trouble. It is therefore necessary to swing the box in the opposite direction when changing from one side of

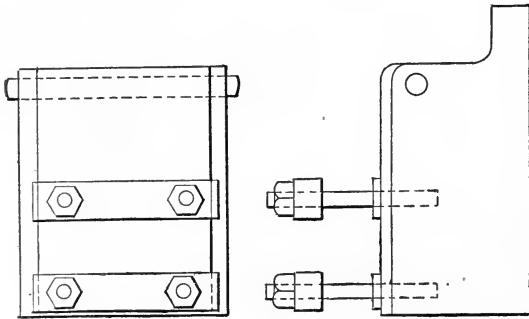

FIG. 397.

the work to the other. The tool clamping device may be an ordinary tool post as used on the lathe, but it is more commonly a pair of clamps, as shown in Fig. 397.

What is known as the standard shaper is of the column or pillar pattern, one design of which is shown in Fig. 398, with several shaper attachments (to be described later). In this machine the upright is called the column. The cross rail is gibbed to its front face and is adjustable vertically by a suitable elevating screw. The box or knee is secured to a saddle which moves over the cross rail. The ram carries the tool head which is in every way similar to the one described above, the swing frame being pivoted to the end of the ram. In the example shown, the swing frame is rotated by means of a worm gear and hand wheel, which enables its operation while the machine is in motion, a most convenient method of shaping out concave surfaces.

In all shapers the ram is actuated by one of two methods. The geared method provides for a rack and gear drive similar to that used in operating the table in the planer. It is simply a geared reduction, the quick return to the ram being accomplished by either the use of a smaller backing pulley or higher belt velocity for the return stroke. This drive is illustrated in Fig. 389.

In Fig. 399 is shown a standard pattern shaper having a rack and gear drive. This drive, although little used on small machines, is always applied on the larger shapers. Machines of the pattern shown in Fig. 399 are regularly made in sizes from 16-inch stroke up to 48-inch stroke.

The other method is known as the crank drive, in which a

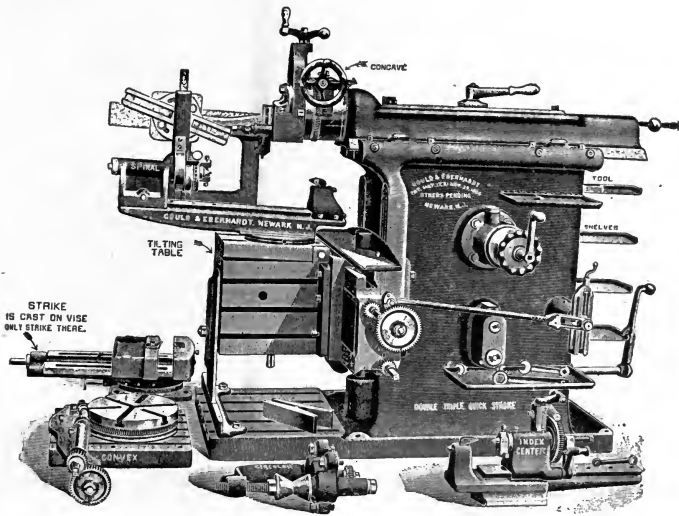

FIG. 398.

crank or its equivalent, operated by a suitable system of gears, transmits the motion to the ram. The use of the simple crank drive has been superseded by crank drives which involve a quick-return motion. With the simple crank motion, not only is the time occupied on the return stroke of the ram equal to that on the forward stroke, but the relative velocity of the ram varies greatly between the beginning and the end of the stroke, being much more rapid at the middle than at the ends. With the quick-return motion, however, it is intended to reduce the time during which the ram is on its return stroke and thus give more time for

the forward or cutting stroke, and also to average up as much as possible the relative velocity of the ram at the different portions of its forward stroke. In all cases the power is communicated to a shaft, usually by a belt running on a stepped cone, causing it to rotate at a uniform rate of speed.

Crank shapers as regularly made run in sizes from 14-inch to 30-inch stroke.

In Fig. 400 is shown the mechanism commonly known as the slotted or vibrating link. P is a pinion receiving motion from

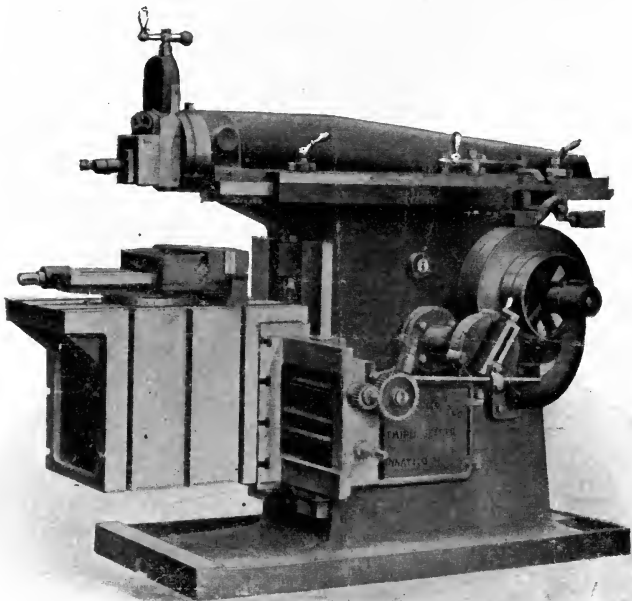

FIG. 399.

the belted cone at a uniform rate of rotation, and gearing with the gear G. The link M M pivots at the point L and carries at its upper end the rod R which connects with the ram at H. A block B is fitted nicely in a slot S in the link and is carried on the pin I which projects from the face of the gear G. The path of the pin is a a, the block B moving up and down in the slot and causing the link to vibrate about L through the limits y y, carrying with it the rod R and the ram. If G rotates in the

direction shown by the arrow and the tool end of the ram is at K, then the forward part of the stroke occupies that portion of G's rotation indicated by the angle x and the return portion by the angle y . It is, therefore, evident that the return stroke occupies

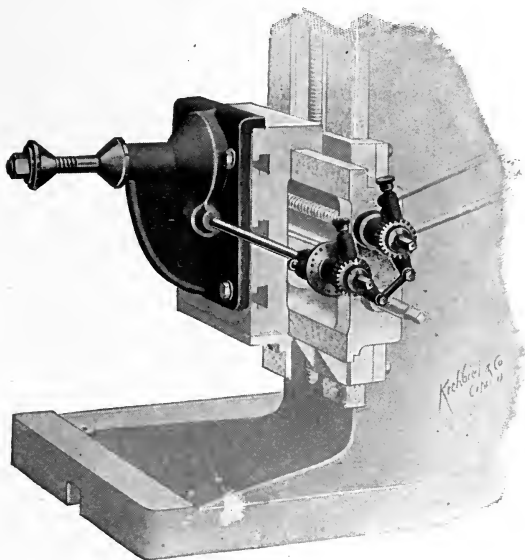

FIG. 399A.

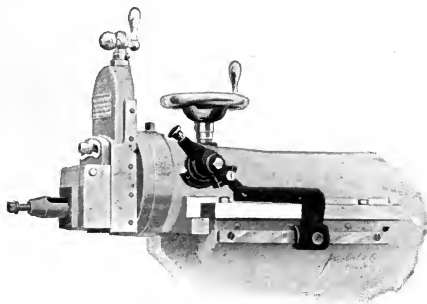

FIG. 399B.

much less than one-half of the revolution of G. An analysis of the mechanism shows the motion of the ram to be much more uniform than with the simple crank, the velocity being faster at the beginning and end of the stroke and slower through the

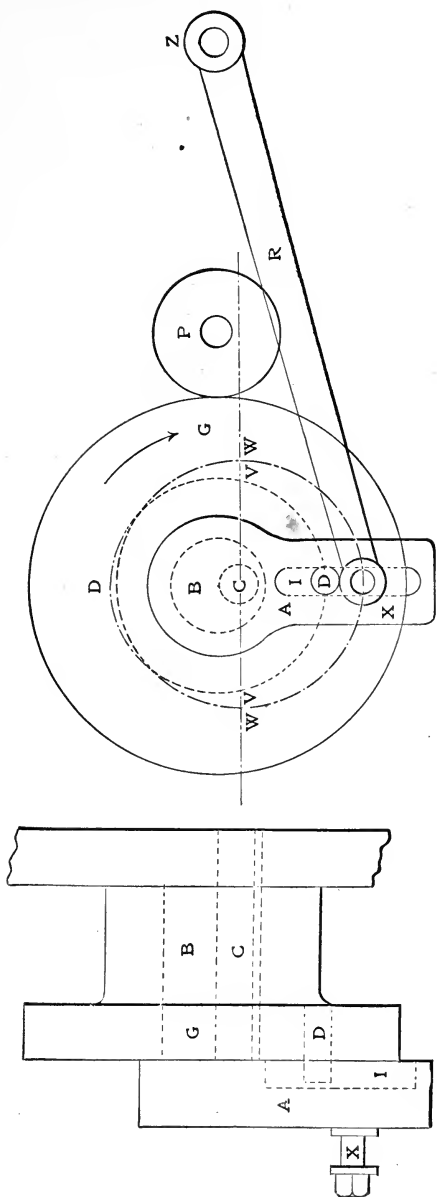

FIG. 401.

of C. When the crank is in the position shown, the lever arm D C is minimum, and since D rotates at a uniform rate of speed, the velocity of X will be greater at this point than at any other point in its rotation. When D reaches the position D', the lever arm D C becomes maximum and the pin X is moving at its slowest rate. While X is going from W to W', in the direction of the arrow, the ram Z is making its return stroke and the pin D has rotated from V to V' or through somewhat less than one-half of its revolution. The forward stroke is made while R

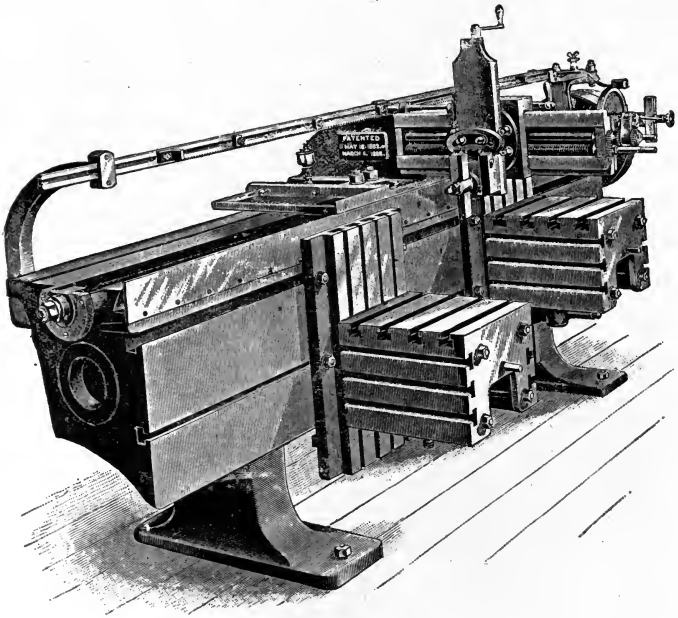

FIG. 402.

moves from W' to W and D from V' to V. It is evident from the above that more time is occupied on the forward than on the return stroke.

A form of shaper well adapted to the machining of long pieces of work is shown in Fig. 402. In this tool the bed, which is long, carries the knee on its front face and the arm which corresponds to the ram on the pillar shaper is given a motion lengthwise of the bed, the tool head being fed automatically in or out on the arm. This machine differs from the open-side planer, as illustrated in Fig. 394, in that the tool moves over

stationary work, whereas the work moves under the tool in the open side planer. On that which is known as the movable head shaper, illustrated in Fig. 403, the work remains stationary and the ram is mounted in a saddle gibbed to the top of the bed and fed over the work. Shapers of this class are most excellently

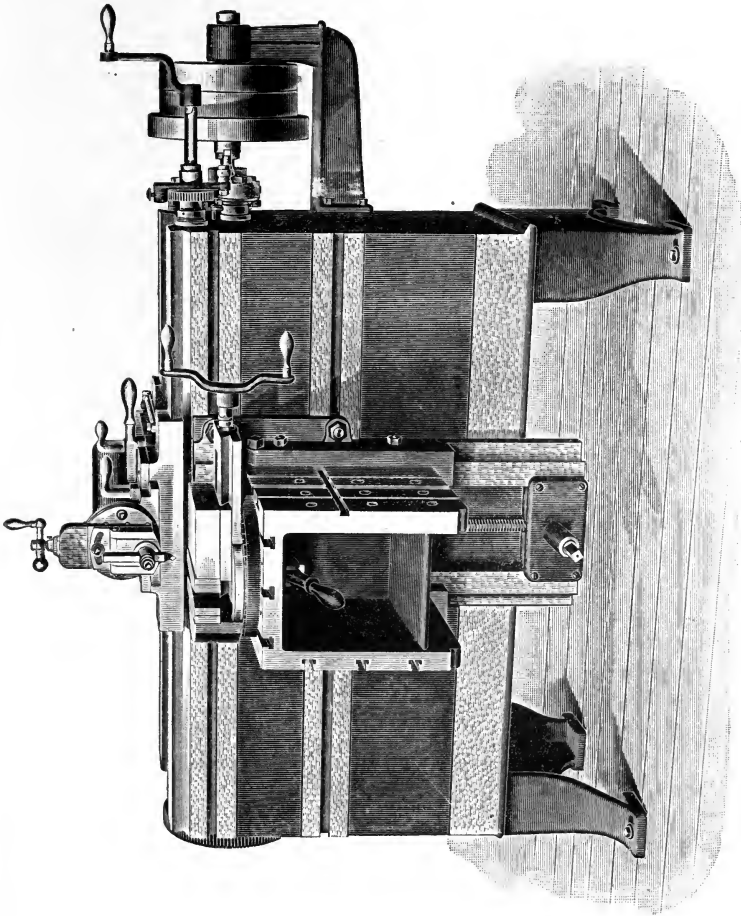

FIG. 403.

adapted to the machining of widely separated surfaces on heavy pieces of work.

In the classes of shapers above illustrated the cutting stroke is the outward or push stroke. In the Morton or draw stroke shaper shown in Fig. 404 the reverse is the case, as the tool cuts on the inward or draw stroke. This tool has been very success-

fully used on heavy work and long strokes, and has been widely modified by its builders to suit special conditions. The head alone, attached to a suitable knee plate and driven by flexible shaft, rope transmission or electricity, is quite extensively used as a portable shaper to be clamped to the work that is to be machined.

Many of the cutting tools used on the planer and shaper are

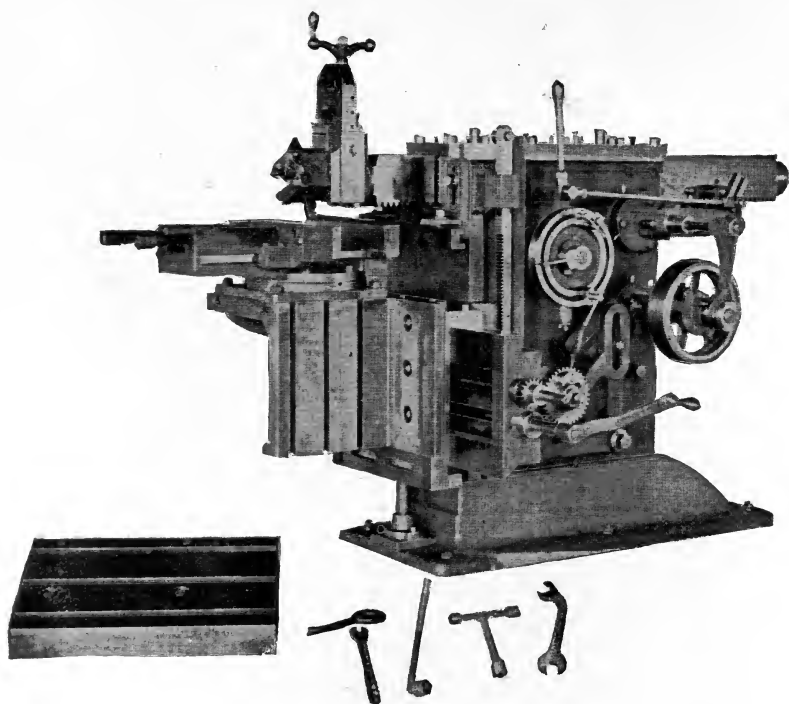

FIG. 404.

the same as those used on the lathe, as, for example, the side-cutting, diamond point and cutting-off tools. There are, however, several forms specially adapted to planing operations. The extended nose tool shown in Fig. 405 is used for cutting keyways or for any class of internal work. This tool, unless short and heavy, springs badly. It should be held as high in the tool holder as permissible, thus reducing the spring to the least amount possible. The shape of the cutting edge is suited to the character of the work and should be given as small an amount of bottom

clearance as will enable it to take hold of the cut, otherwise it will dig into the work badly. The Armstrong planer tool shown in Fig. 406 takes the place of several forms of ordinary planer tools, as top roughing, right and left side roughing and right and left under-cut, all as shown in the figure. It may also be used to hold cutting-off blades or formed cutters of any class. A tool of this kind for the planer possesses the many advantages of

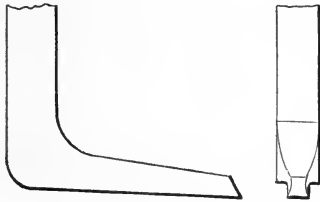

FIG. 405.

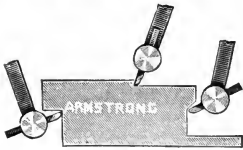

FIG. 406.

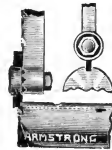

FIG. 407.

similar tools for the lathe in which a small cutting tool of self-hardening steel, ground rather than forged to shape, is used.

The gang tool shown in Fig. 407 is often used on the planer where the surface to be machined is large and comparatively regular in outline. It consists, as shown, of several tools set one back of another in a suitable head held in the tool clamps in the usual manner. The cutting points are so adjusted that each takes the regular cut desired so that a regular feed of, say, 1-16 inch on each cutter would, on a gang cutter tool, enable the head

to be fed over the surface one-fourth of an inch at each stroke of the work. A tool of this class carrying a roughing and a finishing cutter must not be depended upon to produce satisfactory work when good machined surfaces are required, as the spring of the roughing cutter due to the inequalities of the work surface is communicated to the finishing cutter, and this must as a result produce a finished surface having much of the irregularity of the original rough one. Single tools of this character with special formed cutting edges are much used on special work.

Planer and shaper tools should, almost without exception, be ground with very little bottom clearance. The rake should be suited to the hardness of the metal being machined. It is advisable, when possible, to have the cutting edge well back under the head so that the spring of the tool and head will not cause

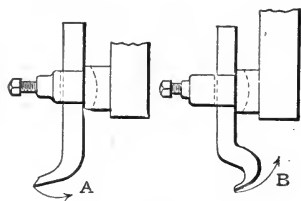

FIG. 408.

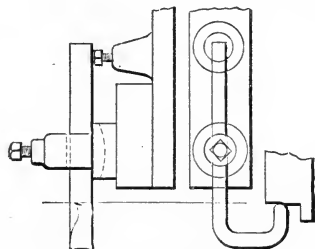

FIG. 409.

the cutting edge to dip into the work surface; it also tends to prevent chattering. This point is illustrated in Fig. 408, where at A is shown a tool whose cutting edge is well ahead, and at B one with the cutting edge well back. The dotted lines show the path the cutting edge tends to follow in each case, due to the spring of the tool itself. The spring of the head tends in each case to let the point into the work, but not so badly in the case shown at B as at A. On all top and side cuts the tool swings out and away from the work surface on the return stroke. For under cuts, however, except those of comparatively slight angle from the vertical, where the head can be angled to meet the condition, the tool must be held from swinging out on the return stroke, as it would in that case cause trouble, lifting the work or breaking it, the tool, or the head. For under cuts the tool should have a long shank extending well above the clamp and blocked out at the top as shown in Fig. 409. As the tool

drags back heavily in such cases, the wear on it is excessive. A side head, due to its position, is well adapted to under-cut work. Where much under-cut work is to be done and a side head is not available, or owing to the position of the work surface, not adapted, a relieving tool similar to the one shown in Fig. 410 can be made at a small expense. In this tool a stud projecting from the side of the shank carries a small tool holding collar, which can rotate on the stud until the stop A strikes the shank. A light spring S bears against the stop, allowing it and the tool to swing back from the work on the return stroke and bringing it back again for the beginning of the forward stroke. For finishing cuts at coarse feeds the broad nose-tool shown in Fig. 411 is used. The corners are slightly

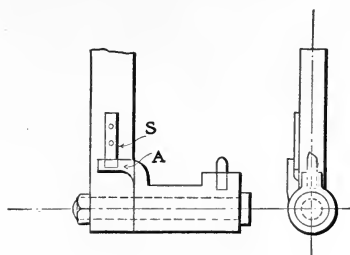

FIG. 410.

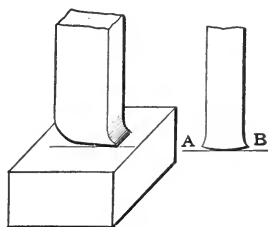

FIG. 411.

rounded, as shown at A, B, and the tool given only a slight amount of clearance, as shown.

The planer and shaper, when equipped with suitable attachments, are capable of a very wide range of what might be termed special tooling operations. An emery-grinding head is secured to the cross rail with suitable belted connections to drive its wheel and the planer table at the proper speeds, and the planer is converted into a very creditable plane grinding machine. This transformation, however, is not to be advocated, as the bearing surfaces of the planer are not properly designed for the protection necessary against the flying particles of emery. The conversion, however, into a plane milling machine is more commendable, as the planer when provided with suitable feeds for the table is fairly well adapted to milling work. In Fig. 412 is illustrated a device that can readily be attached to the cross rail of any planer, virtually converting it into a slab milling machine. The head of this attachment is so constructed that the spindle

can be swiveled from horizontal to vertical. As there are many operations that can be more advantageously performed by milling than by planing, an attachment of this kind will frequently be of value in cases where a slab milling machine is not available. In Fig. 413 is shown an attachment for planing concave or convex surfaces. It consists principally of a vise pivoted in suitable housings at the points O O. The arm S is a part of the vise

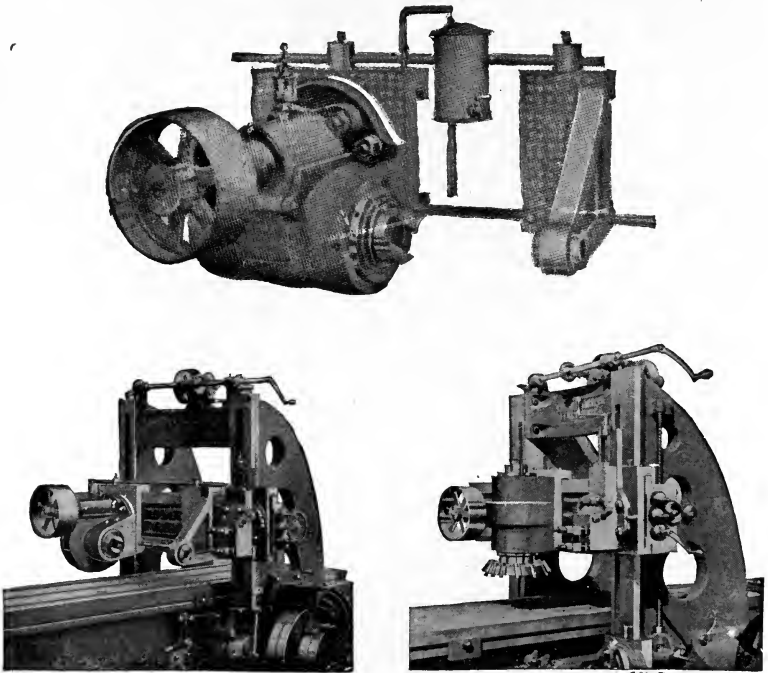

FIG. 412.

and carries within it a stud terminating in the guide R. The bar G G is secured at any desired angle with the table to the post P, which is fastened to the side of the planer bed. If G G is parallel to the work table the vise will have no motion relative to its housing. If the bar is set as shown in the figure the farther end of the vise elevates as the table advances to the cut and a concave surface results. By inclining the bar in the opposite direction, however, the end drops as the table advances to the cut and a convex surface results. The arc of the circle planed depends on the amount of the angle between G G and the table;

the greater the angle, the smaller the radius of the surface planed. With the bar G G removed the vise becomes an ordinary planer vise, possessing the additional advantage of being adjustable to

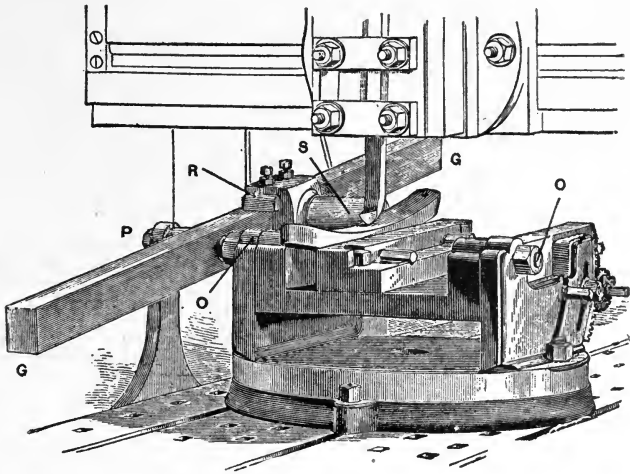

FIG. 413.

quite an angle with the work table, a point of value in the planing of wedges.

Planer vises are very necessary accessories to both the planer and shaper, as a considerable amount of planer, and more es-

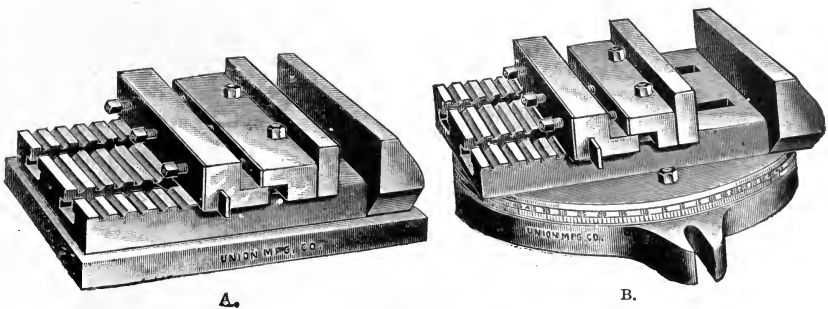

FIG. 414.

pecially shaper work must be held in the vise. In Fig. 414 are shown two forms of planer vises. The vise shown at A has a plain base, to be clamped in any desired position on the planer table. The adjustment of the movable jaw is clearly shown in the

figure. The vise shown at B is provided with a circular base usually fitted with two tongues to fit the wards or T slots in the planer table and thus insure its being put on at the same angular position with the line of the table's motion. The circular bottom of the vise is pivoted at the center of the base and provided with a graduated rim, thus making it possible to set the jaws at any desired angle with the table's length. In this vise blocking is used between the clamping screws and the movable jaw. It is quite necessary in any planer vise to have the movable jaw so secured that it can be clamped down closely to its seat, as otherwise the clamping of the work between the jaws will cause it to lift. The shaper vise is considered a regular shaper attachment, and is always furnished with the machine. The sliding jaw is always operated by a screw and gibbed to the body of the vise.

The attachment shown in Fig. 415 is a special tool for the

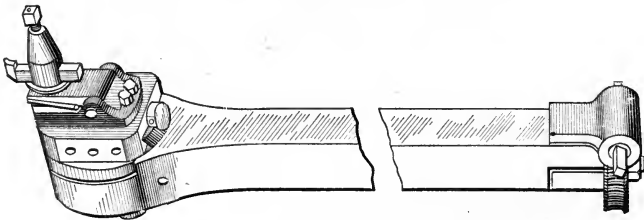

FIG. 415.

planing of circular surfaces, as, for example, locomotive driving boxes. Its range is comparatively small. The long shank is held in the regular tool clamps. The head of the attachment is pivoted at its center in the end of the arm and operated by a shaft carried in a recess in the back of the arm. A worm and worm gear at the upper end of the bar provides a suitable feed drive for rotating the tool. When a considerable amount of work is to be done with the attachment a suitable automatic feed can readily be applied to the worm.

The milling machine has taken most of the center work away from the planer. A pair of planer centers, however, an example of which is shown in Fig. 416, is frequently of great value. They are usually tongued to fit the wards in the table, and the head spindle is so indexed that the circle can be divided into a large number of equal parts.

In Fig. 398 is illustrated a number of shaper attachments. The one shown on the machine is for planing spirals. The spindle of the head is rotated back and forward with the strokes of the ram through a suitable geared mechanism operated by the up-and-down motion of the block over which the inclined guide (which is actuated by the stroke of the ram) slides. The work to be operated upon is held between centers, and as the upper section of the knee can be inclined, spirals can be shaped upon tapered work. The shaper vise is shown at the rear of the cut. Two small centers attached to the jaws, as shown, are frequently found very convenient. The vise wedges shown on the extended base of the shaper are pivoted at the center and are used against one of the jaws of the vise in holding tapered work.

In the front and on the left of the cut is shown a convex shaping attachment. This may be secured to the front of the cross rail in the place of the knee, and the feed attached to the geared feed mechanism shown, which gives the circular table, and such work as may be clamped on it, a rotating feed motion. This device can also be secured to the knee in a horizontal position for operating upon special work requiring the machining of radial surfaces.

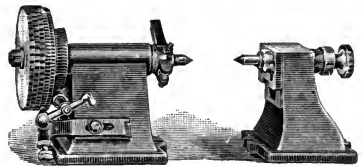

FIG. 416.

The circular attachment shown in the center of the foreground is provided with an arbor carrying two cones. Work having any bore within the limits of the cones can be held on the attachment, an automatic feed giving the work feed rotation. The index centers shown on the right are in principle similar to those shown in Fig. 416. They are, however, self-contained, both head and tail stock being secured on a suitable base casting, which in turn may be secured to the knee of the shaper. In Fig. 399 A is shown the circular attachment as used on the "Cincinnati" shapers. The spindle is driven by a worm and gear, either by hand, or automatically by the power feed mechanism shown. In Fig. 399 B is shown the automatic head feed used on this shaper. It is a positive acting mechanism, having a variable feed adjustment. The action corresponds to that used on the planer head feed, the short side shaft corresponding to the feed shaft in

the cross rail and the motion is transmitted to the nut by two pairs of miter gears.

Spiral planing attachments similar to the one shown in Fig. 398 are frequently applied to planers for the grooving of spiral rolls and work of that class. Another attachment for the cutting of spirals on the planer consists of a rack secured to the side of the planer bed at about the height of the surface of the work table. A pinion carried on a shaft running in bearings secured to the surface of the table and at right angles to its length gears with the rack. This cross shaft through a pair of bevel gears transmits its motion to a spindle parallel with the table's length and to which the work to be spirally planed is attached. The motion of the table causes the shaft, spindle and work to rotate at a rate determined by the velocity ratio of the gears.

A shaper is sometimes used for key seating bores. There is a vertical supporting knee attached to the table for holding the work, and a special head attached to the ram in place of the ordinary tool box. This head holds a cutter bar, which is in the form of a broach, and will cut the keyway at one stroke of the ram.

CHAPTER XXI.

PLANER AND SHAPER WORK.

The proper securing of work in the vise or on the shaper or planer table for planing operations is a most important step in the production of satisfactory work. As the variety of work assigned to these machines is great, the operator continually finds himself against a new problem requiring good judgment and care. In most cases much more skill is required in the setting up of the work than in the machining. When the work is compact and heavy, and the amount of metal to be removed is relatively small, the danger of springing it is not usually great. If, however, the work is large, of irregular shape or light, the danger of springing is great. The springing is due to two causes: First, by ununiform or severe clamping which distorts the work and throws the machined surfaces out when it is unclamped; second, the removal of the outer surface of a casting or forging, which frequently relieves shrinkage and forging strains and throws the work out of true. The first of these troubles can be overcome only by using the utmost care in setting up the work, and the second by, so far as possible, first roughing off all surfaces before taking any finishing cuts, thus allowing the work, after the roughing, to assume its normal condition as to strains.

The most important consideration in the clamping of work to the table is to locate the points of clamp pressure directly over the points of support. The supports should be firm and bear as equally as possible between the work and the table. When only a thin shim is required to level up the work, it should preferably be of metal, as cardboard, leather or any compressible material will allow the clamp to spring the work. Good blocks and parallel bars are indispensable in the planer outfit. For work where the points of support vary in height, leveling wedges and small jack screws are most excellent, as they can be quickly adjusted to any desired height. These leveling wedges, especially if a single wedge is used, should be made with only a slight taper. In Fig. 417 is shown a pair of these wedges. When carefully made they form a good support and may be used to make the fine adjust-



ment for height either directly on the work table or on top of other blocking. The planer jacks shown in Fig. 418 are most excellent, a few of these frequently replacing a large number of

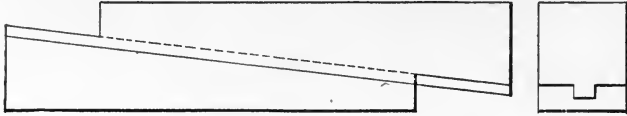

FIG. 417.

blocks of miscellaneous shapes and sizes. A good set of planer bolts should be found on each machine. Common machine bolts are not well suited to this purpose as the heads are too thick

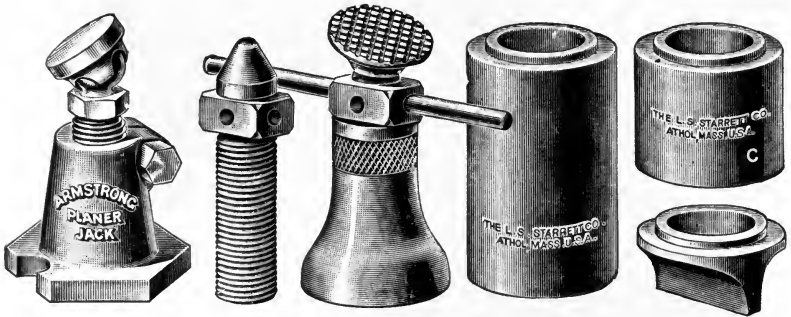

FIG. 418.

and not large enough to properly fill the T-slot. Planer bolts are preferably made of mild steel with heads turned to required thickness and milled on the four sides to properly fit the T-slot.

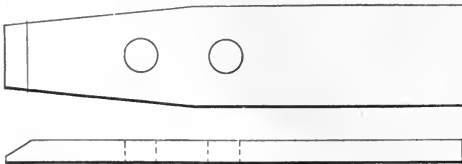

FIG. 419.

The clamp is usually made from a bar of flat steel with one or more holes drilled in it for the bolt, as shown in Fig. 419, and tapered somewhat on the work end to more readily enable it to

be placed in the corners of the work. The clamp shown in Fig. 420 is made from square iron and forms a substantial and convenient form of clamp. Clamps of this character should be applied to the work in the manner shown in Fig. 421, as closely as

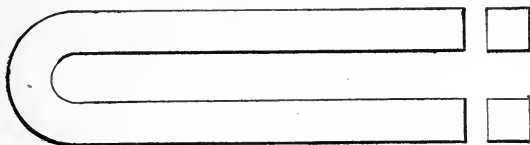

FIG. 420.

possible; that is, the bolt should stand close to the edge of the work and the blocking for the outer end of the clamp as far away from the bolt as convenient, thus throwing most of the bolt pull upon the work and not upon the blocking, as would be the

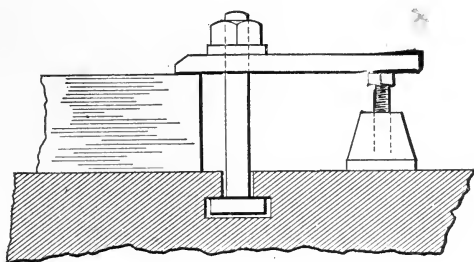

FIG. 421.

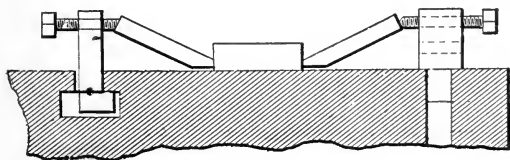
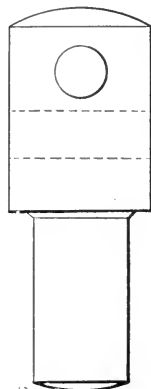
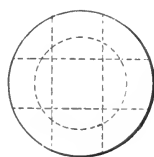

FIG. 422.

FIG. 423.

case if the bolt was nearer the blocking than the work. The T-slots should be sufficiently deep to prevent any reasonable bolt pull from breaking them out. This danger is, however, lessened

by placing the work or its point of support as close up to the bolt as possible.

If the entire surface of the work is to be machined, clamps as above described cannot conveniently be used as it would necessitate changing their position during the cut, a most delicate operation with results usually unsatisfactory if a true surface is required. When the work has considerable thickness, small lugs or flanges can be cast on the edges for holding the clamp point and in some cases a drilled hole in the edge of the work can be made to receive the point of the clamp. In cases where these methods are not convenient, the work can be held in the manner shown in Fig. 422. Two forms of post are shown in this figure, the one a plain pin to fit neatly in the round holes in the table and the other with rectangular base and tongue to fit

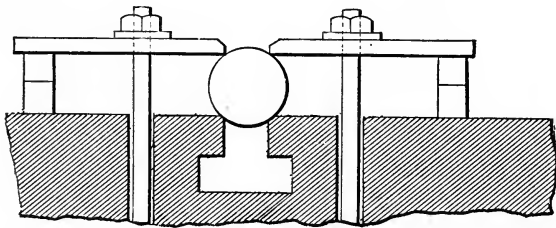

FIG. 424.

the T-slots. A common set screw with cone point fits any of the tapped holes in the post, the height of these holes varying to suit the thickness of the work and length of finger used. The fingers are cupped to receive the point of the screw and the work end pointed to engage a prick-punch hole in the side of the work or preferably formed flat as shown in the figure. A suitable post to receive the end thrust of the tool must in all cases be set ahead of the work, and should be made of steel, preferably a low grade of tool steel, to insure stiffness, and turned to fit neatly the holes in the table. It should extend well into the hole, but should not reach high above the table, from two to four inches being ample. The shorter it is, the less liable it is to get bent. In Fig. 423 is shown such a post. The two holes drilled through it at right angles to each other facilitate turning or prying it up, when, from any cause, it may stick too tight in the hole to be pulled out with the fingers.

Round work may be held as shown in Figs. 424 and 425. In Fig. 424 the bar rests on the edges of the T-slot. In this case the edges should be in good condition. It is suitable for bars of small diameter only, while with the method shown in Fig. 425 where a knee plate is used a bar of any diameter can easily be held.

A pair of V-blocks can be used very advantageously for hold-

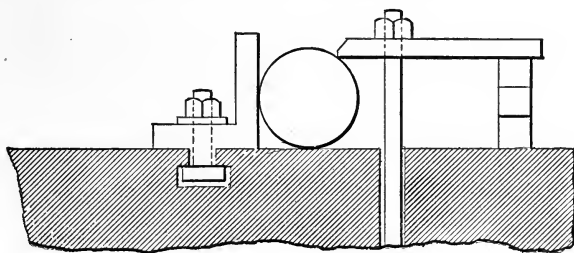

FIG. 425.

ing round work. These blocks as shown in Fig. 426, should be tongued to fit the wards in the table and the V-notches planed with the blocks in place.

A good knee plate is frequently quite necessary in the securing

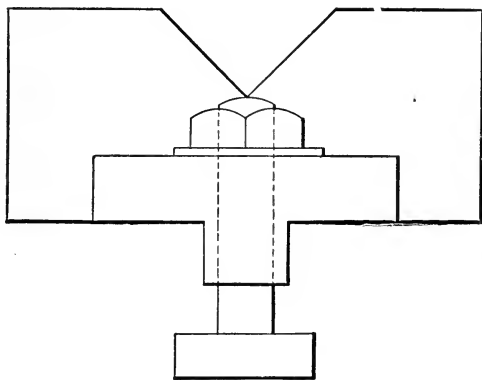

FIG. 426.

of work on the planer table. The regular knee on the shaper, however, serves the purpose on that tool.

On long work the twisting, and deflection due to the weight of the work itself, must, where accuracy is required, be taken carefully

into consideration. For example, long lathe and planer beds must in the machining be handled with great care. Take a lathe bed that is to rest upon legs at each end. It should have the seats upon which the legs are bolted planed first, the points of support being not at the extreme ends but at points about one-fourth the bed's length from each end, with wedges so adjusted as not to twist the bed in its length. After planing the leg seats the bed can be turned over and clamped directly on these seats, the bed assuming its natural deflection, in which position the shears are planed.

In securing work in the vise, the pressure of the jaw against the work should be as uniform along the surface gripped as possible. If the surface is somewhat irregular a soft packing, as paper or leather, will equalize the pressure. If there is much irregularity, however, it is preferable to cause the vise jaws to grip the work at points rather than throughout their entire length. For this purpose a wedge or solid block should be used between the work and jaw and located as near the ends of the jaws as possible. When a jaw is tightened onto the work its tendency is to lift, causing the work to lift on the movable jaw side. For this reason the movable jaw should be fitted nicely to its slide with bolts, as previously shown in Fig. 414, for clamping it firmly after gripping against the work. Planer vise jaws are usually made of cast iron, and a false facing of soft steel secured with bolts to these jaws is excellent when finished surfaces are to be gripped between them. It is important for nice work to keep the vise jaws in good condition.

The leveling and squaring up of work on the planer table is important. If the work has been laid out or some of its surfaces previously machined, the surface gauge will be used in bringing these lines or surfaces parallel with the table. If a line on the work is to be set parallel with the line of motion of the table, the surface gauge needle point will be adjusted to the line at one end with the base of the gauge against the side of the slider. The table is then moved under the cross rail and the other end of the line brought to coincide with the point of the needle. Another method is to square up from lines that have previously been planed with a fine sharp-pointed tool in the top surface of the table, and with the caliper divider caliper from the blade of the square to each end of the line on the work; or, if this line is not too far from the edge of the planer table, the calipering may be

from the line to a straight edge placed against the side of the work table. When the line on the work surface is to be set at right angles to the length of the bed, the work is brought close up to the cross rail and the line adjusted to the surface gauge needle point, with the base of the gauge resting against the face of the cross rail; or, as in the other case, the caliper divider with a straight edge placed against the face of the cross rail can be used.

In the manipulation of the planer and shaper the beginner should keep a few points closely in mind. All planers and geared shapers do not have a fixed length of stroke, the depth of the cut and the speed of the countershaft affecting slightly the points at which reversals take place. Some allowance must therefore be made for the overtravel of the tool. An excessive amount of overtravel, however, means a large loss of time. Roughing cuts should be as heavy and at as coarse feeds as the machine will conveniently handle and the strength and character of the work will permit. Before planing side surfaces see that the top of the tool box is inclined from the work. This allows the tool to swing out and clear the work surface on the return stroke. If it is not inclined the point of the tool drags hard on the work surface, and should it be inclined to the wrong side the tool will swing into the work, doing much damage. Raising the tool clear of the work on the return stroke preserves the cutting edge. Means for automatically accomplishing this are frequently employed. Keep the cross rail clamped firmly to the housings when in use and parallel with the table. Before putting in the feed see that the feed gear is on the right spindle, as otherwise the tool may start up or down when it is intended to move across the work. As there are usually more ways than one to do every piece of work, study the way in which it can best be done. The manner in which the work is set up, the kind of tools used and the way in which they are ground, as well as the efficient handling of the machine, all have an important bearing on the quality and amount of the work turned out.

CHAPTER XXII.

THE SLOTTING MACHINE AND KEY SEATER.

The slotting machine is illustrated in Fig. 427. It consists primarily of a substantial frame, a tool-carrying ram and a table for supporting the work. While the plane of the table is the

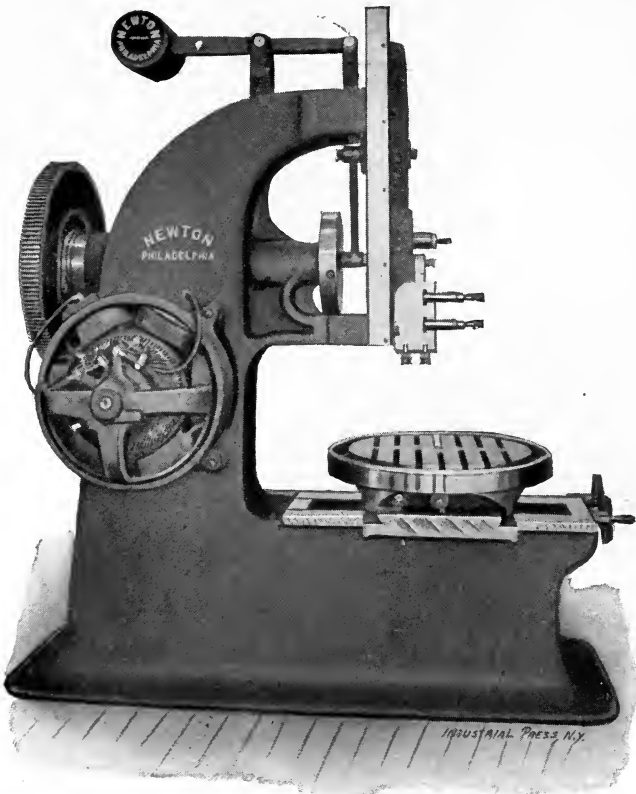

FIG. 427.

same as on the shaper, the ram moves in a vertical plane, thus adapting it to work in which surfaces at right angles to other surfaces are to be machined. The table which is provided with feed rotation is mounted upon a slider and this in turn upon a

saddle gibbed to the knee of the machine, thus providing a work table that may be rotated or moved to any position in its plane relative to the cutting tool and within the capacity limits of the machine.

The slotter is very largely used for the cutting of key ways in hubs and the machining of rectangular, circular or irregular outlines which cannot readily be done on shaper, lathe or milling machine. In Fig. 428 is shown a piece of work well adapted to the slotting machine. The surfaces *a*, *b*, and *c* can be machined on the slotter more advantageously than on the planer or

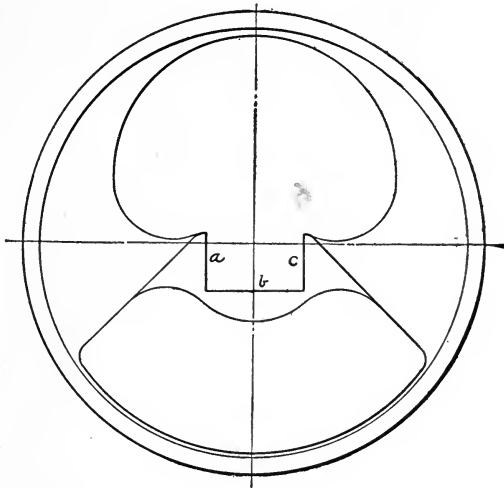

FIG. 428.

shaper, as the side rests solidly upon the table and the form of the slotting tool is adapted to the job. On planer or shaper a knee plate must be used to clamp the work to, and an extension tool employed.

The half boxes used on locomotive driving axles as shown in Fig. 429 illustrate another slotter job. Here the cylindrical bearing surface is machined by placing the work concentric with the work table. The table is so placed with reference to the tool that the necessary amount of rotation can be obtained without interfering with the tool or head. After each downward or cutting stroke the table is automatically rotated the necessary amount of feed for the next cut. By using a fine feed and a properly

formed cutting edge on the tool very smooth true surfaces result. Connecting-rod ends and crank eyes are advantageously machined on the slotter.

The tools for the slotter are either forged on the end of heavy square bars of steel or inserted in steel bars of either square or round section. When forged the tool is usually of the form shown in Fig. 430. The cutting angles are the reverse of those of lathe and planer tools. The end angle turns the chip and is the angle of rake with x as the angle of clearance. As with planer tools the angle of clearance should be small in order to prevent the tool from chattering and digging into the work. The

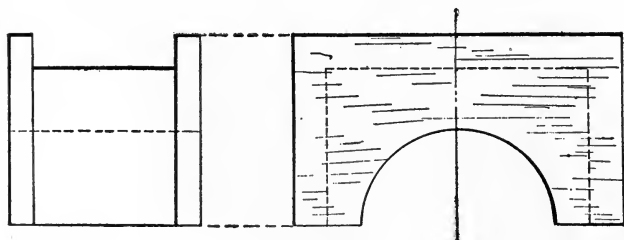

FIG. 429.

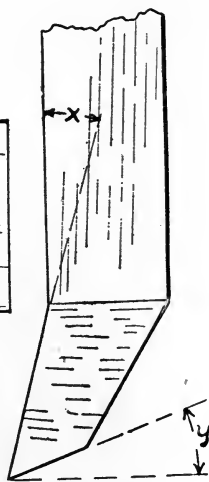

FIG. 430.

angle of rake y should be as great as the hardness of the metal operated upon will permit.

For squaring out corners a tool similar to the diamond point is usually used. By properly indexing the rotating table spur and internal gear may be cut on the slotter, using a cutter of the correct tooth space outline.

The key seater is an outgrowth from the slotting machine, and although designed for cutting key ways only, will, when provided with suitable attachments, perform various classes of slotting machine work. A standard key seater is shown in Fig. 431. A cutter bar is operated by a crank motion in the base of the machine, similar to the drive on a slotting machine. The

upper end of the bar is supported by a suitable overhanging arm. The work table upon which the pulley or gear to be key-wayed is supported may be tilted the necessary amount to give the required taper in the key way, and is also capable of a slight in and

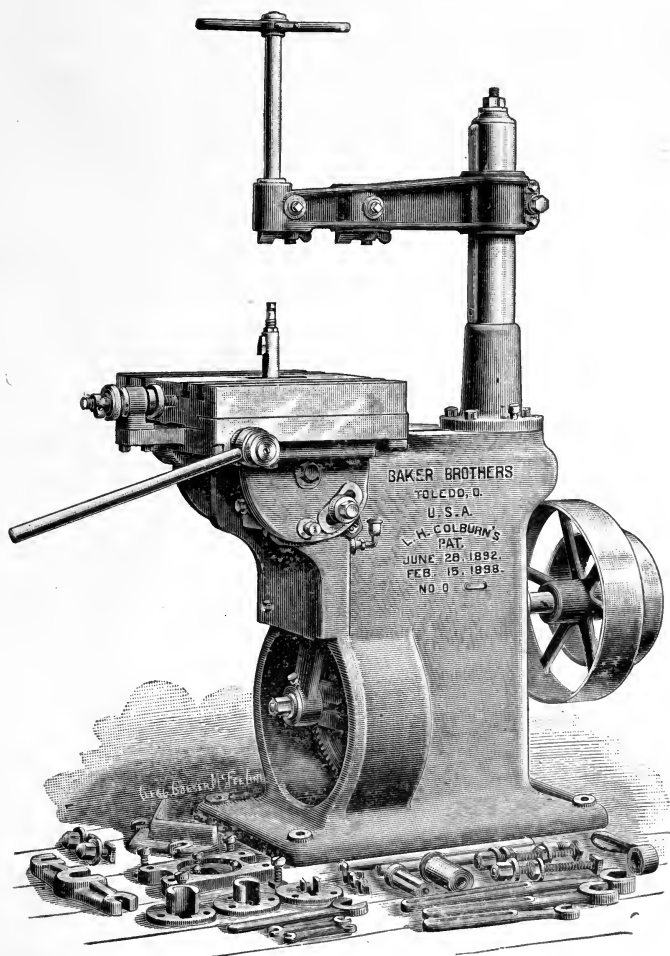

FIG. 431.

out motion, independent of the feed which advances it to the cutter. This motion is necessary in order to clear the cutter from dragging on the return stroke.

The form of cutter used on this machine is shown in Fig. 432

and the bar in which it is held in Fig. 433. These cutters are ground from the bottom only and should be kept sharp. The work is centered to the bore by suitable bushings. The feed screw is graduated to thousands and provided with a stop nut, which

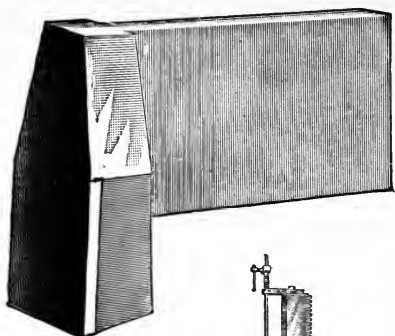

FIG. 432.

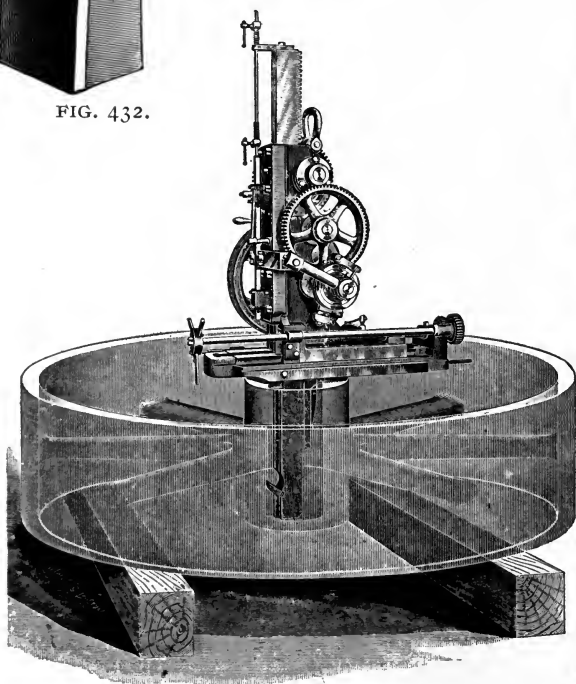

FIG. 434.

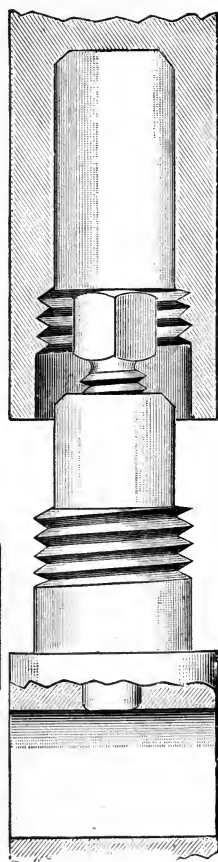

FIG. 433.

enables any number of bores of the same diameter to be keywayed to the same depth.

For a great deal of special work a cutter bar of rectangular section can be conveniently used. In such a case the width of the cutter should exceed the thickness of the bar which allows the

cutter to work out square corners. For the cutting of external key-ways in short shafts and spiders the key-seater is excellently adapted.

For the key-seating of very large, heavy work portable key-seaters are used. In Fig. 434 is shown a Morton portable machine operating on a large pulley. These tools are made in four sizes, ranging from 24 to 72 inch stroke. They are virtually draw stroke shapers without columns. They are operated either by a rope transmission or electrically, a motor in the latter case being attached directly to the machine.

CHAPTER XXIII.

MILLING MACHINES.

The milling machine and its great popularity are due to the peculiar adaptability of the rotating cutter to the machining of plane and irregular surfaces on such a wide variety of work. The variety of work that the milling machine is capable of performing is much greater than can ordinarily be accomplished on the planer or shaper. In thoroughly familiarizing himself with these machines the mechanic has much more to learn as to settings and manipulation in the milling machine than in the planer and shaper. With the latter machines, however, more skill is required in the manipulation for the production of accurate work than with the former. This arises from the fact that on the planer all measurements must be separately made, inasmuch as the cutting tool generates the profile of the work by a series of parallel cuts, all changes in plane of the profile requiring separate adjustments and measurements. With the milling machine, however, the cutter is so formed as to generate the full profile of the work surface as the cutter advances, setting measurements alone being necessary. With the planing machines the accuracy of the work depends very largely upon the personal skill of the operator, while with the milling machine the accuracy of the cutting tool has much to do with the quality of the work. With the milling cutter and the work once set, the accuracy with which a certain work-surface profile can be produced upon one or more pieces depends wholly upon the wear on the cutting edges of the cutter. As the cutters are usually formed with a number of teeth, the work is divided up among these teeth, reducing the wear upon them. This is not only because each unit of length of each tooth performs only a small portion of the total work as compared with the cutting edge of the planer tool of unit's length, but because that particular portion of the tooth is performing work for only a small portion of each revolution, thus giving it an opportunity to cool and recover before each time it comes in contact with the work.

The advantage of the milling machine over the planer lies very largely in its ability to produce, with reasonable accuracy, a large

number of duplicate surfaces, the formed cutter and removal of the personal error in the making of measurements by the operator being the factors that enable it to produce these results. For the producing of many plane surfaces, and especially on work that is not to be duplicated, the milling machine possesses no advantage over the planer and shaper. Its advantages for certain classes of work, however, are great, as illustrated, for example, in Fig. 435. This shows a milling gang cutter made up of seven cutters and capable of producing at one traverse over the work a profile that, if produced in a planer, would require no less than eleven separate measurements, aside from the working out to line of the curved portion. It is only after the operator has become skilled in its use and thoroughly familiar with its every detail that he can appreciate the great capabilities of this class of machine tools.

When used as a manufacturing tool, producing large numbers

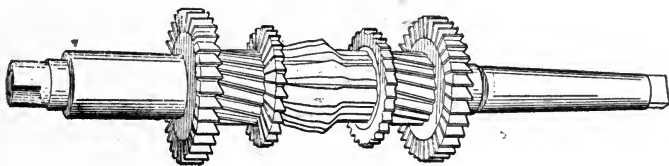

FIG. 435.

of duplicate parts, the results obtained from the use of the milling machine lies almost wholly in the intelligent selecting of proper cutters and fixtures for each special operation and when once set does not require highly skilled labor to operate it. When used as a jobbing machine, however, the operator should be quick and skillful to obtain good results.

The plain and universal milling machines of the column pattern are most extensively used for general shop purposes. In Fig. 436 is shown a universal machine of this pattern. The column and knee resemble somewhat the same parts in the shaper. The upper portion of the column carries the spindle and cone, the spindle on all other than the smallest sizes being back-gearred in precisely the same manner as on the lathe. The outer end of the spindle is always supported by a suitable overhanging arm. The work table is adjustable in and out from the face of the column and vertically, these adjustments being made by screws

with operating handles conveniently placed and moving over dials graduated to measure the amount of table movement in thousandths of an inch. The knee is gibbed to the face of the column and, in the universal machine, the work table is gibbed in a swing frame which pivots to a slider which in turn is gibbed to the upper face of the knee. Through the office of the swing frame the table can be set at an angle from its right-angle position with the cutter spindle. In some machines the table can be carried through a complete revolution, while with others the range is limited. The table is provided with a longitudinal feed automatically operated in either direction. An automatic

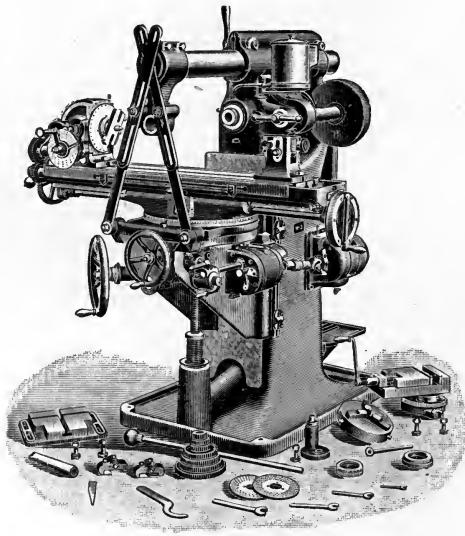

FIG. 436.

in-and-out and up-and-down feed may also be applied when desired. The feed mechanisms are so designed as to give a wide range of feeds. The universal head, to be described hereafter, may be geared with the longitudinal feed screw for the cutting of spirals. The plain milling machines of the column pattern are similar in design to the one shown in Fig. 437. In this type of machine the work table is gibbed directly to the slider and its line of travel restrained entirely to one at right angles to the spindle. The universal head and tailstock of the universal type are omitted, plain dividing centers usually being used on these

machines. The work table is somewhat larger on the plain than on like sizes of the universal machine. The plain machines are preferable for plain milling work, as they are somewhat more rigid and simpler in construction.

For tool room work the universal column pattern machine stands at the front. As probably more than 95 per cent of the milling work outside of the tool room is plain milling, we find the plain machine much in favor for general work. Although the column pattern is generally conceded as the proper style of design for the universal machines, such is not always the case for plain

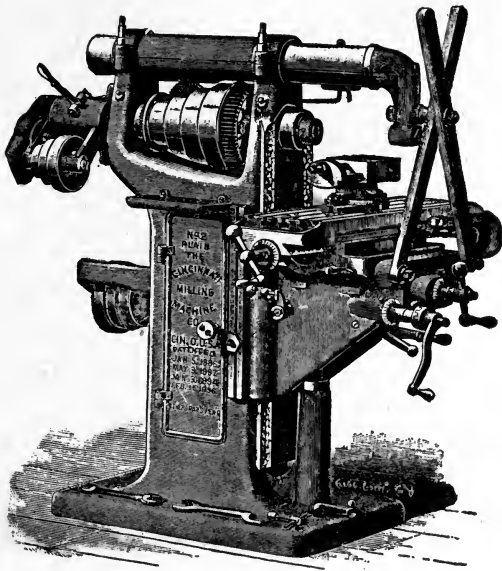

FIG. 437.

machines, inasmuch as a great part of the plain milling runs into larger and heavier work. We therefore find plain milling machines built along entirely different lines, especially when used for the plainest and heavier classes of work. In Fig. 438 is shown a form of plain machine commonly known as the Lincoln pattern. It is an exceedingly simple form of machine, yet very efficient on certain classes of work. The outboard support, for the spindle, together with the form of the bed, makes a rigid machine. The driving cone is mounted on the back side of the main

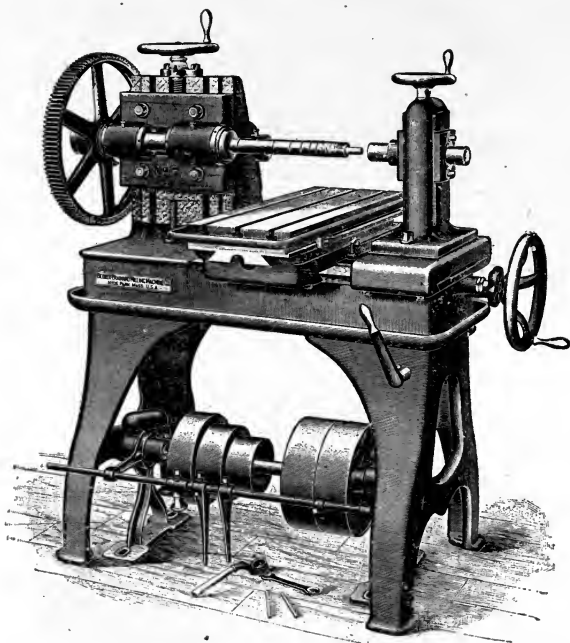

FIG. 438.

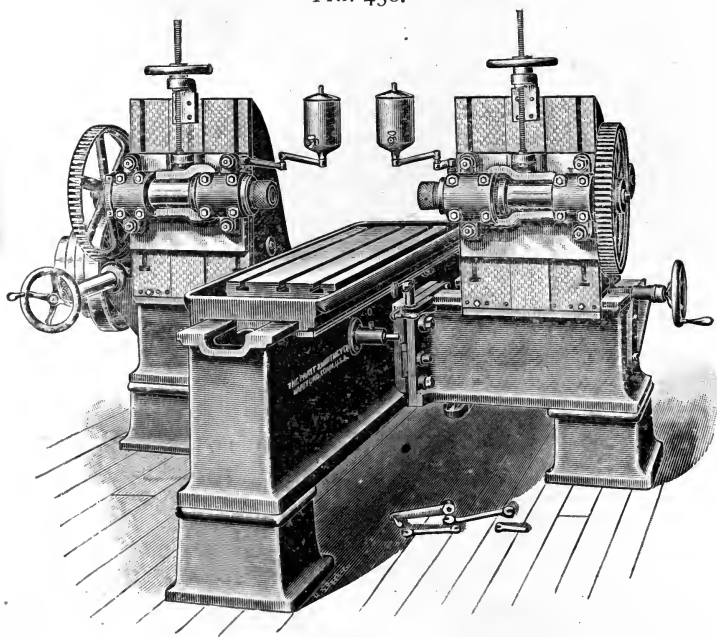

FIG. 439.

upright, driving the spindle through a pinion and gear connection. As the vertical adjustment is in the spindle itself instead of in the work table, a suitable tightener is employed for keeping the belt tensions correct for all positions of the spindle. The work table is given the usual automatic feed under the spindle and suitable lateral hand adjustment. In Fig. 439 is shown a form of plain milling machines somewhat similar in appearance to the one shown in Fig. 438. The design, however, provides for a

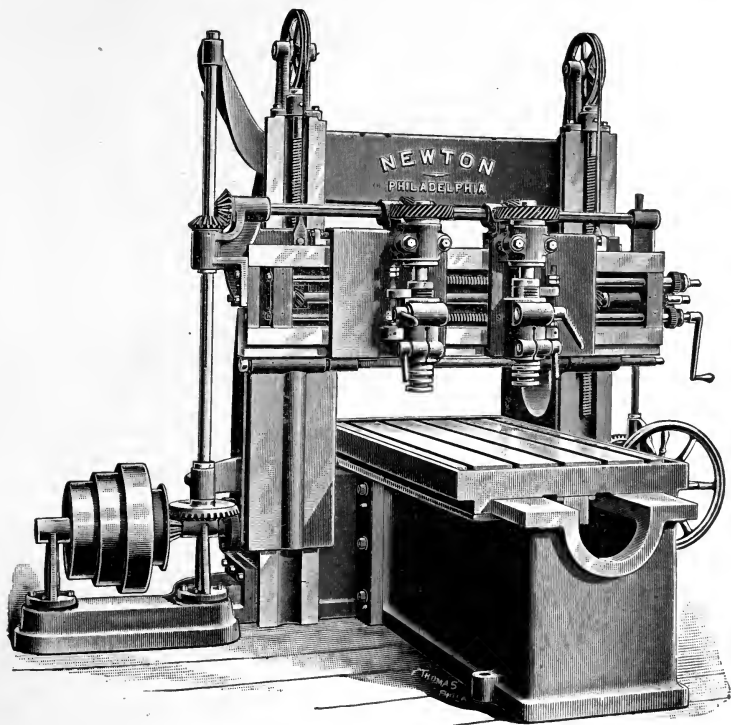

FIG. 440.

larger work table and the machine shown has two heads, making what is usually termed a duplex miller. Machines of this class are well suited not only to the use of plain or axial cutters, but to the radial or end cutter. Thus on the double-head machine of Fig. 439 two radial cutters may be used at the same time on opposite sides of work secured to the table; or one axial cutter can machine the upper surface while a radial is working on the side.

Fig. 440 illustrates what is known as a slabbing milling ma-

chine. It resembles in appearance a planer, is a massive, powerful machine, and in the form shown carries a large slabbing cutter for removing heavy cuts at coarse feeds from the work. These machines are also provided with horizontal spindles which can be operated with or independently of the vertical spindles. In this case the horizontal spindle bearings are carried on the front faces of the housings. The vertical spindles usually carry

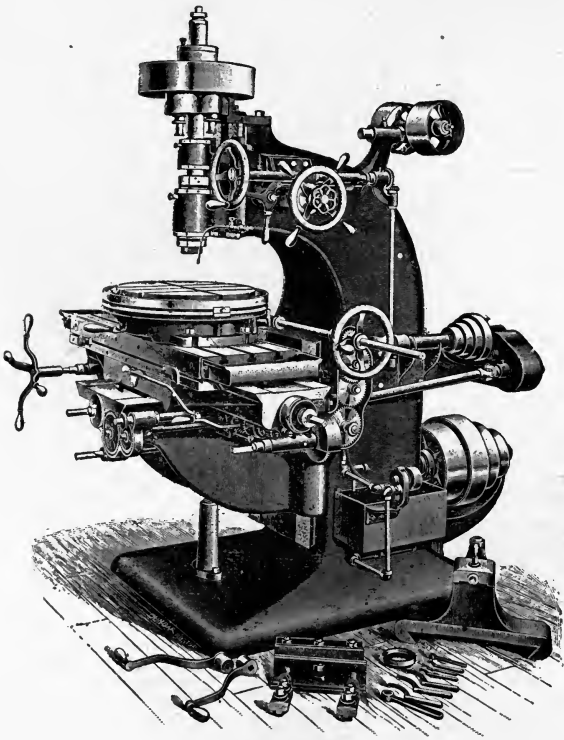

FIG. 441.

radial mills. The advantage of the radial mill over the axial cutter lies in the fact that in forcing it to its cut the pressure is mostly in the direction of the line of the feed and not at right angles to the surface being machined, thus overcoming most of the springing in the work that occurs or tends to occur in the use of the axial cutter. The radial cutter, however, does not leave as smooth a surface as the axial, but this disadvantage is, on a great

deal of work, more than overbalanced by the greater accuracy obtained.

In Fig. 441 is shown a well-known vertical milling machine intended for such general work as can be more advantageously performed by a cutter operated in a vertical spindle than by one on the horizontal spindle pattern machines. This machine in many respects resembles the regular column pattern machines with the column carried upward and out over the table an amount sufficient to bring the spindle into the vertical position.

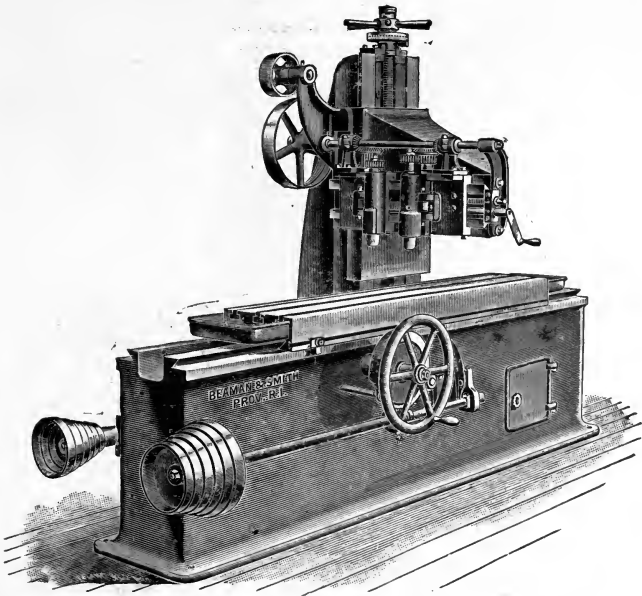

FIG. 442.

The vertical spindle brings the cutter more directly under the sight and control of the operator than when cutters of the radial class are used in the horizontal spindle machines. This type of machine also has the advantage of a circular feed by which a circular table, upon which work is placed, may be given a rotary motion. Thus a class of work may be performed that would otherwise require the use of formed tools in the lathe, and it can be done more quickly than in the lathe.

Another form of vertical spindle milling machine is shown in Fig. 442. This machine is designed for longer and heavier

work than the one last mentioned. The spindles are carried on a radial arm, thus providing a cross adjustment to the spindle rather than the table.

In Fig. 443 is shown a pattern of vertical milling machine, more commonly known as a die sinking machine and used for

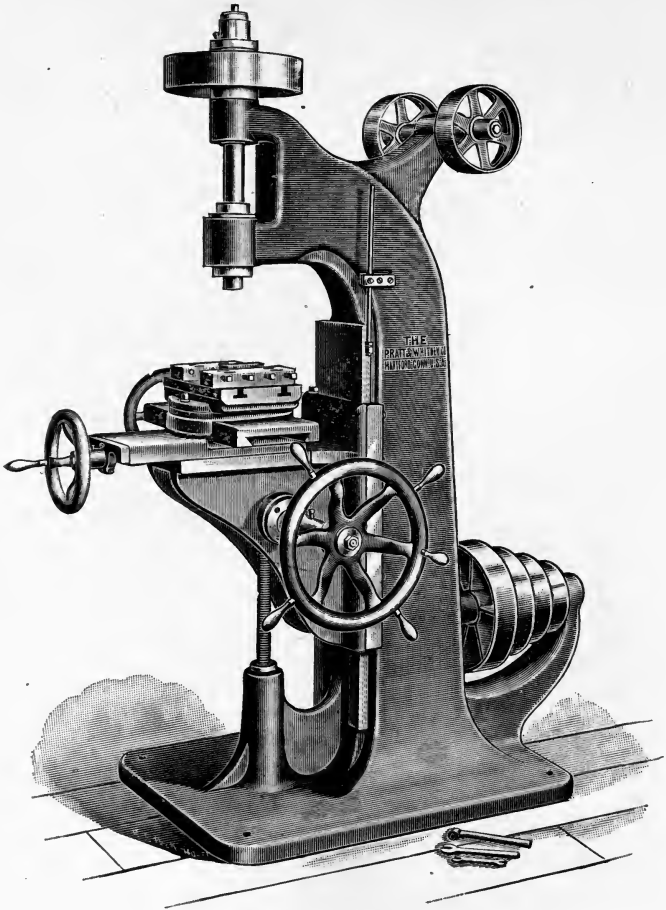

FIG. 443.

recessing of circular or irregular shapes, as dies for drop presses. The work to be operated upon is held in a vise, which may be moved in all directions by means of compound table slides. The knee is adjusted vertically by the screw and large hand wheel shown. Cutters of small diameter are used and the belted

spindle drive gives a smooth steady motion to the cutter. Where a number of similar pieces are to be operated upon a pattern is usually used for guiding the work to the cutter.

For the milling of very light pieces, as sewing machine or gun parts, for example, a light lever feed machine is much more convenient than the heavier pattern tools. The speeds are better adapted for the small diameter of cutters used and the quick table movement makes it possible to turn work out very rapidly. A machine of this character is shown in Fig. 444.

The feed mechanism differs quite widely on machines by different builders up to the point of the connection with the work table. At this point one of two systems is invariably used—the screw or the rack feed. With only a few exceptions the screw feed is used on the plain and universal machines of the column pattern. On the heavy slabbing and duplex machines the rack feed is usually employed. The rack feed furnishes the best form for a quick movement of the table, but possesses the disadvantage of allowing the table and work to draw under the cutter in cases of accident or carelessness on the part of the operator. With the screw feed the table can be moved only by the rotating of the screw. A quick-gear return to the table is usually applied to the screw-feed machines.

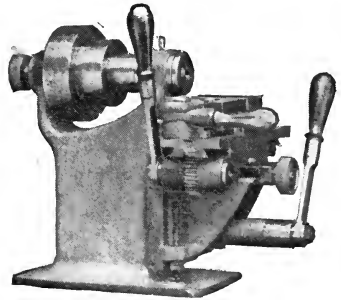

FIG. 444.

The work table is provided with T-slots for holding the clamping bolts and fixtures. The table is gibbed to the bed to prevent lifting and usually moves in flat or angular guides. The overhanging arm is usually made of the style shown in Fig. 436, which enables it to be used to receive and support the several special attachments made to be used in connection with machines of the column pattern. Suitable ties are now furnished with most makes of milling machines connecting the outer end of the overhanging arm with the knee, which adds much to the rigidity of the table and spindle when heavy cuts are being taken.

A comparatively wide range of feeds to the table of the milling machine is considered quite important and especially

so on the back-gearred machines where the variation of the size and speed of cutters is considerable. This range of feed is usually accomplished by means of stepped pulleys, gearing, or a combination of the two. Thus a pair of four-step pulleys will give four changes of speed and if these pulleys are of different sizes, by transposing them on their spindles four more changes may be obtained.

The power of the feed mechanism must be sufficient to pull the feeds under all conditions, and convenient in changing from one rate of feed to another. The importance of being able to make quick changes may be illustrated in the case of large diameter end or radial milling cutters operating upon wide work. The rate of feed on entering and leaving the work can be materially greater than when the cut is operating on the full width of the work. If the cuts are comparatively short the time saved by entering and leaving the work on quicker feed is of material importance.

On machines other than the smaller sizes, automatic in and out and vertical power feeds are usually provided.

The all-gear feed mechanism used on the Cincinnati milling machines is shown in detail in Figs. 445 A and B and 446 A and B. By means of the sliding gear in the upper gear box, two changes of speed are given to the vertical shaft for each speed of the spindle. The vertical shaft through the pair of lower bevel gears drives the two feed gears which in turn drive the two feed cones which run loose and independent of each other on their shaft. The large feed gear meshes with the small gear on one cone and the small gear meshes with the large gear on the other cone.

The intermediate gear by means of a suitable mechanism may be made to gear with any one of the cone gears, thus giving a wide range of feed changes. In changing feeds the upper lever, 446 A, is placed in the extreme left-hand position. This throws the intermediate gear, Fig. 446 B, back an amount sufficient to clear the cone gears. By placing the lower lever in position indicated for the desired feed, the intermediate gear will be placed opposite the proper gear on the cone.

Moving the upper lever to the right engages the gears. The variations in the rate of feed obtained give nearly a uniform progression.

The dividing or universal head is the part of the universal

machine with which the beginner usually has the most trouble in familiarizing himself. A dividing or indexing head in its simple form, and as usually used on the plain milling machine, is shown in Fig. 447. With the tailstock shown it comprises what is commonly known as a pair of index centers. Suitable lugs on the bottom fit neatly in the neck of the T slots in the work table, thus preserving the alignment of head and tail spindles. The head spindle is capable of rotation only. It carries

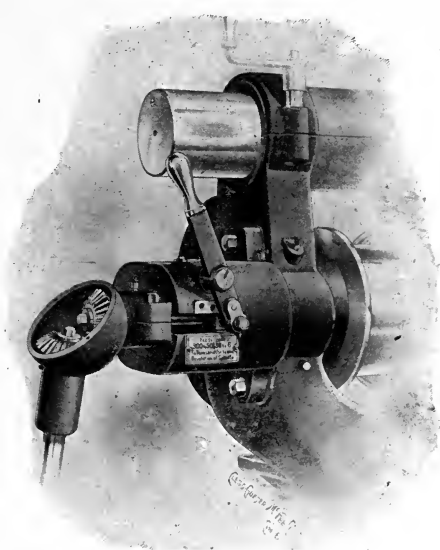

FIG. 445A.

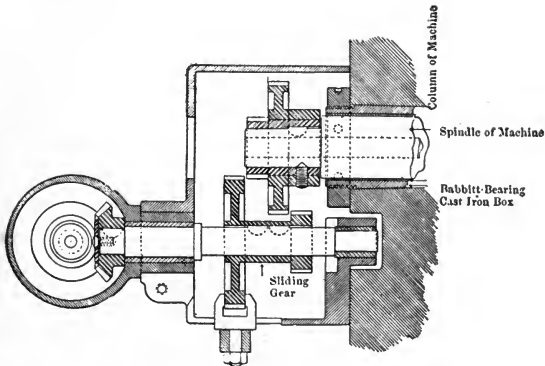

FIG. 445B.

a worm gear which is operated by the worm and crank shown. The ratio between worm and gear is, on all indexing heads, one to forty. In the one illustrated there are 80 teeth in the gear and a double thread on the worm. It is therefore necessary to make 40 turns of the crank and worm to make one turn

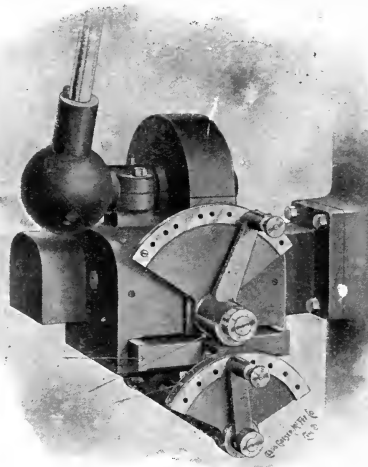

FIG. 446A.

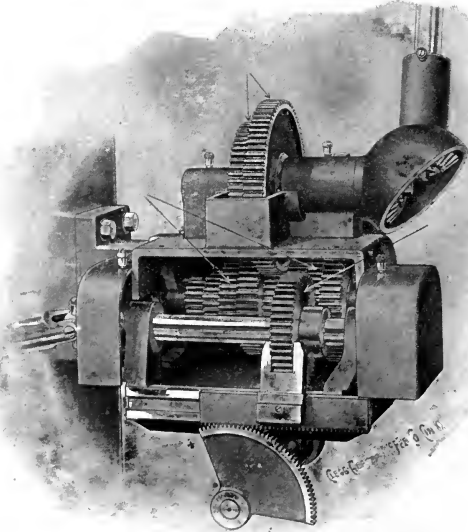

FIG. 446B.

of the gear and spindle. The crank moves over a carefully-divided dial which is secured to the head. A small pin, adjustable radially in the crank, may be set to engage in the holes of any of the circles. As it is not desirable to have the index plates too large in diameter or the holes too small, several plates are necessary in order to get the range of divisions usually required. With the one shown three plates are finished, making all divisions up to 50, all even divisions to 100, with many of the uneven divisions between 50 and 100, and many even and uneven divisions above 100. The sector serves to assist in counting the number of spaces between the holes and can be adjusted to include any desired number of spaces between its two radial arms.

As much of the miscellaneous dividing work done on an

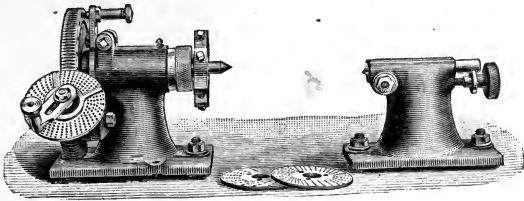

FIG. 447.

index head is for 2, 3, 4, 6, 8, 12 and 24 parts, a more rapid means of obtaining these divisions than by turning the worm is frequently applied. In the centers shown, there are 24 holes, equally spaced, in the face of the worm gear, with a substantial pin arranged to engage in them. When dividing by these holes the worm is dropped out of mesh with the gear.

The universal head is a more complicated piece of mechanism. In Fig. 448 are shown side and end sectional views of the Brown & Sharpe universal dividing head. A side view is shown in Fig. 449. The worm gear B is attached to the spindle, and a side shaft carries the worm A.

The spindle head is mounted in a suitable housing and can be elevated through an angle of 90 degrees and firmly clamped in any position. The spindle may also be depressed through a few degrees. The universal head, as made by some builders is capable of spindle settings at any angle within 0 and 180 degrees.

When used for plain indexing the worm can be disengaged

from the spindle gear and the required division obtained by means of the index plate C, which is locked in position by the pin D. As only a limited number of divisions can conveniently

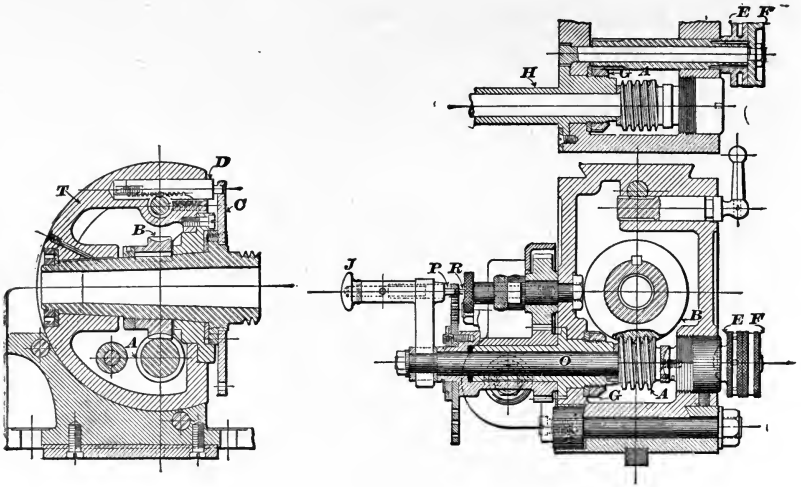

FIG. 448.

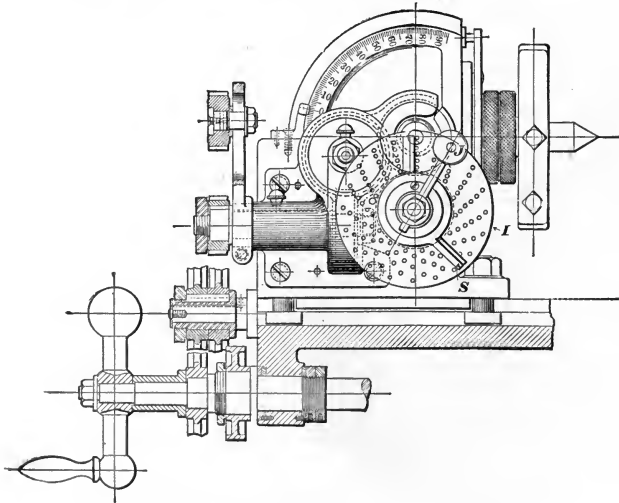

FIG. 449.

be obtained in this way, the usual method is by means of the regular index plate I.

The crank J is secured to the worm shaft, and the sector S is

held by a spring between the dividing plate and the crank with just enough friction to keep it in position when set.

The sleeve to which the index plate I is secured, carries a gear on its inner end which meshes with another gear on the axis R and about which the head rotates in setting to different angles. This latter gear meshes with a third gear on the same axis and secured to the upper of a pair of spiral gears, which transmit the motion from the train of gears leading from the table feed screw. A post may be drawn out from the head and caused to engage in a suitable notch in the back of the plate, or, in cases where the holes are drilled through the plate, in one of

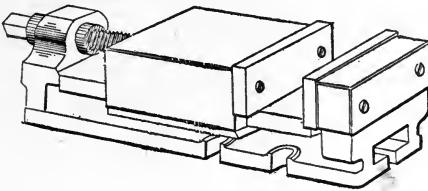

FIG. 450.

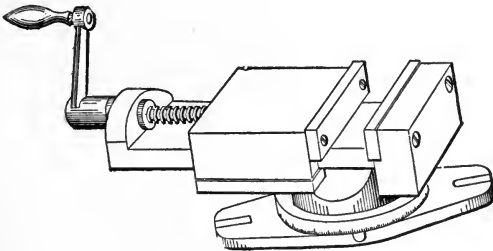

FIG. 451.

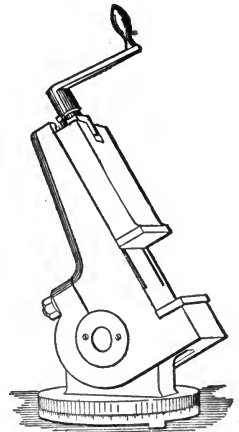

FIG. 452.

the holes. This secures the dividing plate from rotation and divisions on the spindle are obtained in the same manner as described above. When it is required to rotate the spindle while the work is being operated upon by the cutter, as is the case in the cutting of spirals, a geared combination between the worm spindle and the table feed mechanism becomes necessary.

The milling machine is capable of receiving a large variety of attachments for performing special operations, or regular operations with greater facility than can be had with the machine in its standard form.

The vise is a regular attachment on all universal machines

and plain machines of the column pattern. It is of two standard forms; plain, as shown in Fig. 450, and swivel as shown in Fig. 451. The plain vise is provided with tongues to fit the wards in the work table and can be readily set with the jaws parallel with or at right angles to the spindle. It cannot, however, be conveniently set at any other angle. The swivel vise has a graduated base resting on a plate which is tongued and bolted to the wards in the table. The swivel vise is very convenient for angular milling. A special tilting vise shown in Fig. 452 is, with its tilting jaws and swivel base, well adapted to the milling of a large variety of angular surfaces. In all milling machine vises the movable jaw is accurately fitted and gibbed to the body, and the jaw faces, which are usually made of soft steel, are secured to the jaws by means of screws. The surface of the jaw faces should be kept true and smooth, as they will then hold finished work surfaces true for the cut and without injury to the work. Extra jaw faces hardened and with roughed surfaces may be used for holding forgings, castings and rough work. For the holding of special and irregular work special formed jaw faces may be substituted for the regular ones.

As the universal dividing head is a part of the universal milling machine, it is not considered as an attachment. The plain index head already described under Fig. 447, however, is strictly a milling machine attachment. A first-class, three-jawed universal chuck fitted to the spindle of the index head is a very necessary accessory to the machine, as much of the work to be operated upon can or must be held in the chuck.

The vertical spindle milling head shown in Fig. 453, when applied to the plain or universal machines, converts them into vertical spindle machines. These heads are supported on the overhanging arm, and the nose of the spindle bearing. The vertical spindle is driven from the main spindle by bevel gears. A graduated index enables it to be set at any desired angle from the vertical, thus making it possible to mill many angular surfaces with a plain end or shank milling cutter. These attachments are very convenient for the cutting of T-slots, key seating and profiling, as well as angular work. Another attachment, termed a universal milling attachment, is shown in Fig. 454. This has in addition to the vertical spindle an auxiliary one at right angles to it and driven from it by means of spiral gears. With this auxiliary spindle set parallel with the surface of the

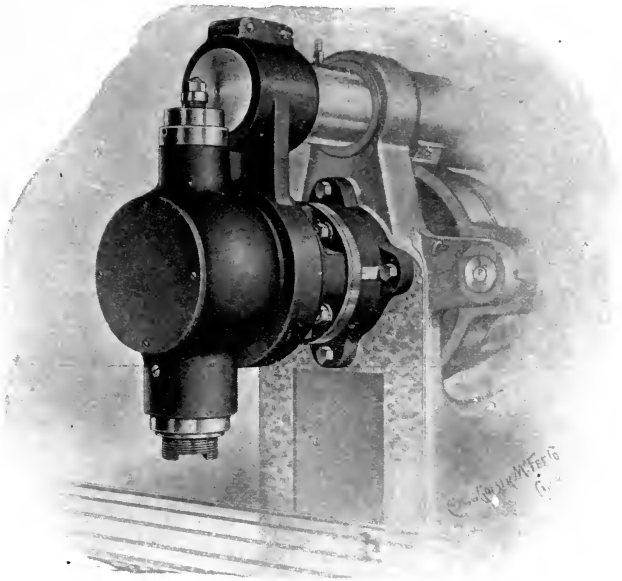

FIG. 453.

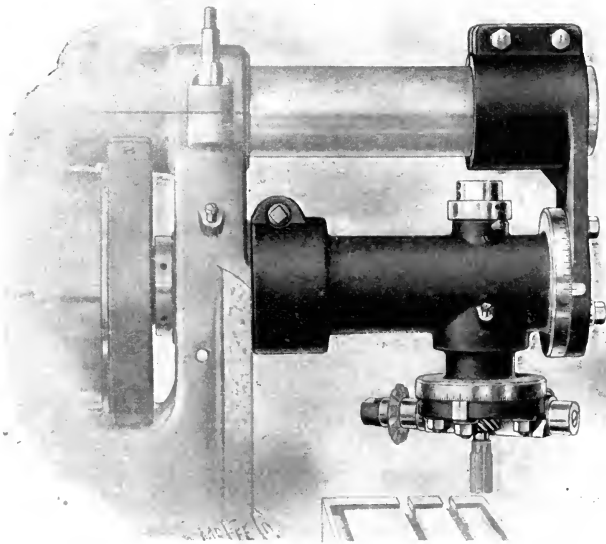

FIG. 454.

work table and its line of travel, it makes a convenient rack cutting attachment. In connection with the spiral head on the universal machines, it can be used to advantage in cutting spirals of large spiral angle, as the axis of the cutter can be set to the spiral angle instead of the work table. The auxiliary spindle can readily be removed when not in use, leaving a simple vertical milling attachment. Attachments of this class become of special value in shops when the amount of work that can be advantageously done by vertical milling does not warrant putting in a vertical milling machine.

In Fig. 455 is shown a circular milling attachment. It consists of a circular plate gibbed to a round base and provided with a worm gear into which the feed worm meshes. The base clamps to the table of the milling machine and the work is secured to

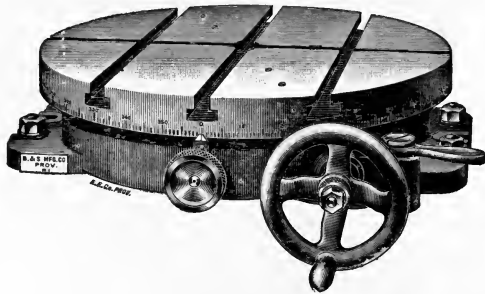

FIG. 455.

the top of the circular table, suitable T-slots being provided for the clamp bolts. This attachment is of special value on the vertical milling machines and in connection with the vertical milling attachments on the column pattern plain and universal machines. It may be provided with an automatic feed, which increases materially its usefulness where a considerable amount of work is to be done on it. This attachment can, when the table is suitably gibbed to the base, be clamped to a substantial right angle knee plate and the faces and periphery of work, as gear blanks, pulleys, etc., successfully milled with cutters on the main spindle of the machine. For this class of work an attachment similar to the one shown in Fig. 456 is best adapted. The construction of this attachment is evident. As shown, it is arranged to carry two blanks to be operated upon at the same time, the rims being completely finished at one rotation of the work.

It is frequently desirable to use cutters of small diameter and requiring high rotative speed in the larger sizes of milling machines. As the spindle speeds are altogether too slow for this

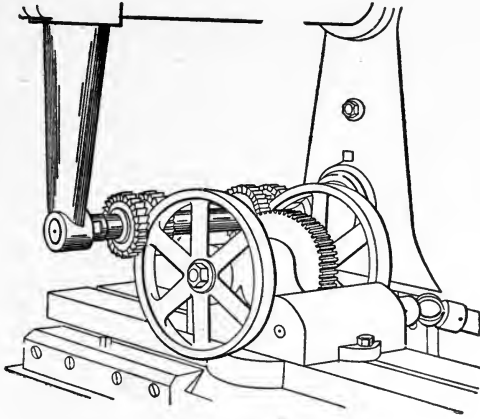

FIG. 456.

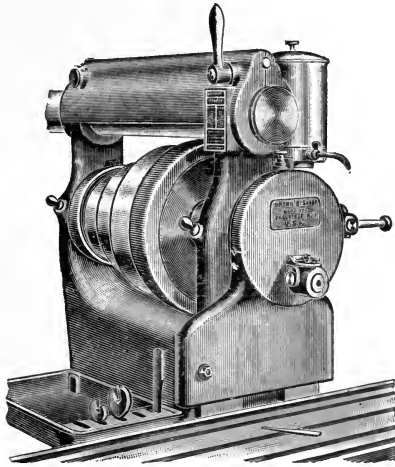

FIG. 457.

purpose, high speed milling attachments, one of which is shown in Fig. 457, are provided.

The attachment consists of a frame which fits the front face of the column and carries a light spindle for receiving the small cutters used. On the inner end of this spindle is a small pinion

which meshes with an internal gear screwed on the nose of the main spindle.

A rack-cutting attachment is shown in Fig. 458. A device similar to this is necessary when racks of any considerable length are to be cut on a milling machine, as the motion of the table in line with the spindle is not great, and the distance the cutter can be set from the nose of the spindle is also small. With the attachment shown, the length of the rack section that can be cut at one setting is limited by the longitudinal travel of the table. In the device shown, the frame is securely attached to the front face of the column, and the cutter spindle driven by a suitable chain of gears. The rack blank is clamped in the special vise

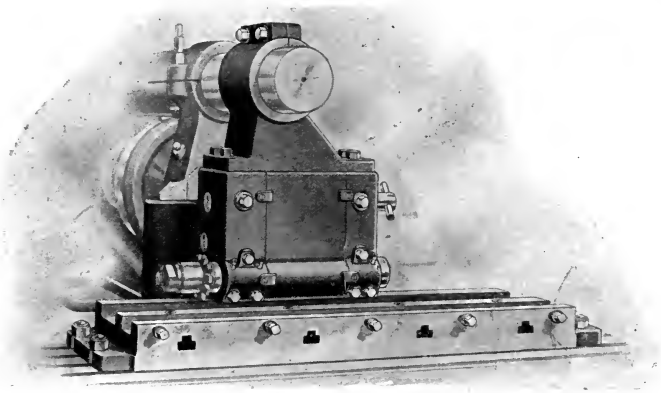

FIG. 458.

shown, and the depth and settings for each cut are obtained by means of the graduated dials on elevating and longitudinal screws. The feed is in and out by hand, or automatically, if the machine is provided with automatic lateral feeds.

The spiral cutting attachment shown in Fig. 459 is adapted, in connection with the plain milling machine, to the cutting of spirals. It frequently happens that the amount of spiral milling to be done in a shop would not warrant putting in a universal machine, and in such cases the attachment shown serves its purpose admirably. It consists of a circular base, carrying a suitable frame in which a work table is gibbed. The frame is preferably detachable from the base, graduated and capable of being clamped at any desired angle with the spindle of the machine. The work table carries a head and tail stock for supporting the work. The

head stock spindle carries at its outer end a bevel gear which revolves upon it. The rear face of the bevel gear is provided with circles of drilled holes, similar to an index plate. A radial arm keyed to the spindle carries a pin which engages in the holes of the plate and through which the drive is carried from the

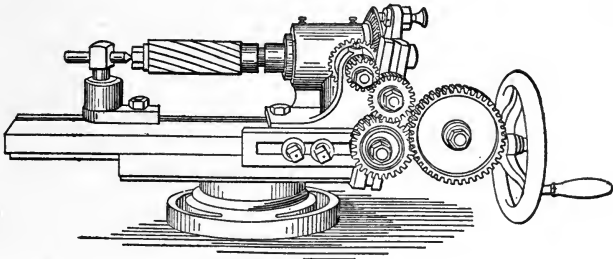

FIG. 459.

gears to the spindle. The balance of the gear combination is a suitable system of change gears substantially as described in connection with the universal dividing head. A worm feed operated by hand is usually provided on attachments of this class.

An attachment for the cutting of cams is shown in Fig.

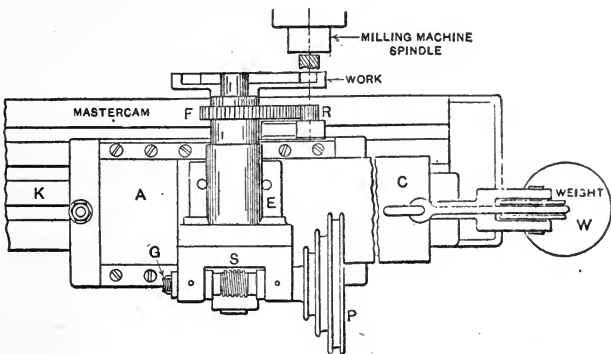

FIG. 460.

460. It consists of a base plate A, which can be bolted to the work table of the milling machine, and a head stock which is mounted on the slide C. C is gibbed to slide in the base plate. The head stock carries a spindle with a worm gear G on its outer end. The worm S engages the gear and the spindle is given a slow feed rotation by the pulley P or a crank which

can be substituted in its place when power feed is not available. R is a small roller mounted on a suitable support which extends upward from the base plate. The master cam F, which is of the same contour as the required cam, is mounted on the spindle, as is also the work. The work table of the milling machine is adjusted vertically and laterally so as to bring the center of the roller R and the milling cutter in the same axial line. A weight W connected by a rope, over a sheave at the end of the table, with the slide C, holds the master cam constantly in contact with the roller as the spindle and work are rotated. The master cam is usually of the exact size of the required cam, and in that case, the roller R should be of the same diameter as the milling cutter. If the master cam is larger or smaller than the required

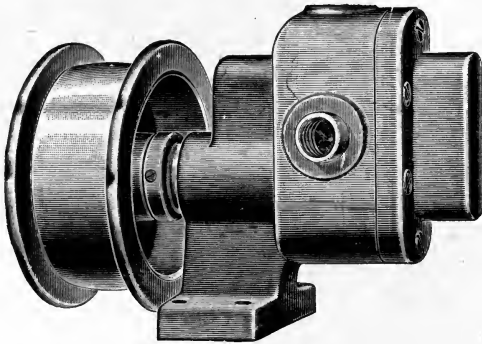

FIG. 461.

cam, the diameter of the roller, for the same diameter of the cutter, must be decreased or increased as the case may be, in order that the sum of the master cam and the roller radii will at all points equal the sum of the required cam and the cutter radii. For the cutting of cylindrical cams the spindle must stand at right angles with the cutter spindle. The attachment is so constructed that the spindle head can readily be secured in such a position on the slide plate C.

An oil pump for supplying a lubricant to the cutter and work when milling steel can properly come under the head of attachments. In Fig. 461 is shown such a pump. It is attached to a suitable reservoir and driven from an independent countershaft.

In Fig. 462 is shown a slotting attachment for the milling machine. The guide casting is secured to the overhanging arm

at its upper end, and at the lower end is clamped to a yoke casting which is secured to the front face of the column. The guide may be set at any angle between 0 and 10 degrees either side of the center line. Motion is given the slide by a crank screwed on the nose of the spindle. The stroke of the slide can be adjusted to any required length between 0 and 2 inches. The tools, which

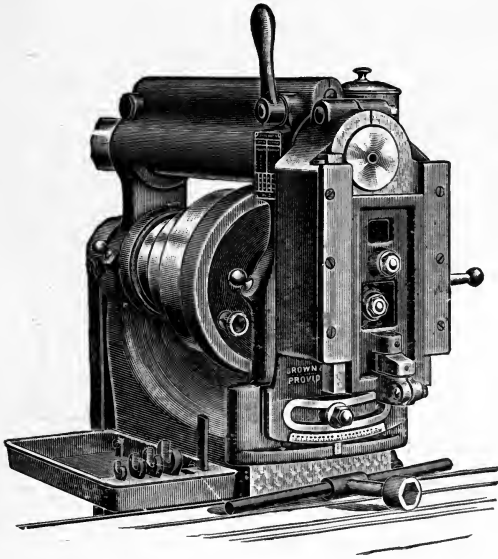

FIG. 462.

are provided with $\frac{1}{2}$ -inch round shanks, are firmly clamped in position. In the use of the attachment both the longitudinal and transverse table feeds are available and by means of the graduated dials very accurate readings can be made. This attachment is specially valuable in the forming of special tools, jigs, dies and templates.

CHAPTER XXIV.

MILLING MACHINE CUTTERS.

The milling of metallic surfaces requires a rotating cutter provided with one or more teeth having an edge and temper suited to the nature of the material operated upon. As to construction, milling cutters may be divided into the two classes—solid and inserted tooth. All small and most of the medium-sized cutters may be brought under the first class, as they are made from a single piece of tool steel; but when the dimensions become large the cost of the steel is an important point, which, together with the risks incident to the proper hardening of such large masses of tool steel, warrants the greater expenditure of labor usually necessary in the making of inserted tooth cutters. The inserted tooth cutter has only teeth of tool steel, the core or body being of cast iron or mild steel.

As to classification, milling cutters naturally fall under four heads, as determined by the four distinct varieties of work performed, as follows: Axial—those cutters used for milling plain surfaces which are parallel to the axis of rotation of the cutter; Radial—those which will mill plane surfaces at right angles to the axis; Angular—those used in milling plane surfaces at any angle other than 90 degrees with the axis; and Form cutters, used for machining all curved or irregular surfaces.

In Fig. 463 A is shown an axial or plain milling cutter, as it is usually called. It has teeth on the cylindrical surface only, which, when the cutter exceeds about one-half inch in thickness, are cut spirally, as shown in the figure. When these cutters are less than three-sixteenths of an inch in thickness, they are called metal slitting saws, and the sides are ground slightly dishing, which serves to give the teeth clearance in the grooves they cut. This is of much importance when the cut is deep, as is frequently the case when using the metal slitting saw.

The spiral teeth on these cutters are necessary for the following reasons. If the teeth are straight, each tooth as it comes into action would strike square against the work, producing a shock and consequent springing of work and cutter arbor; and as each tooth leaves the work the sudden release of pressure

causes reverse spring. If the cut is not deep, and only one or two teeth cutting at a time this effect will be more marked than when a greater number of teeth are in action, and the effect of the spring will be clearly shown by the waved and uneven condition of the surface produced. If, on the other hand, the teeth are arranged spirally they will come into and leave the work gradually, thus avoiding shock and, what is very important, give a shearing cut.

Plain milling cutters with nicked teeth, an example of which

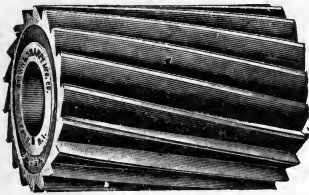

FIG. 463A.

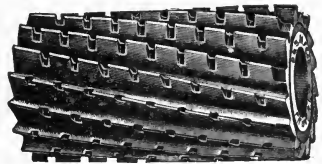

FIG. 463B.

is shown in Fig. 463 B, are especially adapted for heavy milling. The breaking up of the chip by the nicked tooth makes possible a very much heavier cut than can be taken with the ordinary form of continuous tooth.

When provided with teeth on their faces, these cutters become what are called radial, face, side or straddle mills. When the

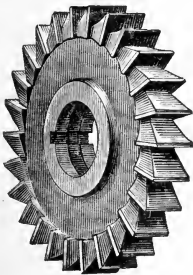

FIG. 464.



FIG. 465.

teeth are on but one face and the cutters used for straddle work, they must be cut right and left, as otherwise one cutter would run backward. The cutter shown in Fig. 464 can be run in either direction, as it has teeth on both faces, and constitutes the form usually used. These cutters, when worked in pairs, and especially for shoulder work, as shown in Fig. 465, should be carefully ground to the same diameter.

The end or shank milling cutter shown in Fig. 466 is virtually a radial mill of small diameter provided with its own independent shank. These cutters are seldom made larger than $1\frac{1}{2}$ inches in diameter. Their form permits the small diameters, which are so necessary in much of the fine milling work. These cutters are made right and left handed, and frequently the teeth on the circumference are cut spirally, as shown, straight teeth, however, being most used. The advantage of the spiral tooth for the end mill when used as an axial cutter arises from the de-



FIG. 466.

creased shock and vibration due to the steady shearing cut, which reduces the tendency of the tool to jar loose in the spindle or collet bearing. The direction of the spiral must be such that the end thrust of the cutting pressure tends to force the shank into, rather than draw it out, of its bearing. In a right-hand mill the angle of the spiral would be left-handed.

If it is desired to mill a slot with the end of the shank cutter, shown in Fig. 466, which does not start at the edge of the work, a hole must be drilled into the work of a diameter at least equal



FIG. 467.

to the diameter of the space without teeth in the end of the cutter, as otherwise the cutter could be made to enter only a depth equal to the depth of this space, and could not then be moved along the work. A form of cutter shown in Fig. 467 overcomes this difficulty, as the inner ends of the radial teeth are provided with cutting edges, which enables them to cut their way out when moved along the work. The length of these cutting edges limits, however, the depth to which the cutter may be made to enter the work at any one setting. In this form of cutter a smaller number of teeth must be used. The end mill may be placed

under either of the two first classes, as it may be used for machining surfaces which are either parallel with or at right angles to the axis of rotation.

The standard T-slot cutter is shown in Fig. 468. This tool is used in cutting the slots, a section of which is shown in Fig. 469, the central portion of the slot having been previously removed. In the cutter shown, alternate teeth cut on the inner and outer edges. These face teeth, however, have little work to do, and are



FIG. 468.

on some cutters omitted, the faces being ground slightly dishing, to provide the necessary clearance. T-slot cutters are made 1-32 of an inch over size in diameter, to allow for grinding. They are usually made left-hand, as shown in the figure.

In Fig. 470 is shown an angular cutter. These cutters are usually provided with face teeth, as shown in the figure. For straight work the face teeth may be omitted, the face being ground slightly concave. When the character of the work re-

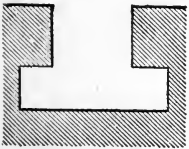

FIG. 469.



FIG. 470.

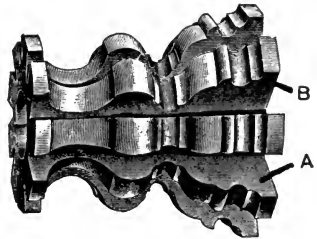

FIG. 471.

quires the cutter to be used as an end mill, a threaded hole is substituted for the plain one and the cutter held on the end of a suitable screw arbor. These cutters are regularly made with 40, 45, 50, 60, 70 or 80 degree angles, either right or left-handed.

In all of the cutters above referred to, the teeth are sharpened by grinding from their top edges, and since the surfaces milled are either planes or warped planes, the contour of the surface milled is not changed by so grinding the cutter. In form mill-

ing, however, the teeth, if so ground, would lose their outline and would therefore not produce correct work after being sharpened. This difficulty is overcome by the use of the formed cutter, an example of which is shown in Fig. 471. This cutter is sharpened by grinding from the front face, A, of each tooth. The cross-section of each tooth is the same from front to back faces. The back face, B, being somewhat nearer the center of the cutter than face A, provides the necessary tooth clearance. The sharpening of this cutter simply reduces slightly its diameter, which has no effect on the contour of the machined surface, the cutter being adjusted for depth after each grinding.

The original application of this method of forming the teeth was on gear cutters, but it has since been adapted to nearly all

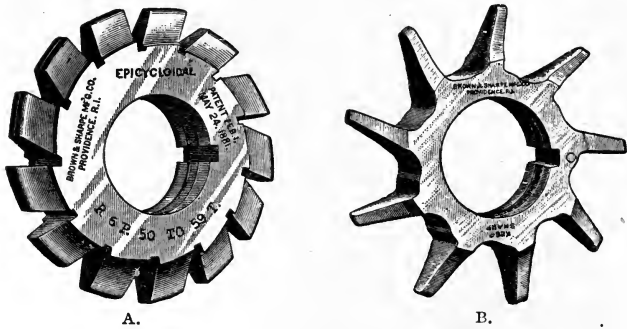

FIG. 472.

classes of irregular outline cutters used for form milling. Fig. 472 shows at A a new gear cutter and at B a similar cutter, which has finished complete, at one cut in cast iron, gear teeth aggregating a total length of 7,472 feet, the necessary grinding to keep the cutter in proper working condition having reduced the teeth to the shape shown in the figure. The last tooth cut was, however, quite as accurate in form as the first.

In Fig. 473 is shown a group of formed milling cutters. The names of these cutters, as given below, refer to the special class of work each is designed to perform. A is a sprocket wheel cutter; B, cutter for fluting reamers; C, for grooving taps; D, for cutting twist drills; E, circular cornering cutter; F, concave cutter, and G, a convex cutter. The hob cutter, Fig. 474, used for cutting the teeth of worm gears, has formed teeth. Angular cutters with formed teeth, Fig. 475, are now quite extensively used.

They are the only cutters regularly made with formed teeth that are used on work not classed under the head of formed work.

The method by which the relieved teeth are produced is briefly outlined in the following. The cutter which is to form the

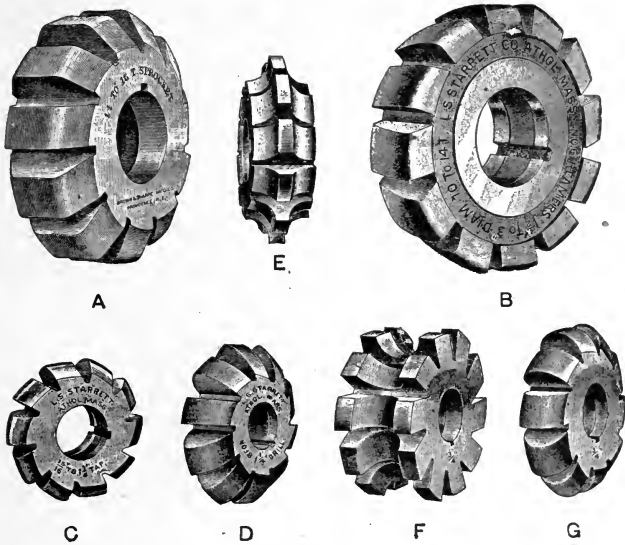

FIG. 473.

teeth is an exact negative in outline to the outline of the required tooth. The form of the space required is very carefully laid out with a fine scribe on a piece of smoked sheet zinc. The zinc

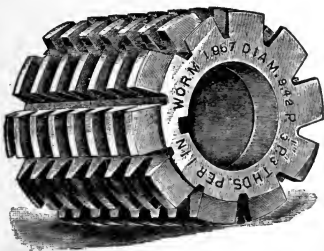

FIG. 474.

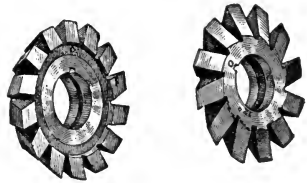

FIG. 475.

is then cut away, forming a template, to which the cutter is carefully fitted; the final fitting of the cutter to the template being made by oil-stoning after it is tempered. This work requires the best of skill, and when a cutter is once perfectly formed, other

cutters may be made from the first milling cutter it produces. These cutters are made on the end of a bar of steel and are as thin at the cutting end as strength will permit their being made.

Take, for example, the gear cutter A, Fig. 472. It is first blanked to nearly the exact dimensions, the spaces which separate the teeth cut and the blank secured on a rigid arbor, which is driven in a special machine at a slow rate of rotation. In front of the blank is mounted the outlining cutter in such a manner that it is given a small in-and-out motion once per revolution for every tooth to be cut. When the cutter begins to cut at the face A, it is farthest from the center of the blank, and as the tooth advances to the face B, the cutter moves toward the center, thus cutting the tooth deeper at B than at A. While the blank is turning through the space to the next tooth the cutter

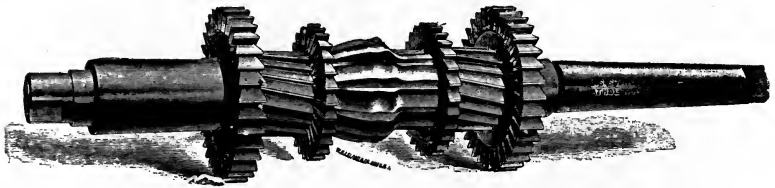

FIG. 476.

backs quickly to its outer position and repeats its motion for each tooth, until all are properly formed.

Relieved tooth cutters are made from solid stock as large as seven inches in diameter and six inches in length. It is usual to make these large cutters in sections, as shown in Fig. 476. Such combinations of cutters are termed gang mills, and may frequently be made up largely of standard cutters. In the one shown, only the middle section is a formed cutter, the balance being regular stock cutters.

What is known as the fly cutter is the simplest of the formed mills, and makes a cutter well adapted to small jobs of special work, where the expense of a regular form cutter would not be warranted. The fly cutter consists of a single tooth mounted in an arbor. In making the cutting tooth the stock is set slightly back from the center, and is then turned in a lathe to the desired outline, tempered and reset in the arbor, this time with a liner behind it, which throws it forward until the front face comes radial, and gives the tooth the desired clearance.

As already indicated, the inserted tooth is virtually the only practical method of making very large milling cutters. The principal difference in cutters of this class lies in the form of tooth and the method of securing it in the head. Inserted tooth cutters necessarily have fewer teeth per inch of circumference than solid cutters. This, however, is considered by many as an advantage. It certainly is on some classes of work, as when too many are used the cut per tooth is too fine, the metal being scraped rather than cut away, which produces excessive friction with a tendency to glaze the surface and rapidly dull the cutter.

In Fig. 477 is shown a form of axial milling cutter, which is used for heavy slabbing work. It is made in any required size and constitutes a very efficient tool for heavy work. The teeth are round pieces of tempered steel driven firmly into the soft

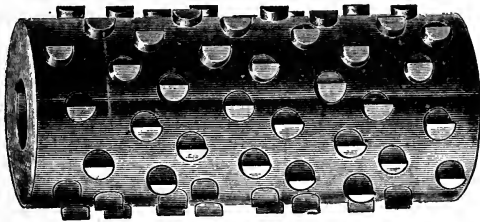

FIG. 477.

core, and then ground in place. It is found that cutters of this class do smoother and better work when the teeth are irregularly spaced. A radial mill constructed along these same lines is shown in Fig. 478. Here the teeth are held in position by set screws, and may be adjusted out when much worn. A plain disk may be substituted for the armed head, the set screws put in the back and more cutters used if desired. The cutting edges of the teeth should project beyond the circumference as well as the face of the disk. Cutters of this character are frequently made of very large diameter.

Fig. 479 illustrates an inserted tooth plain mill, in which the teeth are nicked. The teeth are arranged spirally, and the method of securing them in the head is apparent. The makers of this cutter also make plain solid milling cutters with the divided tooth.

Fig. 480 shows a pair of mills, quite similar in construction, in

which the tapered pins spread the stock an amount sufficient to grip firmly the teeth. In the cutter shown in Fig. 481 the teeth are pinched in their seats by drawing down with the screws the

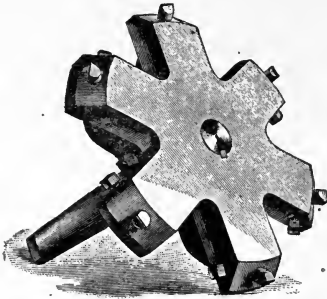

FIG. 478.

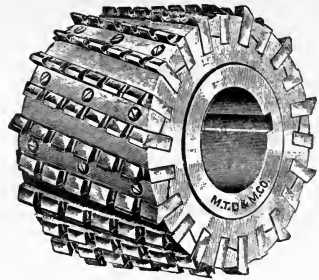

FIG. 479.

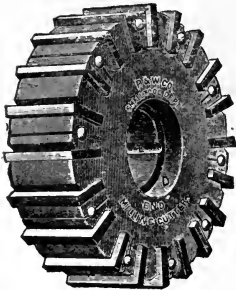

FIG. 480.



FIG. 481.

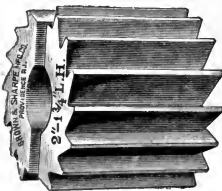
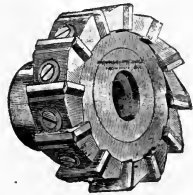

FIG. 482.



FIG. 483.

tapered bushings. This cutter is a form of large end mill to be carried on a special arbor. In Fig. 482 is shown a shell end milling cutter. End mills larger than $1\frac{1}{2}$ inches diameter are made in this form with either straight or spiral teeth. The hole is

parallel, the drive coming on a key which engages the keyway cut across the butt of the mill.

The inserted tooth is well adapted for use in cutters that must be kept up to fixed dimensions, as the teeth when dull can be set out and reground to the exact required dimensions.

When in radial cutters of the class shown in Fig. 464 a fixed thickness must be maintained, they are made as shown in Fig. 483 and known as interlocking cutters. After each grinding it is necessary to put thin washers between the sections to make up for the reduction in thickness, due to the grinding. With large built-up cutters, interlocking sections are generally used where fixed widths must be maintained.

The diameter of a milling cutter should be as small as the work will permit. The small cutter requires less power to drive it, cuts smoother, keeps sharp longer, makes its cut on a shorter length of feed than a large cutter, and is lower in first cost. Plain or axial cutters can usually be of small diameter as the cut is seldom deep, and the surface machined requires length rather than diameter of cutter. This is, however, reversed in the face or radial mill, where the diameter of cutter depends entirely on the width of the surface to be milled.

Milling cutters are usually made with the front faces of the teeth radial, thus giving no angle of rake. The angle of clearance should be about 3 degrees; the width of the top of the tooth being, before the first grinding, from .02 to .04 of an inch wide.

Too much stress cannot be laid on the importance of keeping milling cutters sharp, and especially the formed cutters. When a cutter starts to dull it begins to crush and remove by abrasion rather than cut the stock. This produces excessive friction between the teeth and work, and unless the cutter is ground promptly, its edges will be entirely lost. In the case of a formed cutter, when dull, a few revolutions will often so badly snub the teeth that a fourth or even more of each tooth will be ground away before their perfect section is reached. This is a tedious process, and unless great care is exercised is very apt to result in destroying the temper on one or more of the teeth.

The grinding of formed cutters requires an emery wheel of thin, dished section with a straight face at the edge. The tendency is to grind too much from the outer part of the tooth face, thus making a negative rake angle and poor cutting teeth. For grinding the ordinary form of tooth, a thin wheel of quite large

diameter should be used. If the diameter is small the top of the tooth will be ground concave to such an extent that the cutting edge will be materially weakened. By so mounting the wheel that its axis is not parallel with that of the cutter it will grind the top of the tooth flat. This is not ordinarily done, however. The emery wheel used for this purpose should be a free cutting one, and not too fine, as a fine wheel glazes and burns the delicate edge of the tooth. Its grinding face should be thin, and the emery about No. 80.

Milling cutters are driven from the machine spindle in three ways. Large cutters are frequently threaded directly to the nose of the spindle. This constitutes a most rigid and very satisfactory drive. They may also be carried on stub arbors, which

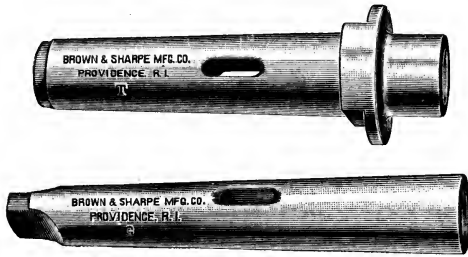

FIG. 484.

are either a part of or separate from the cutter, and lastly, upon through arbors, which may be supported on the outer end.

The small cutters of the end mill class are usually provided with a taper shank and a tang for driving, as shown, for example, in Fig. 468. The Brown & Sharpe taper of $\frac{1}{2}$ inch per foot is the taper usually given the shanks. These shanks fit either directly in the spindle bearing of the machine or in the collets which serve as reducers.

In Fig. 484 are shown two examples of milling machine collets. The one drives from a tang, the other from a flatted collar, which engages in a slot cut across the nose of the spindle. These collets are quite similar to drill sleeves.

Examples of stub arbors are shown in Fig. 485. The shell end mill arbor shown at A is used to carry cutters of the class shown in Fig. 482 with parallel holes. The arbor shown at B has a tapered nose and drives the cutter by the key shown. The cutter is driven tightly on the nose of the arbor and the flat head

screw in the end prevents it from working loose. The nut shown runs over a fine pitch thread and is used for forcing the cutter off. Cutters of the class shown in Fig. 481 are usually carried on an arbor of this character. In the case of milling cutters with threaded holes, a screw arbor must be used. If the cutter is of small diameter and the work it performs light, a plain threaded nose which allows the cutter to screw up squarely against a

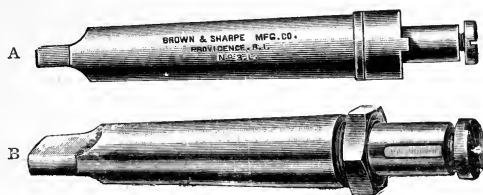

FIG. 485.

shoulder is satisfactory. If, however, the cutter is large and its work heavy it will tighten so hard that difficulty is experienced in starting it loose. In cases of this kind an arbor similar to the one shown in Fig. 486 is well suited. The cutter screws onto the nose of the arbor at A. B is a clutch collar which slides on the arbor and over a feather key D, which prevents it from rotating. E E is a nut which threads over the collar of the arbor.

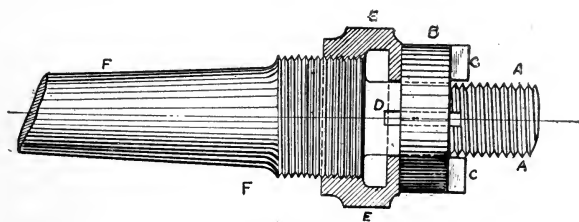

FIG. 486.

In applying the cutter the nut E E is screwed close up to the shoulder and the clutch collar slid back as far as possible. The cutter is screwed on until its face touches the keys C C, which are a part of the collar B. The key seats in the back face of the cutter are placed opposite the keys C C, and the clutch collar moved forward engaging the keys. The nut E E is backed up against the clutch, holding all parts firmly. In removing the cutter it is simply necessary to slack the nut and draw back the

clutch, thus leaving the cutter free to turn off. Threaded cutters, when left-handed should have left-hand threaded holes and when right-handed should have right-hand threads in the hole,

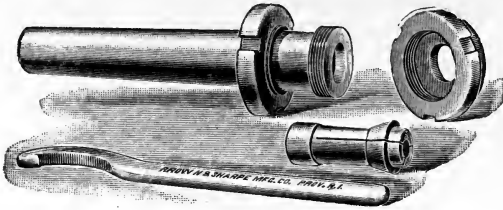

FIG. 487.

as otherwise the pressure of the cut will tend to loosen the cutter from its arbor.

In Fig. 487 is shown a spring chuck collet used on the mill-

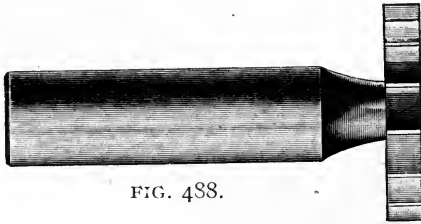

FIG. 488.

ing machine for holding small cutters having parallel shanks; an example of such a cutter being shown in Fig. 488.

Milling machine cutter arbors, an example of which is shown in Fig. 489, are fitted to the spindle bearings and driven in the

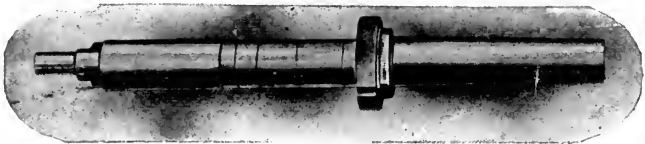

FIG. 489.

same manner as the collets. The extended portion of the arbor is ground cylindrically true and provided with a nut at or near its outer end for clamping the cutter between the washers. The arbor washers are of assorted lengths in order to accommodate

cutters of different thickness. When the overhanging arm supports the bar at the end, a suitable bearing is provided on the end of the arbor. For supporting the bar midway in its length, a collar somewhat larger in diameter than the others fits a suitable bushing in the overhanging arm. Arbor nuts should be right or left-handed, depending upon the direction of rotation, as a slipping cutter should tend to tighten rather than loosen the nut. Cutters of small diameter can usually be driven by the friction between washers and cutters alone. Larger sizes, however, should be keyed to the arbor and for this purpose a spline is cut the full length of the arbor.

In putting collets and arbors in their bearings in the spindle, both surfaces should be wiped clean and dry and driven snugly together. A soft hammer or block of hard wood should always be used to drive with.

CHAPTER XXV.

MILLING MACHINE WORK.

Dividing a circle into equal parts by means of the plain or universal spiral head on the milling machine is known as "indexing." When the index plate is secured to the spindle as at C, Fig. 448, and the divisions obtained by rotating the plate and spindle together, it is known as direct indexing. When the spindle is rotated by means of suitable geared connections and the index plate remains normally stationary the term indirect indexing is usually applied. The indirect method can be classified under three heads, simple, compound and differential.

Since, as shown in Fig. 448, forty turns of the crank J and worm A are required to make one turn of the spindle the following rule for simple indirect indexing may be given. Take 40 as the numerator and the required number of divisions as the denominator, and reduce. Thus, it is required to cut 32 teeth in a gear. $40-32$, or $1\ 8-32$ of one revolution of the crank will make one division on the blank.

The sector should be set to include 8 spaces (9 holes) on the 32 circle, or 4 spaces on the 16 circle could be used. If 108 teeth were required, then $40-108 = 20-54 = 10-27$, or 10 spaces on the 27 circle would give the required division. This ratio is not affected by multiplying or dividing both numerator and denominator by the same number. Therefore after reducing as low as possible, if that denominator does not correspond to the number of holes in any circle available, we can multiply or divide it by any number that would give us the proper number, also treating the numerator in the same manner. For example, 25 divisions require $40-25 = 1\ 3-5$ turns. We can use any circle divisible by 5, as 20, or 4 times the denominator. Multiplying the numerator by 4 also, gives 12 holes in the 20 circle.

It frequently becomes necessary to divide a circle into a number of parts which can not be obtained in the regular manner because a circle of the required number of holes is not on the index plate. If a circle for making one-half the required divisions is on the plate, every other tooth can be cut; the work can then be rotated through one-half of one space and the bal-

ance of the teeth cut. Thus if 96 teeth are required and no circle available, set for cutting 48 teeth, which gives 10 spaces in the 12 circle or 15 spaces in the 18 circle. After cutting once around, move the pin through $7\frac{1}{2}$ spaces, and being careful that it is not moved, cut partly through on the tooth; stop the machine without throwing out the feed and carefully adjust the driver to make up for the $\frac{1}{2}$ space, which brings the pin into another hole, and proceed with the cutting as for the first half. With care in the adjustment, the error in making the $\frac{1}{2}$ setting will be slight.

A method of compound indexing can be used to excellent advantage for obtaining with the regular plates many divisions that may not be had in the regular manner. The application of this method requires plates with the holes drilled through, and the back pin R, Fig. 448, radially adjustable. The method consists in indexing forward on the front side of the plate in the regular manner and adding to or subtracting from this movement another movement indexed from the back side of the plate. From tables calculated by W. Gibbons and given complete in "Construction and Use of Milling Machines," a treatise published by the Brown & Sharpe Mfg. Co. To divide into 91 parts, index forward, on the front of the plate, six spaces on the 39 circle; then index forward on the back of the plate, 14 spaces on the

49 circle. This gives $\frac{6}{39} + \frac{14}{49} = \frac{2}{13} + \frac{14}{49} = \frac{98 + 182}{637} = \frac{280}{637} = \frac{40}{91}$

or the equivalent of 40 holes in a 91 circle. If 99 spaces are required, index forward 15 spaces on the 27 circle and backward

5 spaces on the 33 circle. This gives $\frac{15}{27} - \frac{5}{33} = \frac{5}{9} - \frac{5}{33} =$

$\frac{165 - 45}{297} = \frac{120}{297} = \frac{40}{99}$, or the equivalent of 40 holes in a 99 circle.

For the two cases above given the method is exact. For a large number of the divisions practically possible the method is approximate. For example, to divide into 212 parts. 34-47 turns forward plus 6-49 of a turn forward gives 211.9995 teeth, a division sufficiently accurate for all practical purposes. In this case the teeth are not successively cut, 17 turns of the work being required in which to catch all of the divisions.

The above method is unique and will frequently be found of great value. Care must be exercised in making the moves, as the chances for mistakes are great, especially so as the back plate moves necessitates counting the holes each time, a sector not being provided.

The new method of differential indexing, as applied by the Brown & Sharpe Mfg. Co. to all their universal spiral heads, is an exact method which not only overcomes the chances of error in the compound method, but is much more convenient.

The spiral head is shown in Fig. 490, also in sectional views in Fig. 448. Referring to these figures, an extended shaft from the spindle carries a gear E, which through the idler D and the

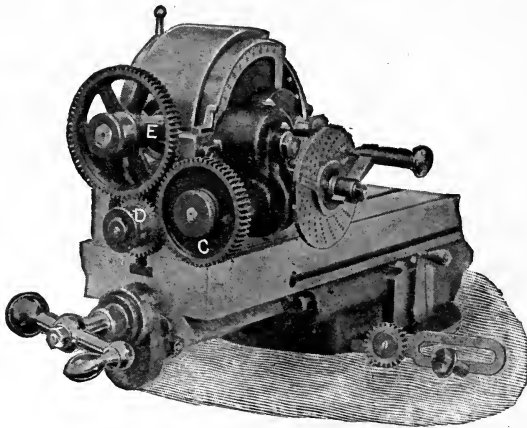

FIG. 490.

gear C communicates the motion of the spindle to the gear train Fig. 449, connected with the index plate I. When pin P, Fig. 448, engages a hole in the plate the whole becomes a locked mechanism. Withdrawing P unlocks the mechanism and the rotation of the crank J, worm A and spindle causes index plate I to rotate either right or left handed, depending on whether one idler, D, or two are used, and the amount of motion relative to the crank is governed by the gears used.

If gears E and C are of the same diameter, one turn of the spindle will make one turn of the index plate. This will require 40 turns of the crank J and as the rotation, due to using one idler, is in the same direction, the pin P has passed a given point on the index, but 39 times, thus giving 39 as the spacing number.

Had two idlers been used the rotation would have been in opposite directions and 41 would have been the spacing number inasmuch as the plate has gained a crank rotation.

The manufacturers furnish a complete table of change gears for dividing all numbers up to 360. Take for example the division 317—referring to the table—gear 64 should be used on the worm C, and gear 24 on the spindle E, with one idler. The ratio of worm to spindle rotation is $\frac{24}{64} = \frac{3}{8}$ and as the plate and crank rotate in the same direction, the spindle loses $\frac{3}{8}$ of one revolution for every 40 revolutions of the crank, or 3 full revolutions in 320 turns of the crank giving 317 as the number of divisions. Set the sector to give $\frac{1}{8}$ turn of the crank, or 3 spaces on the 24 circle.

When the required ratio would give gears too large or too small in diameters they are compounded, thus keeping diameters within reasonable limits. Spirals cannot be cut when the head is geared for differential indexing.

For correct indexing there should be no slack or back lash in any of the parts. It is advisable, however, not to carry the crank and its pin past the hole, but to bring it up to the hole without the necessity of carrying it back, which would serve to let any slack affect the accuracy of the division. It is advisable, in order to prevent confusion, for the operator always to rotate the crank in the same direction, unless there is some special reason for doing otherwise.

The radial arms of the sector are held in position with reference to each other, by friction. In rotating them over the face of the plate, always take hold of the arm that strikes the pin, as there will then be no danger of changing their relative position through striking the pin with considerable force.

In Fig. 491 is shown an end view of the dividing head, described in Fig. 448, secured on the end of the work table. The spindle S carries a spiral gear at its farther end, meshing with the upper spiral gear shown in Fig. 449. The gear marked "screw" is keyed to the feed screw and through the compound idlers transmits its motion to the gear on worm and through the spirals and spur gear connection to the worm and worm gear. When the spindle is so geared the post R is disengaged from the plate and the worm shaft is driven from the dividing plate through the pin P and the crank J. It is obvious that when the feed screw is at rest, the plate I is held without the pin R and the re-

quired divisions obtained by carrying the crank over the plate in the usual manner.

With all universal machines a table of change gears is provided for determining the proper gears to use for producing a large number of spirals of different pitch. Any desired pitch of spiral can be obtained by making special gears, and a good many pitches not given in the table may be produced by other combinations of the regular gears than those given. The proper gear

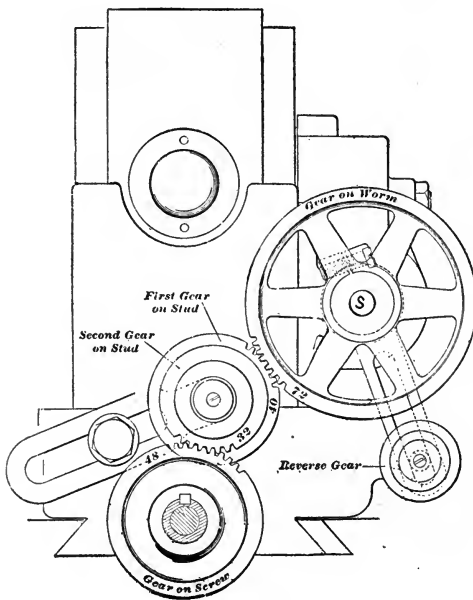

FIG. 491.

for a required spiral pitch may be readily determined from the following considerations.

The table lead or feed screws usually have four threads per inch. Assuming that number, if the gear of the screw had the same number of teeth as the one on the spindle S and was geared directly with it (that is, simple, not compound geared), then 40 turns of the screw would make 40 turns of the worm and one of the spindle; and as four turns of the screw are required per inch of the table motion, the pitch of the spiral would be 10 inches. If a spiral pitch of 6 inches was required, $6 \times 4 = .24$,

the number of revolutions the screw must make while the work rotates through one revolution. Then the ratio

$$\frac{24 \text{ teeth in driven gear}}{40 \text{ teeth in driving gear}}$$

Put gear with 40 teeth on the screw and gear with 24 teeth on the spindle S. It is best when possible to use the simple gearing. If, however, the ratio is such that one of the gears would be extremely large or small, then the gearing should be compounded. For example, required pitch of spiral $32\frac{1}{2}$ inches; $32\frac{1}{2} \times 4 = 130$, or the revolutions of the screw per revolution of the work

$$\frac{130 \text{ No. teeth in driven gear}}{40 \text{ No. teeth in driving gear}}$$

As 130 would be a rather large gear and probably not furnished with the machine we could reduce the ratio to $\frac{65}{20}$, but this would also give numbers of teeth not usually furnished. It would then be necessary to compound. Resolve the ratio $\frac{130}{40}$ into factors $\frac{13}{4} \times \frac{10}{1}$. As these numbers are too low we can multiply both numerator and denominator by the same number, and we would have, for example, $\frac{13}{4} \times \frac{4}{1} = \frac{13}{1}$ and $\frac{10}{1} \times \frac{4}{1} = \frac{40}{1}$ and as $\frac{13}{1} \times \frac{40}{40} = \frac{520}{40}$ we may use gears 40 and 52 as the driven gears. Either 20 or 32 can be placed on the screw and the other will be the inside gear on the stud. Either the 40 or 52 can be put on the worm shaft S and the other will be the outside gear on the stud. If any of the gears called for were not found in the regular set, the numbers could be changed by treating both numerator and denominator without changing the ratio. Thus in the last problem, if the last set did not contain a gear of 20 teeth, we could divide both numerator and denominator by a common factor and multiply the results by a number that would give numbers corresponding to available gears. Thus in the ratio $\frac{13}{4}$ divide both by 5 = $\frac{13}{2}$ and multiply both by 6. This would give $\frac{39}{4}$, which alters the numbers but does not change the ratio. In this manner it is usually possible to so manipulate the ratios that the exact or a very close approximation to the required pitch can be obtained with the regular gears.

The arrangement shown in Fig. 449 gives the proper rotation for cutting a right-hand spiral. If a left-hand spiral is required a reverse gear must be put into the series. This gear is carried on a suitable arm, and the gear marked 40 drives 72 through this

gear, thus changing the direction of rotation of the worm shaft and spindle.

In the cutting of all spirals the work table must be set at an angle with the cutter's axis, an amount equal to the spiral angle of the work. For equal pitch of spiral this angle varies with the diameter of the work; the larger the diameter the greater the angle.

In the cutting of any spiral the pitch of the spiral, the spiral angle, the number of teeth and the form of the cutter must be known. Having this data, the work is placed between centers and the cutter brought over its center. The proper change gears for giving the required pitch are adjusted and the table swung toward the column the amount of the spiral angle. The rotation of the spindle must be left-handed for left-handed spirals, and right-handed for right-handed spirals, this change in direction of rotating being obtained by putting in or taking out an idle gear in the change gear mechanism.

The proper rotative speeds and feeds are very important as they are the principal factors upon which the output of the machine depends. As the toughness and hardness of the different grades of the several metals varies so much, it is impossible to lay down any fixed rules to be followed. With cutters other than the most delicate the very fine feeds are to be avoided, as the cutting edges stand up better under a moderately heavy cut than when scraping the metal away.

Milling cutters must be kept sharp. As soon as a cutter loses its keen cutting edges it dulls very quickly and does not produce smooth or accurate surfaces as it springs away from its work. A cutter must not be run backward when against its cut, as the teeth are not strong against a backing pressure and are apt to be broken off.

For the standard carbon steel milling cutters, a surface speed of 30 to 40 feet per minute can be maintained on soft machinery steel, thoroughly annealed tool steel and wrought iron. In such cases, however, the cutters should be sharp and lubricated with screw cutting oil or some good compound. On cast iron cutting speeds of from 40 to 60 feet per minute can be maintained, depending on the hardness of the iron. On brass a speed of from 80 to 100 feet per minute is suitable. These speeds may, with cutters made of special air hardening steels, be materially increased.

The depth of cut and rate of feed employed are dependent upon the hardness of the metal, its strength to resist the cut, rigidity with which it is held, and character of finished surface required.

In general finishing cuts with plain axial mills are taken at quick speeds and fine feeds. With radial mills finishing cuts may be taken at coarse feeds, as the character of the cut due to the long cutting edge, does not show a waved or uneven surface.

In the case of expensive gangs of cutters, and more especially on those where fixed dimensions necessitate great care in grinding, it is advisable to hold the cutting speed down somewhat.

The following table will be found convenient for determining the proper number of revolutions for cutters of different diameter to give cutting speeds up to 60 feet per minute.

TABLE OF CUTTING SPEEDS.

Feet per Minute.	5'	10'	15'	20'	25'	30'	35'	40'	45'	50'	60'
Diam.	REVOLUTIONS PER MINUTE.										
1/2	38.2	76.4	114.6	152.9	191.1	229.3	267.5	305.7	344.0	382.2	458.7
3/8	30.6	61.2	91.8	122.5	153.1	183.7	214.3	244.9	275.5	306.1	367.5
1/4	25.4	50.8	76.3	101.7	127.1	152.5	178.0	203.4	228.8	254.2	305.1
7/8	21.8	43.6	65.5	87.3	109.1	130.9	152.7	174.5	196.3	218.9	261.9
1	19.1	38.2	57.3	76.4	95.5	114.6	133.8	152.9	172.0	191.1	229.2
1 1/8	17.0	34.0	51.0	68.0	85.0	102.0	119.0	136.0	153.0	170.0	204.0
1 1/4	15.3	30.6	45.8	61.2	76.3	91.8	106.9	122.5	137.4	153.1	183.6
1 3/8	13.9	27.8	41.7	55.6	69.5	83.3	97.2	111.1	125.0	138.9	166.8
1 1/2	12.7	25.4	38.2	50.8	63.7	76.3	89.2	101.7	114.6	127.1	152.4
1 5/8	11.8	23.5	35.0	47.0	58.8	70.5	82.2	93.9	105.7	117.4	141.0
1 3/4	10.9	21.8	32.7	43.6	54.5	65.5	76.4	87.3	98.2	109.1	130.8
1 7/8	10.2	20.4	30.6	40.7	50.9	61.1	71.3	81.5	91.9	101.9	122.1
2	9.6	19.1	28.7	38.2	47.8	57.3	66.9	76.4	86.0	95.5	114.6
2 1/4	8.5	17.0	25.4	34.0	42.4	51.0	59.4	68.0	76.2	85.0	102.0
2 1/2	7.6	15.3	22.9	30.6	38.2	45.8	53.5	61.2	68.8	76.3	91.8
2 3/4	6.9	13.9	20.8	27.8	34.7	41.7	48.6	55.6	62.5	69.5	83.4
3	6.4	12.7	19.1	25.5	31.8	38.2	44.6	51.0	57.3	63.7	76.5
3 1/2	5.5	10.9	16.4	21.8	27.3	32.7	38.2	43.6	49.1	54.5	65.4
4	4.8	9.6	14.3	19.1	23.9	28.7	33.4	38.2	43.0	47.8	57.3
4 1/2	4.2	8.5	12.7	16.9	21.2	25.4	29.6	34.0	38.1	42.4	50.7
5	3.8	7.6	11.5	15.3	19.1	22.9	26.7	30.6	34.4	38.2	45.9
5 1/2	3.5	6.9	10.4	13.9	17.4	20.8	24.3	27.8	31.3	34.7	41.7
6	3.2	6.4	9.6	12.7	15.9	19.1	22.3	25.5	28.7	31.8	38.1
7	2.7	5.5	8.1	10.9	13.6	16.4	19.1	21.8	24.6	27.3	32.7
8	2.4	4.8	7.2	9.6	11.9	14.3	16.7	19.1	21.1	23.9	28.8
9.	2.1	4.2	6.4	8.5	10.6	12.7	14.9	17.0	19.1	21.2	25.5
10	1.9	3.8	5.7	7.6	9.6	11.5	13.4	15.3	17.2	19.1	22.8

The smaller milling cutters which are carried on an arbor are usually driven by the friction between their faces and the arbor collars. They should therefore be rotated in the direction

which tends to tighten the arbor nut. With the large cutters which are keyed to the arbor the direction of rotation may be either way. For a given rotation of the cutter the direction of the feed should be such as to force the work against the cutter as shown at A, Fig. 492. When the rotation and feed are as above indicated, all slack or back lash between the nut and feed screw is taken up and the work is forced steadily to its cut. If the feed is as shown at B, the cutter tends to drag the work under it and as a result any slack whatever allows the work to move forward with an unsteady, irregular motion as the feed screw rotates. When the feed is as shown at A, the cutter teeth work from the bottom up, lifting the hard scale of castings and forgings rather than cutting down upon it, as is the case when the

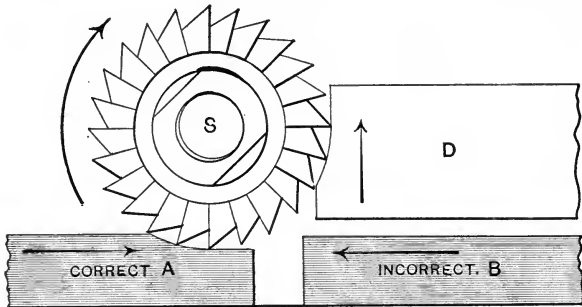

FIG. 492.

feed is as shown at B. The keen edge of the cutter lasts much longer with the feed in the direction indicated at A. The under feed indicated at B has been advocated by some, but is generally considered as incorrect, as the wear on the cutter and the danger of accident from the work drawing under is much greater. With milling machines using the rack feed where the work table is held only when the feed is in, the most careful workman will sometimes get into trouble if the under feed B is used.

When the cutter is operating on the end of the work as shown at D, the feed should be up, as indicated by the arrow; if the work was on the other side of the cutter, the feed should be down. In this class of milling it is best to feed up, as that brings the pressure of the cut down upon the table and tends to close the joints of the table, saddle and knee, making the cut smooth and steady. When the table is to be fed vertically for

work as shown at D, the table stops, provided with all milling machines, should be used and thus prevent any possibility of the work moving in or away from the cutter when correctly set. When it is necessary to use both sides of the cutter at the same time, as in Fig. 493, the direction of the feed should be determined from a consideration of the amount of stock to be removed from the sides. If the rotation of the cutter is as indicated and the most stock is to be removed from the surface A, then the feed should be in the direction shown by the arrow. The cut on the upper surface then tends to retard the feed and the cut on the lower surface to draw the feed; and since the cut on the upper surface is heavier than that on the lower, the retarding pressure is greater than the drawing, and a smooth, steady cut results, with a minimum danger of injury to the

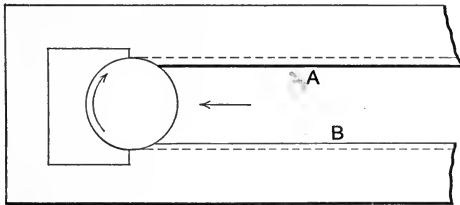

FIG. 493.

work and cutter. If the cut was heaviest at the surface B, the cutter should be started from the opposite end and the direction of the feed reversed.

Plain surfaces may usually be milled either by the plain axial milling cutter or a radial or end mill. The axial cutter leaves a smoother surface and is more easily kept in order than the radial. The tendency to spring and distort the work is, however, greater with the axial cutter, as the pressure of the cut is very largely at right angles to the work surface, while with the end mill the pressure is almost wholly in the direction of the feed. The character of the work usually determines which class of cutter to use. At 1 and 2, Fig. 494, are shown two ways of milling a common hexagon nut. The straddle mills of No. 2 are radial cutters and, as arranged, finish two surfaces each time over the work. An end mill might be used, in which case but one surface would be finished at a time. In any case the diameter of the mill should be as small as strength and con-

venience will permit. An inspection of Fig. 495 shows the reason for this. If the portion D E F G of the work is to be removed by the cutter, it is evident that the smaller cutter X

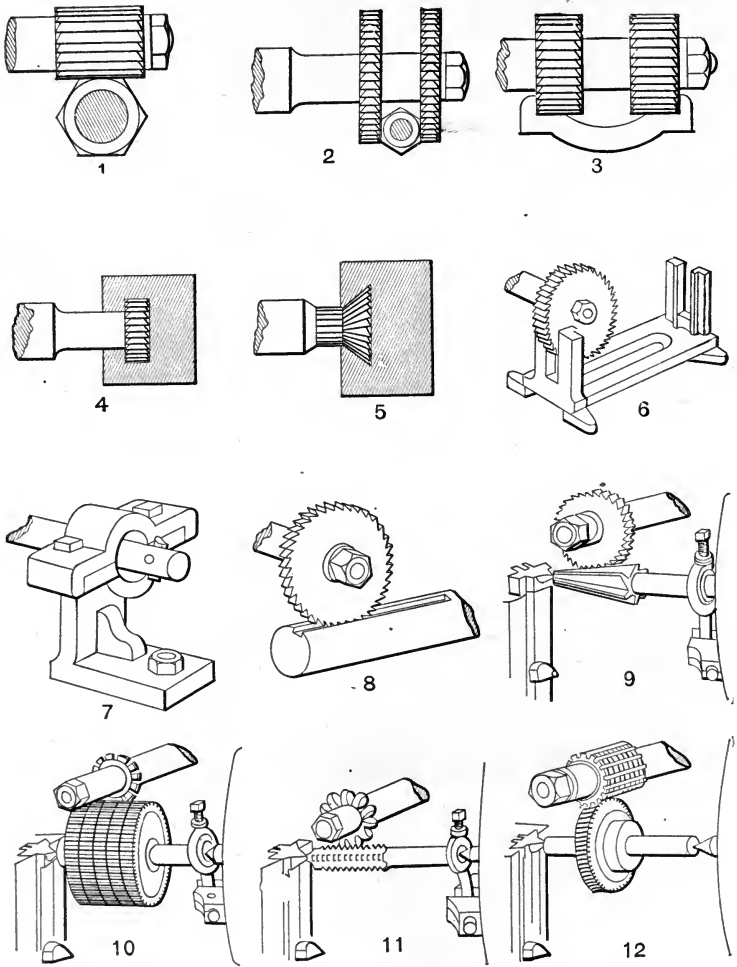

FIG. 494.

will travel the distance B in completing the cut, while the cutter Y must travel the distance A. If the width W of the work is small, the saving in time required for the work by using the small cutter becomes a considerable portion of the total time.

The first cost of the smaller cutter is less and the power required to drive it also less than with the large cutter.

In placing cutters on the arbor, the faces of the cutter and the arbor collars should be carefully wiped and thus insure a true running cutter. As shown in Fig. 496, a small piece of cutting or dirt A between the faces, causes a spring in the arbor and the cutter will run out of true. When made, the faces of these collars are carefully brought parallel with each other and, with reasonable care, they can be kept in this condition. When, as in 2 and 3, Fig. 494, two cutters are to be used for straddle work, it is necessary when the distance between

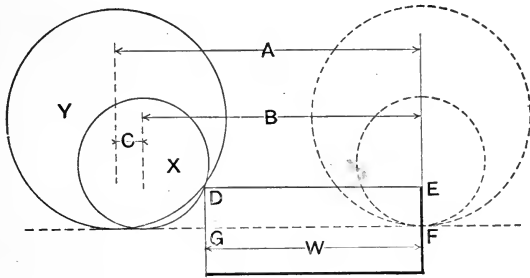

FIG. 495.

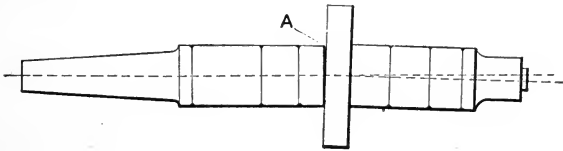

FIG. 496.

the faces of the work is to be of exact dimension, to have collars of suitable length. As the regular collars usually make up by eighths above one-fourth inch, suitable washers must be provided for making up the exact dimension. These may be had with parallel faces and varying in thickness by .001-inch, thus making it possible to obtain any desired dimension between the faces of the cutters. When it is required to machine the top surface of the work, a plain axial cutter can be used between the straddle mills in place of the collars and washers.

At 4, Fig. 494, is shown the final operation in the milling of a T-slot. The neck of the slot and all the metal possible should

be first removed with a plain axial cutter, as in Fig. 497, which leaves a minimum amount of work for the more delicate T-slot cutter to perform. If the nature of the work is such that a plain cutter cannot be used, the stock can be removed with an end mill. In this case, a cutter somewhat smaller in diameter than the required width of the neck must be used first, as the spring of so small a cutter when taking such a heavy cut would cause the work to be untrue. The neck can then be finished to exact width by passing a sizing cutter through or by trimming each side with a finishing cut with the roughing cutter. The milling of a V-slot, 5, Fig. 494, is similar to that of the T-slot, the most of the stock preferably being first removed with a plain cutter or an end mill. The cutter shown could be used to complete the work at once, without the use of a stocking cutter as it is provided with teeth on its shank. This is not, however, the

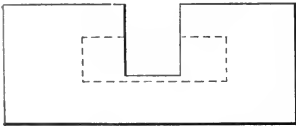

FIG. 497.

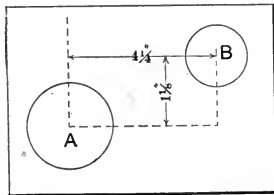

FIG. 498.

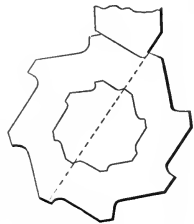

FIG. 499.

customary method, as the necks of these cutters are not usually provided with teeth and the spring of the cutter makes smooth, accurate results very hard to obtain.

At 6, Fig. 494, is illustrated a method of milling the guides of a housing. With a cutter of proper thickness and diameter, both sides and bottom of the guides are finished at one cut. This figure serves to suggest one of many similar operations that can be performed with a plain cutter. No. 7, Fig. 494, shows how the milling machine can be used for boring and facing work. The work is clamped to the table of the machine and a short boring bar placed in the spindle bearing. If the hole to be bored is of considerable length and diameter, the outer end of the bar should be formed to fit the bearing of the overhanging arm, thus making it firm and capable of producing a smooth, true bore. An automatic in-and-out feed is very desirable for work of this character. It will also be noted that the

vertical and lateral adjustments to the work table enable the work to be set in any desired position for the boring of parallel holes. Take, for example, the piece of work shown in Fig. 498, where the two holes are to be bored parallel with each other. The work should be first squared up and the hole A bored; after which, by means of the graduated elevating screw, the work can be dropped exactly $1\frac{1}{8}$ inches and by means of the graduated feed screw set over the $4\frac{1}{4}$ inches, which brings the center of the hole B into exactly the proper position for boring. In like manner any desired number of settings may be obtained quickly and with great accuracy. In making setting measurements by the use of the graduated screws precaution must be taken to avoid the error that might arise from neglecting to consider the back lash between the screw and its nut. Thus, if a vertical adjustment is to be made, the table for the first operation should be dropped a little too low and brought up to the proper point. The index can then be set at zero and the work table raised the exact amount required by the graduated screw. If by accident the table is raised too high, it should be lowered somewhat below the proper point and again brought up to the correct reading. This insures against any error arising from the back lash and means that in all settings the slack between the nut and screw should be kept on the same side.

A long tool with cutting edge at right angles to the boring bar may be used for facing off the end of the work after the boring operation. The end next to the spindle can, of course, be faced with an end mill if desired, or a facing attachment consisting of a slide and tool-carrying head can be mounted for this purpose on the nose of the spindle or on the boring bar. Twist drills and reamers mounted in the spindle of the milling machine can frequently be used to very good advantage on many classes of work.

No. 8, Fig. 494, shows the method of keyseating a shaft in the milling machine. Where the keyway is not cut the entire length of the work, a rounded end is left, which is usually not objectionable. If a cutter of small diameter is used the length of the rounded end is not great. In cases where the keyway must be full depth to the end, an end mill of diameter equal to the width of the keyway can be used to finish out the rounded end. By placing several shafts together on the table and putting as many cutters on the arbor, properly spaced, all keyways may

be cut at one operation. This is advantageous where a large number are to be cut at one setting of the machine. When a keyway is to be cut in the shaft at some point between the ends, to receive a short key or feather, the end mill is used. If the mill is not of the center-cut type a small hole, a little larger than the diameter of the toothless center of the cutter, should be drilled at one end and to a depth equal to the depth of the required keyway. This allows the mill to cut its way to the bottom and then feed out. For this work the cutter should run at a

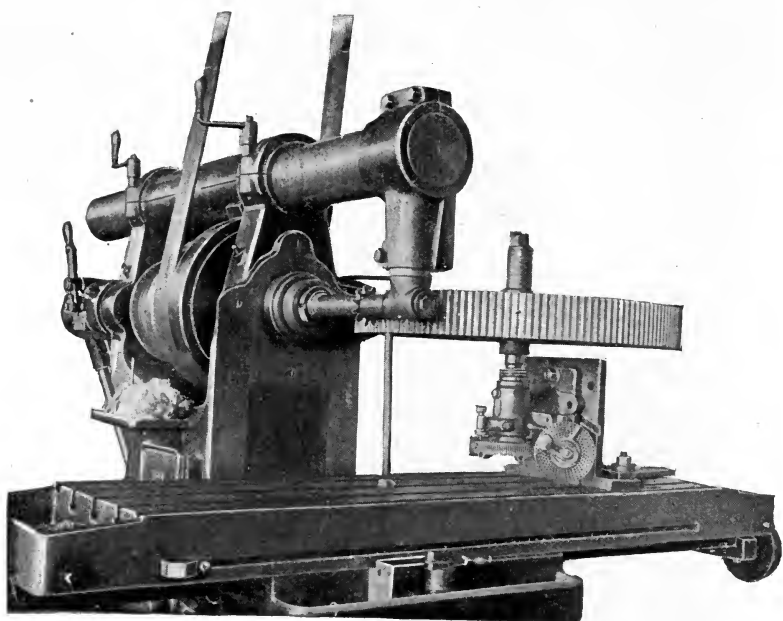

FIG. 500.

comparatively high rotative speed and should be given a fine feed, as otherwise the spring is excessive and the work untrue.

No. 9, Fig. 494, shows the method of fluting a reamer. The present example is that of a taper reamer. In this case the tail center is raised an amount sufficient to give the proper depth of cut at each end of the flutes. The cutters usually employed for this work are specially formed cutters and should be set so that the face of the cutter that cuts the front face of the tooth stands on a radial line with the blank being fluted, as shown in Fig. 499.

No. 10, Fig. 494, shows the method of cutting spur gears in the plain or universal milling machine. One or more of the gear blanks are mounted on a mandrel and placed between the centers, the gear cutter having been previously placed on the arbor and the table adjusted in and out so the center of the cutter falls in the line of the work centers. The index is set to give the correct number of divisions and the work elevated until the rotating cutter just touches the rim of the gear blank. The graduated dial on the elevating screw is then set to zero, the work moved out from under the cutter and raised an amount equal to the required depth of the tooth. Spur gears too large to swing between centers can often be cut by placing the index head spindle in a vertical position and carrying the blank on a vertical mandrel held in the spindle. This places the blank in a horizontal plane and the cutter is set to depth by the table feed screw and the work fed to the cutter by the vertical feed.

In Fig. 500 is shown a method of cutting a large spur gear in a plain milling machine using a plain dividing head clamped to a knee plate. The gear shown is 30 inches in diameter. The greatest care must be taken in an operation of this kind as the leverage on the spindle of the dividing head is considerable and the chances of shifting the work great, especially if the cutter is a little dull. By previously gashing the work with a plain cutter, the chances for a true job are very materially improved.

Another method of cutting large spur gears in the milling machine is illustrated in Fig. 501. This is known as the under cutting method which is accomplished by raising the dividing head and tail stock by means of suitable elevating blocks and providing a substantial outer support for the milling arbor. An adjustable post in the tail stock raising block can be brought to bear against the rim of the blank immediately over the cutter, thus taking the cutter thrust and relieving the centers of this strain.

The fluting of the tap shown at No. 11 is similar in all respects to the fluting of the reamer in No. 9. No. 12 shows the method of hobbing a worm gear, the blank having been previously gashed. The hob is a cutter of exactly the same shape as the worm that is to mesh with the gear and simply forms out the teeth, the blank rotating free on the centers. In gashing the teeth of the worm gear before hobbing, it is placed on the mandrel between centers and the index set for the proper number of

teeth. A gear cutter of suitable size to remove most of the stock, leaving only enough for the hob to finish, is placed on the arbor and brought central with the work. It is then necessary to swivel the table an amount C D E, Fig. 502, depending upon the pitch and diameter of the worm. The work is then raised to the cutter the proper amount and dropped for each succeeding cut. If the thread of the worm wheel is to be right-handed, the table is

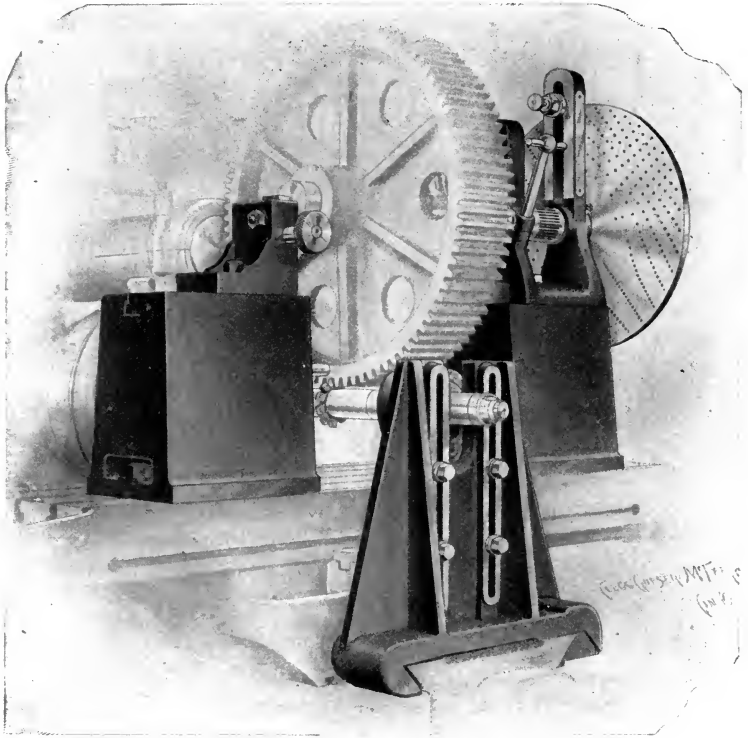

FIG. 501.

swiveled to the right, and to the left if left-handed. For the hobbing, the bed is set back to zero.

Bevel and miter gears may be cut in either the plain or universal milling machines when equipped with an elevating index head. The teeth so cut are of approximate outline, but sufficiently exact for all ordinary uses. As shown in Fig. 503, the gear blank is mounted on a suitable mandrel held in the chuck or, as shown, fitted to the spindle bearing of the elevating head. The head is then elevated until the root line of the tooth is

parallel with the work table. The proper cutter for the particular pitch and number of teeth is placed on the cutter arbor and brought central with the work. For any pitch the depth and width at the outer end of the tooth is the same as for spur gears. As the inner end of the space is narrower, the cutters for bevel gears must be thinner than for spur gears. The index having been set for the proper number of teeth a few center cuts are taken. The index pin is then advanced a few holes and the work moved out a few thousandths from the central position and the cutter again passed through the spaces already cut. This should remove some of the stock from the side of the teeth, taking more at the outer end than at

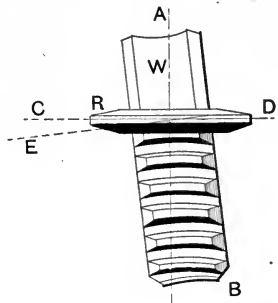

FIG. 502.

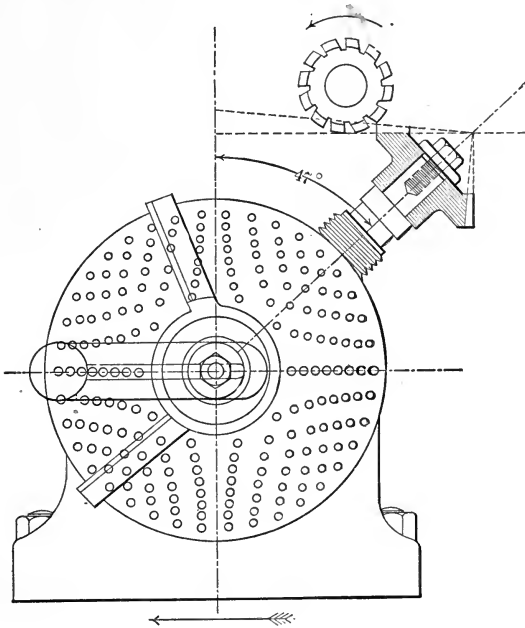

FIG. 503.

the inner end. The index pin is next carried back double the number of holes it was advanced and the work moved in double

the amount it had been moved out for the previous cut. This throws the cut on the opposite side of the tooth. As there is no fixed rule for the amount of these settings, the tooth must be measured and if not of proper thickness another trial setting must be taken. When the proper settings are found for any particular gear, they should be noted for future reference. The center cut is then not necessary as the tooth is finished by the two side cuts.

In Fig. 504 is shown a method of cutting bevel gears in a plain milling machine using a plain dividing head. A spline is milled in the face of the knee plate at the proper angle to

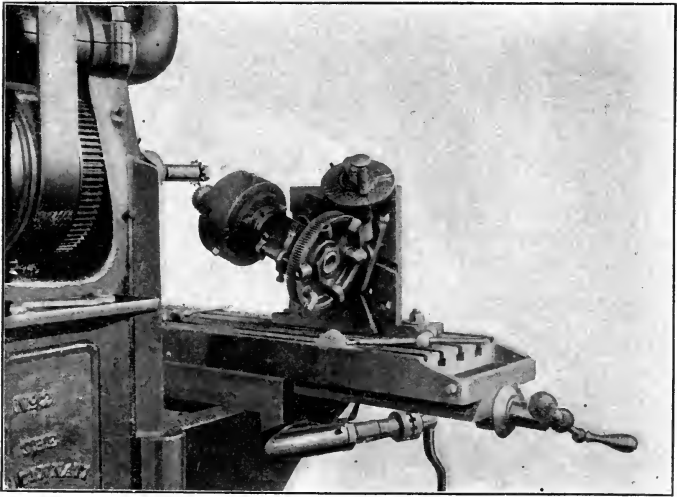

FIG. 504.

receive the tongues in the base of the head thus fixing the cutting angle. A separate spline must be provided for each angle of gear cut. When a large variety of gears, necessitating a number of different angles, are to be cut a plain graduated plate pivoted to the face of the knee plate and carrying the dividing head gives all angles. Where a graduated swivel base vice, as shown in Fig. 451, is available, it can be used to excellent advantage in cutting the splines in the knee plate at the required angle.

The method of cutting a twist drill in the universal milling machine is illustrated in Fig. 505. The settings are as for cutting a spiral gear, with this difference, that the depth of

the flute in a twist drill should be less at the shank end than at the point. It is therefore necessary to elevate the point somewhat. When the flute is to be cut from the very end of the blank, the shank must be held in a chuck on the spindle of the

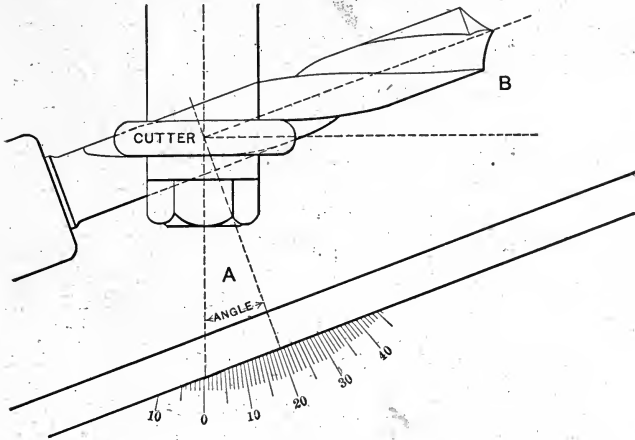

FIG. 505.

universal head, and for the outer end, supported on a suitable steady rest. If, however, the work can be carried on centers and the cutter dropped into its cut as close to the point as possible, better results can usually be obtained with less liability to accident. In this case, the head spindle can be dropped a few

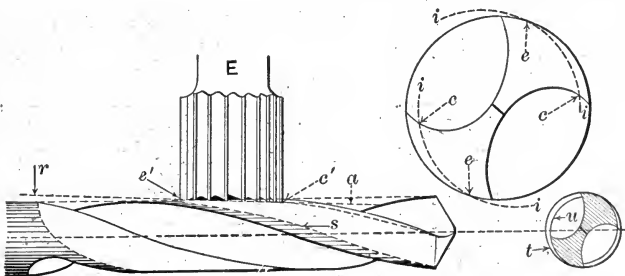

FIG. 506.

degrees below the horizontal position, or the tail center raised to give the proper taper to the web of the drill. The backing off of the lands of the drill, as shown in Fig. 506, is a somewhat difficult operation, requiring good judgment on the part of the

operator. The work table is swung through a small angle indicated by the line *r a*, which causes the end mill to cut deeper at *c* than at *e*, thus clearing the lip, as shown in the end view.

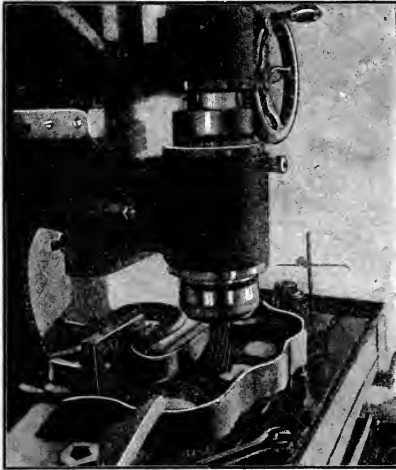

FIG. 507.

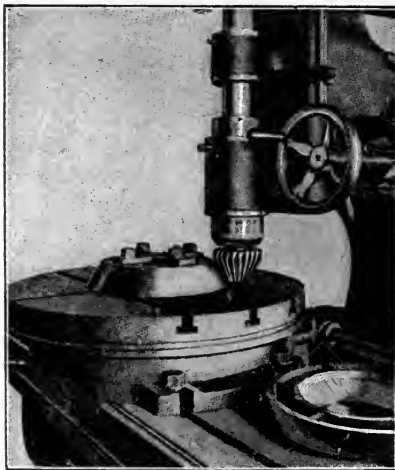

FIG. 508.

Figs. 507, 508 and 509 show examples of vertical milling machine work. In Fig. 507 the end mill in the vertical spindle is machining spots on the inside surface of a feed bracket cast-

ing. While this work, if clamped against a knee plate, could be done in a horizontal spindle machine with the same cutter, it would be much harder to hold and more difficult to get at for settings, measurements, etc. In Fig. 508, an angular cutter is shown, finishing the bevel face of a round casting, secured to a circular milling attachment. This work is done very rapidly and the same cutter is used to mill the internal face of the corresponding ring shown on the work table.

Frequently where duplicate work is held in the vise and its nature will permit, two vises placed side by side will greatly

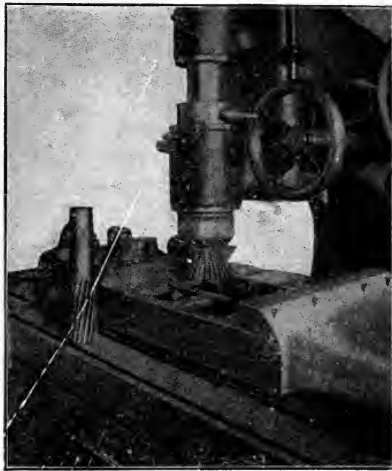

FIG. 509.

increase the output of the milling machine, as the work can be set up in one, while being machined in the other.

A large portion of the work done in a milling machine is held in the vise. Plain base vises as shown in Fig. 450 are provided with tongues which fit the wards in the work table and insure correct settings of the vise jaws, either parallel with or at right angles to the cutter arbor. With swivel base vises a graduation is usually applied with the zeros coincident when the jaws are parallel with the cutter arbor. To test the correctness of the zero setting, remove the collars on the arbor and move the table so as to bring the upper edge of the jaw at the height of the center of the arbor. Move the table longitudinally

until the jaw touches the arbor. If the contact is uniform the full length of the jaw, the setting is correct. This pre-supposes a true running arbor. Squaring from the front face of the column with an accurate square is equally satisfactory and the better method if the arbor is not dead true. For the 90 degree position square the jaw from the arbor.

Vise jaws are nicely finished and made of hard or soft steel, the hard jaws being most used. They are so secured that they may readily be removed and special jaws applied in their place. The faces are at right angles to the work table, which insures the milling of the top surface of work at right angles with its sides when clamped squarely in the jaws.

For the holding of round work a special V jaw as shown

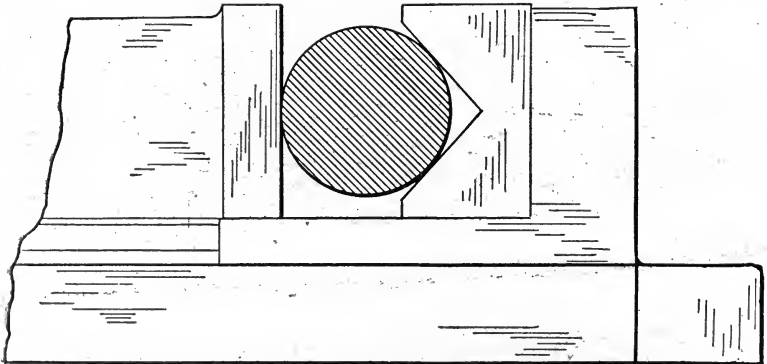

FIG. 510.

in Fig. 510 is well suited. This gives a three line contact between work and jaws and prevents the work from tipping up or down. It also insures, on work of equal diameter, the same height of setting, a very important condition, which is difficult to obtain with certainty when the work is allowed to rest on the face of the vise slide, or on a parallel. For much special work, false vise jaws can be used to very excellent advantage as they may be formed to irregular contours of either work or cutter.

In Fig. 511 is shown an example of heavy gang milling. In this case the seats for caps and quarter box cheeks are finished at once through. It involves the finishing of five horizontal and three vertical surfaces. The gang is made up of four standard cutters and one special inserted tooth cutter. The diameter

of the large cutter determines the rotative speed for the gang. On entering and leaving the cut a coarser feed can be employed than through the middle of the cut.

The advantages of milling this piece of work over planing it,

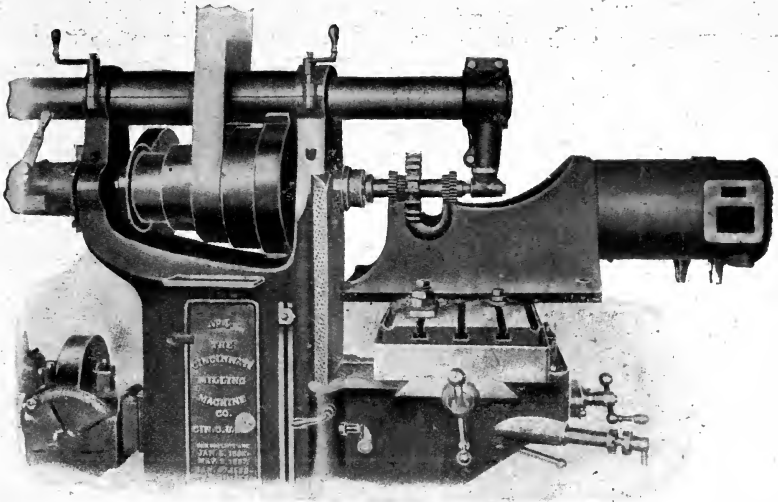

FIG. 511.

lie in the possibilities for perfect duplication in the former, as well as the time saving element, it being milled in approximately one-third the time required for planing.

In Fig. 512, is shown the stock, false vise jaws in which it is

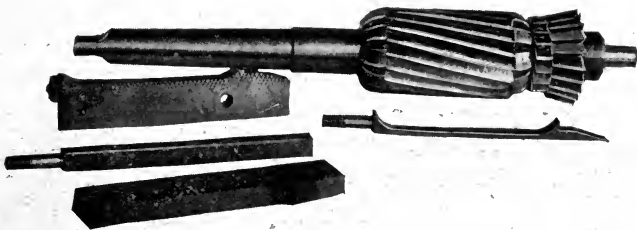

FIG. 512.

held and gang of cutters for the finishing the tool steel piece shown. The stock has had a screw machine operation upon it before coming to the milling machine. A suitable stop on one of

the jaws locates the work in the vise with reference to the turned shoulder. The jaws are hardened with roughed surfaces for firmly gripping the stock, and a copious supply of lubricant is used on the work and cutter. As the cut is very long and heavy for the size of the stock, $\frac{1}{2}$ inch square, it must be very firmly held and a fine feed employed.

In Fig. 513 is illustrated an example of jig milling. In this

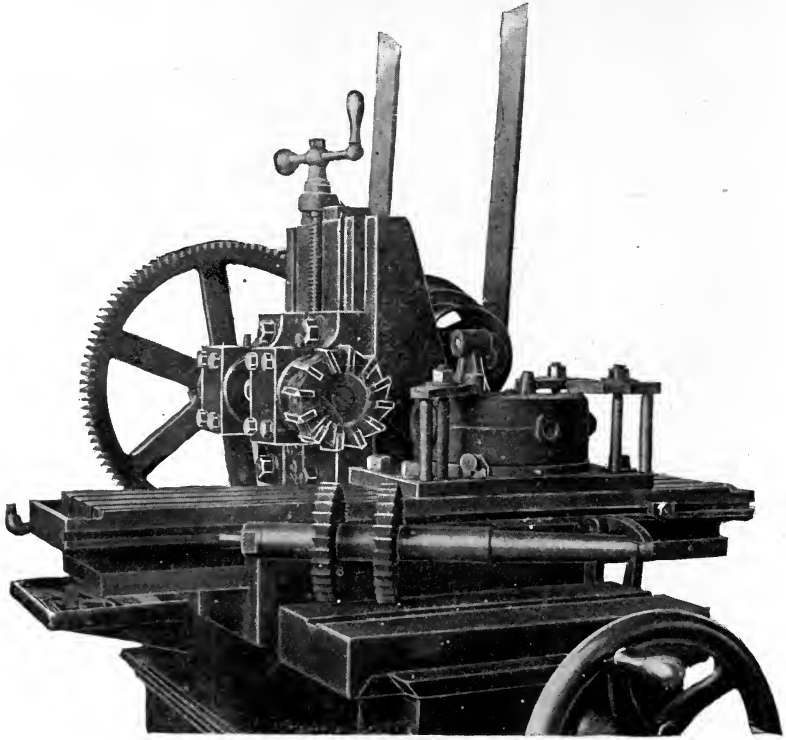

FIG. 513.

case the jig consists of a plate secured to the work table of the machine and a second plate pivoted to it. The work which has been previously bored and faced on its lower side fits over a projection on the upper plate which holds it concentric with the pivot. The work is squared up and the face mill machines one of the spots. The work is then rotated through 90 degrees, determined by a pair of stop pins, and the second spot machined. The pair of straddle mills shown are next used to face off the ends

of the hub of the upright part. It is possible in this way to machine any number of pieces and have them all alike.

The methods for securing work to the table of the milling machine are quite similar to those used on the planer. The same bolts, clamps and blocking being equally suited in both cases. It is ordinarily necessary to clamp the work quite securely as the tendency to shift under heavy cuts is great. As milling machine tables are not ordinarily provided with holes for stop pins, it is frequently necessary to bolt suitable stops to the table. A bar laid crosswise on the table and held with bolts in two or more of the T-slots makes an excellent stop. Round true iron washers bolted to the table may also serve as suitable stops.

Bars of cast iron planed true and having tongues on the bottom side to fit in the wards of the table will be found very con-

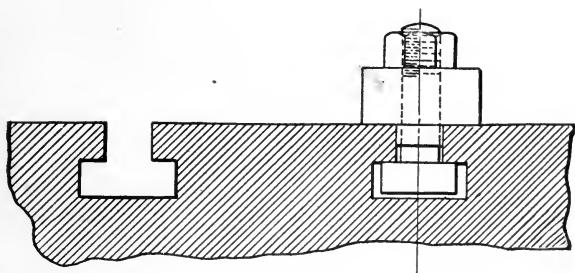

FIG. 514.

venient for much work that requires two surfaces to be milled parallel with each other. Such a bar is shown in end view in Fig. 514. They are simply used for setting the edge of the work against serving as a stop and insuring quick and accurate alignment. By making a casting in the form of a right angle triangle with tongues on one edge, a very satisfactory cross table stop is formed for milling surfaces at right angles to each other.

The knee plate is much used for holding work on the milling machine, and especially in the case of special work where a plate serves as a jig. It should be provided with tongues for properly lining it on the table, and when used for general work the upright arm should have a goodly number of slots or holes for receiving the clamp bolts.

Chuck work should be kept as close up to the jaws as possible, thus making it rigid. When it is necessary to operate on a

part of chucked work extending far out from the chuck jaws, it should be supported in some manner. A small adjustable center rest, usually furnished with universal machines or a small jack screw may be brought to bear immediately under that part of the work the cutter is to operate upon. With long work held between centers this support is also valuable.

In universal machines, taper milling may be accomplished with work between centers, as shown at 9, Fig. 494, by either raising the tail center or depressing the head center. As this throws the centers out of line, the rotation of the work causes the dog driving it to move in and out through the face plate. This is overcome by the use of the new dog and face plate

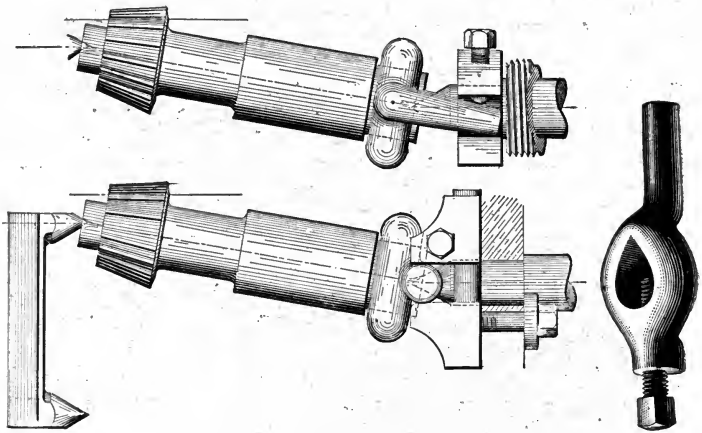

FIG. 515.

carrier shown in Fig. 515. When the work is held in the chuck it is necessary that the adjustment of head spindle be such that its center and the center line of the work remain in the same line, and point directly toward the tail center, as shown in Fig. 516.

Although the milling of cams is usually performed on a special cam cutting attachment, they may frequently be milled in a plain or universal head, using an end mill as shown in Fig. 516A. From the round disk shown in the chuck, which is of a thickness somewhat less than the diameter of the cutter and having a hub upon which the chuck jaws grip, the cam outline shown by the dotted lines is milled. As shown, the center of the mill is central with the disk. For the first or roughing cut, raise the table until the lower side of the cutter reaches the

center line a a of the work. This roughs down one of the straight sides of the cam. Next rotate the chuck slowly by means of the worm and gear until the cutter has roughed all the surface around to the point b. By next dropping the work, the other

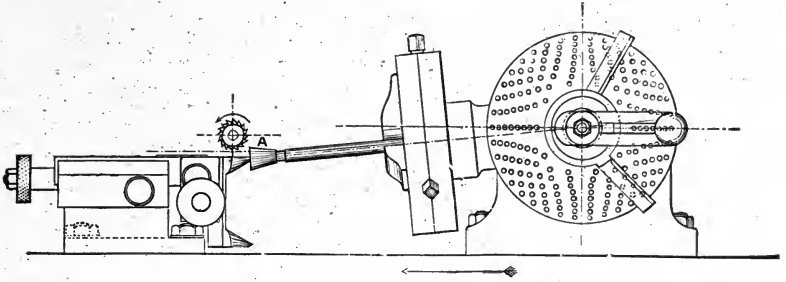

FIG. 516.

straight side is milled. As machined the two straight sides will be flat but the circular portion will be somewhat concave, due to the high position of the cutter. For the finishing cut the cutter should be set with its center at the height of the work center.

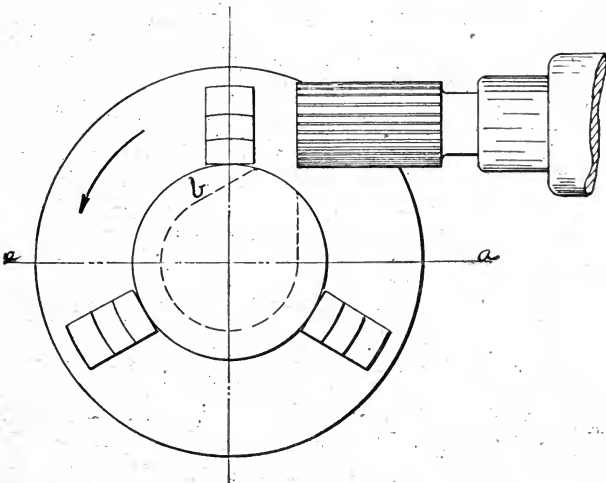

FIG. 516A.

This brings all of the work on the end of the cutter which leaves a straight surface, but does not cut as freely as when set for roughing. This class of work brings considerable strain and wear on the worm and gear of the dividing head.

Cutter vibration can usually be traced to some **slack** in table joints or spindle bearings. Heavy cuts on frail work are apt to chatter. Straight cutter teeth are much more apt to cause chatter than spiral ones. A harmonic relation between the numbers of teeth in the back gears and the number in the cutter, when the machine is running in back gear, is without doubt a frequent cause of chattering.

The graduated dials on all table feed screws are of great value in setting cutters in the proper position relative to the work. They should, when possible, be used for making these settings, care always being exercised in taking up the slack or back lash in the screws.

In the milling of steel and wrought iron a cutter lubricant is used. Lard oil is generally considered the best for this purpose, although its high cost often precludes its use some form of compound being substituted. Many of the soap and soda compounds are very good substitutes. The object of lubrication is to supply, not only enough of the lubricant to keep down friction, but enough to carry away the heat of friction and thus preserve the cutting edges and make possible higher cutting speeds. Cast iron and brass do not require a lubricant.

Castings that are to be milled should be free from sand and hard, flinty spots. It is desirable to pickle them and in the case of small castings, which are very apt to be hard, to anneal them. These operations are inexpensive and rapid and will save many cutters and much grinding.

CHAPTER XXVI.

GEAR CUTTERS AND GEAR CUTTING.

In the cutting or forming of gear-teeth two systems, known as the "duplication" and the "generation" systems, are employed.

The "duplication" system is the one most commonly employed and may be divided into two separate and distinct classes known as duplication by formed cutters and duplication by the templet-

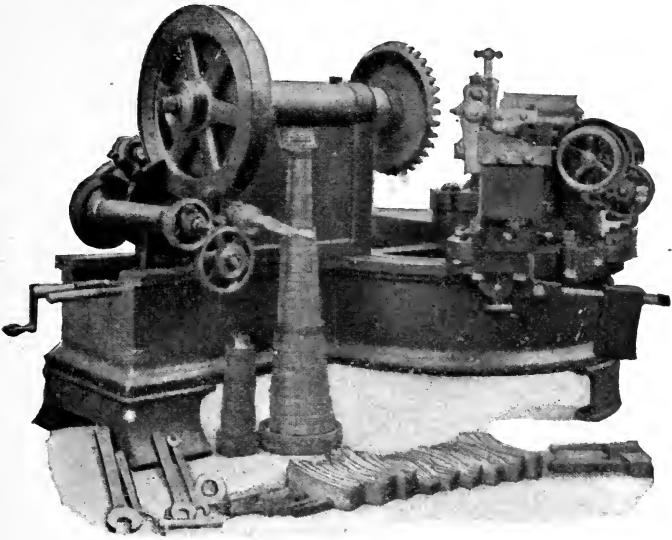

FIG. 517.

planing process. Duplication by formed cutters is the more common method and the one with which most shop men are familiar. It involves the cutting of the tooth space with a rotating or reciprocating cutter, the side of the tooth of which, has a formed outline which is a negative of the side of the tooth outline required. The accuracy of the tooth form is therefore dependent on the accuracy of the cutter's outline and theoretically a different form of cutter should be used for each number of teeth cut in each pitch.

In the templet-planing process the sides of the teeth are planed with a pointed tool, the path of the point being guided by a templet of the correct outline. This process is much slower than the rotating formed cutter method and consequently is little used for other than the cutting of miter and bevel gears, to which work it is admirably adapted. In Fig. 517 is illustrated the Gleason templet bevel gear planer and in Fig. 517A an outline of its movements showing how it is possible to make the point of the cutting tool duplicate the templet outline to a uniformly reducing scale from the outer to the inner end of the tooth, thus giving a correct outline tooth, its accuracy depending upon the accuracy of the templet. With the formed cutter it is possible in bevel gear cut-

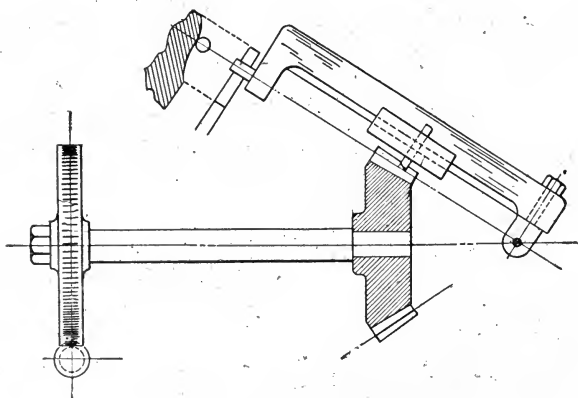

FIG. 517A.

ting to give a correct tooth outline only at one point in the tooth's length. The method is, however, much more rapid and for the finer pitches is much used. For the coarser pitches and relatively longer teeth, where quiet, smooth running gears are required, the planing process is used.

The generating of conjugate tooth outlines, or in other terms, the forming of the teeth upon cylinders that will cause them to roll together as the pitch circle of the one would roll upon the pitch circle of the other without slipping, is a condition that can only be obtained by a molding process.

When two newly cut gears run together, a molding process takes place, the high parts wearing down and gradually producing a smooth running conjugate tooth. If the teeth of one gear

were covered with fine file-like teeth it would quickly mold the teeth of the other gear.

The forming of teeth in this manner by a process known as the molding-planing process has but recently been put into a practical form for spur gear cutting in the Fellows gear shaper.

The single-tooth molding-planing process, as applied in the Bilgrim machine, generates conjugate teeth on miter and bevel gear blanks.

The making of formed gear cutters involves the laying out of the templet and making of the negative cutting tool as described in connection with Fig. 472.

As the tooth outline varies with the number of teeth in the gear a cutter can be made exactly correct for but one number of teeth. In practice, however, the outline varies so slightly, especially for the larger numbers of teeth, that one cutter, although exactly correct for but one number of teeth, is used for cutting quite a range of numbers. As the tooth outline changes very rapidly for the lower numbers of teeth the range is small for these numbers. In the involute system the permissible range is much wider than in the cycloidal system. In the following table is given the numbers and range of Brown & Sharpe involute gear cutters:

No. 1	will cut wheels from 135 teeth to a rack.
" 2	" " " " 55 " " 134 teeth.
" 3	" " " " 35 " " 54 "
" 4	" " " " 26 " " 34 "
" 5	" " " " 21 " " 25 "
" 6	" " " " 17 " " 20 "
" 7	" " " " 14 " " 16 "
" 8	" " " " 12 " " 13 "

In cases where a finer division is required in the number of teeth to be cut with each cutter, as sometimes occurs when very smooth running gears are required, intermediate cutters between those regularly used may be had on special order. The range of these cutters is given in the following table:

No. of Cutter.	Range.	No. of Cutter.	Range.
$1\frac{1}{2}$	80 to 134 teeth.	$5\frac{1}{2}$	19 to 20 teeth.
$2\frac{1}{2}$	42 " 54 "	$6\frac{1}{2}$	15 " 16 "
$3\frac{1}{2}$	30 " 34 "	$7\frac{1}{2}$	13
$4\frac{1}{2}$	23 " 25 "		

In the cycloidal system 24 cutters are required for cutting all numbers from 12 teeth to a rack as given in the following table:

Cutter A	cuts 12 teeth.	Cutter M	cuts 27 to 29 teeth.
" B	cuts 13 "	" N	cuts 30 to 33 "
" C	cuts 14 "	" O	cuts 34 to 37 "
" D	cuts 15 "	" P	cuts 38 to 42 "
" E	cuts 16 "	" Q	cuts 43 to 49 "
" F	cuts 17 "	" R	cuts 50 to 59 "
" G	cuts 18 "	" S	cuts 60 to 74 "
" H	cuts 19 "	" T	cuts 75 to 99 "
" I	cuts 20 "	" U	cuts 100 to 149 "
" J	cuts 21 to 22 "	" V	cuts 150 to 249 "
" K	cuts 23 to 24 "	" W	cuts 250 or more.
" L	cuts 25 to 26 "	" X	cuts Rack.

For bevel gear cutting, involute teeth, eight cutters having the same range as above given are required. These cutters differ from those used for spur gearing in that they are considerably thinner, a condition made necessary by the cutters having to pass through the narrow end of the tooth space. The regular bevel

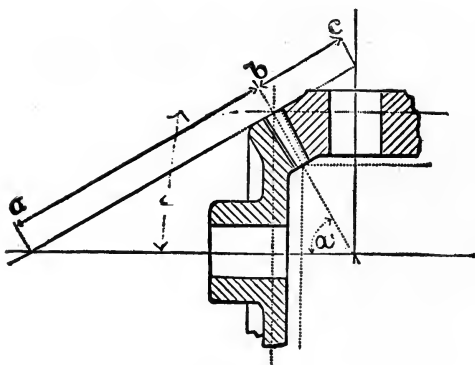

FIG. 518.

gear cutters are thin enough to pass through the narrow end of the space where the length of the tooth is not more than 1-3 the distance from the outer end of the tooth to the point at which the axes intersect. Where an extra length of tooth is required, an especially thin cutter must be used.

Cutters for spur gears have the pitch and the range of teeth stamped on them. Cutters for bevel gears have the pitch, but not the range stamped on them, inasmuch as the range does not ordinarily correspond to that given for spur gears. The selecting of

the proper cutter for a spur gear is therefore a simple matter, as it is only necessary to know the diametral pitch and the number of teeth. With bevel gears, however, the following considerations are necessary. In any pair of bevel gears lay off the back cone radius a , b for the gear, and b , c for the pinion, Fig. 518. Considering the gear, r is the actual pitch radius and upon which the pitch and number of teeth depend. The outline of the tooth, however, is the same as for a spur gear, having a radius a , b . Take, for example, r as equal to 4 inches, and assume No. 6 diametral pitch, which would give 48 teeth in the gear, requiring, if it was a spur gear, cutter No. 3. The back cone radius a , b measures 8 inches, requiring a tooth outline the same as a spur

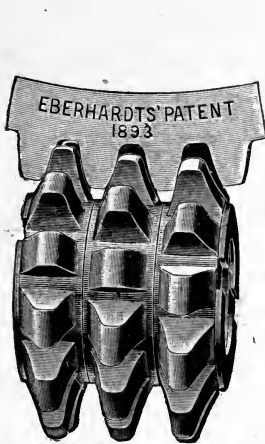

FIG. 519.

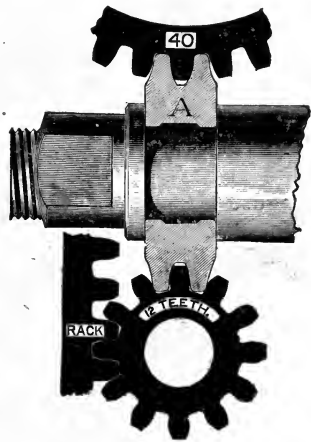

FIG. 520.

gear of 96 teeth, or cutter No. 2, which would be the correct cutter to use.

In Fig. 519 is shown the Gould & Eberhardt duplex gang gear cutter, which consists of two or more cutters mounted together and of such diameters and forms as to cut and correctly finish two or more teeth at each passage through the blank. An inspection of the figure shows the central cutter to be of normal diameter and symmetrical with reference to a central plane. The side cutters are somewhat larger in diameter and the center line of the front face of each tooth is coincident with a radius of the blank. It is evident that but one diameter of gear can be cut with each gang, and the larger the diameter of the blank for a given

pitch, the more cutters it is possible to mount in one gang. This condition at once makes the gang a purely manufacturing tool, which can be advantageously adapted only in cases where large numbers of each size of gears are to be cut. In using these gangs, care must be exercised in setting to the exact depth of cut and that the blanks are of exact diameter, as inaccuracies in these conditions will produce thick or thin teeth.

These cutters are ground from the front face without changing their form. With these gangs as many as ten finished teeth may be cut at one passage through the blank. Under ordinary conditions the excessive heat generated by the removing of so much stock necessitates a somewhat slower rate of feed and cutter rotation than can be employed with single cutters. A jet of compressed air directed against the work and cutters makes possible much higher speeds.

The Clough duplex cutter, as shown in Fig. 520, although a form of gang cutter, finishes but one tooth at a time. The object of this cutter is to produce gears having a widely different number of teeth, that will interchange with a single cutter. Correct tooth outline must of necessity be sacrificed in accomplishing this end. Gears cut, however, with these cutters run fairly well together and will work with gears cut with regular involute cutters. Gears having 30 teeth or over are finished entirely by the inside faces of the cutter. For numbers lower than 30 the flanks are finished by the outer faces of the cutters.

The methods of cutting spur and bevel gears already described in Chapter XXV., require the continuous attention of the operator with a constant danger of his making an error in division. Automatic gear cutting machines insure better gear at very much lower cost. In Fig. 521 is shown an automatic gear cutter capable of cutting spur gears only up to 40 inches in diameter by 9 inches face.

In Fig. 522 is shown an automatic gear cutter for cutting both spur and bevel gears up to 18 inches diameter by 4 inches face.

In these machines all movements are entirely automatic. The work is secured to the dividing head spindle; the necessary change gear adjustments made for dividing the work; the work set to the cutter so as to cut the proper depth of tooth, the correct cutter having previously been put on the cutter spindle, and the machine started up. When the feed is thrown in the cutter advances

through the blank at the required rate of feed, automatically reversing when the cut has finished and returning the cutter slide at a quick speed. When the cutter on its return stroke has cleared the work, the dividing mechanism spaces for the next tooth and

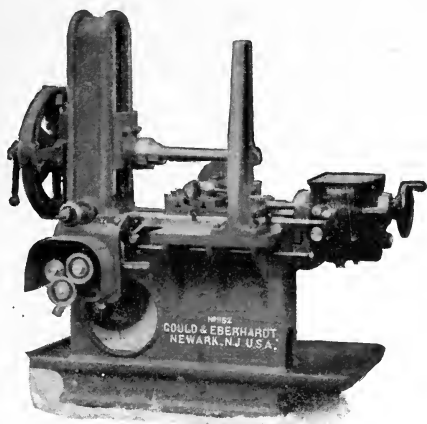

FIG. 521.

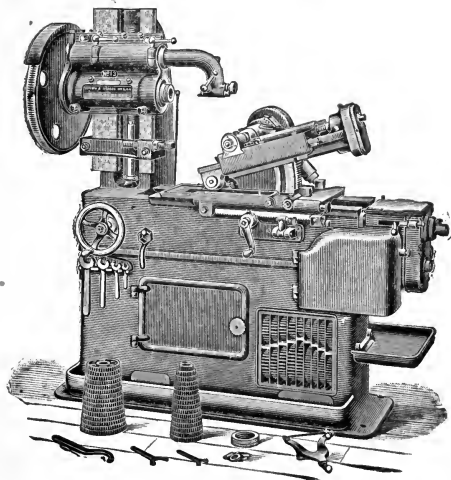

FIG. 522.

the cycle of operation is again gone through, repeating itself without further attention until the work is finished.

For the cutting of bevel gears in the automatic machine it is necessary that the cutter slide be so constructed that it can be set

at any angle between a horizontal and a vertical position. As with the cutting of bevel gear in the milling machine, the cutter must pass twice through each space, the automatic features of the machine, however, remaining the same as for spur gear cutting.

Due to their smoothness of action, spiral gears running in oil are largely used for driving the cutter spindle. As the center of the cutter must, for spur gear cutting, be under the center of the work and as the cutters vary in thickness, it is necessary to give the spindle an adjustment endwise and to provide a suitable gauge for setting the cutter central.

The feed to the cutter slide on the machines shown is accomplished by a slow rotation of the feed screw, which rate can be varied within necessary limits by a change of gearing. The automatic disengaging by stops of the clutch, which engages the forward driving gear with the feed screw, stops the feed. The same movement engages the screw with a quick-running reverse gear which brings the slide back very rapidly. The changes from the one movement to the other occur without pause or shock.

The exactness with which the dividing mechanism performs its work is dependent upon an accurately cut worm gear and worm; accurately cut change gears; nicely fitting bearings and adjustments permitting of no back lash; and an escapement movement which allows the locking disc-shaft to make exactly one revolution, or, as is the case with the Brown & Sharpe machines, two or four revolutions at the time the division is made. In these machines a side shaft rotating at a constant rate of speed carries a clutch which at the instant of the tripping of the escapement stop engages the locking disc causing it to rotate through one, two, or four revolutions, depending on the setting. This has the advantage of reducing the number of change gears necessary.

Referring to Fig. 523, B is the gear on the locking shaft, C and D are intermediate gears on a stud, and E is the worm gear, which transmits its motion to the worm through a pair of miter gears. The number of teeth in the worm divided by the number of teeth to be cut, represents the ratio that must be made up by the change gears. Thus if 120 teeth are required the ratio is one, and gears must be selected that will give this ratio, as B 50, C 50, D 60, and E 60. If, for example, 82 teeth are wanted,

$$\frac{120}{82} = \frac{60}{41} = \frac{2}{1} \times \frac{30}{41}$$

giving gear B 100, C 50, D 30, E 41. As a gear with 41 teeth is not available, 60 and 82 may be used on D and E. If in the latter case 41 teeth were wanted, two revolutions of the locking disk could be employed, using the same change gears.

Where work of small diameter is operated upon, the outer end of the work mandrel is supported by an overhanging arm and no further support is necessary. If of large diameter the end of the mandrel is carried in an outboard support, and a rim support steadies the blank immediately back of the cutter. In setting the work to depth it should be lowered until the revolving cutter just touches the circumference, and the dial on the elevating screw then set at zero. It should then be dropped the required amount for

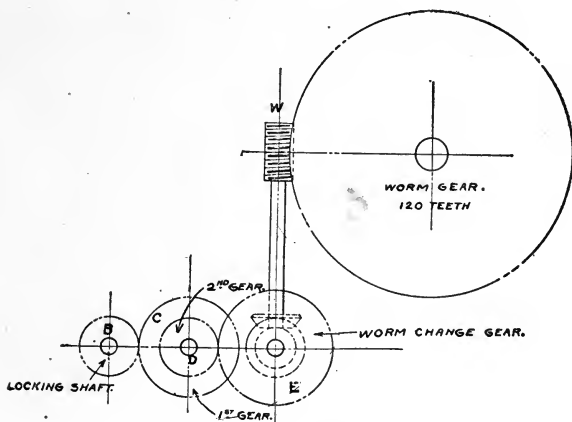

FIG. 523.

the cut by passing somewhat beyond the required distance and turning up to the mark, thus avoiding any error due to back lash in screw and connections.

Gear cutting machines when used on steel gears are provided with an oil pump for supplying a liberal amount of screw cutting oil on cutter and work. In the cutting of steel gears, when properly lubricated, a high rotative cutter speed with very fine feeds are usually advisable. The lubricant prevents the heating of the cutter and the fine feed overcomes its tendency to "hog" into the work.

The cutting of bevel gears in the automatic machine shown in Fig. 522 does not differ materially from the milling machine method described in connection with Fig. 503. The side move-

ment is given the cutter rather than the work, and the same care and judgment must be exercised in making the preliminary settings. In the cutting of heavy pitch and steel bevel gears, it is usually advisable to make a center cut, thus necessitating three cuts for each tooth.

The cutting of racks may be accomplished in the milling machine by use of a special attachment, as shown in Fig. 458; on the automatic gear cutter by means of a suitable attachment or

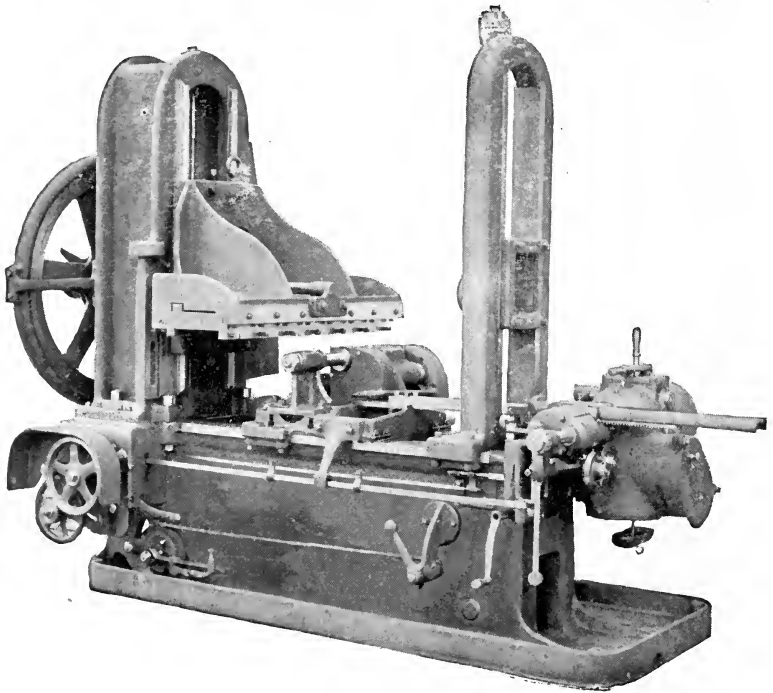

FIG. 524.

on a special automatic rack cutting machine. An attachment for the automatic gear cutter is shown in Fig. 524. A cross rail is secured to the front of the upright, and this is mounted on a sliding head with provisions for clamping the rack blank on its under surface. A pinion on the nose of the dividing spindle engages a rack on the head, thus making it possible to automatically move the head the correct spacing for each passage of the cutter through the blank. Gang cutters can be advantageously used in rack cutting. All cutters must be of exactly the same diameter and

mounted on the arbor with their centers the exact pitch distance apart. Where large amounts of rack are to be cut, machines for that special class of work are employed.

The Fellows gear shaper, above referred to, is shown in Fig. 525. The cut illustrates a front view of the machine at work on an internal gear. The cutters are illustrated in Fig. 526, and the method of securing them to the cutter spindle is shown in Fig.

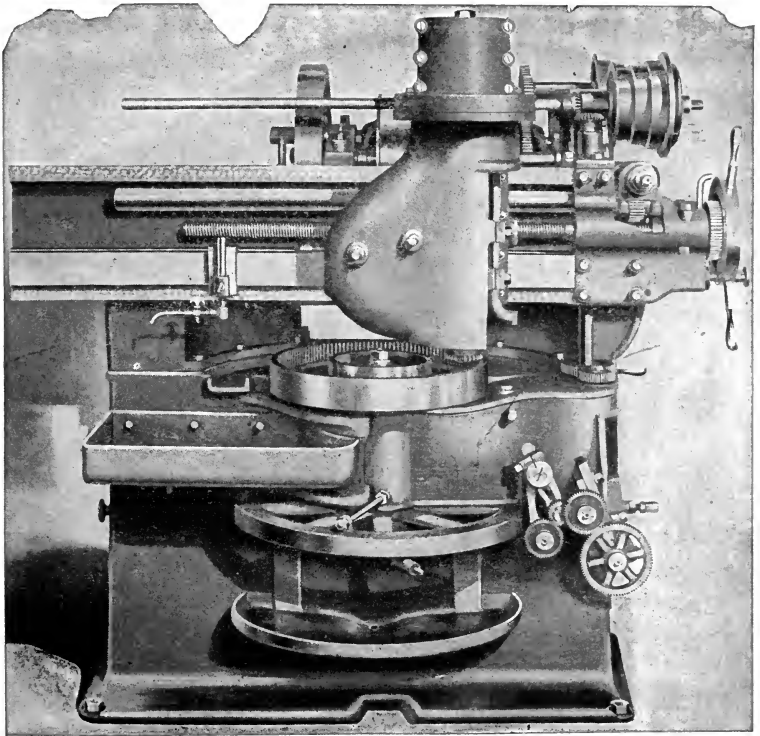

FIG. 525.

527. As already stated the cutter is a correctly formed gear dished on the cutting face in order to give it an angle of rake. The cutter, although resembling a spur gear, is in reality a bevel gear, having a very small center angle. This feature gives the cutter the necessary clearance in the work. Upon the correct forming of the cutter depends the accuracy of the work produced on this machine.

Since the side of the tooth of an involute rack is a straight line, the substitution of the face of a cutting wheel for the side of the

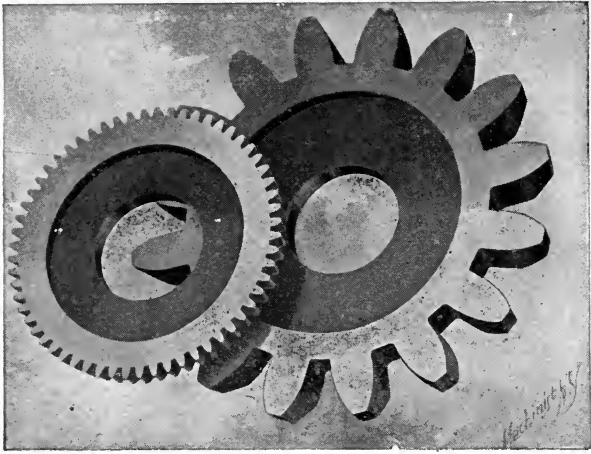

FIG. 526.

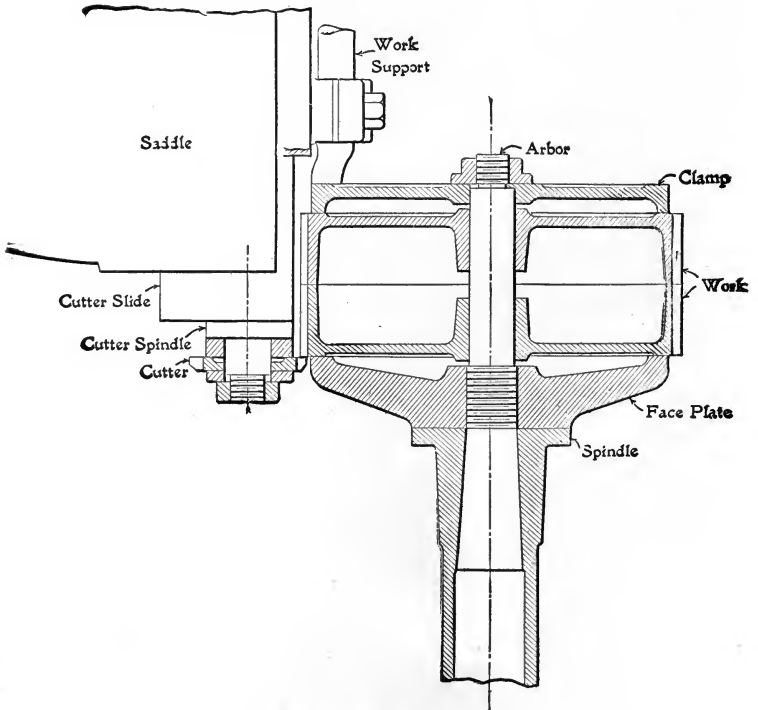

FIG. 527.

tooth would by the molding process produce a correct involute outline on the tooth of any gear that, meshing with the rack, was caused to pass this cutting face. Upon this fact is based the method by which the Fellows cutter is finished. The cutter having been planed from a blank, as shown in Fig. 528, and hardened, is put on a special grinding machine and the tooth outlines ground to the correct form, the operating of the machine depending upon the principle above explained and clearly illustrated in Fig. 529. The rack, of which the face of the wheel forms the side of one tooth, is a fixed imaginary one and the cutter blank is given, by a suitable mechanism, a true rack and pinion motion

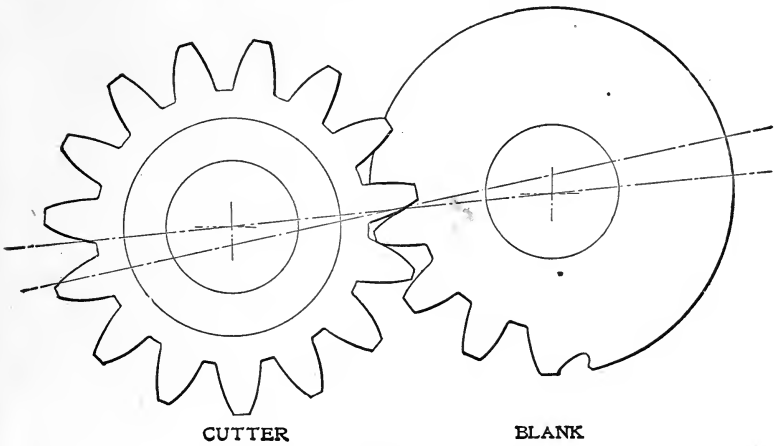

FIG. 528.

past the face of the emery wheel, which grinds the sides of the teeth, one at a time, to the correct form.

In its operation the cutter and blank are so geared together that they rotate the same as two complete gears in proper mesh. After starting the machine, the cutter is fed toward the blank until it has cut the exact depth of the tooth. Rotation which corresponds to a feed then begins, a small amount at the beginning of each stroke, when the cutter is clear of the work and continues until the cutting is finished.

The method of holding the work is shown in Fig. 527, a suitable face-plate and clamp with a work support in connection with the draw stroke on the cutter making a very rigid combination. When the character of the work necessitates it, the cut can be

taken on the down stroke, such usually being the case when cutting internal gears. The stroke of the cutter ram is adjustable, as to length and position.

Since the teeth of the cutter are conjugate to the generating rack, all gears cut with the cutter are conjugate to it and to each other. One cutter will therefore cut all gears from a pinion to a rack.

Bevel gears having the octoidal form of teeth are cut theoreti-

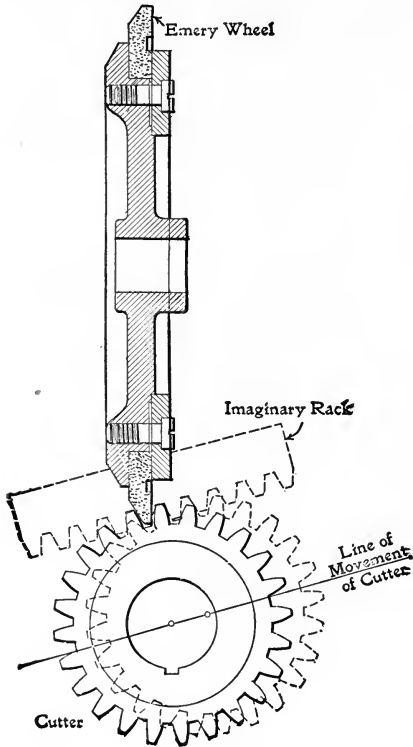

FIG. 529.

cally correct by a molding planing process in the Bilgram bevel gear planer, Fig. 530. The generating tool has a straight cutting edge and is given a motion parallel with the root of the tooth and constantly moving toward the apex of the pitch cone.

In this machine the gear blank is given a rolling motion as it swings under the cutting tool. This motion is accomplished by means of a pair of bands wrapped about a portion of a conical

surface, having its apex in the intersection of the axis, upon which the blank is mounted and the pivotal axis of the head. The adjustments of the machine are such that the motion given the blank is the same as it would receive if it was rolling in gear with a circular rack. As the cutting of the tool corresponds to the straight side of the rack tooth, its action is to generate a conjugate tooth on the blank. The indexing mechanism spaces the teeth and the feed rotates the blank slightly for each stroke of the cutter.

In the cutting of worm gears by the hobbing process is illus-

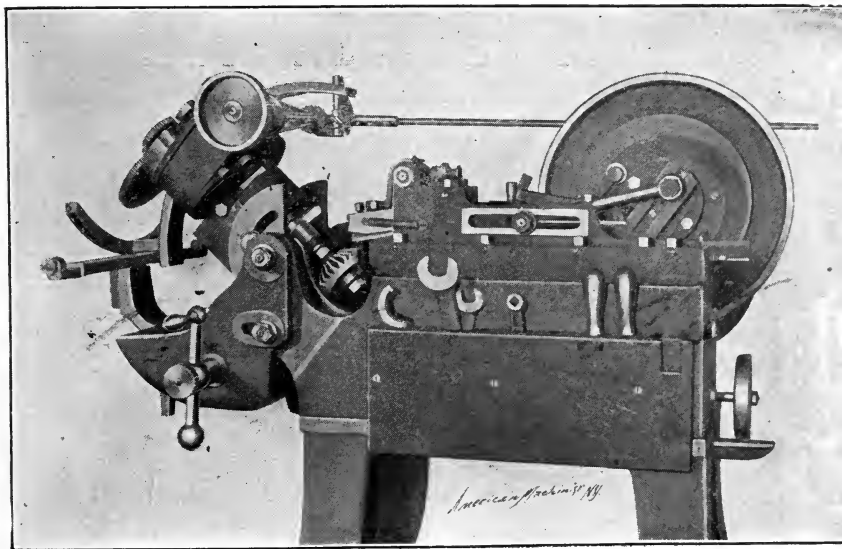

FIG. 530.

trated a method of producing conjugate teeth by a rotating cutter. This operation as performed on the universal milling machine is described in connection with 12 Fig. 494 and Fig. 502.

On machines designed specially for hobbing work and known as hobbing machines, the work spindle and hob are geared together by means of a suitable system of change gears, thus driving the work blank at the proper speed relative to the cutter rotation. With machines of this class it is not necessary to prepare the blank by gashing, as the gearing insures correct spacing. This method is clearly shown in Fig. 531, which illustrates the Whitney attachment for the hobbing of worm gears on a plain

milling machine. As clearly shown a pattern worm on the work spindle, having the same number of teeth as required on the work, gears with the hob.

Spiral gears are usually cut in the universal milling machine with a formed disk cutter mounted on the regular cutter arbor, or preferably on the spindle of a universal milling attachment, as shown in Fig. 454. In the latter case the setting for the spiral angle is made by swinging the auxiliary cutter arbor to the required angular position which is a very desirable feature in the cutting of short pitch spirals.

As is the case with the teeth of bevel gears, spiral gear teeth can be formed theoretically correct by a planing process in which

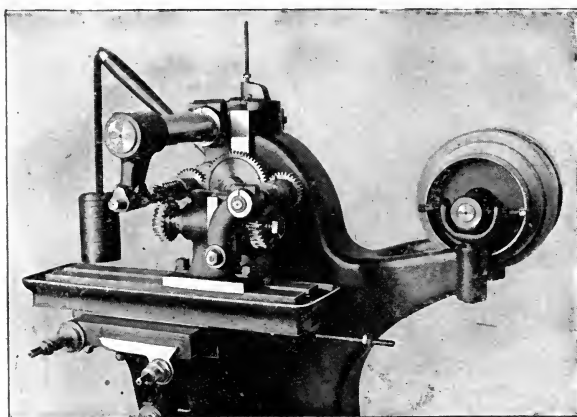

FIG. 531.

the cutting tool is given a rolling feed that causes it to follow the outline of the tooth, the work being rotated as it advances to the tool at the proper rate to produce the required spiral.

The teeth may also be correctly formed by using a planing tool of the same outline as the normal tooth space, the blank being again rotated to produce the proper spiral. Teeth of spiral gears in which the spiral angle is great, as in a worm, are usually formed by this method in a screw cutting lathe.

As the planing process is necessarily an expensive one, the more rapid yet less accurate method of milling is usually used. For this method two forms of cutters are used, the disk cutter, the same as used for spur gear cutting, and the end or shank cutter. Of these the latter is used only when cutting low numbered pinions,

where the root outlines of the teeth are so nearly parallel that a disk cutter would clip off the teeth too much, thus making the space wide and the tooth thin, as well as destroying the form of tooth section.

The end cutter is given the same shape as the desired tooth space and rotates at right angles to the axis of the blank, both axes being in the same plane. The end cutter is a delicate tool that rapidly loses its form and does not produce a spiral groove or tooth space having exactly its outline.

The disk cutter is best suited to this work, as it cuts faster and retains its shape well. When made of small diameter it can ordinarily be used on low numbered pinions with satisfactory results. In its use the axis of the blank must be placed at 90 degrees, minus the spiral angle, from the cutter arbor, the direction in which the angle is measured depending upon whether the spiral is to be right or left handed. The blank as it is fed to the cutter is given the proper rotation to produce the required spiral.

As the disk cutter operated in the universal milling machine forms the most practical method of producing spiral gears, we will consider that method of cutting in the following examples.

In preparing to cut a spiral gear in the universal milling machine the operator should observe the following points: Having selected the proper cutter and secured it well toward the outer end of the arbor in order to allow plenty of room to swing the table without striking the housing, or upon the spindle of the universal attachment, he will proceed as follows: First, move the saddle until the centers of the spindle and center plane of the cutter coincide. This will bring the center of the cutter over the center about which the work table rotates in setting for the spiral angle.

Adjust the dividing mechanism to give the number of teeth desired the same as for spur gear cutting and release the pin on the back side of the index dial so that the dial may rotate with the worm spindle.

The spindle must be geared with the feed screw in order to obtain the required pitch of the spiral. A table furnished with the machine will give the change gears to use for a large range of pitches. If the pitch required does not exactly coincide with any given in the table, it will usually be sufficiently correct to use the one nearest the proper pitch.

The spindle will have right or left hand rotation, depending on whether the gear is to have right or left hand spirals. The

direction of rotation is changed by driving through an idle gear carried on a second stud.

Next swing the table, or the universal spindle as the case may be, through the spiral angle and elevate the knee until the revolving cutter touches the circumference of the blank. Back the blank from under the cutter and again elevate the work, this time an amount equal to the depth to be cut in gear. In returning, lower the work a little so as to clear.

CHAPTER XXVII.

DRILLING MACHINES AND DRILLING WORK.

Drilling machines constitute a class of machine tools which has developed from the lathe. The standard drilling machine in its various forms consists primarily of a revolving spindle for carrying the cutting tool; a work holding table and a substantial frame connecting the two. The details of spindle adjustments and spindle drives and feeds, while differing in points of detail in the several designs and classes, all bear close mechanical relations with each other.

The specific field for this class of tools is the drilling and boring of holes of comparatively small diameters. The reaming and tapping of these holes are in many cases added to the work of the drill and by means of special tools and fixtures much work formerly done in the lathe is now being performed on drilling machines. The relative importance of this class of tools in manufacturing shops has been measured largely by their ability to do strictly drilling work. As a manufacturing tool, it is, however, due to its simplicity, the readiness with which it can be ganged, and its comparatively low cost, rapidly growing in favor.

In Fig. 532 is shown a standard pattern upright drill. This is a back geared machine, the back gear mechanism being inclosed in the upper horizontal spindle cone. This gives the spindle eight speeds. The spindle has a three-speed automatic feed with an automatic stop for knocking the feed off at any required position of the spindle. Both wheel and lever feeds are also provided with a provision for quickly moving the spindle when the worm on hand wheel is disengaged from its gear. The rack and pinion method of moving the spindle is common to practically all makes and styles of drilling machine. The spindle has its lower bearing in a quill which is given a close sliding fit in the head. The feed rack is secured to the quill. The machine shown is of the sliding head pattern, the head having a vertical adjustment on the front face of the column to adapt the machine to work of different heights and drills and tools of varying lengths. The head is counter weighted by an equivalent weight on the inside of the column and

attached to the head by the chain shown. The head can be firmly clamped in any position.

The work table is supported on an arm, which is moved over the column by means of the screw and crank shown. It can be swung to a considerable angle either side of the spindle and firmly

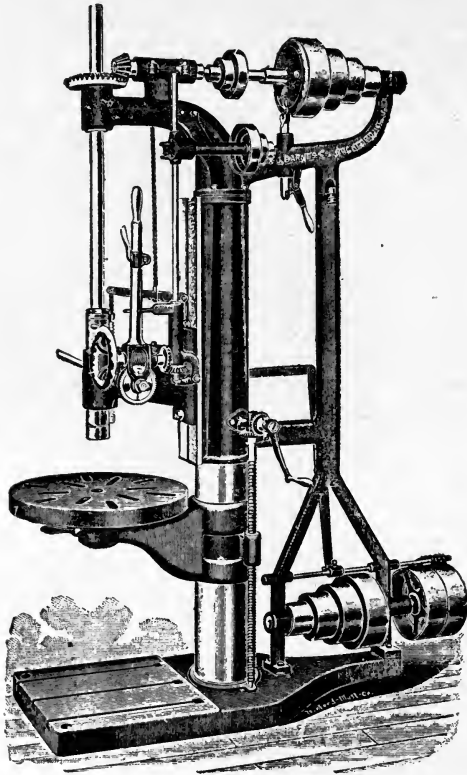

FIG. 532.

clamped in any position. For work too high to be supported on the adjustable table, the lower base table is used.

On the smaller machines of this class, a stationary head is used, all the vertical adjustment being given the table. Machines of this general design are regularly made up to 52 inches capacity, the size indicating the maximum diameter of work, the center of which can be reached by the spindle.

For driving small drills, a light machine should be used in

order to obtain the high speed required and the lightness of parts necessary to make the machine sensitive. By the term sensitive, as applied to small drilling machines, is commonly understood that lightness of parts, smooth running and perfect balance which enables the operator to judge as to the pressure he is applying to the drill and consequently lessen the danger of drill breakage. In addition to the above features some builders go a little farther and employ at some point in the drive an adjustable friction which can be so set as to just drive the drill being used.

In Fig. 533 is shown a simple and efficient friction driven sen-

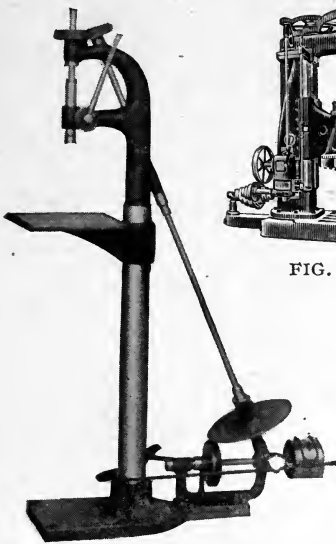

FIG. 533.

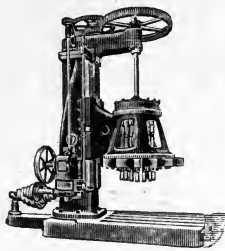

FIG. 535.

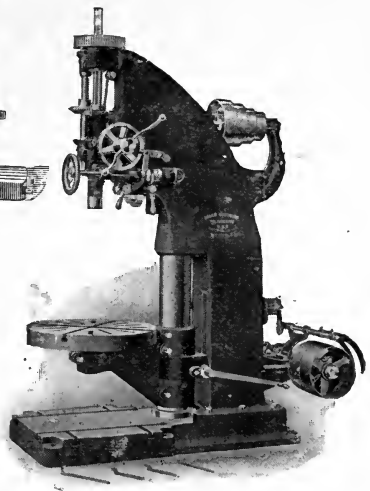

FIG. 534.

sitive drill. The friction driver is adjustable to compensate for wear only. The speed of the spindle is varied by the position of the driving friction wheel.

In Fig. 534 is shown an example of a very heavy upright drilling machine. This machine is designed for very heavy work, as the boring and tapping of flanges. It is of massive proportions and powerfully geared.

When, as illustrated in Fig. 535, a number of drilling spindles are driven from one main spindle, the machine is known as a multiple spindle drill. In the drill shown, the spindles can be set at any desired position within the limiting circle. This is a manu-

facturing tool adapted to the drilling of such work as cylinder heads, chest covers or any machine part where a number of parallel holes can be drilled at the same time and setting. These machines are also made in a horizontal style with one or two heads for such work, as the drilling of cylinder ends.

When several complete machines, each having a single spindle,

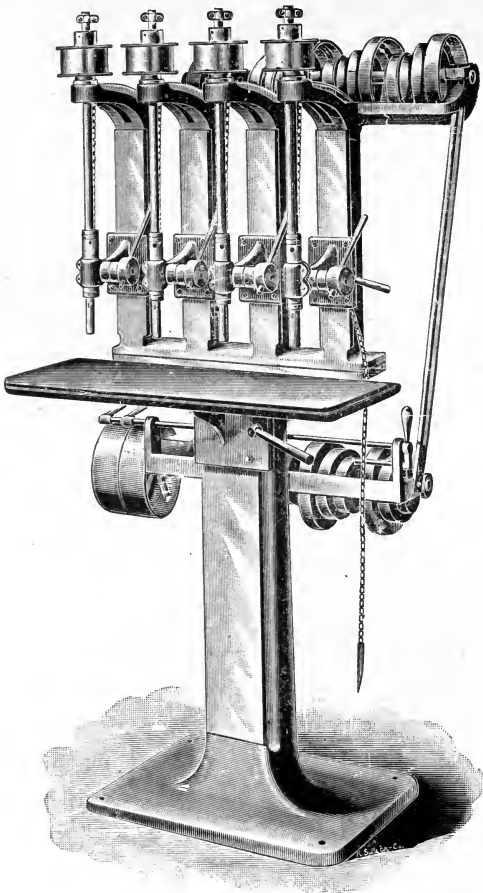

FIG. 536

are mounted upon a common base and driven either independently or as a single machine, they are known as gang drills. They possess many advantages and as manufacturing tools are coming into quite general use.

In Fig. 536 is shown a four-spindle 14-inch gang drill, which

illustrates favorably this class of drills in the smaller sizes. They are made with two to eight spindles in this general style. When larger numbers of spindles are required, as for the drilling of boiler plates, or bridge and structural work, the design is materially modified, the spindle heads being mounted on a cross rail which is supported at the ends by rigid housings resting on a heavy base with fixed or adjustable work table.

With gang drills, as with multiples, the operating economy is evident when the work will admit of their advantageous use. With the gang drill when each operation on the work is short, a single piece of work is carried from spindle to spindle, but one spindle

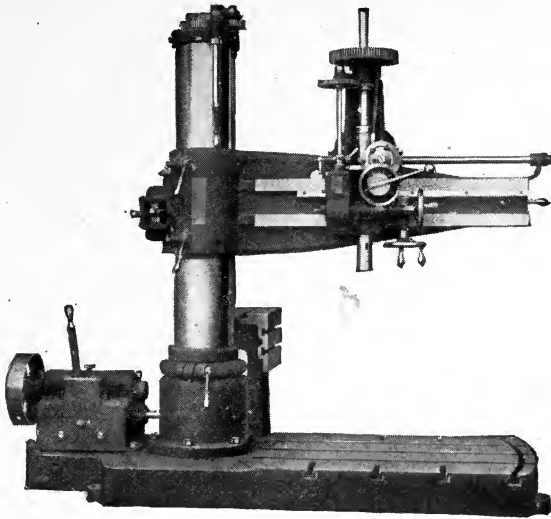

FIG. 537.

working at a time. The saving here comes from not having to stop and start spindles and change tools. When the length of time required for each operation will permit the use of the automatic feed, each spindle may be kept constantly at work, it being only necessary to stop it long enough from time to time to take out the finished piece and put in another. When so operated the timing should be so arranged, if possible, that all spindles except the one at which the work is being changed are working.

The automatic feed and feed knock off are quite necessary for the latter class of operations.

When work of large diameter is to be drilled near its center,

drilling spindle is mounted on a swinging frame which allows the spindle to be set at any angle, in a vertical plane, parallel with the face of the arm. In the "full" universal radial the arm is pivoted to the butt in such a manner that its face can be rotated through a complete revolution, thus making it possible to drill holes at any desired angle with the base.

For a large portion of the angular drilling work put on these machines, the universal drilling table, Fig. 538, in connection

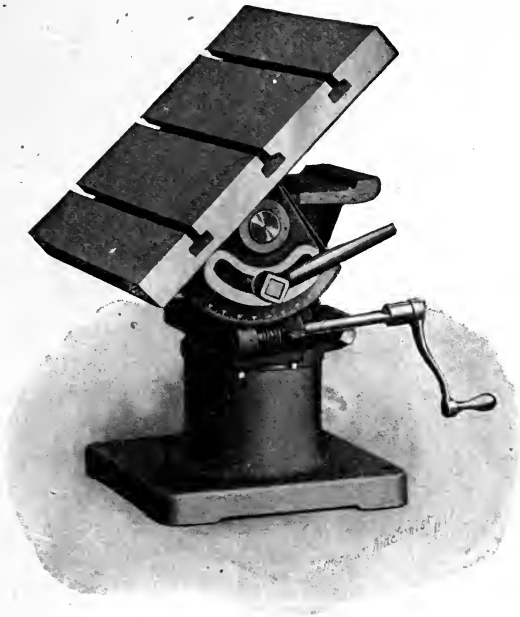

FIG. 538.

with the plain radial machine, is well suited. In this case the work rather than the spindle is set at the required angle.

On classes of work where each operation is short, and as a consequence it is not economical to attempt to work on more than one piece at a time, turret head drills are well adapted. In Fig. 539 is shown a drilling machine of this class. The turret carries a number of spindles which can be successively thrown into position. Each spindle carries its particular tool for the work in hand and only the spindle in working position revolves.

In Fig. 540 is shown a horizontal spindle drill of radial pattern. The value of this class of tool, not only for general work,

but as a manufacturing drill, is not fully appreciated. This drill was originally designed for the drilling and tapping of holes in the ends of long work. Its advantages for this purpose are evident. For the drilling and tapping of holes parallel with a machined surface, on almost all classes of work this machine is superior to the standard upright drill, as the work can be more

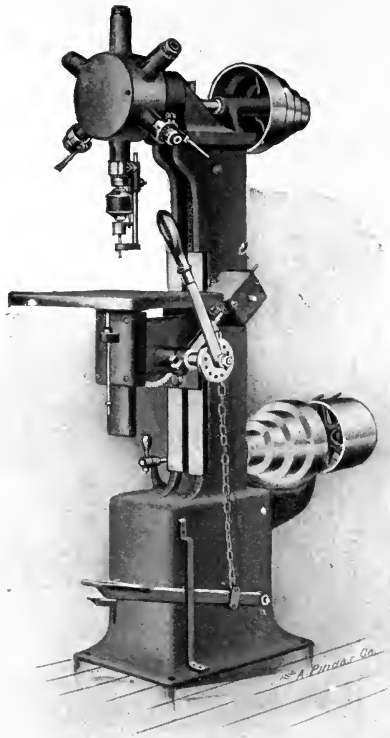

FIG. 539.

readily set up on the table and without the use of knee plates and blockings. The machine is back geared and provided with automatic power feed. Reversal for tapping is accomplished by a double friction clutch counter shaft.

Post drills as usually constructed consist of a substantial drilling head of suitable design to permit its being secured to a post or wall.

Suspension and traveling drills comprise a special class used for the drilling of plates and other work too large to be handled under a radial. The suspension drill is made to bolt to the ceiling and the work is moved under it. With the traveling drill the head is mounted on a steel bridge which is carried on side tracks similar to a traveling crane. These machines have the spindles motor driven, and although limited in their vertical adjustment are capable of wide lateral adjustment, making it possible to reach any part of large heavy work without moving it.

In Fig. 541 is shown a two spindle gang manufacturers' drill of entirely new design and construction. This tool is adapted

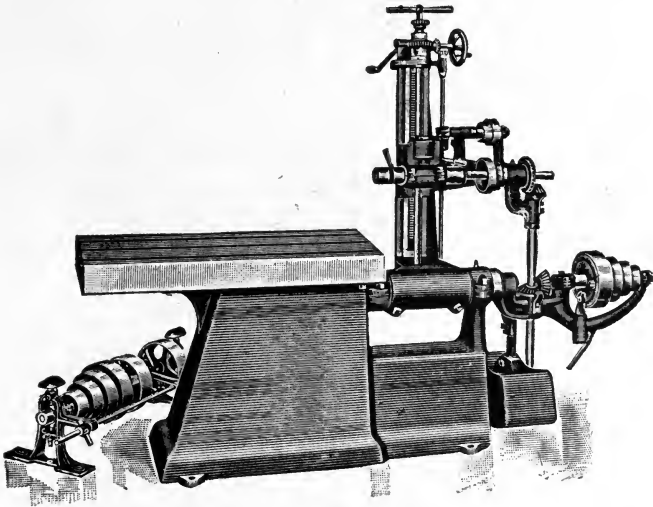

FIG. 540.

to the requirements of the manufacturing plant having many similar pieces to be drilled. In its action the operator throws in the feed lever and the spindle instantly advances by a quick movement until the drill comes in contact with the work surface, when the regular feed starts. When the hole is finished the spindle automatically returns. It is therefore only necessary for the operator to put into and remove the work from the carrying jig.

In Fig. 542 is shown a portable drill operated by a compressed air motor through the flexible shaft. An electric motor or a rope transmission may be substituted for the compressed air motor

when desired. In many cases a small air motor is attached directly to the drill spindle.

When a drilling spindle is to be used for tapping, it is necessary that some provision be made for reversing the spindle. The

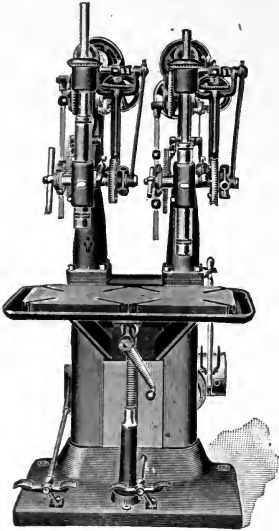

FIG. 541.

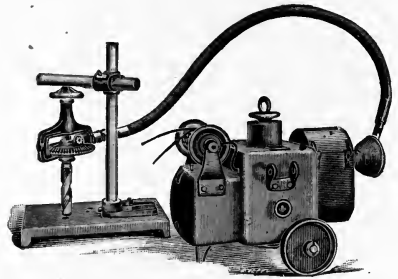

FIG. 542.

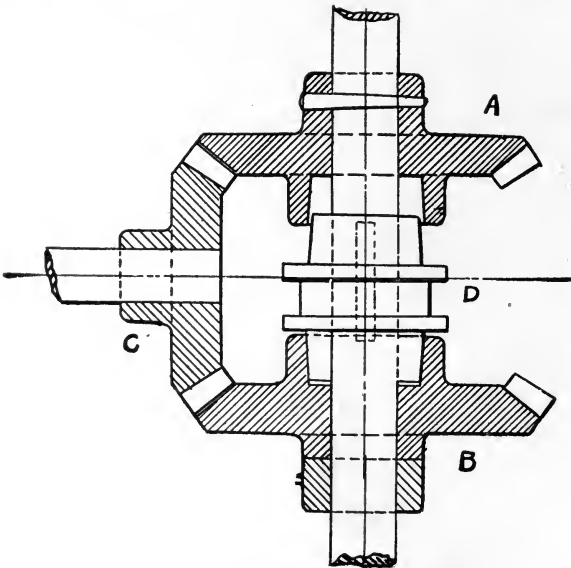

FIG. 543.

common method is by using a double clutch counter shaft with one open and one crossed driving belt. This arrangement causes a reversal of all turning parts which is open to some objection. Some builders are employing a geared reversal, either directly on the spindle or on the first reducing shaft. In Fig. 543 is shown a combination of three bevel gears for this purpose. Gear C is keyed on the first reducing shaft, gears A and B run loose on the spindle, the clutch D is keyed to the shaft, but free to



FIG. 544.

slide up or down over the key. A suitable lever engages with the clutch, thus making it possible to lock gears B or A with D, causing the spindle to rotate forward or back, depending on which gear is made to drive. This makes a very smooth and satisfactory working drive.

It is frequently necessary to use small drills in a large machine. As the spindle speeds are entirely too slow for the proper running of these drills, the high speed drilling attachment Fig. 544 can

be used to very good advantage. The box contains four gears, one cut on the lower end of the taper spindle, another on the spindle carrying the drill chuck with the two others mounted together on the stud shown. The arrangement is precisely like a back gear with an increasing rather than a decreasing spindle speed.

The securing of work on the table of the drilling machine requires clamps, bolts, jacks and blocking, the same as for planer and milling machine work. The same care should also be exercised in the setting, as true work requires careful setting. The use of the square and surface gauge, and good parallel bars are indispensable in setting up work for drilling. For through drilling the work must be so located on the table that the drill in passing through will enter a slot or the central hole on the table. If the drill is too large or for any other reason this can-

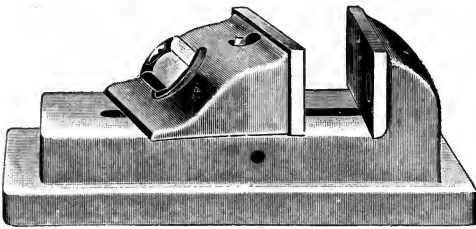

FIG. 545.

not be done, the work should be placed on parallel bars sufficiently thick to raise the work enough to allow the drill to pass through without spotting into the table.

The work table should be kept in good condition, and to drill a hole into it should be an unpardonable offense. As the work table on upright drills turns about its center and the table arm turns on the column, it is possible to so adjust the table that any point on a piece of work clamped to it can be brought under the center of the drill.

For drilling surfaces at right angles to a plain surface, the work can be secured to a knee plate or preferably to the table of a horizontal spindle drill. Round work can be advantageously clamped in a pair of 90 degree V blocks.

For the holding of small and medium sized pieces of work the drilling vise is much used. In Fig. 545 is shown a form of

drilling vise with an angular adjustment to the sliding jaw for holding tapered work. Nearly all pieces of work can be held in some manner in a vise, and in some cases when a large number

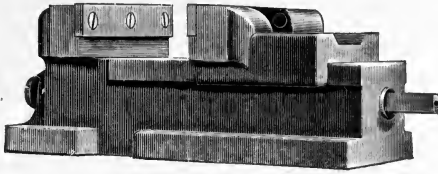

FIG. 546A.

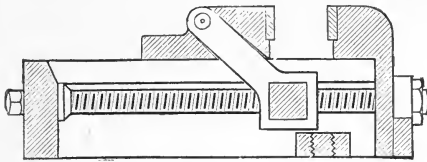

FIG. 546B.

of irregular shaped pieces are to be drilled it is found advisable to make special false vise jaws for holding them.

In Fig. 546 is shown, at A, a new drilling vise with a cross section at B. The method of operating the sliding jaw in this vise is such as to always hold the jaw tight down to its slide,

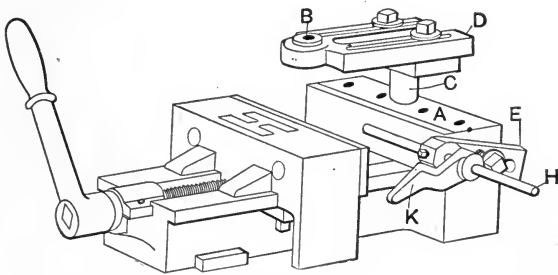

FIG. 547.

which prevents lifting and drawing the work out of true in tightening.

In Fig. 547 is shown a special jig drilling vise. It consists of a substantially made plain drilling vise with the jig drilling attachment shown. The attachment is secured to the stationary

jaw. The post C permits a vertical and a turning adjustment, and is firmly clamped in position. The yoke D, which carries the drilling bushing B, can be adjusted for length. The stops, H and K, are also adjustable. When a number of pieces are to be drilled alike, the first one is clamped in the vise and the stop K or H adjusted to it. The work should rest, if possible, on the ways of the vise or on suitable parallels in order that all pieces can be put into the vise in the same relative position. The bushing, when properly adjusted, insures the drilling of the hole in the same relative position, within reasonable limits, on all the pieces. A vise of this description proves an efficient tool for many drilling operations.

No class of work in the manufacturing shop presents as many

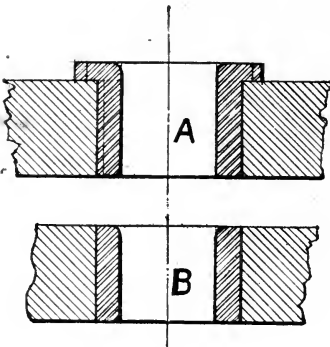

FIG. 548.

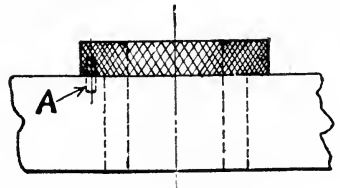

FIG. 549.

possibilities for jiggling as does the work handled in the drilling machine. Drilling is really a connecting operation between the machining and assembling of machine parts. These parts are turned, planed and milled to dimensions, but the accuracy with which they go together, and their interchangeability is dependent entirely upon the manner in which the drilling is performed. Carefully made drilling jigs not only make possible exact duplication, but save much time that would otherwise be devoted to the laying out of the work. Jigs are manufacturing tools of, as a rule, high first cost and their economy depends very largely on the number of pieces to be drilled.

Drilling jigs can be divided into two general classes, plate jigs and box jigs. A plate-drilling-jig is one which can be laid flat upon the surface of the work, properly located and clamped

in position. All holes drilled through plate jigs are parallel with each other. A box jig is one which contains the work and may be used for drilling holes at any angle with each other. The character of the work frequently necessitates the use of a box jig in cases where all holes required are parallel with each other.

Jigs are usually made of cast iron with bushings of hardened steel. The form of bushing usually used is shown in Fig. 548. At A is shown a shoulder bushing for use in jigs to be used from the one side only. At B is shown a plain bushing, as used in plate jigs which are reversed for drilling from either side. When two bushings, as a drilling and a reaming bush, must be used in the same hole in a jig they are usually made as shown in Fig. 549. The knurled head facilitates removing, and the pin A prevents the bush from turning and wearing loose in the jig. Bushings

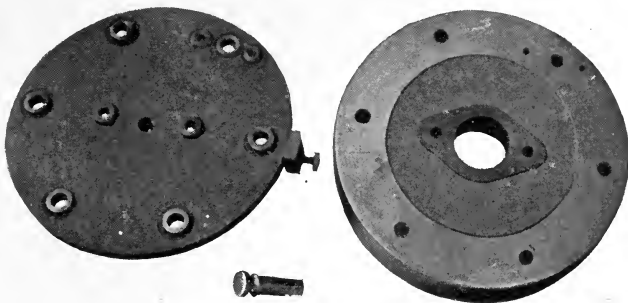
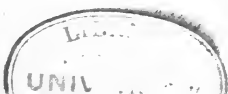

FIG. 550.

should be nicely fitted in the plate and for the most exacting requirements should be ground internally and externally after hardening.

An example of a plane plate jig is shown in Fig. 550. This jig is used in the drilling of the cylinder head shown. The jig is centered by a short bush, which fits the central reamed hole in the head. As the character of the head casting necessitates the jig being put on in a certain position, with reference to a core, a zero line established on each casting and the zero mark on the ear shown on the jig, are in each case made to coincide.

In Fig. 551 is shown a reversing plate jig and the work it is used upon. In this example the holes in the bed are drilled and those in the cylinder drilled and tapped to receive turned bolts which fit the holes exactly. It is also necessary that the flat face, shown on the side of the cylinder, comes exactly at right angles



with the planed bottom of the bed. The jig is first slipped over the extended barrel of the cylinder and its flat side squared with the face above referred to on the cylinder. The jig is clamped in this position and the holes drilled tapping size. The jig is then removed and the holes tapped at the same setting.

The tap drill bushings are next removed from the jig and

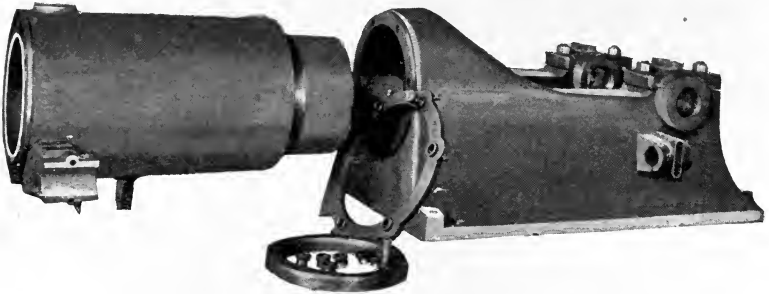

FIG. 551.

the bolt size bushing put in from the opposite side. The ring shown in the cut is now slipped into the bore of the bed and left extending from the face a distance sufficient to receive and center the jig, which is squared as before, this time from the drilling machine table. In all cases, after drilling the first hole, the stop pin

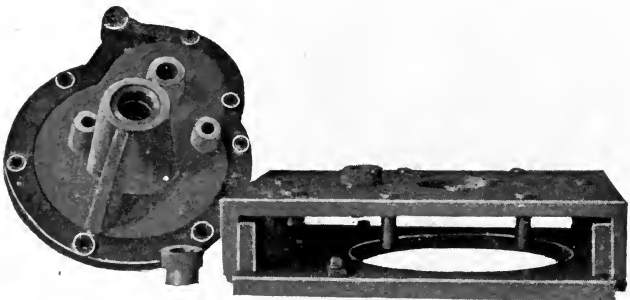

FIG. 552.

shown should be inserted in it to prevent any possibility of the jig shifting on the work.

In Fig. 552 is shown a form of box jig, and the piece of work it is used upon. In this case all the holes are parallel with each other and three of them do not pass through. The work is first

faced and bored. All holes in the jig are located with reference to the bore of the work. The lower portion of the jig holds the work central and the upper portion carries the bushings. These parts are nicely fitted together and suitable dowels insure their always remaining in the required position, relative to each other. For the holes that are low on the work surface, extended bushings are used.

In Fig. 553 is shown a simple form of box jig used for drilling holes in round work at right angles to each other. The construction is evident from the cut. The work is slid to a stop

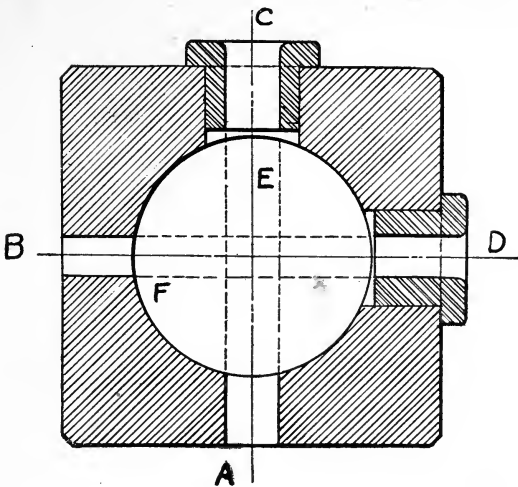

FIG. 553.

in the jig and clamped in position. The hole E is drilled through the bushing C, and F is drilled through the bushing D with the jig resting on its faces A and B respectively. When the angle $A O B$ is a right angle, the holes will be drilled at right angles with each other. By making the angle $A O B$ any required angle the same angular relation between the holes drilled will result.

From a consideration of Fig. 552 it is evident that when holes are to be drilled in a piece of work at any angle with each other, a box jig can be used. This jig must contain the work and have two parallel faces, one to receive the bush and the other to rest upon the work table, at right angles to each required hole.

The drilling of steel and wrought iron requires lubrication

for the cutting tool. Cast iron and brass are drilled dry. As with other cutting tools lard oil makes the most satisfactory lubricant. It is expensive, however, and as a result cheaper oils and drilling compounds comprise the lubricants most used. As the lubricant conducts away the heat of friction generated in the cutting of stock, it should be freely applied and provisions made for delivering it to the very cutting edge. This, as previously described, is accomplished by means of oil tube drills. These when used in a revolving spindle require a special form of socket which can be connected by pipe or tubing with a pump, for forcing the lubricant.

The drilling of deep holes is usually accomplished in special drilling machines using pod drills. Long twist drills are not

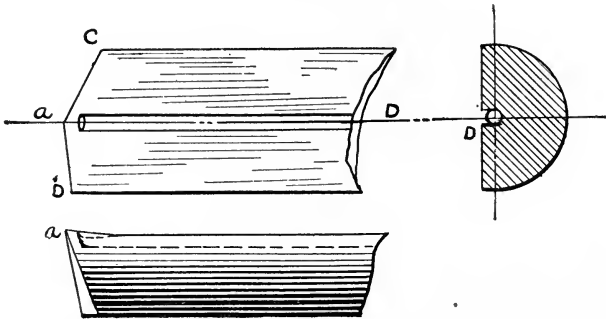

FIG. 554.

well suited to the drilling of deep holes inasmuch as the strain tends to untwist and make them vibrate and catch in the work. There is also not sufficient land area to satisfactorily guide the drill, thus making it difficult to drill true, straight deep holes. The pod drill is shown in Fig. 554. It is of semi-circular cross section, the radius of the section being equal to the radius of the required hole. All the cutting is done by the end face at A B which is given the necessary clearance, and for drilling steel a small amount of top rake. An oil tube D, bedded in the shank, supplies the lubricant to the cutting edge. For this class of drilling it is usual to rotate the work to a stationary drill. The feed, however, is usually given the drill. For the drilling of deep holes of large diameter, the drills used have an inserted cutter which can be removed for grinding and set out to compensate for wear.

Spotting and facing of small surfaces is usually accomplished with a counter boring tool of the class shown in Fig. 555. In this tool the cutter is held in place by the small screw in the end of the teat. The teat bushings are removable, several sizes being furnished with each counter bore. For special work it is advisable to have a separate counter bore for each piece. They should be made of tool steel and the teat or pilot point hardened after the

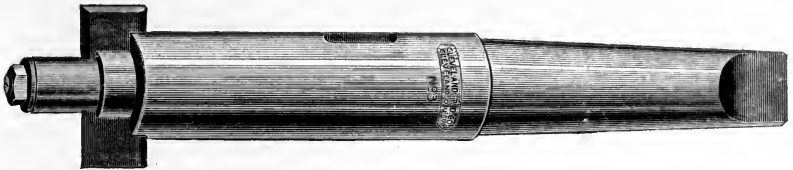

FIG. 555.

tool is finished. A plain mortise through the stock with a small set screw in the center of the teat is a satisfactory method of holding the cutting blade. By reversing the blade this tool is also well suited for back facing operations.

In Fig. 556 is shown the usual method of doing this work. The character of the work is such that the face F cannot be machined from the inside. The counter bore B should be made to fit nicely in the hole and it is also advisable to mill away some of

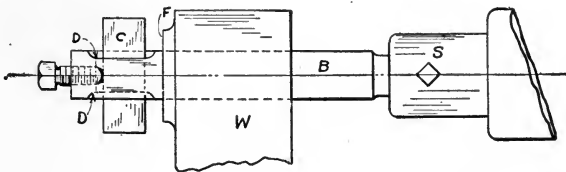

FIG. 556.

the stock D D on the side of the cutter, in order to give a clean cutting edge close down to the bar. A set screw S, or some other means must be provided for preventing the bar from drawing out of the socket.

When large holes are to be drilled in plates, the twist drill is not well adapted, since its point strikes through before the land enters the full size hole, thus leaving nothing to support the cutting edges. It is also necessary for the drill to reduce to chips all the stock removed. For this work the annular or sweep

drill is well adapted. Such a tool is shown in Fig. 557. The head *H* carries two cutters *C C* and the pilot *P*. The small hole for the pilot is first drilled, after which the tool shown sweeps out the balance of the stock with the least possible amount of cutting duty.

When a large hole of considerable length is to be drilled it is good practice to drill a small lead hole the required depth first. This not only aids in starting the large drill true, but prevents the grinding action on the inefficient cutting edge, at the end of the web. In cases of this kind and for the enlarging of cored holes, the three-flute drill is superior to the ordinary form.

For the handling of work on the table of the gang drill where it is necessary to move the work from spindle to spindle, some

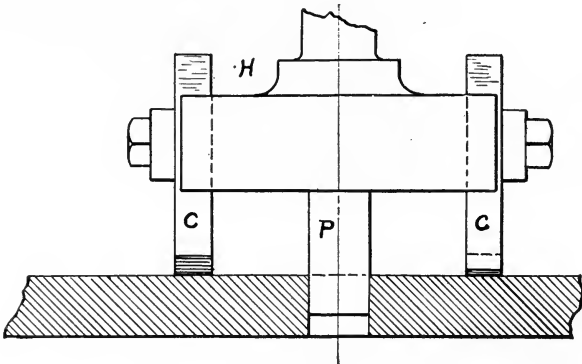

FIG. 557.

form of universal vise or chuck, that will permit the work to readily center, must be employed. If the operations require but little power and consequently cause only a slight turning effort, the work can be held in a drilling vise and moved to the spindles, the operator centering and holding it while the work is done. On heavier work, however, and in cases where all spindles are operating at the same time a special arrangement must be employed.

Take for example the finishing of the collar shown in Fig. 558, which is regularly a turret lathe job. The guide shown in Fig. 559 is the same length as, and secured to the table in such a position that the center line *A B* is in the plane of the spindles. The chuck or vise for holding the work is fastened to, or made

a part of the slide, shown in Fig. 560. This slide fits over the guide, Fig. 559. The work is secured to the upper half of the slide which due to the two motions readily centers itself under

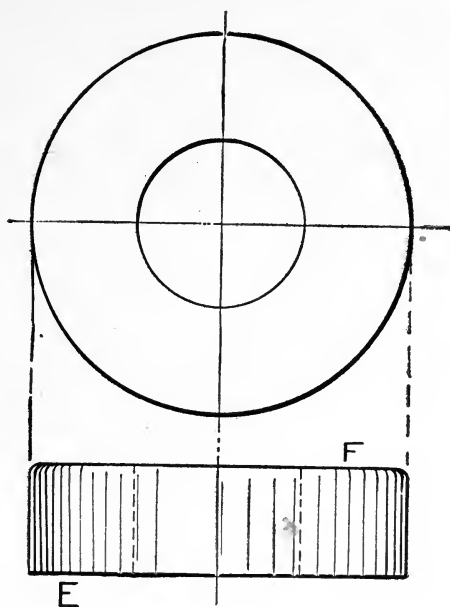

FIG. 558.

the spindle. After the first spindle has performed its operation the slide is moved along the guide to the next spindle and another slide with another piece of work is put on the guide and brought

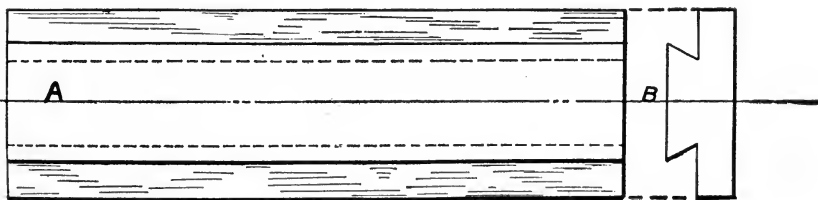

FIG. 559.

to the first spindle. After each operation the work is moved to the next spindle and when finished the slide is taken off the end of the guide, and returned to the starting end for another piece.

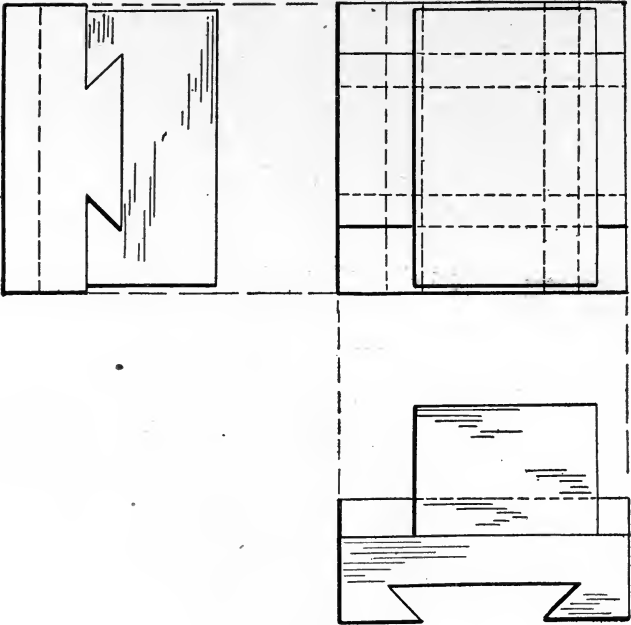

FIG. 560.

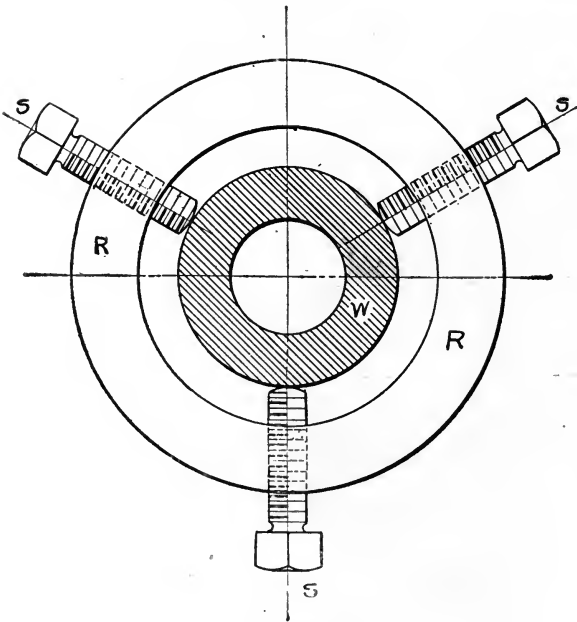

FIG. 561

In this manner several spindles are kept busy, each doing its particular work.

In the present example, Fig. 558, the chuck used can be made as shown in Fig. 561. The ring R is secured to the top of the slide, and the work W gripped by the three set screws S S S. In removing the work, but one of these screws is loosened. The work is put in with the top face F down. The first spindle car-

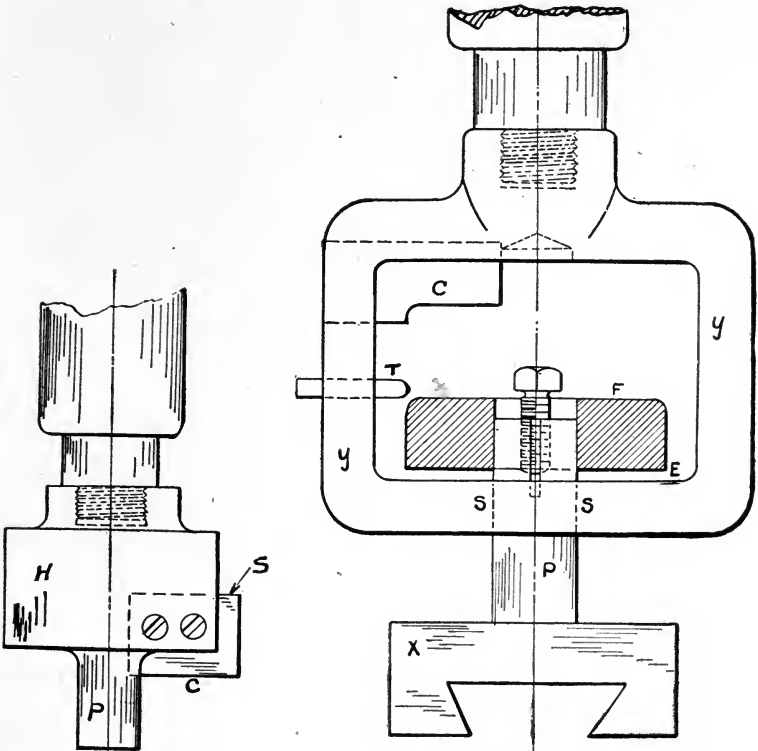

FIG. 562.

FIG. 563.

ries a three-fluted drill 1-64 inch under the finished diameter of the hole. The second spindle carries a reamer which sizes and finishes the hole. The third spindle carries the facing head shown in Fig. 562, which consists of a cast iron head H with the hardened and ground pilot pin P and the inserted cutter with a cutting edge at C which sweeps the face E of the work, leaving it smooth and true. By grinding the cutting edge perfectly par-

allel to the opposite edge of the cutter and securing it squarely against the seat S in the head this tool will face square. The work is now removed from the chuck, the upper half of the slide taken off, and the fixture X shown in Fig. 563 put on. P is a hardened pilot, the upper end of which is made into an expanding chuck, as shown. The frame Y Y has a bearing fit at S S on the pilot post and is threaded on the nose of the spindle. A turning tool T and a facing cutter C are secured in the proper positions in the frame. The work is secured to the post as shown with the unfinished face F up. The downward feed of the spindle first turns and then faces the work.

The above example, although involving simple operations on a very plain piece of work, serves to illustrate how many pieces of work can be put on a gang drill and produced at a much lower cost than is possible on a single spindle turret machine.

Small pulleys, cones and plain work up to 6 and 8 inches in diameter can be advantageously bored and turned by the above method in the drilling machine, when they can be gripped sufficiently rigid by the bore. When that cannot be done the arrangement shown in Fig. 372 can be applied and the work rotated to a stationary cutter.

The boring and reaming of large parallel holes in the drilling machine is accomplished in a very satisfactory manner by the method shown in Fig. 564. In this case a $5\frac{1}{4}$ -inch cylinder 14 inches long is accurately bored in the heavy standard pattern 32-inch upright drill, shown in Fig. 532. As the bottom of the engine bed shown is closed an extended boring bar cannot be used. The work is squared up on the machine table T and firmly clamped; an arm A supporting the upper end of the work. The yoke Y is bolted to the table and extends into the work through an opening in the side. This yoke carries a pilot bar P which fits in a tapered bearing at E. The boring bar B threads on the nose of the spindle and has a reamed hole H through it to receive the pilot bar P. The cutters C C are secured in the end of the bar and rough out the stock at the first passage through the bore. Sizing cutters are next substituted for C C and the bore brought to reaming size. At the end of this cut the facing cutter F which is secured in the head of the bar, as shown, is carried down and the end of the cylinder faced by a sweep cut.

The construction of the end of the bar is such that the cutters C C and the sizing cutters can be changed without altering

their dimensions. This is especially important with the sizing cutter, as it will carry through several bores without regrinding. The pilot bar *P* is now taken out and an inserted blade reamer

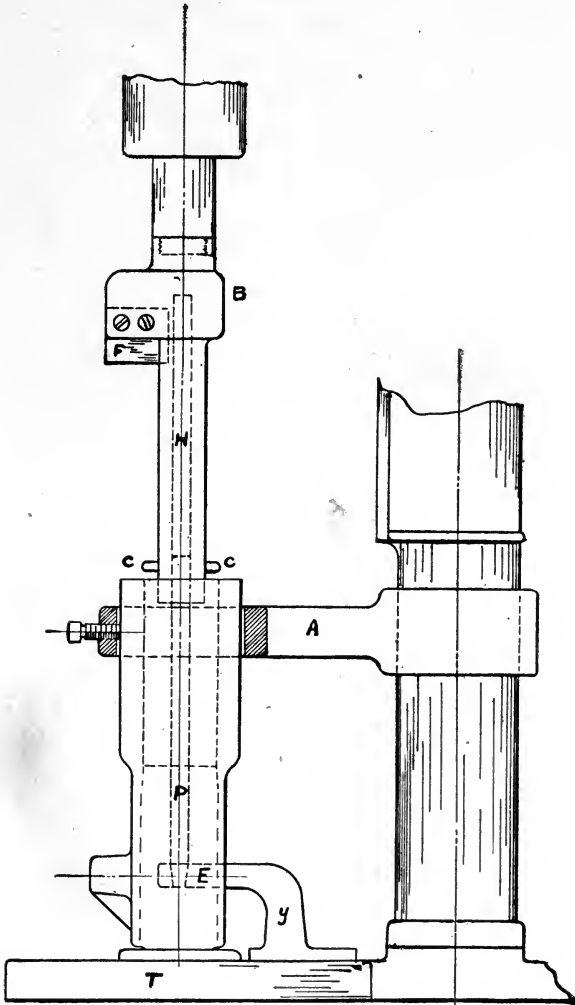

FIG. 564.

secured on the end of the boring bar is floated through the bore leaving it smooth, round and parallel.

The reamer used on the above work comes from the shop of

the B. F. Barnes Company, and its size retaining features are of special interest.

It is shown in Fig. 565. The cutters, one of which is shown at A and B, are inserted in the head, as shown. The shank of each cutter is tapered and drawn firmly to its seat by the bolt shown in B. The cutter disc corresponds to one thread of a coarse pitch square thread screw, a portion of which is ground away, as shown at C. In obtaining the required size, the cutters are numbered, hardened and fitted in the head. The head is then placed on a mandrel between centers in the grinding machine and the cutters ground to the circle D D of the exact diameter required. They are then removed and each cutter ground

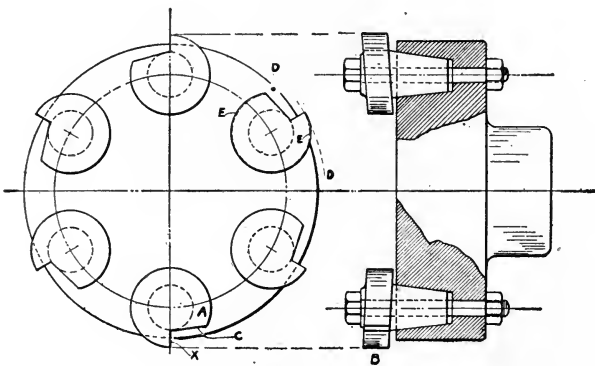

FIG. 565.

to the diameter E E, and replaced in the head, each cutter in its respective bearing as indicated by the numbers. This is important inasmuch as the locations of the bearings vary somewhat and consequently all the cutters are not of the same diameter.

The cutting edge can be set to a line across the face of the head and by grinding from the face X only in sharpening, the exact diameter of the tool can be maintained until the cutters are entirely ground away. By keeping a record of the diameter of each cutter, others can be made at any time without the necessity of the first grinding operation above referred to. The objection to this tool is its comparatively short cutting edges. It is only adapted to reamers of the larger sizes, as enough cutters cannot be put in a head of small diameter.

CHAPTER XXVIII.

GRINDING MACHINES AND GRINDING.

Grinding operations in the machine shop depend upon the abrasive or cutting qualities of stone, emery, corundum, and carborundum, when suitably held and presented to the work. The use of the solid grinding wheel has made it possible to attain many refinements in machine construction that would have been

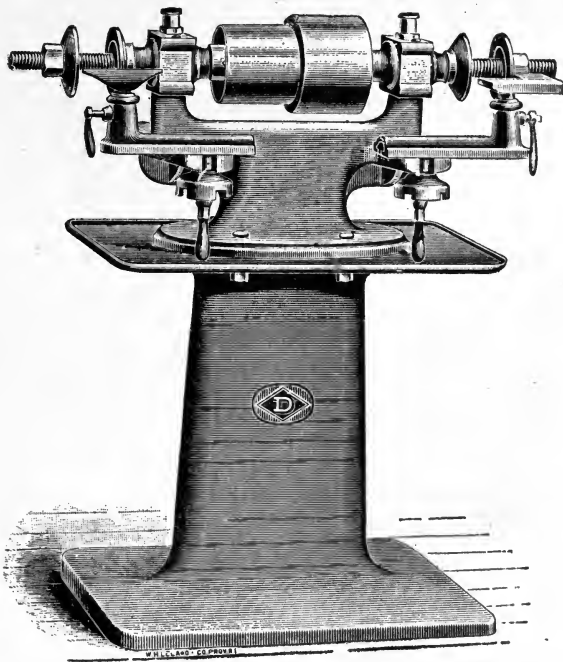

FIG. 566.

impossible without it. It has made it practical to economically finish parts in hardened steel that could not possibly be machined with cutting tools in the lathe or planer; and on the softer materials, surfaces smoother and truer can be obtained by grinding than by any other method.

Grinding operations may be divided into the following classi-

fications: 1st, hand grinding; 2d, tool and cutter grinding; 3d, cylindrical grinding; 4th, surface grinding. Hand grinding includes all the grinding operations in which the work is held to the wheel by hand or with a rest, as in rough grinding, ordinary lathe tool grinding, buffing and polishing. The class of machine used for this work is of the simplest form, consisting of the wheel-carrying spindle mounted in suitable bearings on a substantial head or pedestal. In Fig. 566 is shown a simple grind-

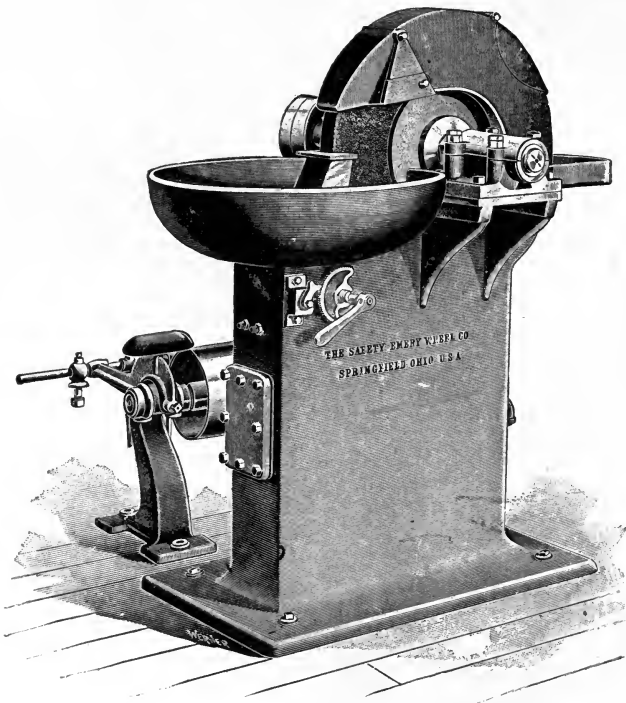

FIG. 567.

ing stand, designed to carry two wheels. It is provided with adjustable rests upon which the work being ground is steadied. This grinder is intended for dry grinding of the rough and heavy class, where there is little danger of heating the work.

When tempered work is to be ground, or any class of work that would be injured by heating, a wet grinder of the class shown in Fig. 567 is used. With tools of this class a supply of water is delivered constantly to the rim of the wheel, thus keeping the

work cool. Fig. 568 shows a buffing head or spindle. The spindle extends well out from its bearings for convenience in handling the work being operated upon. These spindles are fitted to receive wheels of wood, leather, or cloth, which are charged with the emery or other grinding material. The work is held to the wheel without the aid of a rest.

Tool and cutter grinding requires a better class of grinding machinery than is required for the hand-grinding operations. What is here referred to as tools does not include the ordinary hand and lathe tools, commonly ground on the machine shown in Fig. 567, but refers to drills, reamers, milling cutters, and the finest class of tools. Fig. 569 illustrates a universal cutter and

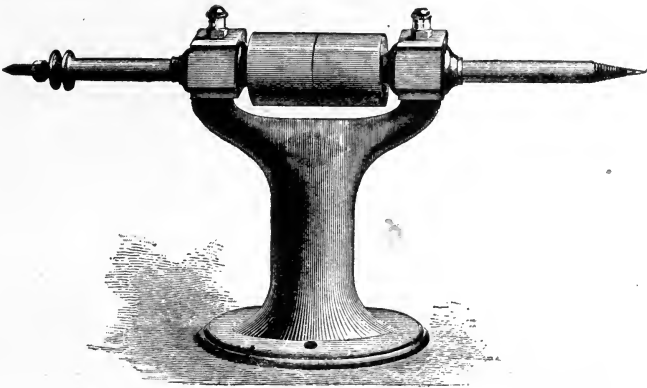

FIG. 568.

reamer grinder. As the name implies these tools are provided with all the necessary adjustments and attachments for grinding the cutting edges of all classes of reamers and milling cutters, and in many cases may be used for doing a limited amount of cylindrical grinding both internal and external. A much simpler machine, shown in Fig. 570, constitutes a very satisfactory cutter grinder of small proportions. By the use of the swivel head shown, cutters of all angles may be readily ground, and by placing centers on the slide which is operated by the lever shown under the table, reamers up to the capacity of the machine may be ground.

The extensive use of the rotating cutter in machining operations and the necessity of keeping these cutters true and sharp makes necessary the use of the cutter grinder whenever this class

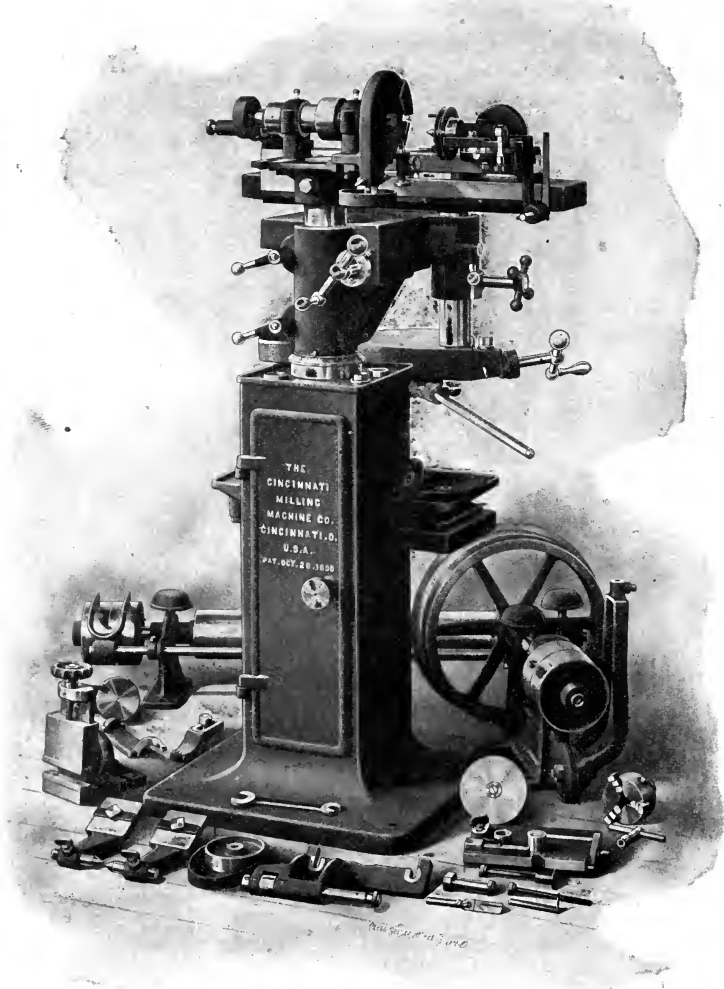

FIG. 569.

of tools are used. In the grinding of cutters care and judgment must be exercised and not until the operator has become thoroughly familiar with all the setting combinations of the machine can he expect to get the best results.

As water is not used on the wheels of cutter grinders and the wheels are for this work usually quite hard and fine, light cuts

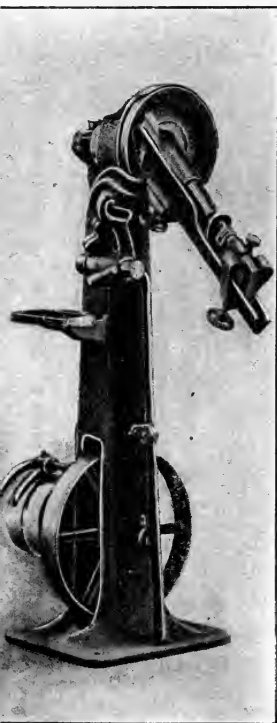

FIG. 571.

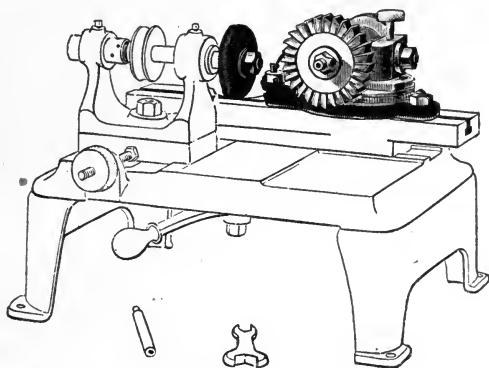

FIG. 570.

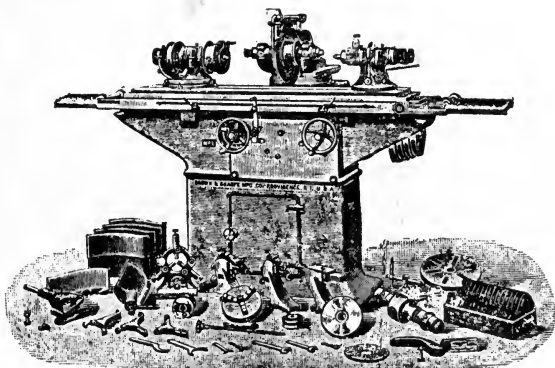

FIG. 572.

must be taken in order not to draw the temper of the tool at its cutting edge. The cutter support should be adjusted to bear against the tooth being sharpened and its position relative to the wheel should be such as to give the necessary amount of clearance to the cutting edge.

Polishing and buffing operations involve the removal by a grinding process of a small part of the work surface, the grind-

ing material used being of such a fine character as to leave a smooth, highly-finished surface. This class of work is usually done on the buffing spindle shown in Fig. 568. Buffing does not leave a true surface and is consequently confined strictly to polishing work.

The grinding of twist drills is a very particular operation, requiring a skillful operator, if performed by hand. In Fig. 571 is shown a twist-drill grinder in which the twist drills may be ground with the assurance that the angle and clearance will be correct and equal on both sides.

In the machine shown, the construction is such that drills of any diameter within the limits of the machine may be ground with but one preliminary adjustment for each size.

Unfortunately a twist drill can be ground by hand on a plain emery wheel, which fact keeps the twist drill grinder out of many shops where its use would add materially to the efficiency of the drilling equipment. Correctly ground drills cut faster, stand up longer between grindings and produce the proper size of hole. A correctly-ground drill seldom breaks, as it cuts freely ahead of its feed and does not scrape and jam, as is the case when clearance and angle are wrong.

Grinding machines for the grinding of common forged lathe and planer tools are manufactured, and in shops where large numbers of forged tools are used have proved very efficient. In the working of these grinders the tool is clamped in a suitable head and presented to the emery wheel at the proper rake and clearance angles.

Cylindrical grinding as a class, covers all forms of grinding operations upon external and internal cylindrical surfaces. The universal grinding machine, or, as it is sometimes termed, grinding lathe, shown in Fig. 572, is specially adapted to this very exacting class of work. All machines of this class consist of a swivel table carrying a suitable head and tail stock, and of a wheel stand carrying the grinding wheel. The arrangement of parts is such that either the wheel stand is given the feeding motion past a stationary table or the platen is given the feed past the wheel. The adjustments are such that the wheel can be set in or away from the line of the work center, or can be turned to stand at any desired angle with the line of the feed travel, which is necessary for face and steep angle grinding. The swivel table can be set at an angle with its travel, or the line of travel of the

wheel where the table is stationary, thus making possible the grinding of long tapers. For internal grinding, a small spindle, run at a high rate of speed and carrying an emery wheel small enough in diameter to operate in the bore to be ground, is used. These machines are provided with suitable pumps for supplying an abundance of water to the wheel and work, when the character of the work is such as to require it. As these machines are expected to produce work smooth and cylindrically true, they are most carefully built, and should embody all the refinements known in machine tool construction. The spindle for carrying the emery wheel is perfectly balanced and runs in very close-fitting boxes, as any slack in the bearings or lack of balance proves fatal to the production of correct results. Provisions are made for rotating the work, when held between dead centers, with a spring tension adjustment on the tail center, thus reducing the danger due to expansion and the unequal wearing of the center bearings. The screw adjustment for setting the wheel up to work is graduated to thousands of an inch, thus forming an excellent guide in determining the amount of stock removed.

The application of an automatic cross feed to the wheel stand is a valuable addition to the plain and universal machines, as it advances the wheel to the work by fixed amounts at the beginning of each cut, thus making the conditions more uniform and requiring less attention on the part of the operator. The amount of feed for each passage of the wheel over the work can be varied to suit the condition. A feed as fine as $\frac{1}{8}$ of $\frac{1}{1000}$ can be obtained, which would reduce the work $\frac{1}{4}$ of $\frac{1}{1000}$ for each passage of the wheel across it. An automatic stop throws out the feed when the wheel has advanced the required amount. As this mechanism is necessarily very sensitive and delicate it must be kept perfectly clean and well lubricated.

Plain grinding machines are in many respects similar to the universal machines. As they are, however, used for straight cylindrical and long tapered work, many of the universal features are dispensed with, making them strictly a manufacturers' machine.

The wheel for any class of grinding should be properly adapted to its work as to shape, grade, and hardness. The shape and character of the work determine in any case the shape of the wheel to use; while the material of which the work is composed, the amount of metal to be removed, and the condition of the

finished surfaces must determine the quality of the wheel. Emery and other wheels of that class are composed of two elements—the abrasive and the cementing materials. The cement—as clay, glue, or rubber—holds together the grains of emery, and in use as the grains become worn and dulled, they break away from their settings in the cement, and fresh grains are uncovered to go on with the cutting process. If this breaking down process is comparatively rapid, the wheel cuts very freely, but reduces in diameter correspondingly fast. If the cement, on the other hand, does not give up the worn grains of emery, the wheel glazes, cuts slowly, and heats the work. The surface velocity of the wheel should be correct for the different classes of work and grade of wheel. The wheel is ordinarily most efficient just before it stops breaking away and begins to glaze. Up to this point, the higher the speed the more metal it will remove in a given length of time. When run at lower speed, it cuts somewhat easier, and does not heat the work as badly. Glazing is usually prevented by reducing the speed. Soft wheels stand up better at high, than at low speeds. The wider the faces of the wheel presented to the work, the more cutting surface, and the faster the metal is ground away. The feeds must be correspondingly coarse. The wider-faced wheels should be comparatively soft, and as the face reduces in width the wheel should increase in hardness.

The surface speed of the work should be proportionate to the speed of the wheel, and in any case should be sufficiently slow to allow the wheel ample time to cut away the metal without crowding, as otherwise the work is sprung away from the wheel more or less, and untrue work results.

A free cutting wheel, run at the proper speed and with a light cut, is best for accurate grinding, as it removes the metal without pressure and consequently cuts the high spots most and does not heat up the work. It is, however, necessary on very accurate work to use water on the wheel, as a slight change of temperature affects the work noticeably. When long cuts are to be taken, it is sometimes difficult to get the wheel to stand up so as to give a parallel cut. In such cases, the wheel must be properly adapted, and each grain of emery must cut as long as possible before dropping out. As the harder wheels hold the emery longer, and can be run somewhat slower, they are best adapted to this condition. The wheel should have a wide face, and should be of large diameter, so as to present as many grains of the abrasive as possible

to perform the required work. It is also necessary to use the coarser feed and light cuts in order that the wheel may cover the entire surface before it drops materially in diameter. The direction of feed is changed for each time over the work, which also tends to even up the wear on the wheel.

All manufacturers of grinding wheels, however, give a table of speeds for the different diameter of wheels they manufacture, but these speeds are not always best suited to the work. All wheels should fit easily, yet closely, on their spindle to prevent danger from cracking, and a soft washer of uniform thickness should be placed between the sides of the wheel and the clamping washer. The wheel should be firmly clamped and trued before using. Manufacturers test all wheels by running them at a speed considerably above their rated speed.

In the grinding of long work it is quite necessary to support it at one or more points between its end bearings, as otherwise it will spring and chatter, making true smooth work impossible. For this purpose, suitable steady and follow rests are provided with the machine.

In Fig. 573 is illustrated the method of grinding slight tapers

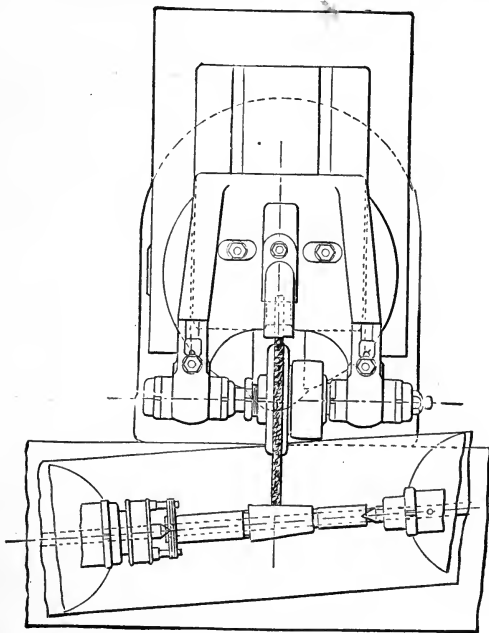

FIG. 573.

in the universal or plain grinding machines. By means of a screw and graduation at the end of the table it is swiveled to the required angle with the line of travel of the slide. In this manner tapers up to $1\frac{1}{2}$ or 2 inches per foot may be ground. When a steeper taper is required it can be obtained in the universal machine by setting the wheel slide to the required angle, as shown in Fig. 574. In this particular case, two tapers, one of 45 degrees and one of 5 degrees are required on the work. By swing-

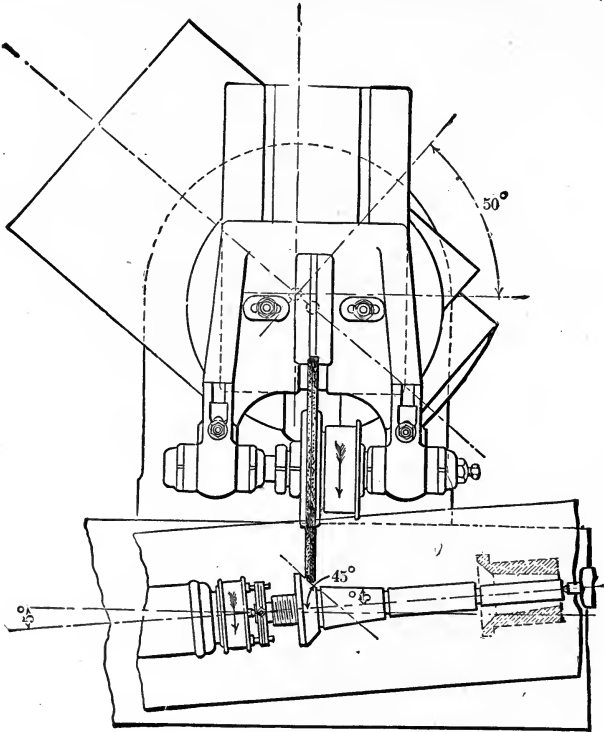

FIG. 574.

ing the swivel table to 5 degrees from the line of its travel the slight taper can be ground by the travel of the table past the wheel. By setting the wheel slide to 50 degrees, as shown, the steep taper is ground by operating the wheel slide, the swivel table remaining stationary. If but the 45 degree taper was required, the table would be left central, and the wheel slide set to 45 degrees. As shown in the cut, the corner of the wheel is dressed to give a cutting face of suitable width.

In Fig. 575 is shown the usual method of face grinding. The work is held in the chuck or on a face plate as shown. If the face is to be a plane surface, the head spindle axis is set at right angles to the wheel spindle. By varying this angle concave or convex, conical surfaces may be obtained.

In Fig. 576 is shown the method of grinding internal surfaces

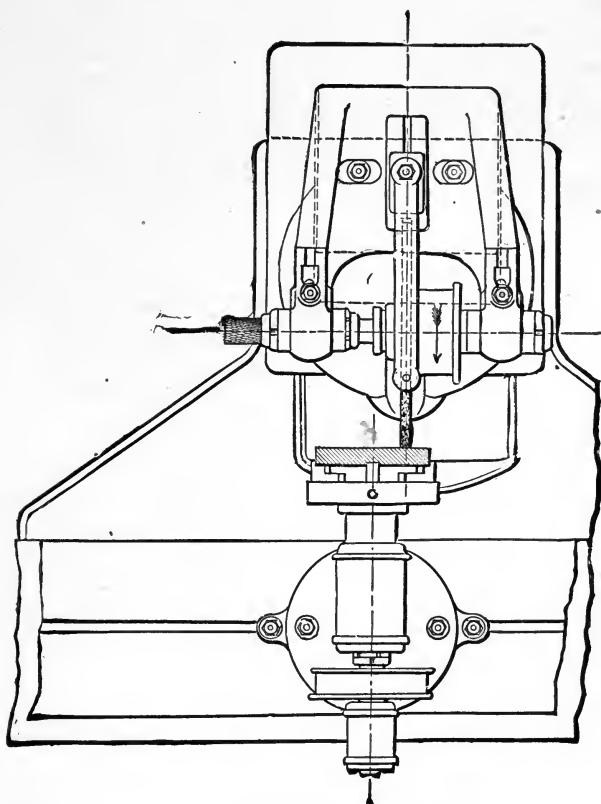

FIG. 575.

with the internal fixture. The example given serves to illustrate, as in Fig. 574, the settings for both slight and steep tapers. The small taper is obtained by setting the swing table to the required angle with the travel of the table slide and the steep taper, by using the wheel slide set to give the wheel the required line of travel. It will be noted that in using the internal grinding fixture, the position of the wheel table is reversed from its universal

position and the fixture secured to the end of the table. A belting jack is substituted for the emery wheel spindle and the spindle of the internal fixture driven by a light canvas belt from the jack.

Although the spindle of the internal grinding fixture is driven at a very high speed, the diameters of the wheels used are so small that it is not possible to obtain a periphery speed as high as would

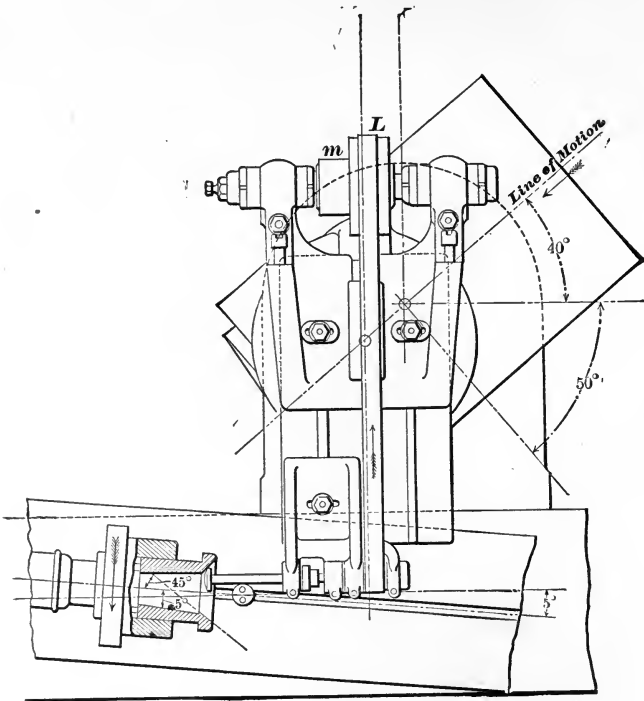

FIG. 576.

be desired. It therefore is necessary to use a free cutting wheel and to rotate the work to it at a comparatively slow speed.

On these machines all work and wheel settings are to carefully graduated arcs. These graduations cannot, however, be relied upon for exact settings within the accuracy limit of the machine. If, for example, the machine is set for parallel grinding on a certain class of work, the head stock is unclamped and the spindle thrown out of parallel with the table's line of travel; it will be found practically impossible to set the head back to its

original position, sufficiently close to make the machine grind parallel again. In fact, so minute are the variations that the wheel will detect that the unclamping of the tail stock, moving it out of position and then back will show an unparallel condition of the work. It therefore becomes necessary after each setting of head or tail stock to readjust the work table by means of the end adjusting screw in order that the line of rotation may be brought parallel with the line of motion of the table slide.

Surface grinding bears the same relation to planing that cyl-

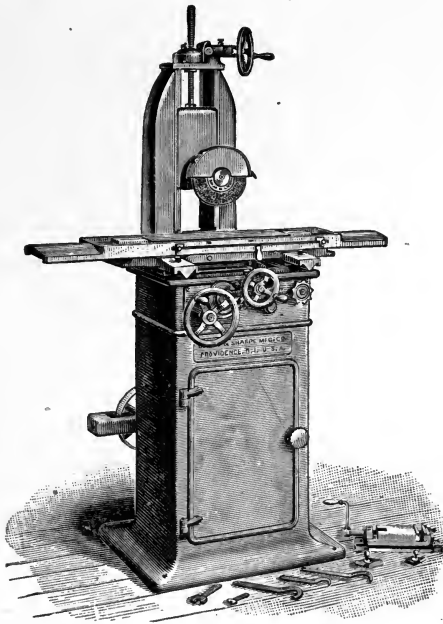

FIG. 577.

indrical grinding does to turning. The surface grinders use the same form of wheels as the cylindrical grinding machines. The work, however, is secured to the work table, which is fed under or over the wheel. In Fig. 577 is shown a surface grinding machine. The construction of the machine is clearly shown. The wheel is adjustable vertically to give depth of cut, the arrangement of pulleys being such as to give constant tension on the belt for all positions of the wheel. The cross feed is obtained by moving the table toward or away from the housings on suit-

able cross slides. Provisions are made for supplying water to the wheel when necessary.

In Fig. 578 is shown a plain grinder provided with a surface grinding plate. In this case the wheel projects above the surface of the plate only the amount of the cut required, and the work is passed over it by hand. To give satisfactory results, the spindle and its bearing should be first class, and the wheel in perfect balance. A grinder of this class is a most satisfactory tool for

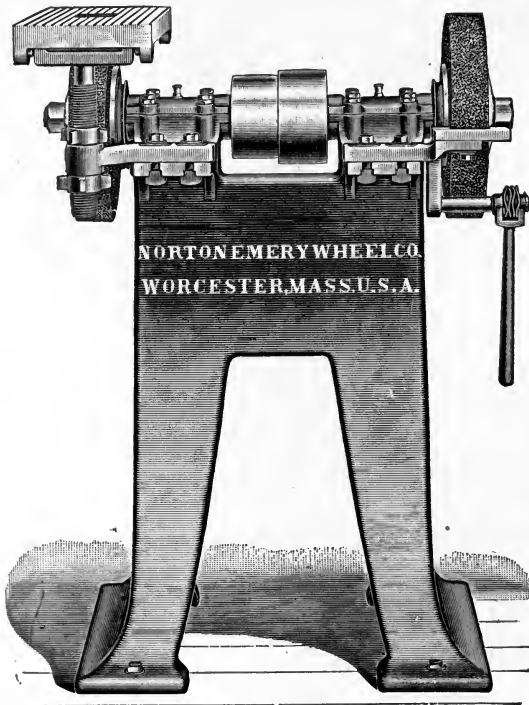

FIG. 578.

smoothing and polishing surfaces where finish and not truth is required. A more refined grinder, somewhat after the same order, and known as a disc grinder is shown in Fig. 579. These are very nicely constructed grinders in which the grinding is done by sheet emery glued to the faces of the discs. The rests swing across the face of the disc, the work being held on top of the rest. For the finishing of one or more plane surfaces on small parts, this tool is very well adapted.

In Fig. 580 is shown a form of portable hand emery grinder driven by a rope transmission through a flexible shaft. These grinders are very satisfactory tools for the grinding of heavy castings that cannot be held to a wheel.

For truing the emery wheels used on the better classes of grinding machinery nothing but a black diamond truer is suitable. Such a tool is shown in Fig. 581. The diamond is mounted in the end of the round steel holder, as shown. The round holder

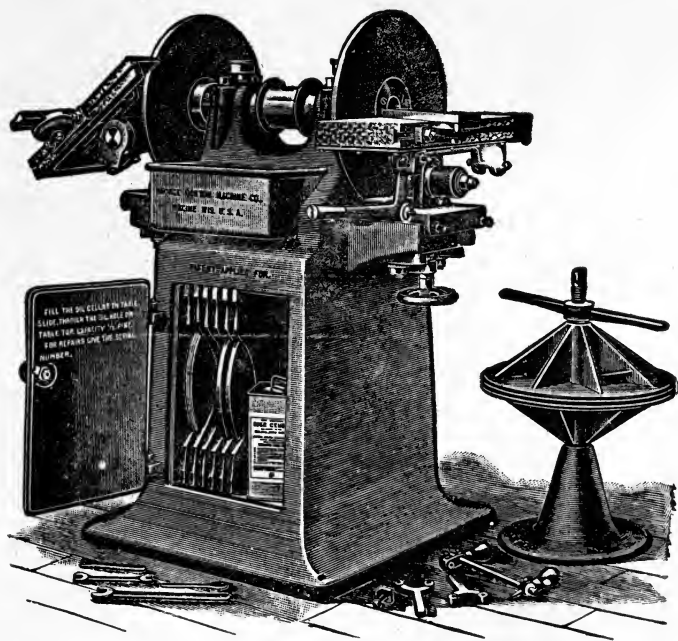

FIG. 579.

enables the stone to be presented to the wheel in various positions, so as to bring the several cutting points of the stone into action. As the diamond is harder than the emery, it actually cuts the wheel away.

A suitable fixture is usually provided for holding the truer in such a manner that it can be passed squarely by the part of the wheel being trued. Water should be used on the wheel in truing and the cuts should be light in order to obtain good results and to preserve the diamond.

For the coarser wheels, dressers of the character of the one

shown in Fig. 582 are used. Several forms of discs are used. The discs are made of hard steel or chilled iron and turn freely upon a pin. In their action the teeth of the discs break up the surface of the wheel as they roll together and dislodge the high particles of the wheel by a picking action.

Lapping is a refined grinding process used for the final finishing of machine ground surfaces, usually of hardened steel. A lap is usually made of cast iron, copper or lead, the surface being



FIG. 580.



FIG. 581.



FIG. 582A.



FIG. 582B.

coated with very fine washed emery. In Fig. 583 is shown a form of lap well suited to the finishing of cylindrical surfaces. The body of the lap is of cast iron with lead or copper strips a a a a extending through it. These soft strips serve to hold the emery better than a harder material. By slightly reducing the diameter of the lap by means of the thumb screw, as the grinding proceeds, the work may be brought to the required size. In its use, the work is usually rotated at a comparatively high speed, and the lap held by the hand. By moving it slowly from end to end of the surface being finished, parallel work can be obtained.

It is in this manner that hardened steel plugs receive their final sizing.

For the finishing of bores the same general method is employed. A plug, preferably with the lead or copper strips, so constructed that it can be slightly expanded, is the form usually employed. In Fig. 584 is shown a form well suited to most classes of work. It is preferably of cast iron but may be made of soft steel. The slot is cut through and the wedges *w w* serve to give the slight expansion necessary.

For the lapping of flat surfaces, a cast iron plate drilled full

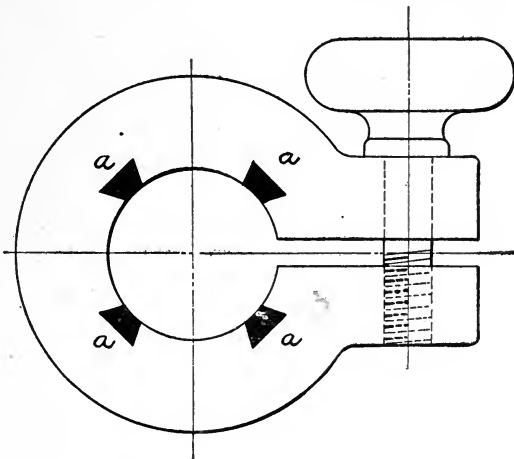

FIG. 583.

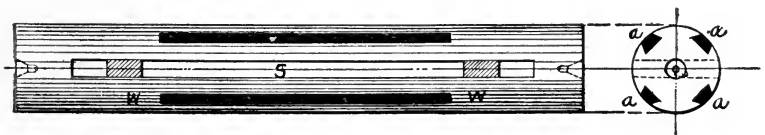

FIG. 584.

of holes with plugs of lead or copper inserted and the surface then planed as true as possible can be used. This surface is charged with emery and oil and the work rubbed over it, the direction of motion and part of the surface used, being constantly changed in order to wear the lap equally all over.

Although it is impossible to give any fixed rule for the correct periphery speed of emery wheels of different makes and for varying service, the tables given in Chapter XXXIV. will serve as suitable guides.

CHAPTER XXIX.

HARDENING AND TEMPERING.

The hardening and tempering of tool steels present many problems which can only be solved by a wide and varied experience at the temperer's forge. The simpler cases are mastered with little trouble, but when it comes to the tempering of difficult and expensive pieces the trained judgment of the expert temperer is usually sought.

Hardening and tempering of steel brings about such a change in its physical condition that it may be used in places where cutting edges, resistance against wear and elasticity are required.

The hardening and tempering of steel are two quite different things although often referred to as the same. By hardening we change the physical condition of the steel, transforming it from a relatively soft material to an exceedingly hard one and at the same time, rendering it brittle and weak. By tempering we reduce the hardness to the degree required for performing the work it is intended for, and in so doing restore much of its original strength and toughness. For tempering it is therefore necessary that a degree of hardness equal to or greater than that required must first be given the steel.

The amount of carbon contained in a piece of steel determines its temper. The more carbon, the higher the temper. Thus $1\frac{1}{2}$ per cent of carbon makes a steel capable of very high tempers, such as are required for the turning of chilled rolls and other very hard materials. One per cent is the amount usual when the steel is used for the more common tools, as cold chisels, drifts, etc. Lathe tools, milling cutters, taps, drills, and reamers come between these two limits. In general, the more the carbon, the greater the care required in the heating and handling of the steel. A $1\frac{1}{2}$ per cent carbon steel burns very easily while a one per cent steel can be heated with little danger from this source.

Cutting tools that are forged to shape are given a short temper; that is only a short portion at the cutting edge is made hard, the balance of the tool being left tough to support the cutting edge, and when that edge is worn or ground back into the softer part the tool is redressed and retempered. When, as with

a drill or milling cutter, the tool must be repeatedly sharpened until worn completely out without retempering, it is necessary to harden it through and then draw down for toughness as far as the character of the tool will permit. Cutters, reamers and mandrels of comparatively large diameter are usually given a hard surface temper, leaving the core soft.

When a piece of steel is of sufficiently high temper to be used as a metal cutting tool it is too hard to permit of any bending. By drawing the temper sufficiently low, however, the steel gains in toughness at the expense of its hardness and what is termed a spring temper is obtained.

The tempering of steel machine parts to make them resist wear is frequently necessary. The higher the temper the better the wear reducing quality; the hardness, however, being limited by the strength required.

The manufacturers of tool steels usually prefer to recommend the grade and temper of steel for any specific purpose. In general, the higher the carbon the finer the steel, but not necessarily the better for many classes of work. For general purposes a grade of steel of medium temper costing about twelve cents per pound, as furnished by any of the reputable makers, will be found satisfactory. The extra qualities at 16 to 20 cents per pound are suitable for the most exacting requirements, while a lower grade at eight cents can be used for the less important work. For many machinery parts, when a temper to resist wear only is required, the lowest grades of tool steel or even machinery steel can be used. The latter is not considered as a tempering steel, but can be somewhat hardened by tempering methods; and can be given a hard surface by case hardening. There are many special grades of steel running much higher in price; their uses being restricted to certain lines.

The heating of steel may be classed under three distinct heads; first, for forging; second, hardening, and third, for tempering. For forging, a clean, thick fire should be used with a steady blast, so regulated as to give a uniform heat to the work. It is very important that the work be heated uniformly and at the same time it is advisable to get this heat as quickly as possible, as it usually injures the quality of the steel to leave it too long in the fire.

If the steel is not uniformly heated, the forging produces surface cracks, makes the grain of the steel coarse and is otherwise injurious. Heavy forging at moderate heats refines and improves

the quality of the steel. In hardening, a coke, charcoal or gas fire should be used for heating the steel. The blast should be moderate in order to raise the temperature uniformly and without overheating corners and delicate cutting edges. The heat should be the lowest possible at which the steel will properly harden. Too high a heat injures the quality of the steel and increases the strains and consequent chances for cracking. An uneven heat is also very apt to produce excessive strains and cracks, when the steel is quenched.

For small flat pieces the heating is frequently done in the open flame of a gas or charcoal fire. A level charcoal fire with a distributed blast is much used for heating thin work, as for example, metal saws, gear cutters and similar work which can be laid flat on the surface of the fire. A fire of this kind is also suitable for heating small round work. When the work is long and comparatively small in diameter a muffler is often used. This may consist of a piece of pipe buried in the fire and heated to a bright red. The work is held in the center of the pipe and by constantly rotating it a very uniform heat is obtained.

The heating of work for hardening in melted lead or a flux of salt and cyanide of potassium is extensively employed by many manufacturers of small tools. In each case the method is similar. A deep cast iron pot of from four to six inches diameter is placed in a special furnace where a suitably regulated fire can be maintained under and around it. This pot is filled to within a few inches of the top with lead. By a proper regulation of the fire the temperature of the lead is maintained at the point it is desired to heat the steel to. To prevent the oxidation and resulting waste of the lead its surface should be covered with powdered charcoal. A study of the appearance of the surface of the lead provides a reliable means of determining the proper heat. It is quite possible to obtain a temperature of the lead sufficiently high to injure a high carbon steel; care must therefore be taken in the matter of regulating the heat.

The article to be hardened is immersed in the lead and allowed to remain until it has acquired, throughout its entire body, the same temperature as the lead. It is evident that all parts of the work surface are subject to the same degree of heat, which insures the greatest uniformity in its heating.

After heating, the hardness is obtained by quickly cooling the steel. The usual method is to plunge it into cold water, brine or

oil, immediately after taking it from the fire. This sudden cooling of the steel is necessary, and the success of tempering depends very largely upon the manner in which it is done. The shape and character of the work must in every case determine the manner in which the steel is presented to the cooling bath. Salt added to the water in which the quenching is performed intensifies the hardening effect. If the body of steel is large, a large volume of cooling solution is necessary.

When the work is of a bulky character, that part which first enters the cooling bath is quite apt to harden better than the top, inasmuch as the boiling action prevents the water from coming in actual contact with the surface longer at the upper parts of the work than at the lower. For this reason, on heavy work, a large jet of water is frequently forced against the upper portion of the work.

Cooling in oil is for many classes of work considered superior to water or brine. In its softer action and more rapid conduction of the heat from the steel, lie the advantages in oil quenching. Sperm or cottonseed oils are those usually employed. In using the fish oils, some means of ventilating that will carry away the disagreeable odor should be employed. Springs of all classes are usually hardened in oil.

When the lead bath is used for heating more or less of the lead and its dross will adhere to the work if it is put in dry. By covering the work with a thin coating of soft soap before immersing it, a thin charred covering will form over the surface of the steel which prevents the lead from adhering to it when removed from the bath. By first plunging the work into a brine solution this coating is removed, leaving a clear gray surface on the work.

When the workman is not familiar with the hardening of a particular brand of steel from which some expensive tool is made, it is usually advisable for him to experiment upon a small piece from the same bar and thus determine the lowest heat at which the steel will properly harden. It is important that the article hardens on the first heat as reheating is quite apt to injure the quality of the steel and adds to the possibility of loss by cracking.

Having hardened the work to a degree considerably beyond that required, it is then necessary to temper it, which involves the reduction of the hardness to the point necessary for the work required of the tool. The tempering of steel is accomplished by

gradually raising its temperature until the hardness has drawn or let down to the required point, when plunging the steel into water fixes the hardness. When the temperature has reached about 600 degrees Fahrenheit the hardness has been drawn down through the several points at which cutting tools for the various uses are tempered. If the rise in temperature continues past this point the hardness continues to disappear in proportion to the amount of heat given it. When a red heat is reached it has lost all the hardness given it in the hardening process and is again back to its normally soft condition.

The correct tempering of a piece of hardened steel for any class of work must therefore depend upon the workman's ability to raise the temperature to the proper degree before cooling. This he accomplishes by one of two methods; first by actually measuring the temperature with a thermometer and second, by what is known as the color method. Except in cases where tempering is done in a manufacturing way the latter method is the one always employed.

An understanding of the colors, the corresponding temperatures and the relation between color and hardness are quite necessary. Lathe and planer tools are given a hard temper. Their color is a straw yellow, which comes at a temperature of 460 degrees. A brown yellow at 500 degrees is used for milling cutters, taps, dies, and reamers. Light purple at 530 degrees is about right for twist drills and wood working tools and dark purple at 550 to a dark blue at 570 degrees is usual for cold chisels, screw drivers, and wood saws.

In determining the proper temper by means of a thermometer the following method is employed: Take for example the tempering of a quantity of small taps. Having been properly hardened they are placed in a wire basket and the entire mass suspended in an iron vessel filled with sperm oil. The vessel is covered with a closely fitting cover having a hole through the top sufficiently large to permit the stem of a thermometer, which is in the oil, to extend through for reading. As the temperatures required are considerably below the boiling point of mercury, a mercurial thermometer having the necessary range may be employed for determining proper temperatures. It is necessary to cover the oil closely, as otherwise it would flash up at the high temperatures employed. Heat is applied to the bottom of the vessel and the temperature of the oil and the articles in it

gradually raised until, in the present example, the thermometer indicates a temperature of 500 degrees. In order to obtain a perfectly even temperature in the oil it is advisable to arrange for some means of stirring it while the heat is being applied. The basket and its contents are taken out when this point is reached and immersed in cold water with the assurance that a uniform temper has been obtained in the entire batch.

In tempering by color, the article after being hardened is made bright by grinding or buffing. Taps and reamers for example are, after hardening and before tempering, ground in the flutes, thus leaving bright surfaces to show the run of the color. The article is then held over the fire, being constantly turned in such a manner that all parts are equally exposed to the heat. The raising of the temperature should be gradual and the surface closely watched for the first show of color. The color will start with a very light tinge of yellow which gradually changes into a straw yellow and next into the brownish yellow. If it is a tap or a reamer it is quickly immersed in cold water just as the yellow blends into the brown. If it was, for example, a cold chisel, the colors would be allowed to run from the yellow through the purples and into the dark blue.

As is the case when heating for hardening, difficult work, especially if long, can usually be heated for tempering in a muffler to very good advantage.

An excellent method of heating for tempering small tools, as taps, reamers, cutters, etc., is in a bath of sand. A suitable tray covered with about one inch of pure white sand supported over a series of gas burners is employed. By first burning all the impurities out of the sand false colors will not be shown on the articles being tempered. The article, if small or thin, can be laid on the top of the sand, but if larger, it should be buried in it, only a small part of the surface being exposed to show the starting of the color.

In the tempering of a piece of steel, the strains are such that the form of the article usually undergoes a change. This may occur in either the hardening or the tempering or both. In such tools as milling cutters and reamers which receive their final finishing by grinding after they are tempered slight changes in form are not troublesome. With long taps, drills, formed cutters, etc., it becomes a more serious question. Take, for example, a stay bolt tap two feet long. Although the greatest care

is exercised in tempering, it usually comes out badly bent. In straightening work of this kind it is necessary to heat it up very nearly to its temper point, place it between a pair of centers, revolve it quickly by drawing the hand over it and note with a piece of chalk the high point or belly. Place it with the belly down and by means of a lever or small jack having a quick pitch screw, spring the work in the direction opposite to its curvature and beyond its proper position an amount somewhat greater than its temper bend. Hold it in this strained position for a few seconds, remove quickly and immerse in cold water. The experience gained in a few trials will usually enable the operator to successfully straighten work of this character.

As a general rule it is not advisable to leave tool steel long in the fire as "soaking" is usually injurious to its structure. Occasionally, however, a piece of steel known to be of good quality will resist hardening properly when treated by the regular methods. In such cases it can usually be hardened if allowed to remain in an even fire and "soak" for a considerable length of time.

When a hard surface and soft center are required, as is often the case when the tool must stand severe strains and shocks, it is given a quick surface heat, the core remaining comparatively cool, and then plunged into the cooling solution. This hardens the surface and leaves a soft strong core. Large mandrels, punches, dies and articles of that class are usually hardened in this manner.

As the high carbon steels harden at comparatively low heats they should never be given a high heat either for forging or hardening as the dangers of burning them are great.

Forged articles, as lathe tools and cold chisels, are usually hardened and tempered with the same heat. In such cases only a small portion at the cutting edge is tempered. It is heated for a considerable distance back from the part to be tempered and the heat in this portion is used in drawing to temper the cutting portion. For example, a cold chisel which should be tempered for only a short distance back from the point, is given a proper heat for hardening at the point and this heat allowed to run back two or three inches. In quenching only the point for a half inch or so back is immersed and held until the red has nearly faded out of the heated portion. It is then removed and the bit brightened up, by a few quick strokes over its surface with a piece of emery cloth, sand stone or any grinding material at

hand. The operator then watches for the color, the heat in the balance of the tool being sufficient to draw the point. The straw colors will start first and move toward the point; these will be quickly followed by the purples and the blue, and just as the required color reaches the point the tool is plunged in the water. When too much heat remains in the tool after the hardening of the point, the temper draws too fast and the point must be immersed a second time to check the drawing, as it would not do to immerse the whole tool while so much heat remains in it. On the other hand if too little heat remains with which to draw the temper, it will be necessary to draw in the open fire as above explained.

What are known as tungsten or self-hardening steels have come into very general use for machine shop cutting tools which require no machine work upon them and little or no forging. These steels are produced by adding several per cent of the metal tungsten to the carbon steel. This makes a steel possessing great hardness without the necessity of tempering. It is very "short" when heated and requires great care and skill in forging. It is usually used in special holders and ground to shape without the necessity of forging. After heating for forging the steel must be allowed to cool in the air as immersion in water is sure to crack it. It must be nicked on an emery wheel and broken to required lengths, as it cannot be cut when cold.

The demand for high cutting speeds and the comparatively recent introduction of high speed cutting steels to meet this requirement is creating a vast amount of interest. These steels are, unlike tungsten steel, capable of annealing and consequently can be used for making tools of finer class, as milling cutters, reamers, etc. In some recent experiments by the author with "Novo" air-hardening steel, cutting speeds as high as 110 feet per minute at coarse feed and moderate cuts on mild steel forging without lubrication, were successfully maintained. Although the cutting edge quickly drew to a dark blue it held its keenness for an unusual length of time. It is quite evident that for heavy roughing work these steels are remarkably well adapted and that the rigidity and ordinary spindle speeds of standard engine lathes are not sufficient for its most effective use.

In forging the "Novo" steel it is at all temperatures other than a white heat "hot short" and crumbles or crushes away. It cannot be burnt and for forging and hardening must be given

a uniform white welding heat. When thus heated, for hardening, it is placed immediately under the strongest and coldest air blast available and left until quite cold. It is not drawn or tempered after hardening. These steels, although extremely hard, possess reasonable strength. It is advisable, however, for heavy work to use as large a bar as possible, not only because better support to the cutting edge can be had, but because the large body of steel conducts away the heat caused by the cutting much more rapidly than can a small tool.

The case hardening of iron and mild steel is a process whereby the surface of the work is converted into tool steel and hardened. This is accomplished by heating the work in contact with a material, rich in carbon, which gives up its carbon to the work.

When large numbers of pieces are to be case hardened they are packed in an iron box with granulated rawbone and fine charcoal mixed in about equal proportions. For the rawbone may be substituted bone black, charred leather or some one of the various special preparations for this work. The box is sealed with an iron cover and fire clay at the joints to exclude the air and prevent the escape of the gases as far as possible. It is then placed in the furnace and allowed to slowly heat up to a low red heat, at which temperature it is maintained for a length of time depending upon the depth it is desired to convert the surface of the work into tool steel. Under favorable conditions the surface will harden to a depth of 1-32 inch, by heating about two hours; 1-16 can be obtained in from five to six hours and by heating for eighteen or twenty hours, a hardened surface as thick as $\frac{1}{4}$ -inch can be obtained.

After heating the contents of the box, it is dumped into a tank of cooling water preferably of considerable depth, as the articles should be well cooled before they reach the bottom. By allowing the articles to fall a short distance through the air before striking the water, the coloring of the surface will be improved.

When only a few pieces are to be treated, they may be heated in an open fire to a bright red; the surfaces to be hardened then covered with cyanide of potassium and again heated before cooling in the water. The thickness of the case hardened surface thus obtained is quite thin. By several applications of the cyanide it can be made sufficiently thick for most requirements.

Another and very satisfactory method is to melt in a black lead crucible, equal parts of cyanide of potassium and fine salt. Bring this up to a bright red heat and immerse the articles to be hardened in it, leaving for a length of time depending on the degree of hardness required. Five to ten minutes will give a thickness sufficient for all ordinary requirements.

When finely mottled surfaces are desired, the work should be polished and thoroughly cleaned before treating. The blowing of air through the cooling water at the time the work is cooled will add much to the beauty of the markings on its surface.

CHAPTER XXX.

FASTENINGS.

The term "fastening" applies to those devices used by the machinist for holding together in their relative positions the various elements that make up a machine. Their importance in mechanical work cannot be overestimated, and a brief description of the more important cases seems advisable.

With few exceptions, all threaded fastenings use the sharp V or United States standard form of thread. In Fig. 585 are shown the three forms of machine bolts most used. The manufacturers of machine bolts have adopted the United States standard form of thread and as a consequence these bolts run reasonably close to size, but a trifle small. A $\frac{5}{8}$ bolt, for example, will pass through a $\frac{5}{8}$ drilled hole. The square head and nut bolt as shown at A is most used on general work. When the nut comes in a place where it is difficult to get at it with a wrench, the hexagon nut is substituted for the square. At B the bolt has both hexagon head and nut, presenting a more finished appearance. The snap or round head machine bolt is shown at C. It differs from the others only in its form of head. Carriage bolts are similar as to diameter and form of thread to the machine bolt shown at C with the exception of a square under the head which prevents them from turning when used in wood. The length of this square section is approximately equal to the diameter of the bolt.

On square and hexagon head machine bolts, the thickness of the head is $\frac{3}{4}$ the diameter of the bolt and the thickness of the nut is $1\frac{1}{8}$ the diameter. The width of the head and nut between flats is $1\frac{3}{4}$ the diameter of the bolt in both the hexagon and square. The width from angle to angle on the hexagon is two times the bolt diameter. A table of weights and dimensions of machine bolts is given in Chapter XXXIV.

Turned machine bolts, commonly known as coupling bolts, are much used for holding together machine and engine parts. In such cases they fit closely in reamed holes.

Machine bolts with specially formed heads and nuts are frequently used. As they are not regularly carried in stock by the

manufacturers and must be made up to order, any desired form may be had.

When the character of the work is such that one of the parts that are being secured together can be tapped, a stud bolt or cap screw may be used. In Fig. 586 at A is shown the standard form of milled stud. The short thread is usually made slightly larger than the long one, as it is intended to fit closely the tapped hole in the work. The stud when set extends above the surface an amount sufficient to receive the work and a nut on the outside.

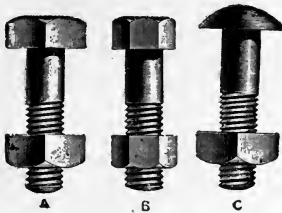

FIG. 585.

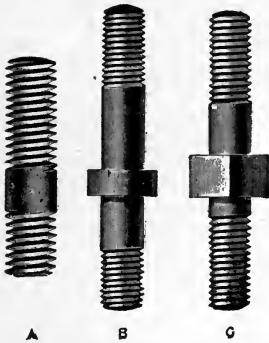

FIG. 586.

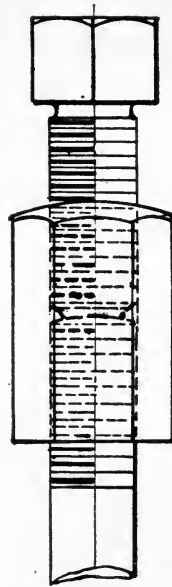

FIG. 587.

At B and C are shown two forms of special collar studs used only on special work. In Fig. 587 is shown a simple device for setting studs. A piece of hexagon steel with a tapped hole through it as shown, is screwed on the end of the stud and the special set screw tightened against the end of the stud. The set screw should be cupped slightly as shown, and hardened. It is also advisable to case harden the body. By using two wrenches the device is readily removed after the stud has been set.

It is frequently necessary to lock the nuts on bolts and studs to prevent them from working loose. The use of two nuts, as

shown in Fig. 588, at A, is a very common method. The thinner nut is called a lock or check nut and is usually one-half the bolt diameter in thickness. The check nut is usually put on the outside; a better distribution of the strains, however, is obtained when the thin nut is placed on the inside. This arrangement of nuts while not absolutely proof against their working loose, can usually be relied upon. By allowing the bolt to extend through the nut an amount sufficient to permit drilling a hole and inserting a cotter key, as shown at B, a most satisfactory safeguard against losing the nut is obtained. The cotter key in connection with the jam nut is perfectly safe.

Devices of the character of the one shown in Fig. 589 are

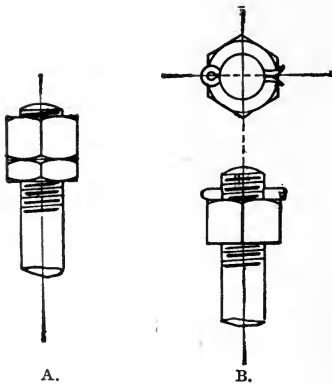

FIG. 588.

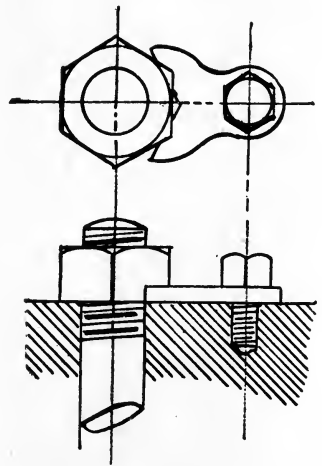

FIG. 589.

occasionally used in connection with standard nuts. More often, however, a special nut having a notched rim is used in connection with a dog to engage the notches and secured to the body of the work.

Cap screws are similar to coupling bolts without nuts. In Fig. 590 are shown three styles; at A, a square head; at B, a hexagon head, and at C, a form known as a tap bolt which is threaded close under the head. When cap screws are used in places where they must often be turned, they are usually of the forms shown in Fig. 591 and known as collar cap screws.

Cap screws with slotted heads for a screw driver, are shown

in Fig. 592; the flat head at A; the round or button head at B, and the fillister head at C. These are known as machine screws when of machine screw diameter and threads.

Set screws are made of steel and tempered or of iron and case hardened. They form a convenient and largely used means of securing pulleys, collars, etc., to shafting, and in their headless

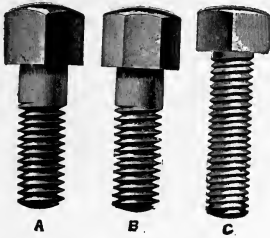

FIG. 590.

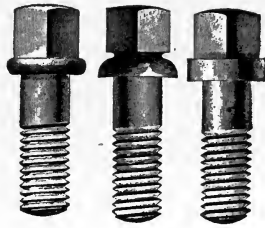

FIG. 591.

forms for holding liners and other machine parts. Set screws are not well suited to the holding of pulleys that must transmit much power, as they do not get much bearing on the shaft and as a result are very apt to slip. The standard form of set screw is shown in Fig. 593, as is also the headless pattern. What are known as low head or collar set screws have square heads of

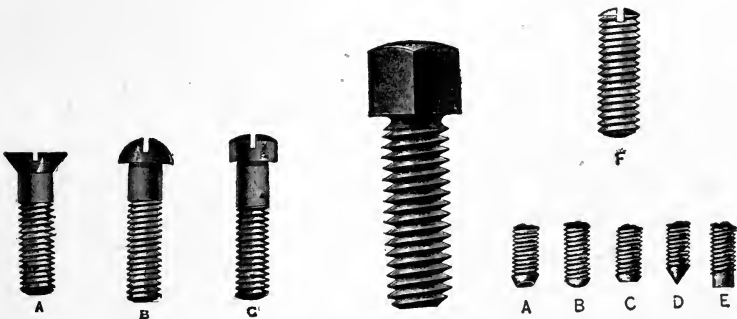

FIG. 592.

FIG. 593.

about one-half the height of the regular head. In this figure are also shown the various forms of points used on set screws. A and B, the cupped and oval points, are regular patterns. The flat point C, the cone point D, and the pivot point E are specials.

Studs, cap, and set screws are regularly made with both the

sharp V and United States standard threads; unless the latter is specified, orders are always filled with V threads.

Square and hexagon nuts may be had either hot or cold pressed, commonly known as black and bright. The cold pressed nuts are those usually used on machine and engine work. A plain nut, tapped and faced on the work side meets the necessities of any case. It is not, however, when applied to well-finished work, in keeping in appearance. It is therefore usual to use what are termed semi-finished, finished or finished and case hardened nuts on good work. A semi-finished nut is faced bottom and top and chamfered on the top. A finished nut has its faces buffed or

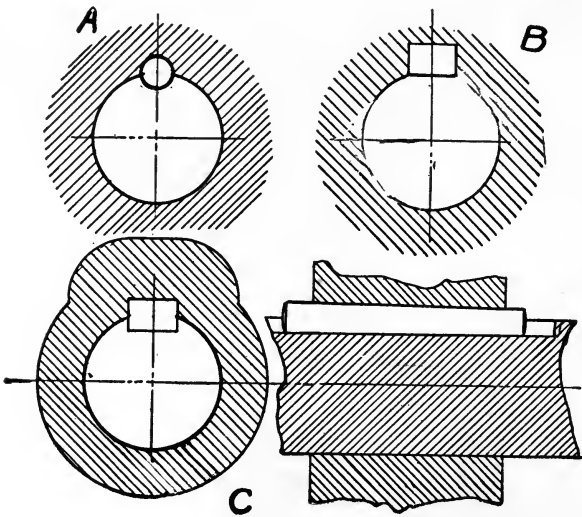

FIG. 594.

ground smooth in addition to the facing; and the case hardened nut, as its name indicates, is hardened after being finished.

Keys and feathers are much used in machine construction in the fastening of the parts to shafts. In Fig. 594 are shown the three forms of keys most used. The round key, shown at A, is used in places where little power is to be transmitted and on light work only. A small hole drilled half in the hub and half in the shaft receives the round key, which is usually not tapered and driven firmly in. By tapping the hole, a headless screw can be substituted for the round key. This not only provides a means for removing if necessary, but prevents the possibility of any

motion in the direction of the shaft's length. Keys of this kind can be properly applied only when the end of the shaft and hub are in the same plane. When the hub and shaft are of different materials, as is usually the case, difficulty is experienced in making the drill follow the joint, as it will tend to crowd toward the softer metal.

Where the strains transmitted are moderate, the flat key shown at B may be employed. As the flat on the shaft can, if necessary, be filed, this forms a most convenient method of keying after a shaft is in place. The width of the key should be from one-quarter to one-third the diameter of the shaft. If the key way is tapered in the hub the key should have the same taper and can be driven firmly to its seat. If the key way is straight it is necessary to use two set screws over the key.

The flat key sunk in the shaft, as shown at C, is the most reliable and consequently most used. It is a tapered key fitting closely in the sides and driven to a tight top and bottom fit. By using a straight key way with set screws over each end the key may be made straight.

Practice as to the taper and dimensions of keys is somewhat at variance. Good practice, however, indicates the use of 3-16 of an inch taper per foot with a width of key equal to one-quarter the shaft diameter and a thickness equal to one-sixth the shaft diameter. For shafting a width equal to one-quarter the diameter and a thickness 1-16 of an inch less than the width is much used.

Tapered keys are little used by machine tool builders owing to their tendency to throw the parts out of true, due to the radial strain. For such work straight square keys fitting neatly on the sides but loose top and bottom are much used. Straight keys should be set one-half their thickness in the shaft and the depth of key seat should be measured from the sides, not the center. With tapered keys the depth of key way in shaft should be one-half the thickness of the key at its middle section. A recommended practice is that the depth of key way in shaft should equal two-fifths the thickness of the key at its thick end.

Feather keys are much used by machine tool builders. They are usually of a thickness greater than their width and are not fitted tight top and bottom. When fitted in this manner the key does not hold against motion along the shaft, consequently very close fits between shaft and bore are necessary.

Sliding feathers are those which are doweled in the hub

where a sliding fit of the spindle through the hub is required, as with drilling machine spindles, feed rods, etc. Feathers of this kind should be long in order to resist wear, and as they must fit the spline in the spindle freely they drive from the hub seat and should therefore have a close deep bearing in this seat. It is usual to make sliding feathers of a thickness equal to one and

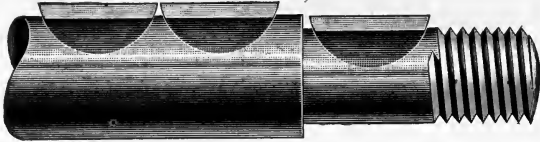

FIG. 595.

one-half the width with one-half their thickness in the hub. When necessary it is of course possible to reverse the conditions and dowel the feather in the shaft, the hub sliding over it.

The Woodruff system of keying, as largely used by machine tool builders, is illustrated in Figs. 595 and 596. The key is a semi-circular disc of soft steel of the required thickness. The

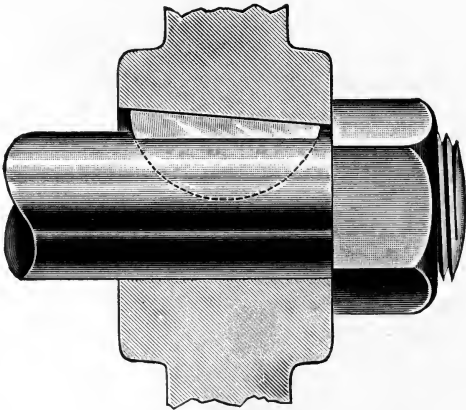

FIG. 596.

cutter for making the seats is shown in Fig. 488. It is dropped the proper depth in the shaft to receive the key as shown. When a long key is required two or more of the keys are placed end to end, as shown in Fig. 595. When used as a tapered key, as shown in Fig. 596, they adapt themselves perfectly to the taper

in the hub and thus overcome the danger of cocking the work as with the flat tapered key when the tapers do not exactly correspond.

When taper keys are used in places where there is a possibility of having to remove them some provision must be made for either drawing or drifting them. If the key way is sufficiently long and the back end of the hub can be gotten at the key can be drifted out, otherwise some form of head must be provided on the key to make it possible to draw it.

In Fig. 597 is shown the Morton gib head key and the method

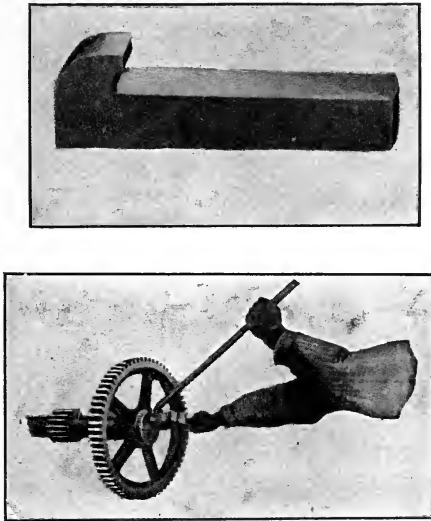

FIG. 597.

of drawing it. The under cut head gives the end of the pinch bar a hold and prevents its slipping off. The stepped fulcrum blocks shown insure a square pull on the key. In this manner gib head keys can be safely drawn. The driving of a wedge between the hub and the head of the key injures the head and is very apt to bend the key. Two wedges of equal angle introduced from opposite sides and driven equally, answers very well. As they tend, however, to bend the head toward the center of the shaft, a heavy weight should, if the key comes hard, be held under the head.

Keys should always be well oiled before driving them home.

In Fig. 598 is shown a taper pin. They are made in sizes from No. 0 to No. 10, varying in length from $\frac{3}{4}$ of an inch to 6 inches and in diameter from approximately 5-32 to 23-32 at the large end. They fit holes reamed with the standard taper pin reamers and are much used by machinery builders for securing collars, gears, couplings, etc. They can be easily removed and when again put back it is with the absolute certainty that the parts are back in their exact relative positions. They are not, however, suited to the transmitting of heavy loads.

The cotter pin or key, Fig. 599, is but little used for purposes other than those illustrated in Fig. 588.

Rivets make the simplest form of fastening. They are, however, permanent fastenings, which can only be removed by cutting



FIG. 598.

FIG. 599.

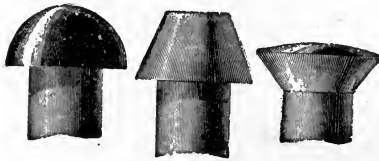

FIG. 600.

off the head. Rivets are little used for purposes other than the holding together of metal plates. They are made of soft tough steel or iron, steel rivets being most used on the heavier steel plate work. Good rivets should stand riveting up cold, without cracking, a method most used on light work. For heavy plates, as used in boiler and structural steel work, the rivets are of the forms shown in Fig. 600 and are set hot.

Riveted joints are of two kinds, lap and butt joints. These are shown at A and B, Fig. 601. In the lap joint the plate edges lap over each other, while in the butt joint the edges come squarely against each other and a cover strip is placed over the joint and riveted to each edge.

A single riveted joint is one in which a single row of rivets are used. The lap and butt joints shown in Fig. 601 are examples

of single-riveted joints. When two lines of rivets are used it becomes a double riveted joint and three lines a triple riveted joint. A covered lap joint is shown in Fig. 602. A cover plate

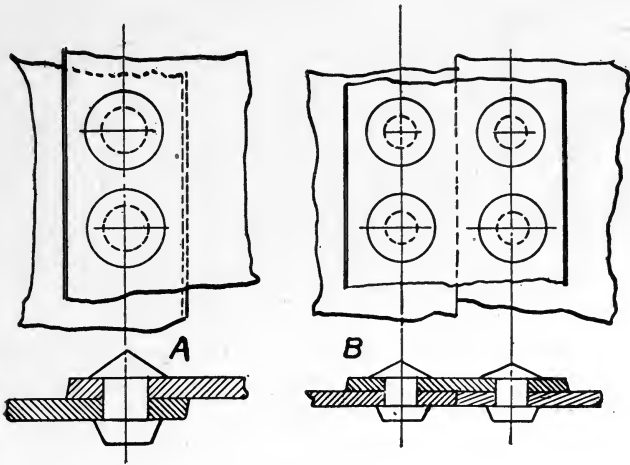

FIG. 601.

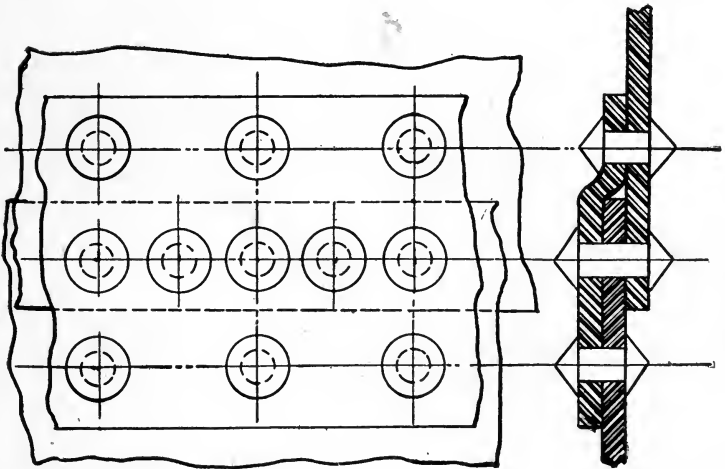

FIG. 602.

is flanged and riveted over the joint as shown. The lap joint rivets pass through the cover strip which is also riveted to the plates back of the joint. A double cover butt joint is shown in Fig. 603. This joint brings the rivets in double shear.

Rivet holes are punched, or drilled. The latter method is much the more desirable, but owing to its greater cost, is not so extensively used as punching. In the punching of rivet holes the metal around the hole is injured by the pressure of the punch and as the holes must be laid out separately in each sheet

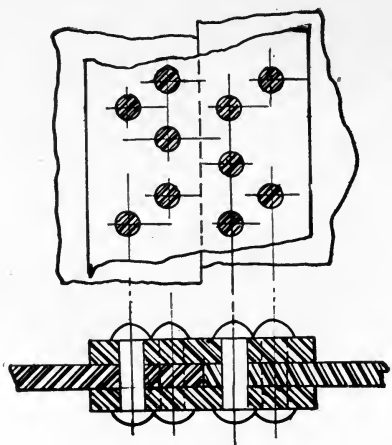

FIG. 603.

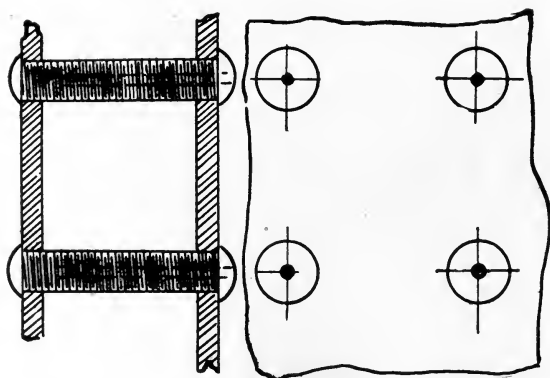

FIG. 604.

it is difficult to make them match properly. In drilling, both plates are usually drilled together and the metal is not injured in any way.

By punching holes somewhat smaller than the required size and reaming them out, the objection to punching is largely over-

come. If the plate is thick the edge after punching should be thoroughly annealed. The use of a drift pin in rivet holes to bring them fair is very objectionable as it strains the plate, frequently cracking it. In the drilled holes the sharp edges left are objectionable and should be slightly rounded for best results.

Rivets are usually set hot as they fill the holes better and due to their contraction in cooling draw the plates very firmly together. In cases where the rivets are long, it is usually necessary to cool the heads before riveting them, as otherwise the excessive amount of contraction is quite apt to break the rivet. It is most important in all cases that the amount of plate lap and the size and pitch of rivets be properly proportioned.

The strength of a riveted joint depends largely upon the manner in which it is put together. When properly designed and put

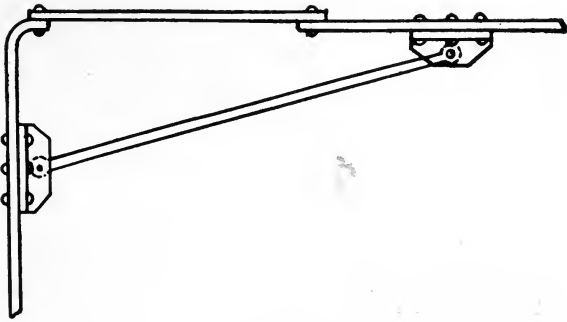

FIG. 605.

together, single-riveted joints will average from 50 to 55 per cent of the plate strength and double riveted joints from 65 to 70 per cent.

A stay bolt is a piece of iron or steel threaded its entire length and used to support parallel surfaces in boilers which are comparatively close together. By means of a long stay bolt tap, the holes in the plates are tapped together, the bolt is then screwed through the plates, cut off and riveted over, as shown in Fig. 604. When the plates are too far apart to permit the use of threaded stay bolts, some other form of stay must be used. The diagonal stay, Fig. 605, is frequently used. This braces the flat end to the shell of the boiler. The feet are riveted to end and shell and the rod connecting them is of the proper size to carry the load.

When the diameter of the shell is great, the feet are attached to both ends, and the tie rods run the entire length of the boiler. When a number of such stays are used in a boiler they must be of the same length as otherwise an excessive strain is thrown on the short ones.

In many cases flat surfaces, as for example, the crown sheet

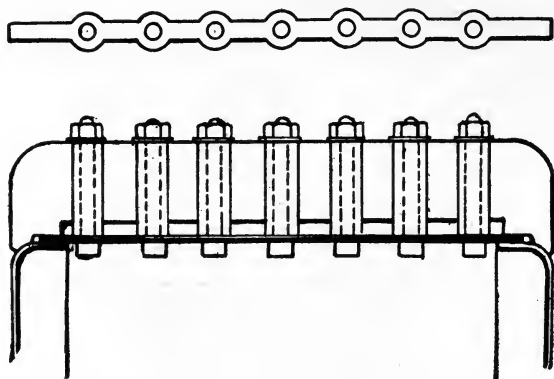

FIG. 606.

of a fire box, are supported by arch or girder stays. Such a stay is shown in Fig. 606. The ends of the stays are supported on the sides of the fire box and the crown bolts shown support the crown sheet against the downward pressure.

CHAPTER XXXI.

GEARING.

The term gearing, although a general one covering all means of transmitting motion, is more especially applied to wheel gearing in which motion is transmitted from one shaft to another by means of toothed wheels.

Two perfectly smooth rimmed wheels rolling together constitute a geared pair, commonly known as friction gears inasmuch as the one drives the other by friction. When the force transmitted is in excess of the frictioned resistance, slipping occurs and consequently a fixed relationship between the axes of the two gears can not be maintained. Such a pair of wheels are shown in Fig. 607, A and B.

In general practice frictional gearing is not extensively used. It is frequently found in mill and hoisting work and more especially in gears for reversing purposes. This class of gearing should be very carefully made. The wheels must be round and the surfaces as true and smooth as possible. At least one of each pair should have a soft surface as of wood, leather or paper. This should be the driving wheel, the driven having an iron face, as in the case of any slippage, the wear on the soft-faced driver will be equal at all points on its surface and it will tend to retain its original round condition. If on the other hand the iron faced wheel is the driver and the soft faced wheel for any reason should stop, the driver would quickly wear a concave spot in the soft cover of the driven wheel.

If we assume the wheels of Fig. 607 of the same diameter and rolling together without any slip, a point on the rim surface of one travels at the same rate of speed as any point on the rim of the other, and the distance that these points travel in the unit of time is called the "linear velocity."

The rate at which this point measures angles is termed its "angular velocity." Thus with wheels A and B, the linear and angular velocities are the same. If we substitute for B another wheel C of one-half the diameter of A, the linear velocity of any point on its circumference must still equal the linear velocity of B, but its rate of measuring angles is double that of B consequent-

All gears have an imaginary circle called the "pitch circle" which corresponds to the circumferences of the wheels shown in Fig. 607 and are the circles which would, if the tops of the teeth were cut off, roll together with the same angular velocity as did the gears. This circle is shown in Fig. 608. That part of the tooth outside of the pitch circle is called the "addendum" and the portion inside is called the "land," or "dedendum." That part of the tooth outline outside of the pitch circle is called the "face" and that part inside of the pitch circle the "flank." The "pitch point" is where the "face" and "flank" join at the "pitch circle." The "root circle" passes through the bottoms of the teeth and the "addendum circle" passes through the tops of the teeth. The diameter of the "addendum circle" is the whole or blank diameter of the gear.

The "circular pitch" of gear teeth is the distance measured on the pitch circle from the pitch point of one tooth to the corresponding point on the next tooth. By "diametral pitch" is meant the number of teeth in the gear per inch of its pitch diameter. Thus if the pitch diameter of a gear is 10 inches and there are 80 teeth in the gear, the diametral pitch would be 8. The pitch circumference is, in the same case, $10 \times 3.1416 = 31.416$ inches

and $\frac{31.416}{80} = .3926 =$ the circular pitch. In any case 3.1416

\times the diameter divided by the number of teeth equals the circular pitch and as the diameter divided by the number of teeth equals

$\frac{1}{P}$, the simple expression $\frac{3.1416}{P} =$ the circular

pitch where $P =$ the diametral pitch. Nearly all gear calculations are now made in terms of the diametral pitch. In the making of patterns, the work is usually based on the circular pitch, which, however, is deduced from the diametral pitch as above. In the cutting of racks it is necessary to know the circular pitch in order to properly space for the teeth.

The addendum equals on standard gear teeth $\frac{\text{one inch}}{\text{diametral pitch}}$
 $=$ in above case $\frac{1}{8}$ inch. This gives for the whole diameter, the pitch diameter $+$ $\frac{1}{4}$ inch or twice the addendum. The flank of the tooth equals the face, thus giving for the working depth twice

the addendum or two diametral pitches. Bottom clearance is usually made equal to 1-10 of the thickness of the tooth on the pitch line.

The thickness of the tooth and width of the space measured on the pitch line are for carefully cut gears practically equal. When the teeth are cast and consequently not perfect as to form, it is necessary to make the tooth slightly thinner than the space. This difference is called the back lash.

In a pair of gears the distance between their axes is equal to the sum of their pitch radii, or is equal to one half the sum of their teeth divided by the diametral pitch.

The number of teeth in a gear may be found by multiplying together the pitch diameter and the diametral pitch. If the number of teeth and the diametral pitch are known, the pitch diameter is found by dividing the number of teeth by the diametral pitch and if the number of teeth and the pitch diameter are known, dividing the number of teeth by that diameter gives the diametral pitch.

The whole diameter in any case equals the pitch diameter plus two diametral pitches, or if the number of teeth and diametral pitch are known add two to the number of teeth and divide by the diametral pitch. In cases where the circular pitch is given, reduce it first to diametral pitch by dividing 3.1416 by it and apply the above rules.

The ratio between the number of revolutions that one gear makes for one revolution of its mating gear is called the "velocity ratio." This ratio equals the number of revolutions of one gear in a given time divided by the number of revolutions of the other gear in the same time, or what is the equivalent, the pitch diameter of one, or its number of teeth, divided by the pitch diameter or number of teeth of the other. The above considers the gears as round and turning about their central axes, thus giving a constant velocity ratio. This is the condition most common in practice.

In the cases of lobed and elliptical gearing, the velocity ratio is constantly changing and for any part of a revolution must be taken in terms of the pitch diameters, acting at that instant. If the ratios of complete revolutions are considered, they may be had in terms of the revolutions per unit of time or the number of teeth.

The gears in common use may be divided into classes as follows:

First, spur gears; those having straight tooth elements parallel with the axis and used for connecting parallel shafts. The teeth are cut on parallel cylinders.

Second, bevel gears; those having straight tooth elements which meet in a common or focal point and are used for connecting shafts whose prolonged axes intersect. The teeth are cut on conical surfaces.

Third, worm gearing; those having spiral tooth elements and used for connecting shafts at right angles, axes not intersecting. The teeth are formed on cylindrical surfaces.

Fourth, spiral gears; often called, twisted, screw, or helical gears; those used for connecting shafts which are not parallel and do not intersect. The teeth are formed on cylindrical surfaces.

As it is of very great importance in nearly all cases to maintain a constant velocity ratio at all points in a gear's rotation, care must be exercised in the forming of the teeth. Many forms of tooth outline can be made that will meet this requirement; but for reasons of a practical nature, and the necessity for uniformity, but two systems are in general use—the "involute" and the "cycloidal" systems. Of these two systems the "involute" form of tooth is the more used and considered by many of the best authorities on gearing, as superior to the "cycloidal" system. In fact the general adoption of this system has been strongly urged and from the point of uniformity in gearing construction would be a most desirable move.

The "involute" tooth has a single curve outline. The "involute" curve is the curve generated by the end of a non-stretching band, as it is unwrapped from a cylinder, as shown in Fig. 609. By taking the points a and b comparatively close together and setting the dividers to that distance, the other points, c, d, e, etc., may be stepped off. Through each point draw a tangent to the circle and step off on the tangent the number of spaces it is from the origin of the curve, thus locating a point of the curve, as shown at 5. The curve passing through a series of points thus located is the "involute" of the circle. If the points are taken sufficiently close together to make the chord and its arc connecting them practically equal, this method may be considered exact.

In practice a curve which approximates the "involute" curve

is employed and the circle upon which it is laid out is called the base circle. This circle lies inside of the pitch circle an amount differing slightly in the methods practiced by the leading makers.

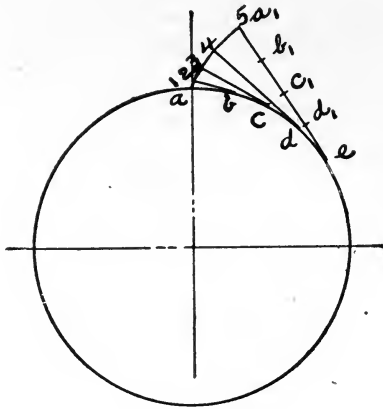

FIG. 609.

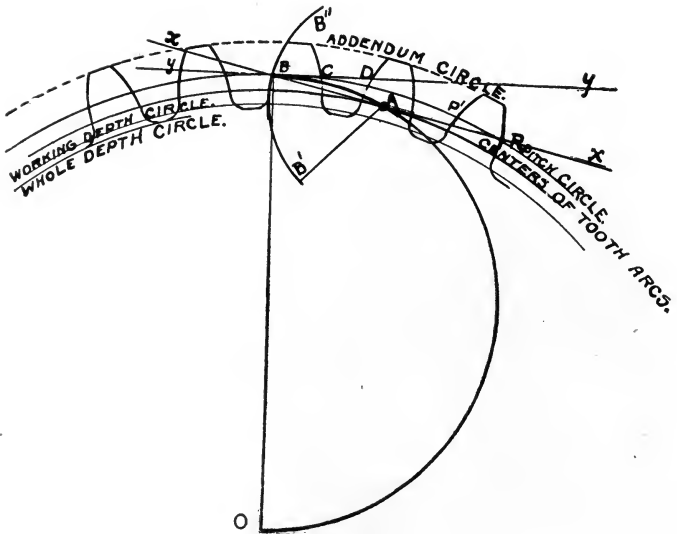

FIG. 610.

Brown & Sharpe make the diameter of the base circle .968 of the pitch circle. Their graphical method of making the single arc approximation for gears having 30 teeth or more, is shown in Fig. 610. Having laid down the addendum and pitch circles,

teeth, it becomes necessary to round the addendum of the rack teeth to prevent interference with the flank of the pinion tooth.

The Grant odontographic method of laying out "involute" gear teeth to approximate arcs is given in the following table and illustrated in Fig. 612.

GRANT'S INVOLUTE ODONTOGRAPH.

TEETH.	Divide by the Diametral Pitch.		Multiply by the Circular Pitch.	
	Face Radius.	Flank Radius.	Face Radius.	Flank Radius.
10	2.28	.69	.73	.22
11	2.40	.83	.76	.27
12	2.51	.96	.80	.31
13	2.62	1.09	.83	.34
14	2.72	1.22	.87	.39
15	2.82	1.34	.90	.43
16	2.92	1.46	.93	.47
17	3.02	1.58	.96	.50
18	3.12	1.69	.99	.54
19	3.22	1.79	1.03	.57
20	3.32	1.89	1.06	.60
21	3.41	1.98	1.09	.63
22	3.49	2.06	1.11	.66
23	3.57	2.15	1.13	.69
24	3.64	2.24	1.16	.71
25	3.71	2.33	1.18	.74
26	3.77	2.42	1.20	.77
27	3.85	2.50	1.23	.80
28	3.92	2.59	1.25	.82
29	3.99	2.67	1.27	.85
30	4.06	2.76	1.29	.88
31	4.13	2.85	1.31	.91
32	4.20	2.93	1.34	.93
33	4.27	3.01	1.36	.96
34	4.33	3.09	1.38	.99
35	4.39	3.16	1.39	1.01
36	4.45	3.23	1.41	1.03
37-40		4.20		1.34
41-45		4.63		1.48
46-51		5.06		1.61
52-60		5.74		1.83
61-70		6.52		2.07
71-90		7.72		2.46
91-120		9.78		3.11
121-180		13.38		4.26
181-360		21.62		6.88

Draw the rack tooth by the special method.

In this system all gears up to 37 teeth have tooth outlines to a double arc approximation and above that number a single arc outline. These determinations are based on a 15 degree line of action.

In the application of the Grant method, Fig. 612, the pitch, addendum, root, working depth and base lines are laid out. The base circle is taken at 1-60 the pitch diameter inside of the pitch circle. If the data is in terms of the diametral pitch, the face and flank radii are taken from the tabulated columns under diametral pitch, and if in terms of the circular pitch they are taken from the columns under circular pitch. These values are divided or multiplied, as indicated, by the pitch. The pitch points are next located, and with the dividers set to the face radius, the faces are drawn in from the pitch point to the addendum with centers in the base circle; and in like manner with the flank radius, the flanks are drawn in from the pitch point to the base line. From the base line to the working depth the flank is a radial line

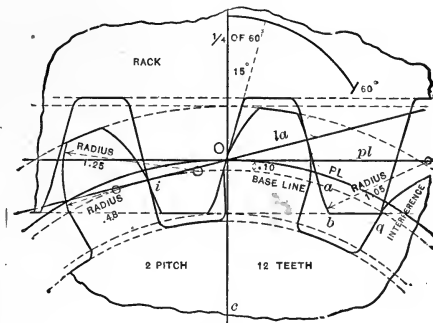

FIG. 612.

from the center of the blank. A fillet between working depth and root completes the tooth outline. The rack teeth in this system have flanks, and the inner half of the faces, at 15 degrees with the pitch line. The outer half of the tooth face is drawn from a point in the pitch line with a radius equal to 2.10 inches divided by the diametral pitch or .67 inches multiplied by the circular pitch.

Gears having the "involute" form of teeth are the only ones that can be run with the axes at varying distances and still transmit uniform angular velocity. The line of action varies, however, as the axes are separated.

In the "cycloidal" system of gearing the tooth outline is made up of a double curve, the face being an "epicycloid" and the flank a "hypocycloid." The system is commonly known as the "epicycloidal" system.

An "epicycloid" is the path of a point in the generating circle rolling on the outside of another circle, which in gearing problems is the pitch circle. A "hypocycloid" is the path of the point generated when the circle is rolled on the inside of the pitch circle. These curves are shown in Fig. 613.

When the diameter of the generating circle is equal to the radius of the pitch circle the path of the generating point is a radial line. The prevailing practice makes the flank of the 15 tooth gear in this system radial which for an interchangeable system makes the diameter of the generating circles equal to the pitch radius of a 15 tooth gear.

In the Grant system a gear of 12 teeth is taken as the basis,

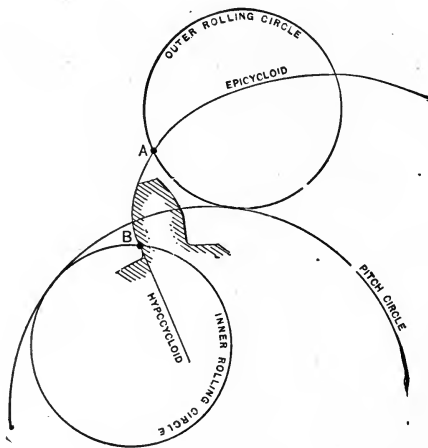

FIG. 613.

which gives a stronger pinion tooth for and above fifteen teeth than the 15-tooth basis.

The rack of the interchangeable cycloidal system has teeth of double curve outline, generated by rolling the generating circle along each side of the pitch line, as shown in Fig. 614. These curves are cycloids.

Although it is a comparatively simple operation to lay out the "cycloidal" form of tooth by means of the rolling generating circle, numerous approximate methods are in use. Notably the Grant three-point double arc approximation and the Klein method by the use of tabulated co-ordinates, which latter method is also applicable to the "involute" tooth outlines.

In the "cycloidal" form of tooth the line of action is perpendicular to the line of centers when the point of contact crosses that line. For all other points of contact the line of action is at an angle with the line of centers, being a maximum at the points where the teeth make and break contact. In general practice the line of action in cycloidal gears varies from zero degrees at the line of centers to about 30 degrees each side of this line.

"Cycloidal" teeth are conjugate only when the centers of the gears are properly pitched and will not admit of as wide variations in form and adjustment as will the "involute" teeth. As the form of a tooth in either system changes for every number of teeth, a cutter can be of correct outline for but one number of teeth. For ordinary requirements, however, 8 cutters for the

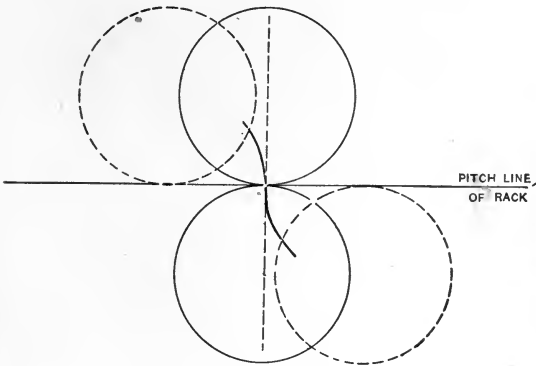

FIG. 614.

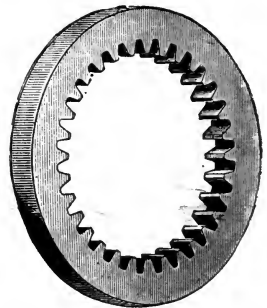

FIG. 615.

"involute" and 24 for the "cycloidal" cut all numbers of teeth, in any one pitch from 12 to a rack.

The annular or internal gear is a spur gear in which the teeth are on the inside of the rim. In the internal gear, an example of which is shown in Fig. 615, the teeth correspond with the spaces of an external spur gear. Annular gears may have either the "involute" or "cycloidal" form of teeth. They come under the same general rules as for external spur gearing. The limitations are, however, more closely drawn.

Bevel gears are used to communicate motion from one shaft to another when the axes of the shafts intersect. In most cases the axes are at right angles with each other. They may, however, be at any angle, their limits being the external and internal spur gears, at which points the axes become parallel.

As in spur gearing, where we assumed two cylinders as rolling together, we may in bevel gearing assume two cones or portions of cones as rolling together. If they roll without slipping, the angular velocity is the same for all points and the velocity ratio is the same at any point between the base and the apex. If now we assume the surfaces of these cones as pitch surfaces, and produce teeth upon them, all lines of which terminate in the apex or focal point, we have a pair of bevel gears which will roll to-

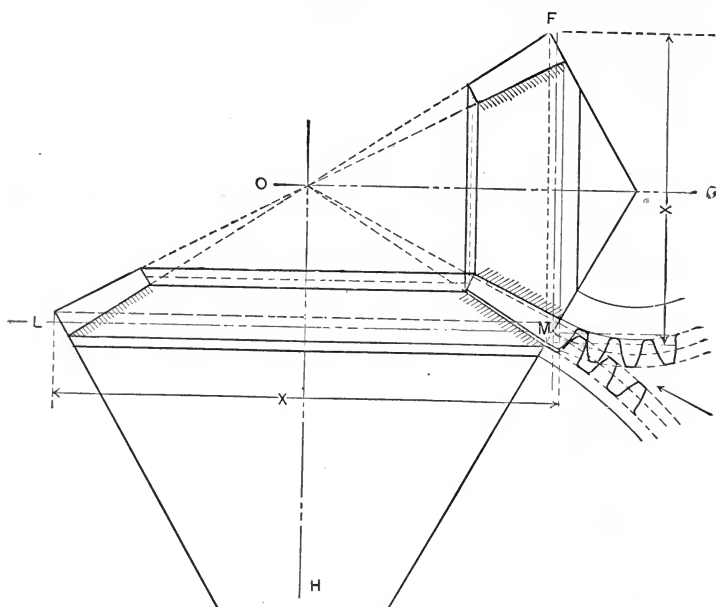

FIG. 616.

gether without slipping and will, if the teeth are of correct form, maintain the same velocity ratio as will the pitch cones.

In bevel gears the relations between pitch diameter, pitch and numbers of teeth and velocities are the same as for spur gearing, thus making calculations pertaining to these points, the same as given for spur gears.

In obtaining the data for bevel gears it is customary to make a sectional drawing of one-half of each gear. In Fig. 616 is shown the usual method of laying out. The two axis or shaft centers $O G$ and $O H$ and the maximum pitch diameters $L M$ and $M F$ are laid out, the latter of lengths proportionate to the

required velocity ratio. The pitch cone lines $L O$, $M O$ and $F O$ and the back cone radii $M G$ and $M H$ are drawn. The calculations for the teeth are based on the largest pitch diameter. Looking at the gears from the direction indicated by the arrow the ends of the teeth appear as would the ends of teeth of spur gears, having pitch radii equal to the back cone radii $M G$ and $M H$. The outline of the tooth is laid out, as shown, in the same manner as for spur gears.

The whole diameters $X X$ and the pitch, root and top angles are usually measured from carefully made drawings.

The teeth of bevel gears may be of the "involute" "cycloidal," of "octoidal" forms and can be correctly formed only by a planing process. They may be cut to approximate form by a rotat-



FIG. 617.

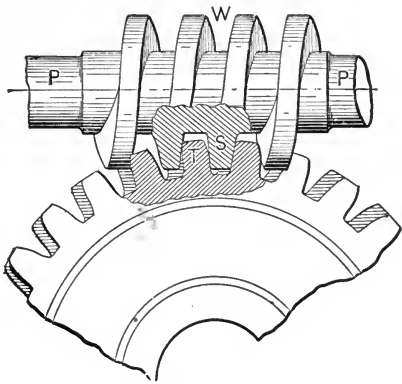

FIG. 618.

ing cutter, a method very largely employed especially on small gears.

Bevel gears of the same size connecting shafts at right angles are termed miter gears.

The efficiency of correctly cut spur and bevel gears is high, ranging from 90 to 99 per cent, depending upon velocity and perfectness of their application.

Skew bevel gears are those used in connecting shafts which are not parallel and do not intersect. They are but little used.

The worm gear and worm, an example of which is shown in Fig. 617, is used for transmitting motion from one shaft to another at right angles to it, axes not intersecting. The worm and gear is a limiting case in spiral gearing, the worm corresponding to a spiral gear having but one tooth.

gearing with low numbered pinions, this interference can be overcome for worm gears having a number of teeth under 30. Separating the pitch lines of correctly formed worms and worm gears, although overcoming interference, produces excessive back lash. The same results without the back lash may be obtained by enlarging the outside diameter of the worm gear, thus giving the tooth a short flank and bringing the action largely upon the faces of the teeth. These are extreme cases and should, if possible, be avoided. When the required velocity ratio necessitates a gear of fewer than 30 teeth, it is preferable, if possible, to double the number of teeth and use a double thread worm.

Worm gearing is largely used in places where a great velocity ratio is necessary with as few gears as possible. It is a locking mechanism in which the worm must always be the driver. This feature is made use of very largely in the application of this class of gearing to elevators and dividing mechanisms.

The tooth action is purely a sliding one and consequently this class of gearing is not well adapted to the transmission of heavy powers as its efficiency is necessarily low, from 50 to 75 per cent, and the wear is in such cases usually excessive.

When used for heavy service the concave form of tooth shown at A in Fig. 620 is best suited, due to its greater tooth surface.

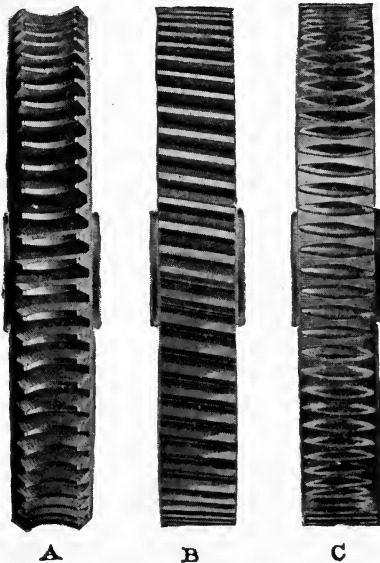

FIG. 620.

The form shown at C is largely used on dividing mechanisms where the strains are not great, and the form shown gives better protection to the teeth against injury. The form shown at B has but one advantage and that is the possibility of its being cut in a milling machine without the use of a hob. The teeth are cut with a spur gear cutter at the angle corresponding with the angle of the helix of the worm. As this gives a very imperfect contact between the teeth of gear and worm, it is suited only to the transmitting of very light loads. When the teeth are so formed it is possible to vary somewhat the angle of the axes from a right angle, as for example, if the gear shown at B was a spur gear, the worm would mesh with it by inclining its axis from its normal

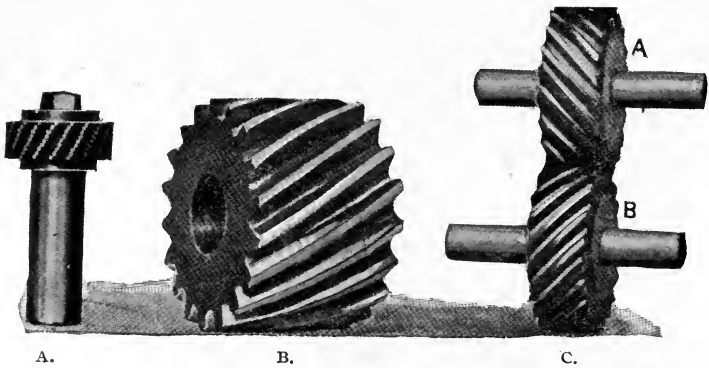

FIG. 62I.

position an amount equal to the angle of its helix. This produces an objectionable pressure in the direction of the gear's axis.

The distinction between worm and spiral gearing is not closely drawn. As the worm and worm gear approach each other in diameter, and the gear is given a low number of teeth with multiple threads on the worm, the problem blends from one of worm into one of spiral gearing.

Take a number of thin spur gears that have been cut together, shift them slightly about their axes so that the teeth do not line, as shown at A, Fig. 62I, and we have what is termed a "stepped" gear. Such a gear when running with a similar stepped gear will have a number of teeth constantly in contact, with practically one pair always passing the line of centers, thus producing a smoother motion than can be obtained with the common spur gears. If we consider these elementary gears as being extremely thin, the teeth

will blend into each other, forming what is known as the twisted gear, the outline of the teeth being of any desired form. When the teeth have a uniform spiral as shown at B, Fig. 621, the gear is called a screw or spiral gear.

When the teeth of twisted gears are other than true spirals, they must work together the same as spur gears on parallel axes, the pitch surfaces rolling upon each other. With screw gearing the axes may be at any angle with each other, and for all angles there will be sliding contact between the teeth along the pitch

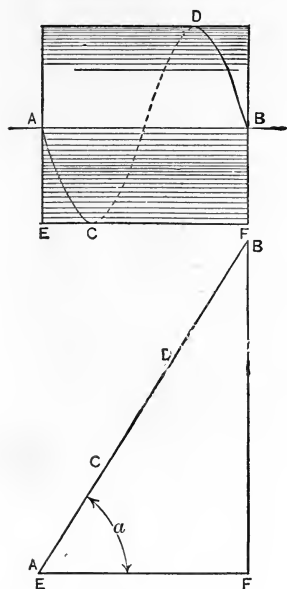

FIG. 622.

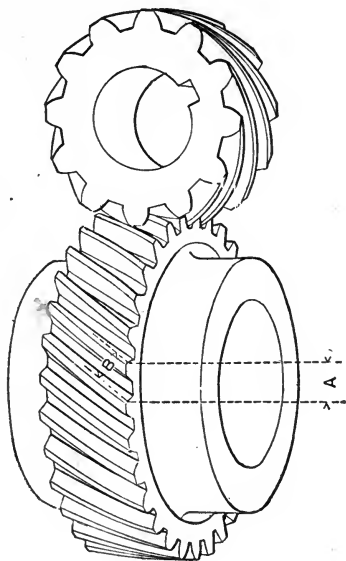

FIG. 623.

surfaces, it being greatest when the axes are at 90 degrees with each other.

In practice the teeth of twisted gears are formed to a true spiral, all such gears being technically known as spiral gears.

The pitch of a spiral is the distance it advances in one revolution and corresponds to the pitch or lead of a screw thread. It is a true helical curve, which, when developed on a plane, becomes a straight line, as shown in Fig. 622 at A C D B, where E F = the pitch and F B the circumference of the cylinder on which the spiral is wound. a = the angle of the spiral with the axis and is

termed the spiral angle. The spiral angle for equal pitches varies with the diameter of the cylinder on which the curve is drawn. The smaller the cylinder the less the angle. With a cylinder of infinite diameter the angle becomes 90 degrees, and the curve a straight line, which gives in practice the rack tooth.

The pitch surface of a spiral gear is cylindrical, and all pitch calculations are based on this surface.

The normal helix is a spiral curve on the pitch surface crossing the teeth at right angles. Upon this curve the normal circular pitch B, Fig. 623, is measured. A is the circular pitch. The addendum and tooth outline are determined from the normal pitch B, not from the circular pitch A, as in spur gearing, as in that case a cutter of thickness equal to one-half A at pitch line would remove too much stock, making the tooth too thin. By using the normal pitch, however, we are enabled ordinarily to cut spiral gears with regular gear cutters.

The teeth of spiral gears may be either right or left hand spirals, the distinction between right and left being the same as for screw threads. When the axes are parallel, as at C, Fig. 621, one gear must have right and the other left hand spirals, and the spiral angles must be equal in each gear. This angle is usually taken small, seldom exceeding 20 degrees. If too great an angle is taken, the end thrust on the bearings, due to the tendency of the teeth to slip on each other along the pitch line, will be excessive. The angle should be great enough to insure at least two pairs of teeth having contact points constantly passing the line of centers. The width of faces will determine largely the angle to use in any case, wider faces and smaller angles going together.

Since in spiral gears on parallel axes the spiral angles must be equal, the pitch of spiral will be equal in both gears only when they are of the same diameter. If, for example, one gear has three times the pitch diameter of the other, in order to have the same spiral angle its spiral pitch must be three times as great.

With the axes at right angles both gears will have either right or left hand spirals.

Consider a pair of spiral gears on parallel axes A and B, at C, Fig. 621, with spiral angles of 45 degrees. Gear A has a right hand spiral and B a left hand. Gradually swing the axis of A away from that of B. Assuming that the spiral angle of A changes, it will gradually decrease until it becomes zero degrees and we have a spur gear when the axis of A is at 45 degrees from the

axis of B. Continuing to swing A, the spiral angle changes from right to left hand, and at 90 degrees it becomes the same as B. If any other spiral angle, as 20 degrees, had been taken, A would have become a spur gear when its axis had passed through an angle equal to the spiral angle or 20 degrees, and beyond that position the spiral would be left handed, increasing to 70 degrees at the 90-degree axis position. From this the following rules are deduced: First—When the gears both have right or left hand spirals the sum of the spiral angles equals the angle between axes; second—When the gears are right and left handed, the difference of the spiral angles equals the angle between axes.

The velocity ratio of spiral gears cannot be determined by direct comparison of pitch diameters, as in spur gearing, but must be found from the angles of the spiral in each gear. Thus if the spiral angles of two gears are the same, the velocity ratio will be inversely as the pitch diameters, but if the spiral angles are not equal, the number of teeth per inch of pitch diameter will vary and the above ratio will not hold.

This is well illustrated in a worm and worm wheel, where, if the worm has a single thread, it is really a spiral gear having a single tooth, and the velocity ratio will be the number of teeth in the gear. If the worm has two, three or more teeth, the spiral angle will be different in each case and the velocity ratio equal to the number of teeth in the gear divided by the number of teeth in the worm. Increasing or decreasing the pitch diameter of the worm will change the spiral angle of the teeth in gear and worm, but will not affect the velocity ratio. In any case the velocity ratio will depend upon the number of teeth and their spiral angle, as expressed in the following proportion: v , the velocity of the small gear, is to V , the velocity of the large gear, as D , the pitch diameter of the larger, times the cosine of its spiral angle is to d , the pitch diameter of the smaller, times the cosine of its spiral angle.

With the axes at any angle the teeth slide upon each other, this action being the greatest when the axes are at right angles with each other. As this sliding contact produces friction between the teeth and excessive end thrust along the axes, spiral gears with axes other than parallel or nearly so are not suitable for transmitting heavy powers at high velocities, as the wear is excessive and the frictional losses make the efficiency low. When the axes are at right angles as in the spiral worm gear and worm, the conditions are the most unfavorable for the economic trans-

mission of power, the efficiency frequently falling below 50 per cent.

In all spiral gearing an end thrust along the axes is produced by the oblique action of the teeth. This effect may be neutralized by placing gears of opposite spirals on the same shaft, as shown in Fig. 624 at A.

Before laying out spiral gearing the designer will do well to consult the shop facilities for cutting them, since their special character will usually enable him to adapt them to the cutters in stock, and only in unusual cases will he find it necessary to use any other than standard cutters.

It will usually be found satisfactory to determine tooth and

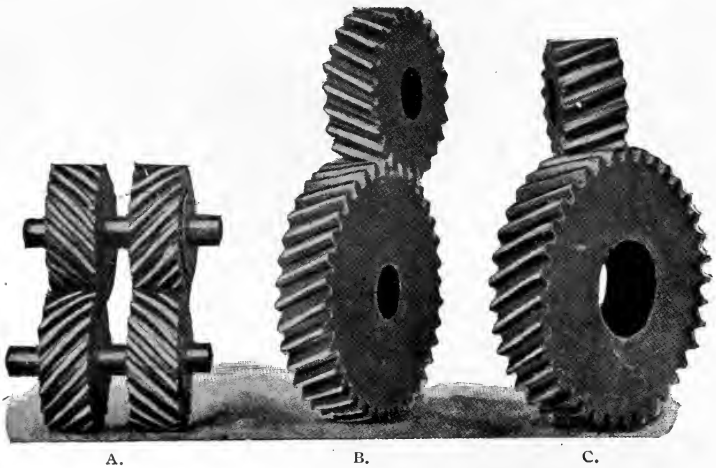

FIG. 624.

rim proportions from the rules for spur gearing. If the gears are of large diameter, the arms must be made sufficiently heavy to resist the pressure in the direction of the axis due to the oblique action at the teeth. As the pressure between teeth is confined to a very small surface, the strain on the tooth is more severe than in the spur gearing, and the consequent wear due to friction much greater.

In considering spiral gearing the following constitutes the most important data: First—The position of the axes, whether parallel or at an angle with each other; second—the distance between centers, whether at a fixed distance, or allowing a small

variation in the distance; third—the velocity ratio; and fourth—the power to be transmitted.

When the distance between centers is fixed, it will often be found difficult to obtain correct velocity ratios, as the normal circular pitch will usually give a fractional diametral pitch which would, unless approximately close to some standard pitch, require a special cutter. When the distance between centers can be varied, as is usually the case, the proper numbers of teeth, with their spiral angles, to give the desired velocity ratio, may be selected, and the correct normal circular pitch to suit a standard cutter assumed. The circular pitch then equals the normal circular pitch divided by the cosine of the spiral angle. The circular pitch times the number of teeth equals the pitch circumference of the blank from which the pitch diameter of the blank may be found. The whole diameter will equal, as in spur gearing, the pitch diameter plus two times the addendum. The addendum equals

1 inch

—————
Diametral pitch

The involute form of tooth is the one generally used.

In the pair of gears shown at C in Fig. 621, the distance between centers is fixed at 2 inches and the velocity ratio is one; the pitch diameters are 2 inches, and since the axes are parallel the spiral angles and numbers of teeth must be equal in each gear. In the gear shown the spiral angle is 45 degrees and the diametral pitch 10, giving 20 teeth in each gear. Pitch circum-

$$\begin{aligned} \text{ference} &= 2\pi = 6.2832 \text{ inches}; \text{ circular pitch} = \frac{6.2832 \text{ inches}}{20} \\ &= .3141 \text{ inch}; \text{ normal circular pitch} = .3141 \text{ inch} \cos 45 \text{ degrees} \\ &= .2213; \text{ normal diametral pitch} = \frac{3.1416}{.2213} = 14.15 = 14 \text{ approx-} \\ &\text{imately.} \end{aligned}$$

$$\text{Whole diameter} = 2 \text{ inches} + \frac{2}{14} = 2 \frac{1}{7} \text{ inches.}$$

By increasing the pitch diameter slightly a 14-P. cutter would be correct, but since from data that is not permissible it will be

necessary to use a cutter having the fractional pitch 14.15, or cut the teeth slightly shallower than exactness would demand, using a 14-P. cutter. The latter method would ordinarily be followed.

Having determined the pitch of the cutter, the next step is to find the shape of cutter to use, as indicated by the numbers. This may be obtained from the expression used by the Brown & Sharpe Manufacturing Company, where T, the number of teeth stamped on cutter, = N, the number of teeth in gear, \div by the

cosine² of the spiral angle. In the present case $T = \frac{20}{.5} = 40$, which requires cutter No. 3.

The pitch of the spiral must be next determined. In any case it will equal, from Fig. 622, the pitch circumference \div by the

tangent of the spiral angle, = in above case $\frac{6.2832 \text{ inches}}{1} = 6.28$ inches.

PROBLEM 2.—AXES PARALLEL, VELOCITY RATIO $1\frac{1}{2}$.

In Fig. 624 at B is shown a pair of spiral gears on parallel axes, in which the velocity ratio is one and one-half. From considerations for strength these gears should have teeth cut with a 10-P. cutter. Assume:

Spiral angle, 25 degrees.

Number of teeth in pinion, 24.

Number of teeth in gear, 36.

Normal circular pitch, .314.

Normal diametral pitch, .10.

$$\text{Circular pitch} = \frac{.314}{\cos 25 \text{ degrees}} = .335.$$

For the Pinion.

$$\text{Pitch circumference} = .335 \times 24 = 8.04.$$

$$\text{Pitch diameter} = \frac{8.04}{3.1416} = 2.56 \text{ inches.}$$

$$\text{Whole diameter} = 2.56 + \frac{2 \text{ inches}}{10} = 2.76 \text{ inches}$$

$$\text{Number of cutter} = \frac{24}{\cos^2 25 \text{ degrees}} = 29, \text{ giving cutter}$$

No. 4.

$$\text{Pitch of spiral} = \frac{8.04}{\tan 25 \text{ degrees}} = 17.25 \text{ inches.}$$

For the Gear.

$$\text{Pitch circumference} = .335 \text{ inch} \times 36 = 12.06 \text{ inches.}$$

$$\text{Pitch diameter} = \frac{12.06 \text{ inches}}{3.1416} = 3.83 \text{ inches.}$$

$$\text{Whole diameter} = 3.83 \text{ inches} + \frac{2}{10} = 4.03 \text{ inches.}$$

$$\text{Number of cutter} = \frac{36}{\cos^2 25 \text{ degrees}} = 44, \text{ giving cutter}$$

No. 3.

$$\text{Pitch of spiral} = \frac{12.06}{\tan 25 \text{ degrees}} = 25.88 \text{ inches.}$$

The spiral of one should be right-handed, of the other left-handed. The distance between centers equals one-half the sum of the pitch diameter, = 3.185. This distance may be changed by increasing or decreasing the number of teeth; of course the change in the number must be such as not to affect the velocity ratio.

PROBLEM 3.—AXES AT RIGHT ANGLES.

Consider next the case of spiral gears with axes at right angles, as shown in Fig. 623. In this case the velocity ratio will be pro-

portional to the pitch diameters only when the spiral angle is 45 degrees. In both gears assume the following case:

Velocity ratio, 1 to $2\frac{1}{2}$.

Normal diametral pitch, No. 8.

Number of teeth in gear, 30.

Number of teeth in pinion, 12.

Spiral angle of teeth in gear, 30 degrees.

To determine the following:

For the Gear.

Normal circular pitch = .393 inch.

$$\text{Circular pitch} = \frac{.393 \text{ inch}}{\cos 30 \text{ degrees}} = .4385 \text{ inch.}$$

Pitch circumference = $.4385 \times 30 = 13.155$.

$$\text{Pitch diameter} = \frac{13.155}{3.1416} = 4.18 \text{ inches.}$$

$$\text{Whole diameter} = 4.18 \text{ inches} + \frac{2 \text{ inches}}{8} = 4.43 \text{ inches.}$$

$$\text{Number of cutter} = \frac{30}{\cos^2 30 \text{ degrees}} = 40, \text{ giving cutter}$$

No. 3.

$$\text{Pitch of spiral} = \frac{13.155 \text{ inches}}{\tan 30 \text{ degrees}} = 22.8 \text{ inches.}$$

For the Pinion.

Spiral angle of teeth in pinion = 90 degrees — 30 degrees = 60 degrees.

Normal circular pitch = .393 inch.

$$\text{Circular pitch} = \frac{.393 \text{ inch}}{\cos 60 \text{ degrees}} = .786 \text{ inch.}$$

$$\text{Pitch circumference} = .786 \text{ inch} \times 12 = 9.432 \text{ inches.}$$

$$\text{Pitch diameter} = \frac{9.432}{3.1416} = 3 \text{ inches}$$

$$\text{Whole diameter} = 3 \text{ inches} + \frac{2 \text{ inches}}{8} = 3.25 \text{ inches.}$$

$$\text{Number of cutter} = \frac{12}{\cos^2 60 \text{ degrees}} = 30, \text{ giving cutter}$$

No. 4.

$$\text{Pitch of spiral} = \frac{9.432}{\tan 60 \text{ degrees}} = 5.44 \text{ inches.}$$

$$\text{Distance between centers} = \frac{4.18 + 3}{2} = 3.59 \text{ inches.}$$

On account of the great obliquity of the teeth the pinion should be the driver, and in general the gear having the larger spiral angle should be the driver.

PROBLEM 4.—AXES OBLIQUE.

Taking up next the case where the axes are neither parallel nor at right angles.

Assume the following data :

Velocity ratio, 1. to $2\frac{1}{4}$.

Normal diametral pitch, 10.

Number of teeth in pinion, 16.

Number of teeth in gear, 36.

Angle between axes, 50 degrees.

If the end thrust is to be equally divided between the bearings of the two gears, then the spiral angle of each gear should be one-half the angle between axes, or for the above problem 25 degrees; and both gears will have right or left-hand spirals. If, however, the minimum amount of sliding between teeth is

desired, then the graphical method given by MacCord may be used. It may be stated thus: The angle between the axis of each gear and the diagonal of the parallelogram having for adjacent sides lines in the axis and corresponding in length to the velocity of each gear. Fig. 625 gives the approximate spiral

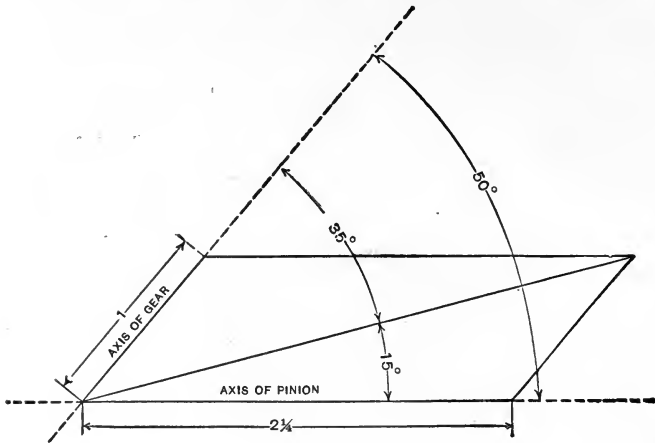

FIG. 625.

angles. In the present case the resulting angles are 15 degrees for the pinion and 35 degrees for the gear.

The Brown & Sharpe Company's practice is to take a mean between the angles given by these two methods, which gives for the above 20 degrees for the pinion and 30 degrees for the gear. On this basis the determinations are as follows:

For the Gear.

Spiral angle = 30 degrees.

Normal circular pitch = .314 inch.

$$\text{Circular pitch} = \frac{.314 \text{ inch}}{\cos 30 \text{ degrees}} = .362 \text{ inch.}$$

Pitch circumference = .362 inch \times 36 = 13.032 inches.

$$\text{Pitch diameter} = \frac{13.032 \text{ inches}}{3.1416} = 4.18 \text{ inches.}$$

$$\text{Whole diameter} = 4.18 \text{ inches} + \frac{2 \text{ inches}}{10} = 4.38 \text{ inches.}$$

$$\text{Number of cutter} = \frac{36}{\cos^2 30 \text{ degrees}} = 48, \text{ giving cutter}$$

No. 3.

$$\text{Pitch of spiral} = \frac{13.032 \text{ inches}}{\tan 30 \text{ degrees}} = 22.58 \text{ inches.}$$

For the Pinion.

$$\text{Spiral angle} = 20 \text{ degrees.}$$

$$\text{Normal circular pitch} = .314 \text{ inch.}$$

$$\text{Circular pitch} = \frac{.314 \text{ inch}}{\cos 20 \text{ degrees}} = .334 \text{ inch.}$$

$$\text{Pitch circumference} = .334 \text{ inch} \times 16 = 5.344 \text{ inches.}$$

$$\text{Pitch diameter} = \frac{5.344 \text{ inches}}{3.1416} = 1.7 \text{ inches.}$$

$$\text{Whole diameter} = 1.7 \text{ inches} + \frac{2 \text{ inches}}{10} = 1.9 \text{ inches.}$$

$$\text{Number of cutter} = \frac{16}{\cos^2 20 \text{ degrees}} = 14, \text{ giving cutter}$$

No. 7.

$$\text{Pitch of spiral} = \frac{5.344 \text{ inches}}{\tan 20 \text{ degrees}} = 14.6 \text{ inches.}$$

$$\text{Distance between centers} = 2.94 \text{ inches.}$$

A pair of gears cut according to this data is shown in Fig. 624 at C.

CHAPTER XXXII.

BELTING AND TRANSMISSION MACHINERY.

The transmission of power by belting is a subject of great importance and one that should receive more thought and study on the part of the machinist. A better knowledge of the characteristics of belting and the problems of belt gearing increases materially the respect of the average mechanic for a piece of good leather.

A belt is a flexible band passing over two or more pulleys for the purpose of transmitting motion from the one to the other. As its drive depends on its frictional resistance to slipping and as it is of a more or less elastic nature, it cannot be depended upon for the transmission of exact velocity ratios.

There are two general classes of belting, flat and round, the former being used on flat or crowned pulleys, the latter on grooved or sheave pulleys. The materials used in the manufacture of belting are leather and cotton for flat belts, and leather, cotton, and manila for the round belts. Rubber is extensively used on cotton belts for increasing the driving power and rendering them weather proof. Of the above materials leather is the most important and the one most used in manufacturing works.

Leather belting is made in various grades, and there is probably no other material, lubricating oils excepted, with which the manufacturer comes in contact that requires better judgment in its selection. The careful selecting of the hides, the proper tanning and currying, and above all the part of the hide used in the belt, together with care used in its manufacture, are the important points in the making of a good piece of leather belting.

In Fig. 626 is shown a cut illustrating the character of the leather used for belting. That portion included in the dotted lines I M P L is used for the various grades of belt, and is termed a "butt." That portion of the hide outside of the "butt" is soft and flabby, and although frequently used in cheap belts, is totally unfit for the purpose. The portion E F G H is known as the center stock and is that part used in the making of the better belts. Of the center stock the portion A B C D is the best, as it is the strongest and most uniform part of the hide. The portion

J M P K is known as shoulder stock and used for the lower grades of belting. What is known as strictly short lap, center stock belt, must be cut from the portion A B C D. As there is so small a piece of this grade of leather in each hide it goes without question that much of the so-called center stock comes from the parts E F B A and D C G H, with tendency to run into the portion J M P K. The shoulder stock is tough and heavy, but stretches in an irregular manner and should not be found in first-class belting. Shoulder stock is preferably cut crosswise of the hide, as it stretches into better shape when so cut.

All hides used for belting leather should be carefully tanned,

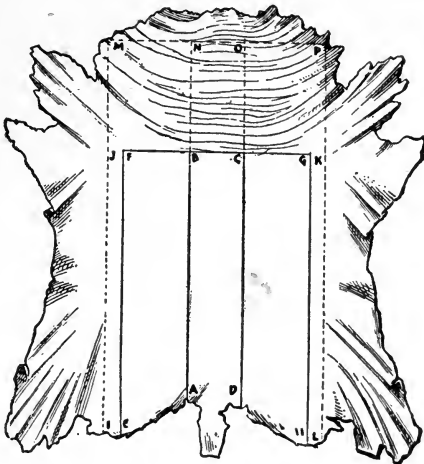

FIG. 626.

and afterwards curried or softened by "stuffing" with hot grease, a process which lubricates the fibers of the leather and converts the hard, dry hide, as left by tanning, into a strong, pliable leather. The hide is then thoroughly stretched and cut to required widths. As all strips other than the one having the center of the hide as its center will stretch more on the one edge than the other, it is desirable to take out most of this stretch before the belt is put into use. It is not, however, advisable to take out all of the stretch, as the belt is then rendered "dead," and lacks that elasticity so desirable in a good belt.

The leather is scarfed to uniform thickness and by careful working and polishing is brought into the smooth uniform condition commonly found in the commercial leather belting. The

weight of the belt is an important feature, a heavy belt being, as a rule, more desirable than a light one. Heavy single belts are cut from selected hides with a view to obtaining weight. Belts from lighter hides are frequently made heavy by excessive stuffing. This is not desirable. When belts are required heavier than the thickest hides will make, it is necessary to glue two or more thicknesses together, making "double," "triple," or "quadruple" ply belting. What is termed a "light double" belt is made of two thicknesses of thin hides, one side unusually being belly or shoulder stock. The weight of the "light double" belt is about one and one half the weight of single belt. Double belt is twice the weight of single; triple three times the weight, etc. In the making of double belts the strips should be so placed that edges of greatest stretch will come opposite so as to average up the stretch and make good running belts. The opportunity for fraud in the making of leather belting and especially in the heavy plies is great. Low prices usually mean light weight or poor quality, which is generally not discovered until the belt begins to go to pieces after short service.

Light and heavy double belts are used for transmitting heavier power than the single belt will satisfactorily stand. Usually for drive belts it is better to use a double belt than a single one of greater width. Light double belts are well adapted to use as shifting belts, where there is considerable wear on their edges, also for shifting belts on cones. A double belt should not be used on pulleys of too small diameters, as the short bend breaks the joint.

In a piece of belting leather the strongest section is on the flesh side. The hair side is relatively weak, hard, and liable to crack. For this reason the hair side of the belt should always be run next to the pulley, as it brings the fibers on the flesh side, which can best resist the strain, under tension as the belt passes over the pulley, and the hair side, which can least resist the strain, under compression. Belts run in this manner seldom crack, while on the other hand if run flesh side to the pulley transverse cracks are sure to show up on the hair side which gradually grow deeper and eventually ruin the belt. The hair side of the belt is the smoother, comes in better contact with the surface of the pulley and by actual test will transmit about 25 per cent more power, other conditions being equal, than when the flesh side is run next to the pulley.

The ultimate tensile strength of leather belting, depending on its quality, varies through a wide range. Most samples fall within the limits of 2,000 to 5,000 pounds per square inch, with 1,000 to 2,000 pounds at properly laced joints. Cotton belting has greater strength than leather, and when coated with rubber clings to the pulley more closely than leather. It is much better than leather for use in damp places or where subjected to material changes in temperature. Leather belting cannot be used in places where there is dampness, as it starts the glued joints and otherwise injures the belt. By a special waterproof treatment leather belting is made to stand a limited amount of dampness, but rubber-covered cotton will be found preferable under such conditions. Leather belting should not be used in temperatures higher than 110 degrees.

The power that can be transmitted by a belt varies, according to conditions, through very wide limits, consequently fixed rules cannot be laid down for the calculation of belt powers. As a pull of 33,000 pounds through a space of one foot in one minute represents one horse power of work, a pull of 33 pounds through a space of 1,000 feet in one minute would represent the same amount of work. By increasing the velocity or the tension, the work performed is correspondingly increased. The working strain on good leather belting may be taken at from 45 to 60 pounds per inch of width for single belts and at double that amount for double belts when the thickness is double that of the single belt. From the above, a heavy single belt running at 1,000 feet per minute will transmit 60-33 or 1.8 horse power, while a heavy double would transmit 3.6 horse power. At 4,000 feet per minute these same belts would transmit 7.2 and 14.4 horse power respectively, and if the widths were increased to 10 inches they would transmit 72 and 144 horse power respectively. The tables ordinarily used give powers somewhat under the above, a common rule being to allow one inch of width at 1,000 feet per minute for every horse power with single belts and one-half inch of width for double belts. This rule gives a most liberal margin, especially for single belts. Excessively tight belts should be avoided not only because of the injury to the belt but because of the excessive strains on shafting, boxes, and pulleys. Covering the face of the pulley with leather increases the adhesion of the belt from 30 to 40 per cent. A cover of this kind must be carefully put on, for best results, the leather from

which it is made being scarfed to uniform thickness and fitted closely over the pulley.

Whenever the character of the work permits, leather belts should be made endless by beveling the ends and making a glued lap joint. This makes a strong joint that runs smoothly over the pulleys, and is most important in the case of high speed belts operating on pulleys of small diameters. In double belts the joint should be lapped as shown in Fig. 627. It is not necessary to

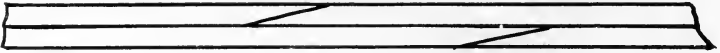

FIG. 627.

use rivets or other fasteners in connection with the glued lap joints. In fact, the best practice now dispenses with them entirely. In gluing the joint a special belt glue should be used and applied hot to both surfaces in order that it may penetrate well into the pores of the leather. The surfaces must be clamped firmly and squarely together and given sufficient time to dry well.

The lacing of belts is a matter of much importance and suf-

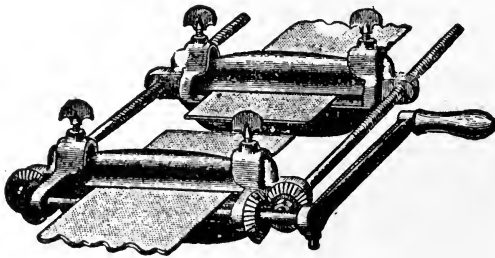

FIG. 628.

ficient care is not ordinarily exercised in this work. The time-honored method of lacing belts with thongs of rawhide has nearly given over to the better practice of using wire lacing, or a limited few of the many patented belt fasteners. The usual troubles with fasteners arise not from the fastener itself, but from its improper application. For any kind of fastener the belt must be cut square, a try square and not the eye being depended upon for this work. The ends must be held squarely together when the fastening is made.

Heavy belts should, for gluing or lacing, be drawn together by means of the belt clamps shown in Fig. 628 in place on the pulleys; as the edge of a wide, tight belt is invariably stretched when run onto the pulleys. On the side next to the pulley the lace leather, wire, or fastener should run parallel with the belt's length, and not cross each other, as in that case they make a rough

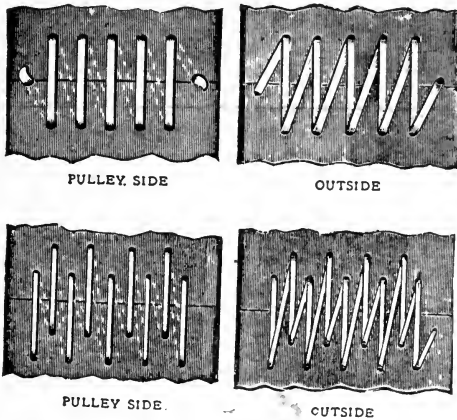

FIG. 629.

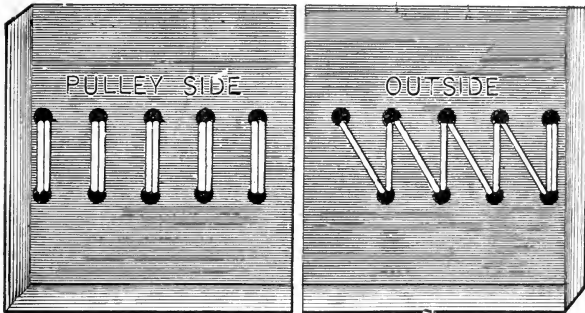

FIG. 630.

surface and wear off very quickly. The holes should be punched exactly opposite each other and should be the smallest possible that will let the lacing through. In the case of raw hide lacing, the usual mistake of using too few strands and too heavy a thong should be avoided. A satisfactory method is shown in Fig. 629. The strands on the inner side should be about 5-8 of an inch apart, and the staggering of the holes gives a firm hold on the ends of

the belt. It is best to lace from the edges to the center, tying off at the center.

In Fig. 630 is shown the method of lacing belts with wire lacing. The method is practically the same as with thongs. The wire used is of comparatively high tensile strength and very pliable. By cutting shallow grooves between the holes on the pulley side of the belt for the strands of wire to lie in a very smooth and durable joint is made by this means. The ends should be carefully tied off or otherwise there is danger of injuring the hand in shifting the belt.

Leather link belts, an example of which is shown in Fig. 631, are used to quite an extent for certain classes of work. They are built up of leather links hinged together by rods, as shown in the figure. They are very heavy, run smoothly, transmit heavy loads

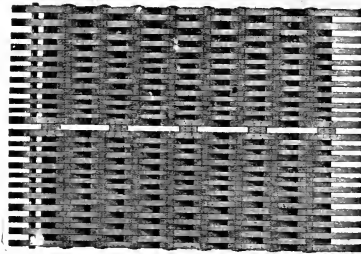

FIG. 631.

per inch of their width; will not come unglued from dampness, wear the pins faster than the leather and are very high in price.

The care of leather belting is a subject which receives too little attention. As above mentioned, avoid dampness and excessive heat, lace properly and run the proper side to the pulley. If the belt slips do not dope it with compounds of questionable quality, rosin, soap, etc., but tighten it. If it continues to slip after it has been made reasonably tight it is evident that it is too narrow. Put on a wider belt, or double the thickness of the troublesome one.

As the original "stuffing" or lubricant dries out, the belt loses its pliability, wears rapidly and cracks. Neat's-foot oil, tallow and a few of the prepared compounds are suitable for use on leather belts for softening, lubricating and preserving them. Mineral oils injure belts as they penetrate and drive out the original lubricants.

In the majority of cases belts are used to connect parallel shafts. When shafts rotate in the same direction, the connecting belt is called an "open" belt, and when they rotate in opposite directions it is called a "crossed" belt. The arc of contact is that portion of the pulley's surface covered by the belt. It is evident that the "arc of contact" is greater with the crossed than with the open belt, and that a crossed belt will, other conditions being equal, transmit more power than an open one. Wide crossed belts should be avoided in cases where the shafts are close together.

The adhesion of the belt to the pulley is dependent upon the condition of the belt and pulley surfaces, and the weight and tension of the belt. If the shafts are close together the weight of the belt is small and its tension must be greater in order to transmit a given power. When the shafts are reasonably far apart

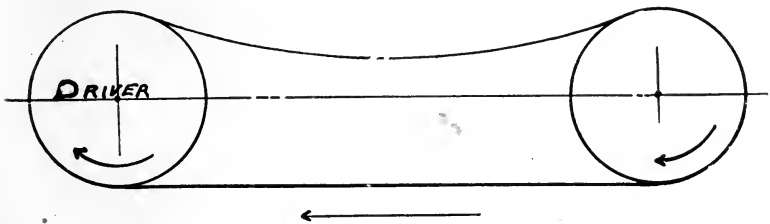

FIG. 632.

the weight of the belt adds much to its adhesion to the pulleys. For narrow belts 10 to 15 feet are good centers when the belts are operating over pulleys of comparatively small diameters. With wider belts operating over larger pulleys 20 to 25 feet should, if possible, be allowed, and for heavy drive belts 30 to 50 feet are usual. Too long a belt is liable to whip, especially in cases where the power transmitted is not perfectly steady. Whipping injures the belt and causes severe strains on the machinery.

When possible the lower side of the belt should be the tension or driving side, making the condition as shown in Fig. 632. If the top side is the driving side, the condition becomes as shown in Fig. 633. The arc of contact is much greater in the first case, and as a consequence a more powerful drive is obtained than in the latter case, all other conditions being equal.

When parallel shafts in a vertical plane are connected as shown in Fig. 634, the tension must be much greater than in the cases

above referred to, inasmuch as the weight of the belt tends to hold it away from the lower pulley. When the difference in diameter between the pulleys is great, a heavy belt on fairly long centers, run as shown in Fig. 635, should be used when possible.

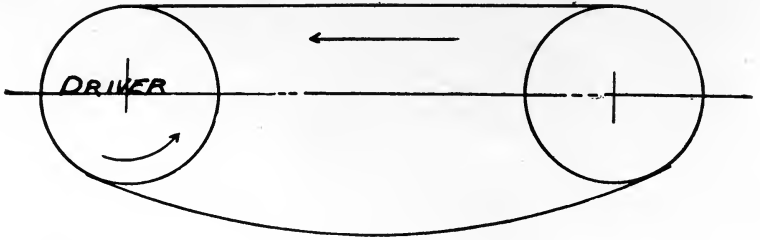

FIG. 633.

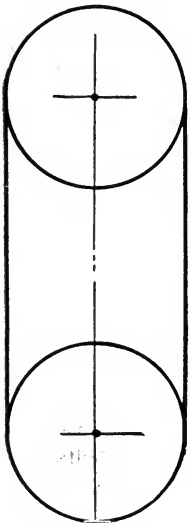

FIG. 634.

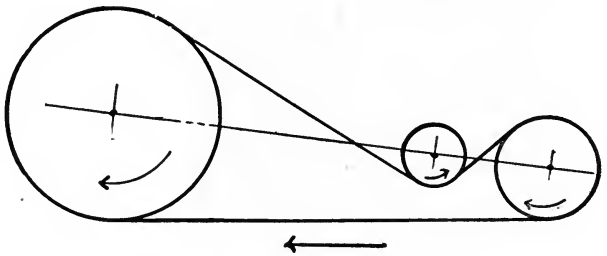

FIG. 636.

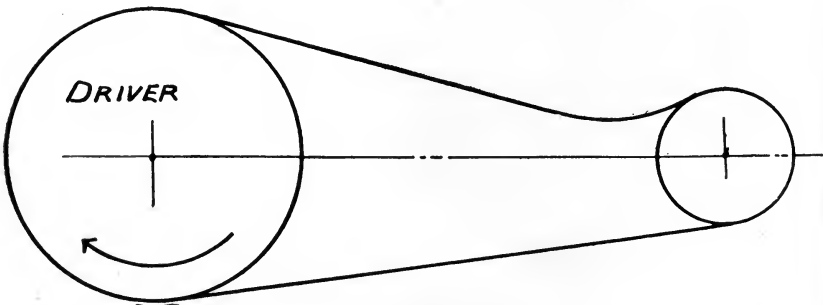

FIG. 635.

When the centers are close and a tightener becomes necessary it should always be put on the slack side of the belt as shown in Fig. 636. This location puts a minimum amount of pressure on the tightener and its bearings. Tightener pulleys should be of liberal diameter in order to prevent noise and wear due to high rotation and injury to the belt due to a short reverse bend.

In Fig. 637 is shown a method of driving two parallel shafts

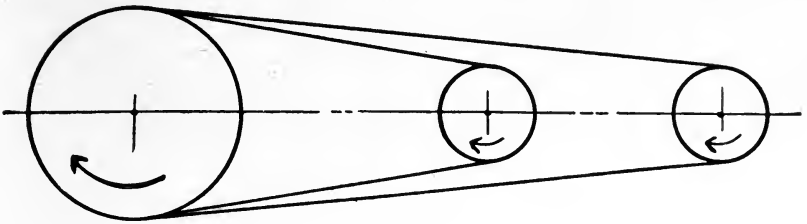

FIG. 637.

from a third parallel with them. One belt runs on top of the other on the driving pulley.

In Fig. 638 is shown what is generally known as a quarter turn belt, commonly used for connecting shafts at right angles with each other and in different planes. The location of the pulleys must be such that the belt leads from the face of one to the center of the face of the other. With this arrangement the direc-

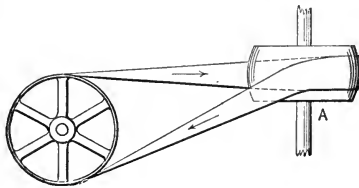

FIG. 638.

tion of rotation cannot be reversed. The pulleys should have liberally crowned faces and pulley A should have a face $1\frac{1}{2}$ times the width of the belt. The centers must be reasonably far apart to give good results.

When shafts are in the same plane and at an angle with each other they may be connected as shown in Fig. 639 by what is called a quarter-twist belt operating over mule pulleys. The pulleys should all be of the same size and well crowned. By having

the mule pulleys so mounted that their axes may be inclined from each other, the driving pulley may be made of a larger or smaller diameter than the driven.

When belts run on straight-faced pulleys it is necessary to guide them on the pulleys in some manner, as otherwise they are quite apt to run off, and especially so if the shafts are not exactly parallel with each other. In such cases a pair of fingers, between which the belt runs, is placed a short distance from the driven pulley on the side of the belt which leads onto the pulley. Flanges on the edges of the pulley are frequently employed. As the usual

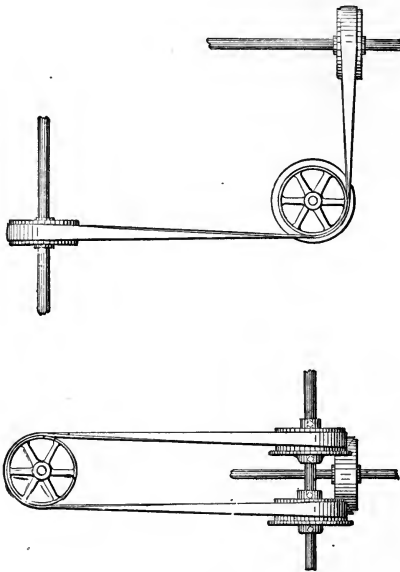

FIG. 639.

form of flange guides the belt after it makes its bearing on the face of the pulley, the destructive action of the flange on the edge of the belt is great, due to the resistance of the belt to a change in direction after it has come in contact with the pulley's face. This action is reduced somewhat by undercutting the face of the flange so that only its outer portion comes in contact with the edge of the belt, thus virtually forming a guide at some distance from where the belt comes in contact with the pulley's face.

When belts are not to be shifted the usual method of guiding is by crowning the face of the pulleys. The belt then tends to run

on the high part of the pulley for the following reasons: If, as shown in Fig. 640, the belt is forced to one side, the edge *a* becomes stretched, making that part of the belt in contact with the pulley's surface of conical shape, with the edge *a* traveling faster than the edge *b*, thus causing it to run in the direction of the arrow and to center itself on the pulley.

When the shafts are parallel a belt always runs to the high part of the pulley. If, however, the shafts are not parallel and the high side is caused by the position, and not the shape of the

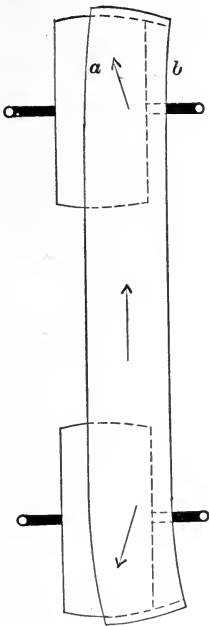

FIG. 640.

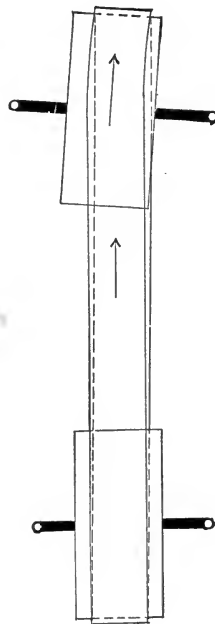

FIG. 641.

pulley, as shown in Fig. 641, the belt runs to the low edge, inasmuch as it passes onto the pulley in a spiral direction and all points when they first come in contact with the pulley's surface are carried in the direction of the pulley's rotation as indicated by the arrow.

When the distance between shafts becomes great, leather belting is no longer suitable for transmitting the power and connecting shafts or rope belting is substituted. The connecting shaft method is but little used and is well adapted only when the shafts

are in the same horizontal plane, the connection usually being made by two quarter-twist belts as shown in Fig. 639.

The use of rope transmission has nearly superseded the shaft method because of its higher efficiency and greater flexibility. It is difficult to conceive of any combination of shafting as to position, angles, etc., that cannot be successfully connected up by rope drives.

As wire rope transmissions are not frequently used in shop drives, only those cases pertaining to cotton and manila rope drives will be considered.

For the transmission of power, only the best of cotton and manila rope is suitable. Cotton rope because of its greater flexibility is better adapted for service on small diameter sheaves than manila rope. It is not as durable as the manila, has not the tensile strength, is harder to splice, and higher in first cost.

The manila rope used for transmission purposes should be of the best possible quality, manufactured from long fiber manila which has been carefully cleaned and selected. The smaller ropes are made of three strands, with four and six strands for the heavier ropes. The four and six strand ropes have a central core around which the strands are laid. The principal wear in transmission rope comes from the continuous rubbing of the fibers together. To overcome this has been the great study on the part of the transmission rope manufacturers. The free use of a lubricant, as plumbago and tallow, on the core and inner strands of the rope serves to soften and reduce the wear on the fiber.

The splicing of transmission rope is a most important operation and one upon which the success of the drive very largely depends. The splice is the weakest point in the rope, yet if properly made it will wear well and seldom gives trouble. It is quite necessary that the splice be a long one, and when finished of the same diameter as the balance of the rope. The ends must be so secured that they will not wear or cause their covering strands to wear off, thus freeing the ends enough to allow them to whip out as they pass over the sheaves. Old sailors do not know how to splice transmission rope, and should not be called upon for this service. A careful mechanic, following instructions, usually has no trouble in making a satisfactory splice. It is extremely difficult to splice a piece of new rope into an old one, as the stretch is out of the old rope, which causes it to pull away from the new. There is also considerable difference in diameters. In such cases

the new rope should, if possible, be thoroughly stretched before putting it in, and the old rope laid slack in the splice, an amount

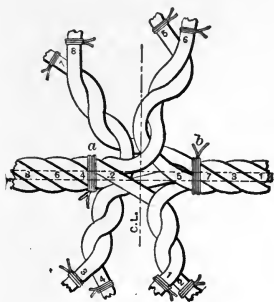

FIG. 642A.

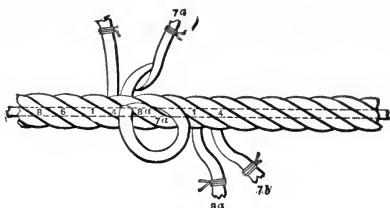

FIG. 642D.

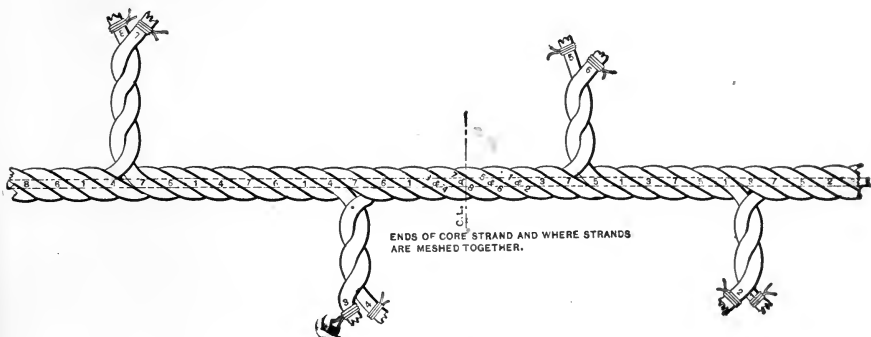

FIG. 642B.

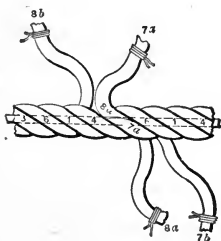

FIG. 642C.

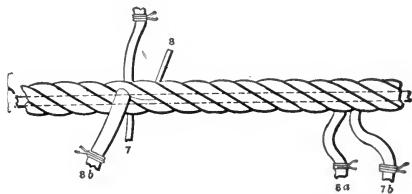

FIG. 642E.

wholly dependent upon the judgment of the workman, to allow for the stretch in the new rope.

The illustrations in Fig. 642 and the instructions following are

those furnished by the Link Belt Machinery Company for making standard rope splices.

TO SPLICE A FOUR-STRAND MANILA ROPE.

Tie pieces of twine a and b around the rope to be spliced one-half the length of the splice from the ends. (See table for length of splice.) Unlay the strands of each rope back to the twine. Butt or mesh the ropes together and twist corresponding pairs together to keep them from being tangled, as shown in A. Cut a. Unlay strand 8 and carefully lay strand 7 in its place for a distance equal to three-fourths its length. Strand 5 is next inlaid about one-quarter its length and strand 6 laid in its place. The ends of the cores are now cut off so they just meet. Unlay strand 1 three-quarters of its length, laying strand 2 in its place. Unlay strand 4 one-quarter of its length, laying strand 3 in its place.

Cut all the strands off to a length about 20 inches for convenience. The rope will now have the appearance shown in B. Each pair of strands is now subjected to the following operation. (See figure C.)

Split strands 7 and 8 in halves from the ends to the point of meeting at the body of the rope. The end of each half strand is now whipped with a small piece of twine. Take half strand 7a and corresponding half strand 8a and tie them in a single knot, drawing the knot down firm and taking care the yarns lie in so that the knot has the same appearance as the rest of the rope. We now pass on to D.

The rope is now opened by inserting a marlinspike between strands 8 and the other two strands at a point just beyond the knot. Half strand 8b is pulled out and half strand 7a pulled in, in place of half strand 8b; care being taken in pulling in half strand 7a to keep the rope smooth and firm, also to keep the yarns twisted the same amount as in the rest of the rope. Continue this operation until about one-quarter of half strand 7a is used. Then drop a yarn from each strand by pulling out of half strand 8b less one yarn and pulling in half strand 7a less one yarn, thus keeping the number of yarns in the strand the same and the rope the same size as at any point. Go on as before, dropping a yarn at every second opening until all of the yarns are dropped. The dropped yarns are laid over the strand being worked on and pulled under the adjacent strands respectively at the time they are dropped by opening the rope. They are then

cut off to about 2 inches long. Half strands 8a and 7b are treated in like manner, going in the opposite direction.

The ends of the yarns left sticking out will partly be drawn into the body of the rope and partly worn off in a short time, so that the locality of the splice can hardly be detected.

In the larger ropes from one inch up, two yarns may be dropped at a time when that stage of the splice has been reached, as it would make too long a splice to drop them one at a time.

Size of Rope.	Length of Splice.
$\frac{5}{8}$ inch	12 feet
$\frac{3}{4}$ "	13 "
$\frac{7}{8}$ "	14 "
1 "	14 "
$1\frac{1}{8}$ "	15 "
$1\frac{1}{4}$ "	16 "
$1\frac{3}{8}$ "	18 "
$1\frac{1}{2}$ "	18 "
$1\frac{3}{4}$ "	20 "

There are two systems of rope transmission in common use—the “multiple system” and the “continuous system.” The “multiple system” consists of independent ropes running side by side, while the “continuous system” consists of one rope wound around the pulleys several times. The “multiple system” is much used for transmitting heavy powers, and while not so adaptable to many special drives, possesses some important advantages over the “continuous system.” In the case of a rope failure it can be removed, the balance of the ropes carrying the load until the repair can be conveniently made. As idlers and tension pulleys are not ordinarily required, the rope is not subjected to a continuous reverse bending, thus making it more durable. In Fig. 643 is shown an example of the “multiple system” of rope driving.

In the “continuous system,” an example of which is shown in Fig. 644, a single rope is used, it being wrapped continuously about the drive and driven sheaves with a tension idler to take up the slack. The use of the tension carriage is necessary in order to take up the stretch in the rope and maintain a uniform tension in it. The position of the tension carriage should be such, that it takes care of the slack at the point where it naturally accumulates. In the example shown the last strand from the driver leads over

an idler sheave mounted at the side of the driven sheave. The tension is taken from this sheave back to the opposite groove on the driven by means of the tension sheave, the axis of which is sufficiently inclined to lead the rope properly.

The applications of the rope drive are many, and for the

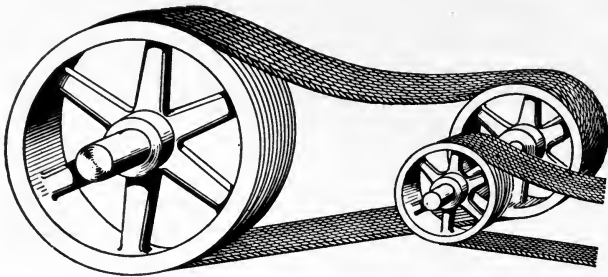

FIG. 643.

smooth, quiet transmission of power it has become a popular method. Perfect alignment of sheaves is not necessary, and shafts may be run at any angle with each other and at any distance within reasonable limits.

The sheave pulley is one in which deep grooves are cut in its rim to receive the wraps of the rope. They are made of cast iron

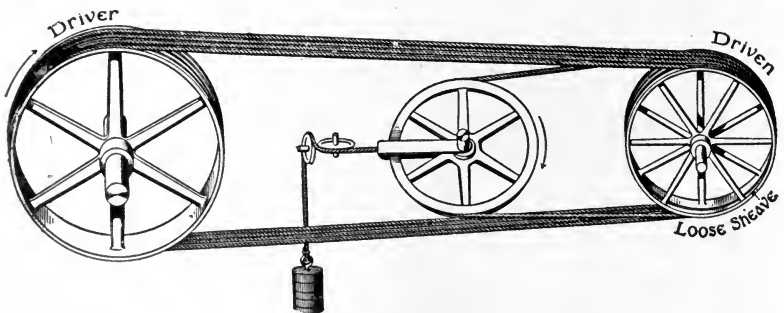

FIG. 644.

with the surfaces of the grooves very carefully polished, as any roughness wears the rope unduly. For driving and driven sheaves the accepted form of groove is the one shown in Fig. 645 at A. The angle of the sides of the groove at the pitch line *a a* is 45 degrees with each other. The sides are, however, slightly concave in section, which produces a rolling motion in the rope re-

sulting in a more uniform wear on the rope than when it runs without rolling.

The width of the groove at the pitch line is such that the rope bears on the sides, thus wedging in and causing a high frictional resistance to slipping. When used as an idler the bottom of the groove, as shown at B, is semicircular, the radius being equal to or slightly greater than the radius of the rope when new.

When the sheave has two or more grooves it is very important that they be of the same shape, size, and diameter in order to avoid any slipping or "creeping" of the rope. Sheaves smaller in diameter than 30 times the diameter of the rope should not be used with ropes under $1\frac{1}{4}$ inch. With ropes over $1\frac{1}{4}$ inch in

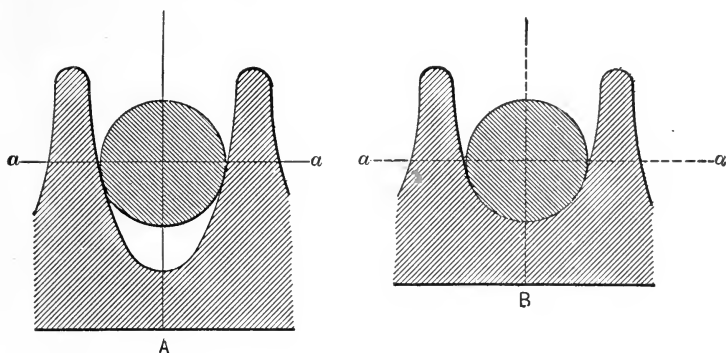

FIG. 645.

diameter the sheave should not be less in diameter than 40 times the rope diameter. The larger the sheave the less the bending of the rope and consequent wear upon it.

The usual speed at which ropes are operated is between 3,000 and 4,000 feet per minute. When the speed exceeds 4,000 feet, but little gain can be had in the power transmitted up to 5,000 feet, and above that speed the power transmitted, due to the excessive centrifugal action, falls off rapidly.

The table in Chapter XXXIV, compiled by C. W. Hunt, gives the horse power of "Stevedore" transmission rope at various speeds.

Shafting as universally used at the present time for power transmission purposes is of mild steel finished smooth, round and true, either by turning or by cold rolling. Turned steel shafting

runs in sizes 1-16 inch under the common sizes, as 1 15-16, 2 3-16, 2 7-16, etc., it having been finished from black stock of 2, 2¼ and 2½ inches diameter, respectively, by turning in a special shafting lathe. The final true surface on turned shafting is obtained by

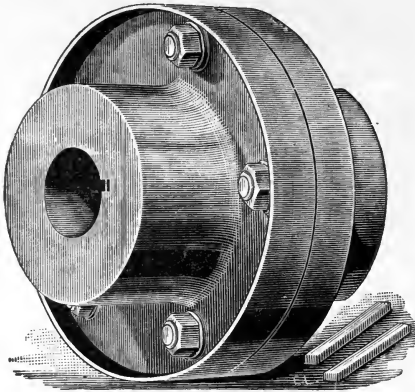

FIG. 646.

passing a hollow reamer or shafting burr over it, or by a final rolling process. Cold rolled shafting is given its final finish by a cold rolling process which leaves a true smooth surface and also intensifies and stiffens the material. When a number of lengths of shafting are to be connected together a suitable coupling must

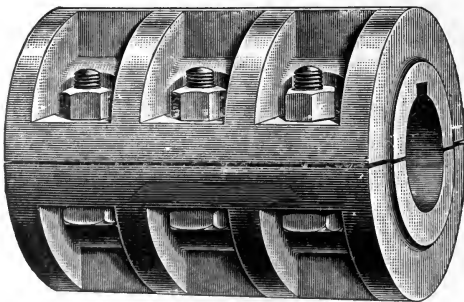

FIG. 647.

be employed. A flanged face coupling is shown in Fig. 646. These should be fitted to the ends of the shaft and the faces turned in place, thus insuring faces at right angles to the axis of the shaft and a true connection. Compression couplings are of numerous forms, many possessing good points. In Fig. 647 is shown a

simple and effective compression coupling. It consists of two semicircular shells fitted and bolted together. The shaft ends come together in the center and are held concentrically true. A key properly fitted makes a positive drive and a pin projecting a short way into the shaft at each end of the coupling prevents the shafts from pulling out of the coupling.

Shafting lengths should be so selected as to bring the couplings close to the bearings. For example, if bearings are eight feet apart

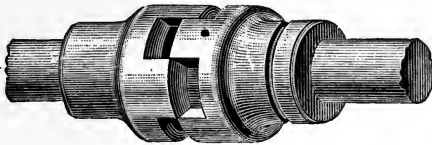

FIG. 648.

the shafting lengths should be 8, 16 or 24 feet. When it is frequently desirable to disconnect two lengths of shafting a dental coupling, Fig. 648, may be employed. The construction is evident. The end of one shaft should extend into the opposite coupling enough to hold the ends concentric. A bearing should be provided on each side of this form of coupling. They cannot be operated when the shafts are in motion.

The universal coupling, Fig. 649, is suitable for connecting

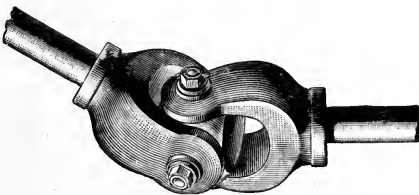

FIG. 649.

shafts which are at a small angle with each other. They will operate at an angle of 25 degrees, but are not well suited to the purpose when the angle exceeds 10 or 15 degrees.

Pulleys for power transmission purposes are of two classes, whole and split. The whole pulley is made in a single piece and must be put on its shaft from the end. The split pulley is made in halves and can be put on the shaft at any point in its length. Pulleys are constructed of wood, cast iron and wrought iron or

steel. The wood pulley is built up of small sections of hard wood, well glued and secured together, the whole being turned true. They are provided with bushings for any size of shaft and are secured to the shaft by a clamp hub. They are lighter than cast iron pulleys and are well adapted to high speed work. They are little used in machine shops.

Cast iron pulleys are, when of large diameter, made in sections because of the severe shrinkage strains in the castings. They should always be balanced, and when of extra wide face they should be provided with double sets of arms as shown in Fig. 650. The steel rimmed pulley shown in Fig. 651 is coming into quite

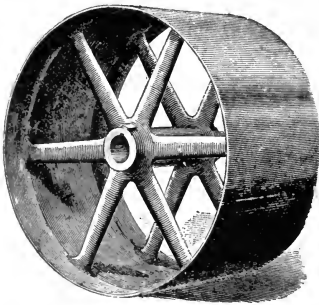

FIG. 650.

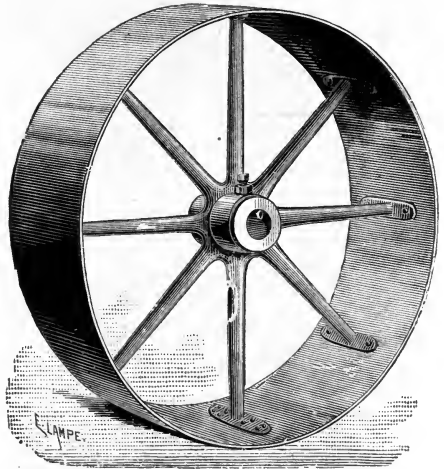

FIG. 651.

extensive use. It consists of a cast iron center or spider with a sheet steel rim riveted to the arms. It is a light, strong pulley, free from strains and well suited to all classes of work.

Pulleys are "tight" or "loose," depending on whether they are to be secured to the shaft or are to turn freely upon it. They are "straight" or "crowned," depending on whether they are to carry shifting or non-shifting belts. When used for very heavy service the rims are made extra heavy.

When it is necessary to frequently stop or start a pulley without stopping the shaft a clutch pulley is employed. In Fig. 652 is shown a cut of such a pulley. The clutch is keyed to the shaft and the pulley runs free upon the shaft when the clutch is dis-

engaged from it, as shown in the figure. By sliding the sleeve toward the hub of the clutch the toggle joint closes the jaws firmly onto the smooth rim attached to the pulley, thus locking the two firmly together. There are many forms of clutches, differing widely in design, made. One of the most important features of a good clutch pulley is a long bushing in the pulley with suitable provisions for its thorough lubrication.

Shafting must be carried in suitable bearings, which are mounted in what are known as hangers. A hanger is a frame,

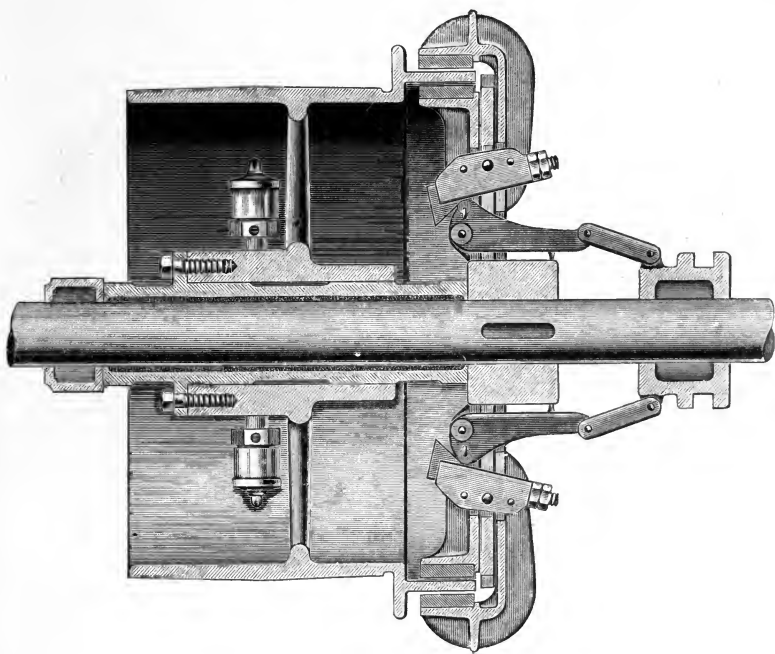

FIG. 652.

usually of cast iron, which carries the bearing and is suspended from the ceiling. The same frame when set on the floor becomes a floor stand, and when made to fasten to a post or the wall is called a post hanger. Wall boxes are made to set in the wall in cases where the shaft passes through the wall.

The most important feature of all hangers is the box or bearing. They should be lined with a good grade of bearing metal and preferably provided with some form of self-oiling device. In Fig. 653 is shown a self-oiling hanger bearing. The form is known

as a ring oiling bearing; the ring shown running on the shaft carries the oil from the reservoir to the bearing. Chains and wicks are used for this purpose in other forms.

The proper erecting of line shafting requires good care and judgment on the part of the workman. The perfect alignment of the shafting and proper setting of bearings means much as to the efficiency of the plant. Poorly lined shafting absorbs much power, causes undue wear and trouble with the boxes and incorrect running belts.

When properly lined it must not be assumed that the alignment

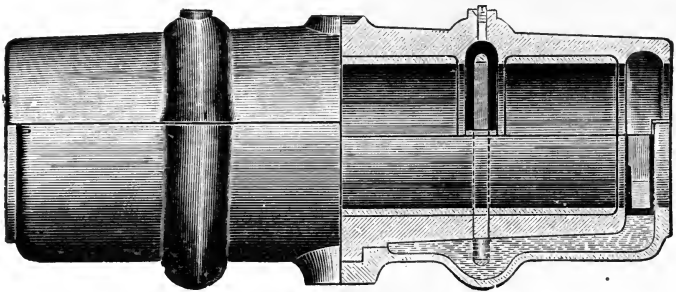

Sectional View.

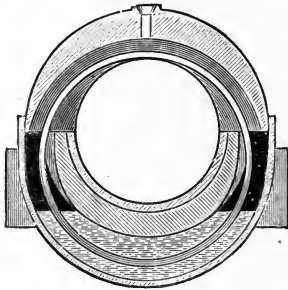

End View.

FIG. 653.

will always remain correct. The pull of belts; the spring of timbers due to changes in load put upon the floors; the warping of timbers due to atmospheric condition; the loosening of bolts and shimmings due to vibration, caused by poorly balanced pulleys, all tend to affect the alignment and make occasional surveys of the line shaft quite necessary.

The quickest and most satisfactory method of lining is by means of the surveyor's transit. If the two ends of the line are

determined, mark these points with copper tacks driven in the floor and bearing a center punch mark at the correct point. Set the transit over one of these points and line it to the corresponding point at the other end of the line and next establish as many points in the line on the floor as there are hangers. The points should be just outside the hanger bearings and the distance from point to point should be found by tape measurement. By dropping a plumb line over the side of the shaft at each point of its support and adjusting the hanger until the plumb centers over the marked tack in the floor the horizontal alignment is obtained. The vertical alignment is next obtained by taking level readings on a rod held vertically against the under side of the shaft, the hangers being adjusted until all readings are alike.

When the only apparatus to hand is a spirit level, a straight edge and plumb bobs, the following method may be employed. It

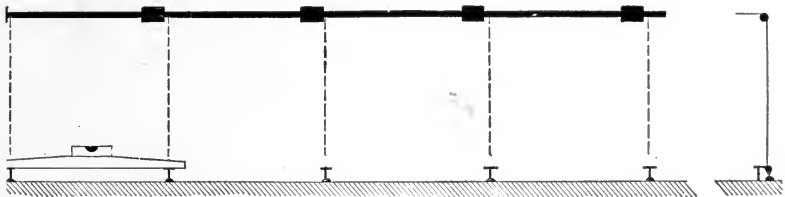

FIG. 654.

should, however, be noted that the ordinary level is quite unsuitable for this class of work. An accurate one must be used. The correct end points, having been determined on the floor as in the former case, stretch a strong fine line tightly over these points and just clearing the floor; establish the other points by this line, and plumb the shaft to the points so found for horizontal adjustment. For the vertical adjustment drive a small-headed nail a short distance in the floor by the side of the tack representing one of the end points. As the plumbing was from the side of the shaft and the floor points are consequently one-half the shaft diameter from the vertical line through the center of the shaft, the nail should be located from the point in the direction that will bring it in the vertical line referred to. Move to the next point and locate a nail as at the first point. Drive this nail in until an accurate straight edge resting on its head and the head of the first nail shows perfectly level with the second and continue for the entire number of points, thus giving a level line of nail heads

under the center of the shaft. Next adjust a tram to the exact distance between the top of the first nail head and the bottom of the shaft and adjust the shaft vertically at all other points to just touch the tram. It is usually advisable to tram the two ends of the shaft first, locating the hangers at the ends, so the shaft comes within the adjustment of the boxes. This method is illustrated in Fig. 654, and makes a simple and reliable method.

Another method, not so reliable as the above, is as follows: For the horizontal adjustment, drop a plumb line from the side of the shaft at each bearing, and standing at the end of the shaft direct the necessary adjustments to make all of the lines appear as one single line to the eye. For the vertical adjustment begin at one end of the line, place the level on the shaft and adjust the second bearing until the first section shows level. Move to the second section and adjust the third bearing until that section is level, and in like manner carry the level through the entire length

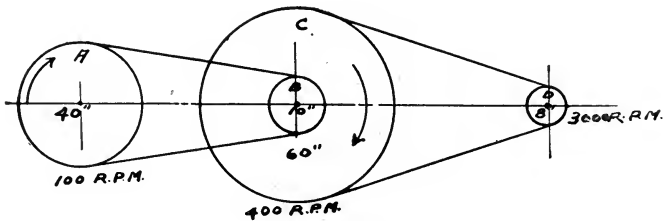

FIG. 655.

of the shaft. If in this method it is difficult to keep the plumbs from swaying, immerse each bob in a bucket of water, which will aid much in bringing them to rest.

When shafts are to be made parallel with each other it is usually better to establish points on the floor and work from these than to attempt to tram a measure in mid air. When shafts on different floors are to be made parallel the plumb line must be carried through a hole in the floor, being careful that the line does not touch the sides of the hole.

The above methods are applicable to most cases found in practice.

A jack shaft is usually a short shaft which receives the full power from the motor and distributes it to the other shafts.

Machine shop line shafts are usually speeded at from 125 to 150 revolutions per minute and wood shop lines at from 250 to

300. The comparatively low speed for machine shop lines is made necessary in order to use drive pulleys of fairly good diameter for the slow speed machine tool counter shafts.

It is always best when possible to apply power to a line shaft as near its center as possible. Heavy drive pulleys should be placed close to the hangers, and the belts should lead in opposite directions as much as possible, in order to balance up those strains which tend to throw the shaft out of alignment.

In calculating the speed of pulleys the following ratio may be employed.

$$\frac{\text{Diameter of driver} \quad \text{Revolutions of driven}}{\text{Diameter of driven} \quad \text{Revolutions of driver}}$$

Take for example Fig. 655. The pulleys A, B, C and D are respectively 40, 10, 60 and 8 inches in diameter, and the shafts make 100, 400 and 3,000 revolutions per minute. This constitutes a compound drive. Consider each drive separately. Assume A as the driver of the first pair and C the driver of the second pair, B and D are the driven. If A and its revolutions and the diameter of B are given to find the revolutions of B.

$$\frac{40}{10} = \frac{\text{Revolution of B}}{100}, \text{ revolution of B} = 100 \times \frac{40}{10} = 400$$

If D must make 3,000 revolutions and its diameter is assumed as 8 inches, then to find diameter of C we get

$$\frac{\text{Diameter C}}{8} = \frac{3000}{400}, \text{ diameter of C} = 8 \times \frac{3000}{400} = \frac{240}{4} = 60$$

In any case multiplying the diameter of one pulley by its revolutions and dividing the product by the diameter or revolutions of the other pulley will give the revolutions or diameter of the second pulley, as the case may be.

Tables giving horsepower and other tables pertaining to shafting and belting are given in Chapter XXXIV.

The electrical transmission of power is now being very largely employed, especially in cases where the distances are great. The convenience of the system has made it a very popular one. The

small power user can buy his power from the central power station; and the large plants, requiring power in widely separated buildings, can concentrate their engines and generators in one station and distribute the power to any required number of motors operating the various line shafts. It is usual to put a separate motor on each line and to hold the length of the line within reasonable limits. This makes possible the shutting down of any one line for repairs or other purposes without affecting the balance of the plant, a condition frequently of great value. The concentrating of the power into one plant and the employment of large units add much to the efficiency of operating over several small units scattered about the plant. The losses in generators, motors and line usually reduces the mechanical efficiency of the system to about 80 per cent. of the power developed by the engine. Belts, rope and shafting are more efficient for short transmission, but when the distances become great, the electrical transmission leads in points of efficiency, cost, safety and convenience.

The application of motors directly to machine tools is coming into quite extensive use. The advantages are chiefly in the doing away with the overhead work, thus leaving an unobstructed passage for the operating of cranes and carriers. It is also possible to set the machine in any position regardless of the direction of the line shaft.

The motors used for this class of work are either of the constant or variable speed class. With the constant speed motors the counter cone is driven by the motor, either directly or by belt, and the variations in spindle speeds are obtained in the usual manner. In the variable speed motor system, the motor drives the spindle directly, the changes in speed being accomplished by changing the speed of the motor.

CHAPTER XXXIII.

MISCELLANEOUS SHOP EQUIPMENT AND CONVENIENCES.

The use of compressed air in the shop for the driving of small motors, air hammers, drills, hoists, etc., is quite common. Its convenience and adaptability to these uses more than balance the losses incident to its compression. Any form of air-driven tool or motor is necessarily an extravagant one so far as cost per horse power developed is concerned.

Many of these motors could be operated by steam, but the heat would prevent them from being conveniently handled and the exhaust must be piped outside. With air, on the other hand, the tool or motor is kept cool and the exhaust discharges in the room.

One of the most important uses of compressed air is for hoisting work. In Fig. 656 is shown a pneumatic hoist. It consists of a cylinder, of diameter suitable for the loads it has to lift, in which a piston having a cup leather packing is fitted. The piston rod carries a hook at its lower end for receiving the connecting rope or chain from the load. The compressed air is piped to a suitable three-way cock which admits and releases it from under the piston, depending on which way the cock is turned.

In its action the air hoist is much quicker than the chain hoist. It lifts its load without shock or jar, and is generally considered as an economical method of lifting material. It is usually attached to a crane or some form of carrier, as it is in most cases necessary to pick up the load at one place and deposit it in another. If the distance carried is great, the hoist is uncoupled after the load is lifted, the air in the cylinder holding it up, providing the cock and rod gland do not leak. This avoids a very long connecting hose. The amount of air required to make a lift depends on the weight raised, the full tank pressure being required only in the case of a maximum lift. A considerable amount of waste usually occurs in the filling of that portion of the cylinder at the bottom which does not represent lift. Thus, if the piston lifts one foot before it begins to raise the load, that volume must be filled with air at the required pressure before any useful work is performed. It is, therefore, always best to couple as close to the work as possi-

ble and get the required height of lift in the lower portion of the piston's stroke.

Hoists of the class shown require considerable head room. When this is not available the cylinder may be placed in a horizontal position, as shown in Fig. 657. As shown, the lift is made on the push stroke, and the method of coupling gives a lift double the stroke of the piston. Short cylinders of large diameters suspended as shown in Fig. 656 and using a push stroke with a multiplying gear, are frequently used in places where head room is limited. They possess the advantage of not taking up so much room, laterally, as the form shown in Fig. 657.

Elevators are frequently operated by pneumatic hoists, either by direct or a multiplied lift.

Pneumatic hammers for chipping, riveting, and calking have come into very general use. With them a very great saving in labor is effected, as one hammer in the hands of a competent operator will perform the work of several men with hand tools.

In Fig. 658 is illustrated a pneumatic hammer suitable for medium heavy chipping and calking. A hose connects the hollow handle with the air supply and the valve which admits the air to the cylinder is controlled with the thumb. The cylinder contains the piston or hammer at the handle end, and the anvil which carries the chisel or other tool at the nose end. The pressure of the air is employed in giving the piston a rapid reciprocating motion, it striking with full force on the anvil at each forward stroke and cushioning against the air on its return stroke. These hammers are made in various sizes, suitable for all classes of work. The tool shown weighs 8 pounds and requires 25 cubic feet of free air per minute compressed to 80 pounds with which to operate it.

The pneumatic drilling machine shown in Fig. 659 is a portable tool much used for drilling and reaming on boiler, bridge and structural steel work. The machine shown is virtually a small, high speed, reciprocating engine. It has four single acting cylinders with nicely fitted trunk pistons, which are connected with a double throw crank, carrying at its lower end a pinion which meshes with a gear on the drill-carrying spindle. The tool shown weighs 30 pounds, requires 35 cubic feet of free air compressed to 80 pounds per minute to operate it and will drill successfully holes up to $2\frac{1}{2}$ inches in diameter. Various types of rotary engines are applied to this class of machines. They are not as economical in air consumption, however, as the piston types.

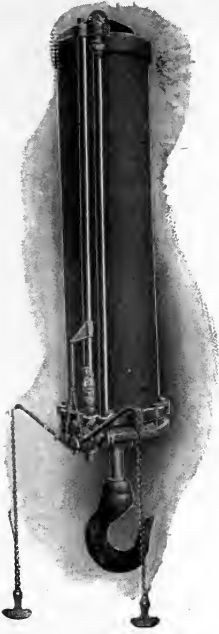

FIG. 656.

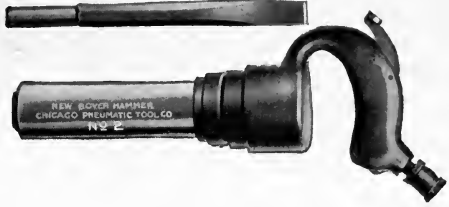

FIG. 658.

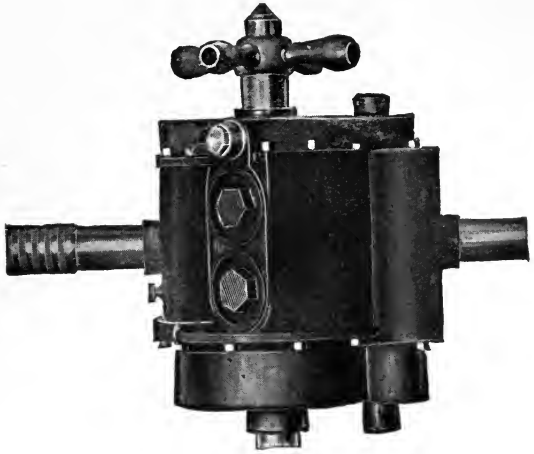

FIG. 659.

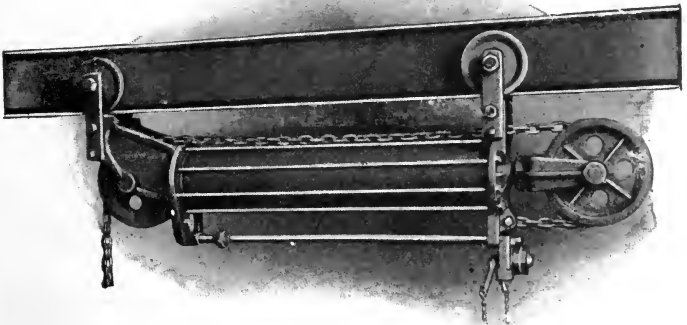

FIG. 657.

Hand hoists are much used in the handling of weights too heavy for one man to lift. They are comparatively slow and consequently not well adapted to regular work in places where pneumatic or power hoists can be used. They are more of the nature of a jobbing hoist, are compact, portable and may be worked in any desired position. The differential hoist shown in Fig. 660 is an exceedingly simple single chain hoist. The two upper sheaves are independent of each other, the one being slightly larger than the other. By pulling the chain over the larger sheave it takes up faster than the smaller sheave lets out, conse-



FIG. 660.



FIG. 661.

quently the hook goes up. One man can lift from 800 to 1,000 pounds with this style of hoist.

The geared hoist Fig. 661 is an example of the many hoists of this character that are made. It is a spur geared hoist with a suitable brake for holding the load. This form of hoist is more rapid than those using a worm and gear and is compact, requiring a minimum amount of head room. With the better hoists of this class one man can lift the rated load. With this class of hoist the higher the speed the less the weight that can be raised with a given effort.

Power hack sawing machines, an example of which is shown in Fig. 662, have come into very general use. These machines

use the regular pattern of hack saw blades, which with proper care will do a remarkable amount of cutting. They require little attention and when the blades are properly adjusted, will saw off work reasonably square. They are so constructed that when the blade drops through the work the machine stops. When the blade is new the weight holding it to the cut should not be too



FIG. 662.

heavy, as the cutting teeth are sharp and bite so freely that there is danger of stripping off the teeth or breaking the blade, especially if the work is of small diameter, thus permitting contact with but a few teeth at each point in the stroke. Tubing is very hard on blades and should be cut with light pressure and saws which are somewhat worn. Oil is not used on the hack saw blade.

In Fig. 663 is shown a "balancing way" used in the balancing

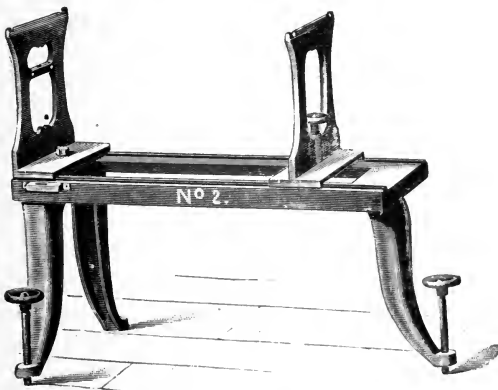

FIG. 663.

of rotating parts, as pulleys, spindles, etc., which from the nature of their work, must be put in perfect balance. The machine has a pair of smooth, hardened ways, parallel with each other, and so mounted that they may be accurately leveled. Spindles, or work carried on spindles, when placed on the ways will rotate and come to rest with the heavy side down. By removing weight from the heavy side or adding to the light side, the piece may be brought into perfect balance as indicated by its action on the "way."

For tempering, case-hardening, brazing, melting of babbitt, etc., a gas or gasoline forge is admirably adapted. They are cleaner and more convenient than coal or coke fires. With the gas

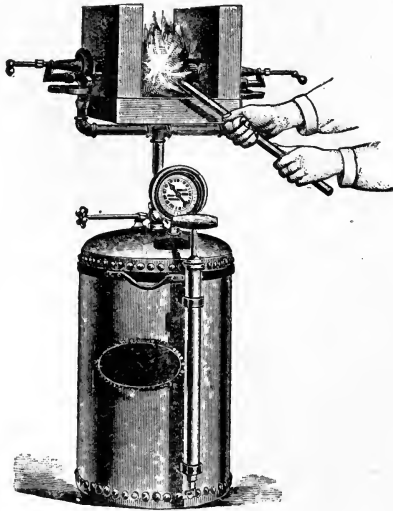

FIG. 664.

forge a supply of compressed air is necessary. With the gasoline forge, an example of which is shown in Fig. 664, an air pressure of from 20 to 60 pounds is maintained on top of the gasoline in the tank. Two or more burners are so placed that their blasts are concentrated at a common point, fire brick baffle plates retaining the heat.

The proper lubrication of high speed machinery requires a liberal supply of oil and consequently some means of catching this oil after it has performed its work. Self-oiling boxes should be frequently drained of old oil and supplied with fresh.

The oil which has been thus used is unfit to be used again, as it is full of impurities which have been washed from the bearings. This oil usually retains all of its lubricating properties and by passing it through a suitable filter the impurities are removed mechanically, thus cleansing, refining and making it suitable for use again.

The reclaiming of oil which cannot be drained from the chips which accumulate in the pans of screw machines, or other machines using oil on the cutting tools, is an important matter. This class of oil is high in price and can be used repeatedly if reclaimed. The only satisfactory method of doing this is by

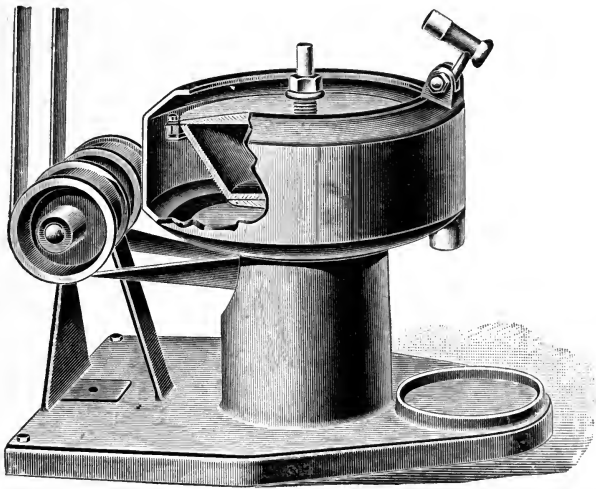

FIG. 665.

means of a centrifugal separator, an example of which is shown in Fig. 665. In this machine a strong inner drum mounted on a vertical spindle and capable of high rotation is filled with the oily chips. The outer casing which surrounds the drum serves to catch the oil which is thrown off from the chips by the centrifugal action. In this manner practically all of the oil is reclaimed.

The accumulation of oily waste about the shop is a constant source of danger and more especially in cases where there is the possibility of its receiving moisture, as spontaneous combustion

is very apt to occur. The only safe way to dispose of this material is to burn it at regular intervals. While accumulating it should be thrown in iron buckets of the character shown in Fig. 666. These buckets are made of galvanized iron and riveted together. They are provided with legs and a close fitting cover. In case the waste starts to burn it is so completely cut off from the air that the combustion is necessarily slow and may be detected by the smoke and odor.

The systematic keeping of stock and tools in the machine shop is a matter of very great importance and one requiring for each particular case a great deal of thought. Small tools, jigs and

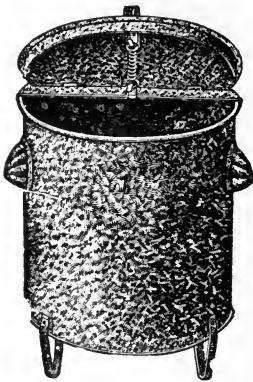

FIG. 666.

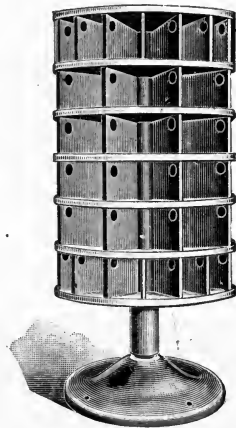

FIG. 667.

fixtures should be kept in a tool room under the charge of a competent tool room man who should be responsible for the giving out, receiving, inspecting and repairing of all tools and fixtures. The tools should be distributed on shelves, racks and in drawers in such a manner that each article has its particular place, thus enabling the tool man to select it upon call with the least possible loss of time. It is preferable to keep tools that are for general use about the shop in a place where they are exposed to view. Tools and fixtures of a special character may be kept in drawers properly tagged. In the case of jigs, it is desirable to keep them with the full assortment of tools, whether stock or special, that are required for the job, in separate drawers. The

operator then draws all that he requires for the work in a single lot and saves the time and chance for error incident to drawing the tools separately.

The stock room is an extremely important feature in any well organized shop. It should be well supplied with bins, shelves and racks for keeping the various supplies in a systematic manner, and it should be in charge of a systematic man.

The stock room should receive and give out all materials and supplies, keeping at all times an exact inventory of stock on hand.

In manufacturing shops all stock parts which go to make up the machine or articles manufactured are kept in the stock room. This gets them away from the machine as soon as completed, and puts them where a quantity record of them may be kept, and

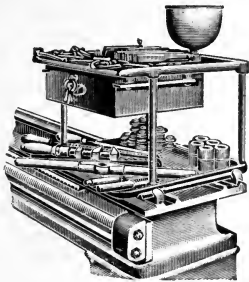

FIG. 668.

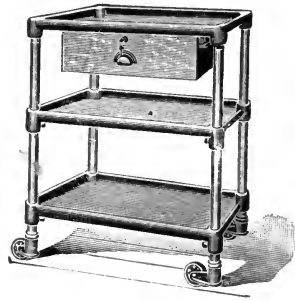

FIG. 669.

the least possible amount of time lost in getting them when required by the assembler.

For the keeping of small stock, as machine screws, cotters, taper pins, etc., revolving racks of the character shown in Fig. 667 are admirably adapted.

Tools and work racks at the machines are very convenient. In Fig. 668 is shown an excellent form of lathe rack which has two shelves for work and tools, with a drawer for the mechanic's finer tools. A similar rack of larger size mounted on castors for moving from machine to machine, is shown in Fig. 669. These are convenient for holding work that is to be operated upon by two or more machines, as they can readily be moved from one to another without the necessity of rehandling the work. Racks of this general character may be had of wood or metal and of forms suitable for any class of work.

The lathe pan shown in Fig. 670 is intended for use under the lathe, the upper tray catching the chips and the lower one for holding work. It can be readily rolled from under the machine for cleaning. It is of special value in cases where an oil or water cut is being run on the lathe, as it catches the lubricant

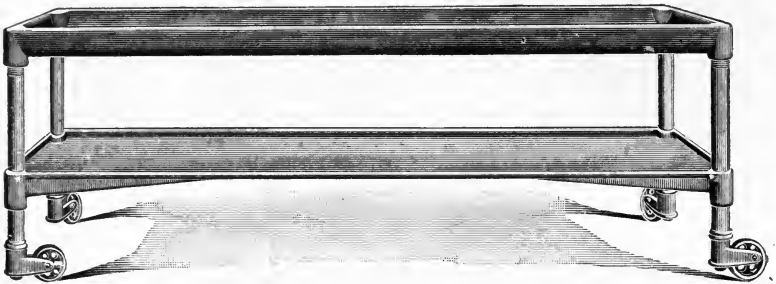

FIG. 670.

which can be drained off through a cock provided for that purpose.

In Fig. 671 is illustrated a form of pressed steel tote box or shop pan. They may be had in a large variety of shapes and sizes and are admirably adapted to the holding of small parts

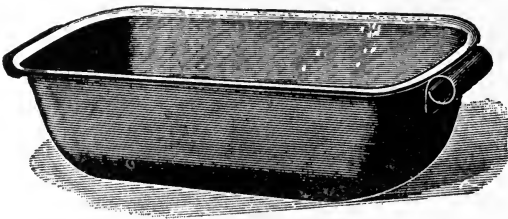

FIG. 671.

and supplies. Small hardwood boxes with suitable handles are also well suited to this purpose.

When an oil or water cut is occasionally desirable on work in the lathe, the simple device shown in Fig. 672 serves very nicely and is much more convenient than the makeshift methods so frequently employed.

Large cast iron plates planed smooth and true, and mounted on suitable legs, are very convenient for the laying off of work.

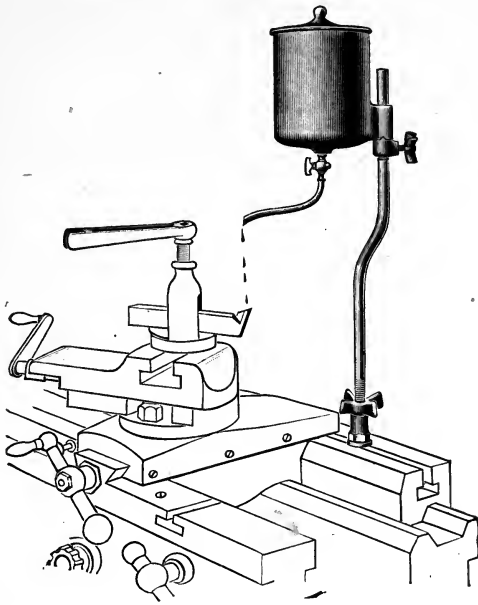

FIG. 672.

They should be kept for the purpose intended and not allowed to be used as shelves for other purposes.

CHAPTER XXXIV.

TABLES AND USEFUL DATA.

The tables and data contained in this chapter have been selected with the view of getting together, in convenient form, the tabulated information to which the mechanic most frequently wishes to refer.

TABLE OF DIMENSIONS OF KEYS AND KEY-WAYS.—BAKER BROS

Size of Hole.	Decimal Equivalent.	Preferred Width of Key-Way.	Nearest Size Cutter.	Preferred Thickness of Key.	Nearest Fractional Thickness.	Depth to be Cut in Hub for Straight Key.	Depth at Large End, for Taper Key.
1 in.	1.	.25	$\frac{1}{4}$.166	$\frac{3}{16}$.093	.112
$1\frac{1}{16}$	1.062	.265	$\frac{1}{4}$.177	$\frac{3}{16}$.093	.112
$1\frac{1}{8}$	1.125	.281	$\frac{1}{4}$.187	$\frac{3}{16}$.093	.112
$1\frac{1}{4}$	1.187	.293	$\frac{1}{4}$.198	$\frac{3}{16}$.109	.131
$1\frac{3}{8}$	1.25	.312	$\frac{1}{4}$.208	$\frac{3}{16}$.109	.131
$1\frac{1}{2}$	1.312	.328	$\frac{1}{4}$.219	$\frac{3}{16}$.109	.131
$1\frac{5}{8}$	1.375	.343	$\frac{1}{4}$.229	$\frac{3}{16}$.125	.15
$1\frac{3}{4}$	1.437	.359	$\frac{1}{4}$.239	$\frac{3}{16}$.125	.15
$1\frac{7}{8}$	1.5	.375	$\frac{1}{4}$.25	$\frac{3}{16}$.125	.15
$1\frac{9}{8}$	1.562	.39	$\frac{1}{4}$.26	$\frac{3}{16}$.125	.15
$1\frac{5}{4}$	1.625	.406	$\frac{1}{4}$.271	$\frac{3}{16}$.141	.168
$1\frac{11}{8}$	1.687	.421	$\frac{1}{4}$.281	$\frac{3}{16}$.141	.168
$1\frac{3}{4}$	1.75	.437	$\frac{1}{4}$.292	$\frac{3}{16}$.141	.168
$1\frac{7}{8}$	1.812	.453	$\frac{1}{4}$.302	$\frac{3}{16}$.141	.168
$1\frac{9}{8}$	1.875	.468	$\frac{1}{4}$.312	$\frac{3}{16}$.171	.206
$1\frac{5}{4}$	1.937	.484	$\frac{1}{4}$.323	$\frac{3}{16}$.171	.206
2	2.	.5	$\frac{1}{2}$.333	$\frac{3}{16}$.171	.206
$2\frac{1}{16}$	2.062	.515	$\frac{1}{2}$.344	$\frac{3}{16}$.171	.206
$2\frac{1}{8}$	2.125	.531	$\frac{1}{2}$.354	$\frac{3}{16}$.171	.206
$2\frac{1}{4}$	2.187	.547	$\frac{1}{2}$.364	$\frac{3}{16}$.171	.206
$2\frac{3}{8}$	2.25	.563	$\frac{1}{2}$.375	$\frac{3}{16}$.171	.206
$2\frac{1}{2}$	2.312	.578	$\frac{1}{2}$.385	$\frac{3}{16}$.171	.206
$2\frac{5}{8}$	2.375	.593	$\frac{1}{2}$.396	$\frac{3}{16}$.218	.262
$2\frac{3}{4}$	2.437	.609	$\frac{1}{2}$.406	$\frac{3}{16}$.218	.262
$2\frac{7}{8}$	2.5	.625	$\frac{1}{2}$.416	$\frac{3}{16}$.218	.262
$2\frac{9}{8}$	2.562	.641	$\frac{1}{2}$.427	$\frac{3}{16}$.218	.262
$2\frac{5}{4}$	2.625	.656	$\frac{1}{2}$.437	$\frac{3}{16}$.218	.262
$2\frac{11}{8}$	2.687	.672	$\frac{1}{2}$.448	$\frac{3}{16}$.218	.262
$2\frac{3}{4}$	2.75	.687	$\frac{1}{2}$.458	$\frac{3}{16}$.218	.262
$2\frac{7}{8}$	2.812	.703	$\frac{1}{2}$.469	$\frac{3}{16}$.218	.262
$2\frac{9}{8}$	2.875	.719	$\frac{1}{2}$.479	$\frac{3}{16}$.25	.3
$2\frac{5}{4}$	2.937	.734	$\frac{1}{2}$.49	$\frac{3}{16}$.25	.3
3	3.	.75	$\frac{3}{4}$.5	$\frac{3}{16}$.25	.3
$3\frac{1}{8}$	3.125	.781	$\frac{3}{4}$.521	$\frac{3}{16}$.25	.3
$3\frac{1}{4}$	3.187	.797	$\frac{3}{4}$.531	$\frac{3}{16}$.25	.3
$3\frac{3}{8}$	3.25	.812	$\frac{3}{4}$.542	$\frac{3}{16}$.25	.3
$3\frac{1}{2}$	3.375	.844	$\frac{3}{4}$.562	$\frac{3}{16}$.312	.375
$3\frac{5}{8}$	3.437	.859	$\frac{3}{4}$.573	$\frac{3}{16}$.312	.375
$3\frac{3}{4}$	3.5	.875	$\frac{3}{4}$.583	$\frac{3}{16}$.312	.375
$3\frac{7}{8}$	3.625	.906	$\frac{3}{4}$.604	$\frac{3}{16}$.312	.375
$3\frac{9}{8}$	3.687	.923	$\frac{3}{4}$.614	$\frac{3}{16}$.312	.375
$3\frac{5}{4}$	3.75	.937	$\frac{3}{4}$.625	$\frac{3}{16}$.312	.375
$3\frac{7}{8}$	3.875	.969	1	.646	$\frac{3}{16}$.343	.412
$3\frac{9}{8}$	3.937	.984	1	.656	$\frac{3}{16}$.343	.412
4	4.	1.	1	.666	$\frac{3}{16}$.343	.412

TABLE OF DECIMAL EQUIVALENTS OF 8THS, 16THS, 32DS AND 64THS OF AN INCH.

$\frac{1}{8}$.125	$\frac{1}{16}$.0625	$\frac{1}{32}$.03125	$\frac{1}{64}$.015625
$\frac{2}{8}$.25	$\frac{2}{16}$.125	$\frac{2}{32}$.0625	$\frac{2}{64}$.03125
$\frac{3}{8}$.375	$\frac{3}{16}$.1875	$\frac{3}{32}$.09375	$\frac{3}{64}$.046875
$\frac{4}{8}$.5	$\frac{4}{16}$.25	$\frac{4}{32}$.125	$\frac{4}{64}$.0625
$\frac{5}{8}$.625	$\frac{5}{16}$.3125	$\frac{5}{32}$.15625	$\frac{5}{64}$.078125
$\frac{6}{8}$.75	$\frac{6}{16}$.375	$\frac{6}{32}$.1875	$\frac{6}{64}$.09375
$\frac{7}{8}$.875	$\frac{7}{16}$.4375	$\frac{7}{32}$.21875	$\frac{7}{64}$.109375
1	1	1	1	1	1	1	1

DIFFERENT STANDARDS FOR WIRE GAUGE IN USE IN THE UNITED STATES.
Dimensions of sizes in Decimal Parts of an Inch

Number of Wire Gauge	American or Brown & Sharpe	Birmingham, or Stubs' Wire	Washburn & Moen Mfg. Co., Worcester, Mass.	Imperial Wire Gauge.	Stubs' Steel Wire	U. S. Stand. for Plate	Number of Wire Gauge
00000046446875	000000
000004324375	00000
0000	.46	.454	.3938	.40040625	0000
000	.40964	.425	.3625	.370375	000
00	.3648	.38	.3310	.34834375	00
0	.32486	.34	.3065	.3243125	0
1	.2893	.3	.2830	.300	.227	.28125	1
2	.25763	.284	.2625	.276	.219	.265625	2
3	.22942	.259	.2437	.252	.212	.25	3
4	.20431	.238	.2253	.232	.207	.234375	4
5	.18194	.22	.2070	.212	.204	.21875	5
6	.16202	.203	.1930	.192	.201	.203125	6
7	.14428	.18	.1770	.176	.199	.1875	7
8	.12849	.165	.1620	.160	.197	.171875	8
9	.11443	.148	.1483	.144	.194	.15625	9
10	.10189	.134	.1350	.128	.191	.140625	10
11	.090742	.12	.1215	.116	.188	.125	11
12	.080608	.109	.1055	.104	.185	.109375	12
13	.071961	.095	.0915	.092	.182	.09375	13
14	.064084	.083	.0800	.080	.180	.078125	14
15	.057068	.072	.0720	.072	.178	.0703125	15
16	.05082	.065	.0625	.064	.175	.0625	16
17	.045257	.058	.0540	.056	.172	.05625	17
18	.040303	.049	.0475	.048	.168	.05	18
19	.03589	.042	.0410	.040	.164	.04375	19
20	.031931	.035	.0348	.036	.161	.0375	20
21	.028462	.032	.03175	.032	.157	.034375	21
22	.025347	.028	.0286	.028	.155	.03125	22
23	.022571	.025	.0258	.024	.153	.028125	23
24	.0201	.022	.0230	.022	.151	.025	24
25	.0179	.02	.0204	.020	.148	.021875	25
26	.01594	.018	.0181	.018	.146	.01875	26
27	.014195	.016	.0173	.0164	.143	.0171875	27
28	.012641	.014	.0162	.0149	.139	.015625	28
29	.011257	.013	.0150	.0136	.134	.0140625	29
30	.010025	.012	.0140	.0124	.127	.0125	30
31	.008928	.01	.0132	.0116	.120	.0109375	31
32	.00795	.009	.0128	.0108	.115	.01015625	32
33	.00708	.008	.0115	.0100	.112	.009375	33
34	.006304	.007	.0104	.0092	.110	.00859375	34
35	.005614	.005	.0095	.0084	.108	.0078125	35
36	.005	.004	.0090	.0070	.106	.00703125	36
37	.0044530068	.103	.00640625	37
38	.0039650030	.101	.00625	38
39	.0035310052	.099	39
40	.0031440048	.097	40

CIRCUMFERENCE, AREAS, SQUARES, ETC., OF CIRCLES.

Advancing by 16ths, 8ths, and 4ths.—1 to 50.

Diameter or Number.	Circumference.	Area.	Square.	Cube.	Square Root.	Cube Root.	Diameter or Number.	Circumference.	Area.	Square.	Cube.	Square Root.	Cube Root.
1	3.14	.7854	1.	1.	1.	1.	7 1/4	22.78	41.28	52.56	381.08	2.692	1.935
1 1/16	3.34	.886	1.13	1.19	1.031	1.020	7 1/8	23.56	44.18	56.25	421.88	2.739	1.957
1 1/8	3.53	.994	1.27	1.42	1.060	1.040	7 3/8	24.35	47.17	60.06	465.48	2.784	1.979
1 1/4	3.73	1.107	1.41	1.67	1.089	1.059	7 1/2	25.13	50.26	64	512.	2.828	2.
1 1/2	3.93	1.227	1.56	1.93	1.118	1.077	8 1/4	25.92	53.46	68.06	561.52	2.872	2.021
1 3/8	4.12	1.353	1.72	2.26	1.146	1.095	8 1/8	26.70	56.75	72.15	614.12	2.915	2.041
1 3/4	4.32	1.485	1.89	2.60	1.173	1.112	8 3/8	27.49	60.13	76.56	669.92	2.958	2.061
1 7/8	4.52	1.623	2.07	2.97	1.199	1.129	9	28.27	63.62	81.	729.	3.	2.080
1 9/8	4.71	1.767	2.25	3.38	1.225	1.145	9 1/4	29.06	67.20	85.56	791.45	3.041	2.098
1 5/8	4.91	1.917	2.44	3.82	1.250	1.161	9 1/8	29.85	70.88	90.25	857.37	3.082	2.118
1 5/4	5.11	2.074	2.64	4.29	1.275	1.176	9 3/8	30.63	74.66	95.06	926.86	3.122	2.136
1 5/2	5.30	2.236	2.85	4.80	1.299	1.191	10	31.41	78.54	100	1000	3.162	2.154
1 11/8	5.50	2.405	3.06	5.36	1.323	1.205	11	34.55	95.03	121	1331	3.317	2.224
1 11/4	5.69	2.580	3.29	5.95	1.346	1.219	12	37.69	113.0	144	1728	3.464	2.289
1 11/2	5.89	2.761	3.52	6.59	1.369	1.233	13	40.84	132.7	169	2197	3.606	2.351
1 3/2	6.09	2.948	3.75	7.27	1.392	1.247	14	43.98	153.9	196	2744	3.742	2.410
2	6.28	3.142	4.	8.	1.414	1.260	15	47.12	176.7	225	3375	3.873	2.466
2 1/16	6.48	3.341	4.25	8.77	1.436	1.273	16	50.26	201.0	256	4096	4.	2.520
2 1/8	6.68	3.547	4.52	9.59	1.458	1.286	17	53.40	226.9	289	4913	4.123	2.571
2 1/4	6.87	3.758	4.78	10.47	1.479	1.298	18	56.54	254.4	324	5832	4.243	2.621
2 1/2	7.07	3.976	5.06	11.39	1.5	1.310	19	59.69	283.5	361	6859	4.359	2.668
2 3/8	7.26	4.200	5.35	12.36	1.521	1.322	20	62.83	314.1	400	8000	4.472	2.714
2 3/4	7.46	4.430	5.64	13.40	1.541	1.334	21	65.97	346.3	441	9261	4.583	2.759
2 5/8	7.66	4.666	5.94	14.48	1.561	1.346	22	69.11	380.1	484	10648	4.690	2.802
2 5/4	7.85	4.909	6.25	15.63	1.581	1.358	23	72.25	415.4	529	12167	4.796	2.844
2 7/8	8.05	5.157	6.57	16.83	1.600	1.369	24	75.39	452.3	576	13824	4.899	2.885
2 7/4	8.25	5.412	6.89	18.08	1.620	1.380	25	78.54	490.8	625	15625	5.	2.924
2 3/2	8.44	5.673	7.22	19.41	1.639	1.391	26	81.68	530.9	676	17576	5.099	2.963
2 11/8	8.64	5.940	7.56	20.79	1.658	1.402	27	84.82	572.5	729	19683	5.196	3.
2 11/4	8.84	6.213	7.91	22.25	1.677	1.412	28	87.96	615.7	784	21952	5.292	3.037
2 11/2	9.03	6.492	8.27	23.76	1.695	1.422	29	91.10	660.5	841	24389	5.385	3.072
2 5/2	9.23	6.777	8.63	25.34	1.714	1.432	30	94.24	706.8	900	27000	5.477	3.107
3	9.42	7.07	9	27.	1.732	1.442	31	97.59	754.8	961	29791	5.568	3.141
3 1/16	9.62	7.37	9.77	30.52	1.768	1.462	32	100.5	804.2	1024	32768	5.657	3.175
3 1/8	10.21	8.30	10.53	34.32	1.803	1.482	33	103.7	855.3	1089	35937	5.745	3.208
3 1/4	10.60	8.95	11.39	38.44	1.837	1.5	34	106.8	907.9	1156	39304	5.831	3.240
3 1/2	11.00	9.62	12.25	42.88	1.871	1.518	35	110.	962.1	1225	42875	5.916	3.271
3 3/8	11.39	10.32	13.14	47.63	1.904	1.535	36	113.1	1017.9	1296	46656	6.	3.302
3 3/4	11.78	11.05	14.06	52.73	1.936	1.553	37	116.2	1075.2	1369	50653	6.083	3.332
3 7/8	12.17	11.79	15.02	58.17	1.968	1.570	38	119.4	1134.1	1444	54872	6.164	3.362
4	12.57	12.57	16.	64.	2.	1.587	39	122.5	1194.6	1521	59319	6.245	3.391
4 1/4	13.35	14.19	18.06	76.78	2.081	1.619	40	125.7	1256.6	1600	64000	6.325	3.420
4 1/2	14.14	15.90	20.25	91.13	2.121	1.651	41	128.8	1320.3	1681	68921	6.403	3.448
4 3/4	14.92	17.72	22.56	107.16	2.179	1.681	42	131.9	1385.4	1764	74088	6.481	3.476
5	15.71	19.63	25.	125.	2.236	1.710	43	135.1	1452.2	1849	79507	6.557	3.503
5 1/4	16.49	21.64	27.56	144.70	2.291	1.738	44	138.2	1520.5	1936	85184	6.633	3.530
5 1/2	17.28	23.76	30.25	166.37	2.345	1.765	45	141.4	1590.4	2025	91125	6.708	3.557
5 3/4	18.06	25.97	33.06	190.11	2.398	1.792	46	144.5	1661.9	2116	97336	6.782	3.583
6	18.85	28.29	36	216.	2.449	1.817	47	147.7	1734.9	2209	103823	6.856	3.609
6 1/4	19.64	30.68	39.06	244.14	2.5	1.832	48	150.8	1809.6	2304	110592	6.928	3.634
6 1/2	20.42	33.18	42.25	274.63	2.550	1.866	49	153.9	1885.7	2401	117649	7.	3.659
6 3/4	21.21	35.78	45.56	307.55	2.599	1.890	50	157.1	1963.5	2500	125000	7.071	3.684
7	21.99	38.48	49.	343.	2.646	1.913							

NOTE.—To find the 4th power (or biquadrate) of a number, multiply the square by the square.

To find the 4th root, extract the square root twice in succession.

WEIGHTS OF SQUARE AND ROUND BARS OF WROUGHT IRON IN POUNDS PER LINEAL FOOT.—KENT.

Iron weighing 480 lbs per cubic foot. For steel add 2 per cent.

Thickness or Diameter in Inches.	Weight of Square Bar One Foot Long.	Weight of Round Bar One Foot Long.	Thickness or Diameter in Inches.	Weight of Square Bar One Foot Long.	Weight of Round Bar One Foot Long.
1/16	.013	.010	4 1/16	55.01	43.21
1/8	.032	.041	4 1/8	56.72	44.55
3/16	.117	.092	4 1/4	68.45	45.91
1/4	.208	.164	4 1/2	60.21	47.29
5/16	.326	.256	4 3/4	61.99	48.69
3/8	.469	.368	4 7/8	63.80	50.11
7/16	.638	.501	4 7/8	65.64	51.55
1/2	.833	.654	4 7/8	67.50	53.01
9/16	1.055	.828	4 7/8	69.39	54.50
5/8	1.302	1.023	4 7/8	71.30	56.00
3/4	1.576	1.237	4 7/8	73.24	57.52
7/8	1.875	1.473	4 7/8	75.21	59.07
1	2.201	1.728	4 7/8	77.20	60.63
1 1/16	2.552	2.004	4 7/8	79.22	62.22
1 1/8	2.930	2.301	4 7/8	81.26	63.82
1 1/4	3.333	2.618	5	83.33	65.45
1 1/2	3.763	2.955	5 1/8	85.43	67.10
1 3/4	4.219	3.313	5 1/8	87.55	68.76
1 7/8	4.701	3.692	5 1/8	89.70	70.45
2	5.208	4.091	5 1/8	91.88	72.16
2 1/16	5.742	4.510	5 1/8	94.08	73.89
2 1/8	6.302	4.950	5 1/8	96.30	75.64
2 1/4	6.888	5.410	5 1/8	98.55	77.40
2 1/2	7.500	5.890	5 1/8	100.8	79.19
2 3/4	8.138	6.392	5 1/8	103.1	81.00
2 7/8	8.802	6.913	5 1/8	105.5	82.83
3	9.492	7.455	5 1/8	107.8	84.69
3 1/16	10.21	8.018	5 1/8	110.2	86.56
3 1/8	10.95	8.601	5 1/8	112.6	88.45
3 1/4	11.72	9.204	5 1/8	115.1	90.36
3 1/2	12.51	9.828	5 1/8	117.5	92.29
3 3/4	13.33	10.47	6	120.0	94.25
3 7/8	14.18	11.14	6 1/8	125.1	98.22
4	15.05	11.82	6 1/4	130.2	102.3
4 1/16	15.95	12.53	6 1/4	135.5	106.4
4 1/8	16.88	13.25	6 1/4	140.8	110.6
4 1/4	17.83	14.00	6 1/4	146.3	114.9
4 1/2	18.80	14.77	6 1/4	151.9	119.3
4 3/4	19.80	15.55	6 1/4	157.6	123.7
4 7/8	20.83	16.36	7	163.3	128.3
5	21.89	17.19	7 1/8	169.2	132.9
5 1/16	22.97	18.04	7 1/4	175.2	137.6
5 1/8	24.08	18.91	7 1/4	181.3	142.4
5 1/4	25.21	19.80	7 1/4	187.5	147.3
5 1/2	26.37	20.71	7 1/4	193.8	152.2
5 3/4	27.55	21.64	7 1/4	200.2	157.2
5 7/8	28.76	22.59	7 1/4	206.7	162.4
6	30.00	23.56	8	213.3	167.6
6 1/16	31.26	24.55	8 1/4	226.9	178.2
6 1/8	32.55	25.57	8 1/4	240.8	189.2
6 1/4	33.87	26.60	8 1/4	255.2	200.4
6 1/2	35.21	27.65	9	270.0	212.1
6 3/4	36.58	28.73	9 1/4	285.2	224.0
6 7/8	37.97	29.82	9 1/2	300.8	236.3
7	39.39	30.94	9 3/4	316.9	248.9
7 1/16	40.83	32.07	10	333.3	261.8
7 1/8	42.30	33.23	10 1/4	350.2	275.1
7 1/4	43.80	34.40	10 1/2	367.5	288.6
7 1/2	45.33	35.60	10 3/4	385.2	302.5
7 3/4	46.88	36.82	11	403.3	316.8
7 7/8	48.45	38.05	11 1/4	421.9	331.3
8	50.05	39.31	11 1/2	440.8	346.2
8 1/16	51.68	40.59	11 3/4	460.2	361.4
8 1/8	53.33	41.89	12	480.	377.

WEIGHT OF FLAT BAR IRON.

Width inch.	THICKNESS IN INCHES.											
	$\frac{1}{16}$	$\frac{1}{8}$	$\frac{3}{16}$	$\frac{1}{4}$	$\frac{5}{16}$	$\frac{3}{8}$	$\frac{7}{16}$	$\frac{1}{2}$	$\frac{5}{8}$	$\frac{3}{4}$	$\frac{7}{8}$	1
	lbs.	lbs.	lbs.	lbs.	lbs.	lbs.	lbs.	lbs.	lbs.	lbs.	lbs.	
$\frac{1}{8}$.11	.21	.31	.42	.52	.63	.73	.84				
$\frac{3}{16}$.13	.26	.40	.53	.66	.79	.92	1.06	1.32			
$\frac{1}{4}$.16	.32	.47	.63	.79	.95	1.11	1.26	1.58	1.89		
$\frac{5}{16}$.18	.37	.55	.74	.92	1.11	1.29	1.48	1.85	2.22	2.58	
$\frac{3}{8}$.21	.42	.63	.84	1.05	1.26	1.47	1.68	2.11	2.53	2.95	3.37
$\frac{7}{16}$.24	.47	.71	.95	1.18	1.42	1.66	1.90	2.37	2.84	3.32	3.79
$\frac{1}{2}$.26	.53	.79	1.05	1.32	1.58	1.84	2.11	2.63	3.16	3.68	4.21
$\frac{5}{8}$.29	.58	.87	1.16	1.45	1.74	2.03	2.32	2.89	3.47	4.05	4.63
$\frac{3}{4}$.32	.63	.95	1.26	1.58	1.90	2.21	2.53	3.16	3.79	4.42	5.05
$\frac{7}{8}$.34	.68	1.03	1.37	1.71	2.05	2.39	2.74	3.42	4.11	4.79	5.47
1	.37	.74	1.11	1.47	1.84	2.21	2.58	2.95	3.68	4.42	5.16	5.89
$\frac{1}{8}$.40	.79	1.18	1.58	1.97	2.37	2.76	3.16	3.95	4.74	5.53	6.32
$\frac{3}{16}$.42	.84	1.26	1.68	2.11	2.53	2.95	3.37	4.21	5.05	5.89	6.74
$\frac{1}{4}$.45	.90	1.34	1.79	2.24	2.68	3.13	3.58	4.47	5.37	6.26	7.16
$\frac{5}{16}$.47	.95	1.42	1.90	2.37	2.84	3.32	3.79	4.74	5.68	6.63	7.58
$\frac{3}{8}$.50	1.00	1.50	2.00	2.50	3.00	3.50	4.00	5.00	6.00	7.00	8.00
$\frac{7}{16}$.53	1.05	1.58	2.11	2.63	3.16	3.68	4.21	5.26	6.32	7.37	8.42
$\frac{1}{2}$.55	1.11	1.66	2.21	2.76	3.32	3.87	4.42	5.53	6.63	7.74	8.84
$\frac{5}{8}$.58	1.16	1.74	2.32	2.89	3.47	4.05	4.63	5.79	6.95	8.10	9.26
$\frac{3}{4}$.61	1.21	1.82	2.42	3.03	3.63	4.24	4.84	6.05	7.28	8.47	9.68
$\frac{7}{8}$.63	1.26	1.90	2.53	3.16	3.79	4.42	5.05	6.32	7.58	8.84	10.10
1	.68	1.37	2.05	2.74	3.42	4.11	4.79	5.47	6.84	8.21	9.58	10.95
$\frac{1}{8}$.74	1.47	2.21	2.95	3.68	4.42	5.16	5.89	7.37	8.84	10.32	11.79
$\frac{3}{16}$.79	1.58	2.37	3.16	3.95	4.74	5.53	6.32	7.89	9.47	11.05	12.63
$\frac{1}{4}$.84	1.68	2.53	3.37	4.21	5.05	5.89	6.74	8.42	10.10	11.79	13.47
$\frac{5}{16}$.90	1.79	2.68	3.58	4.47	5.37	6.26	7.16	8.95	10.74	12.53	14.31
$\frac{3}{8}$.95	1.90	2.84	3.79	4.74	5.68	6.63	7.58	9.47	11.38	13.26	15.16
$\frac{7}{16}$	1.00	2.00	3.00	4.00	5.00	6.00	7.00	8.00	10.00	12.00	14.00	16.00
$\frac{1}{2}$	1.05	2.11	3.16	4.21	5.26	6.32	7.37	8.42	10.53	12.63	14.74	16.84
$\frac{5}{8}$	1.11	2.21	3.32	4.42	5.53	6.63	7.74	8.84	11.05	13.26	15.47	17.68
$\frac{3}{4}$	1.16	2.32	3.47	4.63	5.79	6.95	8.10	9.26	11.58	13.89	16.21	18.52
$\frac{7}{8}$	1.21	2.42	3.63	4.84	6.05	7.26	8.47	9.68	12.10	14.53	16.95	19.37
1	1.26	2.53	3.79	5.05	6.32	7.58	8.84	10.10	12.63	15.16	17.68	20.21

PLATE IRON.

WEIGHT OF SUPERFICIAL FOOT.

Thickness in inches.	Weight, lbs.	Thickness in inches.	Weight, lbs.
$\frac{1}{32}$ = .03125	1.25	$\frac{5}{16}$ = .3125	12.58
$\frac{1}{16}$ = .0625	2.519	$\frac{3}{8}$ = .375	15.10
$\frac{3}{32}$ = .0937	3.788	$\frac{1}{2}$ = .4375	17.65
$\frac{1}{8}$ = .125	5.054	$\frac{3}{4}$ = .5	20.20
$\frac{5}{32}$ = .1562	6.305	$\frac{7}{8}$ = .5625	22.76
$\frac{3}{16}$ = .1875	7.578	$\frac{15}{16}$ = .625	25.16
$\frac{1}{4}$ = .2187	8.819	$\frac{1}{2}$ = .75	30.20
$\frac{5}{16}$ = .25	10.09	$\frac{3}{4}$ = .875	35.30
$\frac{3}{8}$ = .2812	11.38	1 = 1.	40.40

SPECIFIC GRAVITY AND WEIGHT OF VARIOUS METALS.

METAL.	Specific Gravity.	Weight of a Cubic Inch in Lbs.	Weight of a Cubic Foot in Lts.
Aluminum, cast.....	2.560	.0926	160.
" wrought.....	2.670	.0906	156.5
Antimony.....	6.712	.2428	419.5
Brass, Sheet, Copper 75, Zinc 25.....	8.450	.3056	528.
" Yellow, Copper 66, Zinc 34.....	8.300	.2997	517.9
" Plate.....	8.380	.3026	522.9
" Cast.....	8.100	.2930	506.3
" Wire.....	8.214	.2972	513.5
Bronze, Gun Metal.....	8.750	.3165	546.9
" Copper 84, Tin 15.....	8.832	.3194	551.9
" Copper 81, Tin 19.....	8.700	.2929	506.1
" Phosphor-Bearing Metal.....	9.214	.3332	575.8
Copper, cast.....	8.788	.3179	547.2
" plates.....	8.698	.3146	543.7
" wire and bolts.....	8.860	.3212	555.1
Gold, pure, cast.....	19.258	.6965	1204.
" hammered.....	19.361	.7003	1210.
" 22 carats fine.....	17.486	.6325	1093.
" 20 carats fine.....	15.709	.5682	981.8
Iridium, hammered.....	23.000	.8319	1437.
Iron, cast, gun metal.....	7.308	.264	456.2
" ordinary, mean.....	7.207	.2607	450.4
" wrought bars.....	7.788	.2817	486.8
" wrought wire.....	7.774	.2811	485.8
" wrought rolled plates.....	7.704	.2787	481.6
Lead, cast.....	11.352	.4106	709.5
" rolled.....	11.388	.4119	711.7
Mercury-40 deg.....	15.632	.5661	978.2
" +32 deg.....	13.598	.4918	849.8
" +60 deg.....	13.569	.4908	848.1
" 212 deg.....	13.370	.4886	835.7
Nickel.....	8.800	.3183	550.
" cast.....	8.279	.2994	517.4
Platinum, hammered.....	20.337	.7356	1271.
" native.....	16.000	.5787	999.9
" rolled.....	22.069	.7982	13.9.
Red Lead.....	8.940	.324	559.9
Silver, pure, cast.....	10.474	.3788	654.6
" hammered.....	10.511	.3802	657.
Steel, tempered and hardened.....	7.818	.2828	488.7
" plates.....	7.806	.2823	487.7
" crucible.....	7.842	.2836	490.1
" Bessemer.....	7.852	.284	490.7
Tin, Cornish, hammered.....	7.390	.2673	461.9
" pure.....	7.291	.2637	455.7
Zinc, cast.....	6.861	.2482	428.8
" rolled.....	7.191	.26	449.4

WEIGHT OF VARIOUS SUBSTANCES.—RICHARDS.

Name of Substance.	Weight of 1 Cubic Foot in Lbs.	Name of Substance.	Weight of 1 Cubic Foot in Lbs.
Brickwork.....	100 to 120	Oils, various.....	54 to 57
Clay.....	120 to 130	Acid, Sulphuric.....	114 to 116
Coal.....	80 to 82	Oak Wood.....	42 to 53
Coke.....	45 to 62	Pine, White.....	27 to 30
Earth, Loose.....	76 to 90	Pine, Yellow.....	35 to 45
Earth, Rammed.....	100 to 120	Air.....	.08 to .080
Granite.....	160 to 165	Steam.....	.05 to .055
Sandstone.....	135 to 150	Snow.....	5.2 to 5.5
Water, Fresh.....	62.3 to 62.5	Coal Gas.....	.035 to .036
Water, Salt.....	63 to 65	Carbonic Acid.....	.122 to .123
Alcohol.....	50 to 60		

WEIGHT OF CASTINGS FROM PATTERNS.
Simpson Bolland.

A Pattern Weighing One Pound, Made of—	Will Weigh when Cast in				
	Cast Iron.	Zinc.	Copper.	Yellow Brass.	Gun Metal.
	Lbs.	Lbs.	Lbs.	Lbs.	Lbs.
Mahogany—Nassau.....	10.7	10.4	12.8	12.2	12.5
“ Honduras.....	12.9	12.7	15.3	14.6	15.
“ Spanish.....	8.5	8.2	10.1	9.7	9.9
Pine—Red.....	12.5	12.1	14.9	14.2	14.6
“ White.....	16.7	16.1	19.8	19.	19.5
“ Yellow ..	14.1	13.6	16.7	16.	16.5
Oak.....	9.	8.6	10.4	10.1	10.9

UNITS OF HEAT IN ONE POUND OF FUELS.

Anthracite.....	14,500	Petroleum, refined.....	19,200
Bituminous.....	14,000	Petroleum, crude.....	19,210
Petroleum, light.....	22,600	Coal Gas.....	20,200
Petroleum, heavy.....	19,440	Water Gas.....	8,500

TABLE OF RELATIVE VALUE OF NON-CONDUCTORS.



















Chas. E. Emery.

Non-Conductor.	Value.	Non-Conductor.	Value.
Wood Felt.....	1.000	Loam, dry and open.....	.550
Mineral Wool No. 2.....	.832	Slaked Lime.....	.480
Mineral Wool with Tar.....	.715	Gas House Carbon.....	.470
Sawdust.....	.680	Asbestos.....	.363
Mineral Wool No. 1.....	.676	Coal Ashes.....	.345
Charcoal.....	.632	Coke in lumps.....	.277
Pine Wood, across fiber.....	.553	Air space undivided.....	.136

PROPERTIES OF METALS.—RICHARDS.

Names of materials.	Weight in lbs. of a cubic foot.	Weight in lbs. of a cubic inch.	Relative Weight. Water, 1,000	Tensile strength lbs. per in. section.	Melting point in degrees Fahrenheit.
Wrought iron, avge.	485.0	.277	7,700	56,000	3,000
Cast iron, “	450.0	.260	7,200	16,000	2,300
Cast steel, “	487.0	.280	7,800	100,000	2,500
Bessemer steel, “	489.0	.280	7,852	90,000	2,500
Copper, “	547.0	.316	8,780	33,000	2,000
Brass, “	500.0	.281	8,100	20,000	1,800
Tin, “	455.0	.210	7,200	5,000	446
Lead, “	709.0	.410	11,352	2,000	600
Silver, “	653.0	.378	10,474	30,000	1,800

STANDARD HEXAGON BOLTS AND NUTS.

Diameter of Tap.	Threads per Inch.	Mill.	Across Corners.	Thickness U. S. Standard.	Depth of Thread.	W	Tap Drill Used.	Width of Flat.	Area at Root of Thread.	Safe Strain in lbs. Iron at 50,000 lbs. per sq. in.	Factor of Safety 5
$\frac{1}{4}$	20	$\frac{1}{2}$	$\frac{31}{16}$	$\frac{1}{4}$.0295		$\frac{13}{64}$.0056	.0286	285	
$\frac{5}{16}$	18	$\frac{3}{32}$	$\frac{11}{16}$	$\frac{5}{16}$.0361		$\frac{11}{64}$.0069	.0452	452	
$\frac{3}{8}$	16	$\frac{1}{16}$	$\frac{51}{64}$	$\frac{3}{8}$.0406		$\frac{9}{64}$.0078	.0877	677	
$\frac{7}{16}$	14	$\frac{3}{16}$	$\frac{23}{32}$	$\frac{7}{16}$.0464		$\frac{7}{32}$.0089	.0632	932	
$\frac{1}{2}$	13	$\frac{1}{8}$	$\frac{11}{16}$	$\frac{1}{2}$.0500		$\frac{5}{16}$.0096	.1257	1257	
$\frac{5}{8}$	12	$\frac{3}{16}$	$\frac{11}{16}$	$\frac{5}{8}$.0562		$\frac{3}{8}$.0104	.1620	1620	
$\frac{3}{4}$	11	$\frac{1}{4}$	$\frac{11}{16}$	$\frac{3}{4}$.0590		$\frac{3}{8}$.0114	.2018	2018	
$\frac{7}{8}$	10	$\frac{1}{4}$	$\frac{11}{16}$	$\frac{7}{8}$.0650		$\frac{5}{8}$.0125	.3020	3020	
1	9	$\frac{1}{2}$	$\frac{11}{16}$	1	.0722		$\frac{7}{8}$.0139	.4194	4194	
$1\frac{1}{8}$	8	$\frac{3}{8}$	$\frac{11}{16}$	$1\frac{1}{8}$.0812		$\frac{7}{8}$.0156	.5509	5509	
$1\frac{1}{4}$	7	$\frac{1}{2}$	$\frac{11}{16}$	$1\frac{1}{4}$.0928		$\frac{15}{16}$.0179	.6930	6930	
$1\frac{3}{8}$	6	$\frac{5}{8}$	$\frac{11}{16}$	$1\frac{3}{8}$.1083		$1\frac{1}{8}$.0208	.8890	8890	
$1\frac{1}{2}$	5	$\frac{3}{4}$	$\frac{11}{16}$	$1\frac{1}{2}$.1285		$1\frac{1}{4}$.0208	1.0540	10540	
$1\frac{3}{4}$	4	$\frac{7}{8}$	$\frac{11}{16}$	$1\frac{3}{4}$.1300		$1\frac{3}{8}$.0250	1.2930	12930	
2	4	$\frac{15}{16}$	$\frac{11}{16}$	2	.1444		$1\frac{1}{2}$.0278	1.7440	17440	
$2\frac{1}{4}$	4	$\frac{15}{16}$	$\frac{11}{16}$	$2\frac{1}{4}$.1625		$1\frac{3}{4}$.0278	2.3000	23000	
$2\frac{1}{2}$	4	$\frac{15}{16}$	$\frac{11}{16}$	$2\frac{1}{2}$.1625		$1\frac{3}{4}$.0313	3.0210	30210	
$2\frac{3}{4}$	3	$\frac{15}{16}$	$\frac{11}{16}$	$2\frac{3}{4}$.1857		$2\frac{1}{8}$.0313	3.7140	37140	
3	3	$\frac{15}{16}$	$\frac{11}{16}$	3	.1857		$2\frac{1}{8}$.0357	4.6180	46180	
									5.4270	54275	

GENERAL FORMULÆ, ETC.

1. Mill or distance across flats equals $1\frac{1}{2}$ times the diameter of Tap, plus $\frac{1}{8}$ inch.
2. Across corners or long diameter equals 1.155 times the mill. Table gives nearest $\frac{1}{16}$ larger.
3. Exact depth of thread equals .65 times the pitch. Width of flat on thread equals $\frac{1}{8}$ the pitch.
4. Exact size of hole U. S. Standard equals diameter Tap minus $\frac{1}{16}$ threads per in. Tap Drill nearest $\frac{1}{16}$ larger.
5. Bolt Heads same dimensions as Nuts.

TABLE OF EMERY WHEEL SPEEDS.

Diam. Wheel.	Rev. per Minute for Surface Speed of 4,000 Feet.	Rev. per Minute for Surface Speed of 5,000 Feet.	Rev. per Minute for Surface Speed of 6,000 Feet.
1 inch.	15,279	19,099	22,918
2 "	7,639	9,549	11,459
3 "	5,093	6,366	7,639
4 "	3,820	4,775	5,730
5 "	3,056	3,820	4,584
6 "	2,546	3,183	3,820
7 "	2,183	2,728	3,274
8 "	1,910	2,387	2,865
10 "	1,528	1,910	2,292
12 "	1,273	1,592	1,910
14 "	1,091	1,364	1,637
16 "	955	1,194	1,432
18 "	849	1,061	1,273
20 "	764	955	1,146
22 "	694	868	1,042
24 "	637	796	935
26 "	586	733	879
28 "	546	683	819
30 "	509	637	764
32 "	477	596	716
34 "	449	561	674
36 "	424	531	637
38 "	402	503	603
40 "	382	478	573
42 "	364	455	546
44 "	347	434	521
46 "	332	415	498
48 "	318	397	477
50 "	306	383	459
52 "	294	369	441
54 "	283	354	425
56 "	273	341	410
58 "	264	330	396
60 "	255	319	383

THE SPEED OF DRILLS.

Cleveland Twist Drill Co.

Diam. of Drill.	Spced for Soft Steel.	Speed for Iron.	Speed for Brass.	Diam. of Drill.	Speed for Soft Steel.	Spced for Iron.	Speed for Brass.
$\frac{1}{16}$	1,824	2,128	3,648	$1\frac{1}{16}$	108	125	215
$\frac{1}{8}$	912	1,064	1,824	$1\frac{1}{8}$	102	118	203
$\frac{3}{16}$	608	710	1,216	$1\frac{3}{16}$	96	112	192
$\frac{1}{4}$	456	532	912	$1\frac{1}{4}$	91	106	182
$\frac{5}{16}$	365	425	730	$1\frac{5}{16}$	87	101	174
$\frac{3}{8}$	304	355	608	$1\frac{3}{8}$	83	97	165
$\frac{7}{16}$	260	304	520	$1\frac{7}{16}$	80	93	159
$\frac{1}{2}$	228	266	456	$1\frac{1}{2}$	76	89	152
$\frac{9}{16}$	203	236	405	$1\frac{9}{16}$	73	85	145
$\frac{5}{8}$	182	213	365	$1\frac{5}{8}$	70	82	140
$\frac{11}{16}$	166	194	332	$1\frac{11}{16}$	68	79	135
$\frac{3}{4}$	152	177	304	$1\frac{3}{4}$	65	76	130
$\frac{13}{16}$	140	164	280	$1\frac{13}{16}$	63	73	125
$\frac{7}{8}$	130	162	260	$1\frac{7}{8}$	60	71	122
$\frac{15}{16}$	122	142	243	$1\frac{15}{16}$	59	69	118
1	114	133	228	2	57	67	114

TABLE OF SIZES OF TAP DRILLS.

Tap Diameter.	Threads per Inch.	Drill for V Thread.	Drill for U. S. Standard.
$\frac{1}{4}$	16 18 20	$\frac{5}{32}$ $\frac{3}{16}$ $\frac{11}{32}$	$\frac{3}{16}$
$\frac{5}{16}$	16 18 20	$\frac{7}{32}$ $\frac{1}{4}$ $\frac{15}{32}$	$\frac{1}{4}$
$\frac{3}{8}$	14 16 18 18	$\frac{1}{4}$ $\frac{9}{32}$ $\frac{11}{32}$ $\frac{13}{32}$	$\frac{9}{32}$
$\frac{1}{2}$	14 16 18	$\frac{3}{8}$ $\frac{7}{16}$ $\frac{15}{32}$ $\frac{17}{32}$	$\frac{13}{32}$
$\frac{5}{8}$	10 11 12	$\frac{1}{2}$ $\frac{9}{16}$ $\frac{11}{16}$ $\frac{13}{16}$	$\frac{7}{16}$ $\frac{13}{16}$
$\frac{3}{4}$	10 11 12	$\frac{11}{16}$ $\frac{3}{8}$ $\frac{13}{16}$ $\frac{15}{16}$	$\frac{1}{2}$
$\frac{7}{8}$	9 10	$\frac{13}{16}$ $\frac{3}{4}$ $\frac{15}{16}$ $\frac{17}{16}$	$\frac{5}{8}$ $\frac{13}{8}$
1	8 9	$\frac{15}{16}$ $\frac{17}{16}$ $\frac{19}{16}$ $\frac{21}{16}$	$\frac{3}{2}$ $\frac{27}{8}$

TAP DRILL SIZES.

For Gas Taps.

Diameter of Tap or Size of Pipe.	Diameter of Drill.	Diameter of Tap or Size of Pipe.	Diameter of Drill.
$\frac{1}{4}$ inch	$\frac{21}{64}$ inch	$\frac{1}{4}$ inch	$\frac{11}{32}$ inch
$\frac{1}{4}$ " "	$\frac{23}{64}$ " "	$\frac{1}{2}$ " "	$\frac{13}{32}$ " "
$\frac{3}{8}$ " "	$\frac{19}{32}$ " "	$\frac{3}{8}$ " "	$\frac{2}{16}$ " "
$\frac{1}{2}$ " "	$\frac{33}{32}$ " "	$\frac{1}{2}$ " "	$\frac{21}{16}$ " "
$\frac{3}{4}$ " "	$\frac{15}{8}$ " "	$\frac{3}{4}$ " "	$\frac{3}{8}$ " "
1 " "	$\frac{1}{16}$ " "	$\frac{3}{4}$ " "	$\frac{31}{32}$ " "

MACHINE SCREW TABLE.

Screw Gauge Size.	Diameter in Decimals.	Approximate Diameter.	No. Threads per Inch.	Size of Tap Drill.
2	.0842	$\frac{5}{64}$	56	49
3	.0973	$\frac{3}{32}$	48	45
4	.1105	$\frac{7}{64}$	36	42
5	.1236	$\frac{1}{8}$	36	38
6	.1368	$\frac{9}{64}$	32	35
7	.1500	$\frac{5}{32}$	32	30
8	.1631	$\frac{11}{64}$	32	29
9	.1763	$\frac{1}{8}$	30	27
10	.1894	$\frac{3}{16}$	24	25
11	.2026	$\frac{13}{64}$	24	21
12	.2158	$\frac{7}{32}$	24	17
13	.2289	$\frac{15}{64}$	22	15
14	.2421	$\frac{15}{64}$	20	13
15	.2552	$\frac{1}{4}$	20	8
16	.2684	$\frac{17}{64}$	18	6
17	.2816	$\frac{9}{32}$	18	2
18	.2947	$\frac{19}{64}$	18	1
19	.3079	$\frac{5}{16}$	18	C
20	.3210	$\frac{21}{64}$	16	D
22	.3474	$\frac{11}{32}$	16	J
24	.3737	$\frac{3}{8}$	16	N
26	.4000	$\frac{13}{32}$	16	P
28	.4263	$\frac{27}{64}$	14	R
30	.4526	$\frac{29}{64}$	14	U

TRANSMISSION OF POWER BY LEATHER BELTING.
Single Leather.

Belt Speed.	600	1200	1800	2400	3000	3600	4200	4800	5400	6000
Width of Belt.	H P	H P	H P	H P	H P	H P	H P	H P	H P	H P
1 in.....	1	2	3	4	5	6	7	8	9	10
2 in.....	2	4	6	8	10	12	14	16	18	20
3 in.....	3	6	9	12	15	18	21	24	27	30
4 in.....	4	8	12	16	20	24	28	32	36	40
5 in.....	5	10	15	20	25	30	35	40	45	50
6 in.....	6	12	18	24	30	36	42	48	54	60
8 in.....	8	16	24	32	40	48	56	64	72	80
9 in.....	9	18	27	36	45	54	63	72	81	90
10 in.....	10	20	30	40	50	60	70	80	90	100
12 in.....	12	24	36	48	60	72	84	96	108	120
14 in.....	14	28	42	56	70	84	98	112	126	140
16 in.....	16	32	48	64	80	96	112	128	144	160

Double Leather.

Belt Speed.	400	800	1200	1600	2000	2400	2800	3200	3600	4000	5000
Width of Belt.	H P	H P	H P	H P	H P	H P	H P	H P	H P	H P	H P
4 in.....	4	8	12	16	20	24	28	32	36	40	50
6 in.....	6	12	18	24	30	36	42	48	54	60	75
8 in.....	8	16	24	32	40	48	56	64	72	80	100
10 in.....	10	20	30	40	50	60	70	80	90	100	125
12 in.....	12	24	36	48	60	72	84	96	108	120	150
16 in.....	16	32	48	64	80	96	112	128	144	160	200
20 in.....	20	40	60	80	100	120	140	160	180	200	250
24 in.....	24	48	72	96	120	144	168	192	216	240	300
30 in.....	30	60	90	120	150	180	210	240	270	300	330
36 in.....	36	72	108	144	180	216	252	288	334	370	450
40 in.....	40	80	120	160	200	240	280	320	360	400	500

ROPE DRIVING.

TABLE OF THE HORSE POWER OF TRANSMISSION ROPE BY C. W. HUNT.

The working strain is 800 lbs. for a 2-inch diameter rope and is the same at all speeds, due allowance having been made for loss by centrifugal force.

Diameter Rope.	Speed of the Rope in Feet per Minute.										Smallest Diameter Pulleys.
	1500	2000	2500	3000	3500	4000	4500	5000	6000	7000	
3/4 in.....	3.3	4.3	5.2	5.8	6.7	7.2	7.7	7.7	7.1	4.9	30 in.
7/8 in.....	4.5	5.9	7.0	8.2	9.1	9.8	10.8	10.8	9.3	6.9	36 in.
1 in.....	5.8	7.7	9.2	10.7	11.9	12.8	13.6	13.7	12.5	8.8	42 in.
1 1/4 in.....	9.2	12.1	14.3	16.8	18.6	20.0	21.2	21.4	19.5	13.8	54 in.
1 1/2 in.....	13.1	17.4	20.7	23.1	25.8	28.8	30.6	30.8	28.2	19.8	60 in.
1 3/4 in.....	18.0	23.7	28.2	32.8	36.4	39.2	41.5	41.8	37.4	27.6	72 in.
2 in.....	23.1	30.8	36.8	42.8	47.6	51.2	54.4	54.8	50.0	35.2	84 in.

TRANSMITTING EFFICIENCY OF TURNED IRON SHAFTING AT DIFFERENT SPEEDS.

As Prime Mover or Head Shaft carrying Main Driving Pulley or Gear, well supported by bearings.

Diameter of Shaft.	Number of Revolutions per Minute.										
	60	80	100	125	150	175	200	225	250	275	300
	H P	H P	H P	H P	H P	H P	H P	H P	H P	H P	H P
1 3/4 in.	2.6	3.4	4.3	5.4	6.4	7.5	8.6	9.7	10.7	11.8	12.9
2 in.	3.8	5.1	6.4	8	9.6	11.2	12.8	14.4	16	17.6	19.2
2 1/4 in.	5.4	7.3	8.1	10	12	14	16	18	20	22	24
2 1/2 in.	7.5	10	12.5	15	18	22	25	28	31	34	37
2 3/4 in.	10	13	16	20	24	28	32	36	40	44	48
3 in.	13	17	20	25	30	35	40	45	50	55	60
3 1/4 in.	16	22	27	34	40	47	54	61	67	74	81
3 1/2 in.	20	27	34	42	51	59	68	76	85	93	102
3 3/4 in.	25	33	42	52	63	73	84	94	105	115	126
4 in.	30	41	51	64	76	89	102	115	127	140	153
4 1/2 in.	43	58	72	90	108	126	144	162	180	198	216
5 in.	60	80	100	125	150	175	200	225	250	275	300

TRANSMITTING EFFICIENCY OF TURNED IRON SHAFTING AT DIFFERENT SPEEDS.

As Second Movers or Line Shafting. Bearings 8 Feet Apart.

Diameter of Shaft. Inches.	Number of Revolutions per Minute.										
	100	125	150	175	200	225	250	275	300	325	350
	H. P.	H. P.	H. P.	H. P.	H. P.	H. P.	H. P.	H. P.	H. P.	H. P.	H. P.
1 3/4	6	7.4	8.9	10.4	11.9	13.4	14.9	16.4	17.9	19.4	20.9
1 7/8	7.3	9.1	10.9	12.7	14.5	16.3	18.2	20	21.8	23.6	25.4
2	8.9	11.1	13.3	15.5	17.7	20	22.2	24.4	26.6	28.8	31
2 1/8	10.6	13.2	15.9	18.5	21.2	23.8	26.5	29.1	31.8	34.4	37
2 1/4	12.6	15.8	19	22	25	28	31	35	38	41	44
2 3/8	15	18	22	26	29	33	37	41	44	48	52
2 1/2	17	21	26	30	34	39	43	47	52	56	60
2 3/4	23	29	34	40	46	52	58	64	69	75	81
3	30	37	45	52	60	67	75	82	90	97	105
3 1/4	38	47	57	66	76	85	95	104	114	123	133
3 1/2	47	59	71	83	95	107	119	131	143	155	167
3 3/4	58	73	88	102	117	132	146	162	176	190	205
4	71	89	107	125	142	160	178	196	213	231	249

TRANSMITTING EFFICIENCY OF TURNED IRON SHAFTING AT DIFFERENT SPEEDS.

For Simply Transmitting Power.

Diameter of Shaft. Inches.	Number of Revolutions per Minute.										
	100	125	150	175	200	233	267	300	333	367	400
	H. P.	H. P.	H. P.	H. P.	H. P.	H. P.	H. P.	H. P.	H. P.	H. P.	H. P.
1 3/4	6.7	8.4	10.1	11.8	13.5	15.7	17.9	20.3	22.5	24.8	27
1 7/8	8.6	10.7	12.8	15	17.1	20	22.8	25.8	28.6	31.5	34.3
1 3/4	10.7	13.4	16	18.7	21.5	25	28	32	36	39	43
1 7/8	13.2	16.5	19.7	23	26.4	31	35	39	44	48	52
2	16	20	24	28	32	37	42	48	53	58	64
2 1/8	19	24	29	33	38	44	51	57	63	70	76
2 1/4	22	28	34	39	45	52	60	68	75	83	90
2 3/8	27	33	40	47	53	62	70	79	88	96	105
2 1/2	31	39	47	54	62	73	83	93	104	114	125
2 3/4	41	52	62	73	83	97	111	125	139	153	167
3	54	67	81	94	108	123	144	162	180	198	216
3 1/4	68	86	103	120	137	160	182	205	228	250	273
3 1/2	85	107	128	150	171	200	228	257	285	313	342

SIZES OF CHIMNEYS WITH APPROPRIATE HORSE POWER BOILERS.
Babcock & Wilcox Co.

Diameter in Inches.	Height of Chimneys.											Effective Area, Square Feet.	Actual Area, Square Feet.	Side of Square of Approximate Area, Inches.		
	Commercial Horse Power.															
	50 ft.	60 ft.	70 ft.	80 ft.	90 ft.	100 ft.	110 ft.	125 ft.	150 ft.	175 ft.	200 ft.					
18	23	25	27											0.97	1.77	16
21	35	38	41											1.47	2.41	19
24	49	54	58	62										2.08	3.14	22
27	65	72	78	83										2.78	3.98	24
30	84	92	100	107	113									3.58	4.91	27
33		115	125	133	141									4.47	5.94	30
36		141	152	163	173	182								5.47	7.07	32
39			183	196	208	219								6.57	8.30	35
42			216	231	245	258	271							7.76	9.62	38
48				311	330	348	365	389						10.44	12.57	43
54				363	427	449	472	503	551					13.51	15.90	48
60				505	539	565	593	632	692	748				16.98	19.64	54
66				658	694	728	755	775	849	918				20.83	23.76	59
72				792	835	876	934	934	1023	1015	1181			25.08	28.27	64
78				995	1038	1107	1212	1107	1212	1310	1400			29.73	33.18	70
84				1163	1214	1294	1418	1294	1418	1531	1637			34.76	38.48	75
90				1344	1415	1496	1639	1496	1639	1770	1893			40.19	44.18	80
96				1537	1616	1720	1875	1720	1875	2027	2167			46.10	50.27	86

CAPACITY OF ROUND TANKS AND CYLINDERS IN CUBIC FEET AND IN U. S. GALLONS.
(FROM TRAUTWINE.)

Of 231 cubic inches (or 7.4805 gallons to a cubic foot); and for one foot of length of the cylinder. For the contents for a greater diameter than any in the table take the quantity opposite one-half said diameter, and multiply it by 4. Thus, the number of cubic feet in one foot length of a pipe 80 inches in diameter is equal to $8.728 \times 4 = 34.912$ cubic feet. So also with gallons and areas.

Diameter in inches.	Diameter in decimals of a foot.		For 1 foot in length.		Diameter in inches.	Diameter in decimals of a foot.		For 1 foot in length.		Diameter in inches.	Diameter in decimals of a foot.		For 1 foot in length.	
	Cubic ft., also area in sq. ft.	Gallons of 231 cubic ins.	Cubic ft., also area in sq. ft.	Gallons of 231 cubic ins.		Cubic ft., also area in sq. ft.	Gallons of 231 cubic ins.	Cubic ft., also area in sq. ft.	Gallons of 231 cubic ins.		Cubic ft., also area in sq. ft.	Gallons of 231 cubic ins.		
1/4	.0208	.0003	.0026	.0004	6 3/4	.5625	.2485	1.859	19	1.583	1.969	1.969	14.73	
1/2	.0260	.0005	.0040	.0007	7	.5833	.2673	1.999	19 1/2	1.625	2.074	2.074	15.52	
3/4	.0313	.0008	.0057	.0010	7 1/4	.6042	.2868	2.144	20	1.666	2.182	2.182	16.32	
1	.0365	.0010	.0078	.0013	7 1/2	.6250	.3068	2.295	20 1/2	1.708	2.292	2.292	17.15	
1 1/4	.0417	.0014	.0102	.0018	7 3/4	.6458	.3275	2.450	21	1.750	2.405	2.405	17.99	
1 1/2	.0469	.0017	.0129	.0021	8	.6667	.3490	2.611	21 1/2	1.792	2.521	2.521	18.86	
1 3/4	.0521	.0021	.0159	.0025	8 1/4	.6875	.3713	2.777	22	1.833	2.640	2.640	19.75	
2	.0573	.0026	.0193	.0030	8 1/2	.7083	.3940	2.948	22 1/2	1.875	2.761	2.761	20.65	
2 1/4	.0625	.0031	.0230	.0036	8 3/4	.7292	.4175	3.125	23	1.917	2.885	2.885	21.58	
2 1/2	.0677	.0036	.0270	.0040	9	.7500	.4418	3.305	23 1/2	1.958	3.012	3.012	22.53	
2 3/4	.0729	.0042	.0312	.0044	9 1/4	.7708	.4668	3.492	24	2.000	3.142	3.142	23.50	
3	.0781	.0048	.0359	.0048	9 1/2	.7917	.4923	3.682	25	2.083	3.409	3.409	25.50	
3 1/4	.0833	.0055	.0408	.0055	9 3/4	.8125	.5185	3.879	26	2.166	3.687	3.687	27.58	
3 1/2	.0885	.0062	.0459	.0062	10	.8333	.5455	4.081	27	2.250	3.976	3.976	29.74	
3 3/4	.0937	.0070	.0512	.0070	10 1/4	.8542	.5730	4.286	28	2.333	4.276	4.276	31.99	
4	.1042	.0085	.0638	.0085	10 1/2	.8750	.6013	4.498	29	2.416	4.587	4.587	34.31	
4 1/4	.1145	.0101	.0768	.0101	10 3/4	.8958	.6303	4.714	30	2.500	4.909	4.909	36.72	
4 1/2	.1250	.0123	.0918	.0123	11	.9167	.6600	4.937	31	2.583	5.241	5.241	39.21	
4 3/4	.1458	.0168	.1250	.0168	11 1/4	.9375	.6903	5.163	32	2.666	5.585	5.585	41.78	
5	.1667	.0218	.1632	.0218	11 1/2	.9583	.7213	5.395	33	2.750	5.940	5.940	44.43	
5 1/4	.1875	.0276	.2066	.0276	11 3/4	.9792	.7530	5.633	34	2.833	6.305	6.305	47.17	
5 1/2	.2083	.0341	.2550	.0341	12	1 foot	.7854	5.876	35	2.916	6.681	6.681	49.98	
5 3/4	.2292	.0413	.3085	.0413	12 1/4	1.042	.8523	6.375	36	3.000	7.069	7.069	52.88	
6	.2500	.0491	.3673	.0491	12 1/2	1.083	.9218	6.895	37	3.083	7.468	7.468	55.86	
6 1/4	.2708	.0576	.4310	.0576	13	1.083	.9218	6.895	38	3.166	7.876	7.876	58.92	
6 1/2	.2917	.0668	.4998	.0668	13 1/4	1.125	.9940	7.435	39	3.250	8.296	8.296	62.06	
6 3/4	.3125	.0767	.5738	.0767	13 1/2	1.167	1.069	7.997	40	3.333	8.728	8.728	65.29	
7	.3333	.0873	.6528	.0873	14	1.208	1.147	8.578	41	3.416	9.168	9.168	68.58	
7 1/4	.3542	.0985	.7370	.0985	14 1/4	1.250	1.227	9.180	42	3.500	9.620	9.620	71.96	
7 1/2	.3750	.1105	.8263	.1105	14 1/2	1.292	1.310	9.801	43	3.583	10.084	10.084	75.43	
7 3/4	.3958	.1231	.9205	.1231	15	1.333	1.396	10.44	44	3.666	10.560	10.560	79.00	
8	.4167	.1364	1.020	.1364	15 1/4	1.375	1.485	11.11	44	3.750	11.044	11.044	82.62	
8 1/4	.4375	.1503	1.124	.1503	15 1/2	1.417	1.576	11.79	45	3.833	11.540	11.540	86.32	
8 1/2	.4583	.1650	1.234	.1650	16	1.458	1.670	12.50	46	3.916	12.048	12.048	90.12	
8 3/4	.4792	.1803	1.349	.1803	16 1/4	1.500	1.767	13.22	47	4.000	12.566	12.566	94.02	
9	.5000	.1963	1.469	.1963	16 1/2	1.542	1.867	13.97	48					
9 1/4	.5208	.2130	1.594	.2130										
9 1/2	.5417	.2305	1.724	.2305										

CAPACITIES OF RECTANGULAR TANKS IN UNITED STATES GALLONS, FOR EACH FOOT IN DEPTH.

Width of Tank.	Length of Tank.											
	Feet.		Ft. In.		Feet		Ft. In.		Feet.		Ft. In.	
	2	2 6	3	3 6	4	4 6	5	5 6	6	6 6	7	
2	29.92	37.40	44.88	52.36	59.84	67.32	74.81	82.29	89.77	97.25	104.73	
2 6	...	46.75	56.10	65.45	74.80	84.16	93.51	102.86	112.21	121.56	130.91	
3	67.32	78.54	89.77	100.99	112.21	123.43	134.65	145.87	157.09	
3 6	91.64	104.73	117.82	130.91	144.00	157.09	170.18	183.27	
4	119.69	134.65	149.61	164.57	179.53	194.49	209.45	
4 6	151.48	168.31	185.14	201.97	218.80	235.63	
5	187.01	205.71	224.41	243.11	261.82	
5 6	223.28	246.86	267.43	288.00	
6	269.30	291.74	314.18	
6 6	316.05	340.36	

METRIC CONVERSION TABLE.

Arranged by C. W. Hunt, New York.

Millimeters $\times .03937$ = inches. Millimeters $\div 25.4$ = inches. Centimeters $\times .3937$ = inches. Centimeters $\div 2.54$ = inches. Meters $\times 39.37$ = inches. (Act Congress.) Meters $\times 3.281$ = feet. Meters $\times 1.094$ = yards. Kilometers $\times .621$ = miles. Kilometers $\div 1.6093$ = miles. Kilometers $\times 3280.7$ = feet. Square Millimeters $\times .0155$ = sq. inches. Square Millimeters $\div 645.1$ = sq. inches. Square Centimeters $\times .155$ = sq. inches. Square Centimeters $\div 6.451$ = sq. inches. Square Meters $\times 10.764$ = sq. feet. Square Kilometers $\div 247.1$ = acres. Hectare $\times 2.471$ = acres. Cubic Centimeters $\div 16.383$ = cubic inches. Cubic Centimeters $\div 3.69$ = fl. drachms. (U. S. P.) Cubic Centimeters $\div 29.57$ = fl. oz. (U.S.P.) Cubic Meters $\times 35.315$ = cubic feet. Cubic Meters $\times 1.308$ = cubic yards. Cubic Meters $\times 264.2$ = gallons (231 cu. in.) Liters $\times 61.022$ = cubic in. (Act Congress) Liters $\times 33.84$ = fluid ounces (U. S. Phar.) Liters $\times .2642$ = gallons (231 cu. in.) Liters $\div 3.78$ = gallons (231 cu. in.) Liters $\div 28.316$ = cubic feet. Hectoliters $\times 3.531$ = cubic feet.	Hectoliters $\times 2.84$ = bushels (2150.42 cu. in.) Hectoliters $\times .131$ = cubic yards. Hectoliters $\div 26.42$ = gallons (231 cu. in.) Grammes $\times 15.432$ = grains. (Act Congress.) Grammes $\div 981$ = dynes. Grammes (water) $\div 29.57$ = fluid ounces. Grammes $\div 28.35$ = ounces avoirdupois. Grammes per cu. cent. $\div 27.7$ = lbs. per cu. in. Joule $\times .7373$ = foot pounds. Kilogrammes $\times 2.2046$ = pounds. Kilogrammes $\times 35.3$ = ounces avoirdupois. Kilogrammes $\div 1102.3$ = tons (2,000 lbs.) Kilogrammes per sq. cent. $\times 14.23$ = lbs. per sq. in. Kilogram-meters $\times 7.233$ = foot lbs. Kilo per Meter $\times .672$ = lbs. per foot. Kilo per Cu. Meter $\times .062$ = lbs. per cu. ft. Kilo per Cheval $\times 2.235$ = lbs. per H. P. Kilo-Watts $\times 1.34$ = Horse Power. Watts $\div 746$ = Horse Power. Watts $\div .7373$ = foot pounds per second. Calorie $\times 3.968$ = B. T. U. Cheval vapeur $\times .9863$ = Horse Power. (Centigrade $\times 1.8$) $\div 32$ = d gree Fahrenheit. Franc $\times 193$ = Dollars. Gravity Paris = 980.94 centimeters per second.
--	---

DATA ON WATER.

1 cubic foot of water =	62.3791 lbs.
1 cubic inch of water =03612 lbs.
1 gallon of water =	8.338 lbs.
1 gallon of water =	231 cubic in.
1 cubic foot of water =	7.480 gallons.
1 pound of water =	27.7 cubic in.

The above data is calculated for distilled water at 40° Fahrenheit.

The pressure of a column of water in pounds per square inch is equal to the height of the column in feet multiplied by .433.

The pressure per square foot is equal to the height of the column in feet multiplied by 62.44. The power required to elevate water is equal to the weight of the water multiplied by the height in feet through which it is lifted (foot pounds) divided by 33,000. An allowance of 25 per cent should ordinarily be made for frictional losses.

DATA ON POWER.

The Unit of Work is the foot pound or the work necessary to raise a weight of one pound one foot.

The Unit of Heat is the British Thermal Unit or the amount of heat necessary to raise the temperature of one pound of pure water from 39° to 40° Fahrenheit.

The Mechanical Equivalent of one British Thermal Unit of heat is 778 foot pounds of work, and upon this value are based all heat and power determinations.

A Horse Power is the amount of work necessary to raise 33,000 pounds one foot high in one minute. It is dependent upon three factors: force, distance and time.

Indicated Horse Power is the measure of the work developed in the cylinder of an engine and equal to the following expression:

$$\text{Horse Power} = \frac{\text{Pressure} \times \text{Area} \times \text{Double Stroke} \times \text{Revolutions}}{33,000}$$

where pressure = the mean or average pressure per square inch on the piston; Area = the area of the piston in square inches; Double Stroke = the distance traveled by the piston in feet for each revolution, and Revolutions = the number of revolutions the engine makes in one minute. In this expression the pressure and area represent the force, and the stroke and revolutions the distance.

Brake Horse Power is the measure of the power given off at the shaft, and is always less than the indicated horse power by an amount equal to the work necessary to overcome the frictional resistance of the engine. In measuring the brake horse power a suitable brake is applied to the fly wheel of the engine as shown in Fig. 673.

A band a a a of rope, leather or steel is placed on the wheel. The rod R attached to the brake at the distance L from the center of rotation holds the brake from rotating with the wheel. This rod is attached to a suitable scale beam by means of which the pull P can be weighed. By means of the nut H and screw S the brake can be adjusted to absorb the full power of the engine.

We then have a force P acting through a distance represented by the radius L and

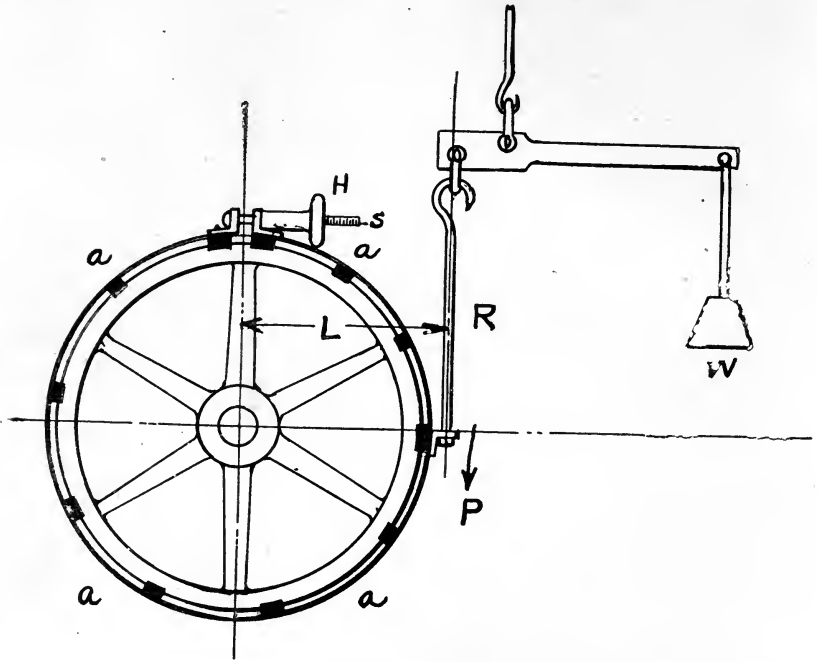

FIG. 673.

the number of revolutions the wheel makes, or, in other words, the distance the point P would move in one minute if free to turn.

$$\text{The brake horse power} = \text{horse power} = \frac{\text{force} \times \text{distance}}{33,000 \text{ foot pounds}} = \frac{P \times 2L \times \pi \times N}{33,000}$$

when P = the force in pounds; 2L = the diameter in feet of the circle through which the force acts; π = the constant 3.1416 by which the diameter is multiplied to obtain the circumference, and N = the number of revolutions per minute.

INDEX.

A

Addendum circle	465
Adjustable hollow milling tool.....	208
Adjustable reamers	114, 120
Adjustable limit gauges.....	91
Adjustable dies	136
Advantage of radial mills.....	318
Advantage of collapsing taps.....	133
Advantages of expansive mandrels..	158
Advantages of patent lathe tools..	201
Aligning shafting.....	512
Angular and notch gauges	84
Angular milling cutters.....	336, 339
Angular velocity	463
Angular drilling	415
Arbors	154
Arbors, milling	348
Arbors, shell end mill.....	346
Arbors, thread	347
Arch stays	462
Automatic gear cutting machines..	384
Automatic screw machine	191

B

Back facing	415
Back gearing, computation of.....	167
Back gear, friction.....	191
Back gearing, triple.....	167
Back lash, effect of on taper turning	230
Balancing of pulleys	521
Balancing way	521
Bearing, shaft	511
Bell center punch.....	220
Ball turning	243
Belting	490
Belting, care of leather.....	493
Belting, double, triple, etc.....	492
Belting, examples of drives.....	497
Belting, hides used for leather....	490
Belting, leather	490
Belting, leather strongest section of	492
Belting, methods of lacing.....	495
Belting, methods of lapping.....	494
Belting, power transmitted by.....	493
Belting, preparation of leather....	491
Belting, reasons for running hair side next to the pulley.....	496
Belts, run of on pulleys.....	501
Bevel gear cutting	365-387
Bevel gear cutting in milling machine	365
Bevel gear cutting, selecting of cutters for	382
Bevel gears	467
Bevel gears, laying out.....	474
Bevel gear planer, Belgram.....	392
Bevel gear planer, Gleason.....	392
Blocking for planer.....	299
Bolts, carriage	450
Bolts, machine	450
Bolts, stud	451
Boring bars	250
Boring large parallel holes in heavy drilling machines	420
Boring mills, floor	268

Boring mills, horizontal	263
Boring mills, relation to the lathe.	264
Boring mills, universal	269
Boring mill work, securing.....	260
Boring parallel holes in the lathe.	259
Boring mills, vertical.....	264
Boring, setting up work for.....	253
Boring spherical sockets.....	261
Boring tapered holes with boring bars	252
Boring tools	200-202-203
Boring work secured to the lathe carriage	252
Box cut-off slide	209
Box tools	207
Buffing spindle	425
Bushings, for jigs	410
Brazing furnace	522
Brown and Sharpe tapers.....	346

C

Circulating speed of pulleys.....	514
Calculation of cutting speeds.....	224
Calculations for indexing on automatic gear cutters	386
Caliper dividers	220
Calipers	64
Calipers, firm joint.....	64
Caliper gauges	60
Calipers, hermaphrodite.....	68
Calipers, how held	65
Calipers, keyhole	68
Calipers, lock joint	64
Calipers, micrometer	70
Calipers, recording	64
Calipers, spring joint	65
Calipers, thread	68
Calipers, transfer, types of.....	64-68
Calipers, use of	65-67
Calipers, vernier	68
Cam cutting attachment	333
Cam milling, example of.....	376
Cape chisels	20
Case hardening	448
Care in heating tool steel.....	446
Care in indexing	353
Care and use of drill chucks.....	151
Care of centers	236
Care of files	45
Care of lathe centers	181
Care of mandrel centers	161
Care of surface plates.....	54
Care necessary in chucking.....	255
Care to exercise in putting on arbor cutters	361
Carriage bolts	450
Cat head	226
Causes of inaccurate work with flat drills	104
Center bearing reamers.....	123
Center bearings, form of.....	222
Center bearings, lubrication of....	222
Center gauges	86
Center head square, use of.....	221
Center reamer, combination.....	222
Center rest	225
Center rest work, example of.....	227

- Centers, care of 236
Centers, drawing over 222
Centers, drilling of 222
Centers, pipe 238
Centers, index 296
Centers, locating of 220
Centers, planer 296
Check nuts 451
Chucking reamers 116, 118
Circular milling attachment 330
Circular pitch 465
Clamp dogs 211
Clamping work on planer 299-301
Clamps, belt 494
Clamps for planer 300
Classes of milling cutters 336
Classification of drilling jigs 410
Classification of files 25
Classification of grinding operations 423
Cleaning castings 46
Cleaning files 44
Clearance angle 198
Clearance in tap threads 131
Clearances in twist drills 105
Cold chisels; forms of 20
Cold chisels, how forged 18
Cold chisels, correct grinding of 19
Cold chisels, how held 21
Cold chisels, machinist 18
Cold chisels, temper of 21
Cold chisel, tempering of 446
Collet chucks 195
Collets, milling machine 346
Collets, spring chuck 348
Combination center reamer 222
Combination drill and pipe taps 133
Combination chucks 216
Combination squares 96
Comparison of wire gauges 82
Combination wrenches 102
Compound indexing 351
Compound rest 170
Compressed air in the shop 517
Computation of back gearing 167
Cones, rapid finishing of 259
Correct grinding of cold chisels 19
Correct use of hack saw blades 99
Correct use of hammers 18
Correct use of monkey wrenches 100
Cotter pins 458
Counter bore 415
Counter shafts 196
Couplings, shaft 508
Change gears in gangs 177
Chucking, care necessary in 255
Chucking work 254
Chucking work from outside 255
Chucks, drill 150
Chucks, drill, care and use of 151
Chucks, combination 216
Chucks, face plate 218
Chucks, independent 215
Chucks, lathe 214
Chucks, revolving 219
Chucks for special work 254
Chucks split 266
Chucks, universal 215
Collapsing taps, advantages of 133
Crank driven shapers 283
Crank pins, turning of 232
Cross-filing 30
Cross sections of files 22
Cutter and reamer grinder 425
Cutter bar for keyseater 310
Cutter head for boring 270
Cutters, care to exercise in putting
on arbor 361
Cutters for keyseaters 309
Cutters, importance of keeping
sharp 356
Cutters, milling, driving of 349-359
Cutting angle for drills 106
Cutting bevel gear 365-387
Cutting edges 197-199
Cutting double threads 235
Cutting key ways 364
Cutting worm gears 365
Cutting off machine 196
Cutting speeds 223
Cutting off tools 200
Cutting speeds, calculation of 224
Cutting speeds, effect upon output 224
Cutting spiral gears 394
Cycloidal curve 472
Cycloidal gearing system 467, 471
Cycloidal tooth curves 472
Cylinder boring, example of 271
Cylinder boring machine 270
Cylindrical grinding 428
- D**
- Data for spiral gears 482
Data on water 542
Definition of forced fit 262
Definition of horse power 542
Definition of working fit 262
Diametral pitch 465
Diamond point chisels 21
Diamond truers 437
Die sinking machine 320
Dies, adjustable 136
Dies, two classes of 135
Dies, effect of tempering on 140
Dies, self-opening 138
Dies, how sharpened 137
Dies, solid 136-138
Dies, use of on oversize stock 140
Dimensions of lathe 177
Dividing mechanism on automatic
gear cutters 386
Dogs, clamp 211
Dogs, die 211
Dogs, double end 211
Dogs, lathe 210
Dogs, effect of leverage on the work 210
Double cut files 25
Double threads, cutting of 235
Draw filing 39
Draw filing, accuracy of 40
Drawing of keys 457
Drawing over centers 222
Dressing and regrinding ham-
mers 18
Drift drill 134
Drill and tap holders, reversing 148
Drill and tap holders, importance
of 142
Drill chucks 150
Drill chuck, "Presto." 149
Drill feeds 110
Drill lubrication 110
Drill, pod 414
Drill shanks 108
Drill sockets 142
Drill speeds, rule for 110
Drill sizes 109
Drills, flat 103
Drilled holes, locating 112
Drilling attachment, high speed 407
Drilling large holes in plates 415
Drilling jigs 410
Drilling, annular 415
Drilling of centers 222
Drilling machines 397
Drilling machine, pneumatic 518
Drilling machines, standard pat-
tern 397
Drilling, starting drill true in the
lathe 249
Drilling of deep holes 414
Drilling jigs 410
Drilling in the lathe 248

Gauges, limit	61	Hobbing machine	393
Gauges, manufacture of	63	Hobs, worm	340, 365-393
Gauges, nut and washer	85	Hoists, hand	520
Gauges, plug and ring	59	Hoists, pneumatic	517
Gauges, scratch	89	Hollow hexagon turret lathe	196
Gauges, screw thread	88	Hollow milling tool, adjustable	208
Gauges, standard care in use of	61	Horse power, brake	542
Gauges, standard	59	Horse power, definition of	542
Gauges, standard thread	62	Horse power, indicated	542
Gauges, surface	90	Horse power, measuring of	542
Gauges, thickness	88	How to find tap drill sizes	141
Gauges, thread	87	How to sharpen dies	137
Gauges, use of	61	hypocycloidal curve	472
Gauges, wire	85		
Gear cutters	340	I	
Gear cutting, duplication system	379	Importance of drill and tap holders	142
Gear cutters, duplex	383	Importance of gang milling	313
Gear cutters in gangs	383	Importance of grinding	423
Gear cutting in plain milling machine, by under cut method	365	Importance of keeping sharp cutters	356
Gear cutting, large spur, in plain milling machine	365	Importance of milling machines	312
Gear cutting machines, automatic	384	Increase twist in drills	106
Gear cutting, molding planing method	380	Independent chucks	215
Gear cutting, templet planing method	380	Indexing, care in	353
Gear snaper, Fellows	389	Indexing, centers	323
Gears, bevel	467	Indexing, compound	351
Gears, toothed	464	Indexing, differential	352
Gears, worm	467-475	Indexing on automatic gear cutters, calculations for	386
Gearing	463	Indexing, plain	324
Gearing, cycloidal, system	467-471	Indexing, rule for	350
Gearing, efficiency of toothed	474	Indicator, use of test	92
Gearing, frictional	463	Influence of form and number of teeth in reamers	114
Gearing, involute system	467	Inside micrometer calipers	81
Gears, internal	443	Internal grinding	433
Gears with axes at varying distances	471	Involute curve	467
Gears, spiral	467	Involute tooth outline, approximate method of laying out	468
Gears, spur	467		
Graduated dials on feed screws, use of	362	J	
Graduate machine dials, value of	378	Jacks, planer	300
Grinder, cutter and reamer	425	Jig, box, example of	412
Grinder, twist drill	428	Jigs, drilling, classification of	410
Grinding, cylindrical	428	Jigs, examples of	411
Grinding, importance of	423	Jigs, for drilling	410
Grinding, internal	429-433	Jigs of gang drilling	417
Grinding machine, plain	293-429	Jig milling, example of	374
Grinding machine, universal	428		
Grinding operations, classification of	423	K	
Grinding steep tapers	434	Key rule blocks	97
Grinder, portable	437	Key seater	308
Grinder, tool	424	Key seaters, portable	311
		Key seating in a shaper	298
H		Key ways, cutting of	364
Hack saw blades	99	Keys, drawing of	457
Hack saw blades, correct use of	99	Keys, flat	455
Hack saw frames	100	Keys, gib head	457
Hack sawing machines	520	Keys, round	454
Hammers, correct use of	18	Keys, taper of	455
Hammers, dressing and regrinding	18	Keys, Woodruff	456
Hammers, forms of	17	Knee plate, securing work to	254
Hammer handles	18	Knee plate, use of	375
Hammers, machinist	17	Knurling tools	206
Hammers, pneumatic	518		
Hammers, weight of	17	L	
Hand cut files	27	Large micrometer calipers	74
Hand caps	129	Lapping	438
Handles, of hammers	18	Laps	439
Hardening in oil	443	Lathe beds	165
Hardening in steel	440	Lathe carriage	169
Heat, unit of	542	Lathe centers, care of	181
Heating of steel	443	Lathe change gears	174
Heating of tool steel, care in	446	Lathe change gear calculations	175
Hermaphrodite calipers	220	Lathe change gears, compound	175
Hides used for leather belting	490		
High speed milling attachment	331, 407		
Hints on planer manipulation	305		

- Lathe chucks..... 214
 Lathe, dimensions of..... 177
 Lathe dogs..... 210
 Lathe, elements of..... 165
 Lathe, engine..... 165
 Lathe, gap..... 184
 Lathe head stock..... 165
 Lathe, importance of..... 163
 Lathe, monitor..... 189
 Lathe pans..... 525
 Lathe, pit..... 184
 Lathe, pulley..... 185
 Lathe racks..... 525
 Lathe, relationship with other tools..... 163
 Lathe, speed or hand..... 164
 Lathe spindle bearings..... 166
 Lathe tail stock..... 168
 Lathes, testing of..... 179
 Lathe tools..... 197
 Lathe, tool makers..... 182
 Lathe tools, patent..... 200
 Lathe tools, patent, advantages of..... 201
 Lathe tools, threading..... 203
 Lathe tools, setting of..... 199
 Lathe, two spindle..... 183
 Lathe, turret..... 186
 Lathe, turret chucking..... 188
 Lathe, wheel..... 184
 Laying out bevel gears..... 474
 Lead screw..... 169-174-177
 Lead screw nut..... 174
 Lead screw threads..... 177
 Leather belting..... 490
 Left-hand screw cutting..... 234
 Leveling wedges..... 299
 Linear velocity..... 463
 Line of action in gearing..... 473
 Link leather belting..... 496
 Lining up line shafting..... 512
 Link planing attachment..... 295
 Limit gauges..... 61
 Locating drilled holes..... 112
 Lock nuts..... 451
 Lubrication of center bearings..... 222
 Lubrication of drills..... 41
 Lubricating machine centers..... 161
 Lubricating, planer ways..... 280
 Lubrication of milling centers..... 378
 Lubrication of taps and dies..... 140
- M**
- Machine bolts..... 450
 Machinists' cold chisels..... 18
 Machine cut files..... 26
 Machinists' hammers..... 17
 Mandrel block..... 161
 Mandrel centers..... 154
 Mandrel centers, care of..... 161
 Mandrel presses..... 162
 Mandrels..... 153
 Mandrels, driving in bores..... 161
 Mandrels, expanding..... 154, 156
 Mandrels, expansive, advantages of..... 158
 Mandrels for conical bores..... 158
 Mandrels for large bores..... 159
 Mandrels, hardened and ground..... 155
 Mandrels, influence of on sizes of bores..... 156
 Mandrels, nut..... 159
 Mandrels, solid..... 154
 Mandrels stub..... 160
 Mandrels, taper of..... 156
 Mandrels, with ends only hardened..... 155
 Manufacturers' drilling machine..... 406
 Measuring machine, Pratt & Whitney..... 78
 Measuring machine, Rogers-Bond..... 57
 Measuring machines, Sweets..... 79
 Mechanical equivalent of heat..... 542
- Methods for testing squares..... 95
 Method of lacing belting..... 495
 Methods of lapping belting..... 494
 Methods of producing screw threads..... 129
 Micrometer calipers, beam..... 76
 Micrometer calipers, bench..... 77
 Micrometer calipers, for measuring screw threads..... 73
 Micrometer calipers, inside..... 81
 Micrometer calipers, large..... 74
 Micrometer calipers, reading of..... 71
 Micrometer calipers, use of..... 72
 Milling arbors..... 348
 Milling, advantages for certain classes of work over planing..... 312
 Milling attachment for planer..... 293
 Milling cutters, forms of teeth..... 345
 Milling cutter vibration, causes of..... 378
 Milling cutters, advantages of small diameters of..... 361-345
 Milling cutters, angular..... 336-339
 Milling cutters, axial..... 336
 Milling cutters, classes of..... 336
 Milling cutters, inserted tooth..... 343
 Milling cutters, formed..... 336-339-341
 Milling cutters, grinding of..... 345
 Milling cutters, method of driving..... 346
 Milling cutters, nicked teeth..... 337
 Milling cutters, radial..... 336
 Milling cutters, straddle..... 337
 Milling, direction of feed and rotation of cutter for..... 358
 Milling, examples of..... 359-361-363
 Milling head, universal..... 328
 Milling head, vertical spindle..... 328
 Milling, in the lathe..... 260
 Milling machine as a manufacturing tool..... 313
 Milling machine, duplex..... 317
 Milling machine feeds..... 321
 Milling machine feeds, all gear..... 322
 Milling machine, plain..... 314
 Milling machine, slabbing..... 317
 Milling machine, universal..... 313
 Milling machine, vertical spindle..... 317-319
 Milling machines, importance of..... 312
 Mills, end..... 338
 Mills, end, center cut..... 338
 Monitor lathe..... 189
 Monkey wrenches..... 100
 Movable racks..... 525
 Movable head boring bars..... 250
 Muffler for tempering..... 253
 Multiple cutters, for boring..... 107
 Multiple fluted drills and their uses..... 399
 Multiple spindle drills..... 128
 Multiple thread screws..... 128
- N**
- Names of files..... 22, 23
 Necessity of belly in files..... 29
 Nut and washer gauges..... 85
 Nut drivers..... 212
 Nuts, machine..... 454
 Nut locks..... 452
- O**
- Object of tempering..... 440
 Odontograph, Grant's involute..... 470
 Oil, filtering of..... 522
 Oil pump..... 334
 Oil separator..... 522
 Oil tube drills..... 111
 Open side planer..... 279
 Open side shaper..... 288
 Overhanging arm supports..... 321
 Oversize in taps..... 131

P

Parts of planer head	281
Patent lathe tools	200
Pickling brass castings	47
Pickling castings	47
Pilot bars	257
Pipe centers	238
Pitch circle	465
Pitch of screw thread	127
Planer attachments	293
Planer clamps	300
Planer jacks	300
Planer, characteristic parts	273
Planer and its modifications	243
Planer and shaper tools	291
Planer feeds	246
Planer head, parts of	281
Planer, open side	279
Planer, table drives	274
Planer table reversing mechanism	275
Planer table stop pins	302
Plane surface, method of producing	53
Planing, care necessary in	305
Planing, clamping of work	299
Planing, lining up work	304
Planing, securing work in vise	304
Planing, springing of work in	303
Pneumatic drilling machine	518
Pneumatic hammers	518
Pneumatic hoists	517
Pinning of files	45
Plain grinding machine	293, 429
Plain milling machine	314
Plain turret screw machine	191
Planer centers	296
Planer, jacks	300
Planer tool clamps	282
Plug and ring gauges	59
Portable drills	405
Portable grinding head	437
Portable key seater	311
Position of tool for screw cutting	233
Position of work for filing	33
Position of workman filing	33
Power required to elevate water	542
Power transmitted by belting	493
Pratt & Whitney measuring machine	78
Pratt & Whitney's standard graduated line-measure bar	56
Preparation of leather belting	491
Problems in spiral gearing	483
Proper care and use in reamers	122
Pulleys	510
Pulleys, balancing of	521
Pulleys, calculating speed of	514
Pulleys, clutch	510
Pulley drivers	213
Pulley lathe	185
Pulley taps	131

R

Rack cutting attachment	332, 388
Racks, cutting of	388
Rack-driven shapers	283
Racks for files	46
Rack teeth, involute	469
Racks, movable	525
Radial drills	401
Radial mills, advantages of	318
Raising blocks	182
Rake angles	198
Reamer, special large	421
Reamers, adjustable	114-120
Reamers, arbors for shell	119
Reamers, center bearing	123
Reamers, chucking	116-118
Reamers, expansive	120
Reamers, fluting of	364
Reamers, hand	116

Reamers, influence of form and number of teeth in	114
Reamers, life of	120
Reamers, points on manufacture of	116
Reamers, the proper care and use of	122
Reamers, shell	119
Reamers, solid	114
Reamers, stocking	122
Reamers, taper	120
Reamers, tooth clearance in	115
Reamers, undersized, reclaiming of	120
Reamers with three flutes	119
Reamers with spiral flutes	119
Reaming by hand	124
Reaming in machines	124
Reaming in the lathe	249
Recording calipers	64
Regrinding and dressing hammers	18
Relationship of lathe with other tools	163
Relieving attachment for lathes	24
Reversing drill and tap holders	148
Revolving chucks	219
Riveted joints	458
Rivet holes	460
Rivets	458
Rivets, setting of	461
Rogers-Bond comparator	57
Rogers-Bond measuring machine	57
Rolled drills	106
Root circle	465
Rope drives	502
Rope drives, flexibility of	506
Rope splicing	502
Rope transmissions, systems of	505
Ropes, speed of in drives	507
Round keys	454
Rule for drill speeds	110
Rule for indexing	350
Rules for determining gear parts	466
Rules, gear	94
Rules, hook	94
Rules, key seat	97
Rules, standard steel	93
Rules with end graduation	93

S

Safety edges on files	36
Scrapers and surface plates	48
Scrapers, forms of	48
Scrapers, how held and used	51
Scrapers, use of	48
Scraping, plane surfaces	52
Scraping, preparation of work surface for	50
Scratch gauges	89
Screw cutting, by use of compound rest	236
Screw cutting, catching thread in	237
Screw cutting, exercise of care in	235
Screw cutting, in the lathe	233
Screw cutting, left-hand	234
Screw cutting, position of tool for	233
Screw cutting, square threads	236
Screw drives and how ground	100
Screw machine, plain turret	191
Screw machine, automatic	191
Screw thread gauges	88
Screw thread, pitch of	127
Screw threads	125
Screw threads table	128
Screw threads for fastenings	125
Screw threads for transmitting motion	125
Screw threads, methods of producing	129
Screw threads, square, trapezoidal and Powell's	127
Screws, cap	452
Screws, set	453
Securing work on planer	299, 304
Securing work to knee plate	254

Are You Awake

to the vast amount of valuable and interesting matter which is afforded the readers of

Cassier's Magazine
The Leading

ENGINEERING MONTHLY

25 Cents a copy.

\$3.00 a year.

it contains articles of the greatest importance in each issue, and should be read not only by every Engineer, but by every thinking man in order to keep in touch with industrial progress.

It is impossible to tell half of its good features here—and we prefer anyway to let the magazine speak for itself.

Why not send for a sample copy? We will send you one free—or we will send you the current number and two previous ones for twenty-five cents.

THE MAGAZINE OF INDUSTRIAL PROGRESS

Send for "AS OTHERS SEE US" it is of interest to every advertiser and will interest you. A COPY FOR THE ASKING

The Cassier Magazine Company

12 West 31st Street, New York

THE PEERLESS

Piston and Valve

Rod Packing

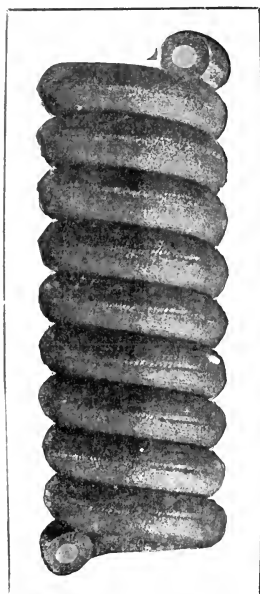

It will hold 400 pounds of steam.

Will run twelve months in high-speed engines.

In boxes 3 to 8 pounds.

1-4 to 2 inches diameter.

Made in three different shapes:
Straight, Spiral and Square
Spiral.

SOLE MANUFACTURERS OF THE

**Celebrated "Rainbow Packing," "Eclipse Sectional
Rainbow Gasket," "Hercules Combination,"
"Honest John," "Success," "Arctic,"
and "Germane" Packings**

Manufacturers of a full and complete line of superior Rubber Goods, including Gas Bags, Belting, Fire Buckets, Diaphragms, Disks for Valves, Rubber Gaskets, Air, Steam Hydrant, Garden and Suction Hose, Landing Pads, Mats and Matting, Nipple Caps, Packing, Pails, Pump Valves, Gauge Glass Rings, Springs, Tubing, etc.

COPYRIGHTED AND MANUFACTURED EXCLUSIVELY BY

PEERLESS RUBBER MANUFACTURING CO.

16 WARREN STREET - - - - NEW YORK

FOR SALE BY ALL FIRST-CLASS DEALERS

RAINBOW PACKING

Thousands
of Imitators.
No Equal.
Will Hold
Highest
Pressure.



Don't Have to
Use Wire and
Cloth to Hold
RAINBOW.
Can't Blow
It Out.

THE COLOR OF RAINBOW PACKING IS RED

Notice our trademark of the word "Rainbow" in a diamond, in Three Rows of Diamonds in Black, extending throughout the entire length of each and every roll of Rainbow Packing

Sole Manufacturers of the Famous

Eclipse Sectional Rainbow Gasket
Peerless Piston and Valve Rod Packing
Honest John Hydraulic Rainbow Core Packing
Hercules Combination
Arctic Ammonia Ring Packing

A FULL AND COMPLETE LINE OF FINE MECHANICAL
RUBBER GOODS
INCLUDING RUBBER HOSE FOR ALL PURPOSES

SEND FOR OUR NEW CATALOGUE

Copyrighted and Manufactured Exclusively by

PEERLESS RUBBER MANUFACTURING CO.
16 WARREN STREET - - - - NEW YORK

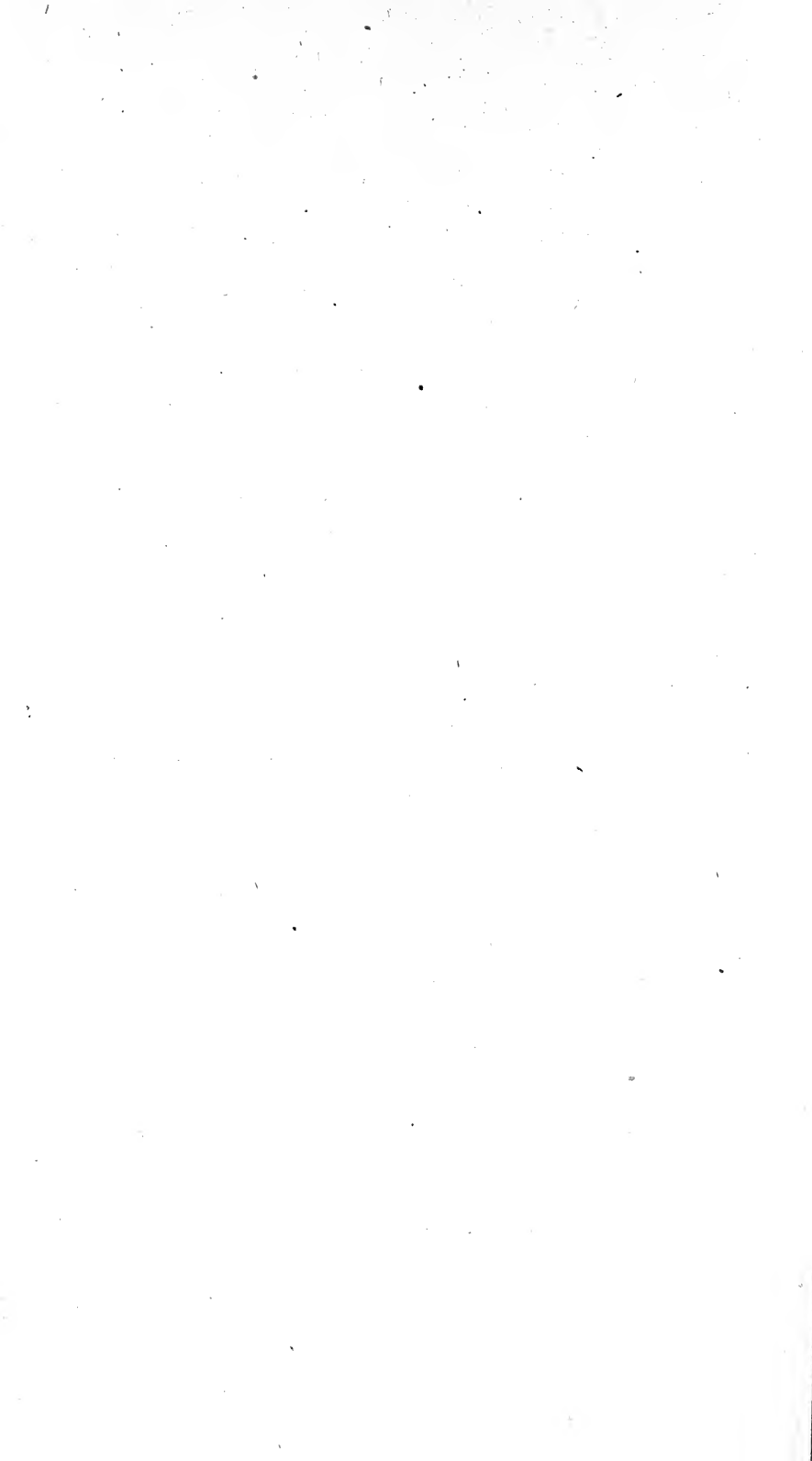

1911

CATALOGUE

of

Practical Books

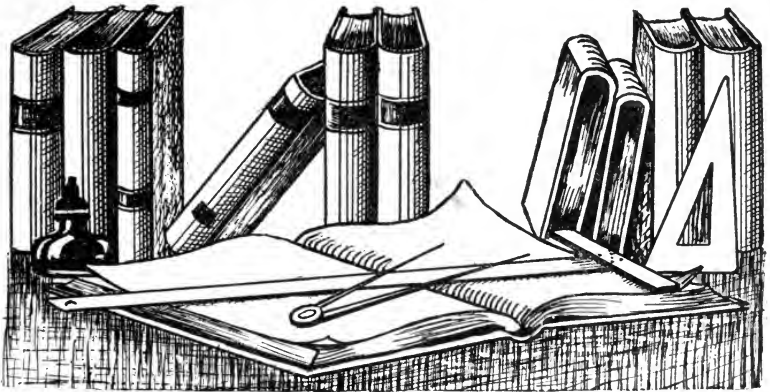

Published and for sale by

The Norman W. Henley Publishing Company

Publishers of Scientific and Practical Books

132 NASSAU STREET

NEW YORK, U.S.A.

All books in this Catalogue sent prepaid on receipt of price.

SUBJECT INDEX

	PAGE		PAGE
Air Brakes.....	3, 12, 13	Manual Training.....	16
Arithmetics.....	7, 15, 20	Marine Engines.....	16
Balloons.....	3	Mechanical Movements.....	15
Bevel Gears.....	10	Metal Turning.....	11
Boilers.....	3, 13, 16	Milling Machines.....	16
Brazing.....	3	Mining.....	13
Cams.....	11	Oil Engines.....	10
Car Charts.....	3	Patents.....	11
Change Gear.....	11	Pattern Making.....	17
Charts.....	3	Perfumery.....	17
Chemistry.....	10, 17	Pipes.....	20
Coal Mining.....	17	Plumbing.....	18
Coke.....	4	Producer Gas.....	10
Compressed Air.....	4	Punches.....	6
Concrete.....	4, 5	Receipt Book.....	18
Cyclopedia.....	4	Refrigeration.....	11
Dictionaries.....	5	Rubber Stamps.....	18
Dies.....	6	Saws.....	18
Drawing.....	6, 18	Sheet Metal Working.....	6
Drop Forging.....	6	Shop Tools.....	15
Dynamo.....	7, 8	Shop Construction.....	15
Electricity.....	7, 8, 9	Shop Management.....	15
Engines and Boilers.....	16	Sketching Paper.....	6
Flying Machines.....	3	Smoke Prevention.....	9, 12
Fuel.....	9, 12	Soldering.....	3
Gas Manufacturing.....	10	Steam Engineering.....	19, 20
Gas Engines.....	10	Steam Heating.....	20
Gears.....	10	Steam Pipes.....	20
Heating, Electric.....	7	Steel.....	20
Hot Water Heating.....	20	Superheated Steam.....	12
Horse-Power Chart.....	19	Switchboards.....	7, 8
Hydraulics.....	11	Tapers.....	12
Ice Making.....	11	Telephone.....	6
India Rubber.....	18	Threads.....	11
Interchangeable Manufacturing.....	14	Tools.....	14, 15, 16
Inventions.....	11	Ventilation.....	20
Lathes.....	11	Valve Gear.....	11
Lighting (Electric).....	7	Valve Setting.....	11
Link Motion.....	13	Walschaert Valve Gear.....	11
Liquid Air.....	12	Watchmaking.....	20
Locomotive Engineering.....	12, 13, 14	Wiring.....	7, 8
Machinist's Books.....	14, 15, 16	Wireless Telephones.....	20

INDEX BY AUTHORS

	PAGE		PAGE		PAGE
Alexander, J. H.....	3	Erskine-Murray.....	9	Perrigo, Oscar E.....	9, 11, 12
Askinson, G. W.....	17	Fowler, Geo. L.....	3, 13	Pratt, H.....	9, 11, 12
Barr, Wm. M.....	9, 12	Garbe, Robert.....	12	Putnam, Xenon W.....	1
Barrows, F. W.....	17	Goddard, Dwight.....	19	Radcliffe and Cushing.....	1
Bauer, Dr. G.....	16	Grimshaw, Robert.....	13, 16, 18, 19	Richards-Colvin.....	1
Baxter, Wm.....	7, 8	Harrison, Newton.....	7	Rouillon, Louis.....	11, 12
Benjamin, Park.....	16	Haslam, Arthur P.....	8	Royle, H. M.....	1
Blackall, R. H.....	12, 13	Hiscox, G. D.....	4, 10, 11, 15, 17, 18, 19	Saunier, Claudius.....	2
Booth and Kershaw.....	9	Hobart, J. F.....	3	Sloane, T. O'Conor.....	5, 7, 8, 12, 13
Booth, Wm. H.....	20	Horner, J. G.....	4, 11, 14, 16	Starbuck, R. M.....	1
Buchetti, J.....	19	Houghton, A. A.....	4, 5	Sylvester and Oberg.....	1
Byrom, T. H.....	17	Johnson, J. P.....	17	Usher, John T.....	1
Byrom and Christopher.....	4	King, A. G.....	20	Vandervoort, W. H.....	1
Cockin, T. H.....	17	Kleinhans, F. A.....	13	Walker, S. F.....	1
Colvin, Fred H.....	12, 13	Kraus, H. T. C.....	6	Wallis-Taylor, A. J.....	1
Colvin-Cheney.....	15, 20	Lewis, M. H.....	5	Weed, A. J.....	1
Colvin-Stabel.....	16	Lummis-Paterson.....	8	Wood, Wm. W.....	1
Crane, W. E.....	19	Markham, E. R.....	20	Woodworth, J. V.....	6, 14, 20
Dalby, H. A.....	14	Mathot, R. E.....	10	Wright, J.....	1
Engstrom, D. Ag.....	10	Parsell and Weed.....	10		

ANY BOOK ADVERTISED IN THIS CATALOGUE WILL BE SENT PROMPTLY TO AN ADDRESS IN THE WORLD, CHARGES PREPAID, UPON RECEIPT OF PRICE.

How to Remit.—Remit by Postal Money Order, Express Money Order, Bank Draft or Registered Letter.



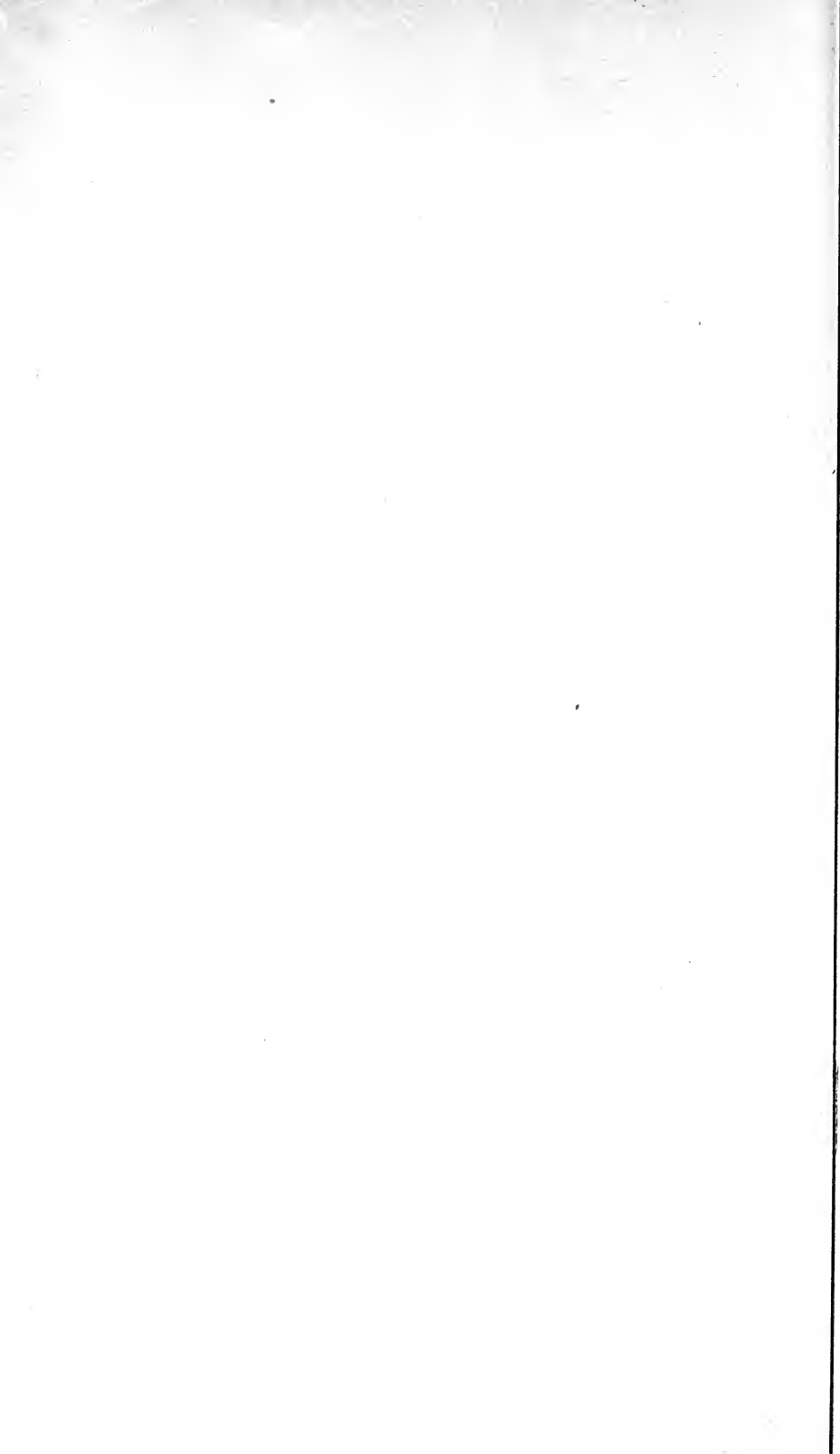

U.C. BERKELEY LIBRARIES



C021104361

THE UNIVERSITY OF CALIFORNIA LIBRARY

