

TS 250 H691

UNIVERSITY OF CALIFORNIA SAN DIEGO E



3 1822 01094 2571

MACHINES and TOOLS  
*Employed in the*  
WORKING of SHEET METALS

BY

R. B. HODGSON,

A. M. Inst., Mech. E.

LIBRARY

UNIVERSITY OF  
CALIFORNIA  
SAN DIEGO

TS 250 H691

UNIVERSITY OF CALIFORNIA, SAN DIEGO E



3 1822 01094 2571

*Bayern*  
*N.Y. city*

**University of California, San Diego**

**Please Note:** This item is subject to recall.

**Date Due**

*TS*  
*250*  
*H691*

**SSE**

MAR 31 1992

MAY 27 REC'D



PUBLISHED ANNUALLY.

# "THE PRACTICAL ENGINEER" POCKET-BOOK.

Price 1s. net ; leather gilt, with Diary, Pocket, and Elastic  
Band, 1s. 6d. net. Postage 2d. extra.

CONTAINS CHAPTERS ON

CHIMNEYS.  
INJECTORS.  
CONDENSERS.  
OIL ENGINES.  
GAS ENGINES.  
STEAM ENGINES.  
STEAM PIPES.  
AUTOMOBILISM.  
STEAM BOILERS.  
CUTTING TOOLS.  
NOTES ON HEAT.

NOTES ON MINING.  
FUEL ECONOMISERS.  
NOTES ON PATENTS.  
LIFTING MACHINERY.  
BEAMS AND PILLARS.  
STRENGTH OF METALS.  
POWER TRANSMISSION.  
HYDRAULIC MACHINERY.  
ELECTRICAL ENGINEERING.  
INDICATORS AND DIAGRAMS.

With numerous Rules, Tables, &c.

---

Price 1s. ; leather, gilt edges, with pocket and elastic band, 1s. 6d.  
Postage to any address at home or abroad, 2d.

# "THE PRACTICAL ENGINEER" ELECTRICAL POCKET-BOOK AND DIARY.

CONTAINS CHAPTERS ON

POWER GAS.  
MAGNETISM.  
ELECTROLYSIS.  
ELECTRIC CRANES.  
ELECTRICAL UNITS.  
DUST DESTRUCTORS.  
POTENTIAL RESISTANCE.  
METHODS OF MEASUREMENTS  
OF CURRENTS.  
ACCUMULATORS AND PRIMARY  
BATTERIES.  
ELECTRIC TRACTION, MINING,  
AND WELDING.

FORMULE FOR MAGNETIC CAL-  
CULATIONS.  
WORKING HYDRAULIC AND  
ELECTRIC LIFTS.  
ELECTRICAL TRANSMISSION AND  
POWER IN FACTORIES  
DESIGN OF DYNAMOS, ALTERNA-  
TORS, AND TRANSFORMERS.  
MODES OF TRANSMISSION BY  
BELTS, ROPES, AND GEARING.  
CONDUIT SYSTEM OF WIRING.  
POWER REQUIRED FOR DRIVING  
SHAFTING AND MACHINE  
TOOLS.

With numerous Rules, Tables, &c.

---

THE TECHNICAL PUBLISHING CO. LIMITED,

287, Deansgate, Manchester ; and all Booksellers.

2D.  
Weekly.

# **THE Practical Engineer.**

2D.  
Weekly.

*Published Simultaneously in London and Manchester every Friday.*

---

## **THE BEST WEEKLY JOURNAL OF MECHANICAL AND MOTIVE POWER ENGINEERING**

**WRITTEN BY PRACTICAL ENGINEERS FOR PRACTICAL ENGINEERS.**

---

The Journal has a large staff of Contributors, of special experience in every branch of Engineering to which it is devoted, so that its readers are kept fully informed with respect to the latest improvements and most modern practice in Steam and Gas Engines, Hydraulic Engineering, Electrical Engineering, Boiler Making, Machine Tool Making, &c.

---

To the TECHNICAL PUBLISHING CO. LTD.,

287, Deansgate, Manchester, England.

Dear Sirs,—Enclosed please find a Post-office order for 10s., for which please send to my address *The Practical Engineer*, a mechanical paper you publish. Our chief engineer, Mr. T. H. McDonald, recommends *The Practical Engineer* as one of the best engineers' papers in the world. Wishing to keep abreast of the times, upon his recommendation I wish to take your paper for one year.—Yours respectfully,

ALBERT SWITZER,

Denver, Colo., U.S.A.

---

### **SUBSCRIPTION 10s. PER ANNUM.**

**PAYABLE IN ADVANCE.**

**Including Free Copy of Pocket-book if ordered direct from Publishers.**

Post free to all parts of the world.

---

THE TECHNICAL PUBLISHING COMPANY LIMITED,

287, Deansgate, Manchester.

JOHN HEYWOOD, 29 & 30, Shoe Lane, London; and Deansgate, Manchester.

And all Booksellers.

MACHINES AND TOOLS EMPLOYED

IN THE

WORKING OF SHEET METALS.

BY

R. B. HODGSON, A.M. INST. MECH. E.,

*Author of "Emery Grinding Machinery."*

---

PRICE FOUR SHILLINGS AND SIXPENCE NET.

---

1903.

THE TECHNICAL PUBLISHING CO. LIMITED, 287, DEANSOATE, MANCHESTER.  
JOHN HEYWOOD, Deansgate, Manchester, and 29 and 30, Shoe Lane, London ;  
SIMPKIN, MARSHALL, HAMILTON, KENT AND CO. LTD., Stationers' Court, London ;  
D. VAN NOSTRAND CO., 23, Murray Street and 27, Warren Street, New York ;  
E. W. COLE, Sydney and Melbourne, Australia ;  
GEO. ROBERTSON AND CO. PROPRIETARY LTD., Melbourne, Sydney, Adelaide, and  
Brisbane ; and all Booksellers.





DEDICATED TO

PROFESSOR HENRY ADAMS,

M. INST. C. E., M. I. MECH. E., F. S. I.,

PROFESSOR OF ENGINEERING AT THE CITY OF LONDON COLLEGE,

TO MARK MY ESTEEM FOR THE

AUTHOR OF THE "HANDBOOK FOR MECHANICAL ENGINEERS,"

AND MY APPRECIATION OF

THE METHODS ADOPTED BY HIM IN HIS CLASSES ON

MECHANICAL ENGINEERING SUBJECTS AT THE

CITY OF LONDON COLLEGE.

## ERRATA.

---

On page 63, line 11, instead of "the limiting diameter, &c.," read "The minimum diameter of any hole in a plate  $t$  inches thick of any material is

$$= \frac{t \times 4 \times \text{the limiting shearing stress,}}{\text{crushing stress of punch}}.$$

On page 94, fig. 96, dimension of base should read "4 $\frac{3}{4}$  in.," not "4 ft. 3 in."

## P R E F A C E .

---

THE scarcity of the literature on Presses and Press Tools is in itself sufficient justification for the publication of these articles, which appeared originally, at intervals, in the columns of *The Practical Engineer*, and are now published in book form at the request of many readers.

The production of tools for the working of sheet metals is a distinctly separate branch from that of engine-fitting and general machine work. It is therefore difficult for an engineer to thoroughly grasp the work of the press-tool maker, unless he has had an opportunity of closely watching the tool work in progress and the subsequent operations performed by the tools in the production of numerous articles made from sheet metals.

This difficulty is largely due to the many technical points of detail connected with the processes through which an article may have to pass before reaching its final stage, which will become obvious upon reading Chapter XI.—Drawing and Re-drawing—and Chapter XIX. on Tool Setting.

The subject embracing, as it does, many industries, including a vast number of separate processes, no systematic treatment has been attempted. As far as possible each section has been taken separately, and where necessary to a complete and thorough understanding of a point under consideration, either a little recapitulation has been deemed advisable, or reference made to the chapter or section where the particular point has been previously mentioned.

The original articles were the result of many years' work, and study of a business which plays an important part in many British industries, and it is hoped that these collective notes in book form will be found useful to engineers, mechanics, manufacturers, and to young technical students, assisting them to overcome some of the difficulties which they may meet with in technical schools and workshops. A few

remarks in reference to the machine tools to be found in every machine shop have been included, to enable the younger readers to better understand the matter contained in those chapters which refer to the manufacture of press tools.

At present very little seems to be known by mechanics in the workshops concerning the work done in either a Fly Press or Drop Stamp. It is therefore hoped that the special chapter devoted to the following subjects—work done in Copying Press, Fly Press compared with the Screw Press, work done by the Stamp Hammer, the reasoning regarding the Hammer Blow—will be readily followed by the student and practical mechanic, who may not have sufficient scientific and mathematical knowledge to follow the reasoning of the more advanced text-books on the subject.

The illustrations used are of a special character, and do not represent every possible type of Power Press. Those selected may be regarded as being good practical examples of modern machines and calculated to be useful to the greatest number of those who are engaged in sheet-metal working industries.

Calculations and definitions have been introduced to enable practical mechanics to readily grasp the point under consideration with the least possible calculation, and at the same time more accurately and quickly than by "rule-of-thumb" methods.

Any suggestion relating either to improvements or additional matter calculated to make this work more complete will be gladly and carefully considered, with a view to the revision of future editions.

The Author takes this opportunity of thanking his numerous friends for their valuable assistance, specially mentioning Mr. Daniel Smith, whose information regarding both machines and tools has greatly assisted him in his work. The Author's best thanks are also due to Messrs. Buck and Hickman, London; Daniel Smith and Co., Wolverhampton; John Rhodes and Son, Wakefield; Taylor and Challen Ltd., Birmingham; W. H. Ward and Co., Birmingham, who, by their kindness in placing at his service electrots of special machines have enabled the text to be illustrated so as to make it more readily understood.

R. B. HODGSON.

54, Westfield Road, King's Heath,  
Birmingham, 1903.

# CONTENTS.

---

CHAPTER I.—MATERIALS AND MEASUREMENT.	PAGES
Introduction—Metal Gauge Tables—Common Sheet Brass—Best Dipping Metal—Alloy Suitable for Cartridge Cases—Worthless Gauges—Imperial Standard Wire Gauge—Whitworth Standard—Old Birmingham Wire Gauge .....	1-7
CHAPTER II.—MICROMETER GAUGES.	
Brown and Sharp Micrometer—Pitch of the Screw—Graduations on the Thimble—Reading the Micrometer—Micrometer Rolling Mill Gauge—Plate Gauges—Internal and External Gauges—Standard Cylindrical Gauges—Limits of Accuracy—Metal Work Defined—Terms Used for Various Presses—Operations Defined by Terms .....	7-21
CHAPTER III.—THE SCREW PRESS.	
Example of Double-sided Fly Press—Details of Screw Press—Gartering the Ram—Formation of the Gartering Nut—Various Methods of Gartering—The Bumping Bit .....	21-30
CHAPTER IV.—FORM OF SCREW PRESS FRAME.	
Frame Casting Screw-cut—Frame Casting Bored to Receive Special Nut in Large Work—Strengthening Stay Rod—Strengthening Press Frame at Back—Position of Stresses in Press Frame—Method of Strengthening the Weakest Point of Casting—The Press Screw—Formation of Screw Thread—Threads and Spaces Compared—Faults Due to Pitch of Screw—Multiple-threaded Screws .....	30-38
CHAPTER V.—A POWER PRESS.	
Example of Power Press—Details of Working Parts—Methods of Driving the Ram—Gear for Guiding the Driving Belt—Adjusting the Ram by Means of Plates—Faults of Cast-iron Clutch—Driving by Means of Steel Pin Through Fly Wheel—Example of Steel Pin Clutch-gear and Counter Shaft .....	38-45

	PAGES
<b>CHAPTER VI.—FAULTY CONSTRUCTION.</b>	
Four Rams Operated Simultaneously—Faults in Construction—Unreliable Method of Erecting—Faulty Method of Driving Ram—Direction of Shaft Rotation—Forces Acting on Ram—Relative Position of Cranks—Coupling the Two Crank Shafts.....	45—52
<b>CHAPTER VII.—DIES AND PUNCHES.</b>	
Forging a Stamp Die—The Solid Steel Die—Die having Wrought-iron Base—Examples of Cylindrical Die and Rectangular Die—Careless Hardening—Per Cent of Carbon in Tool Steel—The Upper Die or Stamp Force—Methods of Attaching Force to Stamp Hammer—Formation of the Force—Punching and Shearing—Formulæ—Theoretical Limits of Thickness that may be Punched—The Angle of Dip on Shears—Punches Built up in Sections—Methods of Fixing Punch—Action of Punching and Shearing—Parallel and Screwed Shank Compared—Methods of Fixing the Bolster—Methods of Fixing Cylindrical Die—Interchangeability of Die and Punch .....	52—79
<b>CHAPTER VIII.—ACCURACY AND DURABILITY.</b>	
Standard Dies and Punches—Preparing a Standard Die—Correcting the Die—Preparing the Punch—Interchangeable Tools .....	80—86
<b>CHAPTER IX.—DIE MAKING BY DRIFT.</b>	
Formation of Drift—Preparing the Die for Drifting—Complete Set of Piercing Tools—Stripper and Guide Plates—Automatic Knockout or Flipper—Blank Cutting Tools—Special Drill Chuck—Automatic Umbrella Stretcher Machine—Construction of Cropping Die .....	87—106
<b>CHAPTER X.—METAL SPINNING.</b>	
Spinning Ornamental Work—Spinning a Rivet Head—Spinning a Sheet Steel Cup—Special Form of Chuck—Extracting Mechanism Actuated by Ram—Setting the Extracting Mechanism—Tools for Bending Wire—Form of Tools for Metal Bending—Press Tools for Wire Cutting.....	106—126
<b>CHAPTER XI.—DRAWING AND RE-DRAWING.</b>	
Radius on Drawing Punch End—Tool Dimensions for Re-drawing—Drawing a Metal Sphere—Formation of Cartridge Shell—Successive Piercing and Blanking—Stamping a Steel Washer—Combination Tools—Construction of Double-action Press—Attaching Punches in Double-action Press—Removing Small Shell from Drawing Punch.....	127—148

## CHAPTER XII.—PRESSES FOR SPECIAL WORK. PAGES

Selection of a Suitable Power Press—Important Points in Press Construction—The Use of a Stay Bolt on a Press—Single-acting Power Press—Geared Single-acting Press—Chief Defects in Single-acting Press—Single-acting Open-back Press—Pressure Plate with Positive Lift—Adjusting the Pressure Plate—Advantage of Balanced Slides.....149—167

## CHAPTER XIII.—DOUBLE-ENDED PRESSES.

Tool Changing in Double-ended Press—Stop Motion Arranged in Ram—Proper Place to Apply the Stop Motion—Dangers of Sliding-key Stop Motion—Details of Metal Shearing Machines—Shearing Machines for Circular Blanks—Cutting Blanks by the Shearing Method .....168—181

## CHAPTER XIV.—ROLLER AND DIAL FEED MOTIONS.

Advantages of the Roller-feed Motion—Construction of Dial-feed Motion—Details of Dial-feed Motion—Important Points concerning the Dial Plate—Application of Roller-feed Motions—Accidents to Operators' Fingers—Unexpected Descent of the Ram—Worm Adjustment for the Ram—Toggle Drawing Press—Armature Disc-notching Machine—Feeding Blanks by Vertical Hopper .....182—203

## CHAPTER XV.—STAMPING.

The Ordinary Stamp—Weight of Stamp Block and Hammer—Advantages of the Double Stamp—Accidents to Stamp Operators—Automatic Drop Hammers—Details of Automatic Drop Hammer—Stamp Hammer Raised by Friction .....204—214

## CHAPTER XVI.—AUTOMATICS AND MACHINE TOOLS.

Selecting Special Automatics—Machines Used for Tool-making—Lathe for Boring a Stamp Die—Screw-cutting a Punch Shank—The Use of a Shaping Machine—General Purpose Drilling Machine—Method of Drilling a Cutting Die—Use of the Profiling Machine—Profiling a Cutting-out Bed—Special Machine Vice—Quadrant Dividing Head Stocks .....215—235

## CHAPTER XVII.—TOOLS AND JIGS FOR REPETITION WORK.

Types of Lathe Test Indicators—Method of Applying Test Indicators—Accurately Boring Tools and Jigs—Accurate Methods of Drilling by Jig—Setting Work upon a Lathe Face Plate .....236—246

## CHAPTER XVIII.—INTERCHANGEABLE MACHINE PARTS.

Preparation of an Accurate Boring Jig—The Use of a Boring Jig.....246—251

	PAGES
<b>CHAPTER XIX.—PRESS TOOL SETTING.</b>	
Necessity of Correct Tool Setting—Troubles Caused by Careless Tool Setting—Common Stripper Arrangements and Waste Work—Correct Setting of Punch, Bed, and Stripper—The Stop Peg on a Cutting Bed—Guide Plate Fixed to Cutting Bed—Hardening and Tempering—Heating Steel Uniformly for Hardening—Hardening and Tempering at One Heat—Hardening and Tempering Dies and Punches—Hardening and Tempering a Slitting Saw—Annealing Sheet Metals—Table of Colours for Tempering—Annealing Dies and Tools—Annealing Dies in Slaked Lime .....	251—273
<b>CHAPTER XX.—BLANK DIMENSIONS.</b>	
Three Methods for Fixing Blank Dimensions—Mensuration of Sheet metal Surfaces—Measuring an Article in Sections—Clipping of Stamped Articles.....	274—286
<b>CHAPTER XXI.—PRESSURES FOR CUTTING BLANKS.</b>	
Pressures Required to Shear Iron Bars—Factor of Safety for Shearing Machine—Definitions of Terms—The Power of Presses and Stamps—Work in the Copying Press - Work of Fly Press—Fly Press Compared with Copying Press—Work Done by a Stamp Hammer—Accumulated Energy Stored in Hammer .....	286—302



MACHINES AND TOOLS EMPLOYED  
IN THE  
WORKING OF SHEET METALS.

---

INTRODUCTION.

FOR some years past the author has experienced a constantly-recurring need of a practical treatise on this important class of machine tools, as well as of the processes used in the working of sheet metal, and has found that English writers on mechanical subjects appear to have generally neglected this branch of engineering. It is true that in describing certain processes incidental references are made to some special form of press devised by them, yet there does not appear to be any treatise dealing with the subject in a systematic manner. American writers also have apparently neglected this subject, save as a subsidiary section of a work dealing with other branches of mechanical engineering, and then only in books which are published at a price which is generally prohibitive to the ordinary mechanic or student, whose means are limited.

A possible reason for this general neglect may be found in the multiplicity of articles that are now being manufactured from sheet metal, each of which possesses its

own individual shape, often involving a large number of steps or operations before it is attained. Thus it has become to a very large extent a branch of engineering that does not lend itself to a systematic treatment like many others, except at the hands of a specialist. The author has devoted many years to this branch of engineering, in which, in addition to operating the presses when made, he has had frequent occasion to design both the press and the tools required by it for special purposes. In consequence of the lack of any text-book of reference, he has found himself constantly going over the same ground as other engineers had previously, entailing in consequence the loss of much time; hence he ventures to think that in collecting together the knowledge obtained in his own practice, supplemented by an account of the results that have been already achieved in the use of these important labour-saving machines in the reduction of the costs of manufacture, a useful work will be the result.

A systematic treatment of the subject seems impossible, so no attempt will be made in this direction, but a description of one or two generally used presses will be dealt with at first, showing how the simpler results are obtained, afterwards passing on to the consideration of the more complex operations, in which more than one stage is required to complete the work. By thus gradually building up from the simple form to the more complex, it is hoped that the reader will be able to follow along easily the gradual development of a most interesting class of tools, which the author ventures to think will be appreciated more and more by engineers, who are being pressed hard to produce cheaply everything that they manufacture in order to hold their own in the commercial race.

## CHAPTER I.

## MATERIALS AND MEASUREMENT.

THE metals in general use are sheet brass, copper, tin plate, iron, and steel, rolled to the required thickness before reaching the workshop to be cut into blanks and formed into the required shapes. In most cases the various metal alloys are mixed according to the requirements of the manufacturer, but for brass work a commercial metal is in use known as "Best dipping metal," this being mixed so as to be most suitable for dipping or gilding. Further, the metal known by this name stands more torturing whilst being worked than the ordinary common sheet brass, the reason being that it contains a greater percentage of copper. Some of the most important articles produced from brass are ammunition cases, which require a special alloy, as well as great care and judgment in arranging the number of processes and annealings, to enable the case to be worked into shape without rupture. The proportion of the metals forming the alloy suitable for cartridge cases is 70 per cent copper and 30 per cent zinc.

The metal sheets are usually measured or gauged by a wire or metal gauge. There are between twenty and thirty different wire or metal gauges in actual use, each gauge being considered by some manufacturer as the standard gauge that should be used for their own particular work. There appears to be no reason why one standard gauge should not be used throughout the whole industry, and if this could be arranged, much loss of time, trouble, and inconvenience to which manufacturers are now subject would be prevented. Many of the gauges now in use are practically worthless on account of the misleading and peculiar manner in which their sizes run. The appended table represents the gauges most frequently found in use by the trade.

It is customary to speak of the thickness of a sheet or wire as, say, No. 7 gauge, which means that the thickness is

A	B	C	D	E	F	G	H	I	J	K	L
Descriptive number.	Imperial legal standard wire gauge.	Stubbs wire gauge.	Whitworth standard wire gauge.	Metric equivalent.	Birmingham wire gauge, chiefly for iron sheets.	Fractions of an inch for Gauge F.	Flat iron gauge. South Staffordshire Iron-Masters' Association B.G.	Fractions of an inch for Gauge H.	B.W.G. The old Birmingham wire gauge, traced back for 45 years.	The old Birmingham metal gauge for brass.	American, or Brown and Sharp.
0/7	.500	....	....	12.700	....	....	....	....	....	....	....
0/6	.464	....	....	11.785	....	....	....	....	....	....	....
0/5	.432	....	....	10.973	....	....	....	....	....	....	....
0/4	.400	.454	....	10.160	....	....	....	....	....	....	.46
0/3	.372	.425	....	9.449	....	....	.500	1/4	....	....	.40964
0/2	.348	.380	....	8.839	....	....	.4452	....	....	....	.3648
0	.324	.340	....	8.220	....	....	.3061	....	....	....	.32486
1	.300	.300	.001	7.620	.3125	1/8	.3532	....	.206	.0085	.2893
2	.276	.284	.002	7.010	.28125	....	.3147	....	.270	.0095	.25763
3	.252	.259	.003	6.401	.25	1/4	.2304	....	.256	.0105	.22942
4	.232	.238	.004	5.893	.234375	....	.250	1/2	.240	.012	.20431
5	.212	.220	.005	5.385	.21875	....	.2225	....	.213	.014	.18194
6	.192	.203	.006	4.877	.203125	....	.1981	....	.200	.016	.16202
7	.176	.180	.007	4.470	.1875	1/2	.1764	....	.183	.019	.14428
8	.160	.165	.008	4.064	.171875	....	.1570	....	.167	.0215	.12649
9	.144	.148	.009	3.658	.15625	....	.1398	....	.150	.024	.11443
10	.128	.134	.010	3.251	.140625	....	.1250	1/2	.136	.028	.10189
11	.116	.120	.011	2.916	.12518	....	.1113	....	.121	.032	.090742
12	.104	.109	.012	2.642	.1125	....	.0991	....	.110	.035	.080908

A	B	C	D	E	F	G	H	I	J	K	L
13	.092	.095	.018	2.837	.10	$\frac{1}{16}$	.0882	....	.006	.088	.071961
14	.080	.088	.014	2.032	.0875	....	.0785	....	.086	.043	.064084
15	.072	.072	.015	1.820	.075	....	.0699	....	.074	.048	.057068
16	.064	.065	.016	1.626	.0625	$\frac{1}{16}$	.0625	$\frac{1}{16}$	.067	.051	.05082
17	.056	.058	.017	1.422	.05625	....	.0556	....	.060	.055	.045257
18	.048	.049	.018	1.219	.05	$\frac{1}{20}$	.0495	....	.051	.059	.040808
19	.040	.042	.019	1.0116	.04375	....	.0440	....	.046	.062	.08589
20	.036	.035	.020	.914	.0375	....	.0392	....	.039	.065	.031961
21	.032	.032	....	.818	.034875	....	.0349	....	.038	.069	.028462
22	.028	.028	.022	.711	.03125	$\frac{1}{32}$	.03125	$\frac{1}{32}$	.030	.073	.025347
23	.024	.025	....	.610	.028125	....	.02782	....	.027	.077	.022571
24	.022	.022	.024	.559	.025	$\frac{1}{40}$	.02476	....	.024	.082	.0201
25	.020	.020	....	.508	.02344	....	.02204	....	.022	....	.0179
26	.018	.018	.026	.457	.021875	....	.01981	....	.020	....	.01594
27	.0164	.016	....	.4166	.020812	....	.01745	....	.0185	....	.014195
28	.0149	.014	.028	.3759	.01875	....	.015625	$\frac{1}{64}$	.017	....	.012641
29	.0136	.013	....	.3454	.01719	....	.0139	....	.016	....	.011257
30	.0124	.012	.030	.3150	.015625	....	.0128	....	.015	....	.010025
31	.0116	.01	....	.2946	.01406	....	.0110	....	.014	....	.008928
32	.0108	.009	.032	.2743	.0125	$\frac{1}{80}$	0098	....	.013	....	.00795
33	.0100	.008	....	.2540	....	....	.0087	....	.012	....	.00708
34	.0092	.007	.034	.2387	....	....	.0077	....	.011	....	.006304
35	.0084	.005	....	.2194	....	....	.0069	....	.010	....	.005614
36	.0076	.004	.036	.1980	....	....	.0061	....	.009	....	.005
37	.0068	....	....	.1727	....	....	.0054	....	.008	....	.004453
38	.0060	....	.038	.1524	....	....	.0048	....	.007	....	.003965
39	.0052	....	....	.1321	....	....	.0048	....	.0065	....	.003581
40	.0048	....	.040	.1219	....	....	.00386	....	.006	....	.003144

that represented by the width of a slot against that number in some gauge. These numbers are given in the first column of the table, and the actual thickness in terms of an inch will be found for the several gauges in their respective places.

The second column (B) gives the values for the Imperial standard wire gauge, which is the legal standard in this country by the Weights and Measures Act of 1878, and as a consequence no contracts or dealings can be legally enforced that are made contrary to this standard.

The South Staffordshire Ironmasters' Association held a meeting in Birmingham on the 28th February, 1884, and by resolution adopted as their standard that shown in column H.

In column D is shown the proposed standard by the late Sir Joseph Whitworth, which is, as far as one can see, the only rational system contained in the table. It should be noticed that the number of the gauge is also the number of thousandths of an inch that measure the actual thickness of the sheet. It ought also to be noted that as the number of the gauge gets greater so does the dimension increase, whereas with the other standards the higher numbers have the smaller dimensions. The true solution of the gauge question appears to be in the adoption of the Whitworth standard, and in place of the present misleading plate gauges the general adoption of a micrometer graduated to read to  $\frac{1}{1000}$  of an inch for the determination of the actual gauge in each instance.

The old Birmingham wire gauge, which can be traced back for 45 years, is shown in column J, and the figures shown in column K refer to that known as the Birmingham metal gauge.

The gauges as per columns B, C, D, F, H, J, K, L are all in use. Manufacturers who roll metal for the trade have, consequently, an understanding with each of their customers as to which gauge their metal must be rolled to, and this makes it necessary that each lot of metal ordered be passed through the rolling mills in a separate batch.

A few moments' consideration will suffice to show how the use of these different gauges cause troubles and inconvenience to manufacturers. It seems that the only course open to

manufacturers generally is to fall in line with the requirements of their customers upon the gauge question.

The figures given in column L are those of the American standard wire gauge. The want of uniformity in common wire gauges led the Brown and Sharpe Manufacturing Co., at the request of the principal American wire drawers and brass workers, to prepare this standard, which was worked out so that the variation between the different numbers on the wire gauge should not be so irregular as those numbers on the Stubs wire gauge. Previous to the introduction of this new American standard the Stubs gauge was the one generally used in America, but the Brown and Sharpe gauge has now taken the place of the Stubs gauge in America. The Brown and Sharpe Manufacturing Co., as gauge makers, have earned their reputation for high-class work, in accuracy and finish, and a special feature of their wire gauges worthy of attention is that, in order to familiarise the users of the gauge with the decimal equivalents of the gauge numbers, they stamp on the back, opposite to the regular gauge numbers, the decimal equivalents expressed in thousandths of an inch.

---

## CHAPTER II.

### MICROMETER GAUGES.

THE Brown and Sharpe micrometer gauges form convenient and accurate tools for external measurements. They are made in various sizes and styles to measure up to 24 in., and are graduated to read English measure to thousandths and ten-thousandths of an inch; they are also made to read to hundredths of a millimetre. The decimal equivalents stamped on the frame are convenient for the immediate expression of readings in eighths, sixteenths, thirty-seconds, and sixty-fourths of an inch.

The chief mechanical principle embodied in the construction is that of a screw free to move in a fixed nut, an opening to receive the work to be measured is afforded by

the backward movement of the screw, and the size of the opening is indicated by the graduations.

Referring to fig. 1, the pitch of the screw C is forty to the inch, the graduations on the barrel A, in a line parallel to the axis of the screw, are forty to the inch, and figured 0, 1, 2, etc., every fourth division. As these graduations conform to the pitch of the screw, each division equals the longitudinal distance traversed by the screw in one complete revolution, and shows that the gauge has been opened one-fortieth or twenty-five-thousandths of an inch. This opening (between B and C) in fig. 1 is three divisions exactly, and is therefore =  $3 \times 1/40$ th of an inch, or seventy-five-thousandths.

The bevelled edge of the thimble D is graduated into twenty-five equal parts, figured every fifth division, 0, 5, 10, 15, 20, each division, and when coincident with the line

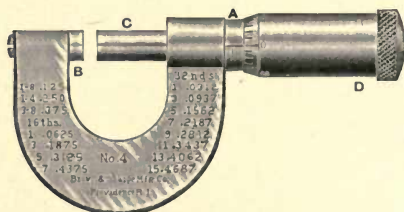

FIG. 1.

of graduations on the barrel A, indicates that the gauge screw has made one-twenty-fifth of a revolution, and the opening of the gauge increased one-twenty-fifth of twenty-five-thousandth = one-thousandth of an inch.

Hence to read the gauge, multiply the number of divisions visible on the scale of the barrel A by 25, and add the number of divisions on the scale of the thimble D, from zero to the line coincident with the line of graduations on the hub. For example, as the gauge is set in the figs. 2 and 5 there are three whole divisions visible on the barrel; multiplying this number by 25, and adding five, the number



of divisions registered on the scale of the thimble, the result ( $3 \times 25 = 75$ , then  $75 + 5 = 80$ ) is eighty-thousandths of an inch. After a little practice these calculations are readily made mentally.

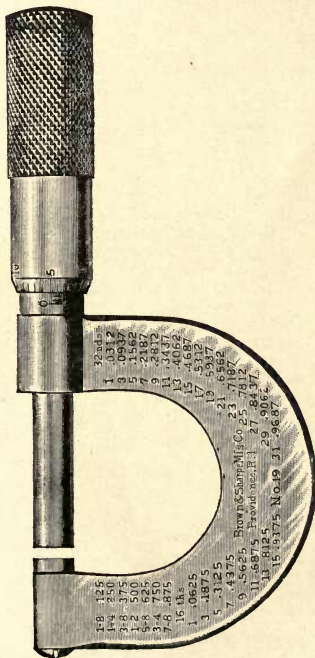

FIG. 2.

The micrometer is shown full size at fig. 2, and measures all sizes less than an inch by thousandths of an inch; whilst the micrometer shown by fig. 3 is graduated to read

to ten-thousandths of an inch. Upon the ends of the screw C, and the face of B, falls all the wear due to actual use, and in order to provide for this, B is a tightly fitting

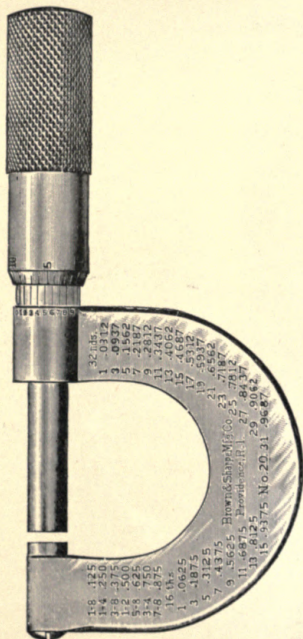

FIG. 3.

screw, which may be advanced from time to time as required. The slot for the screw-driver is shown to the left in figs. 1, 2, and 3. Thus, every gauge ought always

to read accurately the dimension of the opening between B and C, no matter how constantly they are in use. The readings of ten-thousandths of an inch are obtained by means of a vernier, or series of divisions on the barrel of the gauge, as shown in fig. 4. These divisions are ten in number, and occupy the same space as nine divisions on the thimble, and for convenience in reading are figured 0, 1, 2, 3, 4, 5, 6, 7, 8, 9, 0. Accordingly, when a line on the thimble coincides with the first line of the vernier, the next two lines to the right differ from each other one-tenth of the length of a division on the thimble, the next pair of lines in order to the right differ by two-tenths, etc., as

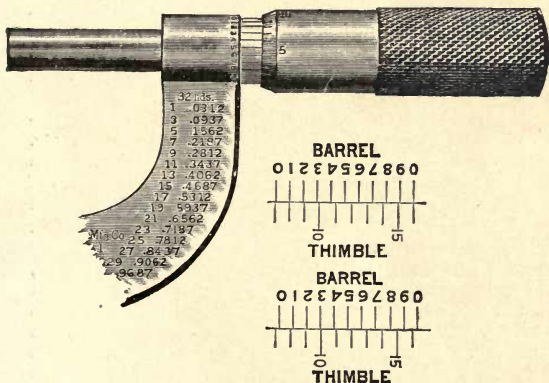

FIG. 4.

shown by the upper illustration of the two enlarged views of the graduations on barrel and thimble. Since each of the divisions thus measured are equal to one-tenth part of a division on the thimble, it follows that they are each equal to one-tenth of one-thousandth of an inch—i.e., one ten-thousandth of an inch. Hence, when the gauge is opened the thimble is turned to the left, and when a division passes

a fixed point on the barrel, it shows the gauge has been opened one-thousandth of an inch. Hence, when the thimble is turned so that a line on the thimble coincides with the second line (end of the first division) of the vernier, the thimble has moved one-tenth of the length of one of its divisions, and the gauge opened one-tenth of one-thousandth, or one ten-thousandth of an inch. When a line on the thimble coincides with the third line (end of second division) of the vernier, the gauge has been opened two ten-thousandths of an inch, etc.

In the lower diagram of the vernier in fig. 4, where the fourth line marked 10 on the thimble coincides with that on the barrel marked 3, which is the third division of the vernier, shows the position which indicates three ten-thousandths of an inch. To read this gauge, note the thousandths as usual, then the number of divisions on the vernier, commencing at 0, until a line is reached with which a line on the thimble is coincident.

If the second line reached is figured 1, add one ten-thousandth, if it is figured 2, two ten-thousandths, etc. Gauges graduated to read to ten-thousandths should not be used on ordinary fine mechanical work, as in instruments of this class wear perceptibly affects the readings, which would be of comparatively slight consequence in gauges reading only to thousandths. These gauges should therefore only be used as a final test for very important accurate work, and their use requires a much more delicate sense of touch than in the case of the thousandth gauges to obtain exact readings. For such fine adjustments, these gauges are often fitted with a friction clutch for moving the screw, so that the same degree of tightness is always obtained. This is very important when measuring substances that are soft and easily indented to the extent of one ten-thousandth of an inch.

#### MICROMETER ROLLING MILL GAUGE.

A micrometer gauge, which has recently been introduced for the use of sheet metal workers, is shown by fig. 5, and it is well adapted for this class of work. The gauge screw is encased and protected from dirt or injury, and means of

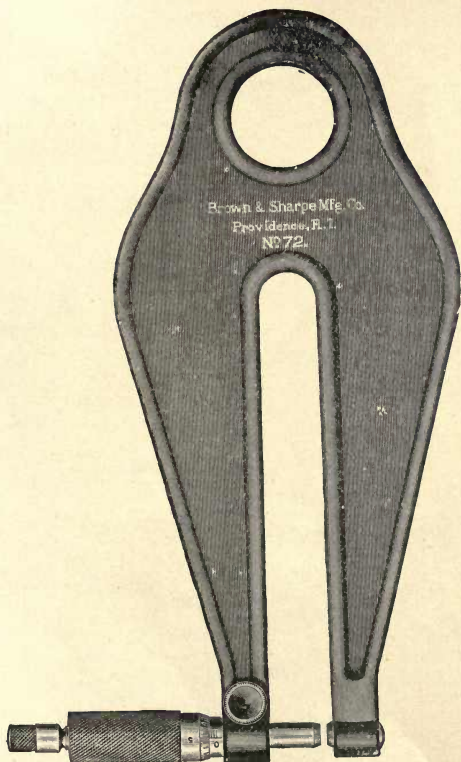

FIG. 5.

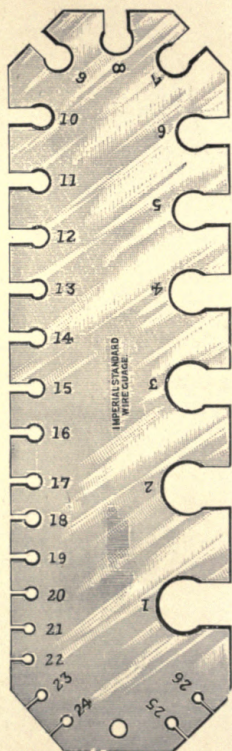

FIG. 6.

adjustment are provided to compensate for wear. The opening in the frame is about 6 in. deep; this is a very important feature, as it enables sheet metal to be more accurately measured than would be possible with an ordinary micrometer. This great depth in the frame makes it possible to measure or gauge the metal at various points in the width of the sheet, which could not be reached with the ordinary pattern of micrometer gauge.

The British standard wire gauges in three patterns are seen at figs. 6, 7, and 8—the oblong, the double circular, and the single circular respectively. The American standard wire gauge shown in fig. 9 is that gauge adopted by the American

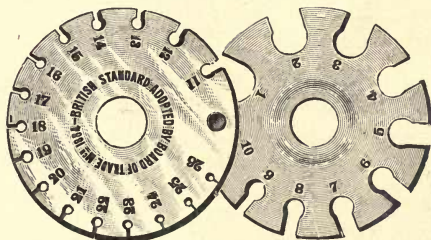

FIG. 7.

brass manufacturers, January, 1858 (see the figures given in column L of gauge table), in place of the Stubs wire gauge. This American gauge, as previously mentioned, has the decimal equivalents stamped upon the back in thousandths of an inch.

This pattern of gauge is much inferior to the micrometer type. It is not always clear which of the several standards they actually represent, whilst as often as not the faces of the openings are anything but parallel, and in consequence there is some choice left to the user to determine which place gives the actual gauge. They serve, however, as a rough guide to the thickness of the plate or the diameter of a wire; but it must be borne in mind that measurements made by it can only be *approximate* at the best, for it is quite

impossible to determine how much larger or *smaller* a plate or wire is than the nearest opening that may be found in the gauge. It is to be noticed that there is no way of taking up the wear that must inevitably result after the gauge has been in use for a time.

#### INTERNAL OR EXTERNAL GAUGES.

The standard internal and external cylindrical gauges, fig. 10, and the internal and external limit gauges, fig. 11, are invaluable where accurate production of duplicate parts

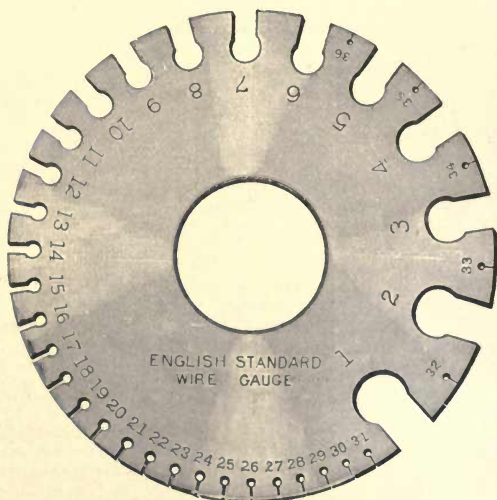

FIG. 8.

of machinery or tools are required. The value of these gauges are well understood in all first-class workshops, though they have not been used to anything like the extent



that they should be in the average works requiring to duplicate machine parts. The standard cylindrical gauges are hardened, ground, and lapped accurately to the size stamped upon them.

Where work has to be made interchangeable, for success it is obviously necessary to lay down the limits of accuracy

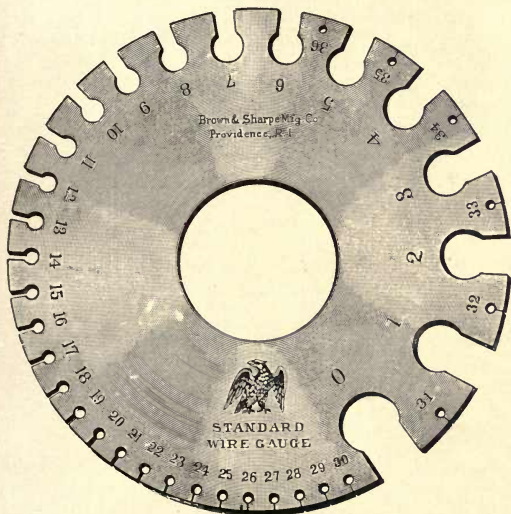

FIG. 9.

within which the work must be done. Thus, suppose the case of a piston rod for a steam engine as an example of this method of working be taken, the rod must in the cylindrical part be made a *certain size* to ensure its working, without heating the gland, and all the glands must be *similarly bored* within certain limits, or they will be either tight or slack on a rod. Now, for the glands, a gauge would be prepared like

the internal gauge shown in fig. 11, and every gland before being passed into the manufactured stores would have to be such a size that whilst one end would go in the other end would not enter. Thus it is obvious that the size of the hole must be greater than 1.249 in., and less than 1.251 in.—that is, the bore is  $1\frac{1}{4}$  in. within *one-thousandth* of an inch. Closer limits, if required, might be specially arranged, although for all ordinary cases this limit would be amply sufficient. In a like manner gauges would have to be made for the piston rod, so that whilst one ring would slip on and be equally tight anywhere, the smaller ring would not go on.



FIG. 10.—Internal.



FIG. 10.—External.

In fig. 11 the external gauge is shown with two parallel jaws, so that any part of the rod can be tested if either a tight or slack place be found when passing the ring gauge along it. By making every rod and gland to gauges in this way, it is *absolutely certain* that any rod and gland that may chance to be found in the stores may be relied upon to work satisfactorily together. The whole business of the engineer is to produce parts that will work together satisfactorily, and to do this he is constantly making working fits of his rods and glands; but instead of determining this allowance once for all in the form of limit gauges, he prefers to do it, as a rule, in pairs; thus at any time there is an

PLATE GAUGES.

opportunity for some one or other to alter the "difference" allowed, and to make it either too tight or slack.

Gauges of this type are stamped with the words "go on" and "not go on" for external work, "go in" and "not go in" for internal work (see fig. 11), and as the two ends are

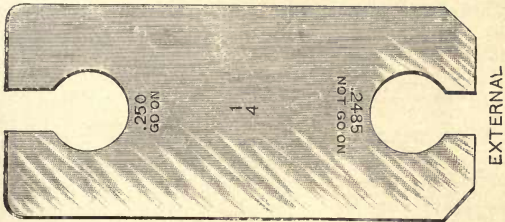

FIG. 11.—External.

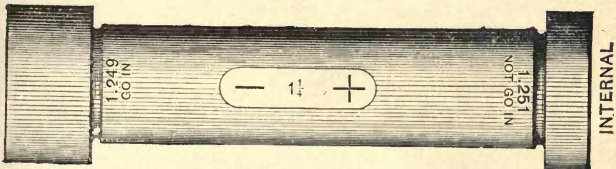

FIG. 11.—Internal.

of different shape the operator quickly learns to distinguish the large from the small end without referring each time to the legend stamped upon the gauge, after having satisfied himself that he has the proper one for his particular job. In making or using limit gauges the degree of accuracy required governs the variations between the two ends of the gauge in thousandths or fractions of a thousandth of an inch, as the case demands.

The object of the metal worker is to produce a certain shaped article from a flat thin plate, and in consequence the material of the plate must be squeezed, forced, or stretched, as the case demands, into the given form. When the operation is

carried out by hand the principal tools made use of are the hammer, some form of anvil, together with some templates giving the peculiar outlines called for by the design, to which the workman refers from time to time in the progress of his work. The action of the hammer upon the material is to stretch the plate locally—that is, where the blow is given; there the plate is slightly thinned, and there will be in consequence a change of form. In the case of sheet iron or steel the act of hammering must be carried on upon the hot plate only, and if the hammering is carried on after the plate has cooled down below a certain limit the material will be damaged. Particularly is this the case with some qualities of steel. Some other metals may be worked to a certain point cold, but must be annealed at intervals to remove the brittleness produced by the hammering. To facilitate this process of shaping cast-iron blocks are used, suitably formed, upon which the sheet is laid and gradually worked into its hollows by means of the hammer, &c. But the operations by hand labour must of necessity be tedious, requiring much skill on the part of the workman, which can only be acquired after many years' constant effort, with the result that the costs of production must be very heavy.

Under the stimulus of increasing competition the aid of mechanical tools has been sought, initially possibly mainly with a view to reducing the heavy costs of assistant labour required by those engaged in the working of such heavy plates as are required in the manufacture of the steam boilers. The weight of these plates is very great, even in the case of small boilers, and the operations of flanging and shaping them makes it necessary to provide each workman with a squad of assistants to manipulate heavy hammers, and to move the plate from time to time into the furnace and back again into the required position for flanging, &c. From these causes the tools for pressing the flanges into shape, for punching holes, and rolls for bending are absolutely necessary in every well-equipped boiler shop to-day.

But whilst in the case of heavy work the use of tools has been common for some time past, the case is somewhat different in workshops where the work is of a much lighter description. The better knowledge that we possess of the

"laws of flow" of metals under pressure has shown engineers the limitations under which materials can be successfully forced into special shapes by pressure.

One of the earliest machines which the metal worker used was probably one which enabled him to stamp a pattern upon metal blanks at one operation, instead of slowly cutting the same by hand. The operation of squeezing or pressing gave the name to the tool which now embraces an innumerable number of special operations.

The term "press," as applied to metal work, may be any machine capable of altering the form of any body by squeezing, forcing, or crushing. The machine naturally takes a great variety of forms, and is often classified according to its construction and the source and nature of the power required for its working. For instance, the terms single-sided press, double-sided press, lever press, foot press, hand press, screw press, fly press, toggle press, crank press, power press, hydraulic press, &c., and numerous other names are in general use.

Then, in other cases, the name of the press depends upon the special operations that it is intended to perform, and of these shearing, punching, forming, bending, embossing, coining, &c., are familiar examples. Thus the press is classified in actual practice on several lines, each of which has its advantages. It is the intention of the author to take for the first example the simplest form and the most commonly used of all the presses as the starting point from which the student and mechanic alike may study the development of the modern machines.

*and  
Mex  
500  
hop  
hydraulic*

*single-sided  
power  
Kovach  
cogging*

## CHAPTER III.

## THE SCREW PRESS.

THIS press is also known as the fly press, since advantage is taken of the kinetic energy stored in the rotating mass of the "fly" operating the screw. In fig. 12 is shown the elevation of the frame, together with a part plan and section of the standard. The base B is square in plan, provided with holes for fastening down in place—usually on a bench; the table or upper part is circular in plan, and is planed or surfaced level, to take the bolster or bottom die. When small work is being executed, then a false bottom (fig. 17) is placed in the recess M, which, in its turn, supports the bottom die. The frame is machined to accurately guide in a vertical direction the ram R, which is kept in its place by the strips S. The ram R (which is sometimes called the bolt or slide) carries the upper die at its lower end, and is moved vertically by means of the fly F, fig. 13, which is attached to the upper end of the screw, fig. 14. The screw works in a nut fitted in the boss H, seen in the upper part of the press frame in fig. 12. The dimensions of the frame will indicate the proportions generally adopted in a tool of this capacity. The screw collar, fig. 18, is screwed on the press screw, fig. 14, being secured by means of a set screw, the lugs A and B being drilled for this purpose. The hole in B is tapped, whilst that in A is drilled slightly larger than the set screw, so that the collar is jammed in any required position by simply tightening up the set screw. This collar, when in position, acts as a stop for the press screw by bumping upon the top of the boss H on the frame, fig. 12. The lower end of the screw, fig. 14, is reduced at D to take the split nut shown in fig. 15. This nut is cut in half along a diameter, so that it can be placed in position; the upper nut, which is large enough to pass over the collar K in the press screw, is then screwed in to hold it in place. In fig. 15 the lock nut is shown screwed on, holding the two halves of the nut in position. The lower part of this nut is then screwed into

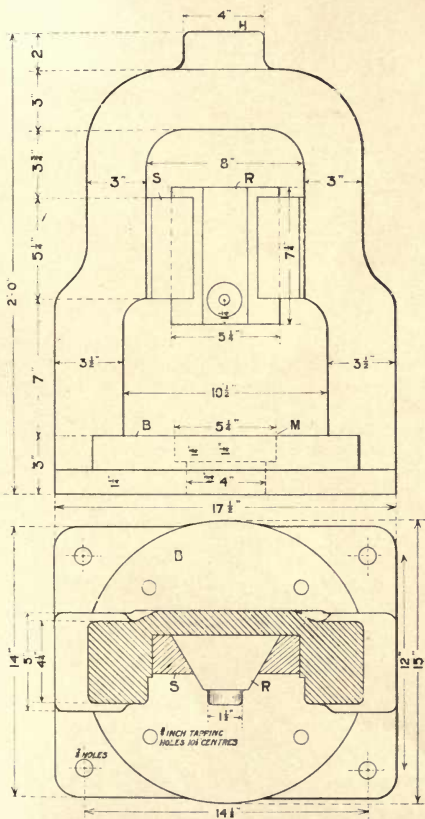

FIG. 12.

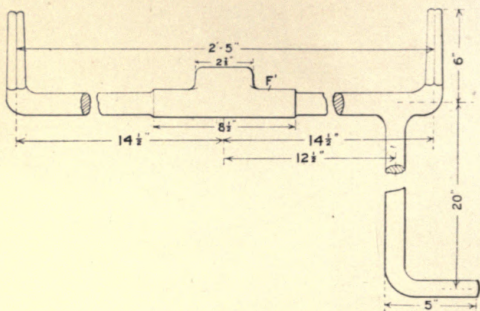

FIG. 13.

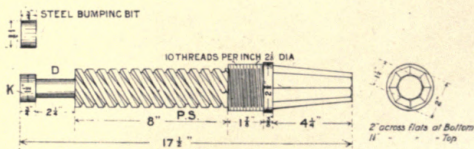

FIG. 14.

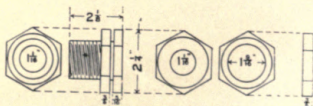

FIG. 15.

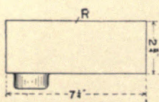

FIG. 16.

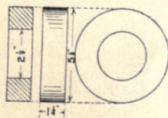

FIG. 17.



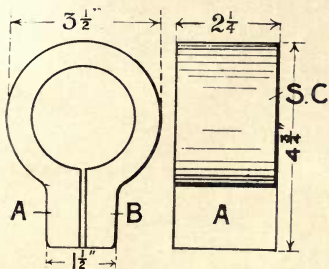

FIG. 18.

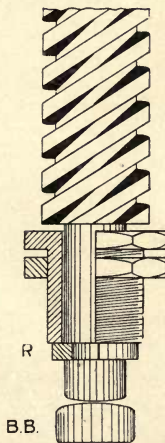

FIG. 19.

the upper end of the ram R, figs. 12 and 16, and the whole locked together by tightening the lock nut down on the ram.

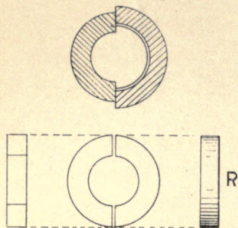

FIG. 20.

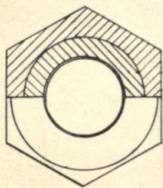

FIG. 21.

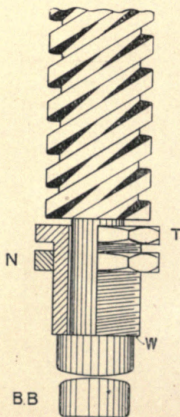

FIG. 22.

In the bottom of the hole in the top of the ram, the hardened steel disc B B, fig. 14, is dropped, and this takes

the thrust from the lower end of the screw K, which is also hardened. It is called the "bumping bit," and takes up the thrust of the blow, which might otherwise damage the screw thread of the split nut. The clearance allowed is clearly shown at T in fig. 22; thus the only work that has to be done by the screwed nut is that of lifting the ram and die ready for the next stroke. Connecting the screw to the ram is known as "gartering."

In presses of common make this split nut is cast in malleable iron, which quickly wears away at W, fig. 22, but in first-class work these nuts are made of steel, in the

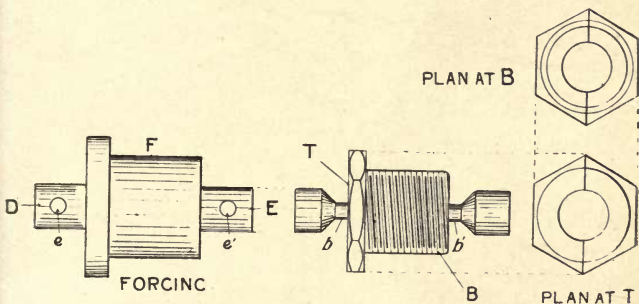

FIG. 23.

following manner, viz. : A steel forging F, fig. 23, is made both longer and larger in diameter than the actual finished nut. It is then cut through longitudinally (see D, E), after which the faces of each half of the forging are planed perfectly flat, then clamped together, and two holes  $e, e'$  are drilled. The halves are then riveted together, centred, turned, screw cut, a hexagon head milled on, and their ends reduced as shown at  $b, b'$ . The nut is then screwed into a special chuck on a lathe. End  $b$  is now cut off, and the hole bored. The boring of the hole removes the end  $b'$ . This completes the operation. The split nut is now completed by hardening the end B, which is afterwards ground true. At fig. 19 is

shown another method of gartering, in which the end of the screw, after being turned parallel, is grooved by a square parting tool, and a ring inserted. This ring is split, so that the two halves may be inserted into the groove. A third method of gartering is shown at figs. 24 and 25, which is the

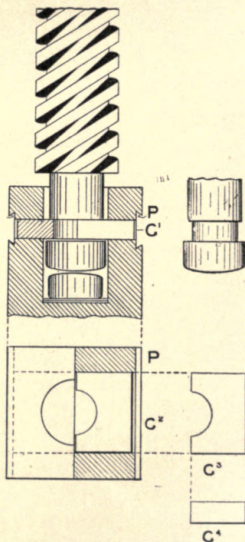
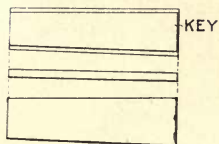

FIG. 24.

old method for the square ram. After the hole has been bored in the top of the ram, to take the end of the screw, the ram is slotted, to take the two halves of the garter G, after which two taper key-ways are planed in two opposite sides of the ram, and into these are driven taper keys, to prevent the garters from slipping back out of place. A modified

K.F.



K.B.

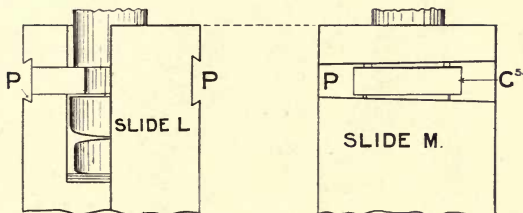

FIG. 25.

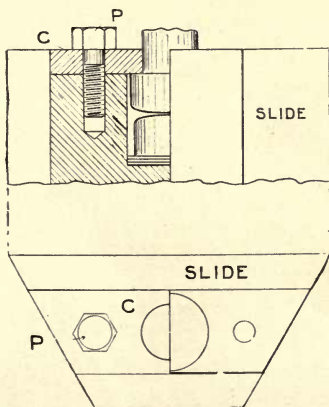

FIG. 26.

form of this method of gartering is shown at fig. 26, which is to plane a broad key-way straight across the top of the ram, sliding the two halves into the key-way, and fastening them down by a set pin P.

The ram shown at fig. 26 is the shape now used extensively for the screw press, and when adopted the edges of the garter are planed at an angle, to prevent any great strain coming upon the head of the pin P, to prevent the head being forced off the pin. The ends of the bumping bit, screw, split nut, or ring will, after being sometime in use, wear away. In the case of the gartering methods shown in figs. 19 and 22 the slack or play could be easily taken up or adjusted by screwing the split nut further into the bolt; but in the case of gartering methods shown at figs. 24, 25, and 26 the slack or play would be taken up by inserting thin sheet steel blanks, as shown in position underneath the bumping bit.

---

## CHAPTER IV.

### FORM OF SCREW-PRESS FRAME.

THE most common form of double-sided screw press is shown at fig. 27, in which the top of the frame casting terminates in a boss B, which is bored and threaded or screw-cut to receive the screw attached to the ram. In large presses a better plan is to bore a parallel hole through the top of the frame casting (see fig. 28), and into this hole fix firmly a nut through which the screw can work. This nut has a collar D on one end, and is screwed at the other end *a*. It is made a tight fit in the frame, being forced into position. A lock nut *b* holds the main nut in position, the face of lock nut being screwed down upon the boss of casting C. When the press is being operated the strain or thrust is taken between the face of the bottom of the casting at E and the collar D.

The single sided screw press is shown at fig. 29. The action of the tools in a single-sided press tends to spring

the frame by an amount varying with the character of the operation performed. They are usually strengthened by either joining K to L by an arm cast in place, or by means

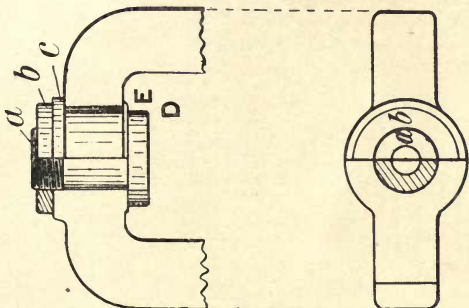

FIG. 28.

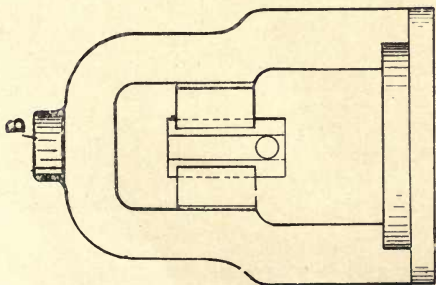

FIG. 27.

of a rod of round iron. There are, however, certain classes of work requiring the front of the press to be entirely unobstructed, and in such cases failure of the press frame

frequently occurs by fracturing at the point marked A, B. These breakages happen more frequently than many mechanics would imagine, even when employed upon comparatively light work. Where these breakages occur a good method is to cast on the press a strong rib shown at R, which, adding very little to the weight of the press, gives strength where strength is required.

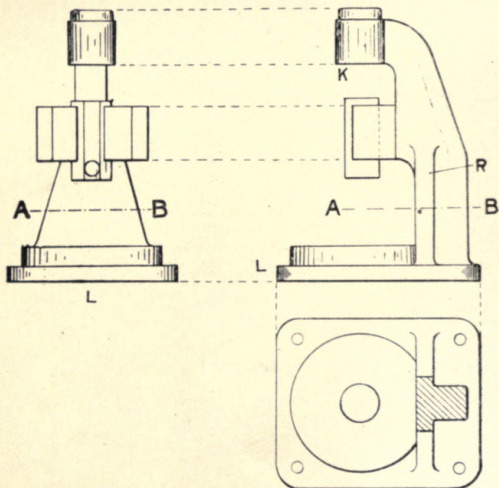

FIG. 29.

Other suitable sections are shown in fig. 30, the selection in any given machine depending upon questions of manufacture and the peculiar uses to be made of the machine. The student of mechanics should notice that this section is actually strained by a bending moment and a tensile stress, due to the load more or less suddenly applied, according to



the character of the operation being executed. The stresses produced are not exactly known, because the load is a *line* one, and a large factor of safety must necessarily be employed, allowing for the fact that the material is being repeatedly strained by a load rapidly varying from zero up to the maximum, and back again to zero. Under these

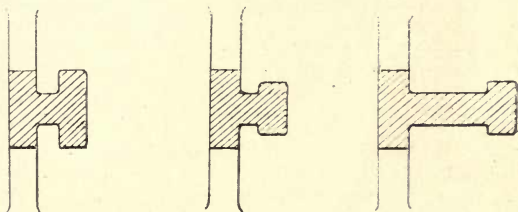

FIG. 30.

circumstances the area of the section must be ample, so that the maximum stress imposed upon the metal may be low, otherwise failure at an early date is inevitable.

Another important quality that the frame must possess is *rigidity*. If the frame should spring perceptibly, then there is a great risk that the dies will not meet truly, and this must result in broken tools. Hence in any press the frame should be designed on liberal lines if satisfactory work is wanted, for it is obvious that the cost of a few pounds of cast iron, suitably placed in the frame, will be a good investment, producing, as dividend, good work, few broken tools, and a valuable reputation.

## CHAPTER IV.

## THE PRESS SCREW.

FREQUENTLY trouble is experienced through the screw wearing badly, and it is by no means an unusual thing to find the screw quite slack after a few weeks' working, even in new machines. Doubtless in many instances this wear is due to rough workmanship, want of similarity between thread and nut, for after all the cutting accurately of screws with double or triple square threads is not the easiest task that meets the machinist. If there is any want of equality between either of the threads of a multiple-threaded screw, then it is obvious that upon one or more of the threads an undue amount of work must fall, with a pro-

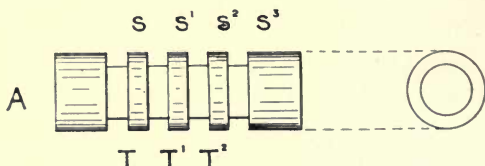

FIG. 31.

portional effect upon the life of the thread. For this reason it is usual to mark the thread and the space in which it works, so that if for any reason the screw has to be taken out of the nut it can be easily replaced in the same position with regard to the nut as it occupied originally.

In the best practice, of course, the threads are accurately cut, both in the spindle and in the nut, so that any thread will work in any space with equal facility.

The difficulties met with in obtaining a true thread may be understood by considering the following two special cases illustrated in figs. 31 and 32. In the first of these is shown a series of parallel grooves cut in a cylindrical bar of steel

by a square-nosed tool held stationary in the rest at right angles to the axis of the bar, and only moved inwards as the work progresses. The result is a series of grooves, the

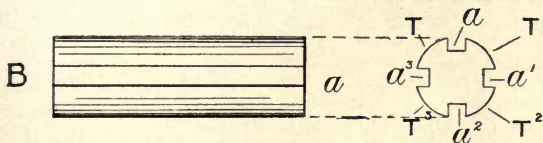

FIG. 32.

spaces  $S$ ,  $S^1$ ,  $S^2$ ,  $S^3$  are of equal widths, and have sides exactly perpendicular to the axis of the bar. These grooves

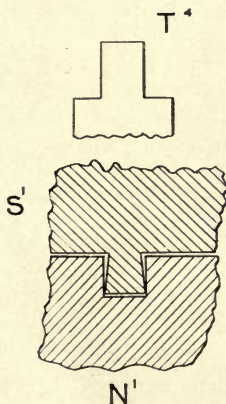

FIG. 33.

actually represent a square-threaded screw whose pitch is zero.

Now, turning to fig. 32, another cylindrical bar is seen, upon which exactly the same tool has been used, but instead

of its being held stationary, it is moved along parallel to the axis of the bar, and the bar is stationary, the result being a longitudinal groove  $a$  of the same size and having the same sectional shape as the grooves in fig. 31. If the bar be turned through exactly 90 deg. after each groove is completed, then there will be four grooves  $a, a^1, a^2, a^3$  equidistant from each other and of equal size and similarly shaped, and this may be looked upon as a square-threaded screw having *four* threads and of *infinite* pitch.

Next, compare the shape of the projections  $T, T^1$ , and  $T^2$  in fig. 31 with those in fig. 32 which are marked  $T, T^1, T^2$ ;

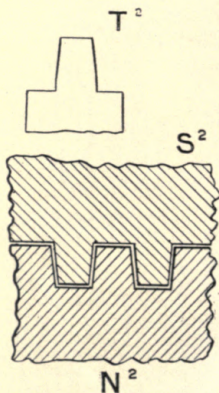

FIG. 34.

and  $T^2$ . In fig. 31 the sides of each projection are parallel, but in fig. 32 they are *not* parallel, but a considerable angle is enclosed, and the reason for this difference is easily appreciated after considering the two figures. Further, it may be noticed that in order that the shape of both the projection or external screw thread and the space or the internal

screw thread may be as nearly alike as possible, it is necessary to make the pitch as *small* as possible, for they can only be exactly the same when the pitch is *zero*.

Assuming that a thread of *sensible* pitch is cut with a square tool  $T^1$  (see fig. 33), the projection must have sides converging towards the axis of the bar (see  $S^1$ , fig. 33), and if this operates in a space with parallel sides  $N^1$ , then the



FIG. 35.

pressure must inevitably fall upon the extreme edge of the thread, and rapid wear will occur, resulting in the appearance of slack very soon after the machine is put into regular operation. Sometimes a tool is used shaped as shown at  $T^2$ , fig. 34, which produces threads of the shapes shown there,



FIG. 36.

and thus overcomes the difficulty to a certain extent. Examples of similar threads to these may be found sometimes in the leading screws of screw-cutting lathes.

For these reasons it is easily seen that unless care be used in cutting the threads of the screw, that trouble from bad working and undue wear is sure to ensue. In figs. 35 and 36 are shown examples of multiple-thread screws, that in fig. 35 having four threads, whilst that in fig. 36 has three threads.

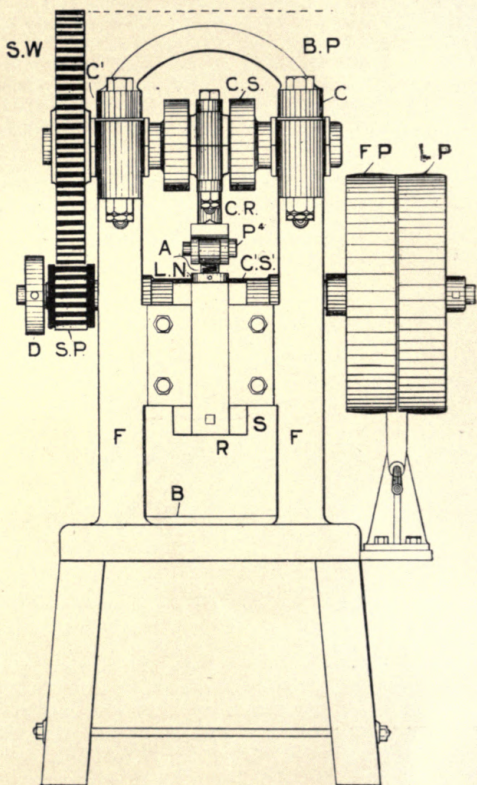

FIG. 37.

## CHAPTER V.

## A POWER PRESS.

THE press just considered is intended for use in operations where only a very moderate amount of energy is required to complete the operation to be performed, and the attention of the student should be turned next to a simple form of press intended for operation by power. In figs. 37 and 38 are shown different views of a press operated by means of a belt through gearing. The frame F, fig. 37, is of cast iron, carrying at the top the bearings, in which the steel crank shaft C S is placed. The brasses of the bearings are held down by caps C, C', which form part of the cast iron bridge piece B P. On one end of the shaft is fixed the spur wheel S W, which is driven by the shrouded pinion S P, fixed to one end of the counter-shaft C' S'. The other end of this counter-shaft carries two belt pulleys, one of which, L P, is loose, whilst the other, F P, is fixed. The ram R is moved by the crank through the connecting rod C R. The exact position of the ram is obtained by means of the adjusting screw A, which screws into the ram R, and is locked in position by the nut L N. The construction of the guide strips S are clearly shown in the figures, and B is base of the press, which is prepared to carry the lower die. On the counter-shaft next to the pinion is shown a cast-iron disc D, in the circumference of which are drilled four holes, so that the position of the ram may be readily moved as required whilst setting fresh tools in position, the belt being then upon the loose pulley. H L, fig. 38, is the handle operating the belt striking gear S G for controlling the position of the belt B<sup>1</sup>.

1. In single-sided power presses the ram is frequently driven by an overhung crank pin. In fig. 39 is shown an example of this form of construction. The ram is slotted S at the back, and in this a block N is fitted, so that it can move freely from side to side of ram. The block is bored to suit the crank pin (see fig. 40). The guide strips are shown at S<sup>2</sup>, S<sup>1</sup> in the plan view, fig. 39.

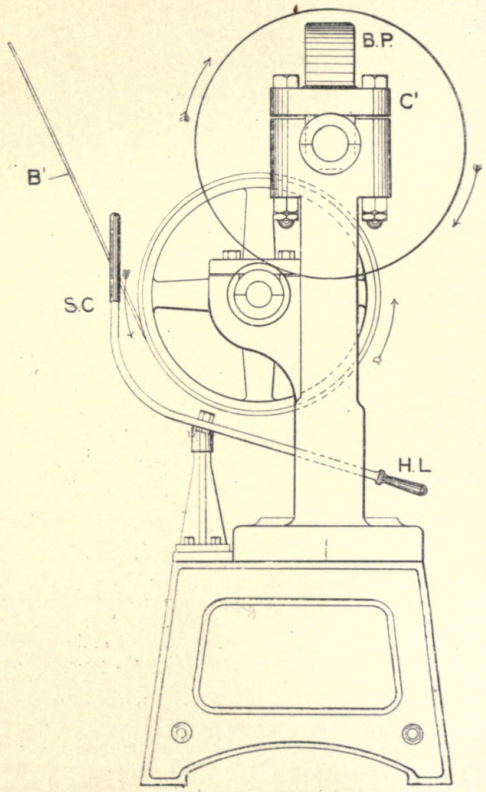

FIG. 3°.



Fig. 40 shows the complete arrangement. The driving shaft CS has a pin let into its enlarged end to form the driving crank, the construction being clearly shown in the

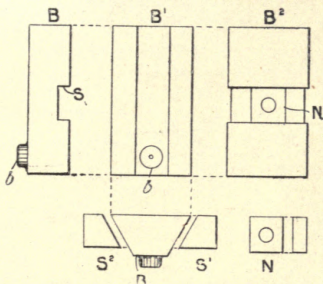

FIG. 39.

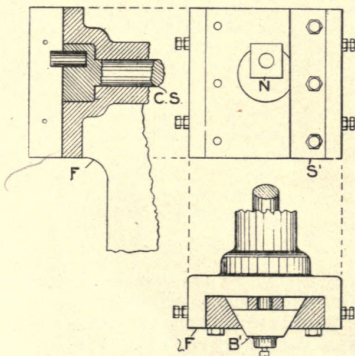

FIG. 40.

left-hand sectional view. The right-hand drawing shows the front view, one of the guide strips and the ram having been removed so that the block N is shown in its position on

the crank pin, and the lower view shows the relative positions of the various parts.

Another method is illustrated in fig. 41, and it will be noticed that the slot extends completely through the ram; in fact, it is a rectangular hole. The depth of the slot is,

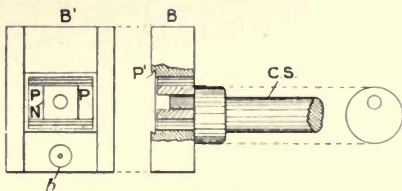

FIG. 41.

however, greater than necessary to accommodate the block N, in order to accommodate the thickness strips shown, which are used in order to provide a means of adjusting the relative positions of crank pin and bottom of the ram to suit different sets of tools. This adjustment is obtained by varying the number above or below the block N, according

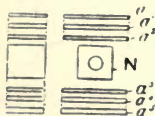

FIG. 42.

to requirements. The six strips,  $a$  to  $a^5$ , are all different thicknesses, to enable minute adjustments to be made, and are shown to a larger scale in fig. 42. They are retained in their proper position by means of a metal sliding cover held in place by the beveled edges shown at  $P^1$ , in fig. 41. Crank pin, fig. 41, is turned solid on the shaft.

The method of driving the ram shown in fig. 39 is open to objection, because of the excessive wear that often occurs in the slot S, which leads, of course, to noise due to back-

lash. This hammering in its turn increases the damage done both to the slot S and the block N, sometimes in the case of the design shown at fig. 40 causing the crank pin to work loose. The tool-setter, in taking up the slack by the packing strips  $S_1 S_2$ , can put a heavy load upon the machine, thus reducing its effective capacity, straining the crank pin, and grooving of the sides of the ram. To prevent this the machine fitter, when fitting in the strips  $S_1 S_2$ , should make them butt on the machine casting, metal on metal. Then, should grooving take place, it can be traced to imperfect

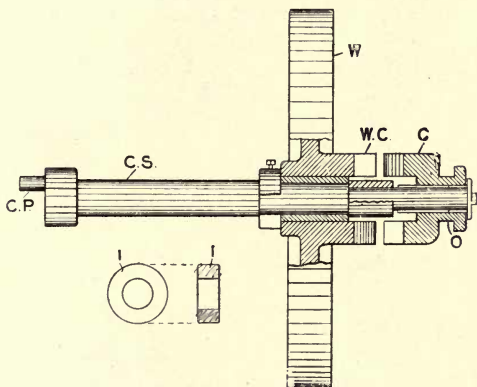

FIG. 43.

adjustment of the side screws for setting up the strips  $S_1 S_2$ . Where this design is employed, the crank pin should be made of large diameter, and as short as possible, in order to obtain stiffness. In many instances, after a crank pin has given trouble by bending, cutting off one-third of its length has removed the difficulty.

The power press is sometimes driven by means of a clutch instead of using fast and loose pulleys as shown in fig. 37. One form of clutch is shown in fig. 43. The wheel W is a

flywheel pulley fitted with a brass bush and running freely on the shaft. The boss is continued so as to form the jaws of the clutch, as shown at W C, a perspective view being shown in fig. 44. On the end of the shaft the other half of clutch C is fitted so that it may slide freely along the axis of

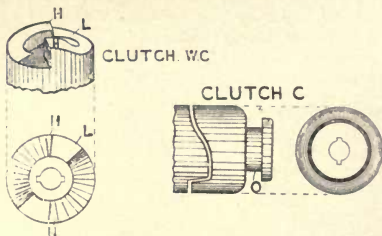

FIG. 44.

the shaft, but it cannot rotate upon the shaft, the two keys K being fitted for driving the shaft. This part of the clutch C is moved to and fro by a lever and rollers operating in the usual manner, the groove O being provided for this

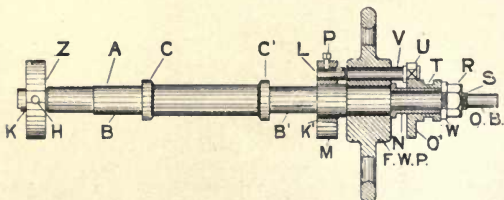

FIG. 45.

purpose. The mode of action is easily understood by reference to fig. 44, which shows the relative positions of C and W C when the clutch is engaged. This clutch was intended for intermittent working, and is only suitable when the press is running continuously for long periods without

being stopped. It is obvious that the shock at starting is only tolerable when the speed is low, and in consequence this form of clutch is very liable to damage, but in certain classes of presswork it can be used with advantage. Any damage to the clutch is a serious matter, for castings cannot always be easily replaced, so that the jaws may have to be put into working order by means of hand labour, always a costly business.

In another form of clutch, fig. 45, a wrought-iron or steel pin V is fitted to the sliding collar O, and passes through the boss of the flywheel pulley F W P, engaging with the pin L, which is fixed into the collar M, which is keyed fast to the shaft. In the position shown in the figure the clutch is disengaged, the pin V, as it rotates with the clutch and flywheel, passing clear of the pin L, and the coupling is effected by sliding O to the left when the pin V engages with the fixed pin L. This form of clutch is open to the same objections as the preceding, but has the advantage that the pins V and L can be more easily replaced in case of damage, since it can be made from a wrought-iron bar of suitable diameter very quickly.

---

## CHAPTER VI.

### FAULTY CONSTRUCTION.

THE press shown in fig. 46 has been selected by the author as an example of poor design, and the results obtained in actual operation practically justify the statement that they are complete failures. The press is belt driven; a flywheel F W is fitted to the pulley shaft, and the crank shaft is driven by means of the pinion P and spur wheel S W, the ratio of the gear reducing the speed of the pulley shaft down to 25 revolutions per minute at the crank shaft. Four rams may be operated simultaneously, or by means of the clutch D; the two presses on the right may be disconnected. The press is one of great power, the crank shaft having a diameter of 6 in., the stroke of the rams being

1½ in., and the ratio of the gears 5 to 1. At the extreme right will be seen a pair of shears L, driven by means of a connecting rod (not shown) from the end E of the crank shaft.

The reason for adopting this design of press was economy of first cost, as compared with the outlay necessary to secure four independent presses. This leads at once to one great disadvantage of the design—*i.e.*, impossibility of independent operation of the several presses. It is impossible to operate the two right-hand presses without running the other two at the same time, and it is not necessary to remind the practical mechanic that it is very difficult, if not quite impossible, to secure the conditions that will allow of all four presses remaining continuously at work. Each time that either of the presses have to be stopped, the remainder must also stand; thus the total time wasted will be at least four times that which would occur had some independent system of driving been adopted in the design. To secure this independence would not have involved any serious outlay when the value of continuous working is allowed for. It could have been secured by any of the familiar devices used in punching and shearing presses that are belt driven and run continuously during working hours.

An examination of the construction of the frame will reveal the multiplicity of joints between the floor and the crank shaft, each of which increases the chance of something working loose, or irregular settlement, and so forcing the shaft out of correct alignment. In the design (fig. 46) it will be noted that a brick pier supports one end of the pulley shaft, whilst the outer bearing is carried on a cast-iron pedestal resting on a wooden block, which may shrink, etc., whilst the presses are fixed to a wrought-iron angle iron resting upon the brick pier at the extreme left end, and four cast-iron pedestals, supported as before upon a wooden block. If the various ways in which this frame can give trouble are counted up, considering both errors of workmanship in construction and erection, as well as carelessness in supervision during its operation, the advantage of a perfectly solid and rigid frame as free as possible from joints will be fully realised.

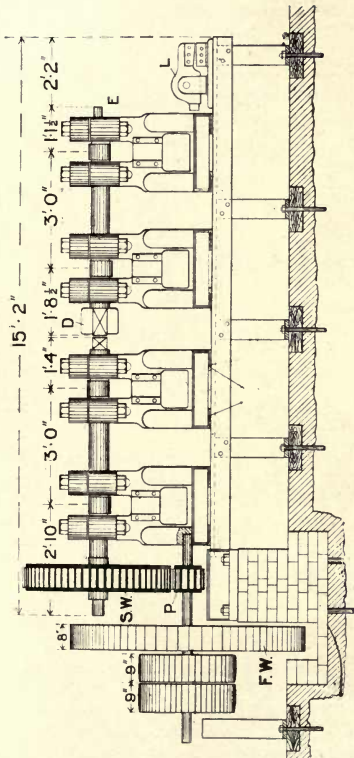

FIG. 46.

The end view, fig. 47, together with fig. 46, will show the construction and method of erection very clearly, and will not require any further explanation.

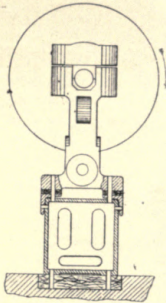

FIG. 47.

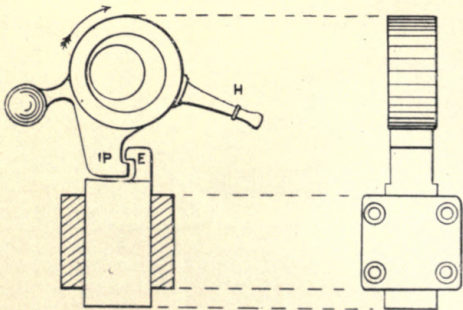

FIG. 48.

In order that either of the four presses may be stopped for tool setting, &c., the mechanism shown in fig. 48 was devised.



The shaft is rotating continuously in the direction shown by the arrow, and the lower part of the eccentric strap is shaped so that there is a solid mass  $M$  to receive the stress due to the thrust exerted upon the ram on the down or working stroke, and a projection  $P$  which engages in a recess  $E$  formed on the upper part of the ram; by this means the ram is lifted for a second stroke. The heavy balance weight  $W$  is to prevent any possibility of  $M$  being forced out of gear when the load comes on, whilst the handle  $H$  is provided

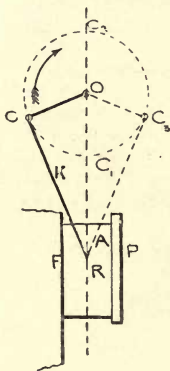

FIG. 49.

for lifting it out of gear when the press has to be stopped, a suitable catch being fitted to hold the handle out of gear until the press is ready to commence running again.

An important matter in press construction is to arrange the direction of rotation of the shaft so that the load due to the reaction at its point of connection to the ram, due to its obliquity, shall come on the frame of the press continuously. The diagram in fig. 49 will make this clear. In the fig.  $O$  is the centre of rotation, and  $C$  the centre of the crank pin rotating about  $O$  in the direction shown by the arrow. The ram  $R$  is being raised between the frame  $F$

of the press and the cover plate P, and obviously the connecting rod K must be in *tension*, since a chain might replace the rod and the ram lifted. But this pull in the rod K is exerted against the weight of R, which is acting downwards in the direction of a line drawn vertically through the centre of gravity of the ram. Thus there are two forces acting at the point of attachment A of the connecting rod K and the ram R, one  $k$  upwards in the direction of K, and the other W vertically downwards, as indicated in fig. 50. Under the action of these two forces the tendency of A is to set itself in the line joining the centre of the crank pin C and the centre of gravity of R; but since the face of the frame F prevents this movement, there must be a pressure exerted against F. The amount of this pressure can be ascertained readily by making the length AW, in fig. 51, to represent the magnitude of the weight W of the ram to some convenient scale; then through A draw a line AQ parallel to the direction of the connecting rod K, and, finally, through W draw WX at right angles to AW, meeting AQ at F; then

$$\frac{\text{the pressure on the face (F)}}{\text{weight of the ram}} = \frac{F W}{A W};$$

and

$$\frac{\text{the tension or pull in the connecting rod (k)}}{\text{weight of the ram}} = \frac{A F}{A W}.$$

Since the angle between the centre line of the connecting rod and the vertical is continuously varying during the stroke from O through some maximum value back to zero again, it is obvious that the line AQ will swing from AW to some position A'Q and back again to AW, so that the length of the intercept WF will vary from 0 when the ram is at the bottom of its stroke and the crank at C<sub>1</sub>, to a maximum value WF when the crank is at C, when the angle OCA is 90 deg., back to zero when the ram is at the top of its stroke—i.e., when the crank has reached the point C<sub>2</sub>.

By similar reasoning it will be seen that on the down stroke—that is, whilst the crank is moving from C<sub>2</sub> to C and thence to C<sub>1</sub>—the crank is *pushing* the ram down, the stress

in the connecting rod is changed from tension to compression, and the resistance due to act of cutting or stamping, the ram's motion downwards is resisted—that is, at A we have, as before, two forces acting again, but their directions are reversed, and are shown in fig. 52. The result of these two thrusts at A is to cause a movement of A to the left, which, as before, is resisted by the frame F. The magnitudes of these forces can be found as before, the exception being that the line A W must be of such a length as to represent the *resistance* offered to the die by the material being operated upon, *less* the weight of the ram, die, etc., which, of course, assists the press to do its work. The direction of rotation



FIG. 50.

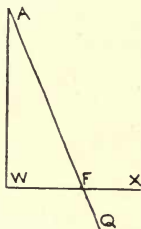

FIG. 51.



FIG. 52.

should be so arranged that the pressure should *always* come on the machine frame, and *not* upon the cover holding the ram in place. This is a small point, but an important one, to be considered, for the smaller the strain that comes upon the bolts securing the cover can be made, so much are the risks reduced of having difficulties with loose cover plates, etc.

Another point that must be paid attention to in multiple presses—such as that shown in fig. 46—is the sequence of the cranks, or trouble will be experienced in the regular working of the machine. The action of a press is intermittent—that is, during a very small portion only of a revolution the whole of the work has to be done, and thus for a short period the pressure exerted is very great. The

object of the flywheel is to store up energy during the idle period of a revolution of the crank, in order to overcome the resistance offered to the movement of the die without throwing off the belt. In the case of a multiple press the cranks must therefore be spaced at intervals of equal angles, so that the working loads come regularly. In the machine shown in fig. 46 there are four presses; hence during a single revolution of the crank shaft there are four working strokes, and the cranks are spaced at angles of 90 deg. to each other. But in this machine, since the coupling D allows two presses to be disconnected, it may so happen that only two presses may be at work, and to meet this each of the two crank shafts have their cranks at 180 deg., or opposite to each other, and when they are coupled the second shaft is set with its cranks at right angles to the first shaft. Thus, if the presses be called No. 1, No. 2, No. 3, and No. 4, counting from left to right, then the sequence of events are shown by the following table:—

Press cutting.	When crank No. 1 is —
No. 1.	on its bottom centre.
No. 3.	has moved 90 deg. from its bottom centre.
No. 2.	has moved 180 deg. from its bottom centre.
No. 4.	has moved 270 deg. from its bottom centre.

Or if the presses Nos. 3 and 4 are disconnected, then the sequence is—

Press cutting.	When crank No. 1 is —
No. 1.	on its bottom centre.
No. 2.	has moved 180 deg. from its bottom centre.

In this way uniformity of speed is obtained. The flywheel, however, must be designed so as to meet the worst case—*i.e.*, the conditions of working when the idle period is *least*; and will be dealt with presently.

## CHAPTER VII.

## DIES AND PUNCHES.

DIES and punches are of infinite variety and shape, special forms being devised daily by engineers in order to produce some new shape that may have to be manufactured. It would be absolutely useless to attempt anything here in the way of a complete exposition of the subject, and only the most commonly used forms will be dealt with, pointing out the leading features of the design, so that some idea of the conditions that have to be fulfilled will be brought before the notice of the reader.

The die is the lower tool that is fixed to the bed of the press, and has a hole pierced through it, so that the blanks forced out by the punch can fall away; or it may be hollowed out to suit the shape required, where the work to be done is pressing, or stamping some special shape from sheet metal; or there may be combination of form, with one or more holes to be punched.

It will be obvious, therefore, at the outset that the die will have to sustain a very heavy load, during the time that the operation is being carried out, without suffering any deformation. In many instances the blanks formed, or the holes punched, have to be true within very small limits, and the dies must not need continuous examination to discover where the wear, &c., is such that the work produced will be rejected, but should retain its efficiency for a long time.

In order to retain its shape the effective portion of the die must be made of the best steel, suitably hardened to meet the special requirements of the operation to be executed; and to meet the great strains imposed, its mass must be very large. But since the cost of suitable steel is much greater than that of iron, it is the practice frequently to fit the steel die proper into a suitable block of wrought iron. The weight of the iron put into the block must be proportioned to the severity of the strains that may be expected in actual work, and for which no mathematical rules are

Handwritten notes in the right margin:

1. *Handwritten text, possibly a reference or note.*  
 2. *Handwritten text, possibly a reference or note.*  
 3. *Handwritten text, possibly a reference or note.*  
 4. *Handwritten text, possibly a reference or note.*  
 5. *Handwritten text, possibly a reference or note.*  
 6. *Handwritten text, possibly a reference or note.*  
 7. *Handwritten text, possibly a reference or note.*  
 8. *Handwritten text, possibly a reference or note.*  
 9. *Handwritten text, possibly a reference or note.*  
 10. *Handwritten text, possibly a reference or note.*

easily applicable, the designer's experience alone being usually depended upon. There is a certain size at which the cost of building up the compound die will exceed the saving effected by using iron in the place of steel. In punching presses, for example, for ordinary sizes there is not any advantage gained by making the outer part of the die of iron. In some cases the cast-iron frame of the machine itself is quite sufficient, because its mass may be easily made comparatively very great.

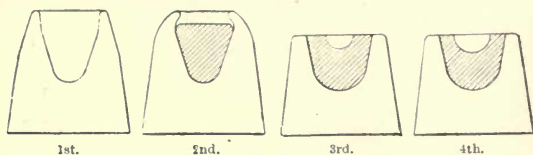

FIG. 53.

The process usually followed in the manufacture of a compound die is illustrated in fig. 53, the first stage being the formation by the smith of a hollow in the wrought-iron bed; next, a piece of steel is inserted and the iron closed as tightly upon it as possible. The third stage shows the block with the iron and steel firmly welded together. The hollow in the steel centre is formed by the tool smith to reduce the



FIG. 54

work of the tool maker when shaping the die accurately to the specified dimensions and contour, as shown in the fourth stage. Fig. 54 shows three other different shapes of stamp dies. The dotted line indicates the depth of metal left by the tool smith for machining purposes in the tool room; whilst fig. 55 illustrates a drawing die in which the steel centre has a wrought-iron ring surrounding it, the hole in the steel centre being afterwards bored out accurately by the tool maker, where the work to be done is that of

cutting out blanks to some special shape; then the steel is worked into the iron bed by the smith, the face and hole being shaped by the tool maker, so that the upper edge of the hole in the steel centre forms with the punch a pair of cutting edges. Fig. 56 shows two methods of making beds intended for cutting out long round-ended blanks. The bed A has an iron bottom and steel top, which, after being forged, is machined nearly all over; whereas, in the case of B, the bed is cut off a solid bar of steel by the tool maker

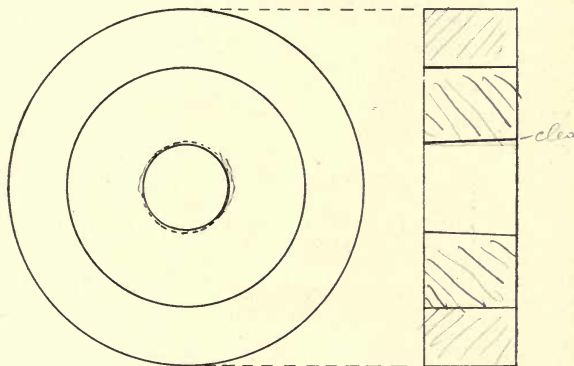

FIG. 55.

and machined, thus avoiding the cost of forging. The hole to receive the punch is clearly shown in fig. B. The holes should increase slightly, so that there is sufficient clearance for the blanks to fall freely immediately they are formed, or otherwise difficulties may arise.

Where possible the correctness of the die is tested before hardening, but this cannot always be done, because the material will be unable to withstand the stress in its unhardened state. When the dies are correct they are hardened and tempered to a light straw colour. This process of hardening and tempering dies so that they are able to

successfully withstand the rough usage of the press is one of great importance, depending ultimately upon the care exercised by the tool maker entrusted with the work. The great point apparently is to heat the articles to be hardened as uniformly as possible to the required temperature, and then to cool them more or less quickly and evenly, so that

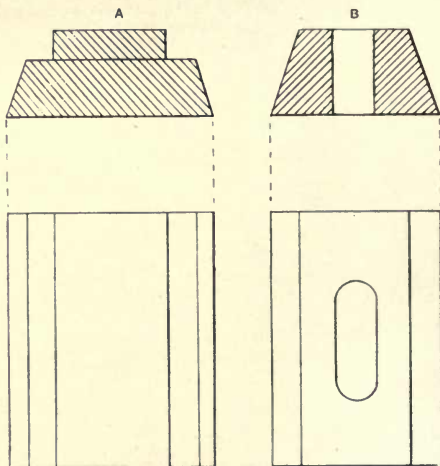

FIG. 56.

the internal stresses shall be as equal as possible. Cracks result from failure of the material, due to the excessive internal stress; whilst fracture soon after work is commenced indicates that the stress due to the external load sufficed, when added to the internal stresses already existing, to strain the material beyond its "yield point," and failure results. At other times failure only occurs after many applications of the load, the "fatigue" reducing the ultimate



strength more or less quickly according to the magnitude of the internal stresses in the material due to the hardening and tempering processes.

The practice of the careless smith is to put the tool to be hardened into the fire, so that whilst one portion is rapidly warmed up another part is out of the fire and almost cold. The tool is presently turned over to warm up the colder part, when the heated side is cooled down; finally the tool is rapidly twisted about, so that as far as the eye can judge it is properly heated. If a fire is used, then the tool should be actually covered entirely over, and the process of heating up carried out slowly and evenly throughout the whole mass, so that the temperature is even throughout. Probably the best way to ensure this regular heating is to use a gas-fired furnace or muffle, which can easily be arranged to maintain the correct temperature by adjusting the gas supply, and in this way there is no risk of burning the steel if the workman should be unable to remove it when ready for cooling. Another incidental advantage of the gas-fired furnace is its economy in working both as regards cost for labour in handling the fuel and the increased cleanliness due to the freedom from smoke and dust, which are inseparable where the ordinary smiths' fires are used.

The dies should be left as soft as the nature of the work will permit as the internal stresses are proportionately reduced, leaving a wider margin of safety in actual work, and a proportionately longer life, before repairs or renewals are required in order to preserve the necessary accuracy of form.

For the manufacture of dies and punches a careful selection of the steel employed is of the utmost importance, for if the quality of the steel employed is not suitable, it will be impossible to make satisfactory tools, notwithstanding the utmost care exercised by all concerned during their production. The amount of hardening possible depends upon the quantity of carbon present, and for the purpose of tools that will stand a great pressure, as in the case of dies, &c., the best proportion of carbon is about  $\frac{3}{4}$  per cent. Increasing the amount of carbon to  $\frac{5}{8}$  per cent gives an exceedingly tough steel suitable for "cold sets," and similar

tools that have to withstand very heavy blows. For chisels and similar tools, where ability to withstand heavy usage, and yet to harden sufficiently to give a cutting edge, the steel should contain about 1 per cent of carbon. Increasing the amount of carbon beyond 1 per cent yields steels having greater hardening powers, and consequently increasingly brittle, whilst the metal requires much more care to work satisfactorily.

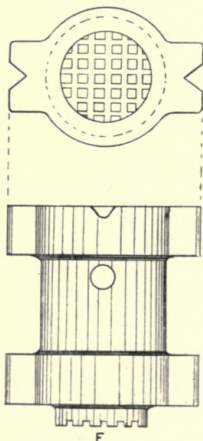

FIG. 57.

The upper die used in stamping out work is shaped to suit the inner form of the article to be produced, and is usually termed "the force." It is made of various materials, to suit the special conditions to be satisfied. Tin, brass, iron, and steel are the materials most commonly used. The force is held in the stamp hammer in several ways. Fig. 57 shows the face of the hammer notched or grooved, into which the force is pressed. In fig. 58 the force is keyed in the

groove, whilst in figs. 59 and 60 it is secured by means of a screw S pressing on to the spindle as in an ordinary drilling machine.

The operation of making a tin force is illustrated in figs. 61 and 62. In the first of these C is the clay mould formed round the top of the tool, into which the molten tin T has

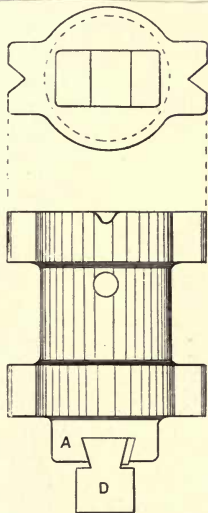

FIG. 58.

been poured, thus forming a casting for the force. The head of the hammer K—the face being ready notched—is then carefully lowered, the tin filling the interstices in the face of K, and securing the force accurately in place.

The brass force is made by using a tin force as a pattern to make a mould from in the foundry as in the ordinary course.

Iron and steel forces are formed first by forcing the hammer face K into the rough force F, fig. 63, the iron being heated for this purpose. When this has been done the force is again re-heated, and repeatedly forced into the tool until it has been squeezed into the exact form. Where the shape of the force has been much upset by the process of

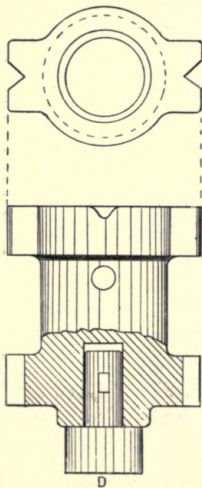

FIG. 59.

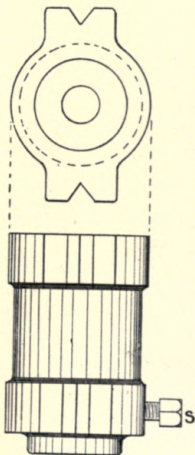

FIG. 63

forming the "jag," time may be saved in the last operation if some of the metal at *a*, *b*, fig. 64, be roughly turned off. This is always true when the die is a deep one. The turning operations are facilitated by the use of a template. Care should be taken in these operations not to let the force get cold whilst it is being formed, or the lower die will be

damaged. In fig. 65 the bar of iron B is placed above the die to protect it whilst the force is having the jag formed in its upper face.

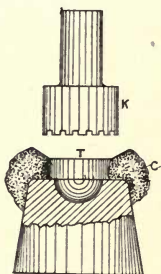

FIG. 61

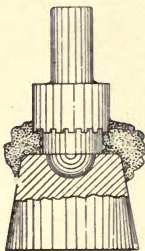

fig. 62

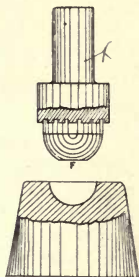

FIG. 63.

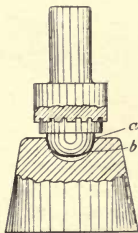

FIG. 64.

PUNCHING AND SHEARING.

The term *punching* is generally understood to include all operations of cutting out blanks from sheet metal. The shape cut away is known as the *blank*, whilst the unavoidable amount of metal sheet left afterwards is only fit

*Superior*

for scrap. Some ingenuity is required to so arrange the sequence of successive punchings that the amount of scrap shall be a minimum.

*Shearing* is the operation of cutting up sheet metal, flat bars, &c., into lengths, strips, &c. The action of a punch is that of shearing, and a punch may be regarded as an endless shearing tool.

The load that comes upon a punch is wholly compressive, and very heavy. The limiting thickness of metal that can be punched without heating the punch, being dependent upon the relative resistances of the die to compression, and of the plate to shearing.

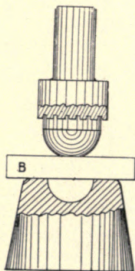

FIG. 65.

Let  $f_c$  = crushing stress in pounds per square inch of punch;  
 $d$  = diameter of the punch in inches;  
 $D$  = diameter of the hole punched in the plate in inches;  
 $f_s$  = shearing stress in pounds per square inch at which the plate yields to the punch;  
 $t$  = thickness of plate in inches.

Then at the instant of rupture

The load on the punch = maximum resistance offered by the plate to punching

$$\frac{\pi \cdot d^2}{4} \times f_c = \pi \cdot D \cdot t \cdot f_s$$

$$d^2 \cdot f_c = 4 \cdot D \cdot t \cdot f_s$$

if the difference between  $d$  and  $D$  is so small that it may be neglected, then putting  $d = D$  we have

$$\frac{d}{t} = \frac{4 \cdot f_s}{f_c};$$

Taking the case of best Yorkshire iron plates, then  $f_s$  is, according to Professor Goodman, about 19 tons as the upper limit, and for tempered cast steel  $f_c$  may be taken at about 85 tons, the exact figure, however, depends upon the amount of hardening and the quality of the steel, then using these values the ratio

$$\frac{d}{t} = \frac{4 \times 19}{85} = \frac{76}{85} = 0.894.$$

That is, the theoretical limit of thickness is, in this case, equal to the diameter  $\times$  by 1.118, which agrees with the practical rule which puts the maximum thickness as being equal to the diameter of the hole punched. The limiting diameter of any hole in a plate  $t$  inches thick of any material is

$$= \frac{t \times 4 \times \text{the limiting shearing stress}}{\text{safe working crushing stress of punch}}$$

In this connection the following figures will be useful in connection with the above formula.

Metal.	W. iron.	Steel plates.	Copper rolled.	Brass.
Shearing .....	40,000	{ 50,000 } { 83,000 }	....	....
Crushing .....	50,000	....	28,000	{ 20,000 } { 120,000 }

From experiments that have been made, it is found that the area surrounding the hole in punched boiler plates is injured by the severe stresses caused by the pressure of the die, and the extent of this injury is given by Professor Goodman as about  $\frac{1}{10}$ th of an inch deep round the hole. For this reason, where plates have been punched or cut by shears it is customary to plane the edges of such plates and

ream out the punched holes. The pressure on the plates makes them brittle, and if the plates be bent, cracks develop in the crushed parts.

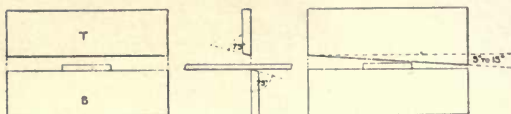

FIG. 66.

To reduce the magnitude of the total load, it is common practice to give a slope to one of the cutters in a shearing machine, as shown in fig. 66, the amount of this dip being

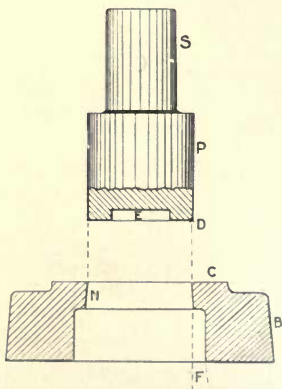

FIG. 67.

from 5 deg. to 15 deg. This dip has also the effect of extending the time during which the cutting is going on over a longer interval, with the result of reducing the



stresses generally on the machine. The angle of the cutting edges, and the position of the plate to be operated upon, is shown clearly in the figure.

The details of punching tools, it may be noted first that whilst cutting-out punches are given shear for the purpose first referred to in shearing cutters, yet generally the ends of the punches are faced off flat—that is, at right

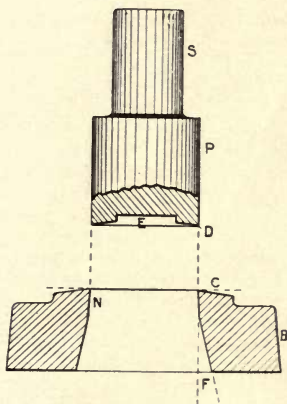

FIG. 68.

angles to the line of motion, thus there is no shear, and the cutting angle is 90 deg. An example is shown in fig. 67, where the cutting edge D is equal to 90 deg., whilst in fig. 68 is a similar punch, but the central part of the face is cut away, making the cutting edge D less than 90 deg. This is of some advantage when the punch becomes worn, and requires upsetting to enable the original diameter to be regained.

For tools that are to cut blanks from thin sheets of brass and tin, particularly those of large area, it is usual to harden and temper the lower die to a straw colour, and leave the

punch comparatively soft; i.e., it would be hardened, but let down in tempering to a blue colour. When such a punch has worn, the punch can be hammered up around its cutting edge, and then forced into its own die, to bring it up to correct size again. This is necessary when the metal sheet is thin, say less than  $\frac{1}{32}$  in., then the cutting tools to do good work require to be a good fit, but with thicker sheets there must be some clearance varying from  $\frac{1}{100}$  in. to about  $\frac{1}{16}$  in., according to the nature of the work. The result of any freedom when working on thin plates is to leave a ragged edge or fraze on the blanks.

If the blanks have to be cut from steel plates, the punch must be hardened and tempered the same as the die if uniformity of size is necessary, but this hardened punch must have some freedom in the lower die, or the friction will increase the rate of wear, and entail extra work upon the tool-maker in grinding, etc. The amount of clearance required depends upon the size of the punch, the thickness of the plate, and the nature of the work to be done; in some cases  $\frac{1}{100}$  in. will be sufficient, whereas, if it is boiler plate, or girder work, the clearance may be as much as  $\frac{1}{16}$  in. The effect of clearance upon the size of the blanks is to render them taper, their top side will be the same diameter as the punch, and the lower face will correspond to the diameter of the hole in the die.

Punches may be made solid, in which case they require some forging, or they may be made up in the tool room without the aid of the smith. Each plan has its advantages, the built-up tool requiring to be well made or it will lack rigidity, and fail to do good work in consequence. In punches of small diameter they are drawn down from a larger bar of tool steel, the upper end of a suitable size to fit the ram; the lower end the diameter of the hole or blank required. Sometimes the punch is left perfectly parallel, but in many cases there is a slight taper which may tend to slightly increase the diameter of the punch as it wears back, or may reduce its diameter.

It is sometimes convenient to build up a punch of large diameter for cutting out blanks, and one such composite punch is shown in figs. 69 and 70. In this example the

tool consists of three parts, the cutting part F formed of hardened steel, attached to the part B (which may be a casting) by means of three or more small screws. The shank S is parallel and enters the ram, whilst H enters the casting B. This tool can be made without the aid of a toolsmith, and several different sizes of cutter F can be made to suit B, the hole in F being machined, so as to fit

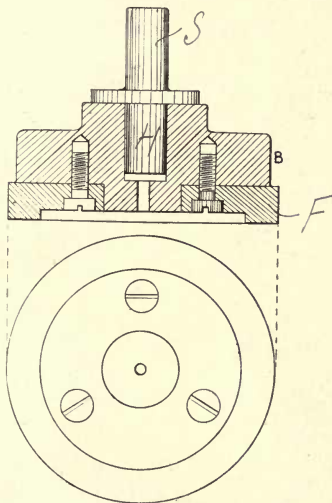

FIG. 69.

exactly concentrically without the assistance of the screws. The casting B may be attached to the shank H by heating and shrinking in the usual way.

A very common method of fixing punches to the ram is shown in fig. 71, where the shank is screwed into the ram, flats being provided so that it may be tightened by means

of a spanner. A better method of fixing is shown in fig. 72, where the shank of the punch is turned parallel and made

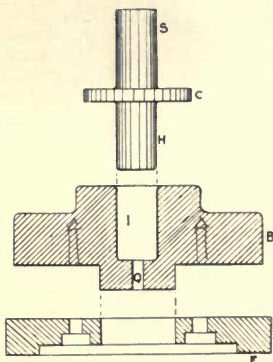

FIG. 70.

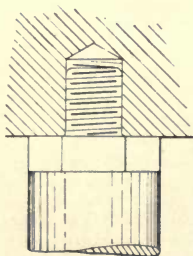

FIG. 71.

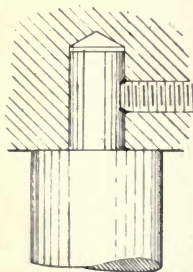

FIG. 72.

to fit the hole in the ram, and secured in its place by means of a set-screw. This is necessary in order to prevent its

being pulled out on the up stroke of the ram, when considerable force is often required to withdraw the punch from the hole it has made.

A badly-fixed punch means bad work and many broken tools, because when the pressure comes upon the tool it will "kick" or spring aside, if it does not press evenly upon the material from which the blanks are being formed. The load that comes upon the punch is very great even when but small holes are being punched, and when this is fully realised the necessity for good workmanship will be readily admitted. Dr. Anderson gives some interesting figures obtained by means of a series of careful experiments in which the load upon the punch was gradually increased until the hole was punched.

Diameter of punch.	Thickness of plate.	Sectional area of plate.	Total load on punch.	Stress per square inch.
Inch.	Inch.	Square inches.	Tons.	Tons.
$\frac{1}{4}$	0.437	0.344	8.384	24.4
$\frac{1}{2}$	0.625	0.982	26.678	27.2
$\frac{3}{4}$	0.625	1.472	34.768	23.6
$\frac{7}{8}$	0.875	2.405	55.000	23.1
1	1.000	3.142	77.170	24.6

*2000 lbs. - a  
comp.  
1000 lbs.*

In the Transactions of the Institution of Mechanical Engineers of 1858, particulars are given of some experiments made with punching presses, from which we take the following results:—

Diameter of punch.	Thickness of plate.	Sectional area of plate.	Total load on punch.	Stress per square inch.
Inches.	Inches.	Square inches.	Tons.	Tons.
1	0.5	1.571	36	22.90
1	1.0	3.142	69	21.95
2	0.5	3.142	65	20.70
2	1.0	6.283	132	21.00
2	1.5	9.425	186	19.73

Mr. Hick, of Bolton, found the load required to force a punch 8 in. diameter through a plate  $3\frac{1}{2}$  in. thick was 2,000 tons, or 22.74 tons per square inch of area.

The load upon the punch can be estimated roughly by multiplying together the diameter of the punch, the thickness of the plate, by the stress per square inch of area, and 3.14. Stated algebraically, if  $D$  = diameter of punch in inches,  $t$  = the thickness of plate in inches,  $f$  = the resistance offered by metal in tons per square in., and the load upon the punch in tons =  $L$ , then

$$L = d \times t \times f \times 3.14.$$

The figures given above show that the total load upon the punch is very great, and unless it is properly secured the tool must be very severely strained. These figures also show that the load upon a punch is approximately equal to the tensile strength of a bar, the area of whose cross-section is the same as the area of the sides of the hole. Thin plates appeared in many instances to require a greater load than was necessary in the case of thick plates, and the reason for this probably will be found due to the skin effect of the hard exterior surface of rolled plates.

It must be remembered that the operation of punching and shearing is not strictly cutting, but rather a detruding action. The time occupied in punching is due to the elasticity of the material, the punch, and the parts of the press. When this elasticity and slackness are all taken up, then the resistance of the material is at once overcome, and the metal is detruded, or pushed off, rather than cut away. After the operation is completed the resilience of the machine in assuming its normal condition gives rise to the well-known jerk or knock which is heard immediately the blank is detached.

The behaviour of materials under pressure has been the subject of many experiments, and the plastic properties of solids are now fairly well known. If a solid substance be subjected to a stress gradually increased, careful observation will show that at first there is a period of nearly perfect elasticity, when the variations of length are exactly proportional to the stress, and if the stress be removed the body

*Handwritten notes in the left margin:*  
 Now a year  
 close to  
 the  
 the  
 the

returns to its original length. If, however, the load applied be increased still further, then a second period is reached when the alteration of length is no longer proportional but rapidly increases with the augmented loads. If the load be removed after this second stage is reached the body will not regain its original length, but will remain permanently stretched. If this second period of deformation be further considered, it will be seen that it tends towards that condition in which a force sufficiently great would go on stretching the material, as occurs in the operation of drawing lead wire. This particular condition M. Tresca first called the period of fluidity. In certain materials, such as glass, this period practically disappears, but in the case of

*neglected  
Tresca  
recog.*

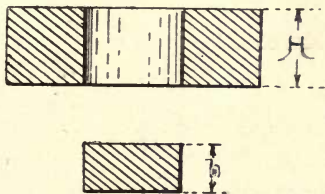

FIG. 73.

malleable metals it is very much extended. M. Tresca found from his experiments that large plastic deformation is not associated with any sensible change of density. The following examples will serve to illustrate the flow of metal that takes place under the action of the punch, and are taken from the results of the experiments already referred to. Suppose a block to be supported on the die of a machine, and to be perforated by a punch. If the blank produced is carefully measured and compared with the thickness of the block, in general it will be found to be less, that is,  $h$  is less than  $H$  (see fig. 73). In one case  $H$  was 10 centimetres, the hole punched was 2 centimetres diameter, and the thickness of the blank was only 3 centimetres. The density of the blank was determined precisely, and found to be the same as that of the original block, con-

sequently during the act of punching 70 per cent of the metal must have *flowed laterally* into the block.

In another case where the punching was only partially performed, as shown in fig. 74, the thickness of the blank was easily seen to be less than the penetration of the punch without having recourse to measurement. A further experiment may be mentioned, in which a series of lead discs were placed upon each other and then punched. After being cut in two the appearance of the block and blank produced was as shown in fig. 75. The blank consists of an equal number of discs, but their thickness has been changed, and it will be seen from the figure that the depth of each disc differs, the thickness of each gradually increasing

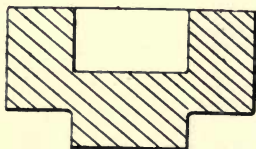

FIG. 74.

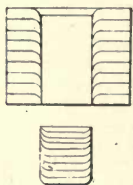

FIG. 75.

from the top to the bottom of the blank. Of the metal forced to flow laterally the greater part has been obtained from the upper discs. From these experiments the student will easily infer that under the pressure of the punch, the metal becomes plastic and flows, till the remaining metal is so thinned that its resistance to shearing is less than the load on the punch. Further details upon the "Flow of Solids" can be found in the Proceedings of the Institution of Mechanical Engineers of 1876 and 1878; and also in an article on "Elasticity" in the "Encyclopædia Britannica" by Lord Kelvin.

Obviously the best way to fix the punch is that shown in fig. 72, because the whole load comes upon the shoulder which can be turned true, and thus there cannot be any tendency to force the punch out of line. Probably the reason that



screwed punches have been so much used in the past is due to the facility with which a punch can be secured tightly into the ram, by means of a spanner, as contrasted with the trouble given by a punch with a shank that is not parallel, although it may be called so.

Parallel punches may be made from round bar without the aid of the smith, and if suitable jigs and gauges are available may be completed ready for use without the tool maker going near any of the presses in which they will be used.

In order to prevent the punch from being drawn out of the ram on the up-stroke, a flat or hole should be provided for the set screw to bed against, and so hold the punch firmly. This precaution is very necessary in the case of large cutting-out tools, also in cupping and drawing presses, in each of which operations there is often a very heavy drag put on the punch.

Screwed shanks cannot be used when the shape of the punch is irregular, square, rectangular, &c., as in such cases the punch must always have some particular position with respect to the ram, and the slightest deviation from this position will cause the punch to foul the die. With a screwed shank it would be very difficult to maintain this accuracy; but by means of a parallel shank, with a flat planed upon it, a set screw will secure it in the same position accurately any number of times. When extreme accuracy is essential some arrangement of dowel pin can be easily devised upon the face of the ram to suit the special case, and for this purpose a jig should be made, so that the tools can be accurately made in the tool room to suit one or more presses in the shop, as may be required. One such arrangement is shown in fig. 76, where the punch P is secured to the ram by means of the parallel shank S, which is held by means of a set screw E pressing on the flat F. The punch, however, has a small dowel pin D fixed near its outer edge, and this entering the hole in the ram forces the punch to take up its proper position automatically, without any effort on the part of the workman fixing it. The dowel pin should have its upper end slightly tapered so that it may readily enter the hole in the ram, and should be

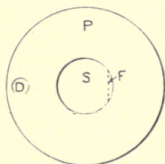
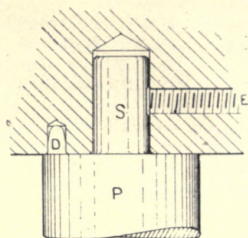

FIG. 76.

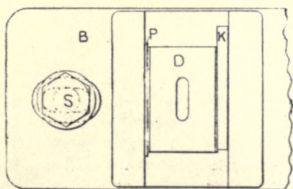
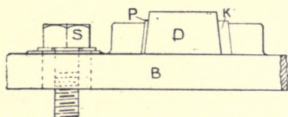

FIG. 77.

made large enough to prevent its being damaged with ordinary shop usage.

In an American cutting-out press the author noticed that the punch was fixed to the ram by means of a key similar to a method commonly used for attaching dies, but it does not seem to offer any advantages over the parallel shank type, except in some kinds of forcing work. For small cutting-out work, such as this press was intended for, it would be comparatively expensive to make, as well as more difficult to handle.

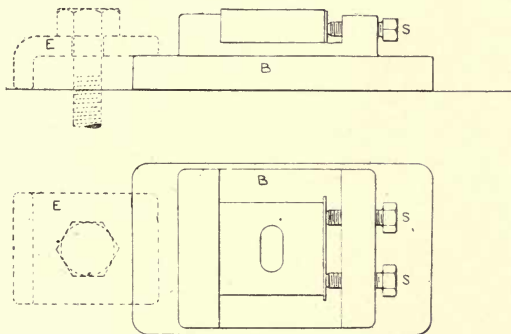

FIG. 78.

A good method of holding the bed is shown in fig. 77. The bolster B is fixed to the press by means of two set screws S, and the bed D is secured in its place by means of the key K, its position being adjusted by means of thin packing strips at P. This packing strip is also useful in case the key is not tight enough to hold the bed D securely.

Another method of holding the bed is shown in fig. 78, where, instead of taper grooves, the bolster is planed with vertical edges and two set screws S are used to fix the bed in its place. This method is not so good as that shown in fig. 77, because there is nothing to ensure the block being

tightened hard against the bolster B; indeed, it may be easily raised up slightly by the turning of the set screws, whereas the pressure of the key K and the taper grooves

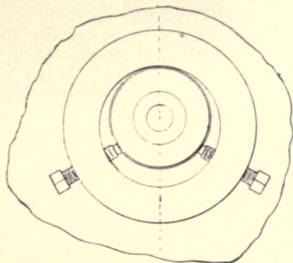

FIG. 79.

forces the bed down in a very positive fashion ensuring a solid fixing. The bolster is attached to the press frame by means of the dog plate E and a set screw in the way familiar

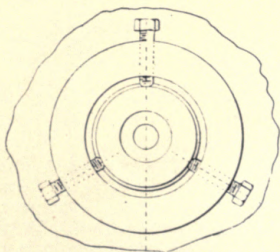

FIG. 80.

to turners. This method of fixing gives more latitude in adjusting the position of the bed upon the press.

When the die-forging is circular in shape, then it may be fixed as shown in figs. 79 and 80, by means of either two or

three set-screws, which press upon the taper sides of the die. The three set-screws permit the die to be centred accurately in place very readily. The bolster may be either circular in shape or rectangular, and fixed to the machine, as shown in fig. 77 or fig. 78. In the plan illustrated in fig. 77

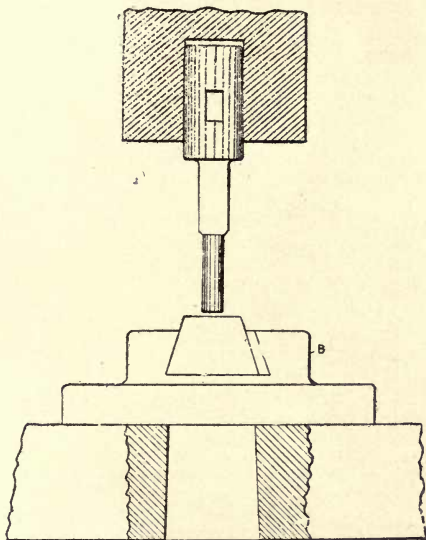

FIG. 81.

it is advisable to make the bolt holes in the form of slots, so that the toolsetter may have some freedom in adjusting the bolster in place. Washers should be placed under the head of the screw, so that the pressure due to tightening up may be distributed evenly.

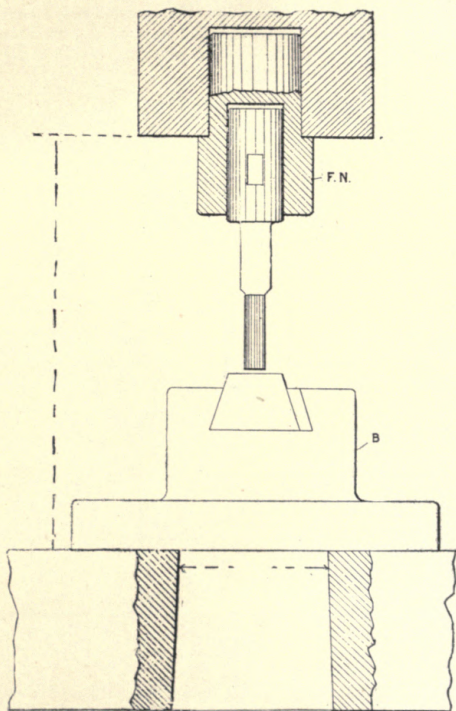

FIG. 82.

A point of some importance to watch in the equipment of a workshop in which a number of presses are in use is the size of the dies and punches, so that as far as possible they may be interchangeable. Unless this is done much time will be wasted because a particular press is engaged in the execution of an order and cannot be stopped. In order that any machine of a group may be utilised, the stroke of the rams and the depth between the ram and the bed must in each case be noted, and the diameter and length of the punches determined to suit. If there is much variation in depth, then it may be necessary to construct some adapters to compensate for these differences. The tools should be constructed to suit the smallest machine, and for each of larger presses a plain chuck or false nose would be formed with a shank to suit the larger hole in the ram, and provided with a hole to take the standard punch. In the case of the die a special bolster would be required, the lower face or bottom being shaped to suit the press bed, whilst the upper part would be machined to take the standard die. By arranging the thickness of the bolster and the length of the false nose any variation of depth in the frames can easily be compensated for.

By these means the shop foreman can easily arrange matters so that the machines are utilised uniformly, even when an unexpectedly heavy demand arises for some special article, the execution of which would be delayed—seriously, possibly—if only one press was available for that particular operation. An example of this interchange of tools can be seen in figs. 81 and 82; in the former is shown a punch and die fixed in a press of proper size, whilst in fig. 82 the same size punch and die are shown fixed in a larger press by means of a false nose FN, and a thick bolster B, thus enabling the standard punch and die to be used, and the same sized blanks to be produced simultaneously at several presses.

## CHAPTER VIII.

## ACCURACY AND DURABILITY.

THE durability of dies and punches depends to some extent upon the nature of the work upon which they are used. Further, the work to be done by these tools governs the point as to the amount of accuracy and finish that shall be given to them. It is, therefore, necessary that care and judgment be exercised upon this point, for when the metal after being cut into blanks has to be stamped, or raised and clipped as often is the case, the cutting tools need not be so accurate as they would necessarily have to be if several pairs of tools were producing similar blanks, which may have to undergo many processes before finally coming together and be interchangeable when being assembled. The cutting-out tools for such articles as cycle chain links, quick firing shells, small arms ammunition, type writing machines, cycle and motor car parts, electrical apparatus, jewellery, locks, musical instruments, stencils, watches, or any similar delicate work, must necessarily be made very accurate and be of first-class finish; whereas in the case of such articles as stamped hollow-ware, coal hods, elevator buckets, trunk trimmings, kitchen utensils, agricultural implement parts, hinges, lanterns, shovels, etc., a small fraction of an inch larger or smaller in the size of the cutting-out tools, or a slight variation in their shape would be of small consequence.

## STANDARD DIES AND PUNCHES.

It is interesting to trace the process of making a die and punch to a standard pattern, such for instance as the two ordinary shapes, a pedal plate blank, fig. 83, and a spanner blank, fig. 84, the die D having been planed or milled both on the top and bottom and the necessary angle planed upon its sides to fit the bolster. The top of the die should now be cleaned off with a smooth file and emery cloth, after which the top must be smeared with sulphate of copper,



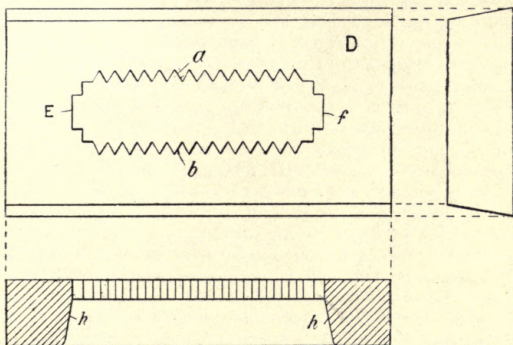

FIG. 83.

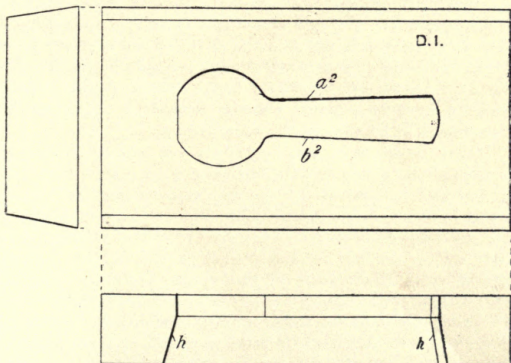

FIG. 84.

commonly known in the workshop as "blue stone." This is done to enable a fine line to be seen, for without the blue stone, it would be of little use marking out a shape upon the bright face of the steel die with a marking scriber, because the lines could only be traced by the eye with great difficulty. In some instances the standard blank would be used as a template to mark out the shape upon the die, but this is not considered a good method unless a perfectly accurate blank is used as the template. Assuming that the blank is one that has been cut by a pair of ordinary press tools, probably it would not be accurate, therefore the better plan would be for the tool maker to carefully set out and mark the shape accurately upon the face of the die. This would be done with square, compasses, and scriber, in a similar manner that a detail drawing would be made upon a piece of drawing paper. From this it follows that a knowledge of geometrical drawing is very useful to the tool maker. Having carefully indicated the outline of the figure by dots from a small centre punch, as much of the metal as possible should be removed by drilling various sized holes straight through the die; the size of the drills used will depend upon the size and shape of the hole required in the die—in other words the size and shape of the required blank. After removing as much metal as is possible by drilling, the die may be turned over and larger drills passed up the back to a certain depth, thereby forming a clearance; this clearance will be seen in the section at *h*.

If the holes have been carefully set out to follow the outline of the shape a little chipping with a thin flat chisel on top and bottom of the die will remove the bulk of the metal in one piece or lump. The back or clearance side of the die may now be cut away by the aid of larger chisels, after which the die is turned over in the vice so that the top, showing the outline of the figure, faces the operator, who will carefully chip and file out the shape of the blank by using the various small chisels and files. When the shape is apparently filed up true to the line, assuming that the pattern blank, fig. 85, is a true one, it is usual to try the blank upon the die, filing away the die until the pattern blank will pass into the hole. Suppose this has been done,

and when the pattern is in the die and  $b^1$  in blank comes to  $b$  in die,  $E^1$  to  $E$ , and  $f^1$  to  $f$ ; now either turn the blank completely over, so that  $a$  comes to  $b$ ,  $b^1$  to  $a$ , then  $E^1$  will still be by  $E$ , as will also  $f^1$  to  $f$ . This will show up the imperfection of shape in the curves of the die, and is known as correcting the die. Should the pattern blank pass into

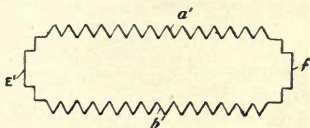

FIG. 85.

the hole and fit fairly well, showing no spaces when held up to the light, both when the blank has been passed in one way then the other, the blank and the die would be considered sufficiently true for ordinary work; but if still greater accuracy is required the blank may be turned or swivelled round half a revolution, bringing  $E^1$  to  $f$ , and  $f^1$  to  $E$ , as this will give an additional test for accuracy. It is unnecessary to trace the making of the die, fig. 84, as that would be made in the same manner as fig. 83. One point, however, may be mentioned regarding fig. 84, namely: In the case of testing the die for accuracy the shape of spanner

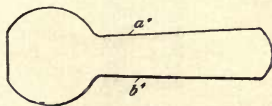

FIG. 86.

blank, fig. 86, would not allow the test of turning end for end, consequently the blank would merely be turned over, and tried in the hole of the die fig. 84. If the shape of the figure upon the die had been copied from a drawing or sketch, as would have been the case supposing there had been no pattern blank to work from, the mechanic who is responsible for making the die may either set out and file a

template of sheet-iron, steel, or brass, or he may place a piece of sheet lead on the die, tap it all over carefully with a small hammer, when it will be seen that the shape of the hole is formed upon the sheet lead. Now carefully cut round the lead with a penknife, thereby producing a sheet-lead template or pattern, finally hammering the piece of lead straight through the die; then turn the end for end,

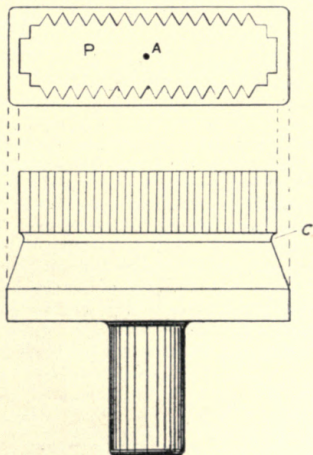

FIG. 87.

or over, as the case may permit, and try into the hole again in the manner before explained. The sheet lead method of testing dies is very useful, as by a little practice and care much time may be saved when a large variety of shapes and small dies are to be made—time that would otherwise be taken up in making metal templates from iron, steel, or brass.

Having made the die it may now be hardened and tempered, and attention may now be turned to the making

of the punches, figs. 87 and 88; the punches will be centred on their faces at  $A A^1$ , and centred at their shank ends. The shanks should be turned to some standard size, and the top and bottom faces turned or faced perfectly flat whilst they are in the lathe, and sulphate of copper smeared over the bottom face and the outline of the figure marked out with the scribe, using either the iron, steel, brass, or sheet-lead blank

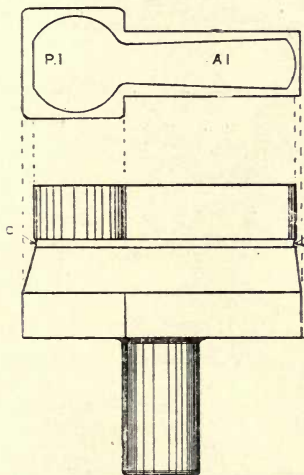

FIG. 88.

as a template. The punch may now have a groove planed or chipped all round (see figs. 87 and 88 at C). This will give a clearance so that the punch may be fixed upon the shaping machine in a special fixture (see fig. 89), and shaped up by the tool T; this will enable the bulk of the metal to be removed. The punch may next be carefully filed up to the lines marked upon the face, and finally driven into the die about  $\frac{1}{16}$  in., which will produce the required shape on the

end of the punch. The punch can then be put back again into the fixture, fig. 89, and carefully re-shaped, afterwards being filed until the punch passes into the die as freely as the nature of the work requires. The fixture for holding the punch upon the shaping machine, as seen at fig. 89, may be made in a variety of forms to suit the various requirements. The simple cast-iron fixture, fig. 89, is easily made and suits ordinary work if the shanks of punches are all made to some standard diameter. The hole  $H$  and the slot  $S$ ,

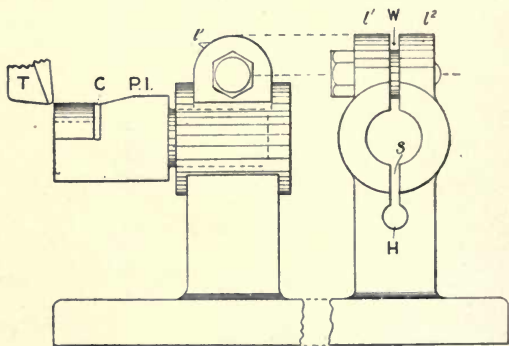

FIG. 80.

enable a certain amount of spring or closing of the hole to be obtained, when the pin is screwed into the lug  $l^2$ . The pin passes through lug  $l^1$ , and screws into lug  $l^2$ ; the washer  $W$  is placed between the two lugs to prevent too much strain being put upon the lugs which might perhaps cause a break. This washer should be made of such thickness that it is just sufficiently free between the lugs to allow the shank of the punch to be gripped firmly.

## CHAPTER IX.

## DIE MAKING BY DRIFT.

As illustrating how any number of dies may be readily made to one standard size and shape, take the case of a cutting-out die for cycle-chain links. It is possible to make dies or beds of this kind by the hundreds, so that they shall not vary more than one thousandth part of an inch. Figs. 90 to 93 show a good method of making these and similar tools. A standard bed and punch would first be made by the method described by figs. 83 and 84, for making standard dies and punches. The bed would be called the standard bed, and must necessarily be made very carefully; in fact, both bed and punch must be made absolutely accurate, the punch being sized so that it can just be pressed into its bed or die, being what is known to a tool maker as a tight fit.

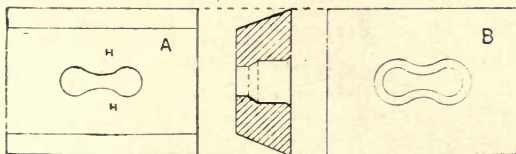

FIG. 90.

Now, referring to fig. 90, the die is seen in plan at A, and the inverted plan B shows the bottom of the die; between A and B the die is seen in section. Supposing this standard die to have been finished, hardened, and tempered, the next step is to prepare an accurate drift, with which it may be finished, or sized and corrected, so that all subsequent dies will be alike in shape and size. This drift will deal with the bar H H of the die, fig. 91. The method of dealing with the round holes or large ends of this die may for the present be left out of the question, as that portion of the

work requires separate attention. To make the drift, procure a piece of tool steel about 3 in. long, and of such sectional area that will allow it to be shaped up for its whole length, the same shape as the hole in the standard die, figs. 90 and 91. Having first filed up the ends and covered them with sulphate of copper, mark out the shape on each end, and indicate by small centre dots, plane or

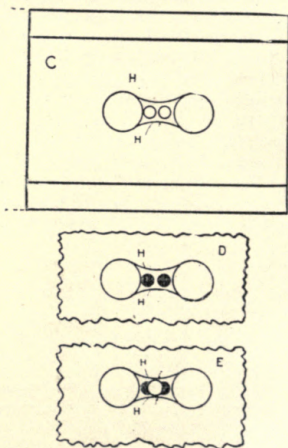

FIG. 91.

shape it from end to end by means of the shaping machine, afterwards carefully file it with suitable files until it is possible to pass the drift straight through the die with the assistance of light blows from a hand hammer. It is not an easy matter to make this drift, and it requires the greatest possible care and judgment to be exercised during each step in the process, and the micrometer gauge should be used throughout, for if the drift was carelessly driven through



the standard die a tight driving fit it would be liable to burst the die, in addition to the drift being so ripped and knocked about as to make it absolutely useless.

The standard die, fig. 90, is used more as a guide to shape, and to enable the extreme ends of the drift to be fitted with the die, rather than to be used for forming the

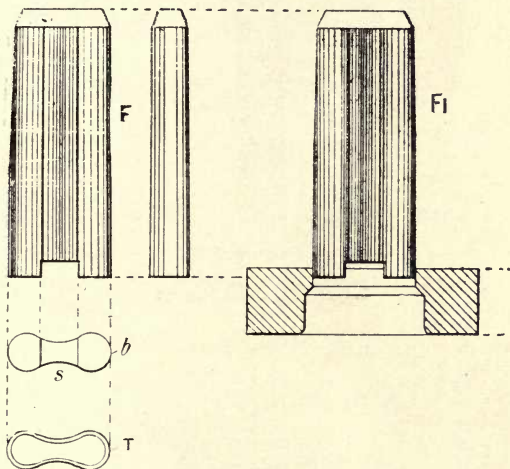

FIG. 92.

general shape of the drift for its entire length. This must be done by careful filing, when the drift has been made perfectly parallel and of uniform shape. The next step will be to file a clearance or taper for about half its length, leaving  $1\frac{1}{2}$  in. parallel. At the end of the clearance make a distinct bevel, so that a hammer may be used freely upon this bevelled end, which may now be called the head of the drift, seen at T, fig. 92. At the other end of the drift it

will be necessary to file away the centre *S*, in the manner shown at fig. 92, thereby forming two small horns *b*. These horns are important to the successful use of the drift, as their office is to fit round holes in the die, thereby guiding

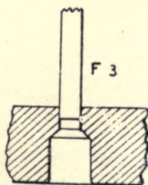
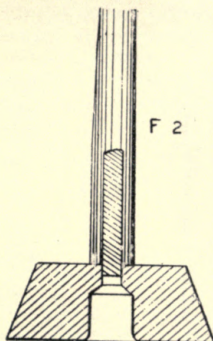

FIG. 93.

the drift, and helping to keep the drift perfectly perpendicular, whilst the bar part of the drift is rectifying the bar part of the die. The drift being finished may now be hardened and tempered its entire length to a dark straw colour, and attention may now be directed to the use of this drift.

The die, fig. 91, having been marked out and had the two larger holes drilled by a method that will be explained later, it will be seen that these two larger holes represent the ends of a cycle-chain link. The drilling of these holes will leave a distance between them in the form of a bridge, from hole to hole. This bridge is known as the bar part of the die. To remove the metal of this bar, first drill two small holes  $H_1$   $H$ , fig. 91 (C), either by the use of a special jig or otherwise, then plug up these two small holes by driving in soft

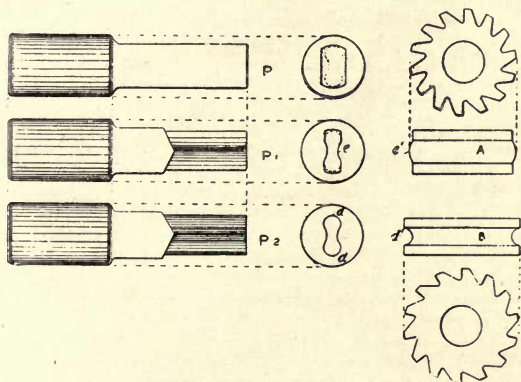

FIG. 94.

iron wire, and file them off level (see section of die at D). Having plugged the small holes, a third hole may now be drilled directly in the centre (see section of die at E). Now remove the part of the plugs that remain, and carefully chip and file away the bar, leaving a few thousandths of an inch to be removed by the drift. Fig. 92 shows the die in section, and it will be noticed that the drift is in position ready to be driven through. Another section is shown at F 2, fig. 93; and a third section of the die, F 3, shows the centre or bar part of the drift only as it passes through the die.

The standard die or bed, fig. 90, may be kept and used to finally correct all punches before they are hardened and tempered. The various stages of machining the cutting-out punch is shown at fig. 94, where P is a steel forging, which has been centered and had its shank truly turned, and the required shape dotted out upon the cutting end. The punch may then be placed in the special fixture seen at fig. 89, to enable the part *e* at P 1, fig. 94, to be milled away. This would be done with the cutter A<sub>1</sub>, an ordinary milling cutter. Passing to P 2, it will be seen that the ends  $d_1 d_1$  have been milled away with the milling cutter B. The punch may now be carefully fitted into the standard die A, fig. 90, by means of filing.

The complete set of tools for piercing the two holes in a driving chain link are a good example of accurate tool making. These tools illustrate the application of steel bushes for accurate piercing. A bolster B, fig. 95, planed top and bottom, and having two holes, one of which is seen at X, drilled and tapped, is ready to receive the pin, fig. 100. Two such pins serve the double purpose of setting up the small piercing dies, O, P, fig. 95, and allow the piercing bits or small blanks to drop through the long hole that is drilled through the centre of the pins for this purpose. The die holder D H receives the piercing dies O, P, which are held in position by a small set pin, seen in the part section of the die at fig. 95. The die holder D H is fastened to bolster B by four screws. The false nose or punch holder F N is made from a Bessemer steel forging, shaped out to receive steel pieces A, B, and C. These are held in position by set screws. Another thinner steel piece D is fitted into the punch holder, and hardened to receive the thrust from the punch ends when they are piercing blanks.

The thickness of steel piece B determines the centres of the punches, since the holes for receiving them are drilled at the point where the faces of A, B, and C come together. After the punch holes have been drilled in steel pieces A, B, and C a little would be filed off the faces F 1, F 2, F 3, F 4 (see fig. 99). This would enable the pieces A, B, and C to firmly grip together the punches, when the set screws shown at fig. 95 are screwed up firmly. A plan and inverted plan of the punch

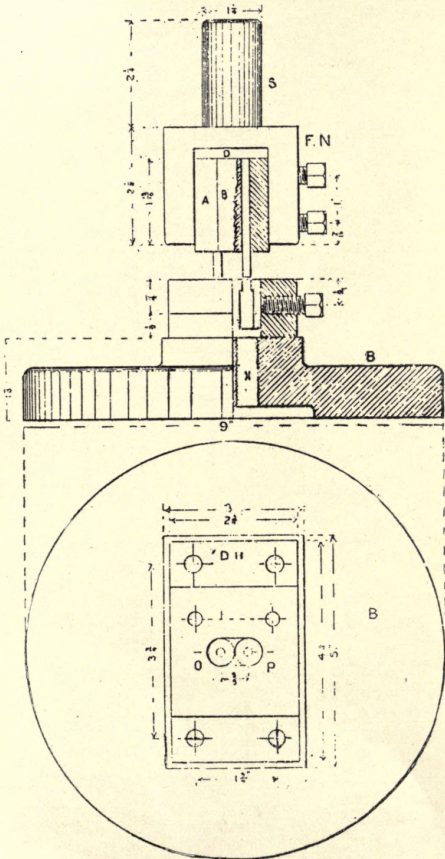

FIG. 95.

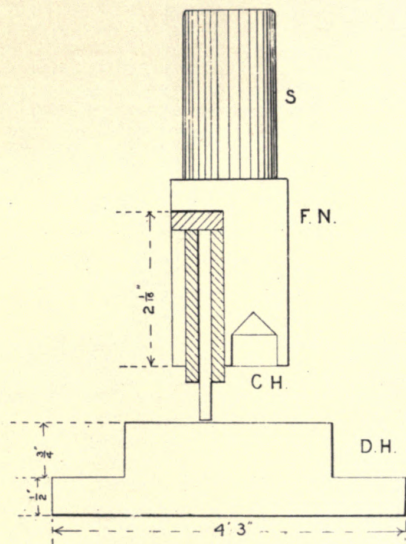

FIG. 96.

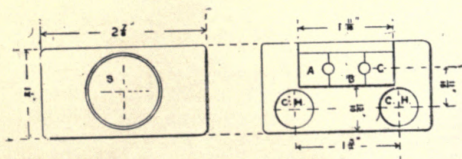

FIG. 97.

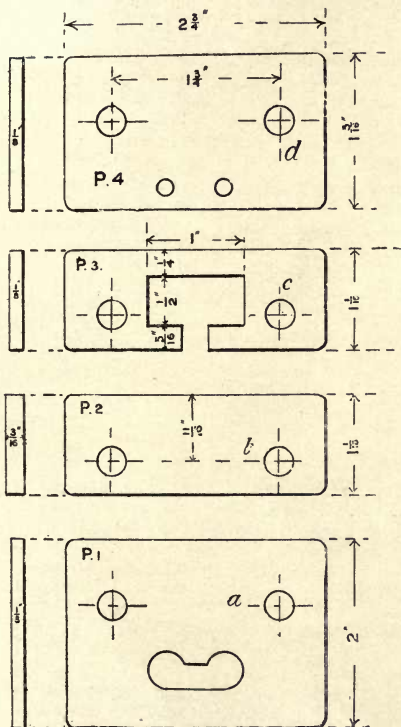

FIG. 98.

holder is seen at fig, 97. The clearance holes C, H are to allow the punch holder to come down close to the stripper

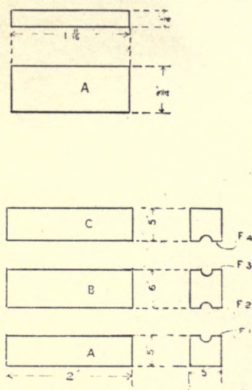

FIG. 99.

plate, and in doing so to clear the nuts of the stripper bolts N, fig. 101. Unless these holes were drilled in the punch holder it would be necessary to let the piercing punches

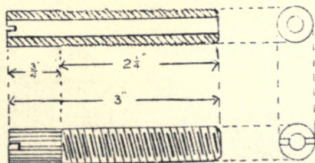

FIG. 100.

stand out further, probably causing them to spring during working. The guide plate P 1, fig. 98, guides the blank and



holds it in position whilst it is being pierced. P 2 is a packing plate, and P 3 is another plate, which has a slot in it to receive a small tongue piece and spring, and is known as the knock-out or flipper, their office being to extract and throw the blank from the tools after it has been pierced. The plate P 4 serves the double purpose of guiding the piercing punches and stripping the blank from the punches after it has been pierced. The four plates P 1, P 2, P 3, and P 4 are all bolted to the top of the die holder in the order of their numbers, thereby forming a complete set for holding, piercing, stripping, and extracting the blank from the tools.

The author's object in giving the chain link as an example of cutting and piercing, is that he considers it to be a class

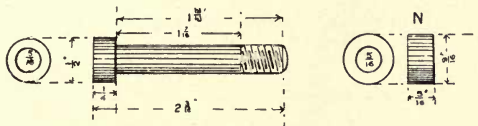

FIG. 101.

of work requiring exceedingly accurate workmanship. It therefore forms a good specimen for the student to investigate, and on several of the sketches are given the actual working dimensions, thereby enabling the student to use them as a guide in designing similar tools to be applied for other purposes than the chain link blank.

A complete set of tools for cutting out a chain link are shown in figs. 102 to 106. The combined die holder B receives the die D, which is keyed in position by K, the strip of metal from which the blanks are cut being fed into the tools by the feed rolls R, R. The making of these punches and dies has been explained in reference to figs. 90 and 94. The combined metal guide and stripper, figs. 104 and 105, is fixed upon the bolster by the double-screwed pins, one of which is seen at fig. 104. The short end of these pins is screwed into the holes A, A of the die holder B (see fig. 103), and the stripper plate can be raised or lowered at will over the top of the die D by means of the two lock nuts (see fig.

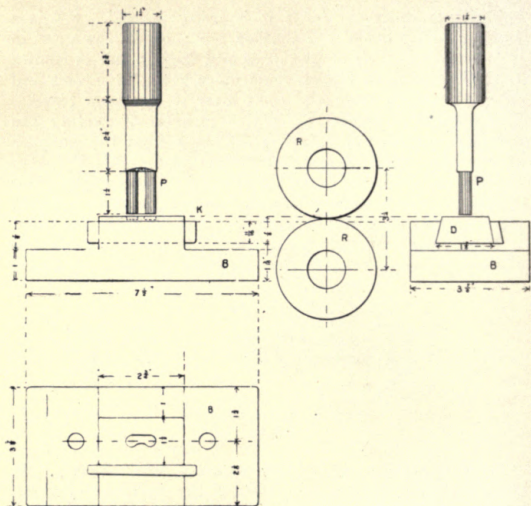

FIG. 102.

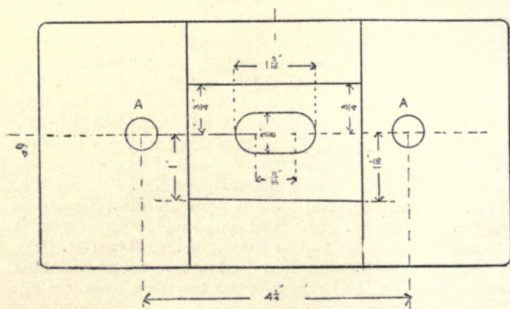

FIG. 103.

104). G, G are the guides shown on the inverted plan. Reference to this useful type of combined guide and stripper arrangement will be made in a subsequent chapter on tool setting.

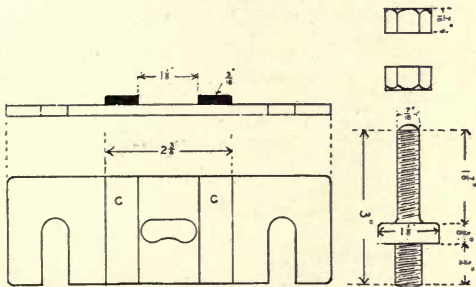

FIG. 104.

Another interesting example of the use of steel bushes for accurate production is the drilling of a small chain block of figure 8 section. The tools for this operation are seen in

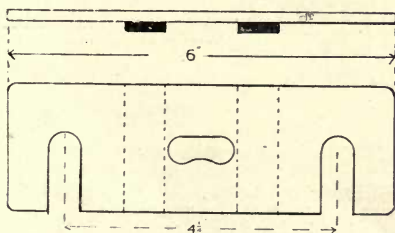

FIG. 105.

detail, figs. 106 to 110. The centres of the holes to be drilled in the block are  $\frac{1}{4}$  in., and these centres are obtained by means of the small steel bushes. The centres may be

reduced or increased by a method which will be explained in another chapter. Referring to fig. 106, a plan C, a side elevation B, and an inverted plan A of the complete jig are seen. The block to be drilled is held firmly by the thrust from the end of slide S, which is screwed up by the handle H. At fig. 107 the jig is seen in position upon the table T

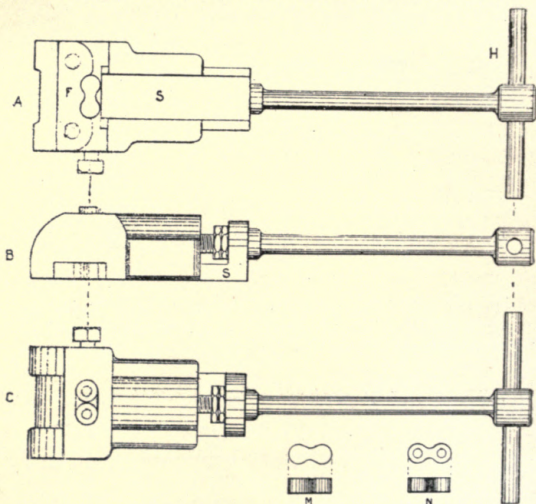

FIG. 106.

of a vertical sensitive drilling machine, ready to receive the drill through the jig bushes. The drill is held in the drill chuck D C by a very simple and reliable means. It may here be mentioned that in the case of the ordinary and well-known types of self-centring chucks, as used by tool makers and machinists, two and sometimes three jaws are brought together by small screws. Although these are very

useful and reliable when in the hands of skilled mechanics, they may become a source of trouble and expense when in the hands of unskilled labour. There are instances where unskilled labour have the setting of their own drills, and where the required rate of cutting makes it very essential that the drill be gripped very firmly on account of the rapid-cutting action of the drill, tending to cause the drill to rotate in its own chuck. This necessitates a strong, cheap, and reliable chuck being placed into the hands of the operator. Such a chuck is seen at fig. 108, where the drill is received into a long bush B, having one side cut away—

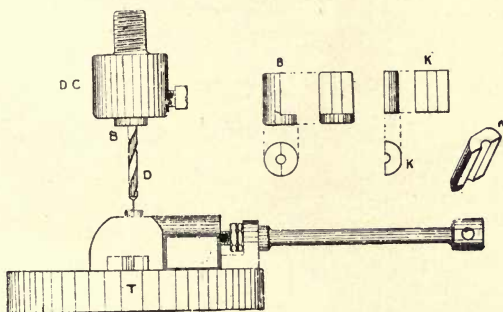

FIG. 107.

after it has been drilled—to receive a separate piece K. The set-pin for gripping up the drill is brought against the back of K, there being a flat filed upon K to receive the thrust from the end of the pin. This form of chuck will stand a great amount of rough usage without getting out of order. Fig. 109 is the guide-thrust plate, used for setting the block into position. The plate is first drilled, as shown, afterwards being shaped away to fit the shape of the block (see F, fig. 109). The thrust slide S of this drilling jig is shown at fig. 110, there being three views: a side elevation S 1, an inverted plan or view of bottom 1 P, and a plan or top view P.

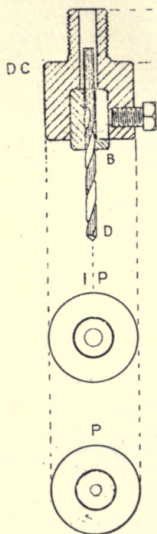

FIG. 108.

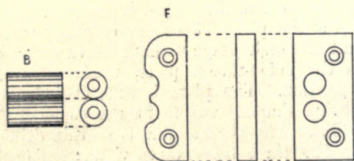

FIG. 109.

An example of wire-working tools, as showing the application of the punch and die for such work, is seen in fig. 111. The complete set of punches and dies are shown for automatically flattening, double piercing, and cropping or cutting off an umbrella stretcher. The wire at the top of the drawing gives the four stages A, B, C, D in the progress

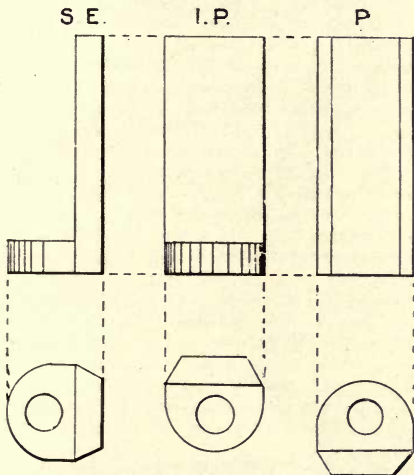

FIG. 110.

of the work. The wire is fed through the machine by means of a grip-feed, which is worked by a crank and connecting rod. The stroke of this crank can be varied at will, and the length of stroke given by the crank will determine the length of the finished stretcher. The blocks or castings carrying the tool slides, into which the various tools, punches, and dies are fixed, are necessarily set a certain distance apart, suitable packing pieces being used to give the required distance. To deal with each length of stretcher

that is being made on the machine the plate-iron packing pieces are dropped between each set of slide blocks. The four sets of slides are worked by levers and rollers; they are connected to act at the bottom of the slides, and are actuated by means of cams and cam shaft working under the bed of the machine. Beginning at the right hand side of the drawing, fig. 111, the flattening punches are seen at A. They are ground upon their ends to produce the flattened shape seen on either side of the wire. The second and third set of tools are the two sets of piercing tools. Each die is backed up by a long set pin, which is used for setting up the dies, a hole being drilled through the centre of the pin, through which the piercing bits pass and drop into an iron box. The fourth and last set are the cropping tools. The cropping punch is shaped upon the end to the exact shape necessary to remove the bit of scrap to form the two ends of the stretcher. The cropping die is of peculiar and novel construction. It is formed or built up by placing two pieces of round steel at a certain angle so that when they are moved forward by the set pins at their back ends the distance between their cutting ends will be reduced. This may sometimes be necessary, should it be desired to make the punch and die a better fit. The cropping punch, when being made, can first be roughed out, then put into the machine, and carefully worked up against the cropping die so that the two pieces of round steel which form the die would gradually cut away the end of the punch into the required shape.

Upon the extreme left of the drawing, fig. 111, the end views of the four sets of tools are seen. A very neat arrangement is here shown for fixing and adjusting the small piercing punches. A taper hole is bored in one end of the slide, and in the other end a larger hole is drilled and tapped to receive the punch-holder. The holder is bored for a portion of its length to receive the piercing punch. A clearance hole is then put in for the remainder of its length to receive a long thrust rod, and finally the back end of the holder is tapped to receive the backing-up set pin S P, after which the punch holder is sawn along one side of its taper end, as seen in the end view. From this it will be readily understood



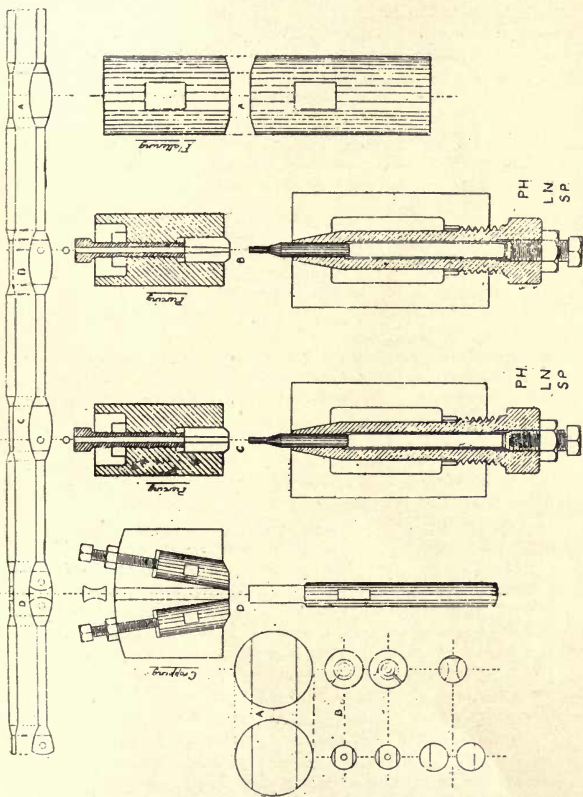

FIG. 111.

that if P H be unscrewed, say half a revolution, this liberates the piercing punch. The lock nut L N can now be loosened, and the punch advanced as required to enter the die by means of the backing-up pin S P, after which L P can be locked again, and finally the punch holder P H can be screwed into position, thereby forcing the taper end of the punch holder into the taper hole of the slide, and closing the ends of the punch holders firmly upon their respective punches. All four sets of tools can readily be adjusted whilst the machine is in operation.

---

## CHAPTER X.

### METAL SPINNING.

METAL shells, after being cupped, drawn, or raised, have sometimes to be expanded, necked, bulged, or otherwise altered in shape. In some instances this is done by means of special expanding dies, and closing, necking, or reducing dies; but usually the operations of bulging or necking are performed in the spinning lathe. The lathe consists of a bed fitted with a fixed headstock, which carries the chucking mechanism for receiving such articles as are seen at A, B, C and D, fig. 112. These represent common examples of spinning. They are held in position by a moveable tail stock. The spinning operation is usually performed by special burnishing or friction rollers, these being carried upon a compound slide rest. The pressure of these rollers or burnishers against the article forces the metal to flow into the desired shape, the outline being governed according to the point at which the pressure of the rollers is brought upon the article. The examples E, E 1, F, F 1, fig. 112, are of cornish-pole end stampings, the small amount of spinning required on these being to connect the two halves together. This would be done by fixing one half of E or F in the chuck, and expanding a little at O or L by means of a hand-spinning tool. Then E 1 or F 1 is taken up by the hand to insert P into O, or M into L, after which O or M is rolled or

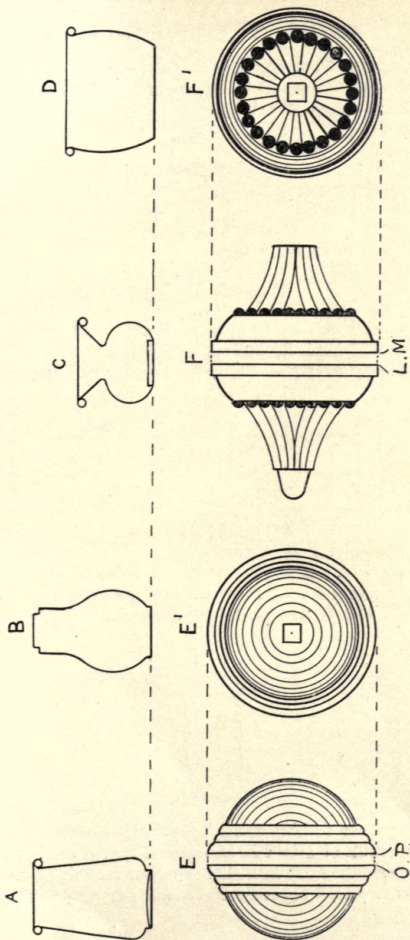

FIG. 112.

spun over P or L, as the case may be, by exerting a slight pressure upon the metal by means of the hand-spinning tool. The various stages of this method of spinning are shown at

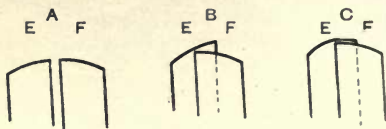

FIG. 113.

A, B, C, fig. 113. The first shows E and F alike. In the second stage E is seen to have been expanded, whilst F has been inserted into E, and in the third stage E has been rolled or spun over F. Another example of joint spinning,

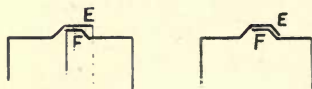

FIG. 114.

where the metal is turned down at a sharp angle, is seen at fig. 114. A copper float ball for a water cistern and tank work forms a good illustration of jointing (see fig. 115), where A and B are portions of hemispheres which are

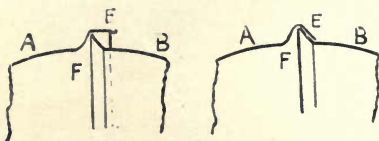

FIG. 115.

jointed together to form the sphere. Hemispheres A and B are both drawn or raised in the same die, afterwards the edge of one is trimmed off in a slitting shear machine, and when A and B are joined together the broad edge E overlaps the

smaller edge F. This rolling or spinning joint metal work is done in many different styles, and by the assistance of quite a variety of special tools, but figs. 113, 114, and 115 will serve to illustrate the principle upon which the spinning is carried out.

Much of the ornamental work, such as bedstead knobs and similar mounts, used for central and end embellish-

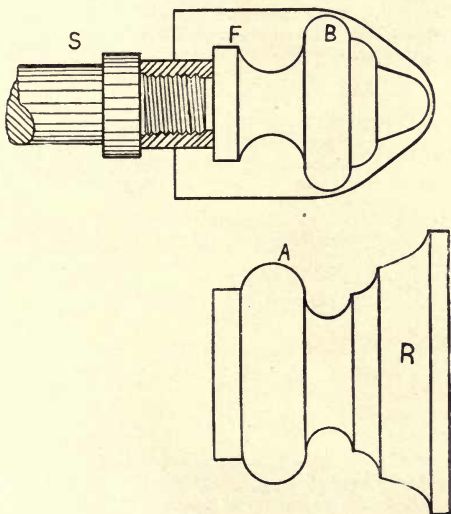

FIG. 116.

ments, are changed in form after they have left the drawing press, by means of a simple high-speed lathe containing a former in the end of its spindle (see fig. 116), where the arrangement is that a spindle S carries a former, which goes inside the work to be shaped. The metal cup C has been

drawn in a press, and is about to be shaped to the former F, which is made sufficiently small in diameter for the purpose. Its largest diameter must never exceed the smallest diameter in the work to be shaped, or the articles shaped thereon could not be drawn off when finished. A simple roller R is used, mounted between the forks at the end of a suitable lever. This lever will be seen at fig. 117, and it would be worked preferably by the foot. The contour of the roller corresponds with the shape of the exterior of the finished article, only it may be much larger in diameter.

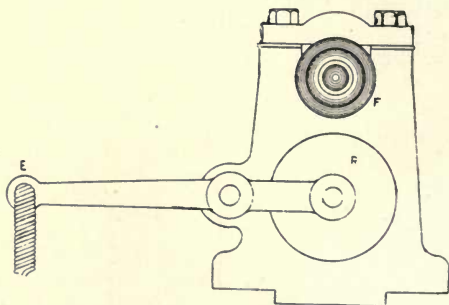

FIG. 117.

The partly-formed article is slipped on to the former, and held against it, whilst the pressing on the end of the lever at E causes the external roller R to force the sheet brass to the form of the central mandril, or former F. This causes the work to rotate, and by this means swells and indents can be rapidly formed on any raised or drawn article, and the cost of labour is very trifling. Not only can plain swells and indents be formed, but ornamental work can be done, such as milled edges, either straight, crescent shaped, spiral, or in the form of beads; in fact, this arrangement enables many designs to be produced that cannot be done by any

other way but casting, and it has the great advantage of cheapness as regards the tools, another advantage being that skilled labour is not required to work the tools. Referring again to fig. 116, when the article C has been shaped by the action of the rolling, the finished diameter of the cup must be sufficiently large to enable it to be readily removed from the former. In other words, the diameter of the part of the cup C, made by A on the roller R, must be large enough when finished to pass over the diameter of part B on the former F. This will be done by commencing with the proper sized cup, according to the shape of the article, and the amount of rolling required.

The operation of spinning the end of a wire rivet so as to form a head is a novel example of the useful application of spinning rollers. Fig. 118 is one of two chucks that would be employed in spinning both heads H, H<sup>1</sup> of the rivet A.

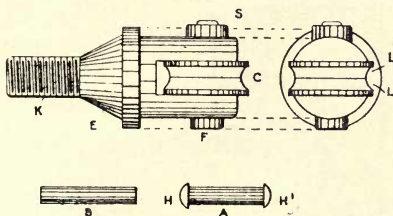

FIG. 118.

The chuck at K is screwed into the spindle of a small special lathe, the coned part E also fitting the spindle. The front end of the chuck is slotted to receive rollers L, L, and when these two rollers come together in the chuck (the centre point C of the rollers L, L comes exactly in the centre line of the chuck itself) each roller is curved on one edge, so that when the two come together in the position shown, the curved form on the two rollers shall be the curve that is required upon the head of the finished rivet. These rollers rotate upon the pin F, which is made a driving fit in

the chuck, but a loose fit in the rollers, and secured by the nut S. Assuming the chuck and rollers to have been fitted up perfectly true, it will be readily understood that, when the whole rotates together, the joint line C between the rollers, and the centre of the transverse hole in the rollers, will both be in perfect alignment, with the centre line through the chuck and lathe spindle.

Now, supposing two such chucks and their rollers to be mounted on the lathe and rotated at a high speed, if the rivet B, fig. 118, be held perfectly central and firmly between the two chucks, and the chucks pressed up against the ends of the rivet B, the result will be that the rollers L, L will rotate in opposite directions, and a very light

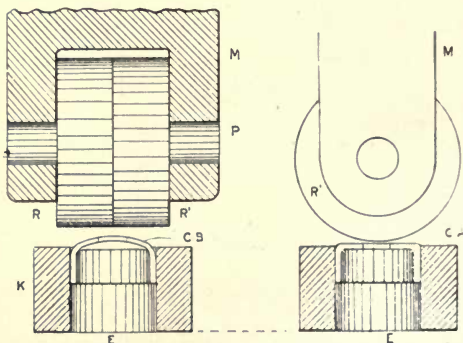

FIG. 119.

pressure will cause the rollers to spin over the ends of the rivet, thereby forming the heads H, H (see rivet A, fig. 118) where the rivet has been headed. This arrangement has been used extensively and successfully in connection with the manufacture of driving chains, in preference to riveting by means of either a hand hammer or power hammer.



Another example of spinning (see fig. 119) further illustrates what actually takes place during the operation of spinning sheet-metal articles by means of rollers in a lathe. A chuck M is mounted upon the spindle of a vertical drilling machine, and a pin P is driven through the chuck to carry the rollers R, R<sup>1</sup>. A steel cup CB, which has been previously drawn and pierced, is placed in the holder K, fig. 120, afterwards the holder and cup receives a cylindrical plug. The holder K is held by being fixed between the vice jaws

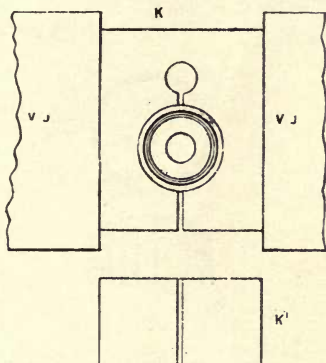

FIG. 120.

(see fig. 120). The cup CB has a curved end, and is exactly the shape that it would be when it leaves the cupping tools (see fig. 121).

Now, having secured the cup CB, the plug and the holder K all in the vice, so that the centre of the cup CB stands directly under the centre of rolls R, R<sup>1</sup>, if the spindle and chuck are rotated, and the rolls R, R brought down upon the end of the cup, they will roll in opposite directions, and roll or spin the end of the cup perfectly flat, as seen at CA, fig. 119. The cylindrical plug A forms the anvil, and the curve on the end of this plug governs the inside shape of the cup.

Fig. 122 is a useful and cheap form of chuck, which may be made of either cast or wrought iron, and used for chucking cups of this kind to enable them to be operated upon by turning tools in a lathe. A section of the chuck is given, from which its form will readily be seen. After being screw-cut at N to fit any lathe spindle, it is bored out at L to receive the cup CA; it is also counter-bored as large as possible (consistent with strength) in the centre of its length to ensure of the chuck springing at T when under pressure of the pin collar C of the pin P. A hole V is drilled at right angles to the pin hole, a slot S being afterwards sawn



FIG. 121.

from the front of the chuck into the hole V. The fact of the metal chuck being comparatively thin at T, assisted by the hole being drilled at V, ensures sufficient springing of the chuck under the pressure of the pin P to firmly grip the cup CA. Chucks of this type may be quickly altered by re-boring to accommodate a new size of cup, or they may be completely faced off at the front end when worn down and be again re-bored to suit a smaller-sized article.

The process of building up a roller-chain link having separate bosses will serve as an example to show how the extracting mechanism may be actuated by the slide of a power press; at the same time the usefulness of the power press, as a means of reducing the cost of production, may be seen from this operation.

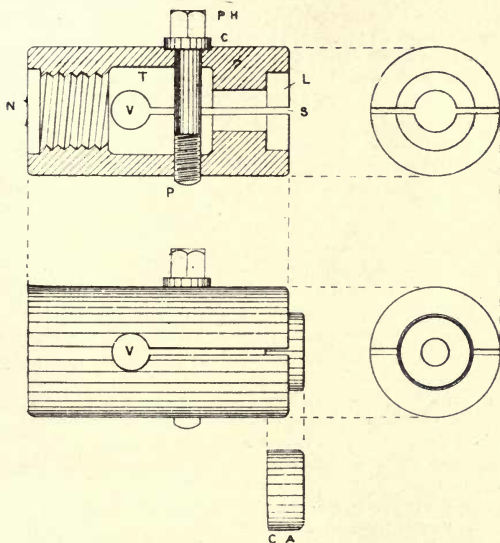

FIG. 122.

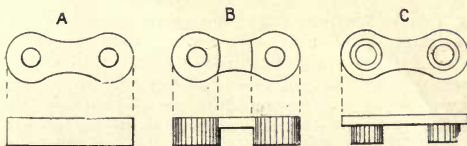

FIG. 123.

Referring to fig. 123, it is required that the blank A shall have the metal so cut away from one side as to form two small bosses. To do this the blank is first pierced, it is then fixed upon two pegs in a lathe, whilst a special milling cutter is brought up against one of its sides to remove the metal from the centre (see fig. 123 at B). Finally, another smaller milling cutter forms the two bosses separately, to complete the bosses as seen at C. From this it will be evident that to make large quantities of similar plates would, in addition to being a great waste of metal in forming the bosses, necessitate a large number of small milling lathes being employed for the operations, besides using up quantities of cutters. It was to overcome these difficulties and to make the production cheaper that the tools seen at fig. 124 were introduced. Passing to fig. 125, another blank A is seen, this time cut from metal of suitable thickness as required for the finished article. The blank has two holes pierced in it, equal in diameter to the outside diameter of the required bosses. Two pieces of cylindrical steel E, E are cut off a bright rod, and forced into the blank A. The next operation will be to use the tools as seen at fig. 124 to 127. These tools are fitted in a heavy double sided power press. The construction of the punch holder, die and die holder, or the methods of holding the punches and dies needs no explanation, these having been previously described in chapter 8.

Referring to fig. 124, a slot is planed straight across the bolster K, to receive the square piece of steel H, and when H is allowed to fall so as to reach the bottom of the slot the two steel pegs E, E are pushed down the holes of the dies. These steel pegs E, E are of such length that when one end rests upon the top of H the other end stands below the top of the die. The correct distance that E stands below the top of die is a little less than the length of the boss E on the blank B, fig. 125. From this it will be evident, by referring to figs. 124, 126, and 127 that when H, E, E are in their lowest position the two bosses E, E could be dropped into the holes of the die, leaving the blank on the top just clear of the die. The press is next moved through one revolution of its crank shaft, during which time one down stroke and one up stroke are made ; on the down stroke centre punches P, P

will punch the centre holes O, O of the blank B, fig. 125. The process of punching these centre holes will expand the small

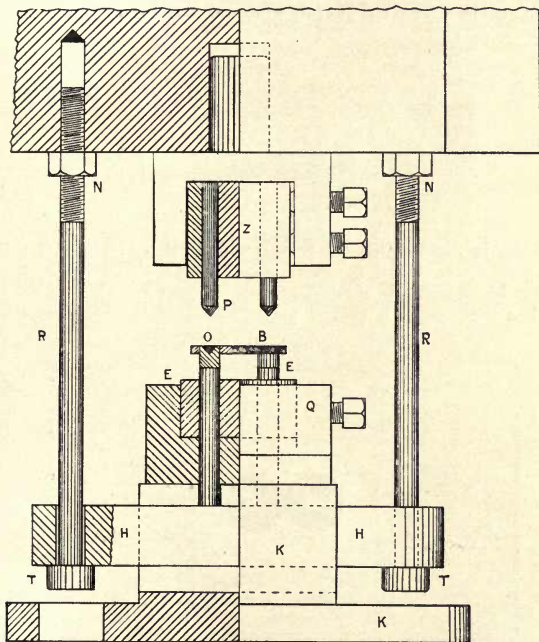

FIG. 124.

bushes E, E, fixing them very firmly in their respective holes in the blank.

These centre holes will afterwards serve to guide the drill for drilling the first sized hole in the bosses previous to their

being finally corrected by a second drilling in a suitable jig. Upon the up stroke of the press the rods R, R, which are connected to the slide, would lift H, E, E, and thereby extract the article B from the die; B will now fall from the tools.

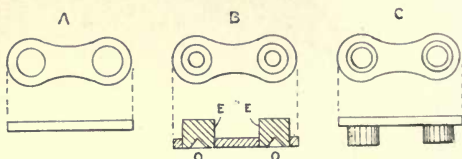

FIG. 125.

It will be noticed that the slide is shown in fig. 124 upon the top stroke, and the question may be asked, how can the next blank and pair of small bushes be placed into the die when the pegs E, E project above the top of the die? The

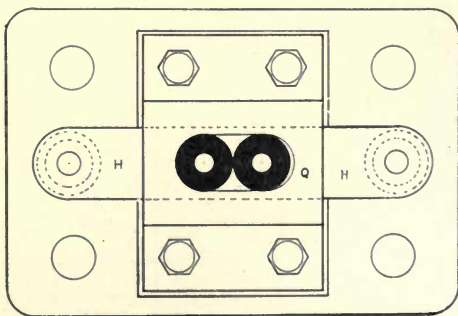

FIG. 126.

answer to this question will explain the value of the arrangement. As a matter of fact, the rods R, R are shown set in the wrong position, and to set the rods properly for the work now being performed in the press the nuts N, N must

be unlocked, and rods R, R unscrewed sufficient to allow H and pegs E, E to fall down into such a position as to bring the tops of pegs E, E a distance below top of die, equal to about one-sixth the length of the bosses on the blank. This will allow the small bosses to be placed in the die, then when the punches come down in their travel they will force the bosses into the die until neither bosses, pegs, or H can be driven further. The punches will then complete their work. From this it will be seen that by lengthening or shortening rods R, R the bar H can be placed in any relative position when the slide is on the top of the stroke, these relative positions being obtained by giving more or less *lost motion* at

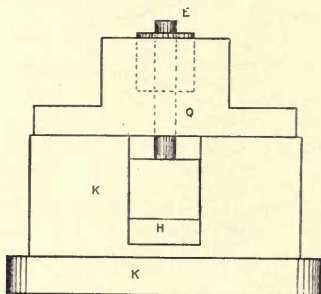

FIG. 127.

the heads T, T of rods R, R during the up stroke. When H falls upon the bottom of slot in K—if the press slide has not completed its down stroke—the heads T, T will leave the steel anvil H. Therefore, whatever distance there is between bottom face of anvil H and the inside shoulders of heads T, T will be *lost motion* to anvil H upon the return stroke, because heads T, T must necessarily travel some distance before commencing to lift the anvil H. Fig. 126 is a plan and fig. 127 an end elevation of the die and bolster, fig. 128 being an inverted plan of the chuck for holding the punches. This principle of extractor can be greatly modified to accommodate

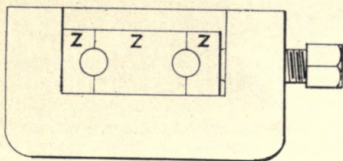

FIG. 128.

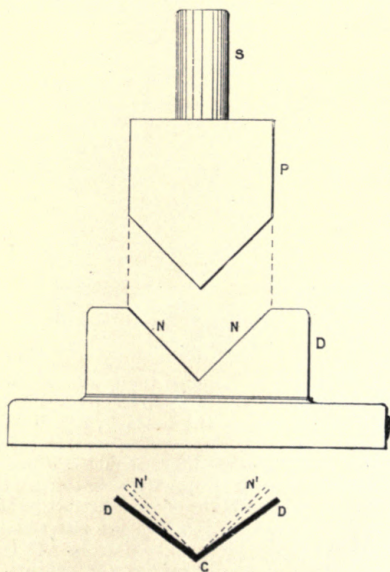

FIG. 129



the various requirements in either hand or power presses to suit different classes of work.

The bending of wire and metal strips usually refers to articles which have their surfaces moved into some new and permanent shape without their thickness being materially altered. They may, however, sometimes be slightly thinned at certain points, where the action of the bending tools have stretched them in bending a corner to some sharp curve or angle. When bending wire or strip metals it is sometimes difficult to decide upon the correct shape of tools to give the desired effect, since the metal will frequently spring back from the shape to which the tools have bent it part of the way towards its original shape. This is due to the elasticity of the metal, and varies according to its nature and temper. Lead and copper will give very little trouble in this way, but brass, iron, and steel are not so easy to manage. Fig. 129 represents a pair of tools for bending the steel wire D, D. The punch P, and the die D, would be made to press the wire into the form seen at N<sup>1</sup>, N<sup>1</sup>, but the wire, after being removed from the bending tools, would spring at the corner C into the position D, D. From this it will be readily understood that the bending tools must necessarily be made to bend the wire a sufficient distance to allow for its springing back. This frequently necessitates the altering of the curves on the bending tools after they have been tried. In the case of fig. 130 the springing action referred to would take place at both corners, C, C, the tools having been designed to carry the wire down to the shape shown at dotted lines N<sup>1</sup>, N<sup>1</sup>. The final outline of the article after the springing has occurred is indicated by D<sup>1</sup>, D<sup>1</sup>.

Fig. 131 illustrates the bending of a flat steel spring, S.S. When bending curves and angles, similar to those contained in this kind of work, the springing back difficulty must necessarily be overcome by careful experiment. In addition to this, it is often advisable to ease away the tools at certain points. It would appear to a new beginner that the proper way to construct such tools would be to make the face of the bending punch P, and the face of die D, to fit the top and bottom sides of the spring respectively, so that

when the bending tools are well up to their work the metal of the steel spring exactly fills the space between the faces of the punch and die. It is, however, found in practice to be much better for the working of the tools if they are eased off at certain points where the action of bending does not actually occur. There are several reasons for this. A

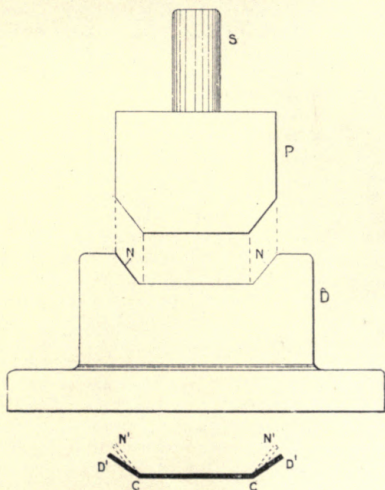

FIG. 130.

little dirt may accumulate in the tools, the metal may not always be of an exact uniform thickness for its whole area, or the peculiar shape of the curves upon the tools may be such as to make it difficult for the toolmaker to ensure the tools fitting accurately the curves on either side of the metal spring, thereby leaving the exact same space between the tools for the whole length of their curves. This is a

difficulty that could be overcome by *careful toolmaking*, but the rough nature of the work will scarcely warrant the expense of such care as would be required to carry this into effect. Particularly is this so by reason of the fact that by easing away the tools as before mentioned enables the bending to be done with very much less power required for the operation. Taking the case of the spring S, S, the punch would need to press hard at A, A, also at the bottom B, but it would be advisable to ease the punch away well at E, E, and it will further be noticed that the die has

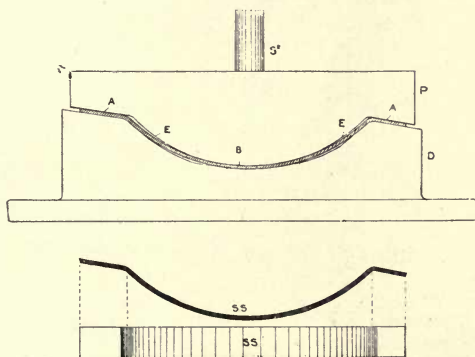

FIG. 131.

been eased away at two points a little below E, E, where a clear space is shown between the bottom of the spring and the die.

It frequently happens that large quantities of short lengths are required to be cut from long wire rods. An instance of this kind would occur in a hinge factory, where joint-wire rods would be required for connecting the two sections of the hinge together. There are also instances when wire rivets and similar wire lengths are required to be absolutely square at their ends when cut, and to be of

standard length. Figs. 132 and 133 represent suitable tools for cutting wires of this kind. The casting C forms the bolster, and it is bored to receive the die D. This die is drilled straight through, parallel, to receive the wire W an easy fit. The die D is held firmly in position by set pins, which are screwed into the lugs L, L. The set pins are not shown in the sketch. Another part A, of the bolster C, is drilled and tapped central, and in perfect alignment

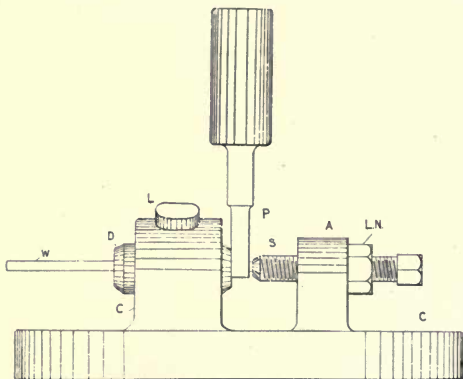

FIG. 132.

with the hole in the die D, to receive the set pin S, which is locked in position by lock nut L N. This set pin may be adjusted to form any given distance between the end of set pin and face of die. If cutting rivets  $\frac{3}{4}$  in. long the distance between end of set pin and face of die will be set at  $\frac{3}{4}$  in., so that set pin S acts as a stop gauge, to which the wire is pushed by the hands of the operator

The punch P, fig. 133, works up and down close against the face of the die, and is slotted for a distance up to pass freely over the wire. The top of this slot is made the form

of the wire to be cut so that the action of the punch, whilst chopping or shearing, shall not damage the wire. The die is made double ended (see fig. 132) so that both ends may be ground and used in their turn; and the fact of the die being a comparatively good length holds the wire sufficiently steady and square, although the wire may be an easy fit. Another example of chopping or shearing a rod is seen at fig. 134. R is a bright drawn steel rod, and would

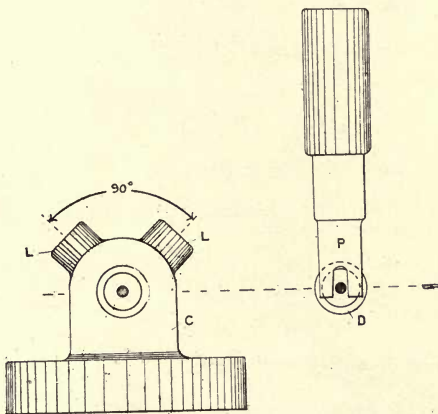

FIG. 133.

probably usually be supplied from the wire drawn in 12 ft. lengths. These rods, which are fig. 8 in section, will be finally sawn up into short pieces by means of slitting saws operated in a milling machine, but the 12 ft. lengths would be awkward to handle in the machine. They are, therefore, usually chopped or sheared up into, say, 4 ft. lengths, to enable the milling machine operator to handle them easily. The bottom shear blade B, would be about  $\frac{5}{8}$  in thick, and bolted on to a special bolster by bolts passing through holes

A, A. The punch P is about  $\frac{5}{8}$  in. thick at part T, and hollowed out the same as B to fit half section of the steel rod R. These tools may be fitted to either a hand or power press, and the face of P would slide up and down against

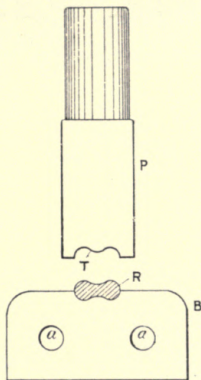

FIG. 134.

face of B, in the position as shown in fig. 134, thereby forming an efficient form of chopping or shearing set of tools. Both punch and die may be made perfectly square, no bevel being required upon either.

## CHAPTER XI.

## DRAWING AND RE-DRAWING.

DRAWING proper refers to the cupping of a blank, as in cutting and cupping processes, or in taking any piece of sheet metal in the form of a blank, and producing therefrom any cup-like shape during which process a flowing of the metal takes place.

The term re-drawing applies to any subsequent drawing processes that follow the first drawing or cupping process as would occur in the manufacture of a cartridge shell or similar work. For instance, if any blank be cupped it may

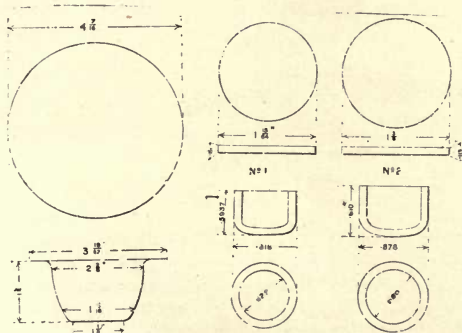

FIG. 135.

be said to have been drawn or had its first drawing. But if this same cup be further reduced in diameter by being passed through a second pair of tools, then the process of so reducing it will be called re-drawing.

Referring to fig. 135, we have two blanks and their respective cups, No. 1 and No. 2. The first, or No. 1 blank,

is  $1\frac{5}{8}$  in. diameter, and cut from metal  $\cdot111$  in. thick, it has been cupped by a cupping punch  $\cdot629$  in. diameter, and a die bored out to  $\cdot818$  in. in the hole, the thickness of metal has been reduced from  $\cdot111$  in. to  $\cdot0945$  in. during the cupping process. There has, therefore, been  $\cdot0165$  in. draw on the metal by means of the cupping tools. In the case of No. 2 the blank is  $\cdot113$  in. thick, it has passed through a die having a hole  $\cdot878$  in. diameter, the drawing punch being  $\cdot680$  in. diameter, there has been  $\cdot014$  in. draw on the metal. Had the punch been  $\cdot652$  in. diameter, the blank would have merely passed through the die, coming from the tools in the

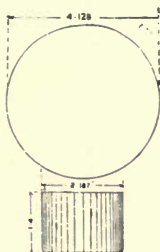

FIG 136.

form of a cup without any draw or flow of the metal taking place. From this it will be readily understood that in any case of drawing an article each process must be considered separately. The thickness of the metal blank and the outside diameter required for the cup are the two points that decide the diameter of the hole in the die. Then twice the thickness of metal blank subtracted from the hole in the die will give the diameter of the cupping punch, if no draw or flow of metal is required. But should it be required to reduce the thickness of metal during the cupping process, then twice the required reduction of the metal thickness must be added to the diameter of the punch. In cases where the size of the hole in the cup is the more important,



then the order of things will be reversed, the drawing being arranged by the diameter of the hole in the die—the larger the hole the less the draw, and the smaller the hole the more will be the amount of draw on the metal. A blank and its cup is seen at fig. 136; it will be noticed that the bottom of this cup has a rather sharp corner; this is a point that is governed to a large extent by the shape of the punch. If a sharp corner is required on a cup the end of the drawing punch should be finished by having a small radius on its corner, whereas—if the radius on the corner at the end of the drawing punch be made comparatively larger then the corner of the closed end of the drawn cup—will necessarily have a larger radius. In conical drawing the taper punch forces the blank into a taper die, after which the conical cup will be extracted or lifted from the die, either by the operator's hands or some form of extracting mechanism. The drawing of conical work may in a sense be called raising, in fact, it is at times very difficult to distinguish drawing from raising, because amongst the great varieties of metal work one blank may be stamped or raised in a stamp, whilst another article exactly the same shape may be raised in a power press, the article passing in and out of the die—not through the die—yet a certain amount of flowing may have taken place in the metal whilst the article was being formed into shape, which would probably warrant the term drawing being applied to the process.

Fig. 137 was made in combination tools, the blank being cut out, then held by the cutting-out punch *under pressure*, whilst the drawing punch (which may in this case be called a raising punch) comes down and draws or raises the blank into the shape, the article being afterwards *pushed* up and out of the die by an extractor. A somewhat similar example to fig. 137, but of smaller size, is shown at fig. 138. No particular rules with regard to re-drawing processes can be given, since the amount of draw or flow of metal required depends so much upon the nature of the work that is being done. A few examples, however, will enable the student to follow what actually takes place during the different stages of re-drawing. Fig. 139 gives the complete

processes for drawing a German silver shell or case for a cartridge, particulars of which will be found in Table 1.,

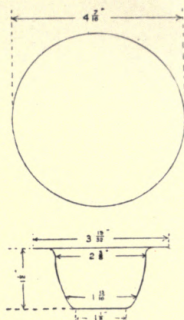

FIG. 137.

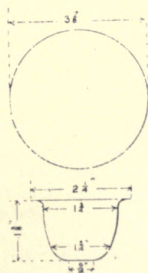

FIG. 138.

beginning with the blank, and finishing by cutting down or trimming the shell. The small metal sphere, fig. 140, is made in four processes, including the blank cutting. The

TABLE I.—EXAMPLE OF DRAWING GERMAN SILVER SHELL FOR CARTRIDGE.

Thickness of metal for blank '042.	Cupping, 1st process.	Extension, 2nd process.	Extension, 3rd process.	Extension, 4th Process.	Extension, 5th process.	Extension, 6th process.	Cutting down, 7th process.
Outside diameter of shell....	.613	.495	.421	.364	.331	.303	.303
Inside diameter of shell .....	.575	.461	.365	.315	.294	.70	.270
Reduction in thickness of shell..	.008	.002	.004	.005	.000	.002	nil
Length of shell.....	.4375	.5375	.8125	1.0625	1.3125	1.625	1.3125
Reduction in outside diameter ..	..	.148	.074	.657	.033	.028	nil
Difference between outside and inside diameter of shell.....	.008	.064	.056	.049	.037	.033	.033
Increase in length of shell for each process .....	..	.1	.2750	.250	.250	.3125	{ Out if or trimmed
Thickness of metal in shell .....	.034	.032	.028	.0245	.085	.0165	.0165

TABLE II.—EXAMPLE IN DRAWING SMALL METAL SPHERE.

Blank 1.2812 in. diameter by .045 thickness.	Cupping, 1st process.	Extension, 2nd process.	Part closed at t.p. 3rd process.	Closed to sphere shape, 4th process.
Outside diameter of shell.....	.757	.570	Expanded to .610	Diameter of sphere .642
Inside diameter of shell .....	.688	.482	Hole at top of shell .3437	Inside diameter of sphere .554
Reduction of metal—thickness of shell .....	.0005	0005	nil	nil
Length of shell.....	.480	.850	.745	Diameter of sphere .612
Thickness of shell .....	.0445	.044	.044	.044

first process, A, will be cutting and cupping the blank in combination tools; the second process, B, is a re-drawing process, or extending the previously cupped blank; the

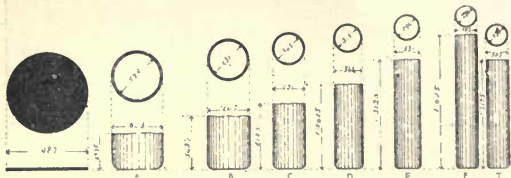

FIG. 139.

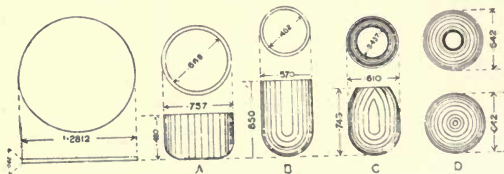

FIG. 140.

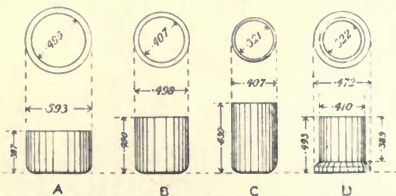

FIG. 141.

third process, C, is to part close the open end of the shell; and in the fourth process the shell is worked into a sphere by means of a special punch and die, which may be either

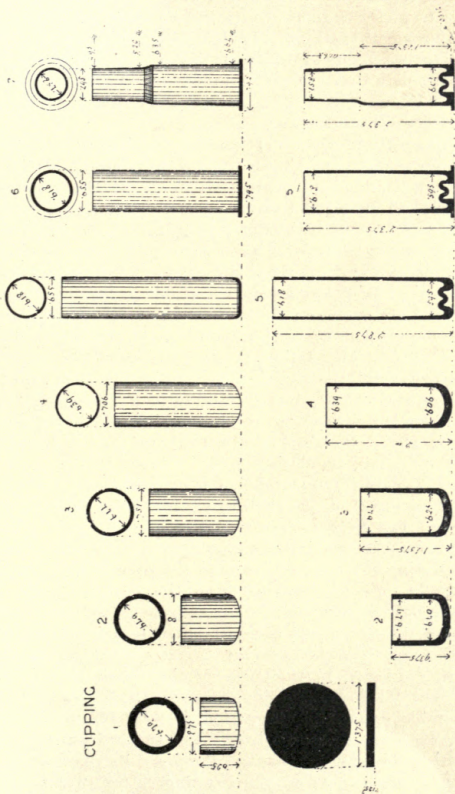

FIG. 142.

called balling tools or closing tools. Particulars of the dimensions at the various stages will be found in Table II.

Another small shell, fig. 141, is drawn and headed. The particulars relating to this example are contained in Table III. The particulars that are given in Table IV. relate to the processes of drawing a small metal shell, but there is no drawing given to this example.

The complete processes of drawing and heading one form of cartridge shell are shown at fig. 142, and a study of Table V. will provide all particulars to enable the processes to be followed during the various stages. After cupping the blank the re-drawing, extending, lengthening, or deepening is carried out by a series of successive stages, at the same time reducing the diameter of the cup, or which we may now call a shell or tube, having one end closed. The number of stages that are necessary for re-drawing or deepening a shell will greatly depend upon the condition of the metal when being worked. The action of the drawing tools tends to harden the metal, thereby making it necessary to anneal the article several times during the various stages through which the shell passes, to be formed into the long shell. The open end of the shell is afterwards reduced or closed by special reducing or closing tools. Work of this kind is frequently required to be tapered inside the shell; in other words, the metal of the shell to be thinner at the open end than near the head. This thinning of the metal will be brought about by making the drawing punch slightly taper. Then, during the drawing process, the punch being smaller in diameter for some distance from the end, will pass the shell through the die with comparatively little draw until it reaches the larger part or swell on the punch, when a flow of the metal will be brought about, resulting in the required reduction in thickness of the metal shell. The shape, both inside and outside drawn shells, is governed to a considerable extent by the shape or form of the drawing punch, both for its whole length and the end which enters the work for carrying it through the die. By increasing or decreasing the radius on the drawing corner of a punch a corresponding increase or decrease may be obtained at the corner of the article that is being drawn. But a point of

TABLE III.—EXAMPLE IN DRAWING SMALL METAL SHELL.

	Cupping, 1st process.	1st re-draw, 2nd process.	2nd re-draw, 3rd process.	Heading, 4th process.
Blank .995 diameter by .05 thickness.				
Outside diameter of shell .....	.598	.498	.407	.410
Inside diameter of shell .....	.490	.407	.221	.322
Reduction in shell thickness .....	.0015	.003	.0025	nil
Length of shell .....	.387	.490	.630	.493
Thickness of shell .....	.0485	.0455	.043	.044

TABLE IV.—EXAMPLE IN DRAWING SMALL METAL SHELL.

	Cupping, 1st process.	Extension, 2nd process.	Extension, 3rd process.	Extension, 4th process.	Extension, 5th process.
Blank .613 in diameter by .051 in thickness.					
Outside diameter of shell .....	.415	.363	.335	.313	.293
Inside diameter of shell .....	.341	.324	.299	.285	.269
Thickness of metal in shell .....	.037	.022	.018	.014	.012
Reduction in thickness of metal in shell .....	.014	.015	.004	.004	.002
Length of shell .....	.275	.501	.604	.902	1.028
Reduction in outside diameter .....	..	.047	.033	.022	.02
Difference in outside and inside diameter .....	.074	.044	.036	.023	.024
Increase in length of shell at each process .....	..	.220	.103	.298	.126

TABLE V.—EXAMPLE IN DRAWING METAL CARTRIDGE SHELL.

Thickness of metal for blank .125 in.	Cupping. 1st process.	Extension. 2nd process.	Extension. 3rd process.	Extension. 4th process.	Extension. 5th process.	Headed and cut off. 6th process.	Reduced part of its length. 7th process.
Outside diameter of shell ..	.878	.8	.751	.706	.655	.655	.495 at top.
Inside diameter of shell ..	.679	.649	.644	.633	.618	.618	.458 at top.
Shell thickness at parallel } part .....	.0905	.0755	.0535	.0335	.0185	.0185	.0185
Reduction in thickness } of shell .....	.026	.024	.022	.020	.015	nil	nil
Thickness of shell near } the bottom .....	.0995	.080	.063	.050	.030	.030	.030
Inside diameter near the } bottom .....	.679	.640	.625	.606	.595	.595	.604
Length of shell .....	.625	.4375	1.4375	2 in.	2.875	2.375	..
Increase in length .....	..	.3125	.5	.5625	.875	{ Cut off or trimmed }	{ Part reduced in diameter causing slight extension. }



importance to be remembered is that, even when a comparatively sharp corner is required on the work, it is not advisable to make the drawing corner of a punch too sharp, or it will tend to cut and tear the metal.

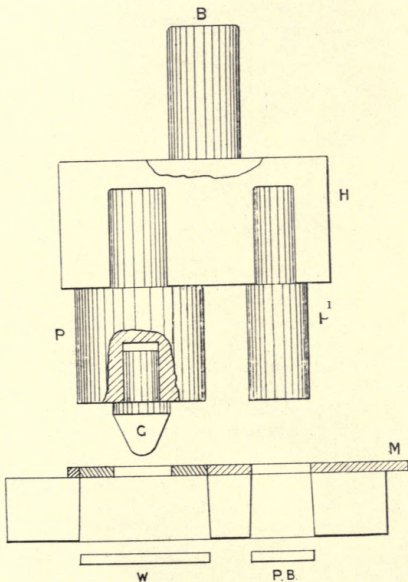

FIG. 143.

A set of successive piercing and blank cutting tools are shown at fig. 143. The wrought-iron holder B is bored out at H to receive the piercing punch P, and the cutting-out punch P¹. The distance between these two punches centre to centre, is equal to the diameter of the washer blank plus the amount of scrap or waste metal necessary

between each pair of blanks. The metal  $M$  is passed along to cover the die, when punch  $P^1$  cuts out the small blank  $P B$ , this makes the hole in the washer and may therefore be called the piercing bit  $P B$  of the washer.

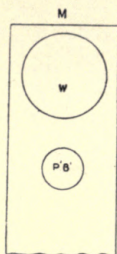

FIG. 144.

The motion of the press next moves the slide carrying the punches up to the top of the stroke, whilst the operator or feed rolls, as the case may be, move the metal  $M$  forward. On the next down stroke, the guide peg  $G$  finds the hole in the centre of the washer which has been pierced on the preceding down stroke, and the punch  $P$  cuts out the actual

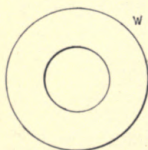

FIG. 145.

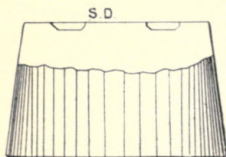

FIG. 146.

washer blank  $W$ , at the same time the smaller punch  $P^1$  makes a hole in the part of the metal from which the next washer blank will be cut. At fig. 144,  $M$ , the scrap metal is seen as it would appear after the press has made two down strokes. A

complete washer ready holed has been cut from  $W$  and the piercing bit of another washer has been cut from  $P^1 B^1$  in the metal scrap. The washer  $W$  is seen in plan at fig. 145. The stamp die, fig. 146, seen in part section  $S D$ , is used for stamping the bevel upon the outer edge of the washer and rounding the edge of the hole in the washer. This is a point of importance as it ensures the washer bedding up well under the head of any bolt upon which it may be used, thereby preventing the trouble which might be caused if a sharp

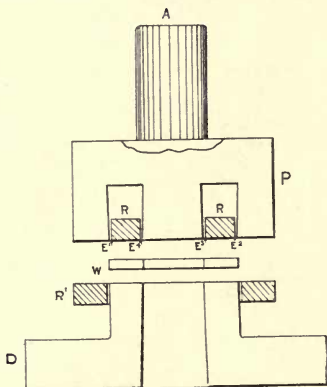

FIG. 147.

edge was left on the hole of a washer; for should a bolt happen to be a tight fit, it might be necessary to ease the hole by filing. This may seem to some mechanics a small point, but it is of importance to remove the frase from the hole in the same stamp die that does the beveling on account of the cheapness of the method as compared to filing the frase from each washer separately.

The set of tools fig. 147 would be used to produce a similar washer; but these tools would cut and hole the

washer at one blow. P is the punch, having a shank A to fit the hole in the slide. The punch P works over the die D and forms cutting edges both inside and outside the die,

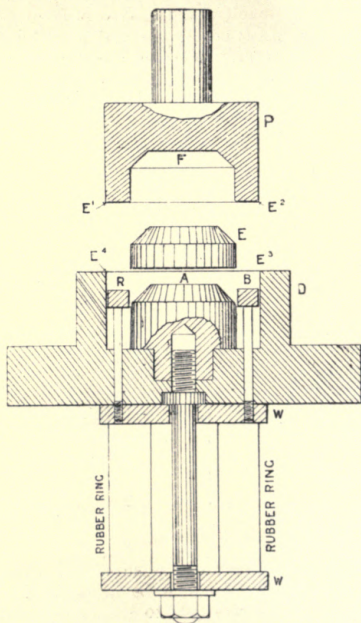

FIG. 148.

$E^1$  and  $E^2$  being the cutting edge for the outside diameter of the washer blank, the hole being pierced by the cutting edges  $E^3$  and  $E^4$ . At the centre part of the punch a ring R,  $R^1$ , shown in section, is provided with a spring, acting

behind it. This is to force the washer out from the punch. Another ring,  $R^1$ ,  $R^1$ , shown upon the die, is backed up by another spring, so as to raise the scrap metal from the die. These extractor rings are sometimes backed up by means of an indiarubber ring or washer, which acts as the backing-up spring. One form of combination tools is seen at fig. 148. These tools are used for cutting out a blank and raising it into a thin metal cap E. The edges  $E^1$  and  $E^2$  on the punch P cuts out the blank. The punch, in its travel on the down stroke, forces the blank down between the walls  $E^3$  and  $E^4$  of the die D. Inside the die is an anvil or raising peg A, and the tools are set in such a position that when the punch reaches the bottom of its stroke the face F of the punch just brings sufficient pressure upon the top of the anvil, or forming peg, to form the metal cap E. During the operation the punch and blank, in the down stroke, will have forced down the ring R, R, thereby causing the rubber backing-up ring to be compressed. Upon the return stroke of the punch this extractor ring R, R will again return to the position shown in fig. 148, enabling the cap E to be lifted out of the die. The same cap E may be made in a different set of tools, fig. 149. In this case the tools are made for a double-action press. The lower die D is fastened to the bed of a power press, and the combined cutting or blanking punch, and blank holder B P, is worked by the outer slide, and moves slightly in advance of the drawing punch D P, which is actuated by the inner slide. The outer slide of the double-action press is so arranged that, after making its stroke to cut out the blank, it stops during about one quarter of the revolution of the crank-shaft. The blank having been cut from the sheet metal by the cutting edges C,  $C^1$ , it is now passed down and held between the face  $a$ ,  $a^1$  of the punch and the face  $e$ ,  $e$  of the inside of the die, during the down *dwell* of the outer slide, whilst the blank is held here by a pressure which can be regulated according to the requirements of each particular case. The drawing punch D P, which is connected to a second or inner slide, continues its downward movement, thereby drawing the metal from between the pressing surfaces  $a$ ,  $a^1$  and  $e$ ,  $e$  into the required shape. It will be readily understood that in this manner

the metal is prevented from wrinkling or puckering during the drawing or raising process. In this set of tools, fig. 149, the face  $a, a'$  of the blanking punch acts as the pressure plate—instead of using a special pressure plate—to prevent the wrinkling or puckering of the metal, besides doing the cutting out. The puckering of the metal is more likely to occur when drawing *thin* blanks than with *thick* ones.

Many articles that are made or formed into cups from thick metal may be so formed without the use of a pressure plate, whereas the pressure plate would be essentially

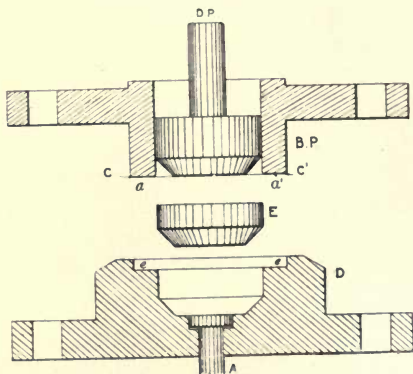

FIG. 149.

necessary with the thinner metals. The separate pressure plate of a drawing press would generally be used in the process of making any article having a flanged top.

The three sets of combination cutting and cupping tools, figs. 150, 151, and 152, are in the position that they would have reached, after passing their blanks through the die. These and similar tools are worked in a double-action press, as they cut out and cup the blank at one stroke of the press. The sketches give a section through the tools, and

they illustrate the construction of three different ways by means of which the punches are attached to their respective rams or slides. In tools of this kind it is essential that the

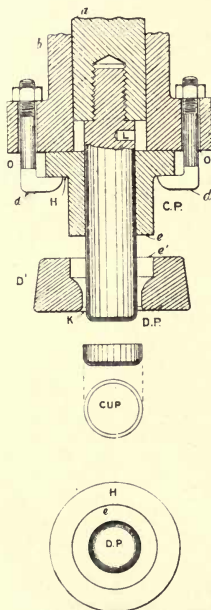

FIG. 150.

two punches be made and fitted perfectly true and in alignment to each other to enable good work to result.

Referring to fig. 150, the cutting punch D P is screwed into the inner ram by means of a steel rod, known as a "tommy lever," being placed in the hole L for this purpose,

having firmly secured D P to *a*. The outer or cutting punch C P is now passed over the drawing punch, and brought up to the bottom face of the outer slide *b*. The fact

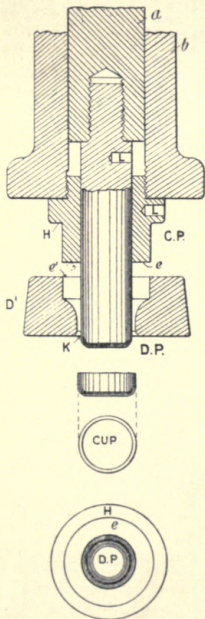

FIG. 151.

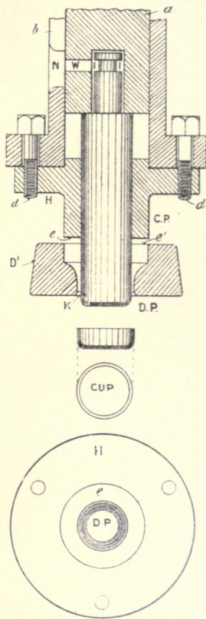

FIG. 152.

of the drawing punch being inside the cutting punch makes the tools practically self-setting, as both punches when they come together, are in perfect alignment. The punch C P is fixed firmly against the face H of the outer slide *b* by the



hook-headed bolts  $d$ , the shank of the bolts passing through the hole  $O$ . The face  $e$  of the punch  $C P$  cuts out the blank and pushes the blank into hole  $e^1$  of the die  $D^1$ . And since the ram  $a$  is a sliding fit in slide  $b$ , when this slide  $b$  comes to rest, the face  $e$  of punch  $C P$  holds the blank in position, whilst punch  $D P$  forces the blank through the die to form the cup, during which process the blank is drawn or dragged from the face  $e$  by the down stroke of the drawing punch  $D P$ .

At the bottom of the cupping die a small bevel is seen at  $K$ , this to some extent prevents the chipping that frequently takes place at the bottom edge of the die, and which is the result of the excessive friction due to the action of drawing. This chipping action or breaking away at the bottom edge of the die during the process of heavy drawing due to the excessive pressure often results in the bursting of the die.

Immediately below fig. 150 will be seen an inverted plan of the two punches,  $H$  being the face on to which the hook-headed bolts come,  $e$  the face of the cutting punch, and  $D P$  the end of the cupping punch.

Figs. 151 and 152 do not need full explanation, as the same lettering is used as in the case of fig. 150. In fig. 151 the bolts are dispensed with, as the cutting punch is screwed into the outer slide, and in fig. 152 the cutting punch  $C P$ , being turned to just enter the hole in the outer slide, set pins are passed down through the flange of the outer slide, and screwed into collar  $H$  of the punch. In this case the cupping punch is pushed up from the bottom of the hole in punch  $C P$ . Bring the cupping punch into perfect alignment, ready to be fixed by some form of gartering at  $L$ . To prevent the punch  $D P$  dropping down, the garter key may be fixed in the ram at  $W$ , whilst the slot  $N$  allows the gartering to be done without removing the inner ram.

Referring again to the breaking away at the bottom edge of a drawing die, this edge must be a sharp corner, since this corner is practically all that is to prevent the cup from re-entering the die upon the return stroke of the drawing punch. This edge has also to act as an extractor or stripper, to remove the cup from the drawing punch. When drawing cup-shaped articles or re-drawing shells and similar work,

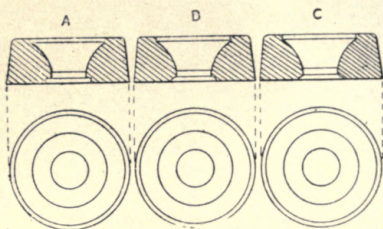

FIG. 153.

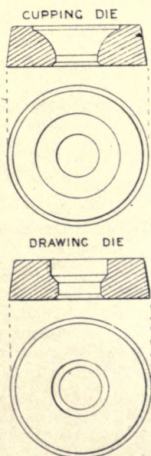

FIG. 154

after the cup or shell has passed through the die, a slight expansion of the metal article takes place at the top edge; this expansion or springing is the result of the elasticity of the metal, and, as a rule, expands the top of an article sufficient to prevent it being drawn up again through the drawing die upon the return stroke of the punch.

Fig. 153 gives three different styles of finishing the corner or bottom edge of the die: A is made perfectly square or a right angle; B has been finished by a round-nosed turning tool being brought up against the edge; and C is finished at an angle of 45 degs. with the bottom of the die. This finish C is by far the strongest, and gives better all-round results in working.

Fig. 154 shows the difference between an ordinary cupping die and a re-drawing die. The cupping die is bored or recessed at the top to a depth equal to the thickness of the blank. The blank is dropped into this recess, and held central whilst the cupping punch moves down to its work; or, instead of recessing the cupping die, there may be a guide plate fastened to the top of the bolster. In the case of the re-drawing die, fig. 154, this die is bored out to receive the shell, and is usually recessed to a sufficient depth to hold the shell upright and steady whilst the re-drawing punch enters the shell to begin the work of re-drawing.

When re-drawing or extending long shells of small diameter, it is frequently very difficult to remove the shell from the drawing punch. This is particularly so when the metal is very thin, there being no strength at the top edge of the shell to engage the sharp edge of the die bottom. A good method to overcome this difficulty is seen at fig. 155, where it will be noticed that special slides are fitted to the bottom of the die bolster B, and held in position by a plate, these slides being drawn up to the punch by means of small springs. Beginning at the left-hand side of the sketch. In the first process a punch P is about to begin re-drawing the metal shell S, and pass it through the die D. The second figure gives the position of the tools after the re-drawing has commenced, and the shell has forced the small slides X X out of the way. In the third figure the re-drawing process has been completed, when the small slides X X have been

drawn up to the punch under the action of the springs, and the slides X X have, as it were, clipped over the top of the long shell. The fourth figure shows that the drawing punch has been withdrawn from the die upon the return stroke of

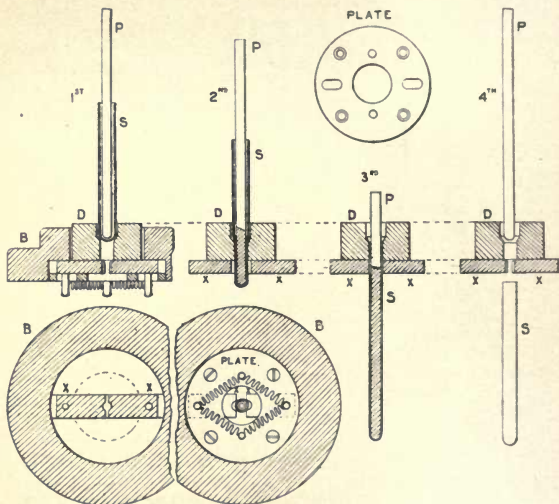

FIG. 155.

the press, and the sharp edges of the little slides X X have clipped over the shell and up to the punch, and prevented the metal shell S from following the punch.

## CHAPTER XII.

## PRESSES FOR SPECIAL WORK.

**Definition 1.**—A <sup>cupping</sup> raising press is generally understood to refer to a machine that has been specially designed to be used for raising into some hollow shape a previously cut blank.

**Definition 2.**—A drawing or extending press is a machine that is used for making deeper, or extending in length, any article that has been previously raised or cupped out of the flat metal, and the length of stroke in an extending press is usually much greater than that in an ordinary raising press.

**Definition 3.**—A cutting-out and raising press is a machine that cuts out its own blank, and simultaneously raises it into some hollow shape, at one operation and at one stroke of the press. This machine is also known as a cutting and cupping press.

In workshops where a limited number of machines are available for use, one press of an ordinary standard pattern is frequently used for an extensive variety of work. This often necessitates the use of special fixtures, which have to be provided to receive the different sets of tools that are required to perform the varied operations. But although a strong and well-designed press may at times be used as a general purpose machine, it is not always profitable to employ one press upon too many varieties of work, since the extra cost of providing fixtures, and the risk of breakages, that sometimes occur when executing heavy work, will frequently out-balance the apparent advantages. There is generally some special feature contained in the design of a press to make it particularly suitable for carrying out some special work or operation; in other words, the designer of any machine has invariably had in view some particular operation to be performed by the machine. With the assistance of a series of illustrations, it will be interesting to note some of these special features as they occur in the design of the machine being dealt with, as in this way the

actual part of the machine may be seen. The author has known instances where an ordinary cutting-out or blanking press has been made, sold, and used for cutting, cupping, drawing, raising, and stamping, simply because the stroke of the press happened to be of sufficient length for the work. From this it would seem to be difficult for one to be able to judge for which operation the machine is most suitable. The first thing required is naturally a sample of the work to be made in the machine; having this sample, and knowing the operation or number of processes required to produce the sample, the next step will be to select a machine giving suitable motions and of sufficient strength for the work. This selection can generally be made successfully by the mechanic who has charge of the section where the operation is carried out. But in important cases, doubtless the better course to adopt would be to seek the advice of the actual press maker, who with his special experience may be better able to recommend a machine suitable to the requirements.

The following brief points are generally considered to be of importance in selecting any screw or power press:—

**No. 1.**—Sufficient weight of metal used in construction of the frame casting to give strength and rigidity, and make it impossible to spring from its normal shape when dealing with the work for which it is intended, and ensure freedom from breakdowns.

**No. 2.**—The part of the press and its strips which guide the slide or ram in its motion, should be carefully and accurately planed, being finished absolutely at right angles to the base, or table of the press, which receives the bolster or bottom die. This point is of particular importance in the case of a drawing or extending press of long stroke.

**No. 3.**—The slide or ram to be as long as possible, its bearing surfaces and those of its guide strips to be of sufficient area, and of suitable shape, to provide a steady motion to the tools, thereby preventing the cutting edges of cutting or forming tools being damaged after the slide or ram has once been properly adjusted.

**No. 4.**—The press bed, the ram, and the adjacent parts to be as heavy as possible consistent with the size of the

press, to enable the principle of the anvil to be successfully carried out. Plenty of metal to resist the sudden blows to which the press may be subjected, and to reduce vibration to a low limit.

**No. 5.**—The details or smaller working parts, to be of sufficient proportions to give the necessary strength, and the wearing surfaces should have ample bearing surface, suitable metal being used for their construction, and hardened where necessary, durability of working parts receiving proper attention.

**No. 6.**—There should be ample room on the bed or table of the press to receive the various bolsters and dies, the ram or any other working parts which have to take variable positions to have sufficient length of adjustment. This point is of particular importance in the case of the ram, unless all bolsters, dies, and punches are designed to one standard length, which is not often the case.

**No. 7.**—The methods of manipulating the press, starting and stopping the operating levers and adjustments should be designed to give the greatest amount of ease and convenience in working.

In seeking out the foregoing points endeavour should be made to select the machine which, in its general design, is of shapely outline. This is often overlooked as being of no direct benefit; even should this be so, the indirect advantages are worth obtaining, especially as no addition is necessary to the cost. These indirect advantages being, the makers are far more likely to take pains and carefully finish the working parts of a shapely machine than of an ugly one. The operators also have more encouragement to keep the machine in good working order by cleanliness, and usually take greater interest in machines that show the improvements than they do if the machine is clumsily designed and of indifferent finish.

The fly-press, fig. 156, is a design suitable for a variety of work. The slide is of the dovetail section, as was seen at fig. 12. This provides a large wearing surface to the slide and steadiness for guiding the tools, thereby ensuring to them a long life. In fly-presses the slide guide is sometimes cast separately, being fixed to the press body casting by a

bolt; this is, however, though common, not good practice. In the case of fig. 156, the guide being cast solid to the press body makes a much stronger job. The connection between the slide and screw is provided with a screw adjustment that serves to take out all play due to wear, the details of which connection are seen at figs. 19 and 22. The extent of the slide's descent is regulated by adjusting screws and

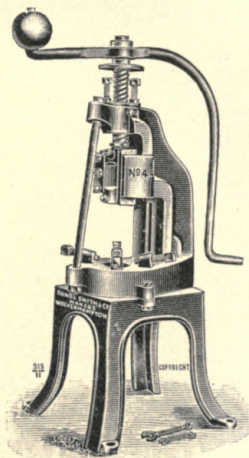

Fig. 156.

stop plate. The stay-bolt seen on the front of the press can be readily inserted or removed, its object being to make the press nearly as strong as if double-sided, in case the press should be required to do exceptionally heavy work. It is often necessary to execute work under this type of press that is too large in area to be placed under a double-sided press, and it is when this class of work has to be dealt with that the stay-bolt would be removed.



The single-acting cutting-out press, fig. 157, is one known by Messrs. Daniel Smith and Co. as the "Gem Series," the special feature of this press that has caused it to receive such a title being that the body and stand are cast in one piece. The connecting rod swings on a ball base, which allows of its free rotation on the upper or bearing part of

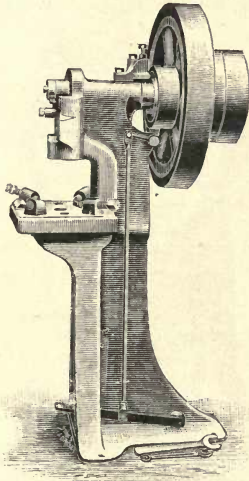

FIG. 157.

the rod. This gives a ready and simple mode of vertical slide adjustment, to suit the variable lengths of the tools, or the extent to which the punch enters the bed, or the degree of pressure that is required to be put upon the work in the case of raising or pressing. The stop motion is of the annular type, having three engaging slots. The engaging key will rotate the press in either direction, and it automatically disengages when the slide reaches the top of its stroke. It will be noticed that in this type of press the fly-

wheel is supplemented with fast and loose pulleys. This saves the band or belt being thrown off the driving pulley or flywheel when tools are being set, or when the press is in any way put to rest. This point is mentioned because it frequently happens that small presses of this kind are driven from the flywheel, which makes it necessary at times to remove the belt altogether from the machine.

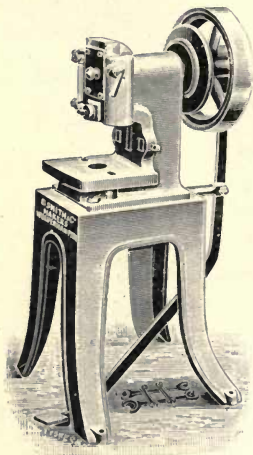

FIG. 158.

The small single-acting press, fig. 158, would generally be useful for small work in any kind of sheet metal, say, for instance, blank cutting, up to  $1\frac{1}{2}$  in. diameter of 14 B.W.G. metal, or its equivalent. The adjustment of slide is made by packing plates, a method previously explained (see figs. 41 and 42). A plate in the front of the slide, being readily removable, gives free access to its adjustments. On presses of this type a small hand wheel may be fixed upon the shaft

at the back of the flywheel, to enable the shaft to be moved by hand for tool setting purposes. The stop motion is of the double peg type, the peg passing through and being supported by the boss of the flywheel. This is a safe and handy arrangement, there being no tendency for the shaft to rotate when setting tools. The friction lever or handle seen on the side of the slide guide serves to retain, by

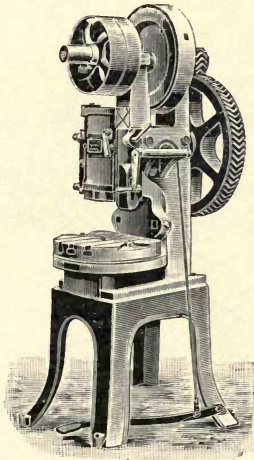

FIG. 154.

friction, the slide in any position of its stroke, while the vertical adjustment of the slide is effected to suit the length of the tools which are being set. When this friction lever has not been attached to presses of this single-acting type, the author has known instances where experienced tool-setters have had the ends of their fingers smashed whilst changing the adjusting plates, the trouble being caused through the slide falling down, due to its own weight.

A compact form of geared single-sided press, which takes up but little space, is seen at fig. 159. It has a vertical adjustment in the slide, being also fitted with a special sliding block stop motion, made to work by treadle. This stop motion automatically disengages when the slide reaches the top of its stroke.

A single-sided press is shown at fig. 160. In this case it has a massive box stand and a back drive, there being a

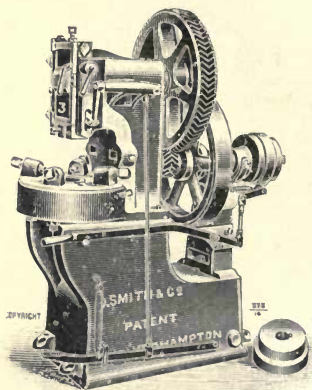

FIG. 160.

friction clutch at the back, inside the two speed cone pullies. The clutch gives a ready means of stopping the entire press, because with the two speeds the loose pulley cannot be used except by the aid of a countershaft. But if the top driving cone is fitted on the main shaft, the friction clutch, as shown, gives stopping and starting control of the gearing, while the usual stop motion in the slide is variable for constant use if required when cutting out. This back drive is very convenient for driving the press from a shaft overhead. The geared incline press, fig. 161, is suitable for

piercing or holing large washers, axle plates, or raising ferrules, or bending articles into shape either in the hot or cold state. The press, as illustrated, would cut out a blank 4 in. diameter by 4 in. thick. The stop motion is arranged for hand or foot, and a screw adjustment is fitted to the connecting rod. The main casting is in one piece. The front stay bolts are removable, and the rate of speed in such a press, if piercing axle plates or similar articles, would be about 70 revolutions per minute.

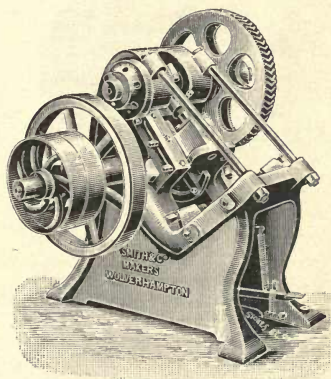

FIG. 161.

The open-backed press, fig. 162, is designed to be used either as incline or upright pattern, single acting or geared, as required by circumstances. This is a very handy type of press, suitable for users who require to deal with small quantities of work having a wide range—that is, light, medium, and heavy. A belt put on the wheel, seen at the right of the illustration, will work the press as a single-acting one, suitable for light sheet pressings or raisings, such, for instance, as can bottoms and tops, tin boxes, and similar articles; or, by sliding the pinion on the back shaft into gear and putting a belt on to the pullies, seen at the left of

the illustration, the press at once becomes a geared one, available for such work as electric-light fittings, bending and forming, cutting out, lock plates, spoons, since the use of the gearing gives a slower speed and greater power to the slide, thereby enabling much thicker metal to be cut. The slower speed is often a great convenience, as it admits of a continuous feed, without the constant use of the stop motion,

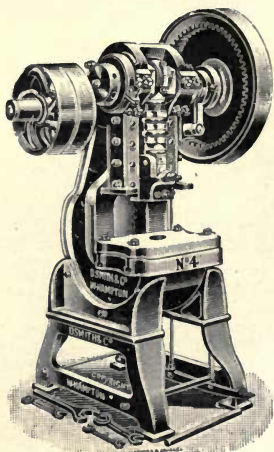

FIG. 162.

as is often the case on some kinds of work. The open back is available for the work to fall through when the press is being used as an inclined press. Fig. 162 shows the press placed in position, ready to be used as an upright one. By loosening the bolts which pass through the semi-circular base of the press, the body can be tilted to a suitable angle, thereby converting the press into an inclined one. The press stands on heavy cast-iron legs.

A type of press called single-acting is shown at fig. 163, this pattern being used extensively. Its chief defect is the form of stop motion, that tends to stop the motion of the slide the moment the operator's foot is taken off the treadle. This is sometimes with the slide up at, or near the top of its stroke, and at others with it down at, or near the bottom; and it frequently requires some considerable

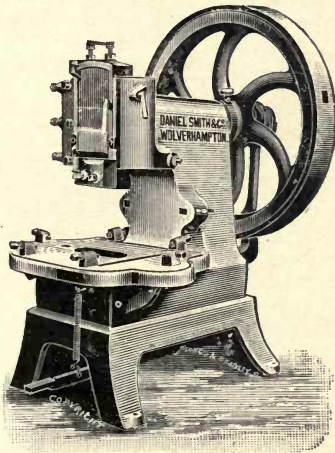

FIG. 163.

practice] on the part of the operator to get into the way of stopping the slide in the right place. Even when this type of press is operated by a competent attendant, it is subjected to the great knocking and hammering at the clutch, as was mentioned when figs. 43 and 44 were being described. This defect is, however, overcome by the substitution of the special stop motion, described and illustrated at fig. 172, which disengages and leaves the slide at the top of its stroke, and avoids the unpleasant shock. It

is also much easier to work the treadle than when the ordinary clutch is used, as with the special stop motion, fig. 172, there is little or no shock to the foot of the operator; whereas, with the claw-clutch stop motion, the operator feels an unpleasant jerk or shock each time the press is started

The single-acting press has its chief application in light work, or that of medium strength, say up to 14 B.W.G. in iron or steel, and to about 10 B.W.G. in brass, and even thicker in copper. But when any of these metals exceed the thicknesses here mentioned, then a geared press is to be preferred, for the reason that more time is allowed to do the actual cutting, and the press is saved those sudden jerky strains that so frequently break the main casting or the end of the crank shaft. In the steel trades the number of breakdowns that arise from this one cause is notorious, especially when cutting thick steel, and it is of a hard nature, and sheared cold; whereas a geared press of the same strength would do the same, if not heavier and harder work, with less strain, all because the work is done gradually, and therefore with less shock.

In the case of heavy work in single-acting presses at a high velocity, the almost instantaneous manner by which it dashes the tool through the metal, or forces out the blank, is liable to break the main casting or shaft; and one of the functions of gearing should be the avoidance of this sudden imposition of great strain on the main casting. For cutting out hot work, or for bending, squeezing, and forging, the gearing is not so important, so long as the thickness is not too great. All forging and squeezing should be done as rapidly as possible, as in the Ryder forging machine, for which the single-acting press is a cheap substitute.

The single-acting open-back upright press, shown at fig. 164, is of the long-slide series, having long slides and guides. It is, therefore, best suited to work requiring a long stroke. The connecting rod has screw adjustment, and at the base of the rod there is a wedge adjustment to take up future wear. There is a loose gland or cap on the base of the slide, handy for the ready removal of the punch or top tool, without removing or even disturbing the



bottom tool or die. The many advantages of this arrangement will be apparent to those who have had experience in press-tool setting. Fig. 164 also shows a loose bedplate, that can be removed or replaced with others of various thicknesses or styles to meet great ranges or varieties of work. It will also be seen that a rod is placed in one of

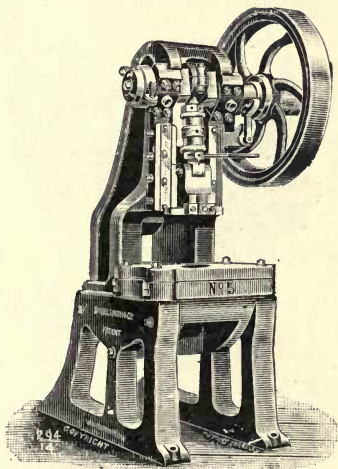

FIG. 164.

the holes of the bottom nut of the connecting-rod adjustment, ready to raise or lower the slide. A press of similar construction is shown at fig. 165, with the exception that this press is geared with helical wheel and pinion.

In fig. 165 it will be noticed that a rod is placed in a hole of a cast-iron disc. This disc serves the double purpose of assisting the tool-setter by enabling him to raise or lower the slide by means of the rod, and the disc having one point in its circumference standing higher than any other, this high

point comes against a piece of hard wood, thereby acting as a brake to stop the press bolt or slide when it has reached the top of its stroke.

The cutting-out and raising press, fig. 166, is of an older design than fig. 167. In the case of the design, fig. 166, there are the usual cams on either side of the crank operating on hardened steel rollers carried by crossbars, which

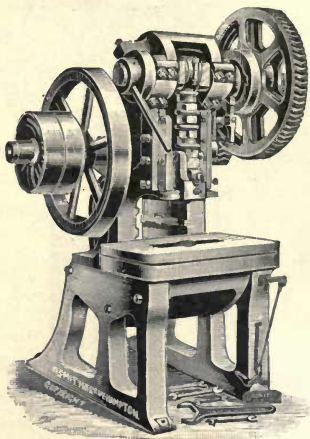

FIG. 165.

are secured to the square frame. Over the cams are another pair of rollers connected to the upper part of the same frame. This gives a positive lift to the pressure plate; this is of importance when the pressure plate is required to carry a cutting-out tool—that is, to cut out and then immediately secure its blank and prevent wrinkles forming whilst the forcer punch sends it into the die. The springs shown are for the purpose of balancing the pressure-plate framings.

In the case of a drawing press being used for cutting out the blank previous to drawing or raising it into some deep-formed article, it is much better for the pressure plate to have a positive lift, because sometimes the top tool will jam or bind in the bed, or the metal may get between and cause it to bind, and then the springs by themselves (see fig. 166)

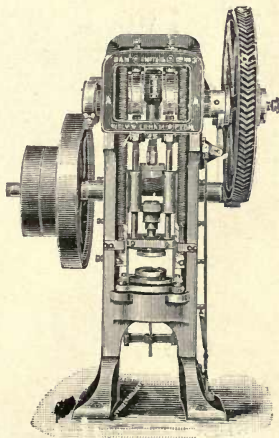

FIG. 166.

would not lift it out, on account of the springs not being sufficiently powerful.

There is another form of pressure plate used for drawing extra deep work. This type has a nozzle fitting inside the die which presses the work against the inside of the die, thereby keeping the wrinkles out of the metal whilst the drawing process is further continued. In this kind of work the positive lift to the pressure plate is very desirable.

In the case of feed rolls and feed motions being used in drawing presses, the positive lift to pressure plate is

essential, because the work is usually cut and raised at the same time, so that in case the blanking tool was not lifted out of the metal, the rolls or feed motion could not work, and the resulting derangement would lead to waste of material, loss of time, and a necessity for entire re-adjustment.

The press, fig. 167, combines the advantage of a cutting-out, raising, and drawing press. The pressure plate descends

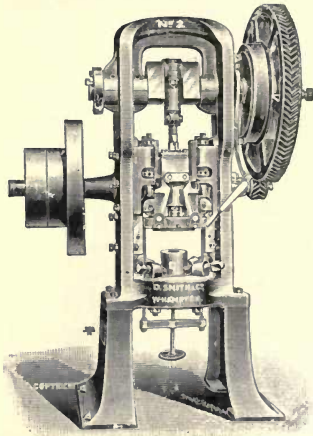

FIG. 167.

by gravity until it rests on the lower die, then the continued descent of the forcer slide (by means of the central rollers) acting upon the incline expands the inverted toggles under the adjustable rollers, which are secured on to the side of the main frame of the machine. This transfers the pressure required to hold down the blank on to the main casting, and thereby relieves the crank of this duty, the crank having to only sustain the pressure of raising the blank.

Fig. 168 shows the change in the position of the parts when the crank is at the bottom of its stroke. There are toggles and adjustable rollers at the back and front of the slide, the pressure plate being held down at four points, the adjustments are positive, the effect being that the work done in this press would be of an exceedingly uniform quality. A press of this type, figs. 167 and 168, would be

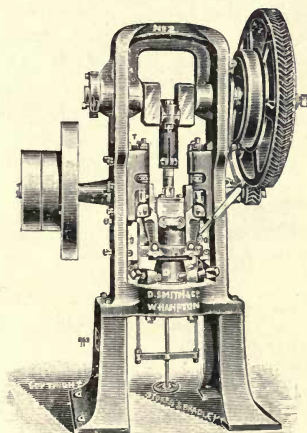

FIG. 168.

specially suitable for such articles as lock-furniture knobs, bedstead knobs and mounts, chandelier weights, drinking cups, lamp bodies, cones, burners, &c. The pressure plate may be removed from the press in a few moments, when the press immediately becomes available, either for cutting out blanks, drawing, extending, and reducing work (that has been previously raised by the aid of the pressure plate). This form of press, with the pressure plate removed, is shown at fig. 169. In presses of this type the crank and

its load should be effectively balanced during descent, and this can be done by having a disc within the spur wheel, which is heaviest on the opposite side to the crank.

The double-crank, double-sided geared press, fig. 170, is a special design for cutting large blanks for baths, two or three thicknesses of metal being cut at one stroke. Such a press would be about six tons weight, and could pass a

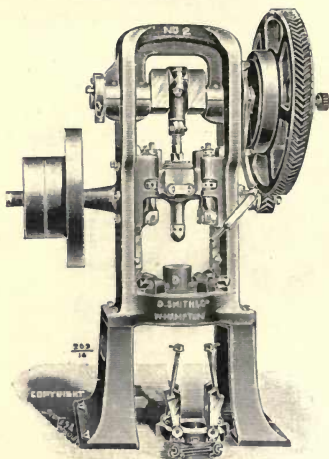

FIG. 169.

blank through its base measuring about 43 in. by 19 in. The slide has a vertical adjustment effected by eccentrics caused to rotate by a tangent screw projecting in front of the slide. This means of adjustment always keeps the base of the slide parallel with the bed or table of the press. The slide is also balanced, thereby preventing any tendency for the slide to overrun in its downward stroke, or unexpected falling of the slide due to its great weight. This feature of

balancing the slides secures safety to the operator. The double-helical gearing is driven by a friction clutch, which is automatically disengaged as the press slide reaches the top of its stroke; pressure on the front treadle allows the

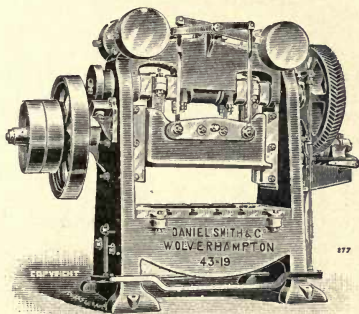

FIG. 170.

clutch to engage and thereby start the machine in motion. The speed of a large press, such as fig. 170, is usually about 30 strokes per minute, and the cutting-out tools would have wavy cutting edges, giving shear to the tools, thereby enabling two or more complete bath bodies to be cut out at each stroke of the press.

## CHAPTER XIII.

## DOUBLE-ENDED PRESSES.

THE advantage of the double-ended type of geared press, fig. 171, is that two presses are fixed and worked, occupying much less space than would be the case if two single presses were used; further, they come out at much less cost in making. When there is a great quantity of repetition work, and not much tool changing required, then double-ended

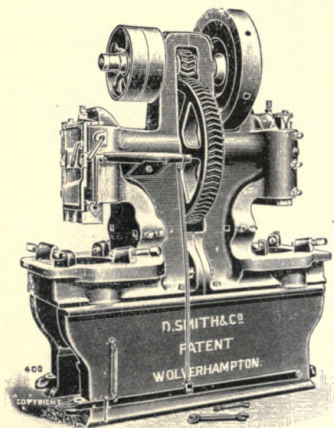

FIG. 171.

presses are, in point of first cost and working space required for them, a great advantage. The eccentrics are opposite each other, the cranks for working the slides being at 180 degrees, so that the strain of doing the work never comes on both together. The stop motion being in the slide is also



a great advantage, and the slides being under independent control each can be stopped and started without interfering with the opposite end. Expert tool setters have been known to change the tools in one end of the press whilst the other

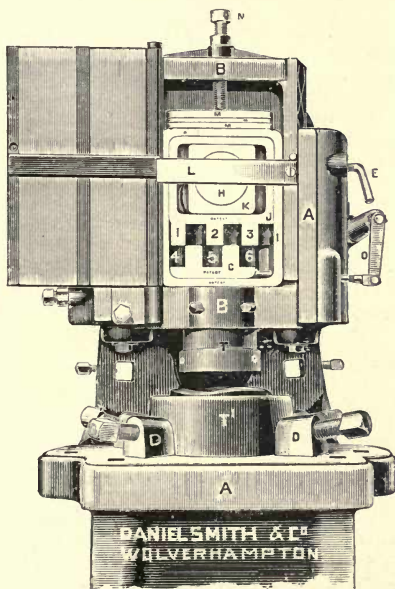

FIG. 172.

end has been working. This has been frequently done in a similar press to the illustration, fig. 171, and by which means will be explained hereafter.

In presses of this kind for heavy work the slides are made of best crucible cast steel. This prevents breakage. In

the case of fig. 171 there is a very ingenious and simple addition made to the packing plate adjustment. A top compensating screw allows any intermediate thickness of plate to be readily inserted, giving a convenience almost equal to a screw adjustment, so useful when using tools of variable length, and in the case of compressing or bending work. At the same time it reserves all the strength and solidity of the packing plate form of adjustment. This is certainly the strongest known method of adjustment, but it is sometimes so constructed by some makers as to be incapable of fine adjustment. In the example referred to, fig. 171, the arrangement gives all the convenience that is desired. Further, the screw can be run back and will allow the slide to descend the top tool, entering into the bottom tool without fear of damage, because if the upper tool should catch in the lower tool it only rests there, indicating the movement needed to set the bed. The slides in these presses are so adjusted that their own weight causes them to descend as the screw is unscrewed, and the friction lever **L** is just tightened so that the slide is safely retained at any point of the stroke.

#### SPECIAL STOP MOTION.

The special stop motion used on these heavy presses is of a form particularly suitable for heavy work. It consists of a sliding block, reduced in the extent of its required motion by its surface being split up into divisions and corresponding projections, as shown by the following illustrations, figs. 172, 173, and 174. On referring to fig. 172 it will be noticed that when the block is at one end of its stroke the spaces 4, 5, and 6 in the lower block C are open to receive the projections 1, 2, and 3 on the upper box J, and the latter moves up and down without giving its motion to the slide (see figs. 172 and 173). But when the lower block is pushed in the direction of the arrow A, or right hand side of the slide, see fig. 174, then the projections on the box come on to those of the block, and the slide is thereby caused to descend. It will be understood that the more divisions there are in each block the less distance the block has to

travel. This is important, since it reduces the time required to advance the block to a minimum, and in accord with the brief space of time allowed for it to properly engage. The projections are preferably made V-shape, as shown by fig.

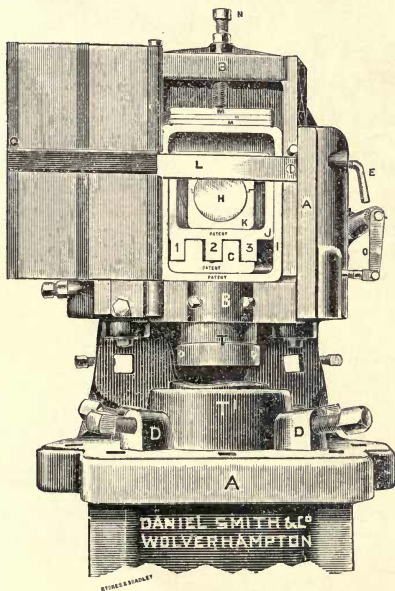

FIG. 173.

175. This greatly increases their sectional area to resist crushing and bending, and allows of a greater number of divisions, and therefore a less travel to be given to the block. This is a very great improvement, since it makes this kind of stop motion applicable not only to geared or slow-working

press slides, but also to the slides of quick action presses, for the very important reason that in all high-speed presses it is desirable that when a stop motion is suddenly thrown into action it should be so arranged in relation to the

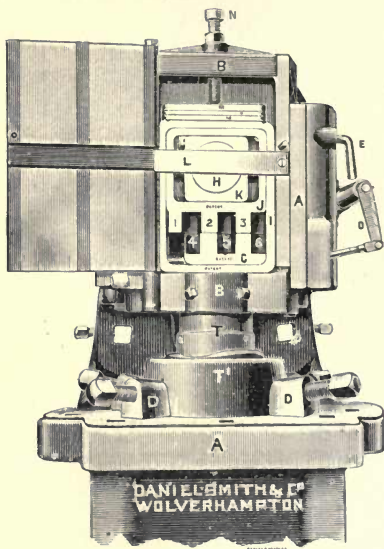

FIG. 174.

moving parts that the motion be given to the least possible mass. This avoids the destructive effect of repeated blows on the parts composing the stop motion, and preserves a silence in the working of the press, which is a very desirable point when a large number of presses are working in one shop.

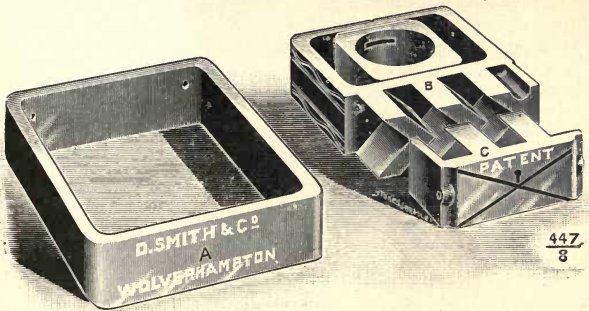

FIG. 175.

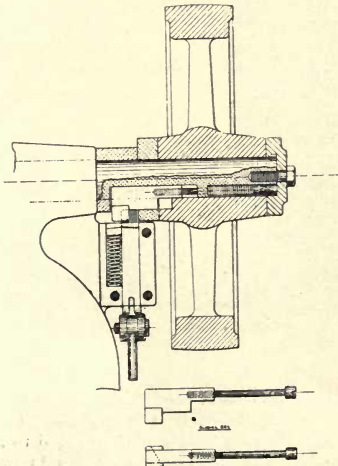

FIG. 176.

In the case of a press having the stop motion in the fly-wheel, the latter going at 120 revolutions per minute, each time the stop motion engages into the crank shaft there is an unpleasant shock caused by the mass of the crank shaft, connecting rod, slide, and tools, having all to be thrown into instantaneous motion. An example of this type of stop motion is seen at fig. 176, where a sliding key is withdrawn by the extracting mechanism, operating upon the head of the key, as the flywheel is rotating. As the inertia of these parts is very great in heavy single-acting presses, it is obvious that the proper place to apply the stop motion in single-acting presses—especially in the medium and larger sizes—is in the slide of the press, rather than in the flywheel. Another patent form of stop motion more

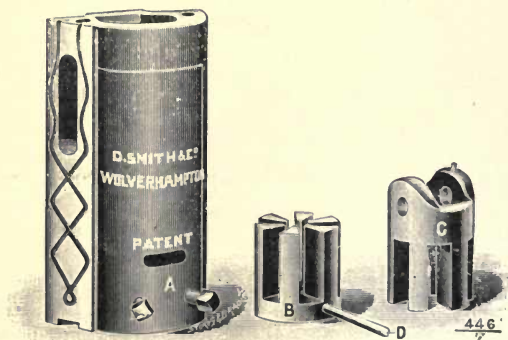

FIG. 177.

suitable for a single-acting press is the one shown at fig. 177. In this example the block is preferably circular, and a slight movement of the lever D is sufficient to start and stop the press. This motion may be arranged to be effected either by hand or treadle. The author has known a great deal of trouble to be caused by the continual hammering and knocking of the various types and shapes of claw

clutches, often resulting in a very heavy cost for repairs in the case of quick running presses, besides frequently resulting in an operator loosing a finger, due to the sudden starting of a press slide. One form of stop motion referred to as being a dangerous method of stopping and starting, is that type seen at figs. 43 and 44, where a cast-iron clutch W C engages another claw clutch C, sliding along the crank shaft. A stop motion such as that described and illustrated, figs. 175 and 177—if either one or the other were introduced into the design of the four large power presses, figs. 46, 47, and 48—would allow of each press being worked separately with perfect success, and the tools could be set in any one press whilst the remaining three presses were at work. Such a stop motion has the following commendable advantages, viz. : It is positive in action ; is in no way tricky or problematical, being easily understood ; and it reduces the possibility of an unexpected descent of the slide to a minimum. The slide is of such small weight as to be readily balanced, thereby removing the liability of the crank and slide to suddenly descend in case it gets carried just over the crank shaft dead centre, as frequently occurs after the stop-motion key has disengaged in many of the American presses. In the case of small and medium size presses, the slide guide may be set up against the slide itself, sufficiently tight to prevent the slide from falling, when the stop motion is thrown out of gear, since the friction between the slide and slide guides would hold the slide at the top of the stroke, as seen in figs. 172 and 173. But for heavy slides it is much preferable to use balance weights, thereby removing any necessity of setting up the slide guides. In fact, it is safer, and much better practice, to work with a balanced slide even with the smaller presses.

The Ryder forging machine, fig. 178, is used extensively for making bolts, joint pins, hurdle and fencing ends, and analogous work that require reducing or swaging quickly. This machine is made in a somewhat similar form as a power press, and may correctly be called a forging press. The speed is usually about 700 blows per minute, and the multiple slides allow a succession of tools to be used, each pair doing their part of the work. The back and front

crossbars are used for fixing guides and gauges. The anvil of each hammer has a wedge adjustment that is used to determine the finished size of the article that is being forged; adjustment can also be made by the screw and hand wheels whilst the machine is in motion, and sometimes they are connected to a treadle, which can be operated by the workman's foot. This mode of working is to be preferred when the required reduction of the bar is considerable. A

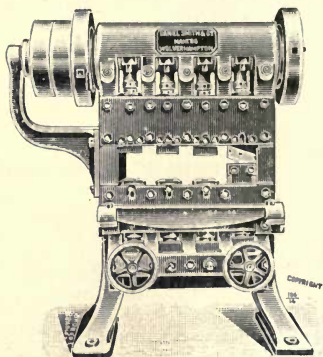

FIG. 178.

set of shearing tools are in the slide on the extreme right of the machine. A forging machine of this type is very useful for forging large quantities of press tools of any particular shape or dimensions. This is readily carried out by fixing suitable swaging and forging tools into the various slides of the machine. The metal shearing attachment, fig. 179, consists of a pair of 12 in. shear blades mounted in a light cast-iron holder, having the necessary adjusting gauges affixed. These may be readily added to any power press, thereby transforming the press into a cross-blade shearing machine. This fixture is very handy when material has to be cut up occasionally, and it may be made in all sizes to correspond with each size or type of power press.



The single-acting guillotine shears, fig. 180, are specially suitable for quickly cutting iron or sheet metal into squares or strips; the stop-motion automatically disengages with

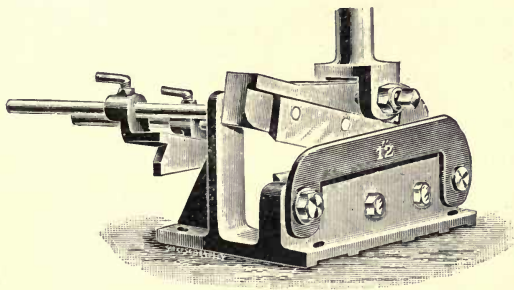

FIG. 179.

the top blade, open ready for the insertion of the sheet. Its cutting speed is about ninety cuts per minute, if the treadle is held down continuously. The machine, as illustrated at

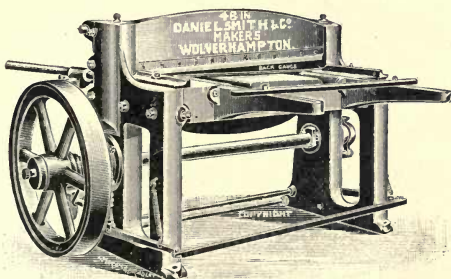

FIG. 180.

fig. 180, would cut sheets 48 in. wide by  $\frac{1}{8}$  in. thick. In the front table graduated rules are set for indicating the position  
13WP

of the front parallel gauge to cut any given size of sheet, and the back gauge has a parallel motion, also a taper adjustment for cutting off taper strips, if required. The connecting rods for working the upper blade arm are coupled to the blade by being engaged into recesses near the top of the upper blade arm, the other end of the connecting rods are attached to the crank shaft. This method of coupling to the top blade arm allows a much longer rod to be used than is usually seen on this kind of machine, and also avoids the tension coming upon a narrow section of cast iron, which

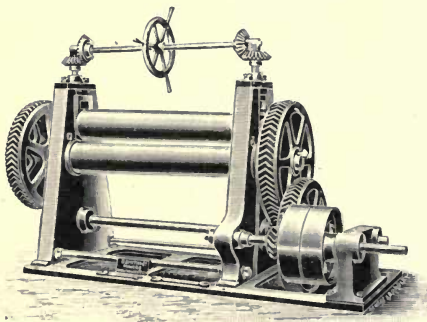

FIG. 181.

is very liable to break, as is often the case when the connecting rods are coupled near the bottom of the blade arm.

Fig. 181 represents a set of flattening or plate bending rolls, for dealing with large safe or bank doors, and similar work. After the plate has passed between the rolls, the motion of the top roll serves to carry it back ready to be put through again. The plate is first bent one way then the other. This process removes all indents, surface distortions, and unequal tensions, and by the adjustment of the parallel motion the plate can be either bent or flattened as

required. The parallel motion for providing a uniform adjustment is very essential if good and expeditious work is required.

A set of circular cutting shears, used for shearing or cutting large blanks, are shown at fig. 182. In this example the cutters are started by a clutch motion, operated by foot. This allows the cutters to remain at rest whilst the sheet is adjusted, without any risk either to the operator or of spoiling the blank. The cutters are made with double cutting edges, and are accurately ground and hardened so that when one pair of edges have become dulled

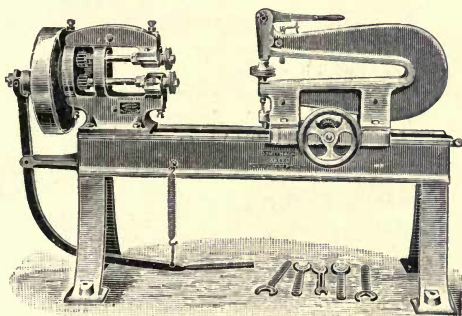

FIG. 182.

by continual wear, they can be reversed, the unused edges being brought into action. The lever grip for gripping the metal sheet acts instantaneously, and this method is preferable to the old screw type of adjustment. A graduated steel rule is fitted in the bed, so that the diameter of the blank to be cut can be readily determined, the adjustment of the rule being needed from time to time as the cutters are re-ground and the plane of either cutting edges are removed in relation to the zero on the graduated rule. The horseshoe grip is readily moved along the bed by rack and pinion motion, and the cutting head gauges so useful for metal splitting operations, can be affixed when desired.

## SHEAR OF CUTTING-OUT TOOLS.

The shear method of cutting out is usually adopted in the case of large blanking tools, to allow of a large blank being cut with comparatively little power required for the operation, and to reduce the stress on both the tools and machine.

The shear method is carried out successfully when the tool which comes in contact with the usable material is kept quite flat, and the shear put upon the tool that will distort the scrap only. For instance (1), suppose ventilator grid blanks are being cut out, these blanks would be required perfectly flat. In this case the punch face should be kept perfectly flat, so as to keep the part of the metal flat which is required to be used up for the blank. The shear in this case will be arranged in the cutting edge of the lower tool bed or die, by making it concave or with curved cutting edge, and this would distort the scrap only, leaving the metal ventilator grid blank perfectly flat.

2. Suppose ventilator plates are being perforated. This is an instance where the order of things must be reversed. The lower tool face, or face of cutting bed, should be kept quite flat, whilst the shear can be arranged upon the cutting edge of the punch, either by making the face of the punch concave or convex; or, if a number of punches are working together, they may be made of variable length, so as to extend the time during which the actual cutting or piercing operations take place. The pieces that are cut out in perforating the plate will be scrap, whilst the ventilator plate itself will be quite flat, owing to the bottom tool or die being perfectly flat. It is of no consequence if the scrap blanks, scrap piercings, or scrap metal surrounding any blank becomes bent or distorted, as they fall from the cutting tools; whilst the ease and comparative silence in which the work is done is quite a pleasure, as contrasted with the constant repetition of reports incidental to cutting when both the punch and bed are flat and without shear or curved edges. Referring to figs. 172, 173, and 174, it will be noticed that the pair of cutting-out tools fixed in the press are for cutting out round blanks. The bottom tool or die

being arranged to shear the blank from these tools will therefore be quite flat, whilst the scrap metal will be distorted or curved as it falls from the tools of the press.

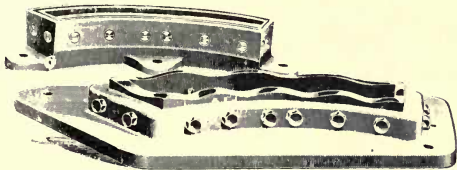

FIG. 183.

Figs. 183 and 184 illustrate a pair of tools for cutting blanks of irregular shape and a pair of round blanking tools respectively.

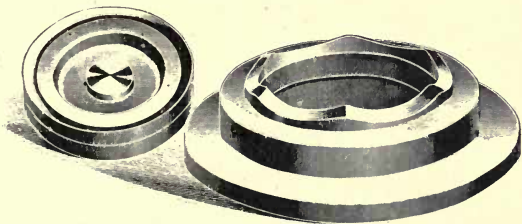

FIG. 184.

ively. In each case the shear is arranged on the cutting edge of the bed or bottom tool, so that the blanks when cut shall be flat.

## CHAPTER XIV.

## ROLLER AND DIAL-FEED MOTIONS.

THE principal reason why the roller-feed finds more favour and is so frequently adopted by sheet metal workers in preference to other feeding devices is on account of it being the only type of feed that can deal satisfactorily with sheet

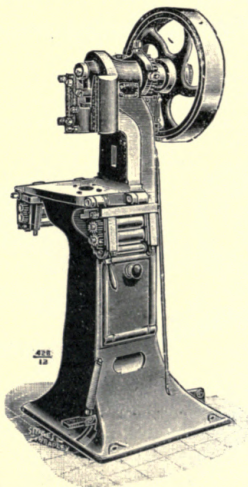

FIG. 185.

metals of the thinner gauges. Such metals, when being handled or uncoiled by an operator, will buckle or break unless reasonable care is used in the handling. Further, the least obstacle will result in impeding its advancement, and care is necessary in dealing with a metal so delicate to

manipulate. From this it follows that when a roller-feed is used the pressure of the rolls, with their length extending beyond the full width of the sheet, keeps the latter flat for a considerable distance before and behind the rolls; they also tend to keep the metal stiff by giving it additional support. The first essential of a good roller-feed is the uniformity of its intermittent progressive motion. When this is perfect, piercing and blanking can be done with precision at an exceedingly high rate of feed, two hundred to three hundred blanks per minute being a very common speed for small articles. It is only when a large quantity of any particular article is required that the roller-feed is adopted. For small lots it has little or no economical application on account of the time occupied by an operator in adjusting the tools with the feed rolls. But when a 50 or 60 feet coil of metal can be started and cut up entirely, and while this is being done the attendant can be fixing up a second coil in an adjacent press, it will be readily understood that the rate of production is greatly increased, and the cost considerably reduced.

As a rule, feed-rolls (especially if they are double) will be in the way when tools are being re-set. It is therefore desirable that their construction be such as to make it possible for them to be readily removed for the purpose of tool-setting. This is effectively accomplished in the arrangement of the roller-feed, as shown in fig. 185, in which the feed rollers are hinged out of the way, the bed of the press being quite clear for setting the tools. The advantage in using a double set of feed-rollers is that whilst the front pair advance the sheet over the tools, the second pair serve to take the scrap or perforated sheet away and to deliver the last remnant of the sheet between the tools. Another important feature is that both pairs of feed-rollers should be capable of simultaneous opening, so that the metal sheet between them can be readily liberated and adjusted in relation to the tools and their gauges. This is accomplished by means of an eccentric lifter, thereby saving time.

The gear should be accurate machine-cut, and the crank-pin used to give motion to the rollers should be provided

with a fine screw adjustment, so that the correct amount of advance can be given to the rolls. There is also usually added a device for automatically coiling up the scrap strip as it comes from the press. Small presses of this kind are especially suitable for making the covers of safety pins, glove fasteners, buttons, stud coverings, chain-links, small cups, and other similar small articles, of which a number

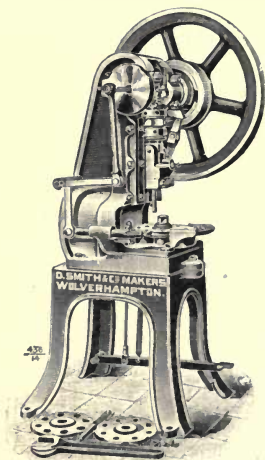

FIG. 186.

may go together and be assembled to build up larger articles. In brief, it may be noted that for thin sheet-metal there is no feed-motion which gives better general results than the roller-feed motion when properly constructed. For thicker metals that will stand some degree of thrust without ready deflection, particularly if in narrow strips, the device known as the grip-feed, or monkey-feed, claims its place, whilst with wider metal the greater the claim of the roller-feed.



The purpose of the dial-feed motion is twofold. Firstly, and most important, it is a device that reduces the risk to a minimum of feeding or the laying under of the work. The great number of accidents in the way of operators' fingers

FIG. 188.

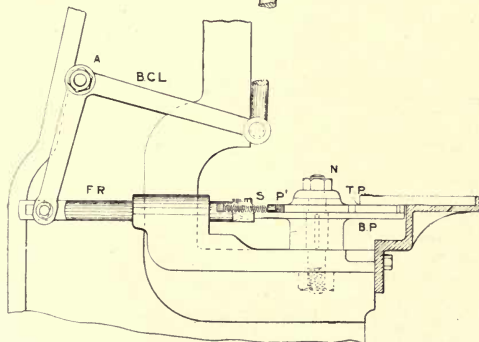
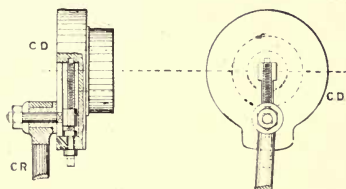

FIG. 187.

being continually mutilated, would be materially reduced, if not altogether avoided, were the dial and other feed-motions more generally adopted. The second advantage is that the operator can feed the work at an exceedingly quick rate. The chief drawback to the use of the dial-feed motion is its cost, especially when applied to small quantities of work. Fig. 186 shows the dial-feed motion fitted to a power press.

The function of the dial-feed is to transfer the work from the hand that feeds it, into the tools that are used to pierce, bend, or reduce the article. Dial-feed motions are made in various forms; the one shown at figs. 187 to 191, is arranged for cupping-blanks that have been previously cut out on another machine. It usually consists of two circular plates about 12 in. diameter, the top plate TP having any number of holes an equal distance apart; the under plate BP is a fixture and has one hole only, this being exactly over that in the lower tool bed or die; this second or bottom plate BP forms a bottom or lower portion to all the holes in the top

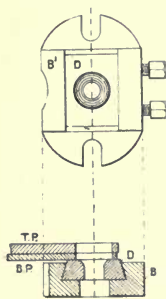

FIG 189.

plate, see fig. 189. The top plate TP is caused to rotate intermittently in one direction by a crank motion, usually on the end of the main shaft of the press, fig. 188, where it is shown in side elevation. A section of the crank motion showing the screw adjustment is also given at fig. 186. The advance of the plate TP occurs only during the upper half of the ascent and descent of the punch and during the lower half the upper plate holds the work to be cupped, drawn, or pierced, over the lower tool bed or die, while the punch descends and does its work. As the crank disc CD rotates, it gives motion to the connecting rod CR, which in turn

transmits motion through the bell-crank lever B C L to the feeding-rod F R. On the rod is fixed a pawl P<sup>1</sup>, and this pawl moves the top dial-plate forward in its revolution, the small spring S keeps the pawl pressed up against the notches in the dial-plate. The function of the locking pawl L P, fig. 190, is to keep the top dial-plate steady in position. The blanks

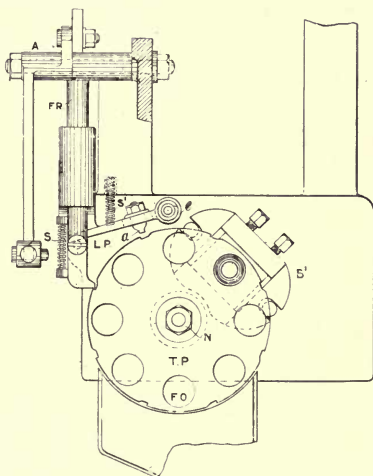

FIG. 190.

are placed in the cast-iron tray and pushed forward into that hole nearest the centre of the tray—each time the dial-plate comes to rest—they are then carried towards the tools as the dial-plate travels round in its revolution. By this arrangement the hands of the operator never need go near the tools. A rear elevation of the locking pawl is seen at fig. 191. The usual speed of the machine is from 100 to 130 revolutions per minute. Fig. 186, is the kind of press generally employed for making brass balls, knobs, cups,

boxes, lamp burners, cartridge cases, and for accurately piercing any kind of blanks. The smaller the size of the work, the greater is the speed desirable, and in consequence the greater the risk to the fingers of the operator.

It is possible to adapt one dial-plate to a variety of work by making the holes in the plate slightly larger than the largest sized article to be dealt with, then fixing bushes into each hole of the dial-plate, of suitable shape to receive the articles to be pierced, bent, or cupped, as the case may be. It is, however, much cheaper and less trouble to the operator to have a separate top dial-plate for each size and shaped article to be handled, for since the complete dial-feed motion is already attached to the machine, the only renewals

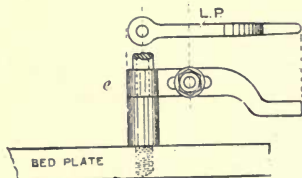

FIG. 191.

required for dealing with new shaped blanks would be additional dial-plates. If all the blanks passing through the machine are round blanks, and of many different sizes, it may be advisable to use bushes in the dial-plates for the smaller sizes, since bushes for round work can be made considerably cheaper than for irregular shaped articles. It is necessary to have the holes in the dial-plates slightly larger than the diameter of the blank to be pierced, so as to allow for expansion, otherwise the blanks might stick in the holes instead of being drawn out by the punch and cause trouble or breakage of tools. If the holes in dial-plate are made sufficiently large the punch will then lift the blank from the hole in the dial-plate, and it will then be drawn off the punch by means of a releaser or stripper. In this case it is essential for the press to be inclined, to allow the work

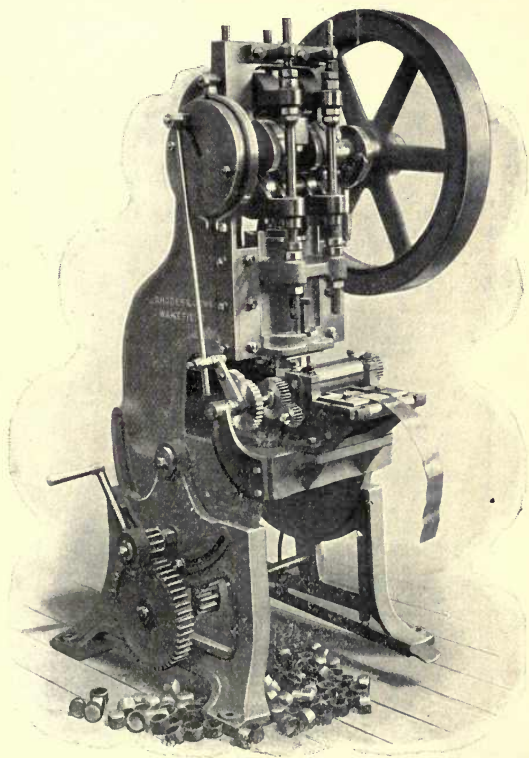

FIG. 192.

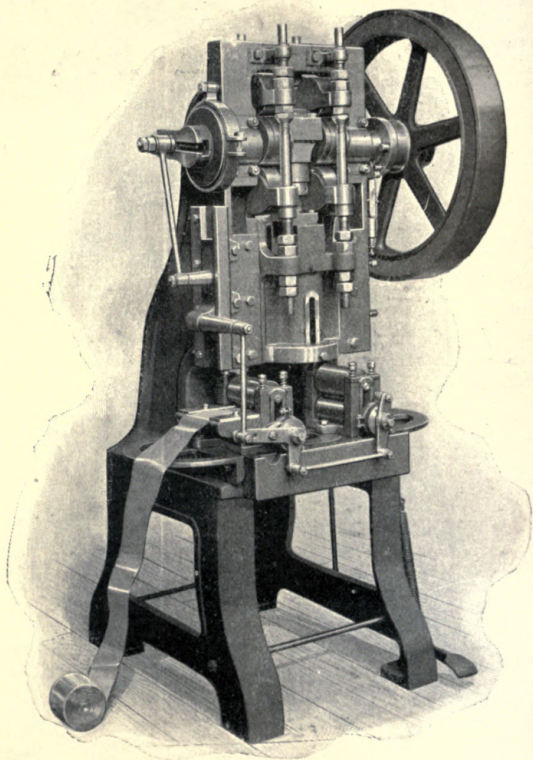

FIG. 193.

to fall from between the releaser and dial-plate, the blank dropping into a box at the back of the press. When the dial-feed is used for cupping or re-drawing it is also advisable to make the holes sufficiently large in the dial-plate to allow the blank or cup (as the case may be) to fall freely into position on to the die, ready to receive the cupping or re-drawing punch.

The adjustable double-action power press, fig. 192, is fitted with a set of automatic feed-rollers. This machine is largely used in the manufacturing of bedstead knobs and similar light brass work. It is fitted with treadle clutch motion, enabling the operator to stop the machine instantly if required, and, being an adjustable machine, it can be worked on the upright or incline position, which is of considerable advantage. Since the machine can be worked up to 125 strokes per minute, and both cuts out the blank and forms the shell to shape at each descent of the ram, it follows that the output is large and the cost of manufacture reduced to a minimum.

A double-action press of somewhat different design is shown at fig. 193. This machine is designed for the same purpose as the previous one, but is fitted with a double set of automatic feed-rolls for more accurately passing on the sheets and reducing the amount of scrap to a minimum. This method of working the feed-rolls is a substantial one, the arm that actuates the rollers being manipulated by a separate slide from the crank shaft end. For operations which do not entail the necessity of these feed-rollers an arrangement is provided on the bed of the machine by means of which the rollers can be swivelled out of the way of the operator.

A power press of strong design is seen at fig. 194, fitted with feed-rolls for use when cutting out round or irregular shaped blanks from strips of sheet metal drawn automatically through the rolls. The rolls may at any time be readily removed, and the press made available for general cutting out and shallow drawing. The machine is fitted with patent positive stop action or clutch, as desired.

The machine, fig. 195, is an adjustable power-press of simple, strong, and serviceable design, and is used extensively

in the manufacture of sheet-metal ware for working the dies in cutting and stamping covers and bottoms of a canister at

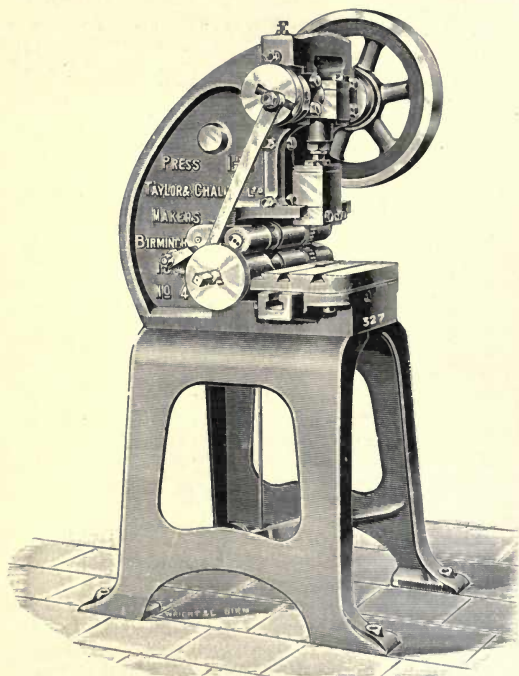

FIG. 194

one operation, and also for cutting body-blanks, [piercing, embossing, and similar purposes. It is fitted with a treadle clutch motion of novel design. An additional attachment



known as a finger guard is frequently added to this class of machine, and it is claimed that whilst practically prevent-

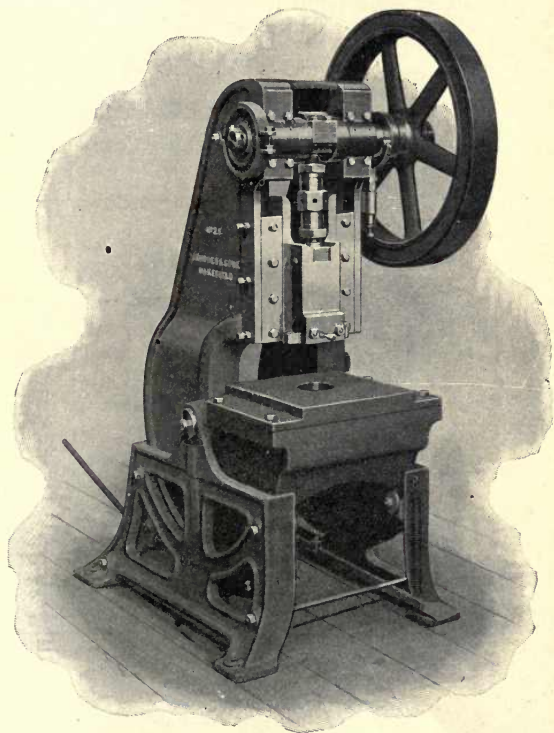

FIG. 195.

ing accidents to the operators' fingers, it also serves the purpose of stripping the tin off the top punch. The clutch  
14WP

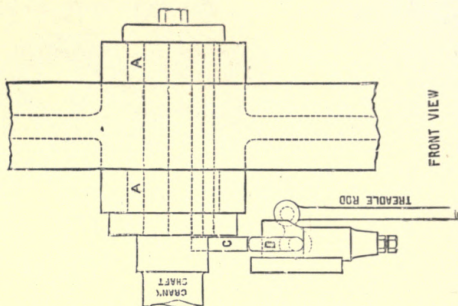

FIG. 197.

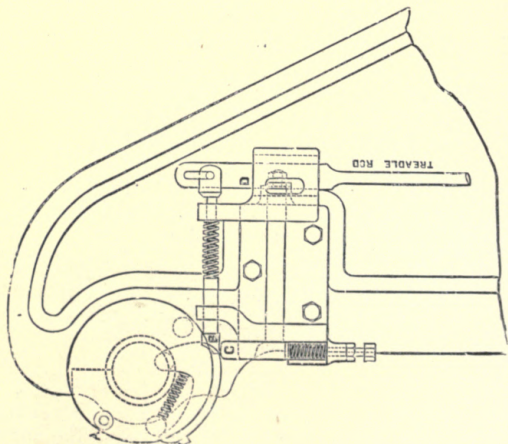

FIG. 196.

motion arrangement can be clearly seen in figs. 196 to 198. We may repeat that the chief cause of the loss of limbs in working a power-press is the unexpected second descent of the ram when it is not intended or expected. Many types of clutch motions are unreliable and accidents will occur with them, even if the greatest care is exercised. The safety-clutch, however, represented in figs. 196 to 198 appears to offer advantages worthy of notice. The following

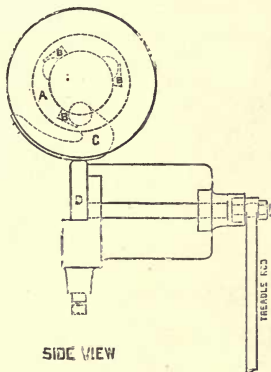

FIG. 198.

explanation will enable its action to be readily understood: When the treadle-rod is depressed the "knock-off," C, is thrown into an angular position, releasing the clutch and causing the ram to make a down stroke. Before the crank has completed its revolution the small roller A strikes the piston B, releasing the "knock-off" C from the treadle-rod. The "knock-off" is then instantly thrown back to its original upright position (by means of a compression spring) in ample time to prevent a second descent of the ram.

Referring to fig. 195, it will be noticed that the ram is coupled to the crank shaft in a manner which enables lengthy

adjustments to be made. A sectional view is seen at fig. 199, which explains itself. Another useful design of connecting-rod, shown at fig. 200, is suitable for presses in which it is desired to bring the ram as close up to the crank

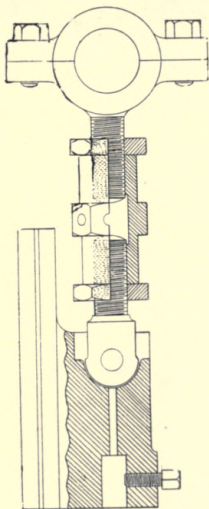

FIG. 199.

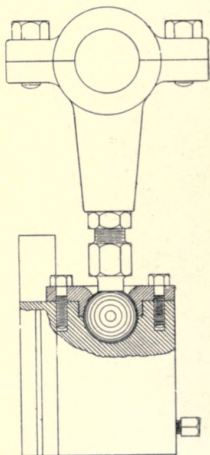

FIG. 200.

shaft as possible, as is the case with small presses of simple design, the adjusting-rod is coupled to the ram by a ball joint, and when this is carefully fitted, it is a great success and works with very little friction. In some designs the screw instead of having a lock nut as shown, is secured by a set pin screwed into the side of the strap rod against a suitable packing-bit, arranged to firmly hold the screw in position without damaging its thread.

## ADJUSTING DOUBLE-CRANK PRESSES.

A difficulty often experienced with double-crank presses, is the adjustment of the two connecting-rods, so as to ensure

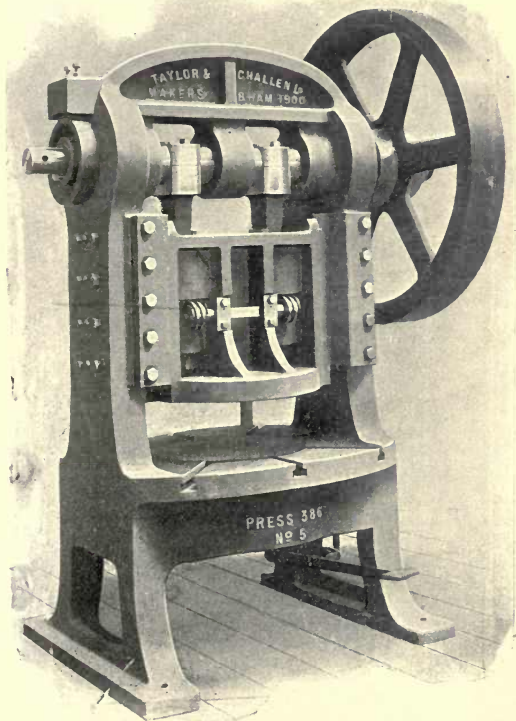

FIG. 201

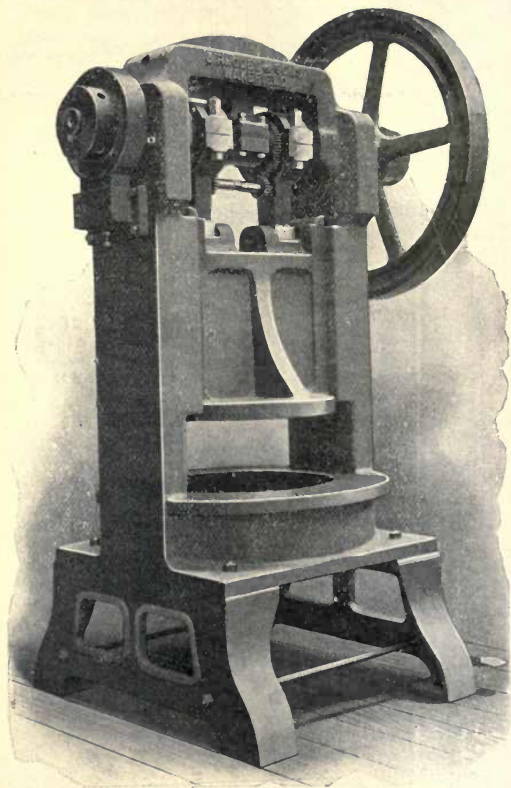

FIG. 202.

that the punch or top die (as the case may be) will come down on to the bottom die and be perfectly level. This is

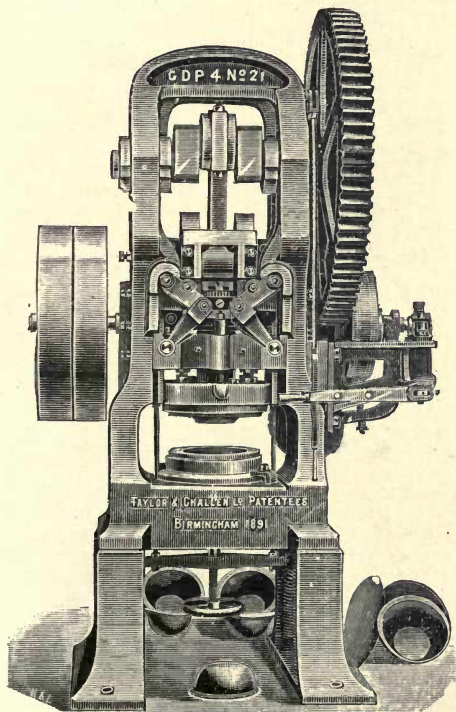

FIG. 203.

very important when a press has to be used on a variety of work requiring connecting-rod adjustments. A worm

adjustment is used in connection with some double-crank power-presses, and has the advantage that it enables the adjusting links to be securely locked at the top and bottom. In many makes of presses, particularly those of American design, there is no proper means of locking these adjusting links or couplings, and the adjustment is therefore liable to be altered during the working of the press. One type of worm adjustment is seen at fig. 201, fitted to a cutting-out, stamping, and embossing press, capable of exerting a working pressure on the dies up to 100 tons.

There are instances, where a small adjustment only is necessary to meet the slight variation in setting the tools; such a press as is shown in fig. 202, where a pair of wheels are attached, one of which is provided with an eccentric brass-bush, and by this means an adjustment of 1 in. is provided. Such a machine is suitable for cutting out heavy blanks in sheet iron and steel—for armature discs, blanks for bottoms of buckets, baths, and similar work, and is fitted with a treadle motion, by means of which the ram makes one descent and stops automatically at the highest point.

A geared press of somewhat similar design is usually employed for such work as pannelling or embossing trunk bodies and covers, by means of dies, a class of work that has usually been done by means of a hand-swaging machine with rollers.

A geared machine known as a toggle drawing press is shown at fig. 203 with its slides up. This type of press is employed upon all kinds of seamless articles, such as basins and other kitchen utensils. The special toggle movement is provided for application to the blank holder, and by this mechanism the pressure put upon the blank under operation is borne by the framework of the machine, thereby reducing the strain and friction upon the crank shaft.

A perforating machine suitable for dealing with heavy sheets and fitted up with automatic feed-table to ensure accurate work is also made. The machine may be employed for punching heavy blanks from the sheet, and which, owing to the machine being automatic, enables the work to be done rapidly and permits one operator attending to two or three machines. It is fitted with hand-lever clutch,



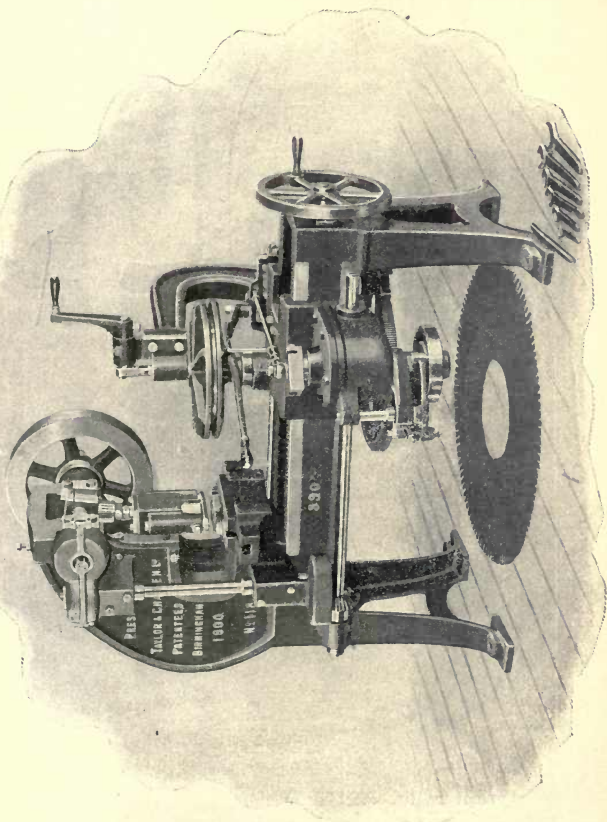

FIG. 204.

by which means the operator can stop the machine instantly if required.

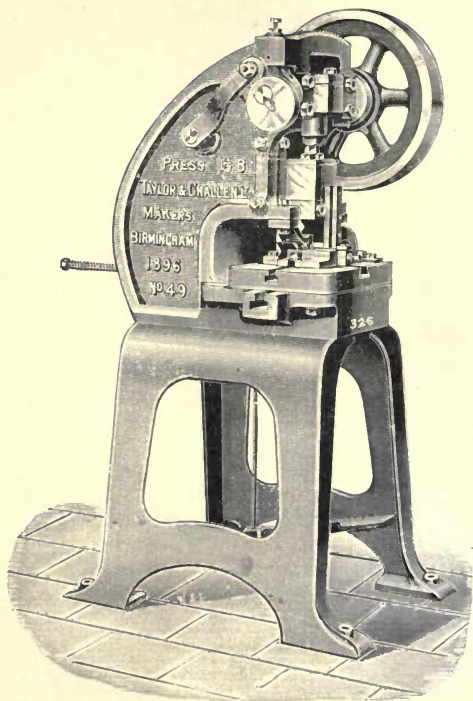

FIG. 203.

The armature disc-notching machine, fig. 204, is a type of machine specially built for the electrical trades. It will be

noticed that the machine consists of an ordinary cutting press, fitted to a suitable bed casting which is truly planed to receive the powerful automatic and adjustable stop mechanism which controls the action of the horizontal rotating movements, ensuring thereby uniformity in the discs that are notched in the press. A positive clutch is provided by means of which punching is automatically stopped after one complete revolution of the disc under operation.

In some instances, as in the case of chamfering, marking, piercing, and burnishing cycle chain links, and similar blanks, it is convenient to pass the blanks on to the tools automatically. Fig. 205 shows a press fitted up for this purpose. Vertical hoppers or tubes of suitable size are provided to receive the blanks, and from these tubes the blanks are automatically conveyed to the dies to be chamfered, marked, or pierced, and after being operated upon fall through the bed into a box placed for their reception.

## CHAPTER XV.

## STAMPING.

THE ordinary stamp, consisting of an anvil, two guide rods, pulley, and a hammer that is worked by means of a band or rope upon the principle of the falling weight, is a very useful arrangement, and is used extensively for raising and stamping sheet metals on account of simplicity of construction and cheapness, when strength is required rather than accuracy. Different opinions are held by users as to the classes of work upon which this machine should be employed, and there seems to be good reason, judging from recent results, for stating that it is frequently better to employ a strong machine, in the form of a power stamping press, that is worked by a crank shaft. This point must, however, be settled according to the class of work to be done. There are many varieties of stamped goods, and necessarily a large number of special stamps and stamping machines, many of which are worked upon the principle of the falling weight, some of the newer types are worked by cranks and cams.

The case of producing an ordinary washing basin, say, 16 in. diameter and 5 in. deep, is an instance where a number of "*forces*," or top dies, would be required if the basin is made in the drop stamp. These "*forces*" will be of different shapes, varying according to the number of stages through which the article passes before reaching the final stage. Each "*force*" may require two or more blows upon the work, according to the actual shape of the article, in addition to which the basin will require annealing at the various stages to prevent splitting or cracking, since in stamping processes every blow of the top die, or "*force*," hardens the metal, frequently causing the article to split or burst. In many cases a suitable and powerful raising press will raise the article at one blow, thereby saving both time and labour. On the other hand, there are classes of work done

successfully under a drop stamp that could not possibly be done economically under a stamping or raising press. From this it will be readily understood that the selection of a machine to do some particular work will frequently require the opinion of an expert.

The ordinary drop stamp, fig. 206, is generally used for hot stamping or drop forgings. The iron in the block should be dense and tough. The practice of having them cast direct from the blast furnace, though cheap, does not

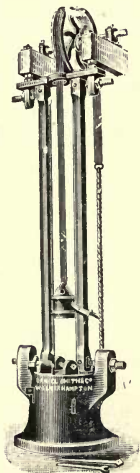

FIG. 206.

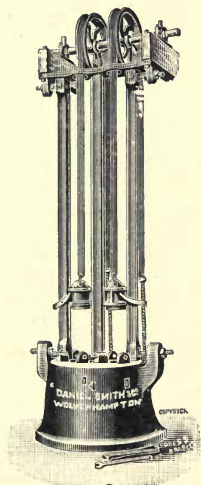

FIG. 207.

give good results, as the face is too soft to withstand the effect of the hammer continually falling on to the lower die. Forged steel hammers are to be preferred to steel castings. The heavier the block is over that of the hammer the more effective is the latter. A good ratio is 12 to 1, and for steel drop forgings it should be 14 or 15 to 1. Stamps in which

soft metal "*forcers*" are used, a ratio as low as 8 to 1 may be adopted. The stamp block should have a large and well proportioned flange and a level base. The supposed economic practice of having these cast in open sand is not a good practice. A level block base can be bedded more solid upon its foundations than an uneven one.

The advantage of the type of double-stamp, fig. 207, is its usefulness for light or small drop forgings of irregular shape and thicknesses, in which the bar of iron or steel needs some preparation to mould it to suit the form of the finished die. The first, or the stamp on the left, is fitted with forging tools that serve to rough shape, that is, to elongate or thin down the bar in one part, while its adjacent part is required the full thickness. This is necessary for economising the raw material and reducing the superfluous metal to a minimum. In this double-stamp the first hammer is called the *dolly*, and the second the finisher. It is found in practice, when making steel stampings, that both hammers cannot be used for finishing, as the concussion and rebound of the one hammer tends to the up-setting and loosening of the dies under the next hammer; but this is not so important when one hammer only is used for finishing and the other used for rough-shaping the material, because the dolly tools are comparatively unimportant in their setting, and the more solid blows are made by the finishing stamp. These latter can receive careful attention to keep them truly and firmly set. When used in this manner the double-stamp economises space, heat, and time in the transfer of the work from the first to the second stamp.

The drop stamp, fig. 208, is the ordinary type raised by pulley and belt. This kind of stamp is worked either by hand or foot. When the work is light, the usual method is to connect a rope or strap to reach the operator's foot; this leaves the hands free to place the work upon the lower stamp die, the blow being made by the falling of the hammer each time the operator raises his foot. In heavier work the hammer is raised by the hand, then allowed to fall, and whilst the operator places the work upon the die the hammer is held by the catch, as seen on the left of fig. 208. The number of accidents that have happened by

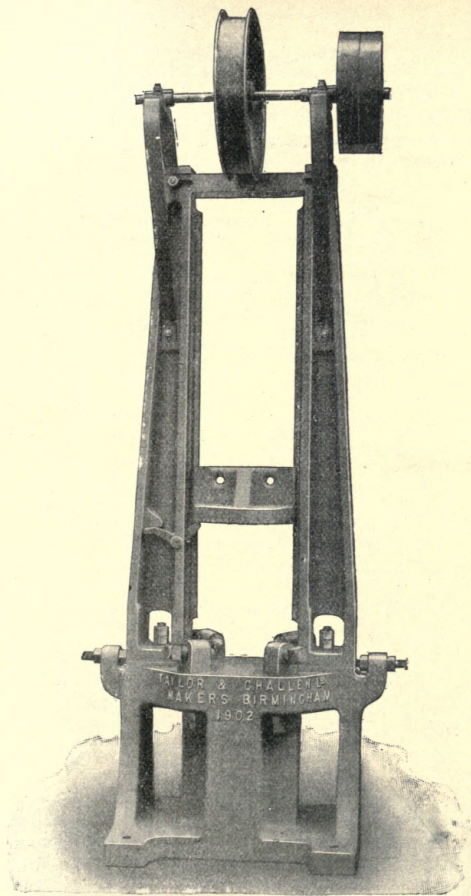

FIG. 208.

stamp operators having their fingers mutilated has led to the introduction of automatic drop hammers. The object of an automatic stamp, or drop-hammer, is to raise the hammer to the required height, then allow it to fall without the attendant pulling or releasing a rope or strap which is connected to the hammer.

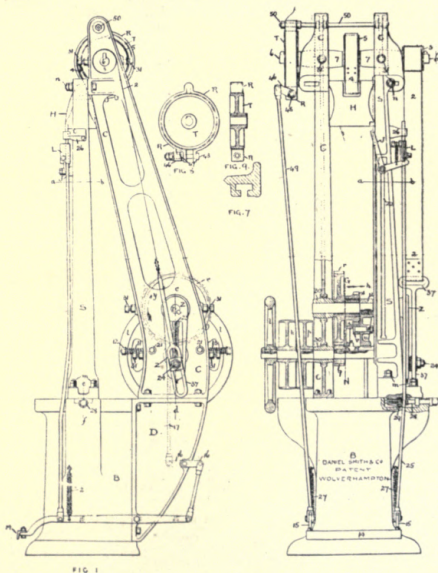

Diagram 1.

The following description of such a stamp, in conjunction with diagrams 1 and 2, will enable the operations to be understood. Referring to diagrams 1 and 2, on the back of the block a projecting bracket is bolted. This serves the



purpose of carrying the lifting mechanism, which consists of a crank motion, rotated by a spur wheel and pinion driven by a pulley. The frame extends upwards, and carries in suitable bearings a spindle free to rotate, upon which is secured a pulley, to which is attached one end of a band of leather, steel, metallic chain, or other more suitable

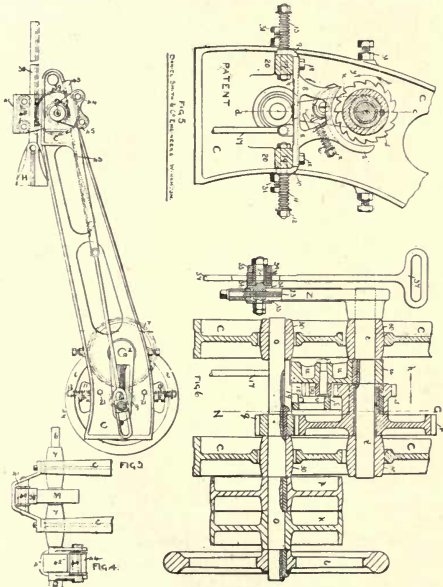

Diagram 2.

material; the other or fall end of such band is connected to the hammer. Secured on the outer end of the top spindle is another pulley of about one-half the diameter of the hammer pulley, and to this pulley is connected another band, the fall end of which is connected, through the

medium of a U-shaped lever, to the stud pin in the adjustable crank previously referred to. The relation between the connection of the band on the hammer pulley and the connections of the band on the crank pulley are such that as the hammer rests on the die the band on the crank pulley is coiled up, so that any motion of the crank uncoils one band and coils up the other. The hammer is thereby raised to such an extent as there is disproportion between the two pulleys—that is, the stroke of, say, a 12 in. throw crank would by these means cause the hammer to be raised a distance of 4 ft., if the ratio between the crank and hammer pulleys were 2 to 1. Any shortening of the crank throw would result in a magnified shortening of the distance the hammer would be raised, and *vice versa*.

Fig. 1, diagram 1, is a side elevation of such a stamp. Fig. 2 is a front elevation, with one of the standards S removed to show the lifting gear in section, and the other part sectioned on line *e, f* to show detail of screw 28 for adjusting the guide or standard S. Fig. 3, diagram 2, is a rack modification for lifting heavy hammers. Fig. 4 is a plan of fig. 3, and fig. 5 is a section through the line GN of figs. 2 and 6 in direction of arrow *h*. Fig. 6 is a sectional elevation through the line *c, d* of figs. 1 and 5.

In figs. 1 and 2, B is the anvil block, S is one of the standards, D is one of the two brackets bolted to the back of the block B, CC are two upright back standards resting on the brackets D. The standards S are secured to the block B by bolts *m*, and slot holes allowing the guides or standards S to move in and out for taking out or replacing the hammer H, or to take up wear and tear.

Referring again to figs. 1, 2, 5, and 6, *o* is a fly shaft driven by a band on the fast pulley *p*. On this shaft is keyed a pinion *q* that gears into a spur wheel *r*, having fastened to it a ratchet wheel *s*; these rotate freely on the shaft *t*, on which is keyed a lever *u*, carrying a pawl *v*, retained by the spiral spring *w* on the adjustable pin *x*. As the pawl engages the ratchet wheel *s* the latter drives the crank shaft *t* in the direction of the arrow *y*, causing the crank to uncoil the band 2, at the same time coil up the band 4 and raise the hammer H.

As the crank *z*, with the lever *u*, return towards the bottom centre the pawl *v* catches against the shield 8, which serves to disengage the pawl from the ratchet wheel *s*, and keeps it out, allowing the ratchet wheel to continue its rotation without rotating the crank shaft *t*. Simultaneously with this the lever *u* forces the flipper bar 9—shown in broken lines through the shield 8—aside, and then strikes against the end of the second flipper bar 10, which serves as a stop, being supported by the spring 11 against the nut on the bolt 12. If it is desired to let the hammer fall downward pressure is applied on the treadle 14, carried by the levers 15, and connected to the flipper bar 10 by the rocking levers and down rod.

It will be clearly seen that the pawl *v* on the lever *u* is still kept out of gear of the teeth of the ratchet wheel by the outward extension of the arc-shaped shield 8 during the fall of the hammer, but when the latter is nearing the bed, the pawl passes off the upper end of the shield 8, and by the pressure of the spring *w* it again engages with the teeth of the ratchet wheel, and consequently the hammer is again raised to the top of its lift. Any rebound from spring 11 is resisted by the spring 13 on the opposite flipper bar 9. Near the outer end of the shaft *o* is a loose pulley *k*, and adjoining this is keyed a flywheel *l*, which is used for raising the hammer up by hand for tool-setting purposes. The automatic safety catch *J* is made adjustable in the slot.

Fig. 7 is a section of the standard *S*. The hammer can be adjusted for any height by means of screw 23 and crank-pin 24 in the slot of the crank *Z*. A rod 25 is connected to the treadle lever. On this rod is a sliding clip *L*, which overhangs the tail end of the catch *J*. As the treadle 14 is depressed to pull down the flipper bar 10 it also withdraws the catch *J* out of the path of the hammer before the latter commences to fall.

The springs 27, which are fastened to the treadle levers 15, are for keeping the flipper bar 10 in gear and the catch *J* under the hammer *H*.

Fig. 6 shows in section the detail of the parts used to effect the crank pin adjustment. The other extremity of this pin is provided with a nut which tightens upon a

shoulder, allowing the bush part 34 to be free to rotate on the pin 24. On the outer end of the bush part 34 is another screwed collar 35 ; this tightens up against a pair of divided

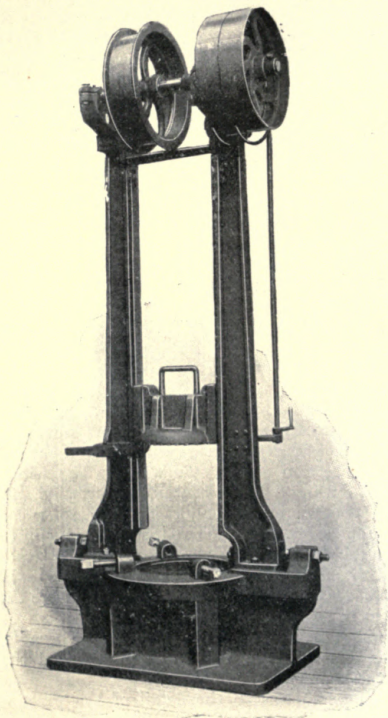

FIG. 209.

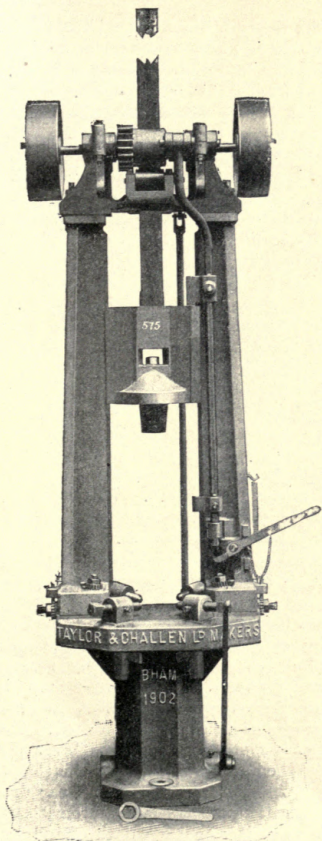

FIG. 210.

clip plates 36, between which is held the slotted connecting bar 37. In case of heavy hammers it may be preferred to use a toothed rack and pinion instead of bands.

Figs. 3 and 4 show this modification. H is the hammer to which a rack 38 is connected, this gears into a pinion 39 and is guided by the rollers 40. On the outer end of the spindle 6 is fixed another pinion 42, about half the size of the pinion 39, and into this works a rack 43, kept in gear by rollers 44. Frame 45 swivels on the spindle 6 in order to conform to the angular movement of the rack around the pinion 42, caused by the circular motion of the crank Z.

The power drop-stamp, fig. 209, is of similar construction to that seen at fig. 208, the only difference being that the latter would be worked by an overhead shaft. The stamp, fig. 209, is self-contained; the belt is attached to the hammer and brought over the flange pulley, which is kept continuously rotating. When the hammer is required to be raised the belt is drawn tight, and the pulley instantly grips the belt and raises the hammer. Both are largely used for finishing seamless-drawn hollow-ware, which, after coming out of the drawing or raising press, have certain imperfections in them, such as buckles or wrinkles and round corners, which need bringing up sharp. The machine, fig. 209, is also used in the manufacture of labels, and for embossment which requires boldly bringing out.

Another style of drop-stamp is seen at fig. 210. In this case the belt for raising the hammer is dispensed with, and in its place are introduced special rollers and a board. On depressing the foot treadle the friction rollers at the top are brought into contact with the board, thus raising the hammer. The board is automatically released and the hammer then descends. This drop-stamp is also used extensively for light forging work, such as articles used in the cutlery trades, locks, keys, pistols, &c. The movement of the hammer is controlled by a hand lever pivoted on the base block. When a blow is required this handle is pressed down, causing the hammer to have a clear drop upon the work under operation, it then rises automatically to the top of its stroke, where it remains till the hand lever is again pressed down to have the blow repeated.

## CHAPTER XVI.

## AUTOMATICS AND MACHINE TOOLS.

It is necessary for those who are fitting out new factories to have had a reasonably extensive experience, in order that commercial success may result. It is important to emphasise this, particularly as regards automatic machinery, as, partially owing to the "booming" of American automatics, there is a probability that this class of machinery will for some years to come be looked upon as an absolute necessity for the successful working of a manufacturing concern. This may possibly result in a point being reached when a reaction will occur against the use of so many automatics. The subject of rapid and accurate production by special automatic machinery is an important one, but, as in many other subjects, there is more than one standpoint from which the matter may be viewed. The modern manufacturer recognises the value of special machines and tools that may be purchased and successfully used for producing thousands of similar articles, all finished to some particular and definite shape and size. But the question as to the advisability of adopting an automatic machine for the production of any new and special article from sheet metal is one that frequently calls for special judgment and care in the decision, not only to decide upon the methods and number of processes through which the article shall be passed, but to select the most suitable machine for the work. In a cycle, motor car, gun or ammunition works there are sections of the work that can be rapidly and accurately produced by automatics, attended by unskilled labour.

The author trusts that he will not be misunderstood by students, neither does he desire to contend that where considerable quantities of any particular article are required automatic machines should not be used. But there is a great tendency in modern times for automatics to be required for all purposes, and whilst their use should be encouraged, when it is possible to obtain beneficial results, there is a limit to their successful and economical employment.

The capstan lathe is an example of the successful application of a special machine. Its employment for a variety of purposes frequently necessitates modifications in design, so as to ensure of its being equally effective on various classes of work.

As an example of an *automatic* machine well known in this country we may consider the wire nail, rivet, and panel-pin machine, where a coil of wire is placed upon a swift, the wire being automatically fed through the machine by a grip-feed, whereby thousands of nails, rivets, or panel-pins can be made before the end of the coil is reached, each nail being headed, pointed, then knocked into a box under the machine. Again, there are the tack and tingle machines, where a narrow strip of metal is placed in a feeding tube and automatically turned upon one side, and then the other; at the same time the strip is carried forward, or fed along the tube, by means of a weight fastened to a piece of cord or string. Machines of this kind are generally attended by girls, and the tools are ground and set by the tool maker. The making of an umbrella rib and stretcher is another excellent example of automatic wire machinery, where the rib or stretcher is flattened, pierced both ends, and cropped or cut off automatically at the rate of 78 per minute. The tools for such machines are shown at fig. 111; and, returning to sheet metal, button-making from a coil of sheet metal, also the cutting and cupping of blanks as in small arms ammunition, are examples of work being done automatically. Many excellent examples of automatic machines may be seen in the textile industries, in spinning, weaving, and knitting.

The great thing to aim for is suitable machinery and tools having the least possible complication in their design. It is often the case with metal-working machinery that an automatic machine will work well for a short time, producing perfect work, then go suddenly wrong, making it necessary to have an experienced operator to work it, and it is questionable whether there is any great advantage to be gained. One example of automatic machine which may be mentioned as giving no special advantages, would be a machine for automatically drilling four blocks of a cycle chain at one operation. The care and attention required for a



perfect result make it doubtful whether there would be any advantage whatever by its adoption.

However, an instance is known where one competent mechanic, with two young assistants, successfully superintended sixty girl operators who were drilling these same steel chain blocks, each operator handling a small single-spindle vertical drilling machine, and fastening the block to be drilled in the small jig shown at figs. 106 and 107. The work in this instance was proved to have been done more accurately and rapidly than could possibly be done in the special automatic machines which were being used in the same works. In cases where a small quantity of an article only is required, or where the demand is likely to be temporary, instances that do not really justify the outlay for a special machine, the mechanic or tool maker must devise some suitable method of utilising what machines and tools he has at hand, to enable the work to be turned out accurately; and providing he has in the tool room or fitting shop, the usual ordinary machine tools, it is not unreasonable to expect him to prepare his temporary tools and jigs. One or two examples will illustrate the principal methods by which their accuracy may be accomplished. Previous to these examples we will indicate the principal machine tools and their uses that one would expect to see in a medium-sized tool room, and follow on by making reference to actual tools that have been made and illustrated in these articles.

The manner of applying the methods must necessarily be left to the mechanic—how best to use and develop them to meet his own particular requirements. If he does this, he will necessarily develop his powers of independent thought, which is so essential to the success of a tool maker who has a limited supply of special appliances at hand from which to execute his work.

The lathe may be truly said to stand of first importance in the equipment of a tool room which has to deal with press tools. A useful 6 in. centre tool-maker's lathe is represented at fig. 211. The headstock is double-g geared, has steel spindle, with a 1 in. hole through its entire length. The three-step cone is driven by a 2 in. belt. A convenient reversing motion is fitted for operating the sliding, surfacing,

and screw-cutting arrangement, and in some instances two rows of division holes are drilled on the face of the main wheel, and an index peg is attached to the headstock, and the loose headstock or poppet is adjustable for taper turning.

It will be noticed that the compound slide-rest is fitted with an ordinary tool holder of the *pillar* form, the turning tool being held by means of a set-pin screwed down from the top end of the pillar. This type of tool holder, though convenient for quickly placing and fixing a turning tool in

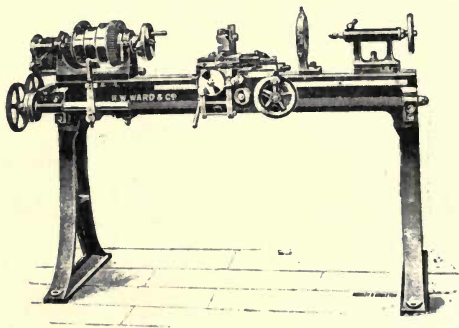

FIG. 211.

position, and useful for light work, is open to the objection of the tool *tilting* when heavy cuts are being taken. A far better and safer tool holder is that consisting of two clamp plates P, P, held down by four pins (see fig. 212), which is a plan of the headstock and compound slide-rest. The turning tool T is operating upon a stamp die D, which is held in the chuck C. This lathe can be used for all ordinary tool turning within its range of size; boring, cylindrical cutting, cupping and drawing dies (figs. 78, 79, and 80); turning and facing punches, such as those seen at figs. 82, 87, 94, 95; and a variety of other work, as instanced at figs. 70 and 111; turning former (fig. 116), or the rollers (fig. 119).

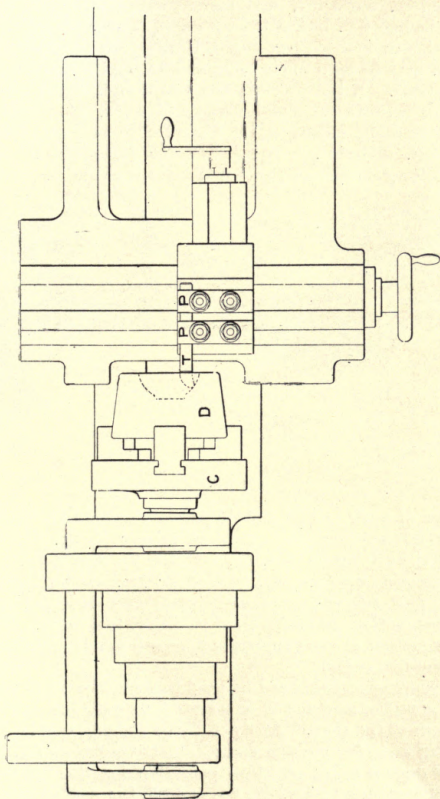

FIG. 212.

A sliding, surfacing, and screw-cutting lathe of 9 in. centre, having 9 ft. bed, fitted with gap, is seen at fig. 213. This lathe, in addition to being convenient for ordinary tool making, may be used for turning and boring the larger dies and punches. A lathe of this size and design is capable of executing a great range and variety of work, from dealing with a piercing punch  $\frac{1}{16}$  in. diameter to boring a bevel wheel 2 ft. diameter. At fig. 214 the lathe will be seen screw-cutting a drawing punch D P, on its shank S. Other

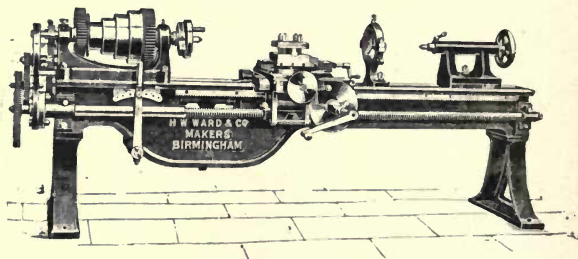

FIG 213.

examples of work carried out on this lathe would be that of boring and screw-cutting cross of bolster B, fig. 95, and making the setting-up pins, fig. 100, and the chuck, fig. 122.

The shaping machine, fig. 215, is a 12 in. stroke, double-gear, and self-acting shaper, being also provided with a circular motion, so useful on sheet metal tool work. This circular motion will be seen above the work table immediately below the tool holder.

The shaping machine can be used to great advantage when its use is understood and it is adapted to suit the existing conditions of the shop. At fig. 216 the shaping tool is seen operating upon the circular end of a cutting-out punch, the circular motion being put into operation for this purpose. On referring back to figs. 87, 88, and 89, the usefulness of a shaping machine will be apparent. The same may be said of fig. 92, since the machine could be used for roughing-out the

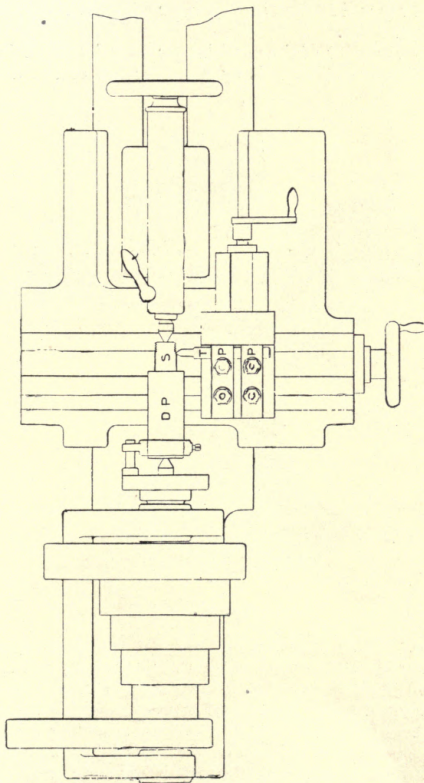

FIG. 214.

*drift.* In addition to its use in the production of cutting punches, large dies and cutting-out beds may be readily surfaced top and bottom and on their edges by means of the shaping machine.

A great amount of time and labour may be saved in the preparation of cutting beds by a proper use of the drilling

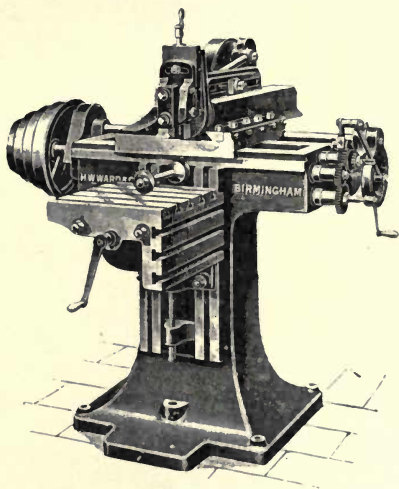

FIG. 215.

machine. That shown in fig. 217 has six speeds provided by means of a three-speed cone on counter shaft, and a two-speed cone on the spindle. The spindle cone runs on a bush attached to the frame, and drives the spindle by means of two keys in feather keyways, thereby removing all strain on the spindle from the pull of the belt. The spindle has a ball thrust, ensuring great sensitiveness and freedom from breaking drills, and the spindle is balanced by a flat coiled

spring. The top table swings away, leaving the centreing arrangement for centre-drilling the ends of cylindrical tools, spindles, and shafts. There is also a circular swivel table available under the drill for use on special work.

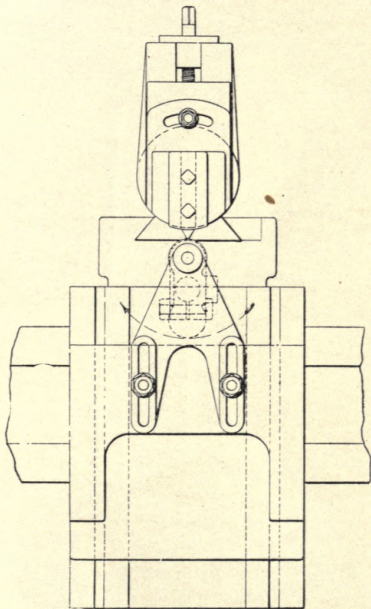

FIG. 216.

Another vertical drilling machine, capable of dealing with the larger work, is shown at fig. 218. This machine is of suitable design and construction to meet with the general requirements of both the tool and fitting shops, since it

embodies all the modern improvements for rapid and easy manipulation. The spindle is balanced, is fitted with ball thrust, and driven by two keys. The back gear is enclosed

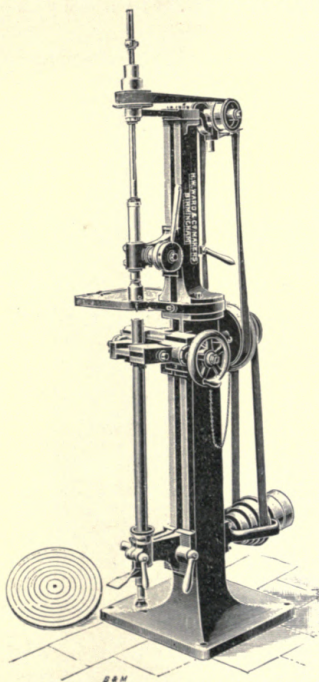

FIG. 217.

in the cone pulley and can be instantly engaged by the movements of the lever, and the machine-cut bevel gear,



seen on the top end of the spindle, is enclosed. The feed is automatic and has self-acting variable stop motion for use when drilling accurately to depth, and a reversing motion

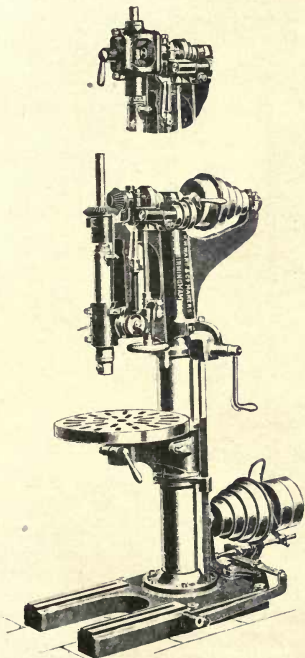

FIG. 218.

for tapping is provided, consisting of three bevel gears and clutch between, the clutch being operated by a lever placed in a convenient position on front of the machine.

The table may be raised and lowered on the column by bevel-wheel gear and screw, and may be swivelled out of the way when it is required to bring a heavy casting under the drill. But for the purpose of press-tool work it will be necessary to use the table, in a position at some distance up the column. The sketch, fig. 219, represents the drilling

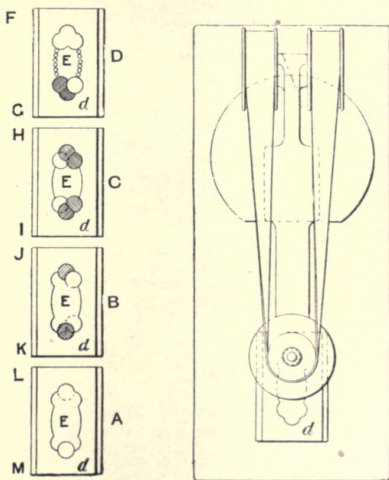

FIG. 219.

machine (shown in plan), operating upon a die *d*, intended for use in cutting sheet-steel blanks, and is an instructive example of the use to which the drilling machine may be put for such work. A, B, C, and D represent the four stages in the progress of the drilling. Beginning at A, we see the shape of the blank marked out, and one hole has been drilled at end M, forming one end of the blank. In the next stage, B, we have the two end holes plugged up, ready

for the holes at either side of the plug (at end K) to be drilled, whilst at end J the hole at one side of the plug has been drilled, this drilling having removed a portion of the plug. In the third stage, C, two plugs are shown in the holes at both ends, and it has been necessary to file flats on the plugs to get them into place ready for the third holes to be drilled in either end of the die. The plugging up of the holes may appear to some to be a trouble, but whenever a drill can be used in making a cutting bed to form any portion of the outline of its cutting edge, it is very much cheaper and satisfactory than if done by the ordinary method of chipping and filing. In the fourth stage, D, the three holes that have been drilled at end F clearly show the shape at one end as it will appear on the blank when cut, and at end G when the two plugs have been removed the same shape will appear there. It will further be noticed in sketch D that a series of small holes have been drilled, so that a small amount of chipping with a thin chisel will remove the centre piece E, ready for the two sides to be finished. A study of fig. 91 will further demonstrate the use of plugging and drilling, and the amount of drilling required to be done on the tools. Fig. 95 will clearly indicate that a drilling machine need not stand idle in a shop where press tools are manufactured.

The use of drilling and profiling machines has long been associated with the manufacture of small arms and sewing machines.

The chief application of the profiling machine was the formation of gun and pistol trigger action, the milling machine being chiefly employed in the preparation of the various cutters used in shaping the members of the gun, pistol, and sewing machines. Recent developments in milling operations have extended their use in many directions, and the advantages of this class of machine are worthy of receiving more attention from the sheet-metal worker and others not directly associated with mechanical engineering than they hitherto have done.

The milling machine, fig. 220, is an example of a modern machine fitted with the latest improvements and conveniences, suitable for the production of articles of small-

arms, cycle components, brass work, and for general engineering purposes. The headstock has a hardened and ground spindle running in conical bearings, a hole being bored through the entire length of the spindle, which facilitates the holding and removal of the cutter mandrel, the taper hole in the front end of spindle being bored to the Morse standard.

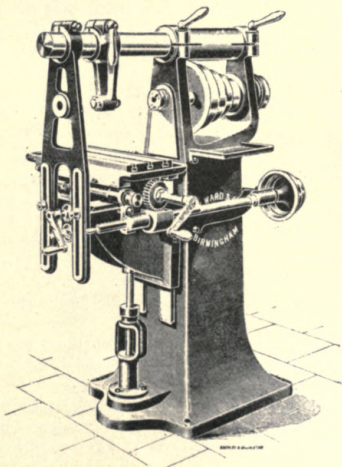

FIG. 220.

Two solid projections are formed on the end of the spindle, and these fit freely in milled slots in the mandrel collar, thus providing a positive drive, so that the driving of the cutter mandrel is not dependent upon the friction of the taper. The mandrel steady is an internal cone bush of suitable taper, and the steady arm is cylindrical and can be easily removed when necessary.

An effective brace is provided to tie the cylindrical steady-bar rigidly to the knee bracket of the machine for reducing the vibration to a minimum. The work-table has tee slots to receive the holding-down bolts, and the table has ample space to allow of several gangs of work being milled side by side, as is in some instances required. The knee bracket is fitted with screw and bevel gear for elevating, and has

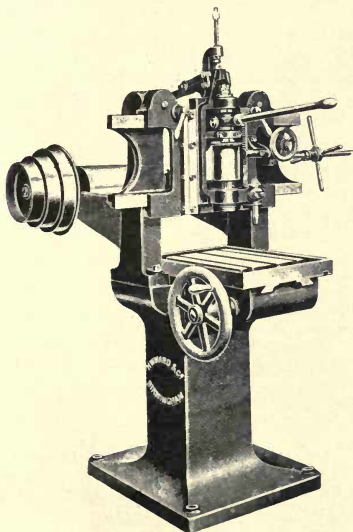

FIG. 221.

vertical stops and indicated discs for the purpose of setting on the cuts accurately. Automatic feed devices are provided with a trip gear, which stops the feed at any desired position, and adjustments are provided to enable the feed belts to be shortened or lengthened within reasonable limits

without cutting them. When suitable cutters are at hand ordinary cutting beds may be cheaply milled top, bottom, and edges, besides such tools as those seen at figs. 87, 94, and similar work. A typical profiling machine is represented at fig. 221. The vertical slide has a central stop-motion, and the lever for working the slide is also placed

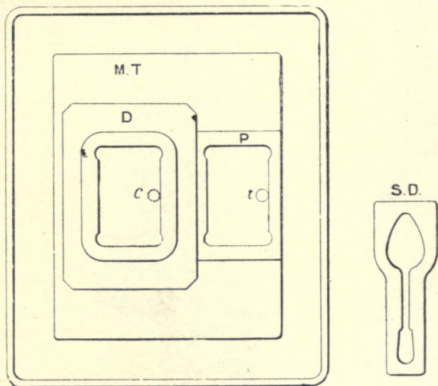

FIG. 223.

in a central position. The transverse slide runs on rollers, thereby making it very free to handle; it can be actuated by a screw and worm feed motion in addition to the ordinary lever, and is furnished with two locking bolts, to clamp it in any fixed position, and stops are provided to allow for milling to definite lengths. The work-table is actuated by wheels and pinion, and is provided with compensating devices to take up wear and ensure perfectly steady cutting. The principle of the profiling machine is indicated at fig. 222. A cutting-out bed *D* is fixed upon the work-table *M T*, and the milling cutter *c* is carried by a vertical spindle attached to the slide. A steel pattern *P* is fixed by the side of the

die *D* ; this pattern is also known as a template or former, and is made the exact contour as required to be formed upon the die *D*. At one side of the spindle which carries the cutter a tracing or feeling peg *t* is fixed ; this peg is turned taper, so that by lowering or raising the peg the cutter *c* will be drawn to or from the die *D*, as the case may be. The feeler is kept hard up against the former *P* by means of a chain and weight attached to the slide ; and

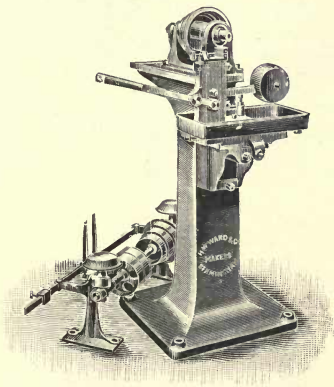

FIG. 223.

since the distance between the feeler *t* and the cutter *c* is always the same, it will be readily understood that as the feeler *t* travels over the contour of the pattern *P*, so the cutter *c* will travel round the die *D*, thereby producing the required contour thereon. Another example of die that may be easily formed by profiling is the die *S D*, intended for cutting spoon blanks, and the profiling machine may be as readily used for external as internal work. A study of the various and peculiar shapes of cutting dies to be met with in any sheet-metal works will give an idea as to the machine's usefulness. In a tool room, where large quantities

of small screws are required for joining up the various parts of dies, punches, and bolsters, the screw-nicking machine, fig. 223, will be a useful addition for milling the slits in the heads of screws; and the screw-polishing machine, fig. 224, may be used for polishing the small screws, pins, and piercing punches, which would otherwise occupy the lathe.

The ordinary machine vice, owing to the uplift of the loose jaw and unreliability of the fixed jaw, has hitherto not been

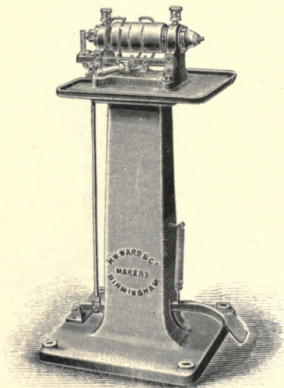

FIG. 224.

of much use for dealing with tool work of any great accuracy, and the special machine vice, known as Taylor's patent, has many advantages. In making this vice great care is taken as regards parallelism of the upper and lower faces of the vice. Any work done upon the upper surface of the article may be depended upon to be true with its under surface, and the necessity of hammering down the article held in the vice is abolished.



The direct action of the screw enables the necessary degree of tightness to be obtained with the expenditure of less force than is required with an ordinary vice, and, in consequence of its favourable position, the screw escapes the

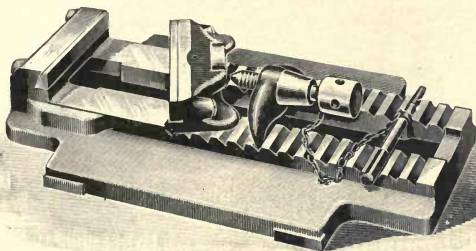

FIG. 225.

dirt and swarf of the cuttings. The "Taylor" vice is represented at figs. 225 and 226. It will be seen that the loose jaw is free to slide backwards and forwards in the longitudinal slot of the vice, as is also the grip plate when tilted

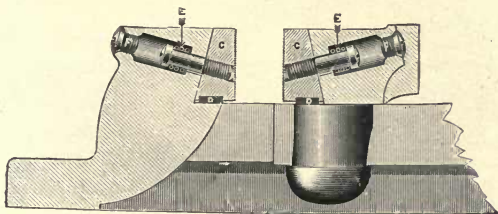

FIG. 226.

slightly forward, thereby disengaging the two strong teeth from those on the body of the vice. Fig. 226 is a section of part of the vice, showing that the rear faces of the steel jaw plates C, C are inclined, thus causing them—when an article

is gripped—to slide downwards for a very short distance, carrying with them the article held, the pin holes in the jaws being slotted to allow of this motion. E, E are screws and springs holding jaw plates back. These plates are raised

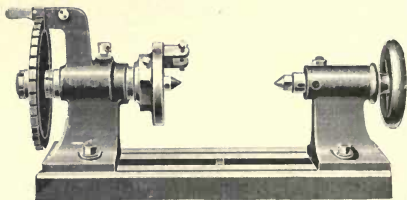

FIG. 227.

again when the article being held is released, by simple springs working in the recesses D, D, shown at the bottom of each plate. The small cap screw F keeps water and dirt from entering the pin hole. A piece of hardened steel is

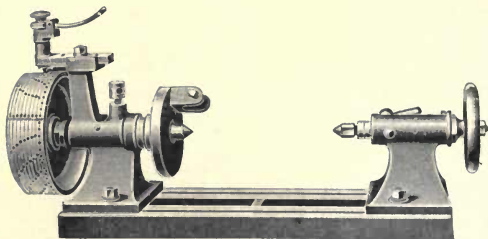

FIG. 228.

fixed in the centre at the back of the moveable jaw to receive the pressure of the screw. These vices are sometimes provided with special vertical tilting adjustable angle plates, forming a convenient attachment for use on milling and shaping machines when employed on general tool work.

The dividing headstocks, represented at figs. 227, 228, and 229, are for general use on either milling or shaping machines. Fig. 227 is a 6 in. centre plain set of heads, and admits 15 inches between the centres, a notched dividing plate being attached thereto. Fig. 228 is a set of  $4\frac{1}{2}$  in. plain heads, admitting 12 inches between the centres. This apparatus is provided with a drilled drum of large diameter, having nine rows of divisions, with the following numbers—120, 100, 90, 88, 72, 64, 42, 36, 26.

The quadrant dividing headstock, fig. 229, is fitted with a switching block, graduated to set the spindle to any angle,

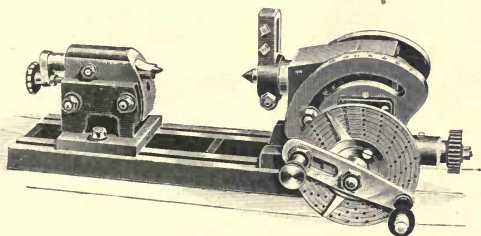

FIG. 229.

from a horizontal to a vertical position, and provided for cutting cutters of any angle. The divisions are obtained by means of worm and worm wheel, and with the plate supplied most numbers can be obtained from 2 to 360 divisions. The index fingers can be set to any division, and by their use the necessity of counting and the danger of mistake are entirely avoided.

## CHAPTER XVII.

## TOOLS AND JIGS FOR REPETITION WORK.

THE lathe test indicator, fig. 232, is for use in setting central any point or hole in a piece of work to be operated upon in a lathe or upon a lathe face-plate. It may also be used for testing lathe centres, shafting, or other work held between

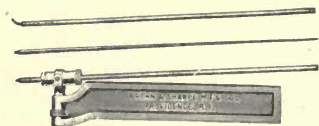

FIG. 232.

lathe centres, the inside or outside of cylinders, pulleys, etc., and all work of a similar class. The tool is of such size as to be held conveniently in the tool post of a lathe; the bar is

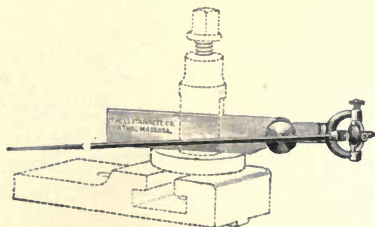

FIG. 233.

drop-forged and formed at the end to receive an universal joint for supporting the finger. A clamp nut is provided for clamping the joint when it is desired to have only a vertical movement to the finger, as in testing pieces held

between lathe centres. The bushing which holds the finger is split, thus allowing the finger to be adjusted to any required length, and clamped in position. The finger holder is provided with two fingers; either one of these may be quickly attached; one finger is ground to an angle of 60 deg. and the other is bent for inside and outside testing. A spiral spring is provided for holding the finger against the work with an even pressure.

An improved instrument known as a centre-tester, fig. 233, is of a special design for use in adjusting and locating central

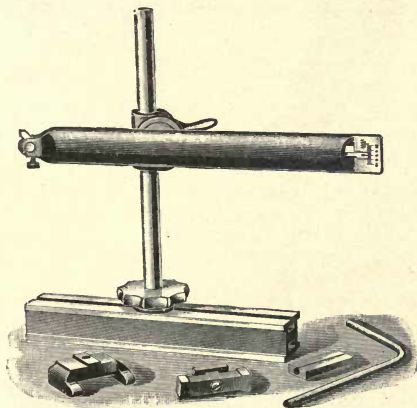

FIG. 234.

any point or hole in a piece of work, which is to be operated upon, in a chuck or upon a face-plate. The tester is shown fixed in a tool post ready for use; a steel bead (not shown) is carried on the needle, it slips over the point of same, when used for inside work. The instrument is joined to a tool post shank by a flexible steel ribbon, with sufficient spring to properly hold the needle in contact with the work. The ball through which the indicating needle passes is pivoted

to form an universal joint, but may be instantly converted into a single joint for a tilting motion, by tightening the knurled nut.

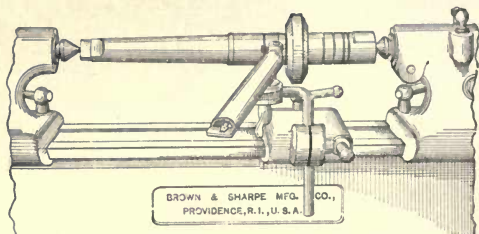

FIG. 235.

Another test indicator, fig. 234, is especially serviceable to those who have the erecting or inspecting of high-class machines, as it is possible by its use to readily determine the degree of inaccuracy of a surface on the top, bottom, or side of a piece of work, or to easily ascertain the amount

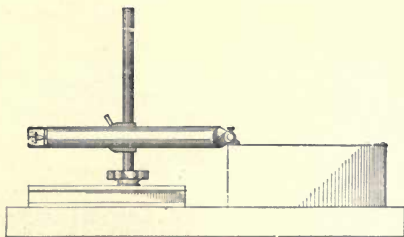

FIG. 236.

of end movement, for example, of a spindle, or the extent to which it runs out of truth. The illustrations, figs. 235, 236, 237, and 238, show a few of the many applications of the test indicator. The upright post or stand may be

clamped at any point upon the base by the thumb nut, and the sleeve which carries the arm may be fastened at any height on the post, or turned around the post to bring the

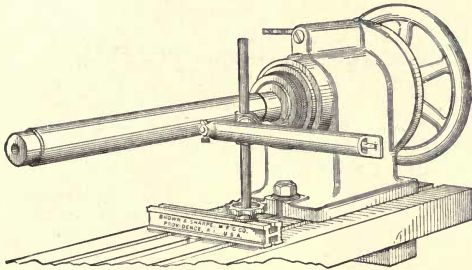

FIG. 237.

arm on either side. The arm turns in the sleeve, and may be set at any angle relative to the base; it may be converted so that the point brought in contact with the work will be downward rather than in the position shown in fig. 234, or

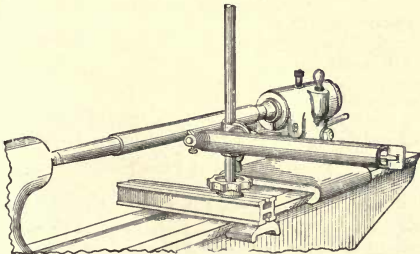

FIG. 238

it can be removed from the post and used independently. A split block and an angular post are furnished with this test indicator, for use in the tool-post of a lathe. The movement

of the point that bears against the work is magnified a number of times by the length of the index finger, and can be easily read upon the scale. The finger can be adjusted and brought to zero by the knurled screw shown. It is enclosed and protected from injury, and stops are provided for use on the underside of the base against perpendicular or angular surfaces; the length of the base is 8 in., the height of the post 9 in., and the graduations read to thousandths of an inch.

One method of setting for boring two holes at a definite distance from centre to centre is represented at fig. 239. For example, the holes required to be bored in a steel die A are

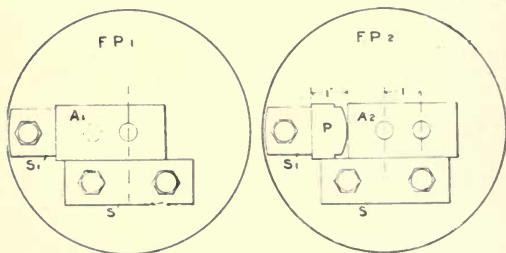

FIG. 239.

$\frac{1}{2}$  in. diameter, and their centres 1 in. apart. FP 1 represents a lathe face-plate, upon which is fixed the steel die; this is shown set in the position required for the first hole to be bored. S is an iron plate to prevent the die A 1 from dropping. Another small iron stop plate S 1, is to prevent the die A 1 from slipping sideways. The small iron straps or plates and bolts for holding the die upon the face plate are not shown. The setting of the die would be done with the assistance of the special centre tester as represented at figs. 232 and 233. Having bored the first hole, the die is moved along the stop-plate S a sufficient distance to allow the packing piece P to be introduced; this piece is filed up to measure exactly 1 in., and consequently the two holes in the die will be exactly 1 in.



between their centres. This method is frequently used in first-class workshops, but although very useful under certain conditions, it is not a sure or reliable method. The least speck of dirt between the faces of P and A 2 will alter the measurement, besides special packing pieces being required for every different measurement.

Another method of setting for boring holes is seen at fig. 240, and may be depended on to give absolutely accurate

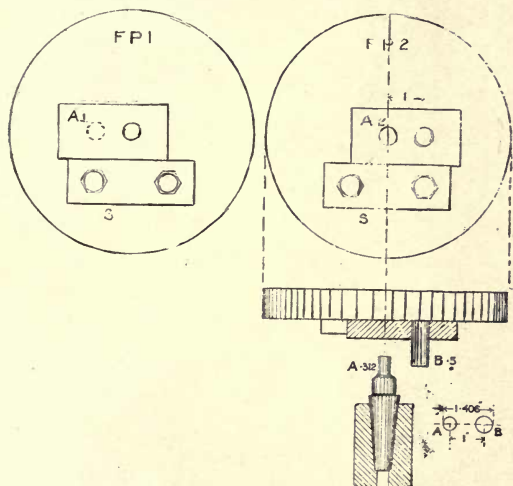

FIG. 240.

results. Referring to the figure it will be seen that the die has been fixed by the aid of a centre tester, and the stop plate S brought up to the die, and the first hole bored. We will now trace the means by which the new position is found. Referring to the section it will be noticed that a standard  $\frac{1}{2}$  in. plug gauge B has been inserted into the first hole.

This  $\frac{1}{2}$  in. plug must necessarily be a good fit. A second plug A, which may be any diameter (in present instance  $\frac{5}{16}$  in.), is made in the form of a lathe centre, and is fixed into the barrel of the movable headstock of the lathe. It will be readily seen that by means of these two plugs it is easy to so fix the die A 2 upon the face-plate as to enable

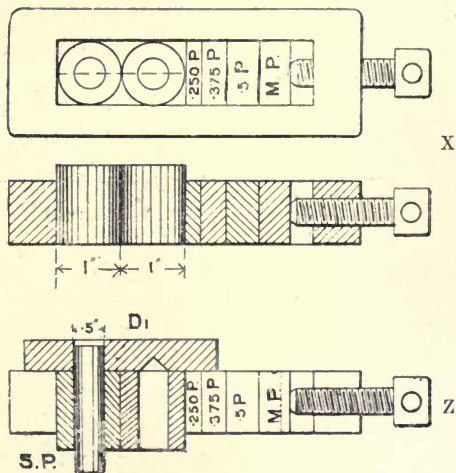

FIG. 241.

holes to be bored at any required centre. Taking the example of the  $\frac{1}{2}$  in. holes of 1 in. centres, here we have 1 in. centres plus half  $\frac{5}{16}$  in., plus half  $\frac{1}{2}$  in. = 1.406 in. Therefore, when the micrometer gauge just passes over the plugs, then the die is set for holes at 1 in. centres. One practical application of the method represented at fig. 240 was boring the two holes in the standard die or cutting-out bed, fig. 91.

Another method by which two or more holes may be drilled at any centres is shown at fig. 241. In this case the centres are fixed by means of steel bushes and packing pieces. To make the method readily understood, we may for simplicity still keep to the steel die having holes  $\frac{1}{2}$  in. diameter, and 1 in. centres. X is a piece of steel measuring  $5\frac{1}{2}$  in. in length, 2 in. wide, and 1 in. thick. This has a slot 4 in. long and 1 in. wide running along the centre. Into this slot two steel bushes 1 in. diameter and  $1\frac{1}{4}$  in. long are introduced, the bushes having  $\frac{1}{2}$  in. holes bored through them, and they are hardened and ground perfectly true.

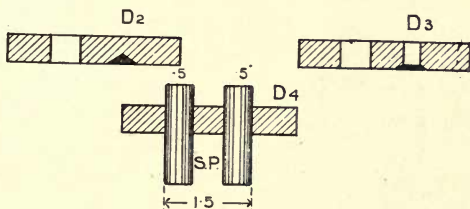

FIG. 242.

Then when these two bushes are brought together their centres will be exactly 1 in. apart, and since they are firmly fixed together by means of packing pieces and set pin, the whole arrangement becomes at once a simple form of drilling jig. The packing pieces being  $\cdot 250$  in.,  $\cdot 375$  in., and  $\cdot 5$  in. thick, when placed between the pair of steel bushes the centres of these bushes will be 1.250 in., 1.375 in., and 1.5 in. apart respectively.

At fig. 241 Z is a section showing the method by which No. 2 hole is drilled. The die D 1 is coupled to the drilling jig by means of a steel plug S P, and a  $\frac{1}{2}$  in. twist drill is passed down the second bush, and its point penetrates the die a short distance, sketch D 2, fig. 242. The next step is to pass a  $\frac{3}{8}$  in. or  $\frac{7}{16}$  in. twist drill through the die—(see D 3)—then finally pass the  $\frac{1}{2}$  in. twist through the bush and die (sketch D 4). This system has been adopted for making

a variety of tools and jigs for drilling and piercing, and has been found useful and reliable.

The sketches, figs. 243, 244, 245, indicate the usual method by which a piece of work to be bored is fixed upon the face-plate by bolts and strapping plates. These sketches further show the principle of the centre tester. Referring to fig. 243, the steel die A is fixed upon the face-plate F P

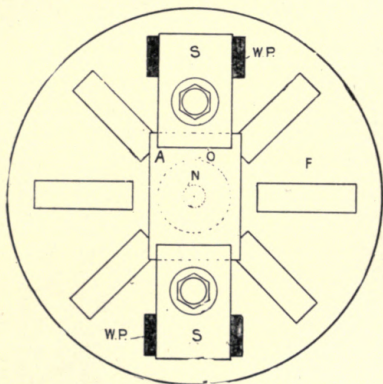

FIG. 243.

ready (in this instance) to have a hole bored in it. The die A is held by S and S'. There are two wood packing pieces W P between the straps and the face-plate. No stop plates are required on this work, since there is only one hole to be bored; but there are instances where it may sometimes be advisable to use one or more stop plates, so as to prevent the work being accidentally moved whilst boring—as for example, when heavy boring cuts are being taken, or when a piece of work is of delicate strength and peculiar shape. In instances of this kind the stop plates, besides holding the work steady, also drive it in a similar manner to that that

the driving peg drives a lathe carrier when a shaft is being turned.

The old method of setting work true upon a face-plate was to describe a large circle upon the surface, as at O, fig. 243. A pointed piece of steel was then fixed in the toolbox, the point being brought close up to the circle whilst the lathe was in motion, thus indicating if the circle O ran true. This large circle is not necessary if a centre tester is used. It will be noticed that a smaller circle N is shown, which has been described from the centre dot C upon the die A,

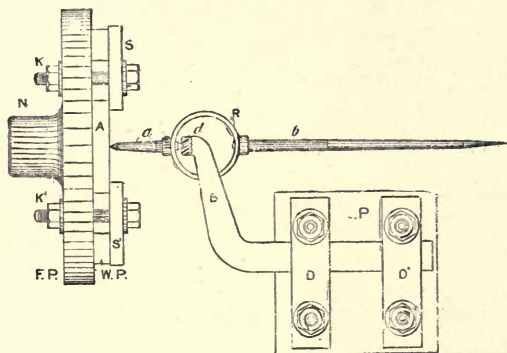

FIG 244.

and is equal in diameter to the hole that is to be bored. At figs. 244 and 245 a ring R is seen, into which the steel rod *a*, having both ends pointed, is fixed, and another rod *b*, having one end drawn out to a long taper terminating at a point. These two rods *a* and *b* are in perfect alignment; one end of rod *a* is held in the centre dot *c* of the die, whilst the other end is placed into another centre hole *d* of the holder B. This apparatus demonstrates the principle of the delicate special centre-testing instruments described in figs. 232 and 233. As may be judged from the sketches shown at figs. 244 and 245, this is an apparatus that can be made in any

ordinary tool-room, and, though of rougher character than fig. 233, it is very useful. The position of centre hole  $d$ , at fig. 244, would be determined by placing it against the lathe centre.  $B$  is fixed into the tool holder by the clamp plates  $D$  and  $D^1$ . In fig. 245 it will be seen that the length of rod  $a$  is 2 in., whilst the distance from  $d$  to the extreme end of rod



Fig. 245.

$b$  is 10 in., or a ratio of 5 to 1. So that, when testing a piece of work for being set true, should the centre dot  $c$  run out of true  $\frac{1}{32}$  in., the extreme end of rod  $b$  would run out of true  $\frac{5}{32}$  in., thereby magnifying the inaccuracy. From this it will be readily understood that the centre tester is of great assistance when setting work.

## CHAPTER XVIII.

### INTERCHANGEABLE MACHINE PARTS.

MACHINES of somewhat small and delicate design are frequently required in which their members must necessarily come together accurately and yet be interchangeable. A machine of this description is shown at fig. 246, as used for spinning the heads of rivets. A barrel  $B$ , having teeth formed upon a portion of its length, gears into a rack formed on the sleeve  $S$ , and as it rotates so the sleeve is advanced, carrying forward the spinning tools to operate upon the rivet head. Assuming that one dozen or more machines are to be made from this pattern, and that any pair of heads are expected to come together, and their centres to be in perfect alignment, and further that any barrel or any sleeve shall pass into and be a working fit in any one of the twenty-four or more headstocks, the work will necessarily be of a delicate

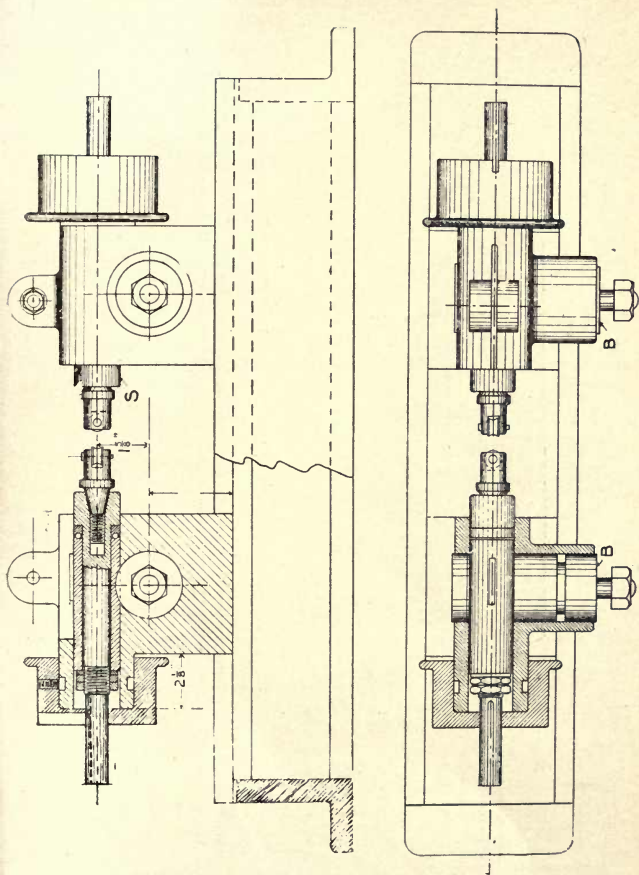
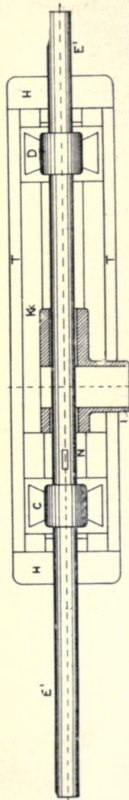
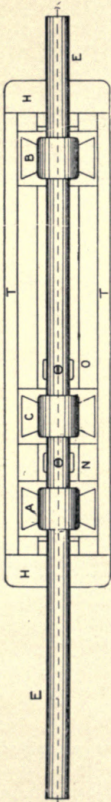

FIG. 246.





nature, and it is essential that special care be taken in the boring of the headstocks. With the very best class of tools and first-class workmen, it is questionable whether the parts could be made interchangeable, unless jigs are used. It is, however, possible, in these special instances, to insure that the heads be bored so that the results are perfectly reliable if suitable jigs, which may be of simple design, are provided for the purpose. To trace how these twenty-four headstocks may be bored will demonstrate the principle of the jig as applied to this class of work. In fig. 247 the casting H is planed out to receive the base of the headstocks to be bored. At fig. 249 four castings, A, B, C, and D, are seen, two of which are prepared to receive the boring bar E. Taking, for example, castings A and B, their bases must be planed to fit the jig bed H, and they are next set out at the required height, and bored

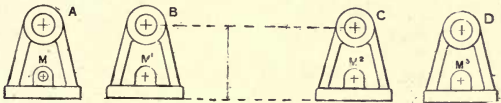

FIG. 249.

upon the angle and face-plates of an ordinary lathe. The next step is to fix them upon the casting H, fig. 247, and introduce the boring bar E, which must be held by two collars (not shown), so that the bar can rotate in castings A and B, but not move in the direction of its length. A and B may have been set out and bored by a careful and competent turner, but are not likely to be absolutely perfect. The next step is to bore C and D in the same manner that A and B were bored, only the holes in the former must be, say,  $\frac{1}{16}$  in. larger in diameter, to enable the boring bar to rotate freely without touching the castings, whilst the bar is being carried by the smaller holes in A and B. The reason for this will be understood by referring to fig. 247, where C is to be bored. The castings C and D, in their turn, are placed upon bed H, and are held down by plates and pins, only sufficient pressure being given to ensure keeping them

down upon the bed, but to allow of them being moved along the bed under the pressure from a long set-screw. It will be noticed that casting A has been drilled and tapped at M,

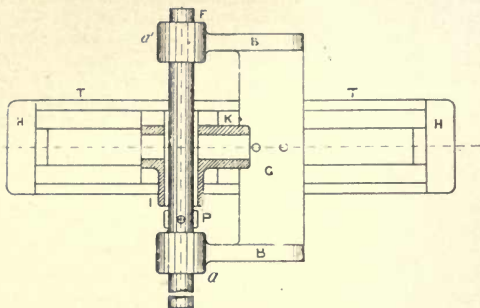

FIG. 250.

to receive the screw *f* seen at fig. 251. This set-screw is placed in the boss, and brought up against boss M<sup>2</sup> of casting C, thereby moving the latter along the bed to enable cutter O to bore the hole. From this it will be seen that, even

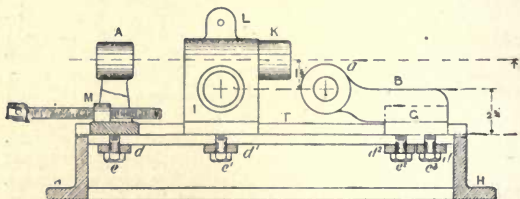

FIG. 251.

supposing A and B to have been inaccurately bored, C and D are certain to be accurate, if reasonable care has been taken to see that the bar runs a good fit in A and B. Castings A and B may be thrown away, since they will not

be required again. The boring bar just used is now substituted by a larger boring bar  $E^1$ . Fig. 248 shows headstock K being bored. This headstock K and all subsequent ones are, in their turn, moved along the casting by means of the long set-pin  $f$ , to enable the boring to be done. Another casting G, fig. 250, which is securely fastened to the bed H, carries the boring bar F, and forms a jig for boring the transverse hole to receive the barrel wheel B (seen at fig. 246). In this case the boring bar travels along carrying the cutter P, whilst the headstock K is firmly fixed to the bed H. A part section of the jig is shown at fig. 251. It will be necessary to drill and tap a hole in casting C at boss  $M^2$  to receive the set-pin. There may appear to be a fair amount of labour required in making this jig, but a careful study of its action will demonstrate that its value as a safeguard against inaccuracy will amply repay itself.

---

## CHAPTER XIX.

### PRESS TOOL-SETTING.

THE old adage—an incompetent workman finds fault with his tools—is as true in press work as in any other industrial department.

No matter how well designed and equipped a works may be, unless the shops are under good management, assisted by competent workmen, the result will be unsatisfactory. It would be beyond the province of these articles to give all the details necessary to explain how every machine should have its varied tools set for successful working. We will therefore briefly draw attention to some few points of general application concerning the tools in this important section of machine working—points that are to some extent overlooked or considered to be of little import, although they govern the quantity and quality of the production, besides affecting both the life of the machine and its tools, in addition to frequently resulting in power being lost or wasted in unproductive work.

Assuming that a first-class machine is supplied with thoroughly accurate tools, the next question is, naturally, the setting of these tools so as to enable the operator to produce good work quickly from the machine. This would in some instances be a simple matter which a careful machine attendant could manage. In other instances the tools may be of such a complicated nature, that a considerable amount of ability and experience may be required to set the tools. A few examples will demonstrate that this is so. In the case of cut-tach and tingle making, an experienced machine minder will have charge of from six to twelve machines; he will both make, grind, and set the tools, but will have female operators to put the strip-iron into the machine, and attend its working. Wire-tach, rivet, panel-pin, wire-nail, staple, and split cotters is a class of work also requiring a skilled mechanic as chief minder, to make and set all tools, the wiring of the machine from the swift being carried out by female or male attendants, according to the size of the work—*i.e.*, the weight of the coil of wire from which the nails are made. Thus in the case of nail machinery the tool-maker is held responsible for the correct setting of his own tools, besides the supervision of the machinery when in motion.

As another example, we may consider metal-stamping, drop-forging, and similar work. The stamping or forging *dies* will be made in a tool-room, thence passed into the hands of an experienced stamper, capable of setting his own tools in the stamp, though he be neither a tool-maker nor mechanic. In other instances the stampers, both male and female, may not be capable of setting tools, but merely proficient in placing the metal between the *dies* and working the stamp. Regarding press tool-setting, it may be truly said that, as a general rule, in small workshops this question is considered to be of minor importance, although a great waste of time and material is caused, due alone to imperfect tool-setting.

An instance came under the authors notice. In a factory where hundreds of machines were in use the more important tools and machines were made in one large fitting and tool-making shop in a central part of the works, thence supplied to the various work-rooms, each under the supervision of a tool-setter having charge of a number of machines and

presses, the operators being pieceworkers. It was noticed that in a certain work-room an unusually heavy demand for tool renewals was experienced. The machines which had been condemned by the tool-setter were replaced with new and first-class machines ; but neither the quantity nor quality of the output improved, nor the demand for tools reduced with the new machines. A competent machine-tool fitter was despatched to carefully examine the machines and investigate matters generally, when it was found that the *press-rams*—which had been properly adjusted in the machine-tool shop—had been re-adjusted by the tool-setter. The slides and rams of the machines were found to have been tightened, requiring considerably more power to drive the machines, besides galling the slides, rams, and guide strips—in fact so much so that re-planing was necessary. The cause of all this trouble was traced to defective tool-setting, and the tool-setter had gripped up the rams, thinking thereby to prevent the tools kicking. In the other work-rooms, where the adjustments of the machines had not been tampered with, no trouble was experienced.

If the tool-setter finds a slide or ram working slack, he should immediately draw the attention of the machine-tool fitter to the defect. If a ram is to work properly, it requires careful adjusting, so that it may work up and down its stroke quite freely, yet have no play or be likely to *kick* when working the tools.

Any slide or ram is difficult to set accurately, and the most troublesome to set is the fly-press ram of square pattern, as these may be adjusted so tightly that they can be scarcely moved by the screw, yet they will *kick* sufficiently to ruin a pair of cutting-out, blanking, or piercing tools at the first blow.

Although it has been mentioned as being advisable, if possible, to have someone to do the tool-setting who has had some training in tool-making, there are instances known where workmen, without any previous knowledge of working machine tools of any kind, have been trained to set tools in the press, and have become quite expert and valuable tool-setters.

The question of tool-setting is an important one, and

should always be kept in view when tools are being designed. It is, however, too often the case that no thought whatever is given to this question; consequently a set of tools—say, for example, a punch and die—are made before any thought is given to either the tool-setting or how the metal blanks are to be stripped from the punch. The result is that probably an unsuitable stripper is used, and a rough method of setting adopted. The method of stripping the scrap

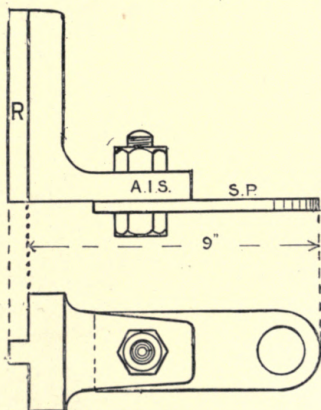

FIG. 252.

metal in press work plays a very important part upon the successful action, as well as upon the life, of the tools; particularly is this so in the case of small delicate press-tools, where a crude stripper arrangement will frequently make bad work, in addition to damaging or breaking the tools.

The old system of stripping, which is even now practised to a certain extent, is to have a slot cast through the back of the press in single-sided presses, and in double-sided

presses a slot cast through each side of the press-frame casting. This slot is of sufficient width and depth to receive a hexagonal-headed bolt, and allow of the bolt being raised up and down for adjustment. A wrought-iron angle forging is fastened to the press-frame by means of the bolt and a strap plate, the bolt passing through the angle-iron and the slot in the press-frame. The angle-iron can either be made to act as a stripper, or some other form of stripper may be mounted and securely fastened to it. An angle-iron stripper will be seen at fig. 252. This angle-plate method of stripping is a rough-and-ready one, and is used with some success for *rough* sheet-iron work. It cannot, however, be recommended with safety for general work for several reasons.

*Firstly*, this stripper arrangement depends too much upon the ability and expertness of the tool-setter. *Secondly*, this stripper is apt to be used for too many kinds of work. *Thirdly*, as the stripper is held against the face of the press-frame by a bolt, there is considerable leverage upon the angle-iron, which springs the whole stripper arrangement.

In many instances a tool-setter will take advantage of this springing action for the purpose of throwing the work from the tools, and it is done in the following manner: After a blank is pierced, the punch on the return stroke carries the blank up to the stripper, and this in turn forces the stripper to spring upwards, and directly the blank is removed from the punch the pressure is released from the stripper, which now returns to its normal position, and thereby throws the blank some distance from the tools. This fact will demonstrate that a fair amount of springing action occurs with this type of stripper, which is detrimental to both work and tools.

The reason why the angle-iron type of stripper, fig. 252, is used so extensively is that it can be used for various sizes of work, even though there may be a large clearance between the piercing punch and stripper hole, which may cause the blank to be bent or otherwise distorted during the process of stripping.

Suppose twenty sets of tools, all differing, are to be used

in a particular power or screw press ; one angle-plate stripper can be used for the twenty sets of tools by using various iron-plates (see fig. 252), where the additional stripper-plate SP is attached to the angle-plate stripper AIS. The only instance where this type of stripper has been known to work successfully was when the angle-plate forging was planed square, and had a rib upon the back, as fig. 252 at R, to fit the slot in the press-frame. Also when used on a double-

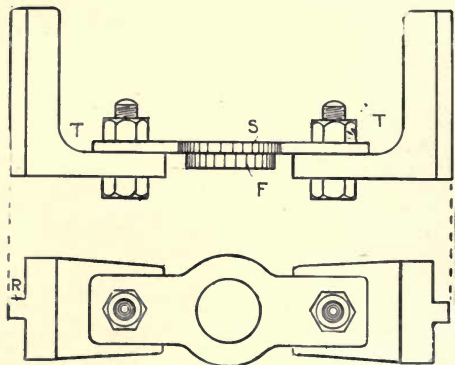

FIG. 253.

sided press, and two separate and well-made angle-plates have been fixed, one on either side of the press-frame, set level with each other, and planed upon the top (see fig. 253 at T), to receive various special stripper-plate forgings, which have in turn been planed, bored, and turned perfectly square and true, as at F. It is, however, *seldom* that one can meet with strippers of this type made and finished in the manner they should be if good work is to result.

From what has here been mentioned in reference to the angle plate type of stripper, it will be readily understood that, when possible, it is advisable to dispense with it, and substitute a more reliable form.



An excellent combined stripper-plate and metal-guide is shown at figs. 103, 104, and 105, arranged to be fixed to the die bolster, and intended for cutting chain-link blanks. In this case the stripper is raised and lowered by means of lock-nuts, and the two small bars across the underside of the stripper-plate are placed at a sufficient distance apart to admit the steel strip from which the blanks are to be cut. When a set of tools are fitted up in the manner shown at figs. 103, 104, and 105, the punch may be removed from the press after a batch of blanks have been cut, and punch, die, bolster, and stripper all stored away together ready for immediate future use.

The proper method is to provide every bolster with its own stripper or strippers, which should be made suitable for the various sets of tools. It is necessary that the bolster

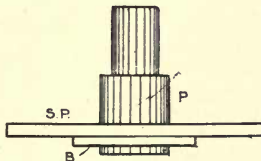

FIG. 254.

be planed on the top, and have suitable holes drilled and tapped to receive the stripper holding-down pins. A stripper may either be fixed in this manner, or it may be attached as shown at figs. 103, 104, and 105.

A stripper to work efficiently must be set at right angles to the side of a punch, and absolutely level with the top of the die, and the hole in the stripper should be of sufficient size to comfortably pass the punch. When a punch is raised up it should, after piercing a blank, bring the whole surface of the blank into contact with the under side of the stripper (see fig. 254); the blank will then be removed from the punch with an easy sliding action, and without placing any side strain upon the punch, as would happen if the stripper were set as shown at fig. 255. It will readily be

seen in this figure that the slipper-plate SP is not set level; consequently the blank touches at *a* and is off at *b*. When tools are set in this careless manner trouble will arise. Owing to the improper use of strippers and tools it is not unusual for much time to be wasted.

It is interesting to trace the proper method of setting the tools seen at figs. 102 to 105.

*Firstly*, the punch should be firmly fixed into the press-ram by means of the set-pin in the ram, the pin preferably being screwed up by a steel box-spanner, since it gives a better purchase than can be obtained by an ordinary spanner. *Secondly*, after fixing the bed into the centre of the bolster, bring the latter under the punch, which

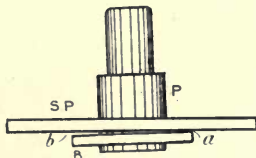

FIG. 255.

carefully lower into the bed. Place the bolster holding-down pins into position, and lightly nip them down; raise the punch and again carefully lower it into the bed, making quite certain that it does not come in contact with the cutting edge of the bed. Next screw down both holding-down pins, proceeding a little at a time—first one pin, then the other. *Thirdly*, place the stripper in position on the bolster, the guide-bars resting upon the top of the bed. Place a piece of metal upon the bed, and cut one blank; the punch should then be raised up until the metal strip touches the under side of the stripper, which may now be set level with the metal strip. If instead of the stripper being fixed by lock-nuts it had been fastened upon the top-surface of the bolster, it would not have been necessary to test for being level. The idea of using the lock-nuts in the tools, fig. 104, is to enable beds of various thicknesses to be used,

without the necessity of packing pieces. Now, suppose the tools which may have been working a few hours require grinding and re-setting, the bed-key can be driven out, fig. 102, and replaced after the bed has been ground, enabling the tools to be re-set in considerably less time than had the bolster been loosened.

When cutting blanks from sheet-metal without the assistance of feed-rolls, it is usual to fix a stop-peg in the bed to

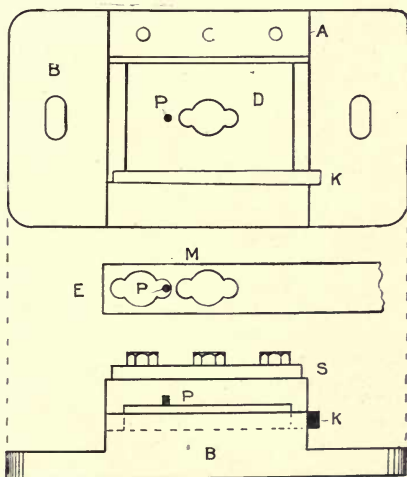

FIG. 256.

enable the operator to bring the metal in the proper position to cover the hole in the bed. Were it not for this peg, it would be practically impossible for an operator to leave a uniform amount of scrap metal between each pair of blanks. A bolster B and a bed D are shown at fig. 256, fitted with the stop-peg P, the end E of the metal M being brought up against the stop-peg whilst the first blank is cut. Previous

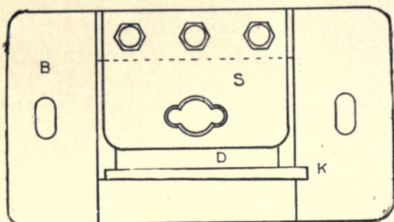

FIG. 257.

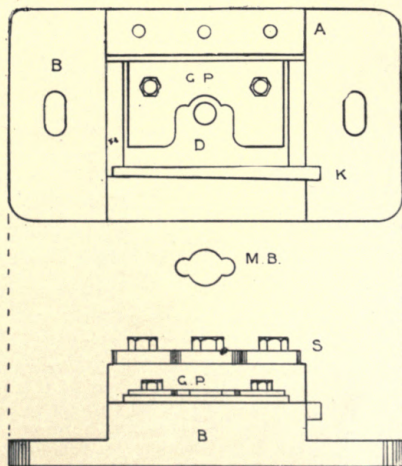

FIG. 258.

to the second blank being cut, it will be necessary to lift the metal over the peg P, so that it comes into the hole made by the cutting of the first blank; this places the metal M in the proper position ready for the second blank to be cut. The bed is here seen fixed in position by the key K, and the

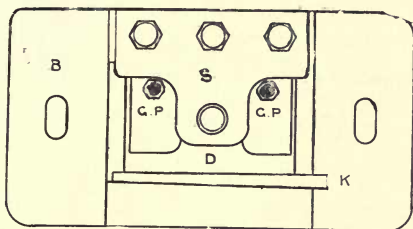

FIG. 259.

stripper-plate S is secured upon the bolster casting at A. Fig. 257 is a plan of the stripper-plate, and it will be noticed that the hole in the stripper-plate is slightly larger than the hole in the cutting bed.

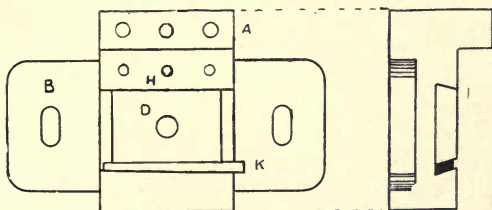

FIG. 260.

The tools, fig. 258, are for piercing a round hole in the blanks that have been previously cut by the tools, figs. 256 and 257. Referring to fig. 258, a guide plate G P is fixed upon the piercing die, to ensure the metal-blank M B being pierced centrally.

The stripper *S* is fastened at *A*, and this part of the bolster casting is raised up a sufficient height to allow a proper freedom of space between the stripper and guide plates. A plan of the piercing tools is shown at fig. 259, from which the position of the stripper and guide plates will be seen.

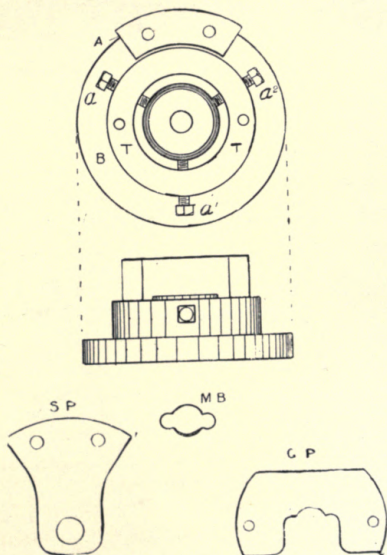

FIG. 261.

Fig. 260 represents another type of bolster to receive a similar pair of piercing tools to those at figs. 258 and 259, the difference being, that whereas in fig. 260 the stripper-plate is fastened to the bolster at *A*, and the guide-plate is

fastened on to the bolster at H, in figs. 258 and 259 the guide-plate is fastened on to the bed itself.

Another design of bolster and tools is shown at fig. 261. This set of tools is arranged for piercing the same blank as the tools, figs. 258, 259, and 260 were, but in the case of fig. 261 both the bolster and the bed are cylindrical in form.

The stripper-plate SP is secured to the raised portion A of the bolster-casting B, whilst the guide-plate GP is fastened to the top of the bolster at  $T_1 T_1$ . Three set-pins,  $a, a^1, a^2$ , are intended to enable the tool-setter to move the bed about until it is set in the proper relative position with the guide-plate, to ensure that the blanks shall be pierced centrally.

#### HARDENING AND TEMPERING.

In the case of cutting, shearing, stamping, drawing, and similar tools that have to be hardened to enable them to deal with sheet metals, it is necessary to exercise special care in heating them to the required temperature before they are plunged into the water bath for cooling. The careful and uniform heating applies to all hardening, more or less, but it is of particular importance in the case of expensive dies or punches. The principal point is to watch that the tool be heated as gradually as possible, and too much stress cannot be placed upon the importance of care in hardening. It is not unusual to see a blacksmith or a toolmaker place a large die into a fire, heat one side red-hot, whilst the other side is nearly cold; he will next turn the die round and heat that side which was cold, whilst that which was red-hot will get nearly cold again. The author has seen this done repeatedly, but there is no brand of steel made that will stand such treatment. There are now special gas stoves that may be used, and properly constructed muffles may also be erected and fed by the application of fine slack, which will do useful work in heating tools for hardening. Where neither of these are handy it is possible to heat a tool properly in a breeze fire, providing that the fire is large enough for the purpose, but it is useless trying to heat tools uniformly in a small fire. First blow up a fairly large fire, then introduce the die, and, covering the die with red-hot breeze, blow the fire very gently until the die has a

thorough gentle soaking. The greatest trouble with which the toolmaker has to contend in hardening his tools is the risk of their splitting, cracking, or warping. The cause of these troubles is generally the cooling and contraction of the various portions of the tool at different rates. To avoid this cracking and warping it is important that the tool be uniformly heated and as uniformly cooled as possible. In the case of dies, all screw, dowel, or gauge-pin holes in them should be filled with clay during the process of hardening. When quenching the tool plunge it straight down into the water, holding it stationary for a minute or so, then move it slowly about, keeping it perpendicular all the time. *Do not use any of the so-called special hardening mixtures or fluids*, as they are practically worthless for tools. Use a plentiful supply of fresh clean water and brine, or rain water and brine, then, when you meet with a brand of steel that cannot be hardened by heating to a cherry-red and quenching in cold clean water, treat it as useless for tools and at once dispense with it. Tools such as drawing or extending dies, where the hole is required to be perfectly hard for its whole depth or length, the cooling of the central portion of the die may be assisted by directing a powerful jet of water through the hole in the die. An ordinary cutting-out bed or die is usually quenched by being plunged into a "bosh" or tank filled with clean water and the die held under the water until it is quite cold, when it may be removed; have its face cleaned or ground bright. It may then be tempered by being placed upon a flat piece of red-hot iron.

Very large dies may be heated for tempering either in a muffle or over a breeze fire. In all cases the slower and more uniformly the change of colour appears the more reliable will be the results from the tools. In tools for turning, planing, and shaping, chipping chisels, drills, and many varieties of press cutting-out punches, where it is not necessary to have the tool hardened for the whole of its length, the hardening (*instead of being carried out by first plunging the whole tool into the water, holding it there until quite cold, then re-heating the whole tool for tempering*) may be readily done at one heating. The following explanation of



hardening and tempering a chipping chisel will serve to illustrate how this is accomplished:—

The chisel, fig. 267, being held by its head H in a pair of tongs, is placed into the fire for about one-third its length A B, and carefully heated to a cherry-red, care being taken that the extreme end E of the chisel does not become overheated. (If the chisel is very thin the end E should be cooled by dipping it into water once or twice during the time that the chisel is being heated.) After it has been heated to the required temperature it is dipped into the water for a portion of its length (according to the size of the chisel this may vary from  $\frac{3}{4}$  in. to  $1\frac{1}{2}$  in.), and held in the water until cold; then remove the chisel, and brighten the hardened portion C by rubbing with a piece of stone or emery cloth. The heat will now travel from the unquenched portion to the quenched portion. The change of colour is watched as it travels along from B to A, until the required colour appears at the cutting end E, when the chisel is again plunged into the water bath; this time the whole of it will be quenched. This method can be applied to any tools to be hardened at their ends only, but it must be understood that the nature of the work to be operated upon may necessitate the tool being brought down in temperature to a totally different colour. For instance, turning tools, dark straw or yellow colour, 450 deg. temperature; cutting-out punches for sheet steel, very dark straw or yellow, 490 deg. temperature; cold chisel for chipping cast iron, dark purple colour, 550 deg. temperature.

It should be noted that when chisels, drills, or turning tools are being forged, it is advisable to hammer them until the steel has become quite cold, as this hammering gives toughness and fineness of texture; it may then be re-heated for the purpose of hardening. Taps and reamers are sometimes covered with a mixture of Castile soap and lampblack, to preserve their cutting edges, and to prevent them being burnt whilst being heated for hardening. This class of tools may also be heated in a wrought-iron pipe filled with charcoal dust, the ends being plugged with clay. This method generally results in the taps or reamers being heated uniformly; they are afterwards dipped into water in a vertical position, and held there until cold.

Circular milling cutters may be covered with Castile soap and lampblack with advantage, and the hole of the cutter plugged up with clay; this preserves the centre, which is not usually required to be hard. The tools are generally slightly warmed before the mixture of Castile soap and lampblack is applied, and a circular cutter should be plunged into the water bath edgewise. The tempering of a tap or reamer is usually done by introducing it into a cast-iron or wrought-iron collar, which has been made red-hot; the tool is held in a pair of tongs, and passed along the centre of the



FIG. 262.

hole. At the same time it assists matters if the tool is rotated whilst being moved along, as the continual change of position prevents one portion becoming hotter than another, and results in a more even temper. Taps, reamers, milling cutters, and similar tools are generally tempered to a light brown colour, and quenched in oil.

Small piercing punches, say from  $\frac{1}{16}$  in. to  $\frac{1}{2}$  in. diameter, and dies from  $\frac{1}{4}$  in. to 1 in. diameter, are best heated in a wrought-iron pipe about 12 in. long and 2 in. diameter, with one end closed. This may be done by welding a wrought-iron plug in one end of the pipe (see fig. 262). The small

punches or dies are placed in the pipe, which is, in turn, thrust into the breeze fire. This method gives much better results than can be obtained when the flame of a fire is allowed to come in contact with such small tools. When the punches or beds, as the case may be, are sufficiently heated the pipe is removed from the fire, and the tools tipped into a bucket of clean water containing a handful of

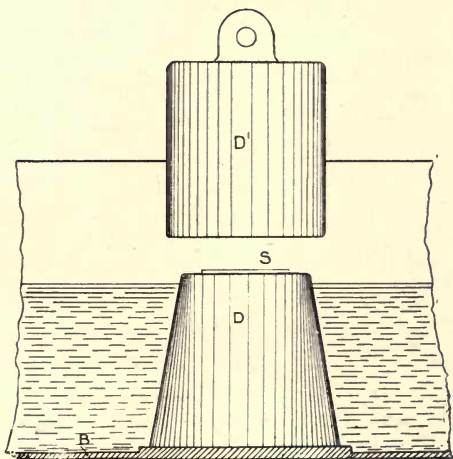

FIG. 263.

common salt. Tools hardened in this manner will be found to be quite clean, and ready for tempering. This may be readily done by placing the tools upon a wrought-iron plate, say 12 in. square by  $\frac{1}{8}$  in. thick, heated over a gas stove; the small round punches would be rolled over the hot plate until the required colour appears, whilst small dies are best placed endways on the plate. In fig. 265 four punches and four dies are shown upon the plate, one of each being placed

near the edge of the plate, as they are nearly ready to be pushed off the hot plate into a bucket of water. In the case

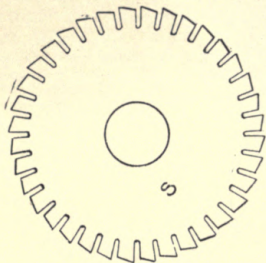

FIG. 264.

of the small die the heat travels up from the bottom, so that when the cutting end or face is a straw colour the back will

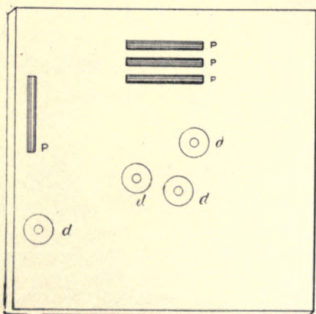

FIG. 265.

probably be blue; but this will be an advantage, as it is only the cutting that is required very hard, whilst the effect of tempering the back of the die will help to preserve it.

Small circular slitting saws for metal work may be hardened in the following manner: Referring to fig. 263, place the cast-iron planishing die D into a bosh of water B, filled to within about  $\frac{1}{2}$  in. of the surface of the die. Arrange a second similar die D<sup>1</sup>, such as to allow of its being raised or lowered by a rope and pulley, in a somewhat similar manner to that by which a stamp hammer is actuated. By this means the top die may be brought down on to the die D. The saw, fig. 264, having been properly in a muffle, is now placed upon the die D, the top die D<sup>1</sup> is quickly lowered until its whole weight is resting upon the saw, the water is then thrown all round the edge of the die faces by the workman. The top die may now be raised and the

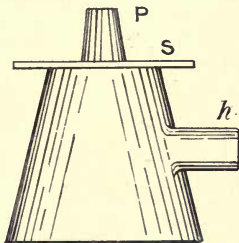

FIG. 266.

tool removed. Saws that are hardened in this manner will be found to have their teeth perfectly hard, whilst being quite flat.

These saws may be tempered by placing them upon a special casting (see fig. 266), heated in a muffle. The saw is placed upon the casting, and it is advisable to occasionally turn it over so that both sides may come in contact with the heated surface. The heat will travel from the centre of the saw to the teeth.

Fig. 266 shows a saw in position ready for tempering, P being a plug cast on and roughly turned to enter the hole

of the saw very loosely; the lug *h* forms a handle by which the casting is moved about by a pair of tongs.

In considering the subject of colour to which a tool should be tempered to give the best results, it should be remembered that different tool-steels may vary considerably. One brand of steel may require to be tempered to a brownish-yellow, whilst another to do the same work may have to be left harder. Another sample of steel may require to be taken much lower in tempering, to prevent the cutting edge of the tool from chipping. Then there is the question as to the metal the tool has to operate upon; this will, to some considerable extent, govern the temper to be given to the tool. It will therefore be seen that it is hardly possible

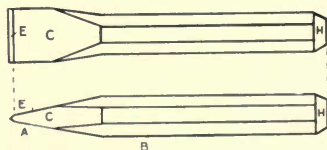

FIG. 267.

to place on record any table that will be found to give reliable results with all steels. The following table, given by Professor R. H. Smith in his work on cutting tools, is very instructive and useful as a guide for tempering. If one has this table before him it is an easy matter to experiment with any particular steel to find out which is the most suitable temper for a certain operation.

#### ANNEALING METAL.

Sheet metals are usually purchased at the proper temper ready to be sheared or cut into blanks, but in drawing tubes or shells the action of the tools rapidly hardens the metal, thereby making it necessary to anneal the metal a number of times according to the number of operations or processes that the metal is passed through to produce the finished article. A cartridge case for a 6 in. quick-firing gun would

be 16 in. long, tapering from 7 in. diameter at the breech end to 6.5 in. diameter at the muzzle end; such a metal shell would be made from a blank  $12\frac{5}{8}$  in. diameter by  $\frac{3}{4}$  in. thick and weighing  $28\frac{1}{2}$  lb. It is formed into the thin case or shell by successive drawings, annealings, pressings, and

## TABLE OF COLOURS FOR TEMPERING.

<i>Faint straw</i> .....	Scrapers for brass. Steel-engraving tools. Light-turning tools. Hammer faces. Planing tools for steel. Planing tools for iron. Paper-cutting knives. Wood-engraving tools. Flat drills. Milling cutters. Wire-drawing plates. Boring cutters.
<i>Brownish yellow</i> .....	Screw-cutting dies. Leather-cutting dies. Taps. Chasers. Rock drills. Punches and dies. Reamers. Shear blades for metal. Gauges. Stone-cutting tools. Plane irons. Twist drills. Wood borers.
<i>Light purple</i> .....	Cold chisels for steel. Axes and adzes. Cold chisels for cast iron. Firmer or mortising chisels. Cold chisels for wrought iron. Circular saws for metal.
<i>Dark blue</i> .....	Screwdrivers. Springs.

squeezings, the weight when finished being  $22\frac{1}{2}$  lb. The number of operations, commencing by cutting out the blank and finishing by lacquering, is 32, including eight annealings and cleanings. As showing the necessity for properly annealing the metal, cartridge cases which have been manufactured by firms of high repute have cracked through their

base spontaneously whilst they have been in the stores. This is supposed to be the result of the effort of the material to recover its normal state, and thus to have caused rupture.\*

The cause of these troubles has generally been traced to an insufficient number of operations in drawing and annealing during the process of manufacture. It is probable that these troubles would not have happened had the cartridge cases been produced by a greater number of stages, thereby bringing about the flow of the metal in a more gradual manner. In works where the ordinary commercial *brass alloys* are mixed and worked, and where the metal has to undergo severe torturing in the processes of rolling, drawing, and hammering, and where the general arrangements and number of annealing muffles are insufficient to deal properly with the amount of work done, the metal strip would be kept in the annealing muffle considerably longer, but at a much lower temperature than would be the case in ordinary annealing, thereby giving the metal what is known as a good soaking. The foregoing remarks, although directly concerning the manufacture of metal ammunition cases, teach a lesson with reference to sheet metal work generally, since it is certain that many of the troubles of cracking and splitting during the process of manufacturing sheet metal articles is due to the metal not having been properly annealed between the various stages of progress, and is further frequently caused by endeavouring to produce a difficult article with a stage or process less than should be given.

#### ANNEALING DIES AND TOOLS.

When dealing with cutting-dies, punches, stamping-dies, or any piece of steel which has to be worked or shaped by the action of cutting tools when in the cold state, previous to the tool being hardened, it is desirable that the steel be carefully annealed. Particularly is this necessary when stamp-dies of some peculiar and difficult shape have to be worked and finished in a first-class manner. When a die

---

\* See remarks by Sir William Anderson, Proceedings, Inst. Mech. Engineers, 1897.



or punch, after having been forged, is thrown down upon the floor of a smith's shop to cool, thereby being exposed to cold air, especially in winter time, it frequently results in the steel being in an unequally hardened condition, which may also be partly caused by the hammering process. Annealing will generally remedy this defect, as the process of annealing reduces the steel to its softest and most uniform condition. The ease with which steel may be worked by the various cutting tools in a lathe, planing, milling, or drilling machines more than repays the little trouble that is necessary for annealing. Small articles—such, for instance, as delicate tools, cutters, reamers, punches, and dies—may be placed in an iron box, surrounded or buried in powdered charcoal; the charcoal prevents the steel from losing its carbon and assists the uniform heating of these small tools, at the same time preserving their shape and preventing any damage being done to their cutting edges. After being heated the box is placed somewhere to gradually get cool before the small tools are removed. The larger tools can be successfully annealed by moderately and uniformly heating them in a muffle, then allowing them to cool slowly. This is sometimes done by burying them in ashes to retard the cooling.

The annealing is usually done before the forgings leave the blacksmith's shop, a good method being to carefully re-heat them after forging to a dull red and place them into an iron box containing slaked lime, where they should remain until cold, which frequently takes a whole day. They are then taken out of the lime, and will be found to be more easily worked into shape, and are not so likely to leave their shape when undergoing the hardening process. There are instances when dies and punches are annealed, roughed-out, and annealed a second time before being finally shaped to their finished outline with beneficial results. But this is not advisable if the tool can be readily worked fairly easy after one annealing, since too much heating may remove the nature from the steel.

## CHAPTER XX.

## BLANK DIMENSIONS.

THE three methods generally used to find the dimensions of a sheet metal blank are the *tentative*, the *gravitative*, and the *mensurative*—probably, as a rule, more time is spent in experimenting to obtain the proper diameter of a blank than it takes to manufacture the tools.

There are many experienced toolmakers who can design and manipulate the tools for producing almost any shaped article in a press that one cares to place before them, yet cannot form any idea *by calculation* as to what size blank is required from which the article is to be produced. These mechanics usually work by the *tentative* method, either giving a rough guess based upon their past experience, and trying over and over again until they have arrived at the proper size or thereabouts, or they look over the patterns of previous work that has been done in the workshop, and select that blank which they think will work out approximately correct.

The gravitative method is often used when a sample of the work to be done is supplied, and this method is particularly useful in the case of stamping or raising sheet metal articles *where no drawing or extending of the metal is to take place*. The sample of work is carefully weighed and its thickness noted, after which a piece of sheet metal measuring one square inch in area and of the same gauge or thickness as the particular sample is also weighed. Then the weight of the sample or finished article, divided by the weight of the one square inch of sheet metal, will give the number of square inches to be contained in the blank for producing an article to sample. For example, suppose the toolmaker is supplied with a sample brass stamping which weighs (*avoirdupois*) 1 lb. 4 oz. 6 drms. = 326 drms., and it is found that the weight of one square inch of sheet metal (*measuring in thickness exactly the same gauge as sample*) is  $1\frac{1}{2}$  drms., then the number of square inches to be contained in the

area of the required blank will be  $\frac{326}{1.5}$  square inch = 217.333

square inches. This will be the exact area of metal contained in the sample, and assuming that the article is not to be clipped after being stamped, then a blank containing the 217.333 square inches would be correct. On the other hand, should it be necessary to clip the article after it has been stamped, as is frequently the case, then a few square inches must necessarily be added to the area of the blank, the amount added being according to the shape, size, and nature of the stamping.

The mensurative method consists in finding the exact area that is contained in the surface of the article to be produced ; the blank is then cut out a certain size, so that it will contain the same area in square inches as the sample. The sample may be an actual finished article, or a sketch may be supplied showing the exact outline and size of the article to be made—in either case it is a question of mensuration.

Anyone having an elementary knowledge of mensuration of surfaces may, by exercising a little care and judgment, obtain fairly reliable results by means of finding the area of an article, and then fixing upon the proper diameter and shape for the required blank. But, even though a tool-maker may be able to deal with the mensuration of curved surfaces, it is not an easy matter to fix upon the diameter of a blank when dealing with articles which have to undergo a large number of processes, such as re-drawings or extensions, as, for instance, would be necessary in producing the brass cases for quick-firing ammunition. This is an instance where the pattern sample shelf often comes in useful to the tool-maker.

It may be truly stated that the usual methods taught by mathematicians for obtaining the areas of curved surfaces of peculiar outline often introduce formula containing the differential and integral calculus. This makes it absolutely impossible for the practical mechanic or toolmaker to follow the reasoning necessary to work out the equations. When, however, such surfaces of unusual outline have to be measured, they may be readily dealt with in comparative

ease (if the article be measured up in sections). The few selected common shaped articles illustrated from fig. 268 to fig. 280, together with their formulæ, will enable the student to follow the application of mensuration to sheet metal processes. The examples have been reduced down to

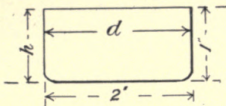

FIG. 268.

ordinary figures, so that the working may be more readily followed by the practical mechanic in the workshop, who may, perhaps, not understand a simple algebraical equation. Some useful notes on mensuration of surfaces will be found in *The Practical Engineer Pocket Book*, besides tables of areas

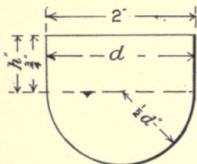

FIG. 269.

and circumferences of circles, squares and square roots, and decimal equivalents of fractional parts of an inch, all of which will greatly assist the workman to follow the examples.

Fig. 268, Cylindrical flat-bottomed vessel :

$$\begin{aligned} \text{Area} &= \pi d h + \frac{d^2 \pi}{4} \\ &= 3.1416 \times 2 \times 1 + \frac{4 \times 3.1416}{4} \\ &= 9.4248 \text{ square inches,} \\ \text{or } \pi (2 + 1) &= 3 \pi = 9.4248 \text{ square inches.} \end{aligned}$$

Then, to obtain the diameter of the required blank, multiply the square root of the area contained in the figure by 1.12838.

Thus the diameter of blank

$$\begin{aligned} &= \sqrt{9.4248} \times 1.12838 \\ &= 3.464 \text{ inches.} \end{aligned}$$

Fig. 269, Cylindrical vessel spherical ended :

$$\begin{aligned} \text{Area} &= \pi d h + \frac{d^2 \pi}{2} \\ &= 3.1416 (2 \times .75) + 6.2832 \\ &= 4.7124 + 6.2832 = 10.9956 \text{ square inches.} \end{aligned}$$

$$\begin{aligned} \text{Diameter of blank} &= \sqrt{10.9956} \times 1.12838 \\ &= 3.7416 \text{ inches.} \end{aligned}$$

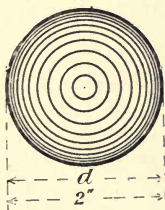

FIG. 270.

Fig. 270, Sphere :

$$\begin{aligned} \text{Area} &= d^2 \pi \\ &= 4 \times 3.1416 = 12.5664 \text{ square inches.} \end{aligned}$$

$$\text{Diameter of blank} = \sqrt{12.5664} \times 1.12838 = 4 \text{ inches.}$$

Fig. 271, Conical vessel :

$$\text{Area} = \pi \frac{D + d}{2} S + \frac{d^2 \pi}{4}$$

when S = the slant height of vessel.

The  $\sqrt{h^2 + \left(\frac{D-d}{2}\right)^2}$  will give the slant height  $S$ .

The full equation will therefore be

$$\begin{aligned} \text{Area} &= \pi \left\{ \frac{D+d}{2} \sqrt{h^2 + \left(\frac{D-d}{2}\right)^2} \right\} + \frac{d^2 \pi}{4} \\ &= 3.1416 \left\{ \frac{4+2}{2} \sqrt{6.25 + 1} \right\} + 3.1416 \\ &= 28.519 \text{ square inches.} \end{aligned}$$

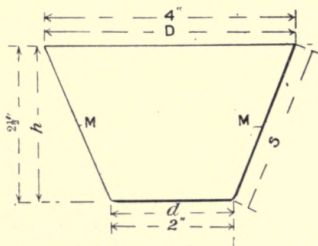

FIG. 271.

$$\begin{aligned} \text{Diameter of blank} &= \sqrt{28.519} \times 1.12838 \\ &= 6.026 \text{ inches.} \end{aligned}$$

The above method is approximately correct.

Another method of dealing with fig. 271 is to carefully set out the figure on paper, when the mean diameter at  $MM$  will be found to be 3 in., and the slant height to be 2.75 in., and the bottom of the vessel  $d$  being 2 in. diameter; then

$$\begin{aligned} \text{Area} &= (3 \times \pi \times 2.75) + \frac{d^2 \pi}{4} \\ &= 25.9182 + 3.1416 = 29.06 \text{ square inches.} \end{aligned}$$

$$\begin{aligned} \text{Diameter of blank} &= \sqrt{29.06} \times 1.12838 \\ &= 6.083 \text{ inches diameter.} \end{aligned}$$

Fig. 272, Elliptical flat-bottomed vessel :

$$\text{Area} = (\text{circumference} \times h) + (\text{area of bottom})$$

$$\text{Area} = \frac{\pi(D + d)h}{2} + \frac{\pi D d}{4}$$

$$= \frac{(3.1416 \times 5.5 \times 1.25)}{2} + \frac{(3.1416 \times 7)}{4}$$

$$= 10.79925 + 5.4978 = 16.297 \text{ square inches.}$$

Then an elliptical blank 3.45 in.  $\times$  6.037 in. will have its diameters in the same ratio as those in the vessel, fig. 272,

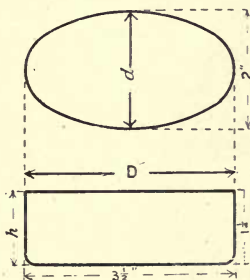

FIG. 272.

and will contain 16.359 square inches, which is slightly larger than area actually required to be in the blank.

Fig. 273, Rectangular vessel :

$$\text{Area} = (x \times y) + 2(x \times h) + 2(y \times h)$$

$$= (3.5 \times 2.5) + 2(3.5 \times 1) + 2(2.5 \times 1)$$

$$= 8.75 + 7 + 5 = 20.75 \text{ square inches.}$$

*Note.*—The length of sides of the rectangular blank must be in the same ratio as the sides of the vessel, fig. 273 ; so that, since the sides of the vessel are 2.5 in. and 3.5 in., the sides of the rectangular blank will be 3.86 to 5.404.

$$\text{Then } 3.86 \text{ in.} \times 5.404 \text{ in.} = 20.859 \text{ square inch.}$$

It will here be noticed that the area of the blank is slightly in excess of that of the example; this size blank will, however, be sufficiently near for all practical purposes.

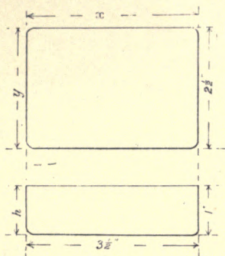

FIG. 273.

Fig. 274, Semi-oblate spheroid: A formula which gives the approximate area of a whole spheroid is as follows:

$$\text{Area} = \pi D \sqrt{\frac{D^2 + d^2}{2}} = 44.430 \text{ square inch.}$$

$$\text{Then } \frac{\text{area}}{2} = \frac{44.430}{2} = 22.215 \text{ square inch.}$$

Therefore 22.215 square inch = area of semi-oblate spheroid.

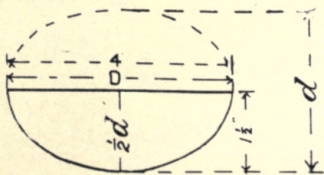

FIG. 274.

Fig. 275, Cylindrical conical-topped vessel:

$$\text{Area} = \left\{ \pi d h + \frac{d^2 \pi}{4} \right\} + \pi \frac{D + d}{2} S.$$



S = slant height, and may be obtained in the same manner as was done in the case of fig. 271.

The full equation for fig. 275 will therefore be

$$\begin{aligned} \text{Area} &= \left\{ \pi d h + \frac{d^2 \pi}{4} \right\} + \pi \left( \frac{D + d}{2} \right) \sqrt{ \left\{ h_1^2 + \left( \frac{D - d}{2} \right)^2 \right\} } \\ &= (9.081) + (5.105 \times \sqrt{.3906}) \\ &= 12.268 \text{ square inches.} \end{aligned}$$

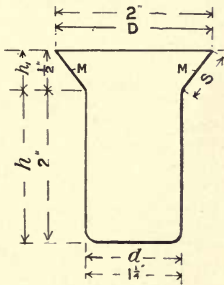

FIG. 275.

The diameter of required blank =  $\sqrt{12.268} \times 1.12838$   
 = 3.952 inches.

*Note.*—The 1.12838 is a constant used to find diameters of blanks for all CYLINDRICAL vessels.

Another method by which the area of fig. 275 may be found is—

$$\text{Area} = \pi d h + (\text{mean dia. of conical top} \times \pi \times S) + \frac{d^2 \pi}{4}$$

when  $\pi d h =$  belt of shell

and  $\frac{d^2 \pi}{4} =$  bottom of shell,

and mean diameter of conical top  $\times \pi \times S =$  area of conical belt.

Set out the conical top on paper, when the mean diameter at M M, fig. 275, will be found equal 1.625 in., and the slant height S equal to .625 in.

The equation will be—

$$\begin{aligned} \text{Area} &= \pi d h + \frac{d^2 \pi}{4} + (1.625 \times 3.1416 \times .625) \\ &= 12.271 \text{ square inch area.} \end{aligned}$$

Fig. 276, Example of cylindrical stamping: The simplest way to measure this is to first lay out the outline of the figure on paper as shown, then treat each section of the

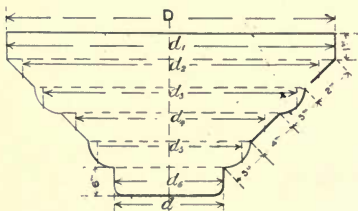

FIG. 276.

figure separately. It will be seen that the figure has been divided into six sections, and numbered 1st, 2nd, 3rd, 4th, 5th, and 6th. These divisions are bisected to obtain their mean diameters (see each section,  $d_1$ ,  $d_2$ ,  $d_3$ ,  $d_4$ ,  $d_5$ , and  $d_6$ ).

The area of each section should be now found by separate working, and all the six areas added finally together. The area of the bottom of the vessel is found, and adding this to the areas of the six sections, previously found, will give the approximate total area of the vessel.

The semi-oblate spheroid may be treated in two sections, as will be seen at figs. 278 and 279. This enables the area to be obtained more accurately than by the formulæ

$$\text{Area} = \pi D \sqrt{\frac{D^2 + d^2}{2}}$$

Fig. 277 shows the method by which the figure can be traced upon paper to enable the figure to be measured up in sections. This is done by an approximate method used for constructing an ellipse by means of arcs of circles. Draw the major and minor arcs, bisecting each other at right angles; draw the rectangle  $O B E C$ ; bisect  $BE$  at  $F$ ; draw  $CF$  and  $ED$  intersecting each other in  $G$ ; bisect  $CG$  by a line at right angles to it; the bisecting line meets the line  $CD$  in  $J$ , the centre from which the arc  $LCG$  is described. Complete

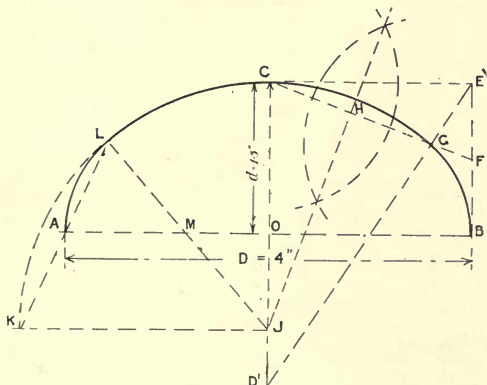

FIG. 277.

the quadrantal arc  $CLK$ , join  $KA$ , and produce to  $L$ , and join  $LJ$ ; the point  $M$  is the centre from which the arc  $LA$  is described; the ellipse can be completed by symmetry.

Fig. 278 shows the one section, which is a slice cut off the top, and it will be seen that the ellipse or figure has been cut through at  $LG$ , thereby forming the spherical segment  $L C G$ .

$$\begin{aligned} \text{Area} &= 2 \pi R h \\ &= 2 \times 3.1416 \times 2.4375 \times .625 \\ &= 9.572 \text{ square inches.} \end{aligned}$$

Fig. 279 gives the remaining section or bottom half of the ellipse, in the form of a band or belt. The area of this band =  $e \times 2\pi a$ . First find  $e$ .

$e$  = length of the curve L A.

$$e = \frac{\text{number of degrees contained by L M A}}{360} \text{ of } 2\pi r$$

$$= \frac{49}{360} \text{ of } 2 \times 3.1416 \times 1.875 = 1.015 \text{ inches.}$$

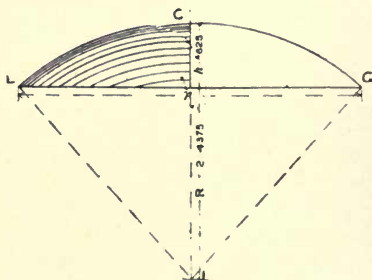

FIG. 278.

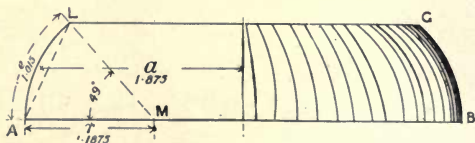

FIG. 279.

Then area of band =  $1.015 \times 6.2832 \times 1.875$   
 = 11.957 square inches.

Therefore the area of semi-oblate spheroid  
 =  $9.572 + 11.957$   
 = 21.529 square inches.

When stamping articles of irregular shape from sheet metals, such, for instance, as fluted cake pans, the work is usually stamped from a piece of sheet metal larger in area than what is actually required to form the finished article, the surplus metal being afterwards clipped off by special clipping tools made to suit the particular shape of the work. Further, as the work varies in shape and depth, so does the number of stamp blows and

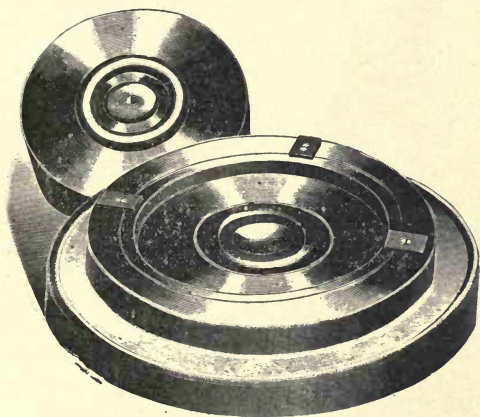

FIG. 280.

required number of annealings vary accordingly. But when raising articles in the power press, it is usual to make the blank the necessary area to simply form the required article. In such cases there will necessarily be provision made upon the top of the bottom die to ensure that an operator shall place the blank perfectly central upon the die, so that when the article is raised the raising shall be done evenly all round the circumference of the finished article. Such a pair of dies for raising are seen at fig. 280, where it will be noticed

that three bits of metal have been screwed down upon the top of the bottom die for the purpose of evenly adjusting the blank, as before explained.

---

## CHAPTER XXI.

### PRESSURES FOR CUTTING BLANKS.

ALTHOUGH shearing and punching may be considered a true cutting action, it is of a rough character. It has been previously explained that at times a punch and die is made flat, at other times concave or convex.

When a punch is being forced through a metal plate, the first effect of the application of the punch is the crushing of the top surface of the plate within the circle of the hole about to be formed. The tendency of the punch is to draw or drag down the metal surrounding the punch. This dragging down of the metal is prevented by the bottom die, which supports the metal surrounding the punch. A certain amount of compression takes place, which varies according to the temper and thickness of the metal that is being operated upon, stresses are set up, and rupture occurs where the stresses have been greatest. When punching thin metals, the action is somewhat different to that of cutting the thicker metals. In the case of thin metal the action may be considered instantaneous, and the top edge of the hole in the scrap metal will appear to be perfectly square, whereas in the case of the thicker metals the shearing action is brought about in a more gradual manner, a series of successive ruptures taking place at various depths in the thickness of the metal plate, until the final shearing occurs. On this account it is difficult to say what actual force or stress is required to cut a given blank, unless experiments are made. But if the ultimate shearing strength of the metal is considered in the calculation, it is possible to arrive at approximate results that will meet all practical requirements. The shearing strength of cold rolled steel may be taken as 60,000 lb. per square inch,

mild steel 50,000 lb., wrought iron 45,000 lb., and soft brass 30,000 lb. To simplify the calculations the above figures may be reduced to tons, so that to shear off wrought-iron bars 1 square inch area a pressure of 20 tons will be required at the punch. In a previous article some figures were given from Dr. Anderson's "Strength of Materials." Another interesting set of figures taken from the same source will be found in the following table, which is a summary of some experiments relating to the shearing of wrought-iron bars.

Size of bar in inches.	Stress with bar laid flat upon its side, in tons per square inch.	Stress with bar laid on edge, in tons per square inch.	Percentage of less stress required when detruded on flat surface.
$3 \times 1\frac{1}{2}$	18.2	20.1	10
$4\frac{1}{2} \times 1\frac{3}{8}$	14.3	17.9	20
$3 \times 1$	15.7	21.1	26
$5\frac{1}{4} \times 1\frac{3}{4}$	16.7	22.6	26
$6 \times 1\frac{1}{2}$	15	18.4	18

These experiments were made with shear blades at an inclination of 1 in 8. It will be noticed in the table that when the bar of iron was cut on the side or flatways the stress required was considerably less than when the iron bar was cut edgewise. This is doubtless due to the circumstance of the work to be done being spread over a longer period, since in the case of placing the bar flatways upon the shear blade it only comes into action with a portion of the bar, due to the inclination of the shearing edge.

To find the approximate pressure required to cut any blank, first measure up the area of metal to be sheared, then multiply by the shearing strength of the particular metal; the result will be the pressure or stress required at the punch or at the ram. It will therefore be understood from the foregoing that the ultimate shearing strength of any metal may be used as a constant in any calculations respecting that particular metal.

Taking cold rolled steel, and the blanks to be cut as cylindrical,

Let  $D$  = diameter of blank in inches,  
 $T$  = thickness of metal in inches,  
 $\pi = 3.1416$ ,  
 $C$  = a constant 26.7 (for steel),  
 $P$  = pressure or stress required ;  
 then  $P = D \times T \times \pi \times C$ .

*Example.*—What stress would be required to punch a blank 6 in. diameter through a steel plate  $\frac{3}{8}$  in. thick ?

Here  $P = 6 \times .375 \times 3.1416 \times 26.7 = 188.7$  tons.

Next suppose a set of shears has to cut off wrought-iron bars.

Let  $W$  = width of bar in inches,  
 $T$  = thickness of bar in inches,  
 $C$  = a constant 20 (for iron),  
 $P$  = pressure or stress required ;  
 then  $P = W \times T \times C$ .

From this it will be seen that in punching a hole (not cylindrical) in a plate the section of metal in square inches to be sheared will be the circumference or length of the curve which forms the outline of the blank, multiplied by the thickness of the plate, the length of curve being obtained by the ordinary rules, according to the shape of the blank. It then remains for this area to be multiplied by the constant  $C$ , which has been explained as that stress required to shear one square inch of metal. It must be clearly understood that these calculations refer to punching or shearing metals when the tools are quite flat—that is, having no dip or shear.

Further, it may be mentioned that when providing or designing a machine to perform punching or shearing of a blank or bar, it will be advisable to allow 6 as the factor of safety. In other words, assuming that the pressure required to punch out a blank has been arrived at by calculation, it will be necessary to provide a machine of such strength that it will require six times that pressure or stress to break any



shafts or wheels that may happen to be used upon that machine. With reference to the example of cutting the cold rolled steel blank, 6 in. diameter by  $\frac{3}{8}$  in. thick, where a stress of 188.7 tons was required at the *ram*, it will be advisable to provide a machine having crank shaft and wheels of such strength that it would be necessary to introduce a resistance at the *ram* or *tools* equal to  $188.7 \times 6$ , or 1,132.2 tons, before any portion of the wheels or shaft would break. The main casting or frame of the machine should necessarily be provided with the same factor of safety.

The punching and shearing machine is an excellent example, demonstrating as it does the great value of the flywheel as a means of storing up energy that may be given out when required to cut a blank. In the case of a machine designed for cutting steel blanks 6 in. diameter by  $\frac{3}{8}$  in. thick, the weight of the flywheel was 15 cwt., its diameter at the edge of the rim being 5 ft. The speed of the counter shaft carrying this flywheel was 116 revolutions per minute. A Bessemer steel crank shaft 6 in. diameter was provided for working the *ram*, the speed of the crank shaft being brought down to 25 revolutions per minute by means of spur gearing.

According to Professor Goodman, it is usual to store energy in the flywheel equal to the work done in two working strokes of the shear or punch, amounting to about 15 inch tons per square inch of metal sheared or punched through.

---

### DEFINITIONS.

THE technical student and practical mechanic will find the following definitions of terms assist him to a better understanding of the problems concerned:—

**The unit** of work is the work done in lifting one pound through a height of one foot, or work done when a resistance of one pound is overcome through a space of one foot, and is called the foot-pound.

**Number** of units of work performed =  $P \times S$  where  $P$  equals the force applied, or the resistance overcome in pounds, and  $S$  equals the space moved over in feet.

**Force** is any action which can be expressed simply by weight, and which can be realised only by an equal amount of reaction, and is the first element in dynamics. All bodies in nature possess the incessant virtue of attracting one another by gravitation, which action is recognised as force.

**Velocity** is speed or rate of motion, and is the second element in dynamics.

**Time** implies a continuous perception recognised as duration, or that measured by a clock, and is the third element in dynamics.

**Power** is the product of force and velocity—that is to say, a force multiplied by the velocity with which it is acting is the power in operation. Power is the differential of work, or any action that produces work, whether mental or physical. Power multiplied by the time of action is work; work divided by time is power.

**Work** is the product obtained by multiplying together the three simple elements—force, velocity, and time.

**Energy** of a body is its capacity for performing work.

**Potential energy**, or the energy stored up, is the product of the effort and the distance through which it is capable of acting.

**Kinetic energy**, or accumulated work of a moving body, is the product of the mass and half the square of its velocity, or the weight of the body multiplied by the height from which it must fall to gain its velocity.

**Gravity** is the mutual tendency which all bodies of nature have to approach each other, or the tendency of any falling body to approach the centre of the earth.

**The mass** of a body is its weight divided by 32·2.

**The acceleration** of motion is the rate of change in the velocity of a moving body, which is increased at different intervals of time.

**The unit** of acceleration is that which imparts unit change of velocity to a moving body in unit time, or an acceleration of one foot per second in one second.

The **acceleration** due to gravity varies at different places on the earth's surface. In this country it is reckoned at 32·2 feet per second, and is generally indicated by the symbol *g*.

**Retarded motion:** The motion of a body, instead of being accelerated, may be *retarded*—that is, its velocity may decrease at different intervals of time.

**Varied motion** is usually understood to refer to a moving body, when the change varies in either accelerated or retarded motion, at different intervals of time.

**Vis-viva** is the energy of a moving body measured by the distance it will pass over before being brought to rest by a resistance of uniform intensity. It is proportional to mass  $\times$  (velocity)<sup>2</sup>.

**Inertia** is that quality inherent in matter whereby it is absolutely passive or indifferent to a state of rest or motion.

A **couple** consists of two parallel forces which are equal, and act in opposite directions.

**Weight** of a body is the pressure which the mutual attraction of the earth and the body causes that body to exert on another with which it is in contact—mass multiplied by 32·2.

**Linear Velocity** is the rate of motion in a straight line, and is measured in feet per second, or per minute, or in miles per hour.

---

#### THE POWER OF PRESSES AND STAMPS.

WHEN considering the power required to perform work in either a press or stamp difficulties arise under the usual working conditions which make it impossible to obtain reliable results by any known formula. One reason for this is that the effect at the face of the hammer, or at the point of the punch, as the case may be, depends so much upon the nature of the resistance, the result being that it renders the ordinary formula unreliable, so far as practical workshop operations are concerned. In a previous article attention has been drawn to the fact that when punching or shearing

metals approximate results, which are governed by the ultimate shearing strength of the metal, may be obtained.

As a rule some ordinary formula would be used to calculate the work stored up in a fly press or stamp hammer, after which a rough estimate of the resistance offered—according to the nature of the material, its thickness, and the time taken to perform the work—would be obtained. In works where a large number of presses or stamps are used it is usual to carry out a series of experiments to find the amount of work that can be done in a certain press, having a screw of known pitch, a fly lever of a certain length, and by placing balls of different weights upon this lever. Again, experiments are frequently carried out to enable some idea to be formed as to the amount of work that can be done by a certain weight of hammer falling through a given height, and in this way approximate data may be obtained which will greatly assist in estimating what size machine would be required to make some specific metal article. By working out a few examples it will be instructive to see how these unknown quantities are continually having to be assumed when dealing with problems connected with the press and stamp; at the same time the working out of these problems will enable one to obtain some approximate results by the principle of work.

#### WORK IN THE COPYING PRESS.

The screw-press, fig. 281, is used extensively for copying letters. It consists of a frame D, bored and screw-cut to form a nut to receive the square-threaded screw S, an iron slab E connected to one end of the screw, and a lever handle A C B fixed to the other end. In operating the press a couple comes into action which rotates the screw. The relation of P to W may be found as follows: Let P equal the push applied at the end A, and also the pull applied at the end B, of the lever handle, and W the resistance overcome—*i.e.*, the pressure that can be put upon any object O—and let  $p$  equal the pitch of the screw thread.

$$\text{Work of W per revolution} = W p$$

$$\text{Motion of P per revolution} = 2 \pi r$$

Then from the principle of work we have in one revolution (the power applied being  $2P$ )—

$$W p = 2 P \times 2 \pi r,$$

or

$$P : W :: p : 4 \pi r.$$

*Example.*—In the screw press, fig. 281, the lever handle is 16 in. long,  $P$  is 20 lb. at each end of the lever, and the pitch of the screw is  $\frac{1}{4}$  in. Find the pressure that can be obtained at the slab  $E$ .

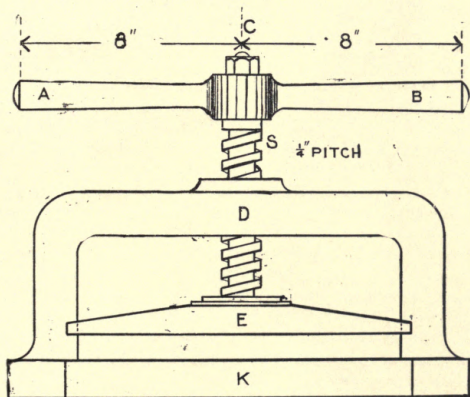

FIG. 281.

The distance travelled by  $2P$  in one revolution =  $2 \times 16 \pi$  inches, and distance moved by  $W = \frac{1}{4}$  in.

Then

$$W = \frac{2 \times 20 \times 16 \pi}{\frac{1}{4}} = 8042.49 \text{ lb. pressure.}$$

From the equation

$$\frac{P}{W} = \frac{p}{4 \pi r}$$

it is evident that any of the unknown terms may be found when the other three terms are given.

The work done by the screw-jack when used for lifting weights may be treated in the same manner as the screw press.

#### WORK OF FLY PRESS.

By reviewing the action of the fly press, it will be interesting to see how the work accumulated in a moving body is applied to overcome the resistance offered when punching holes in metal plates. In this machine, fig. 282, a screw *S* of rapid pitch is attached to the fly lever *F*, which terminates at two massive cast-iron balls *B*, *B*<sup>1</sup>, and on the lever is welded a rod *E* ending in a handle *H*. The operator exerts a certain pull—"quantity unknown"—upon the handle, which transmits motion to the fly lever *F*, and gives considerable velocity—"quantity unknown"—to the two balls, thereby causing work to be accumulated, this energy being available when required to punch the metal *M*. "When calculating the work that can be performed in a fly press, neither the pitch of the screw, the length of the lever, or the pull applied at the handle are considered in the question." The screw is made of rapid pitch for several reasons, the two principal being—First, to enable the operator to raise or lower the punch *P* quickly by a small movement of the handle *H*, thereby allowing the various thicknesses of metal plate, or depth of articles, to be placed between the tools; also enabling the punch *P* to be raised up to the stripper *S*, *F*, without necessitating much movement of the operator. Second, the rapid pitch of screw assists the operator in giving velocity to the balls, and at same time the velocity is maintained. The effect of the descending weights of the balls is, however, disregarded when calculating the power of the fly press.

The work available for overcoming the resistance offered by the metal plate is that which is accumulated in the heavy balls *B*, *B*<sup>1</sup> at the moment of impact. Let the resistance of the plate (which is supposed to be a constant or uniform resistance throughout its whole thickness), be denoted by *R*, let *W* be the combined weight of the two

balls,  $v$  the velocity of the balls at the moment of impact, and let  $y$  feet equal the distance through which the resistance is overcome—*i.e.*,  $y$  feet equal the thickness of metal plate. The accumulated work in the balls

$$= \frac{W v^2}{2 g}$$

also the work of the resistance =  $R y$ , and by the principle of work

$$\frac{W v^2}{2 g} = R y;$$

therefore

$$R = \frac{W v^2}{2 g y}.$$

*Example.*—Two balls, each weighing 30 lb., are placed at the ends of a horizontal fly lever 3 ft. long from centre to centre of the balls. The lever imparts motion to a vertical screw of 2 in. pitch. What resistance will the punch overcome, if the balls have a velocity of 30 ft. per second at the moment of impact, and the punch is brought to rest after traversing a distance of  $\frac{1}{12}$ th of an inch; also what energy is stored up in the balls.

Accumulated work or energy in balls

$$= \frac{W v^2}{2 g} = \frac{30 \times 2 \times 20 \times 20}{2 \times 32 \cdot 2} = 372 \cdot 67 \text{ foot-pounds.}$$

This 372·67 foot-pounds will be absorbed in punching the  $\frac{1}{12}$ th inch plate, or through a space of  $\frac{1}{12} \times \frac{1}{12} = \frac{1}{144}$ th of 1 ft.; therefore

$$\begin{aligned} R &= \frac{30 \times 2 \times 20 \times 20}{2 \times 32 \cdot 2 \times \frac{1}{144}} \\ &= \frac{60 \times 400 \times 144}{64 \cdot 4 \times 1} = 53664 \cdot 59 \text{ lb.} \end{aligned}$$

$\therefore$  53664·59 lb. is the mean resistance to the punch, when brought to rest in a space of  $\frac{1}{12}$ th of an inch.

#### FLY PRESS COMPARED WITH COPYING PRESS.

Now let us see why the massive cast-iron balls are used upon the fly lever of a screw press. In the case of the copying press a certain pressure is applied to the letter

book—so long as the hands are exerting the pull and the push—by working with a comparatively fine-pitch screw and a lever worked by both hands, and, where this lever has to be moved through the circumference of the circle described by P, several revolutions before the actual pressure is applied to the letter book; whereas the fly press has to be worked under entirely different conditions. The screw must necessarily be of rapid pitch, so that by the slight movement of the fly-lever handle, which is grasped by the operator's one hand, the punch may be quickly raised or lowered, leaving the operator's left-hand free to feed the metal articles on to the tools.

Suppose, for example, that the fly press, fig. 282, has a lever handle H, upon which the operator exerts a pull of 50 lb., the radius of circle described by the handle H is 15 in., and the pitch of the screw is 2 in. Find the pressure applied at the punch P.

Here the pressure

$$= \frac{50 \times 2 \pi r}{2} = 2356.2 \text{ lb.}$$

In cutting-out or punching blanks, raising, drawing, and similar work in the fly press, the distance  $y$  feet through which the resistance is offered varies considerably, and the nature of this resistance is such that a continual pressure is required at the punch during the whole time that the work is being performed. The pressure of 2356.2 lb. which has been found by calculation, though useful for copying letters, would be absolutely useless in the fly press for punching holes through metal plate—unless the work was indeed very light. Further, an operator could not exert a pull of 50 lb. at the lever handle H for very long, without becoming thoroughly exhausted, thereby losing all his available energy, probably over cutting one thin blank.

Suppose the fly press is punching holes 1 in. diameter through a steel plate  $\frac{1}{8}$  in. thickness. By the shearing and punching formula we have

$$\begin{aligned} P &= D \times T \times \pi \times C ; \\ \therefore P &= 1 \times .125 \times 3.1416 \times 26.7 \\ &= 10.485 \text{ tons} = 23486.4 \text{ lb.} \end{aligned}$$



Here is therefore a resistance of 23486.4 lb. offered by the steel plate whilst the 1 in. hole is being punched, and the screw-press calculation only resulted in a pressure of 2356.2 lb. Now, placing two balls upon the fly lever, each ball weighing 30 lb., considerably alters the conditions. The operator pushes the fly handle as far back as possible; then, when he comes to pull the handle H, the velocity attained by his

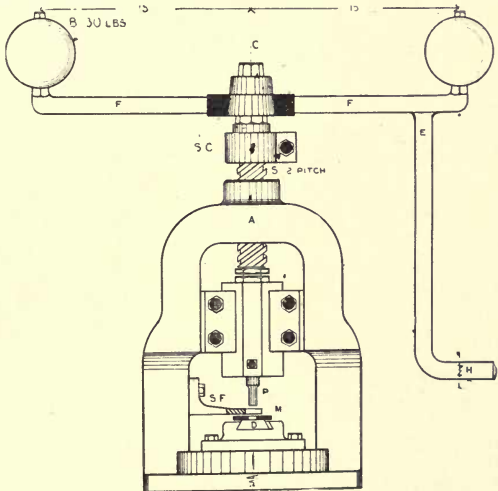

FIG. 282.

hand is very great, and at the moment or instant of impact the operator throws the upper portion of his body back by a quick movement, thereby considerably increasing the velocity of the balls. The screw and the lever have greatly assisted him to attain the high velocity, but the energy given out by him has been accumulated in the balls, which in the previous

example works out at 53664.59 lb. at the punch, when the velocity was assumed to be 20 ft. per second.

By adding to the fly press the two cast-iron balls, the accumulated work is 372.67 foot-pounds, which enables the fly press to overcome a resistance of 53664.59 lb. at the punch.

The fact of adding the balls has made available over double the energy that is actually required to deal with the work the machine has in hand.

#### WORK DONE BY STAMP HAMMER.

The great value of the stamp was mentioned in a previous article, and attention was drawn to its simplicity and cheapness as a means of storing energy, which could be given out again in doing the work of raising, stamping, and forging.

The stamp hammer is an example of the useful application of the principle of the falling weight. In finding the work accumulated in any moving body, such, for instance, as energy stored up in a flywheel, the work of a railway engine when ascending an incline, the work of a cannon ball, and similar questions, it is necessary to introduce the force of gravity into the calculation, since the law of gravitation necessarily has an effect upon such bodies as are dealt with in these calculations. It is therefore perhaps necessary to briefly review the action of gravity on falling bodies to enable the practical mechanic to understand what  $g$  means.

If a body be raised  $16\frac{1}{2}$  ft., then allowed to fall freely, it will fall through this space of  $16\frac{1}{2}$  ft. in one second, and at the end of that second it will have attained a velocity of  $32\frac{1}{2}$  ft. per second. This velocity of  $32\frac{1}{2}$  ft. per second, which is simply due to the force of gravity, is denoted by  $g$ , and the velocity  $v$  attained at the end of  $t$  seconds will be  $t \times 32\frac{1}{2}$ , or  $v = t \times 32\frac{1}{2}$ . Therefore the velocity of a body which has fallen for four seconds will be at the end of that time travelling at a velocity =  $4 \times 32\frac{1}{2} = 128\frac{2}{3}$  ft. per second.

The mean velocity—that is, the velocity in the middle of that time—will be  $2 \times 32\frac{1}{2} = 64\frac{1}{3}$  ft. per second, and the space described will be  $4^2 \times 16\frac{1}{2} = 257\frac{1}{3}$  ft.

## FORMULA FOR FALLING BODIES WHEN FALLING FROM REST.

 $h$  = height of fall in feet. $v$  = velocity in feet per second. $g$  = force of gravity = 32.2. $t$  = time of fall in seconds.

$$h = \frac{g t^2}{2} = \frac{1}{2} g t^2 = \frac{v^2}{2g}$$

$$v = g t = \frac{2h}{t} = \sqrt{2gh}$$

$$t = \frac{v}{g} = \frac{2h}{v} = \sqrt{\frac{2h}{g}}$$

If the stamp hammer be raised to a definite height, the work expended in raising it will be  $W \times h$ , and in doing so the force of gravity will have to be overcome. If the hammer be now supported, there will be "potential energy" stored up in it, and when allowed to fall it will attain a certain velocity depending upon the distance fallen. When the hammer reaches the end of its fall, the accumulated work in the hammer will be

$$\frac{W v^2}{2g}$$

and

$$\frac{W v^2}{2g} = W h$$

*Example.*—Suppose a stamp hammer of 500 lb. weight be raised through a height of 579 ft. The work expended in raising this hammer will be

$$W \times h = 500 \times 579 = 289500 \text{ foot-pounds.}$$

If the hammer be now supported at this height, the potential energy which exists in, or is stored up, will be = 289,500 foot-pounds. When allowed to fall the accumulated work will be

$$= \frac{W v^2}{2g}$$

First find  $v$ :

$$v = \sqrt{2gh} = \sqrt{2 \times 32\frac{1}{8} \times 579} = 193 \text{ ft. per second ;}$$

∴ when the hammer reaches the end of its fall it will have attained a velocity = 193 ft. per second ;

$$\therefore \frac{W v^2}{2g} = \frac{500 \times 193 \times 193}{2 \times 32\frac{1}{8}} = 289500 \text{ foot-pounds,}$$

and this is the same result as  $W \times h$ .

A certain amount of energy is passed into the stamp hammer in raising it up, and when it falls the energy is given out again. There is neither gain nor loss of power. It may be that a great pressure is exerted through a small space, or a less pressure exerted through a greater space, and in both instances the work may be the same.

If a resistance is offered to a 560 lb. hammer, falling from a height of 16 ft., during the last one foot of its fall the average pressure acting against the resistance will be 8,960 lb., the pressure being much greater at the commencement, and reducing as it reaches the last inch ; *i.e.* (this reasoning applies to the last 12 in. of a fall of 16 ft.), the accumulated energy gradually decreasing to simply that of the weight of the hammer itself as it reaches the end.

But should the hammer be brought to rest in a fraction of 1 ft., then the resistance offered must be proportionally greater.

A stamp hammer 200 lb. weight falls 10 ft., and in stamping a piece of metal the hammer is brought to rest in the space of the last  $\frac{1}{2}$  in. in its fall. What resistance has been offered by the metal article ?

$$W \times h = 200 \times 10 = 2000 \text{ foot-pounds,}$$

$$\frac{1}{2} \text{ in.} = \frac{1}{2} \text{ of } \frac{1}{12} = \frac{1}{24} \text{ of 1 ft.,}$$

and since

$$2000 = \frac{R \times 1}{24},$$

$$\therefore R = \frac{2000 \times 24}{1} = 48000 \text{ lb.}$$

Notwithstanding the fact that the work of a stamp hammer may be calculated without considering gravity, we will now consider the case of another kind of hammer,

which is assisted by the workman's arm—the hand hammer. The conditions under which the hand hammer is used make it necessary that the law of gravitation shall be introduced into the calculation. Take the case of a fitter striking a blow upon the head of a chisel, or driving a nail into a piece of wood, with a 2 lb. hand hammer.

As another example, consider the case of a fitter driving a key into the boss of a flywheel with a 4 lb. jack hammer. In the first case there are two forces acting upon the hammer, namely, force of gravity and the man's muscular force. The workman raises the hammer; he then drives it home, delivering a blow upon the head of the chisel. The first portion of the distance through which the hammer moves is traversed by a movement of the whole arm from the shoulder.

This is followed up by the workman straightening his arm at the elbow; then, just as he is about to reach the head of the chisel with the hammer to strike the blow, he straightens his wrist, thereby adding impetus to the hammer, which is already rapidly falling, and in this manner a very great velocity is given; probably at the exact moment of impact the actual velocity may be 50 ft. per second.

In the second example, where a blow is delivered upon the head of a steel key by a jack hammer, and the hammer is driven in a horizontal line, the fitter will swing the hammer through a comparatively long distance, and will probably put the weight of the upper half of his body into the blow, thereby considerably increasing the velocity of the hammer, which may be 50 ft. per second, as before. In both these cases of hand hammers the accumulated work or energy stored up in the hammer will be the same as though the hammer had fallen from a sufficient height to attain that velocity which the hammer has at the moment of impact. But here the only information we have to assist us in solving the problem is the weight of the hammer and the assumed velocity at which it is moving, say 50 ft. per second. Since having no particulars as to the height from which a body must fall to attain this velocity, it is necessary to introduce the law of gravitation into the calculation to enable reliable results to be obtained.

Here we have for the 2 lb. hammer accumulated work

$$= \frac{W v^2}{2 g} = \frac{2 \times 50 \times 50}{2 \times 32} = 78 \text{ foot-pounds.}$$

If the face of the hammer moves the head of the chisel  $\frac{1}{16}$  in., then

$$\frac{1}{16} \times \frac{1}{12} = \frac{1}{192} \text{ of 1 ft. ;}$$

$$\therefore R = \frac{78 \times 192}{1} = 14976 \text{ lb.}$$

If a nail had been driven  $\frac{1}{4}$  in.,

$$\frac{1}{4} \times \frac{1}{12} = \frac{1}{48} \text{ of 1 ft. ;}$$

$$\therefore R = \frac{78 \times 48}{1} = 3744 \text{ lb.}$$

In the case of the 4 lb. jack hammer we have accumulated work

$$\begin{aligned} &= \frac{W v^2}{2 g} \\ &= \frac{4 \times 50 \times 50}{2 \times 32} = 156 \text{ foot-pounds.} \end{aligned}$$

If the key is driven  $\frac{1}{8}$  in. by the blow,

$$\frac{1}{8} \times \frac{1}{12} = \frac{1}{96} \text{ of 1 ft. ;}$$

$$\therefore R = \frac{156 \times 96}{1} = 14976 \text{ lb. resistance.}$$

The work done by the jack hammer, namely, 14,976 lb., is approximately the same that would be obtained by a dead load of 14,976 lb. giving a direct pressure.

# INDEX.

## A

	PAGE
Accidents to Operators' Fingers .....	193
Accidents to Stamp Operators.....	208
Acting, Single, Press, Chief Defects in .....	159
Action, Double, Press Construction .....	143
Action of Punching and Shearing .....	71
Accumulated Energy Stored in Hammer.....	301
Accuracy and Durability .....	80
Accurate Methods of Drilling by Jig .....	243
Accurate Boring Jig, Preparation of .....	249
Accurately Boring Tools and Jigs .....	241
Adjusting Ram by Means of Plates .....	42
Adjusting the Pressure Plate .....	165
Adjusting Double Crank Press .....	197
Adjustment, Worm, for Ram .....	197
Advantage of Balanced Slides .....	167
Advantages of the Double Stamp .....	206
Advantages of Roller-feed Motion .....	183
Alloy Suitable for Cartridge Cases .....	3
Angle of Dip on Shears .....	64
Angle on Punch for Cutting.....	65
Annealing Dies in Slaked Lime .....	273
Annealing Sheet Metals .....	271
Application of Roller-feed Motions .....	191
Armature Disc-notching Machine .....	201
Attaching Punches, Methods of .....	69
Attaching Punches in Double-action Press.....	145
Automatic Drop Hammer .....	209
Automatic Drop Hammer, Details of .....	211
Automatic Knockout or Flipper .....	97
Automatic Umbrella Stretcher Machine .....	103
Automatics and Machine Tools .....	215

## B

Back, Open, Single-acting Press.....	161
Balanced Slides, Advantage of.....	167
Bed, Cutting-out being Profiled .....	231
Bed Cutting, Guide Plate Fixed to a .....	261
Bed, Punch and Stripper, Correct Setting .....	257
Bed, The Stop Peg on a Cutting .....	259
Bending Tools for Wire .....	121
Bending Tools for Metal, Form of .....	123
Best Dipping Metal .....	8
Blank Dimensions .....	274
Blank Feeding by Vertical Hopper.....	203
Blank Cutting by the Shearing Method .....	181

	PAGE
Blank Cutting Tools, Set of .....	98
Blanking, Successive Piercing and .....	137
Blanks, Pressure Required to Cut .....	287
Blanks, Shearing Circular .....	179
Block, Stamp, Weight of .....	205
Bolster, Methods of Fixing .....	75
Bolt, Stay, The Use of a, on a Press .....	153
Boring a Stamp Die on Lathe .....	219
Boring Jig, Preparation of an Accurate .....	249
Boring Tools and Jigs Accurately .....	241
Brown and Sharp Micrometer .....	7

## C

Careless Hardening .....	57
Careless Tool Setting, Trouble Caused by .....	253
Cast-iron Driving Clutch .....	44
Cartridge Shell, Formation of .....	135
Changing Tools in Double-ended Press .....	169
Chief Defects in Single-acting Press .....	159
Chuck, Special Form of Drill .....	101
Chuck, Special Form of Work .....	115
Circular Blank Shearing .....	179
Clipping of Stamped Articles .....	285
Combination Tools .....	141
Common Sheet Brass .....	3
Common Stripper Arrangements and Waste Work .....	255
Compared, Parallel and Screwed Shank .....	73
Complete Set of Piercing Tools .....	98
Complete Set of Blanking Tools .....	98
Concerning the Dial-feed Plate .....	189
Construction of Cropping Die .....	105
Construction of Dial-feed Motion .....	185
Construction of Double-action Press .....	143
Construction, Important Points in Press .....	151
Copying Press, Work Done in a .....	292
Correct Setting of Punch, Bed, and Stripper .....	257
Correct Tool Setting, Necessity of .....	251
Correcting the Die .....	83
Coupling Two Crank Shafts .....	52
Crank, Double, Press .....	197
Cropping-die Construction .....	105
Cutting Angle on Punch .....	65
Cutting Bed, Guide Plate Fixed to .....	261
Cutting Bed, The Stop Peg on a .....	259
Cutting Blanks by the Shearing Method .....	181
Cutting Screw on Punch Shank .....	291
Cutting-out Bed being Profiled .....	231
Cup, Spinning a Sheet Steel .....	113
Cylindrical Die, Methods of Fixing .....	77

## D

Dangers of Sliding-key Stop Motion .....	175
Defects, Chief, in Single-acting Press .....	159
Details of Metal Shearing Machines .....	177
Descent of Ram, Unexpected .....	195
Details of Dial-feed Motion .....	187
Details of Power Press .....	41
Details of Screw Press .....	24
Dial Plate, Important Points Concerning .....	189
Dial-feed Motion, Construction of .....	185



	PAGE
Dial-feed Motion, Details of .....	187
Die and Punch, Interchangeability of .....	79
Die, Boring on Lathe for Stamp .....	219
Die, Correcting the .....	83
Die, Cropping, Construction of .....	105
Die, Cylindrical, Methods of Fixing .....	77
Die Making by Drift .....	87
Die, Method of Drilling a Cutting .....	227
Die Preparing for Drifting .....	91
Die, Preparing a Standard .....	81
Die with Wrought-iron Base .....	56
Dies and Punches, Hardening and Tempering .....	267
Dies and Punches, Standard .....	80
Dies, Annealing, in Slaked Lime .....	273
Dimensions of Blanks .....	274
Dimensions of Tools for Re-drawing .....	131
Dip on Shears .....	64
Direction of Shaft Rotation .....	49
Disc-notching Machine for Armatures .....	201
Dividing Head Stocks, Quadrant .....	235
Double-action Press, Attaching Punches in .....	145
Double-action Press, Construction of .....	143
Double-crank Press, Adjusting .....	197
Drawing a Metal Sphere .....	133
Drawing and Re-drawing .....	127
Drawing Press, Toggle .....	199
Drawing Punch End, Radius on .....	129
Drawing Punch, Removing Small Shell from .....	147
Drift, Formation of the .....	89
Drifting, Preparing the Die for .....	91
Drilling a Cutting Die, Method of .....	227
Drilling by Jig, Accurate Methods of .....	243
Drill Chuck, Special Form of .....	101
Drilling Machine for General Purpose .....	225
Driving Countershaft by Pin Clutch .....	44
Drop Hammer, Automatic .....	209
Drop Hammer, Automatic, Details of .....	211
Durability and Accuracy .....	80

## E

End Radius on Drawing Punch .....	129
Energy Accumulated and Stored in Hammer .....	301
Example of Double-sided Fly Press .....	23
Example of Power Press .....	38
Examples of Cylindrical and Rectangular Dies .....	55
Examples of Spinning Operations ..	107
Extracting Mechanism Actuated by Ram .....	117
Extracting Mechanism, Setting the .....	119

## F

Face Plate, Setting Work on a Lathe .....	245
Factor of Safety for Shearing Machine .....	289
Faults Due to Pitch of Screw .....	36
Faults in Construction .....	46
Faults of Cast-iron Driving Clutch .....	45
Faulty Method of Driving the Ram .....	48
Feed Motion, Advantages of Roller .....	183
Feed Motion, Construction of Dial .....	185
Feed Motion, Details of Dial .....	187
Feed Motions, Application of Roller .....	191
Feeding Blanks by Vertical Hopper .....	203

	PAGE
Fingers, Accidents to Operators' .....	198
Fixing Blank Dimensions .....	275
Fixing Bolster, Methods of .....	75
Fixing Cylindrical Die, Methods of .....	77
Fixing Punch, Methods of .....	69
Fly Press Compared with Copying Press .....	297
"Force" or Top Stamp Die .....	59
Forces Acting on Ram .....	51
Forging a Stamp Die .....	54
Formation of Cartridge Shell .....	135
Formation of Gartering Nut .....	27
Formation of the Drift .....	89
Formation of Tools for Bending Wire .....	121
Formation of Tools for Bending Metal .....	123
Four Rams Operated Simultaneously .....	45
Frame Casting Screw Cut .....	31
Frame Casting Bored for Separate Nut .....	31
Friction, Stamp Raised by .....	213

## G

Gartering the Ram .....	28
Gear for Belt Driving .....	40
Graduations on Micrometer Thimble .....	8
Guide and Stripper Plates .....	95
Guide Plate Fixed to Cutting Bed .....	261

## H

Hammer, Accumulated Energy Stored in .....	301
Hammer, Automatic Drop .....	209
Hammer, Automatic Drop, Details .....	211
Hammer, Stamp Raised by Friction .....	213
Hammer Stamp, Weight of, and Block .....	205
Hammer Stamp, Work Done by .....	299
Hardening and Tempering a Slitting Saw .....	269
Hardening and Tempering Dies and Punches .....	267
Hardening and Tempering at one Heat .....	265
Hardening, Careless .....	57
Head, Spinning a Rivet .....	111
Headstocks, Quadrant Dividing .....	235
Heating Steel Uniformly for Hardening .....	263
Hopper, Vertical, for Feeding Blanks .....	208

## I

Imperial Standard Wire Gauge .....	14
Important Points in Press Construction .....	151
Important Points Concerning Dial-feed Plate .....	189
Indicators, Methods of Applying Test .....	239
Indicators, Types of Test .....	237
Interchangeable Machine Parts .....	246
Interchangeable Tools .....	87
Interchangeability of Die and Punch .....	79
Internal and External Gauges .....	16
Iron Bars, Pressures Required to Cut .....	287

## J

Jig, Accurate Methods of Drilling by .....	243
Jig Boring, Preparation of an Accurate .....	249
Jigs and Tools for Repetition Work .....	236
Jigs and Tools, Accurately Boring .....	241

## K

PAGE

Key for Gartering Bolt .....	29
Key-sliding, Dangers of, Stop Motion .....	175
Knockout or Automatic Flipper .....	97

## L

Lathe Face-plate, Setting Work upon a .....	245
Lathe for Boring a Stamp Die .....	219
Lathe Test Indicators .....	237
Lathe-spinning .....	110
Lift, Positive, or Pressure Plate .....	163
Limit of Thickness that may be Punched .....	63
Limits of Accuracy .....	18

## M

Machine, Drilling, for General Purpose .....	225
Machine for Notching Armature Discs .....	201
Machine for Shearing Circular Blanks .....	179
Machine Parts, Interchangeable .....	246
Machine, Profiling, the Use of .....	229
Machine, Shearing, Factor of Safety .....	289
Machine, the Use of Shaping .....	223
Machine Tools and Automatics .....	215
Machine, Umbrella Stretcher .....	103
Machine, Vice, a Special .....	233
Machines used for Tool Making .....	217
Measuring an Article in Sections .....	283
Mechanism-extracting Actuated by Ram .....	117
Mechanism-extracting, Setting the .....	119
Mensuration of Sheet-metal Surfaces .....	277
Metal Bending Tools .....	123
Metal Gauge Tables .....	4
Metal Shearing Machine, Details of .....	177
Metal Sphere, Drawing a .....	133
Metal Spinning .....	106
Metal Work Defined .....	19
Method of Cutting Blanks by Shearing .....	181
Method of Drilling a Cutting Die .....	227
Method of Strengthening Press Frame .....	89
Methods of Applying Test Indicators .....	232
Methods of Attaching Force to Stamp Hammer .....	58
Methods of Drilling Accurately by Jig .....	243
Methods of Fixing Blank Dimensions .....	274
Methods of Fixing Bolster .....	75
Methods of Fixing Cylindrical Die .....	77
Methods of Fixing Punch .....	69
Micrometer Reading .....	8
Micrometer Rolling Mill Gauge .....	12
Motion, Advantages of Roller-feed .....	183
Motion, Application of Roller-feed .....	191
Motion, Construction of Dial-feed .....	185
Motion, Details of Dial-feed .....	187
Motion, Stop, Arranged in Ram .....	171
Motion, Stop, Dangers of Sliding-key .....	175
Motion, Stop, Proper Place to Apply the .....	173
Multiple-threaded Screws .....	37

## N

Necessity of Correct Tool Setting .....	251
Notching Armature Discs .....	201

	PAGE
Old Birmingham Wire Gauge .....	6
One Heat Hardening and Tempering .....	265
Open-backed Press, Single-acting .....	161
Operations Defined by Terms .....	21
Operations of Metal Spinning .....	107
Operators, Accidents to Stamp .....	208
Operators' Fingers, Accidents to .....	193
Ordinary Stamp .....	204
Ornamental Work in Spinning .....	109

## P

Parallel and Screwed Shank Compared .....	73
Peg Stop, on Cutting Bed .....	259
Per Cent of Carbon in Tool Steel .....	58
Piercing and Blanking, Successive .....	137
Piercing, Complete Set of Tools for .....	93
Pitch of Press Screw .....	37
Plate Face, Setting Work upon a Lathe .....	245
Plate, Gauges for Sheet Metal .....	15
Plate Guide Fixed to Cutting Bed .....	261
Plate, Points Concerning the Dial-feed .....	189
Plates, Guide and Stripper .....	95
Points, Important, in Press Construction .....	151
Points, Important, Concerning Dial Feed Plate .....	189
Position of Stresses in Press Frame .....	32
Power Press, Selection of Suitable .....	149
Power Press, Single Acting .....	159
Power of Presses and Stamps .....	295
Preparation of an Accurate Boring Jig .....	241
Preparing a Standard Die .....	81
Preparing the Die for Drifting .....	91
Preparing the Punch .....	85
Press and Stamps, The Power of .....	291
Press, Chief Defects in Single-acting .....	159
Press Construction, Important Points .....	151
Press, Construction of Double Action .....	143
Press, Double Crank .....	197
Press, Double-ended, Tool Changing in .....	169
Press Fitted with Dial-feed Motion .....	184
Press Fitted with Toggle Gear .....	199
Press Fitted with Roller-feed Motion .....	182, 189, and 192
Press Fitted with Worm Adjustment .....	197
Press, Geared, Single-sided .....	157
Press Power, Selection of Suitable .....	149
Press, Power, Single-acting .....	155
Press, Single-acting Open-back .....	161
Press, The Use of a Stay Bolt on .....	153
Press Tools for Bending Metal .....	123
Press Tools for Cutting Wire .....	125
Press Tool Setting .....	251
Press, Work Done in a Copying .....	292
Presses for Special Work .....	149
Pressure Plate with Positive Lift .....	163
Pressure Plate, Adjusting the .....	165
Pressure Required to Cut Blanks .....	286
Profiling a Cutting-out Bed .....	231
Profiling Machine, The Use of .....	229
Proper Place to Apply the Stop Motion .....	173
Punch and Die, Interchangeability of .....	79
Punches and Dies, Hardening and Tempering .....	267
Punch, Bed, and Stripper, Correct Setting of .....	257

	PAGE
Punch Built up in Sections .....	67
Punch, Cutting Angle on .....	65
Punch End, Radius on Drawing.....	129
Punch, Methods of Fixing .....	69
Punch Shank being Screw-cut.....	221
Puncher and Dies, Standard.....	80
Punches, Attaching, in Double-action Press .....	145
Punching and Shearing .....	61
Punching and Shearing, Action of.....	71

## Q

Quadrant Dividing Headstocks .....	235
------------------------------------	-----

## R

Radius on Drawing Punch End .....	129
Ram, Actuating, Extracting Mechanism.....	117
Ram Adjusting by Plates .....	42
Ram Adjustment by Worm .....	197
Ram, Forces Acting on .....	51
Ram, Methods of Driving .....	41
Ram, Stop Motion Arranged in .....	171
Ram, Unexpected Descent of .....	195
Reading the Micrometer .....	8
Re-drawing and Drawing .....	127
Re-drawing, Tool Dimensions for .....	181
Relative Position of Cranks .....	51
Removing Small Shell from Drawing Punch .....	147
Rivet Head Spinning .....	111
Roller-feed Motion, Advantages of .....	183
Roller-feed Motions, Application of .....	191

## S

Saw, Hardening and Tempering a Slitting.....	269
Screw-cutting a Punch Shank.....	221
Screw Press, The Work of a .....	295
Screwed and Parallel Shank Compared .....	73
Sections, Punch Built up in.....	67
Selecting Special Automatics .....	215
Selection of Suitable Power Press .....	149
Set, Complete, of Piercing Tools.....	98
Setting Correctly the Punch, Bed, and Stripper .....	257
Setting Extracting Mechanism .....	119
Setting, Necessity of Correct Tool .....	231
Setting, Tool, Troubles Caused by Careless.....	258
Setting Work on a Lathe Face Plate .....	245
Shank, Parallel and Screwed Compared .....	73
Shaping Machine, The Use of .....	223
Shearing and Punching.....	61
Shearing and Punching Action of.....	71
Shearing Machine for Circular Blanks .....	179
Shearing Machine Details.....	177
Shearing Machine, Factor of Safety for .....	289
Shearing Method of Cutting Blanks .....	181
Shearing, Pressure Required for Iron Bars .....	287
Sheet Metals, Annealing.....	271
Shell Cartridge, Formation of .....	185
Shell, Small, Removing from Drawing Punch .....	147
Single-acting Power Press .....	155
Single-acting Press, Chief Defects in .....	159

	PAGE
Single-sided Geared Press .....	157
Slides, Balanced, Advantage of .....	167
Sliding-key Stop Motion, Dangers of.....	175
Slitting Saw, Hardening and Tempering a.....	169
Special Automatics, Selecting .....	215
Special Form of Drill Chuck .....	101
Special Form of Work Chuck .....	115
Special Machine Vice .....	233
Special Work, Presses for .....	149
Sphere, Metal, Drawing a .....	133
Spinning a Rivet Head .....	111
Spinning a Sheet Steel Cup .....	113
Spinning Lathe.....	110
Spinning Operations, Examples of.....	107
Spinning Ornamental Work.....	109
Stamp Block and Hammer, Weight of .....	205
Stamp Die Boring on Lathe .....	219
Stamp Die Forging .....	54
Stamp, Double-type, Advantages of .....	206
Stamp "Force" or Top Die .....	59
Stamp Hammer Raised by Friction .....	218
Stamp Hammer, Work done by .....	299
Stamp Operators, Accidents to.....	208
Stamp, Ordinary Type of .....	204
Stamping .....	204
Stamping a Steel Washer .....	139
Stamps, The Power of .....	291
Standard Cylindrical Gauges .....	18
Standard Dies and Punches .....	80
Stay Rod for Strengthening Press .....	31
Steel, Heating, Uniformly for Hardening .....	263
Steel Washer, Stamping a .....	139
Strengthening Press Frame .....	33
Stretcher, Automatic Umbrella Machine.....	103
Stripper and Guide Plates.....	95
Stripper, Common, Arrangements and Waste Work .....	255
Stop Motion Arranged in Ram.....	171
Stop Motion, Dangers of Sliding-key.....	175
Stop Peg Fixed on a Cutting Bed .....	259
Successive Piercing and Blanking .....	137
Surfaces, Mensuration of Metal .....	277

## T

Tempering and Hardening Dies and Punches .....	267
Tempering and Hardening at One Heat .....	265
Tempering and Hardening a Slitting Saw .....	269
Test Indicators, Methods of Applying .....	239
Test Indicators, Types of Lathe .....	287
The Bumping Bit .....	27
Threads and Spaces Compared.....	34
Theoretical Limit for Punching .....	63
Toggle Drawing Press.....	199
Tool Setting, Necessity of Correct .....	251
Tool Setting, Troubles Caused by Careless .....	253
Tools, Annealing, in Slaked Lime .....	273
Tools and Jigs, Accurately Boring .....	241
Tools and Jigs for Repetition Work .....	236
Tools for Bending Wire .....	121
Tools for Bending Metal.....	123
Tools, Combination .....	141
Tools, Complete Set of Piercing .....	93
Tools, Complete Set of Blank-cutting .....	98

	PAGE
Tools, Changing, in Double-ended Press .....	169
Tools, Dimensions for Re-drawing .....	131
Tools, Interchangeable .....	87
Tools, Machine, and Automatics.....	215
Tools, Making Machines Used for .....	217
Types of Lathe Test Indicators .....	237

## U

Umbrella Stretcher Machine, Automatic.....	103
Unexpected Descent of Ram .....	195
Uniformly Heating Steel for Hardening.....	263
Unreliable Methods of Erecting.....	46
Upper Stamp Die .....	59
Use of a Stay Bolt on a Press .....	153
Use of Profiling Machine .....	229

## V

Vertical Hopper for Feeding Blanks.....	203
Vice, a Special Machine.....	233

## W

Washer, Stamping a Steel.....	139
Waste Work Caused by Common Stripper .....	255
Weight of Stamp Block and Hammer .....	205
Whitworth Standard .....	6
Wire Bending, Tools for.....	121
Wire Cutting by Press Tools.....	125
Work Done by a Stamp Hammer .....	299
Work in the Copying Press .....	293
Work of the Fly Press.....	294
Work of a Screw Press .....	295
Work, Ornamental Spinning .....	109
Work, Setting, upon a Lathe Face Plate .....	245
Work, Tools and Jigs for Repetition.....	236
Worm Adjustment for the Ram .....	197
Worthless Gauges.....	3
Wrought-iron Base on Die.....	55

2D.  
Weekly.

# THE Practical Engineer.

2D.  
Weekly.

Published simultaneously in London and Manchester every Friday.

The Best Weekly Journal of Mechanical and Motive Power Engineering.

Subscription (including Free Copy of Pocket Book, if ordered direct from the Publishers) 10s. per annum, post free to any address.

## PUBLISHED ANNUALLY.

### The "Practical Engineer" **POCKET BOOK.**

Price, 1s. ; Leather Gilt, 1s. 6d. net ;  
Postage, 2d.

### The "Practical Engineer" **Electrical Pocket Book.**

Price, 1s. ; Leather Gilt, 1s. 6d. net ;  
Postage, 2d.

## Books for Engineers, Draughtsmen, &c.

(Post Free to any address on receipt of published price.)

**Governors and Governing Mechanism.** By R. H. HALL. 2s. 6d. net.

**The Manufacture of Iron and Steel Tubes (MARKS).** 2nd Ed. 5s. net.

**The Proportions and Movement of Slide Valves (WANSBROUGH).** 4s. 6d.

**Specification for a Lancashire Boiler and its Seating.** 5s. net.

**The Resistance and Power of Steamships.** Price 5s. net.

**Continuous Current Dynamos and Motors and their Control.** 5s. net.

**The Management of Engineering Workshops (BARKER).** 7s. 6d. net.

**Modern Gas and Oil Engines.** 3rd Edition. (GROVER.) Price 5s. net.

**The Indicator and its Diagrams.** 3rd Edition. (DAY.) 4s. 6d. net.

**Notes on the Construction and Working of Pumps (MARKS).** 3s. 6d.

**Problems in Machine Design.** By C. H. INNES, M.A. 2nd Ed. 4s. 6d. net.

**The Design of Structures.** By W. F. PULLEN, Wh.Sc., &c. Price 6s. net.

**Modern Ironfoundry Practice.** By G. R. BALE. Vol. I. Hand Moulding. 5s. net.

**Opening Bridges.** By GEO. WILSON, M.Sc. Price 2s. net.

**Injectors.** By W. F. PULLEN, Wh.Sc., U.E., &c. 2nd Ed. Price 3s. 6d. net.

**The Theta-Phi Diagram, applied to Steam, Oil, and Air Engines.** By H. A. GOLDING, A.M.I.M.E. 3s. net.

**Engineering Estimates and Cost Accounts (BURTON).** 3s. net.

**Centrifugal Pumps, Turbines, and Water Motors (INNES).** 4s. 6d. net.

**Practical Notes on the Construction of Cranes, &c. (MARKS).** 3s. 6d. net.

**The Naval Engineer and the Command of the Sea.** 2s. 6d. net.

**Marine Engineers: Their Qualifications and Duties.** 5s. net.

**Heat and Heat Engines.** By W. C. POPPLEWELL, M.Sc. 6s. net.

**Graphic Methods of Engine Design (BARKER).** 3s. 6d. net.

**The A B C of the Differential Calculus (WANSBROUGH).** 3s. net.

**The Chemistry of Materials of Engineering (SEXTON).** 5s. net.

**Mechanical Engineering Materials (MARKS).** Price 1s. 6d. net.

TECHNICAL PUBLISHING CO. LTD., 287, Deansgate, Manchester.

JOHN HEYWOOD, London and Manchester; and all Booksellers.





SCIENCE AND ENGINEERING  
LIBRARY  
University of California,  
San Diego

DATE DUE

SEP 13 REC'D

MAY 25 1979

MAY 11 REC'D

DEC 07 1960

DEC 07 REC'D

SE 16

UCSD Libr.

its  
2

