

MACHINERY'S REFERENCE SERIES

EACH NUMBER IS ONE UNIT IN A COMPLETE LIBRARY OF
MACHINE DESIGN AND SHOP PRACTICE REVISED AND
REPUBLISHED FROM MACHINERY

NUMBER 107

DROP-FORGING DIES AND DIE-SINKING

By CHESTER L. LUCAS and J. WILLIAM JOHNSON

CONTENTS

Laying Out and Machining Operations - - - - -	3
Hand Operations - - - - -	18
Special Operations in Die-Sinking - - - - -	34

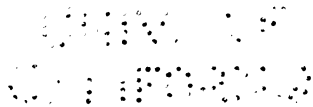

Copyright, 1918, The Industrial Press, Publishers of MACHINERY,
49-55 Lafayette Street, New York City

7737
K.3
1/27

7737
K.3
1/27

CHAPTER I

LAYING-OUT AND MACHINING OPERATIONS

The art of drop forging has worked a great change in the product of the blacksmith shop, both in regard to the quality and the quantity of the work produced. It has created a new branch of the business, and has enabled forgings to be employed in thousands of cases where this had formerly been impossible on account of the expense. Drop forgings are made to-day for nearly every branch of metal manufacturing, although the automobile industry has given rise to a much greater demand for them than has any one other industry. Drop-forgings are made that weigh but a fraction of an ounce, and others that weigh a hundred pounds or over. They are made from iron, steel, copper and bronze. It is needless to speak of the advantages of the operation of drop forging; economy of manufacture, strength, interchangeability, and the general appearance of the product, are all important factors.

The object of this treatise is not, however, to deal with the drop-forging operation itself, but to treat of the dies for this interesting work, and to consider some of the methods and tools used in the die-sinking. The good die-sinker must be somewhat of an all-round mechanic; he must have the knowledge of machine work of the machinist; the skill of the ornamental die-sinker, for sinking the irregular impressions; and a knowledge of steel working so as to know just how the hot steel will flow under the dies. The majority of the drop-forge die-sinkers of to-day have emanated from the ranks of the machinists and tool-makers, but the die-sinkers of to-morrow will be specialists whose thorough training has been acquired entirely in this one important class of work.

Classes of Drop-forging Dies

Drop-forging dies, like dies for the punch-press, are of several different types. Perhaps the most simple form of drop-forging die would be a pair of dies for producing a simple round forging, as, for instance, a gear blank. These dies would require a central impression turned in each of the dies of the pair. Before using the dies, a square plate of steel is worked under the hammer, drawing out a short shank at the side, and "knocking down" the corners. This roughly shaped block of steel is held by the shank and placed between the dies and thus brought to shape.

The most common form of drop-forging die, however, is the one in which there is a central impression to shape the forging, and a side impression, called the "edger," "break-down" or "side-cut," that helps to properly distribute the hot steel. To make clear the use of these two sets of impressions, a drop-forging die of this description may be

likened to a drawing of the finished forging, in which the outline of the central impression would resemble the plan view of the forging, and the two halves of the edger would correspond to the side elevation of the forging. Of course this illustration is not literally correct, but it expresses the general idea. The edger is always on the right-hand side of the die, and the steel bar is struck first in the break-down, edgewise, and then turned and struck flat in the impression, alternating in this manner until the forging is "full."

There are also dies that in addition to the central impression and the edger are made with an anvil or "fuller," as it is sometimes termed. The anvil is formed in the dies at the left-hand side, and is used to draw out the stock previous to striking it in the edger or in the impression



Fig. 1. A Group of Untrimmed Forgings

itself. Dies with anvils are necessary in making forgings in which there is a considerable displacement of the stock. A double-ended wrench, which is thin in some places and very much thicker and wider in other places, may be mentioned as an example. The anvil consists of two flat-faced parts of the die, whose faces, called "fullers," come just near enough together to flatten the stock to such dimensions that when finished in the central impression very little stock will be left to be squeezed out as the fin. After the stock has been thus drawn out to roughly fit the impression, the forging is shaped in the usual way by means of the edger and the die impressions. A considerable number of large drop-forging dies require anvils. In making the dies for difficult forgings, there are often other special features incorporated in the dies, which will be more fully described later.

Fig. 2 shows the lower half of a set of dies with a break-down *A*, an anvil *B*, and the die impression *C*. The sprue is shown at *D*, the

gate at *E*, the flash at *F*, and the shank at *G*. In Fig. 1 are shown several completed forgings before being trimmed. The center of the eye-bolt is the only part that has been trimmed. The excess metal around the forging is called the "fin" and is removed in a separate operation, which may be done either hot or cold. If the forgings are to be cold-trimmed, as is the case with most small forgings, the dies are made with a cut-off to sever the forging from the bar when finished. If the forgings are to be hot-trimmed, they are severed in the trimming press,

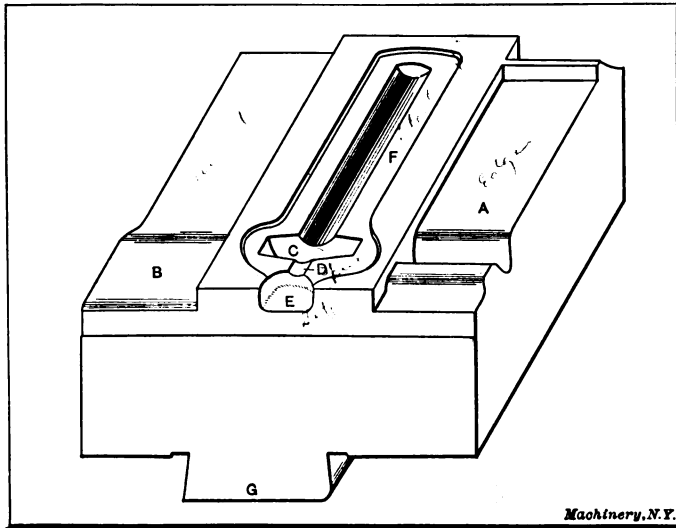

Fig. 2. The Lower Die of a Pair of Drop-forging Dies

and the forging dies will need no cut-off. Fig. 3 shows a group of small finished forgings.

Thus far we have considered only dies with one impression, but in dies for first-class forgings, especially when there is a large number to be made, two impressions are provided, the forming and the finishing. The forging is nearly completed by the edger and the forming impression (and anvil if needed), and finally struck several blows in the finishing impression to bring it up to size and finish it. Thus the finishing impression is saved the severe duty of completely forming the forging, and hence the dies last longer. On small and medium-sized forgings these two impressions are placed side by side in the same die, but if the forging is large, the finishing impression is made in a separate set of die-blocks and set up in a hammer set close to that which forms the forging. The forger uses both hammers to get out the work in such cases. It is seldom that more than two impressions are cut in the same set of dies, but if the piece is small and the number of pieces to be forged great, it is often advisable to make the sets of dies with two or more finishing impressions in addition to the forming impression. If this is done, the die has a longer life, for after one of the finishing

impressions gives out by spreading or "checking," there is still a good finishing impression left.

In addition to these different styles of drop-forging dies, the dies for trimming the fin from the forging must be taken into consideration. As already indicated, trimming dies are of two classes: those for trimming the forging while it is hot, and those for trimming the forging after it is cold. The making of drop-forging dies for forgings of other metals than steel or iron involves the use of special methods. This phase of the subject will be treated later.

Information Required by the Die-sinker

Before the die-sinker begins making the die, he should be given certain information about the job he is to do, in order to make a set of dies that will give satisfactory results. As a general rule, he is fur-

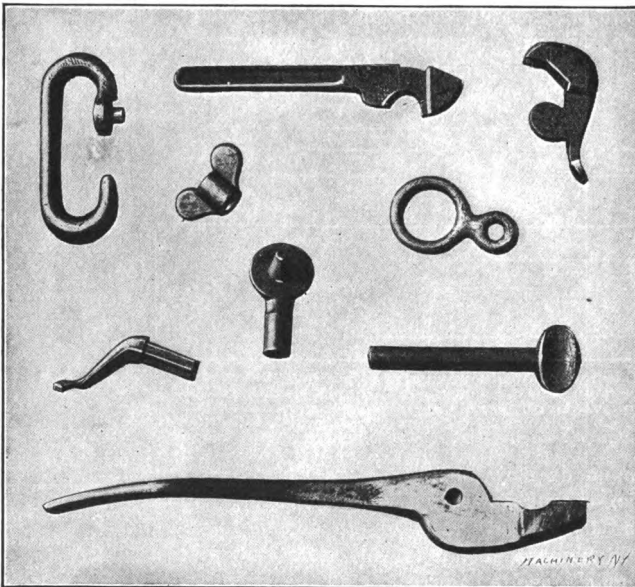

Fig. 3. A Number of Small Finished Drop Forgings

nished with either a drawing or a model of the finished part, or, what is most satisfactory of all, with a sample forging. He must know what finishing operations the forging is to pass through, so as to allow enough stock for machining, and he must know of what metal the piece is to be made, so as to cut the dies large enough to allow for the shrinkage of the metal.

With this information supplied he must decide upon a number of other points that are largely a matter of judgment on his part—points that have to do with the successful working of the dies. He must decide, first, whether to make the set of dies with a forming impression in addition to the finishing impression; second, the way in which to

"face" the impression on the die-block so as to be able to use the best form of edger; third, whether to include an anvil in the dies; and fourth, the type of hammer or hammers the dies will be used in, so that the dies are made in blocks of the proper size. In making the trimming dies he must also decide whether to trim the forging hot or cold. With these points decided, he is prepared to start the making of the dies.

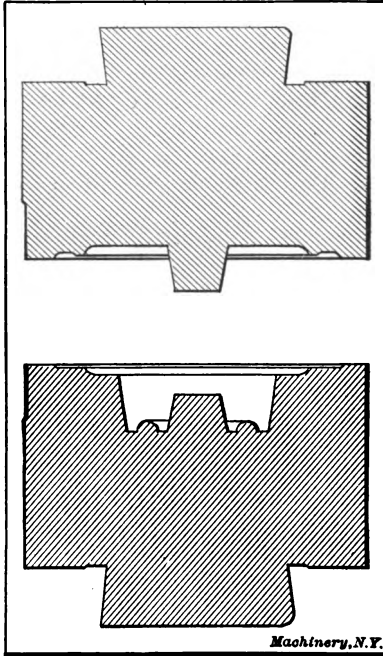

Fig. 4. Drop-forging Dies of a Type that should be made of High-carbon Steel and not hardened.

In making dies for large forgings it is often considered advisable to use 80-point carbon steel for the dies, and not to harden them. This obviates the danger of "checking" or cracking in hardening, and the steel, unhardened, is hard enough to resist the tendency to stretch.

In Fig. 4 is shown, in section, a pair of drop-forging dies for forging automobile hubs. Dies of this design should be made of high-carbon steel and left soft on account of the projecting ring in the bottom of the impression which would be likely to break off if the die were hardened. A steel fairly high in carbon should always be employed for dies that are to be used for making forgings from tool steel or other hard steel. When making forgings for very thin parts that cool quickly while being forged, it is usually preferable to use tool steel for the dies, in order that they may be hardened to a depth sufficient to withstand the tendency of the dies to "dish." A drop-forging die or any die used in the drop hammer, is said to be "dished" when the force of the blows

Steel for Drop-forging Dies

Open-hearth crucible steel is the material from which nine-tenths of all drop-forging dies are made; a 60-point carbon steel is used for most of the dies. In some cases, however, steel as low as 40-point carbon and as high as 85-point carbon is used, but few shops use anything but 60-point carbon steel for the general run of work. If a low-carbon steel is used, a special hardening treatment is required, which outweighs any saving in the price of the steel. Of course, the high-carbon steels make good dies, but except in special cases, there is no necessity for using so high-priced a steel. The average 60-point carbon steel die, if properly hardened, should last for from 15,000 to 40,000 forgings and sometimes as many as 70,000 forgings are made from one set of dies.

In making dies for large forgings

it receives causes the central part of the face to sink beneath the level of the remainder of the face. This condition results in forgings or stampings that are too thick in their central parts. Dishing is usually traceable to a low grade of steel or to improper hardening.

Preparation of the Stock

The best method of preparing the die-blocks is to plane the stock in lengths of from six to eight feet, after which it may be cut to any lengths required by the sizes and shapes of the forgings for which the dies are being made. Occasionally a pair of die-blocks must be planed for a special job, but it is quicker and cheaper to plane them in lengths when the work warrants it, although many shops do not take advantage of this. The steel may be obtained from the mills in ordinary sections suitable for dies six or eight inches in height, which are the sizes mostly used. At the time of planing, the dies are

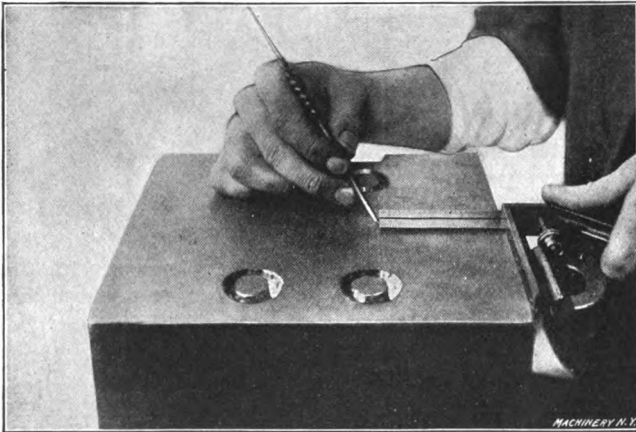

Fig. 5. Laying out the Dies: Transferring a Line from One Die to the Other of a Pair

“shanked” with the proper bevel and height of shank, to agree with the system in vogue in the shop where the dies are to be used.

The die-blocks are planed on the front and left-hand sides for a distance of two inches, or a little less, from the face. These two cuts are merely “skin chips,” and are perfectly square with each other and with the shank of the die; their purpose is to furnish faces from which the impressions may be laid out. The use of these “matching-sides” is plainly indicated in Fig. 5. The reason for using the left side is because the edger is always to the right, and in cutting away for this part of the die, the lay-out face would be destroyed. This would make it impossible to work from that side afterward, in case it should be necessary to make changes in the impression. On the left side the anvil is formed, but this interferes but little with the working face that has been planed, because the anvil occupies but little space, at least as regards depth. In planing these working faces, care must be

exercised to have the faces perfectly parallel with the shanks of the dies; otherwise the two halves of the forging will appear to be twisted with relation to each other, and to correct the error it will be necessary to "shim" the dies—a practice that should be permitted only as a last resort.

There are various precautions taken to prevent blunders in the setting up of the dies. The forger usually lines up the dies by matching the sides of the die-blocks. On dies whose matching faces have been cut away, the die-sinker usually cuts a deep "nick" from one die to the other, while they are in alignment. The shank of the upper die-block is milled with a "half-hole" to fit the familiar "dutchman" in the hammer of the drop-press.

Laying out the Dies

We are now ready to take up the work of laying out and cutting the impressions in the dies. The laying-out of drop-forging dies is totally different from the laying-out of blanking dies, this being due principally to the different allowances that must be made for shrinkage, draft and finish. The allowance for shrinkage is an important one. In order to properly understand the considerations to be taken into account, it is necessary to understand the trimming methods employed for removing the fin. Small forgings are invariably completed, and the fin trimmed off after they are cold; such forgings are said to be cold-trimmed. Larger forgings are trimmed hot and then struck once or twice to finish and straighten them, as it is probable that the trimming has somewhat distorted them. At the time of the last blow, the forging has cooled to a low red heat. In making dies for small cold-trimmed steel forgings, the proper allowance for shrinkage is $\frac{3}{16}$ inch to the foot or 0.015 inch to the inch. Such forgings are completed at a bright red heat, and the rate of shrinkage is great.

In making dies for hot-trimmed steel forgings, which are of medium and large size, the proper allowance for shrinkage is $\frac{1}{8}$ inch to the foot or 0.010 inch to the inch. Hot-trimmed forgings, receiving the finishing blow while relatively cold, shrink a smaller amount than forgings that are cold-trimmed. These proportions hold true for all dimensions of the die impression, whether they be depth, width or length. In making dies for forging bronze or copper, the same principles apply, and the rate of shrinkage for cold-trimmed forgings is $\frac{3}{16}$ inch to the foot, and for hot-trimmed forgings $\frac{1}{8}$ inch to the foot, or practically the same as for steel.

The Draft Allowance

It would be very convenient if we could sink forging dies with sides perfectly straight, the same as a die-casting mold, but in die-sinking this is impossible, as the forging would stick in the die. To overcome this tendency, we employ "draft," just as the pattern-maker does. The amount of draft given a drop-forging die varies from 3 degrees to 10 degrees. If the die is for a thin regular forging, like an oval treadle plate, 3 degrees is ample, but if the forging die is deep, with narrow ribs which are apt to stick, at least 7 degrees is necessary. Should the

die be for forging a piece that is ring-shaped or has a ring in its make-up the central plug that forms the interior of the ring will require a draft of 10 degrees, because, as the forging cools while being worked, it tends to shrink together around the plug, and if the draft is insufficient, it will stick in the die. With the above exceptions, however, the majority of drop-forging dies are cut with a 7-degree draft. For convenience in laying out, it is well to remember that a 7-degree taper equals practically a $\frac{1}{8}$ -inch taper to the inch, and a 10-degree taper, $\frac{3}{16}$ -inch to the inch.

The Allowance for Finish

By "the allowance for finish" is meant the additional metal that is "put on" the forging at those places that are to be machined. Very often it happens that there is no finish required on the forging, in which case, of course, there will be no allowance. Usually, however,

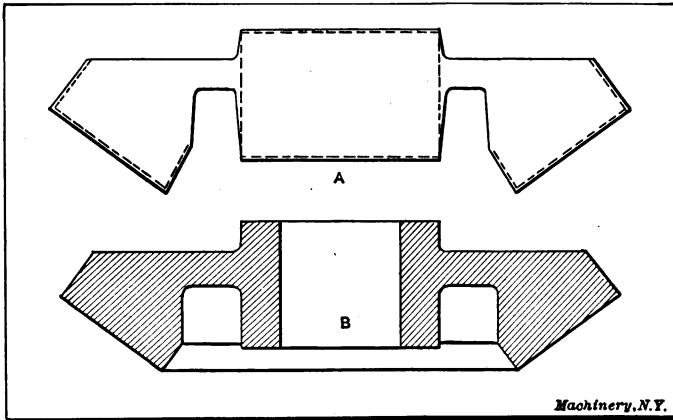

Fig. 6. Templet with Shrinkage, Draft and Finish Allowances added, used in turning out the Impression in a Die for a Bevel Gear Blank. B shows the Finished Gear Forging after being machined

there are bosses to be faced off or other places that require machining, and in such cases the forging is left $\frac{1}{32}$ inch oversize at these points.

Scribing the Outline

In laying out the dies the first step is to copper the faces of both the upper and lower die, after which center lines should be scribed from the two matching sides of the die-blocks. If the forging is irregular in outline, it is advisable to make a templet. Not only will the templet be useful in laying out the two impressions, but if the forging is to be hot-trimmed, the templet can be used in laying out the trimming die and punch. The use of a templet insures that the two dies will match perfectly, for after laying out the lower die, the templet is simply reversed and used for the upper die. The templet should be made of thin sheet metal, and if brass or zinc is used, it may be sawed out with a band or scroll saw and then filed to the line in the usual way. Fig. 6 shows at A a templet for a bevel gear forging, with the various

allowances made, ready to be used in laying out the impression; *B* is the finished gear blank. First the outline of the finished forging is laid out, then the draft allowance is added, and at those points that must be machined, allowance is made on the templet for this purpose. In laying out the set of lines for the shrinkage allowance, a shrink-rule is used, either a $\frac{1}{8}$ inch to the foot or a $\frac{3}{16}$ inch to the foot, as the case may require.

Frequently it happens that the outline of the forging at the parting line is simple and regular, as, for instance, in the case of an eye-bolt forging. In the case of such a simple shape, there is no necessity for a face templet, as the outline may be laid out from the two matching sides of the dies by means of a square and dividers. In order that the outlines of the impressions on the two blocks may come in perfect alignment, two and sometimes three combination squares are used in locating the templet on the blanks, in case a templet is used. The templet is placed in its proper position on the face of one of the die-blocks, and a combination square is set from each of the matching sides to the edge of the templet. With the templet against the ends of the square blades, the outline is scribed; then, without changing the blades of the squares, they are placed in corresponding positions on the other die-block, thus locating the templet (now reversed), and the outline is scribed on this die. The combination square also affords a good way for transferring lines from one die to the other. Fig. 5 shows the die-sinker transferring a measurement from one die to the other die upon which he has started work. After the outlines of the two impressions are scribed on the faces of the die-blocks, they should be either lightly prick-punched at intervals along the lines, or they should be traced with a small, sharp chisel, using the chisel after the manner of a punch, and moving it after each tap of the hammer so as to obtain a clear, deep, continuous line.

In planning the lay-out of a drop-forging die, there are several points that must not be overlooked. The heaviest end of the forging should always be at the front of the die-block, as illustrated in Fig. 2. This makes the forging easier to handle while being forged and still on the bar, and it also permits the use of a liberal-sized sprue. In selecting a die-block and laying out the impression, there should be at least $1\frac{1}{2}$ inch left all around the impression from the outside edge of the block or from any part of the die, such as the edger, anvil or forming impression. If the forging has a hub or other projection that extends some distance from the body of the forging on one side, as in the illustration at the center of Fig. 3, the upper or top die should contain this deeper impression. This is an important point, for every die-sinker and drop-forging knows that it is easier to "shoot" the metal up than down; just why it is so, however, is difficult to understand.

Sinking the Impression—The Machine Work

The work of sinking the impressions in the dies may be roughly divided into two parts: the machine work, and the hand work. In the machine work, the lathe and the vertical milling or die-sinking machine

are the two principal machine tools used. Generally speaking, if there are parts of the impression that can be cut out on the lathe, it is good policy to do this work first, although there are exceptions to this rule which will be mentioned later. The advantage of doing the lathe work first lies in the fact that a large amount of the stock is removed quickly and uniformly, so that the die-sinker has a better chance to start the milling cutters.

The best method of holding the dies for the lathe work is by means of a special bolster, bolted to the faceplate. The bolster is planed to

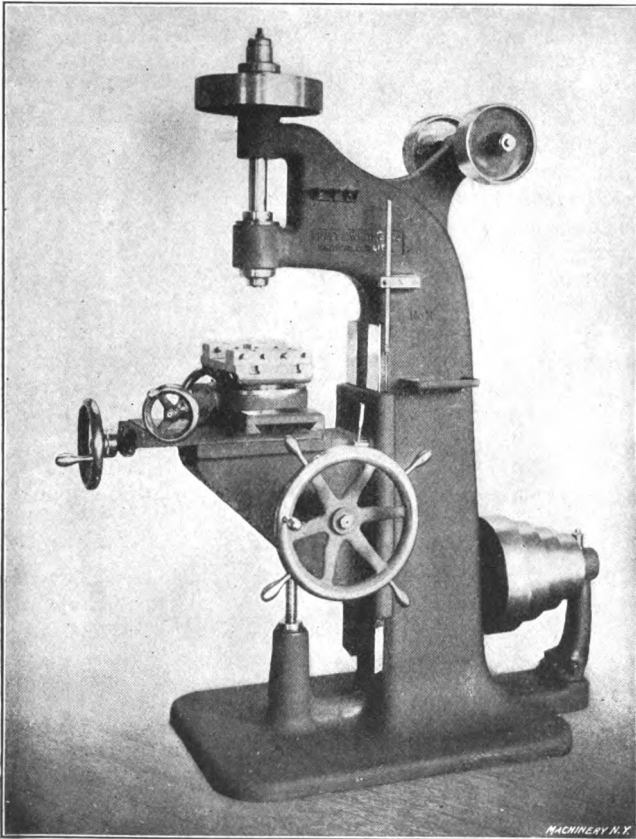

Fig. 7. The Pratt & Whitney No. 2 Die-sinking Machine

take the shank of the die-block, which is held in place by a key. This method has certain advantages over the practice of holding the die-block with set-screws, in that the block may be more easily made to run true, and there is less danger of the die-block working loose. Much time may be saved in the turning if the lathe is equipped with a compound rest, for the draft may then be bored out by swinging the

rest over the required number of degrees. If the lathe work is other than very plain, it is necessary to make use of templets. In turning out the impression for a bevel gear blank, for instance, the templet for the turning would appear as shown at *A* in Fig. 6. A study of this templet will give a good idea of the allowances for draft, shrinkage and finish. The lines of the finished gear show a straight hub, that is, there is no bevel on its sides. In cutting the impression, however, these lines must be given a draft of 7 degrees to prevent the forging from sticking in the dies. The top and bottom of this hub, as well as the face where the teeth are to be cut, will of course be machined; therefore $1/32$ inch is added to the templet at these places. The shrinkage allowance is taken care of by laying out the dimensions of the templet with the $1/8$ inch to the foot shrink-rule, as the forging will be trimmed hot.

The Die-sinking Machine

The die-sinking machine is by far the most important asset of the die-sinker's equipment. At the present time, most die-sinking shops are equipped with machines of the Pratt & Whitney make—the No. 2 machine for the small and medium work and the No. 3 for the heavy

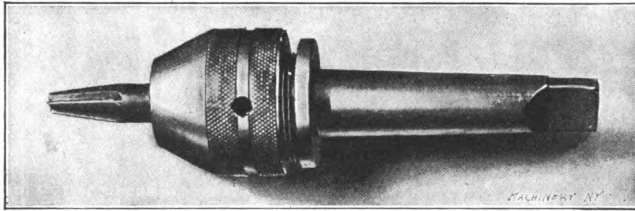

Fig. 8. Special Cutter Chuck for the Die-sinking Machine

work. These two machines will take care of any dies to be made, and in small shops where but one die-sinking machine is installed, the No. 2 size will be found sufficient, if the work is not very large. The illustration, Fig. 7, shows the latest model of the No. 2 machine. The dies are held in the vise of the machine, the shank of the die-block furnishing a good gripping surface. The cutters are held in a spring chuck, that, by substituting different collets, will accommodate cutters made of stock from $1/4$ inch to 1 inch diameter. This chuck, shown in Fig. 8, and its parts in Fig. 9, is made in three pieces—the shank *A*, which is recessed to take the split collet *B*, and the sleeve *C*, which has an internal taper bearing surface. As the sleeve is screwed onto the shank, the split collet is compressed, drawing together upon the cutter without throwing it out of center. The sleeve is tightened by the aid of a spanner wrench, and no trouble is experienced from the cutter slipping in this style of chuck.

Cutters for Die-sinking

The subject of cutters for die-sinking is a very important one, for neither good nor fast work can be done with poor cutters. The very best of roughing cutters can be made from "stub ends" of Novo drills,

and nearly every die-sinker takes advantage of this fact. These short drills are ground ball-pointed on the cutting end, given clearance, and the center ground out as shown at *D* and *E* in the illustration, Fig. 9. This kind of cutter is so easily and quickly made, and stands up so well in "hogging out" the stock, that it does not pay to use any other kind.

For finishing, the cutters are made with three or more flutes, so as to get smooth surfaces. Finishing cutters must be provided in a large variety of shapes to take care of the various forms in the dies being cut. At *F*, *G*, *H* and *I* in Fig. 9 are shown good examples of finishing cutters, most of which are made for finishing dies with a draft of 7 degrees; at *J* and *K* are shown special cutters, the former for cutting very narrow grooves, and the latter for shallow dies with a draft of 2 degrees.

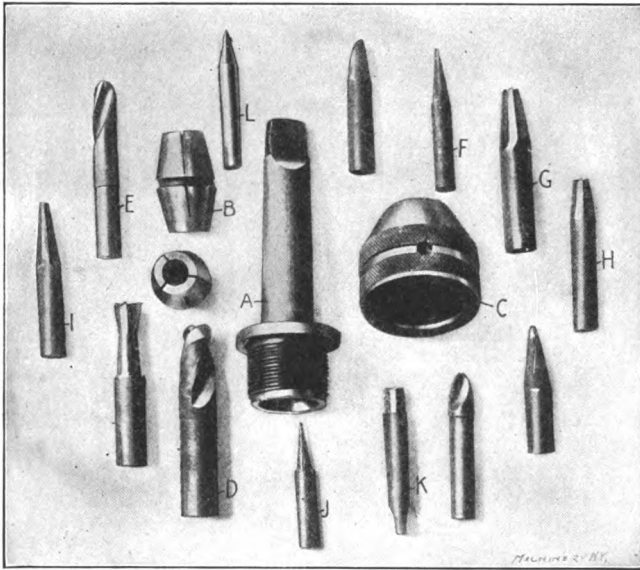

Fig. 9. Chuck Parts and Cutters for the Die-sinking Machine

The die-sinker is guided in the milling by the lines laid out on the face of the die-block and by the index on the pilot wheel of the die-sinking machine, the scribed lines giving the outline, and the index of the pilot wheel taking care of the depth of the various parts of the impression. Except when using special cutters like hub and forming cutters, no oil is used on the tools. The speeds at which the cutters should work vary with the size and style used. If the cutter is a small one, like that shown at *J*, Fig. 9, the speed may be much higher than would be used with a stout cutter like that shown at *G*. Of course, special forming cutters that are sometimes as large as 3 inches in diameter must run very much slower, and the use of lard oil is

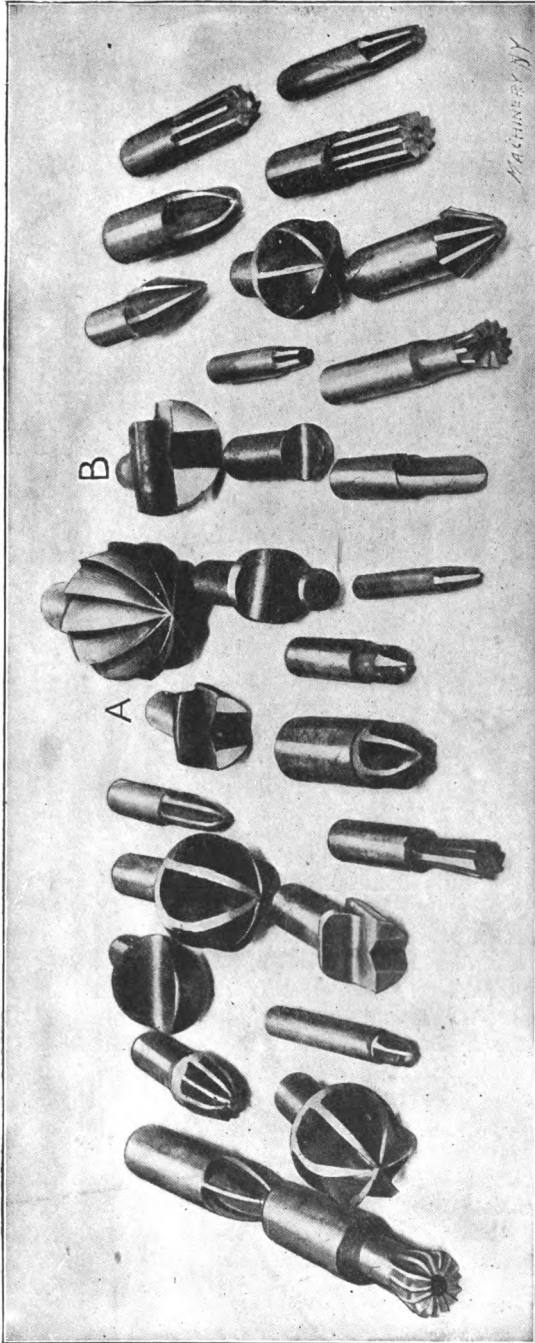

Fig. 10. Hub, Forming and Miscellaneous Cutters for the Die-sinking Machine

advisable. Fig. 10 illustrates some of these hub and forming cutters, and also shows a large variety of finishing cutters of various shapes and degrees of draft.

All circular parts of the impression are not bored out in the lathe, and indeed it is rarely advisable to bore out any parts under 3 inches in diameter, especially if they are deep. These small circular depressions are best taken care of by

special forming cutters or by the circular attachment on the die-sinking machine.

A great many forgings for machine parts have bosses in which must afterward be drilled a central hole. It is not practical to forge the part with the hole, but it is a great help to "spot" the forging, and thus obviate the necessity of using a jig for the following operation of drilling the

forgings. To produce the projection in the die for this "spot," a hub cutter is used. (See *A* and *B* in Fig. 10.) On account of being milled out at the center, and relieved, the cutter will leave a cone-shaped projection in the bottom of the impression that will produce a deep countersink in the boss of the forging.

It is very essential that a large cutter should be correctly located in relation to the outline of the impression before being fed into the die. In order to check its location, it is well to scribe, from the same center, a circle one or two inches larger than the one that is used for obtaining the outline. On this outer circle, four points, equidistantly spaced, should be prick-punched. After lightly entering the cutter, the outline should be tested with dividers from these four points.

The Circular Attachment

The circular attachment on the die-sinking machine is a valuable feature in milling the impressions. By its use much circular work may be done that would be awkward to bore out in the lathe, and short arcs

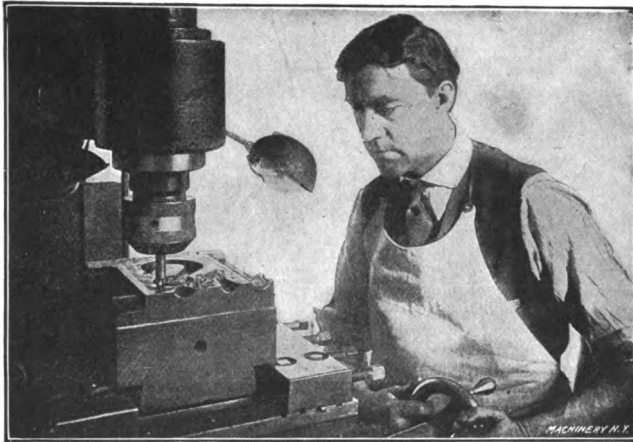

Fig. 11. Using the Circular Attachment

may be cut far quicker than in any other way. When this is used, a straight pointed rod is held in the chuck in place of a cutter. The machine table is adjusted with the two feed handles until the indicating marks, placed on the sides for this purpose, are in line. The table is lowered and the die-block located in the vise so that the center point of the arc to be milled is directly under the indicator in the chuck. Thus located, the table may be moved off center far enough to bring the cutter to the part of the impression that is to be milled, and the line followed by using the feed provided. In Fig. 11 the die-sinker is cutting the impressions for forming the eye of a chain hook, using the circular attachment in doing so. The old-style method of cutting these curves, used when the die-sinking machines were not equipped with circular attachments, was to loosen the check-nuts of the swivel vise, and after moving the die to the proper distance from the center,

clamp a long steel bar to the vise, and rotate the vise by hand. This method is here mentioned for the benefit of those whose die-sinking equipment is not of modern design.

Throughout all the machine work on the impressions, it must be remembered that as little stock should be left to be taken out by hand as is possible, for not only is hand work slower, but its quality can never equal machine work that is properly done. To this end, the finishing cutters should be run over the last cut two or three times, so as to get the smoothest possible surfaces. The heavy milling should



Fig. 12. Roughing out the Impression

be done with the roughing cutter, held in the chuck close to the cutting point, after the manner illustrated in Fig. 12. If, after the finish milling, the surfaces are smooth and the line is "split," there will be little left to be done by hand save the corners and possibly a few irregular shapes that cannot be milled. In the final milling cut for finishing to correct depth, exact dimensions may be obtained by setting the cutter so that it just touches the surface of the die, and then moving the index on the pilot wheel to zero and raising the table to the required dimension, as indicated by the reading of the index.

CHAPTER II

HAND OPERATIONS

The really difficult work of die sinking is the hand work that is necessary to finish the impression; at least this part of the work requires more patience and manual skill than the machine operations connected with die sinking. Some impressions are full of corners and irregular places that must be chipped out and smoothed by hand, nearly every job having a number of such places. These places must be chipped, scraped, rifled and polished, and to facilitate this finishing, the die is held in the ball vise shown in Fig. 13. This useful device, almost too well known to be described, rests on a pad of leather, which in shop practice is made by coiling up a short length of two-inch belting, and riveting it at intervals. By the use of the ball vise, the die

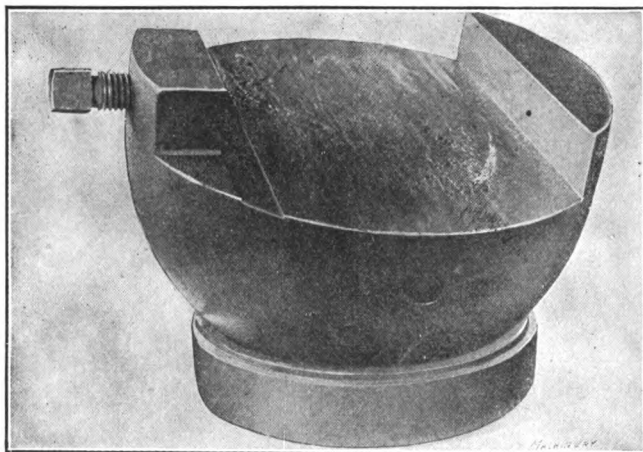

Fig. 13. Ball Vise used in Holding Dies for Hand Work

may be held at any desired angle or position, and will remain where put with sufficient stability to resist any ordinary chipping or filing.

Chisels and Chipping

Die-sinker's chisels are made preferably of Jessop's steel, but any good tool steel will do in the absence of Jessop's. The stock should be hexagon or octagon, and forged out to the shapes best suited to the work. Two or three dozen shapes and sizes of chisels are necessary for the different shaped places that must be chipped out in the general run of work. The most useful shapes are the round and flat varieties, some of which are shown in Fig. 14. The round variety embraces a great many different curves. The flat varieties should run from $1/32$ to $1/2$ inch in width. After hardening, the chisels should be drawn to a

light blue, this temper being the same as that given the ordinary cape chisel, and which will be found a good ordinary temper. The die-sinker's chipping hammer, illustrated in Fig. 15, is flat-faced and double-ended, so that either end can be used. To aid the die-sinker in chipping out parts of the impression that are to be the same

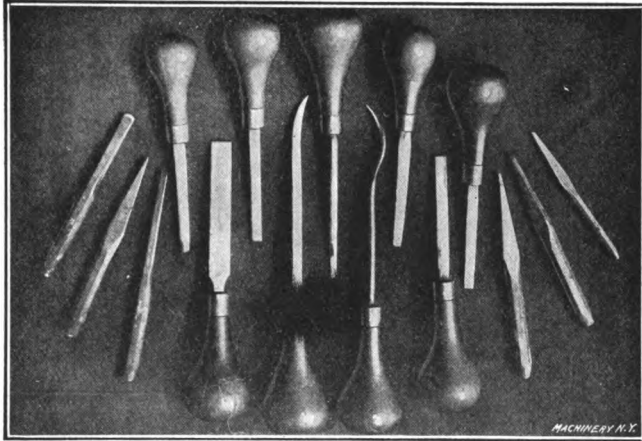

Fig. 14. Chisels and Scrapers used in Die Sinking

depth, depth gages like those shown in Fig. 16 are used, and occasionally the micrometer depth gage will be found indispensable; but there are few jobs that require such accuracy. In Fig. 16 are also shown the two shrink rules that are used in laying out the die impressions.

In chipping out the stock from the corners and other places that cannot be milled, there are a few general rules that should be fol-

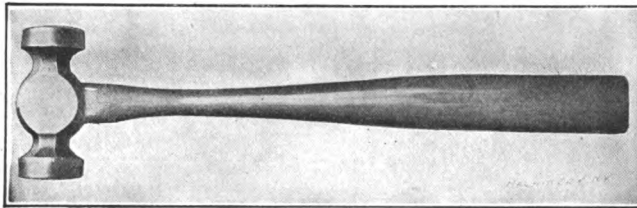

Fig. 15. Die-sinkers' Chipping Hammer

lowed. It is always advisable to chip down or away from the outline of the impression, for by so doing there will be no danger of breaking out "chunks" at the ends of the cuts. In using flat chisels care should be taken to leave as little work for the corners to do as possible, for the corners are the weakest parts of flat chisels. Oil should be used sparingly on the cutting edges of all chisels. For convenience in picking out the different chisels, it is a good plan to keep them, points up, in round cans or boxes. In all chipping, the die-sinker should "make haste slowly," taking light cuts and many of them, frequently trying the templets and depth gages so as to be sure he is not taking out too much stock.

Fig. 18 shows the die-sinker chipping out what appears to be a simple part of an impression, but in reality it is an awkward place, being the oval end of the impression for a chain shackle. The second impression is the forming impression; both of them have been milled

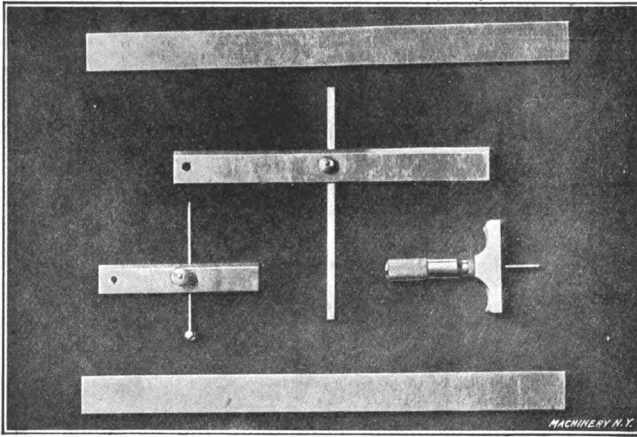

Fig. 16. Shrink Rules and Gages used in Laying out and Sinking the Impressions

out as much as possible and are now being cleaned up by chipping, after which scraping and riffling will follow before the rest of the im-

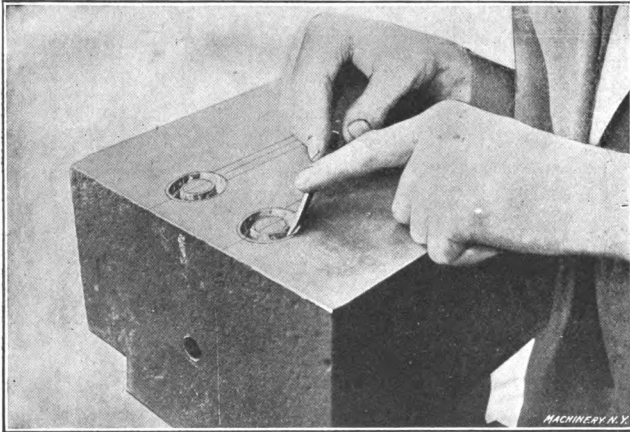

Fig. 17. Scraping Out the Impression

pressions are milled. In most cases, however, it is best to complete the milling while the die is on the die-sinking machine.

Scraping, Riffling and Polishing

The idea of the chipping is to remove as much stock as possible from parts of the impression that cannot be milled or otherwise machined. Of course, it is impossible to finish the die by chipping alone; therefore,

after the bulk of the steel is taken out by milling and chipping, the impression must be smoothed by scraping and riffling.

Scrapers are of several different types. Nearly every mechanic is familiar with the three-cornered and half-round scrapers, and both of these tools are used at times in scraping out a die; but by far the most useful kinds of scrapers are those made of square and half-round straight sections. These scrapers are short, made to cut on the end

only, and "pare" out the stock very quickly. As shown in Fig. 14, these tools are fitted into short, round handles that fit the hand snugly.

After grinding and stoning the edge of the scraper, the corners are slightly stoned off so that there will be no tendency to "dig in." By the use of the scrapers, the high points left by the chipping operation are reduced, and the surface of the impression smoothed. Fig. 17 shows the method of holding the scraper; in this instance the die-sinker is scraping out the oval end of the shackle impression, the milling and chipping having been finished. Scraping is not intended to remove much of the stock, but is more of a finishing operation.

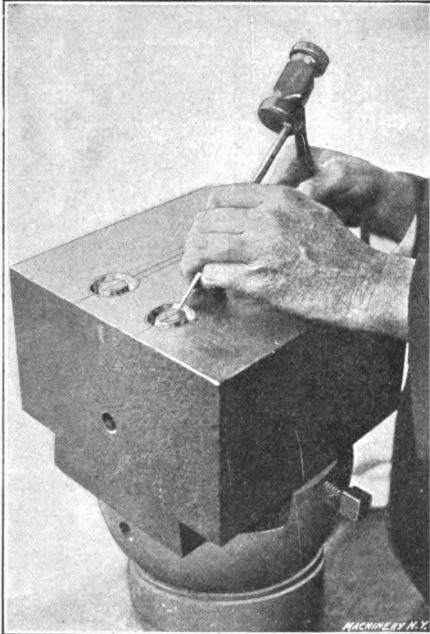

Fig. 18. Chipping Out the Die

By scraping alternately in different directions, the impression is kept free from grooves and ridges. Should there be any chatter marks left by the milling operation, they may be taken out by scraping.

As soon as the die impression has been finished as regards dimensions with the scrapers, the surface may be carefully smoothed by riffling. The rifflers, or small bent files, may be obtained in a large variety of shapes, sizes and cuts. As the illustration, Fig. 19, shows, the riffler is held lightly in the hand and is worked back and forth over the surface to be smoothed. In other words, it is filing on a small scale. A collection of the most useful of the different rifflers is shown in Fig. 21. The most common form is the "spoon" riffler, which comes in many different grades of curves, its name describing its shape perfectly. By turning the riffler while using, many different kinds of curves may be obtained, so that there are few spots in a die that cannot be reached with a spoon riffler.

Next in point of usefulness comes the flat riffler, which is made in

different shapes and widths to take care of the flat surfaces and panels in the impressions. Other styles are the hook riffler, the knife riffler and the round taper riffler. As with scraping, the rifflers must be worked over the surface with ever-changing directions to prevent the formation of grooves and ridges.

As a final finish to the impression, emery cloth, wrapped around a file or a piece of wood, should be applied to every part of the impression, until the surface is perfectly smooth and free from imperfections, using first the coarse and then the fine emery cloth. Often the shape of the impression is such that it can best be polished with emery and oil used on the end of a stick of wood. The emery will imbed itself in the wood as it does in a lap. The reason for this finish is first to get a good surface on the forging and second, to assist the forging to come easily from the die while being worked.

Types and Typing

Frequently it happens that in a drop-forging die there are irregular bosses or ends that cannot be finished on the die-sinking machine, and that are particularly difficult to chip out, scrape and raffle to a finish.

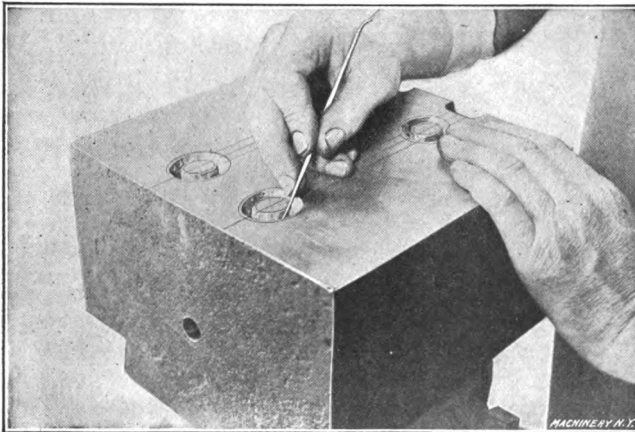

Fig. 19. Using the Riffler—Smoothing the Impression

Usually these places are deep and narrow, and generally it happens that there are two of these awkward places to cut out, one in each of the two dies. It is customary to take care of such places in dies by means of typing.

A "type" is a punch or small block of steel whose end is shaped exactly like that part of the forging that is difficult to cut in the die. Types are hardened and drawn to a purple temper. The part of the die that is to be typed is milled and chipped out to as near the outline and depth as is considered safe. The face of the type is then rubbed lightly with Prussian blue, placed in the impression, and with a piece of copper or brass on its top, the type is struck hard into the impression with a hammer. This operation leaves the high places with a blue facing.

These high places are next chipped away, care being taken not to go too deep, and the process is repeated. If properly done, the typed part of the impression will gradually assume the shape of the type and at last, by striking in the type a number of times, the impressions will take on the smooth finish of the type and be ready for riffling. If the part of the impression to be typed is cylindrical, the type may be

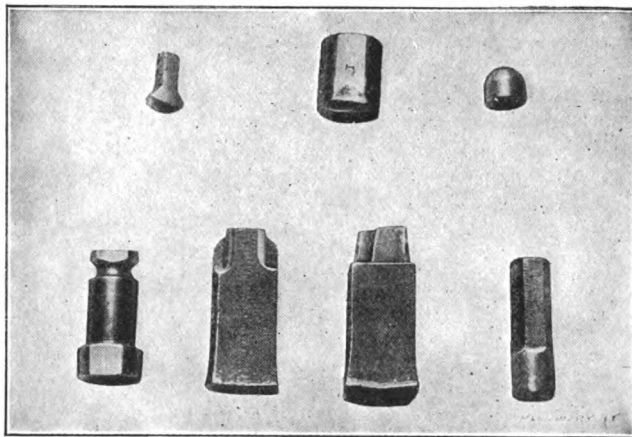

Fig. 20. A Collection of Turned and Milled Typing Tools

turned up in the lathe; but if not, it must be milled and filed to shape. Fig. 20 shows a few types for different die sections, some of which have been turned in the lathe.

In making types for shaping the impressions in dies for forgings whose ends or hubs are shaped like the forging shown in Fig. 22, there

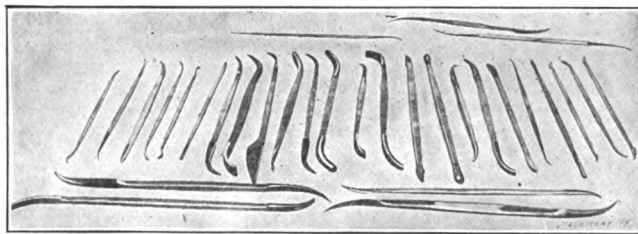

Fig. 21. Die-sinkers' Assortment of Rifflers

is a very convenient rule to bear in mind. The rule is this: Shape the sides of the type with a curve, the radius of which is equal to twice the diameter of the hub. This rule insures the proper amount of draft on the impressions, and as this form is very commonly used on bosses at ends of rocker arms, levers, etc., the application of the rule is very frequent.

While speaking of the machine work on the die impression, it was stated that there were exceptions to the rule of doing all machine work on the impressions first. In typing, we find one of these exceptions.

Let us assume that we have a die to sink for the forging shown in Fig. 23. The impression would consist essentially of a ring with four projecting bosses that must be typed. If the ring were turned first, trouble would be experienced in typing the four bosses, as the type would have a tendency to slide into the ring at every blow. With such a proposition, it is far better to mill out and type the bosses before doing the lathe work, in order to save time and trouble in the typing.

Lettering

When the forging must show lettering, the dies are usually stamped at the bottom of the impression with the desired letters. This produces raised lettering on the forgings. The stamps used are not the usual sharp-line stamps in common use in the machine shop, but are made deep and with a flat face, so as to give body to the letters on the forg-

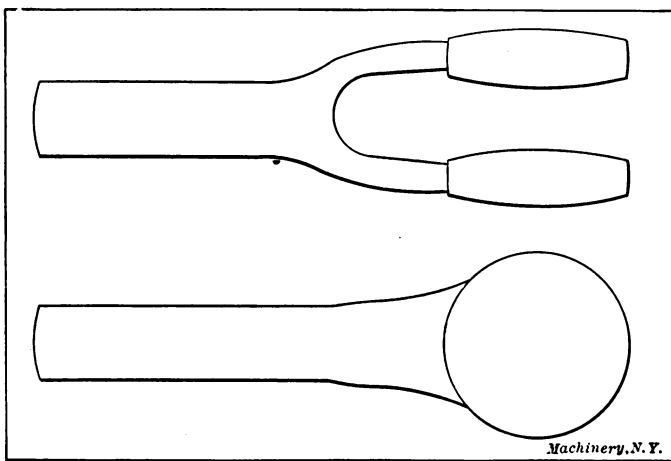

Fig. 22. A Forging to which the Rule for Making the Type Applies

ing. In putting in the lettering, care must be used in the spacing, for if too closely spaced, there is danger of the stock between the letters breaking out. To space a word properly, the central letter of the word should be stamped lightly in the center of the space to be lettered, and from this central letter the rest of the word is added on either side. If the letters are extra large in size, it is advisable to mill or chip out the letters after they have been lightly stamped in the die, after which they may be put in to the full depth without a large displacement of the steel.

The Gate and Sprue

In ninety-nine cases out of one hundred, a drop forging is made complete while still a part of the bar from which it is started and afterwards severed. To hold the forging while being worked, a sprue must be provided. The sprue is the connecting-link between the bar of rough steel and the forging. To form the sprue a channel is cut from the front end of the impression to the edge of the die-block. The

size of the sprue should be governed by the weight of the forging, and in all cases it should be no heavier than is necessary to support the forging while being worked and trimmed.

The gate is an opening in the front of the die to receive the bar stock, and is made large enough to admit the bar without forging or crushing it at all. Fig. 24 shows the operation of cutting the gate, and also illustrates the way in which the matching sides are planed. The second gate in the die is, of course, for the forming impression. The $\frac{5}{8}$ -inch hole shown in the front of the die-block is for the purpose of lifting the die; by placing therein a short bar of $\frac{5}{8}$ -inch rod, and another bar

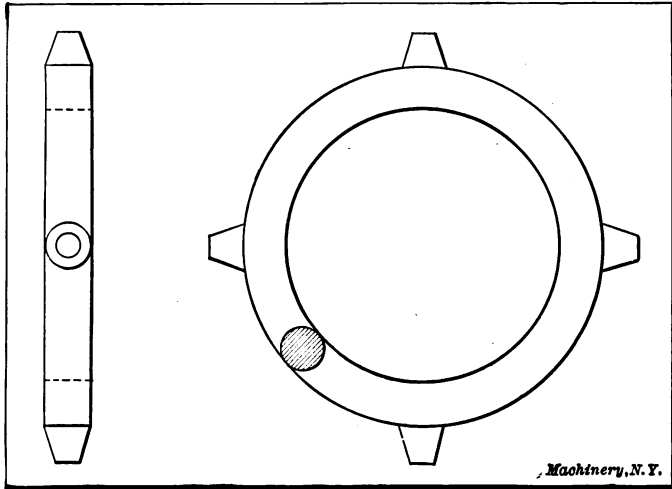

Fig. 28. A Forging for which the Die Impression should be milled and typed before Turning

in the hole on the opposite side, the block may be handled easily either by hand or with a chain fall.

Taking Leads or Impressions

For the purpose of seeing just how the forging will look when it comes from the dies, as well as to check up the shrinkage allowances and see if there are defective places in the impression, it is customary to take a lead proof from the finishing impressions of the upper and lower dies after they have been completed. Frequently the machinist would like to be able to use a "putting-on" tool in his work, especially after he has read his micrometers; with the die-sinker it is very easy to put on stock if the forging needs it, by simply making the dies a little larger at the desired point. A lead will show up any places on the forging that may need more stock; also, by weighing the lead, a good idea of the weight of the finished forging may be obtained.

Roughly speaking, the finished forging will weigh two-thirds as much as the lead proof. The shrinkage of lead is practically the same as that of steel, so that the finished forging will measure very nearly the same as the lead. In the case of dies for eye-bolts, etc., this rule

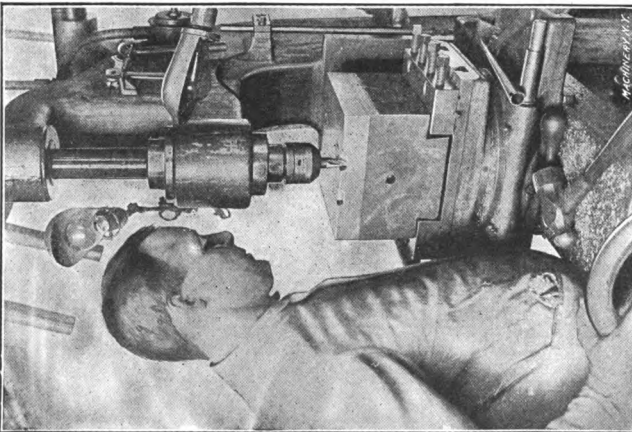

Fig. 24. Milling the Gate

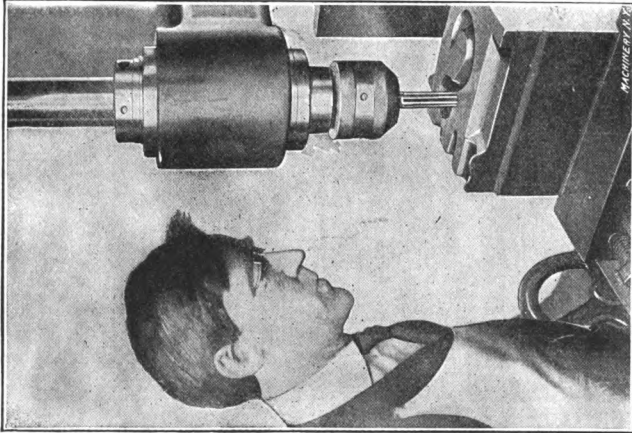

Fig. 25. Milling the Flash

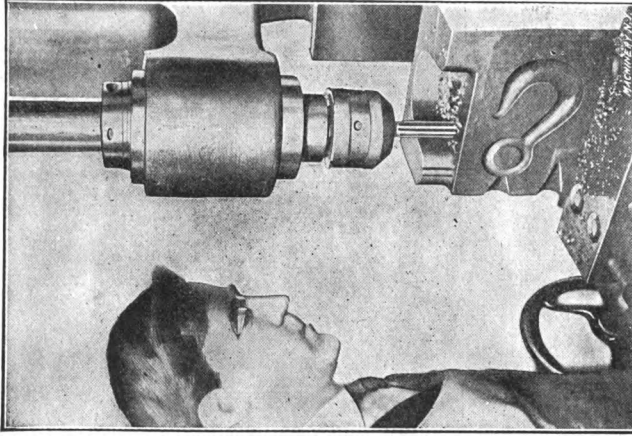

Fig. 26. Milling the Breakdown

must be disregarded, because the plugs in such dies that taken from the dies. Fig. 27 shows a group of leads from form the central openings will hold the lead from shrinking dies for eye-bolts, hooks, etc.

naturally, whereas the forging shrinks most after it has been In taking the lead, the impressions in both upper and

lower dies are cleaned out, dusted with powdered chalk, and the dies stood on end, after which the dies are clamped together with a large C-clamp, care being taken to have the matching sides perfectly in line with each other. The lead is now heated, care being taken not to burn it, and is poured slowly and evenly into the dies until it fills the impression and gate. As soon as the lead has cooled, the dies are unclamped, and the lead removed and examined. After making any changes that the lead shows to be necessary, another lead should be taken to make sure that the impressions are correct. Fig. 28 illustrates the method of pouring a lead.

The Flash

In theory, the amount of the forging metal in the die impression when struck should *just* fill the impression—no more and no less. This is, of course, impossible in practice, although the dies are made to come as near to this ideal as possible. As a matter of fact, there

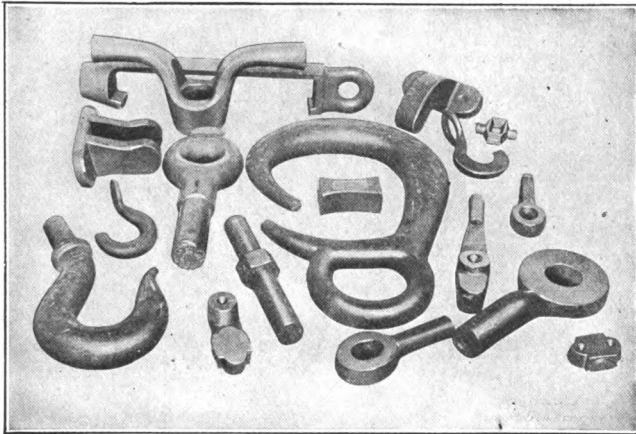

Fig. 27. A Group of Lead Proofs

is always some stock that must be disposed of, after the impression is full; but if the dies are well planned and the forging is well done, there will be but a small amount of extra metal, provided that the right size of stock is used. This excess stock that is squeezed out is called the "fln."

To take care of this metal that is crowded out of the impression, each die is relieved around the impression by milling a flat, shallow recess, about $1/64$ inch deep and $5/8$ inch in width all around the impression. These dimensions are for dies of average size; in larger dies, the recess or "flash" as it is called, would be a little deeper and wider. Both upper and lower dies are flashed in this manner. In addition, the upper die is back-flashed; that is to say, there is a deeper recess, sometimes called the "gutter," milled around the impression at a distance of $1/4$ inch from the impression at every point. This back-flash is $3/64$ inch deep, and acts as a relief for the excess metal after it has squeezed through the flash proper. Only the finishing

impression is provided with flash and back-flash. The fin is trimmed from the forging by means of trimming dies, when the forging is either hot or cold, depending on the size and shape. Fig. 25 shows the operation of milling the flash.

The relative positions of the flash and back-flash in regard to the impression itself are clearly shown on the wrench forging in Fig. 29,

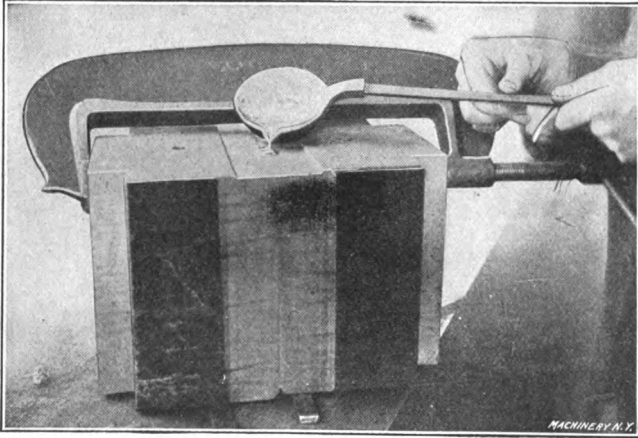

Fig. 28. Pouring a Lead Proof

and the sectional view of a pair of dies in Fig. 30. In Fig. 29, the fin has entirely filled the back-flash, as the two ridges at the sides of the wrench show. This indicates that the stock was a little too full, not being drawn small enough at this part of the forging. Fig. 30 illustrates the appearance of the flash in section, with the back-flash in the upper die. As before stated, the forming impression is not flashed.

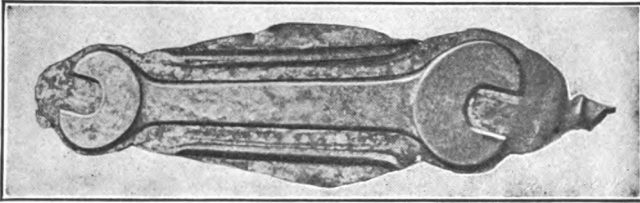

Fig. 29. A Forging showing the Effect of Flash and Back-flash

This set of dies was for forging a plain ring, and although a simple set of drop-forging dies, they illustrate a few points of interest.

The finishing impression is placed as near the center of the blocks as is practical, to secure the best effect of the blow, as well as for strength. The plugs that form the center of the ring are given a 10-degree bevel inside, while the rest of the impression has but 7 degrees. These plugs come within $\frac{1}{4}$ inch of meeting, and the forming impression has plugs that are well rounded over, to give them strength for the hard service that they receive, as well as to spread the stock. These plugs barely meet. The edges of this forming impression are

also rounded to give strength, and to prevent the formation of cold-shuts. In the finishing impression these corners are made nearly sharp, so as to finish the forging. The opening on the right is the breakdown or edger.

The Breakdown

One of the most baffling points of drop-forge die sinking, to the novice, is the planning and making of the breakdown, edger or side-cut. These three terms are identical in meaning and all three are in common use in various shops. In laying out the breakdown, there are many points to be considered that are obtained only through experience, and appreciation comes only after learning, but we can at least give our atten-

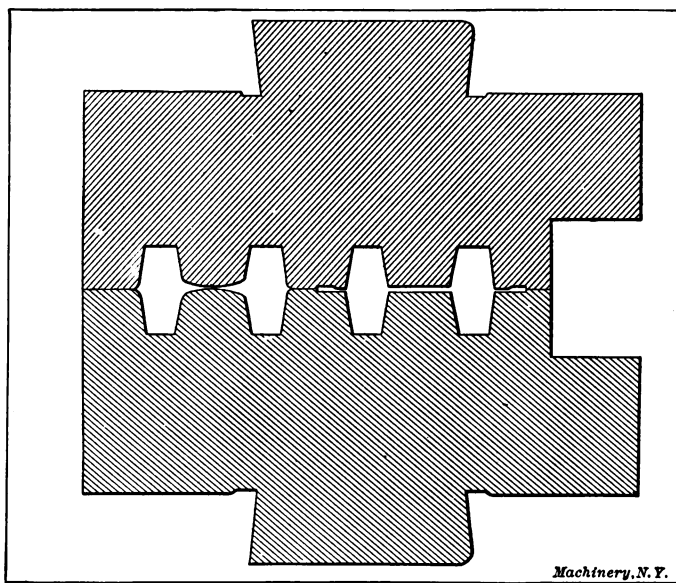

Fig. 30. Sectional View of a Pair of Drop-forging Dies, showing the Flash

tion to a few general principles that should be observed in this part of drop-forge die sinking.

After the face impressions are finished, and the flash, gate and sprue completed, the dies are clamped together just as they were for taking the lead. Next, the rough surfaces of the right-hand sides of the blocks are chalked. The reason for using the right-hand side of the dies for the breakdown, is to make the forging operation easier for the forger, as it is much easier to swing the bar on this side. A half-lead, or a templet of the forging, is then laid on the dies and the outline scribed. The location of this templet is important. If the piece is symmetrical, one-half of the outline should be on each die. If not, a parting line must be decided upon and the templet placed with this line even with the parting line of the two dies. A second line is next scribed $1/16$ inch inside of this outline in all places except the fol-

lowing: First, in all vertical places of the breakdown, the outline is given a draft of 7 degrees, part of which is marked outside the outline, and from that point running to the same distance within the outline at the bottom of the breakdown outline. Second, all right angles or abrupt bends should be well rounded off, so as to prevent the formation of cold-shuts. Fig. 31 illustrates a few templets and the breakdowns for the forgings, showing the points of difference between the templet outline and the breakdown outline.

The width of the section used as the breakdown should be sufficiently wider than the forging to give plenty of room for the work or forging. For a forging 1 inch thick, the edger should be $1\frac{1}{2}$ inch wide, and about the same proportions should be followed for forgings of other widths. At the rear end of the breakdown, a cut-off is pro-

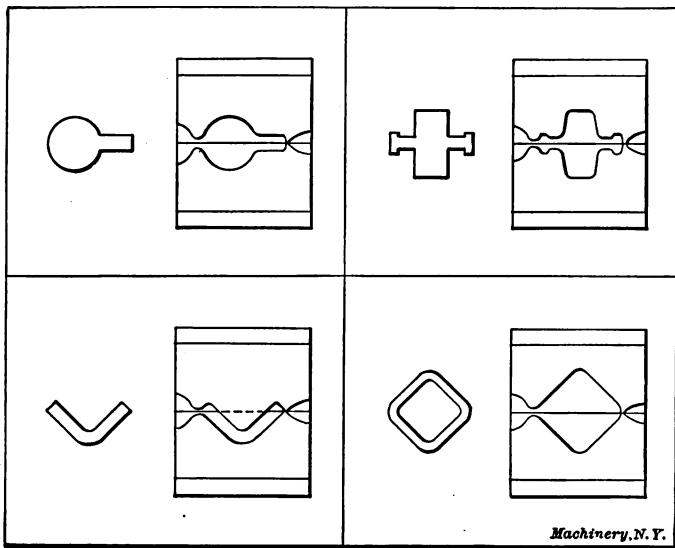

Fig. 31. Specimen Breakdown Lay-outs Compared with their Templets

vided to trim off any extra stock that has been drawn out on the anvil. Beyond this cut-off the die is cut away for clearance. The breakdown must be provided with a section that corresponds to the gate and sprue of the die impression, but it must be made slightly longer, so that the forging will not be stretched off when struck in the impression. This may be noticed on the die shown in Fig. 11 at the left-hand side. The breakdown will be at the right when the die is set up in the hammer, as this particular die is a top die.

The breakdown section should be a part of the die-block, and not bolted on the side as is sometimes done. There are cases where the breakdown must be a separate piece, but in nine out of ten dies, it is practicable to have the breakdown a part of the die-block. Sometimes it happens that the form of the edger or breakdown must extend above

the face of the die-block itself. If the amount of projection is not over 1 inch, the best way to accomplish this result is to plane away the rest of the face of the die, so as to leave the edger projecting. If the distance is greater than 1 inch, a separate piece may be dovetailed in and held in place by a pin driven through the edger and into the die-block. The inserted piece should be a force fit in the dovetailed recess in the die-block. The breakdown should never be built up with a piece bolted on the side of the block, for the bolts will jar loose or shear off. Generally speaking, it is poor practice to use screws for dies or attachments for a drop hammer on account of the vibration.

Fig. 26 shows the method of setting up the die-block in the die-sinking machine for the purpose of milling the breakdown. After the correct outline for the edger has been determined, the line should be scored plainly with a small chisel. The die-block is then held in the vise of the machine on its side, and with a long straight cutter the breakdown is gradually cut in to the line.

The cut-off connected with the breakdown section of the die should not be confused with the cut-off for severing the forgings from the bar when they are to be cold-trimmed. The cut-off on the breakdown merely cuts the stock to length after being drawn out on the anvil.

The Anvil

There is little to be said in regard to the anvil. The two fullers have slightly crowned faces and the corners are well rounded. Beyond these fullers, the die is milled away to clear the stock after it has been reduced, and to clear any large parts that must be left. The anvil is placed on the left-hand side of such dies as require it, and as has before been stated, its purpose is to reduce the stock for the thin sections of the forging. If a double-ended wrench is to be forged, like the one shown in Fig. 29, an anvil will be necessary to thin out the stock between the thick ends of the wrench, before striking it into the impression or edger of the die. If the thin part of the wrench is $\frac{1}{2}$ inch by 2 inches, the fullers would be left just 1 inch apart; that is, each face would be $\frac{1}{2}$ inch under the face of the die itself. Thus it will be seen that the fullers are to square the stock to the dimensions that will "fill" the die when struck in the impression. The forger draws out the stock under the anvil just as the blacksmith would under a trip hammer. About one-half of the drop-forging dies made require anvils in their make-up.

The Cut-off

Dies that are made for cold-trimmed forgings require a cut-off to cut the forgings from the bar after completion. This part of the die is usually placed across one of the two rear corners—wherever there is the most room. The cut-off is made by milling away the stock, so as to leave on each die corresponding chisel-like projections. These edges are not brought up sharp, but are left with a face of $\frac{1}{4}$ inch so as to hold up well in use. Only forgings that are to be cold-trimmed require this method of cutting off, but as most small forgings are cold-

trimmed, the cut-off is very commonly found on drop-forging dies.

Some die-sinkers prefer to cut a vertical channel into the sides of the dies, and set in steel sections that reach to the die-shoe, flush with the bottom of the die-block. In such cases these blades project from the sides of the dies for three or four inches. This method has the advantage of permitting new chisels to be inserted, in case of breakage—an advantage that obviates annealing, re-milling and then hardening the dies in case the cut-off gives out.

Hardening Drop-forge Dies

The hardening of drop-forge dies is an important part of the die making, and in small shops, it often falls to the lot of the die-sinker himself to attend to the hardening, or at least to oversee it. Dies that contain less than 60-point carbon must be packed in boxes with granulated raw bone, sealed air-tight and carbonized before hardening. Those open-hearth steel dies containing 60-point carbon or over, or those of tool steel, will harden without such preliminary treatment.

The Hardening Equipment

A good furnace for the hardening of drop-forge dies is the No. 2 Brown & Sharpe hardening and annealing furnace. Other makes may be just as efficient, but so many shops use this particular furnace for the work, that there is no doubt in this case.

The hardening tank should be about 4 feet square and 3 feet deep. The water supply should come in at the bottom, and the supply pipe should discharge upwards, so as to send a strong current toward the top of the tank. The overflow should be a 6-inch pipe opening from a point near the top of the tank. If dies must be hardened in a tank without circulation, a large wooden paddle must be used to agitate the brine during the hardening. The best method of securing a good supply of cold brine, is to have a small reservoir out-of-doors that is covered over and yet exposed to the air. From this cooling tank, the brine may be pumped to the hardening room, returning by the overflow to be cooled. Across the tank, about 12 inches from the top, two bars should be suspended, forming a support upon which to rest the dies while being hardened. The brine should be a 40 per cent solution, and in the absence of a hydrometer, salt should be added to the water until the brine will float a raw potato.

Packing and Heating

For heating, the dies are placed in cast-iron boxes, in the bottom of which two inches of burnt granulated bone has been placed. Cast-iron boxes are used because cast iron stands the heat well, and the boxes are easily made. The walls should be at least $\frac{1}{2}$ inch thick. Burnt granulated bone is merely the raw bone after it has been used for pack-hardening a number of times. Upon this 2-inch layer of burnt bone, the die is laid face down, and settled down so that the bone fills the impression and the entire top face. This layer of bone serves a double purpose, in that it prevents the formation of scale on the face of the die, and also does not allow the steel to decarbonize. Steel

heated in the open for any length of time will lose its carbon or a good part of it.

With the face of the die thus protected, the box, with the die, is placed into the furnace and heated slowly and evenly. This heating takes from six to eight hours, according to the size of the die-block. The proper heat for quenching a 60-point carbon die lies between 1425 F. and 1450 F. As the die is but partly covered, the heat may be seen at all times.

Quenching the Die

When the die has reached the hardening heat, the cast-iron box, with the die therein, should be taken to the hardening tank. Here the die is held by the shank and placed upon the spider within the tank. The water is turned on full force, striking against the face of the die and driving away any steam that would "pocket" in the impression if it were not for the force of the stream. If the steam were allowed to pocket in the impression, soft spots would be found on the face that would be detrimental to the life of the die. The supply valve is left wide open until the brine reaches half way to the top of the die; at this time the valve should be closed enough to keep the level of the brine at this point. As soon as the die has cooled sufficiently to allow the water to cling or remain at the corners of the top of the die, the shank of which has at this time changed to a dull red color, the die should be placed in a tank of oil and remain there until cold.

A kink in hardening that is worth noting is the method of keeping the die flat when it tends to "hump" up at the shank. The hardener has a short straightedge that he keeps laying on the shank to see if a hump is forming, and such a condition is very apt to arise when hardening large dies. As soon as he notices a perceptible hump, he takes a small hose and plays a stream of water upon the bulging point until it goes back into shape. Care must be taken not to continue this small stream too long, or the hump will be driven to the face. A slight hump on the shank (not over 1/32-inch) will not be objectionable, as this will leave the face of the die comparatively flat. This slight bulging shank may be surfaced or ground flat after the die is cold.

Tempering the Die

The operation of tempering the die is accomplished by drawing the die in a tank of oil. The oil should be brought to a temperature of 450 degrees F. and kept there long enough to insure the heat penetrating through the die. After removing from the oil, the corners of the die and the cut-off must be drawn to a purple color with the aid of a blow torch. The quickest way to do this part of the tempering is to polish off these places as soon as the die is taken from the oil tempering tank, and then apply the blow torch, making use of the heat that is already in the die. After the die is cold, the oil should be cleaned off as much as possible, and the impression polished out with emery and oil on the end of a stick. This final polishing completes the work of making the drop-forging die.

CHAPTER III

SPECIAL OPERATIONS IN DROP FORGE DIE-SINKING

In the first two chapters, the principles of making drop-forge dies were treated upon, covering all of the main operations of sinking the impressions in the dies. There are, however, many special operations that must be employed at times to correctly shape the impressions, and these are fully as essential to good die-sinking as are the rudiments of the trade.

Cherrying

In making the impression in a drop-forging die for producing forgings in a drop-forging die for producing forgings for valve stems or other forms in which each die will have at

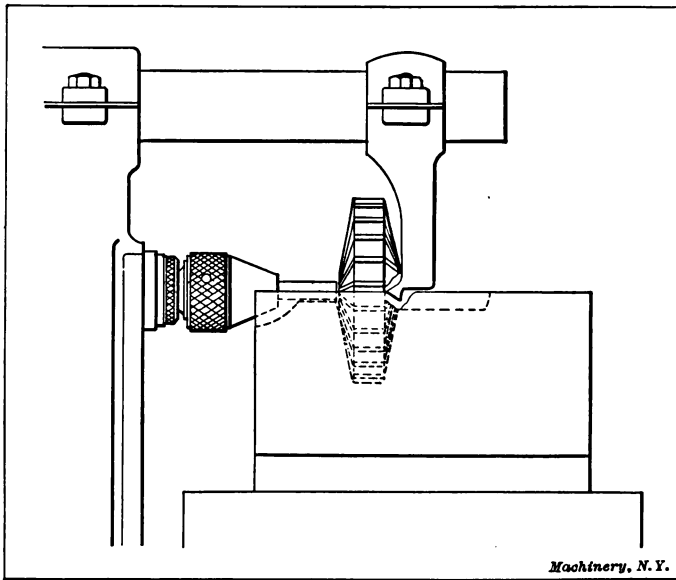

Fig. 82. Cherrying a Die on the Milling Machine

least one-half of its impression of the cylindrical shape, it is obvious that some means must be provided to sink a cutter into the die block to exactly one-half of its depth. There are several different methods of reaching this end, one of which is to use a special milling fixture in which the cutter is supported on a very short arbor and rotated by means of a raw hide pinion that meshes between the teeth of the cutter, this pinion being driven by the spindle of the milling machine. Of course, the bulk of the steel in the impression is roughed out in the

ordinary way before the special attachment and the finishing cutter are put into use.

Another method of sinking the cutter to one-half its depth is by the use of the method called "cherrying." Cherrying and cherries are terms somewhat unfamiliar to the general machinist and toolmaker. A cherry is a milling cutter, usually made integral with an arbor whose length varies with the requirements of the job to be done. The cherry is held in the spindle of the milling machine. The die to be cherried is roughed out on the die-sinking machine as nearly to size as possible and the sprue and gate cut. On dies that are to be cherried the sprue is made circular in shape so as to accommodate the shank of the cherry; that is, the impression in each of the two halves is semi-circular. Next, the die is mounted on the milling machine and the table raised to bring the cherry into the impression that has previously been roughed out. After the cherry has been carefully centered, the table

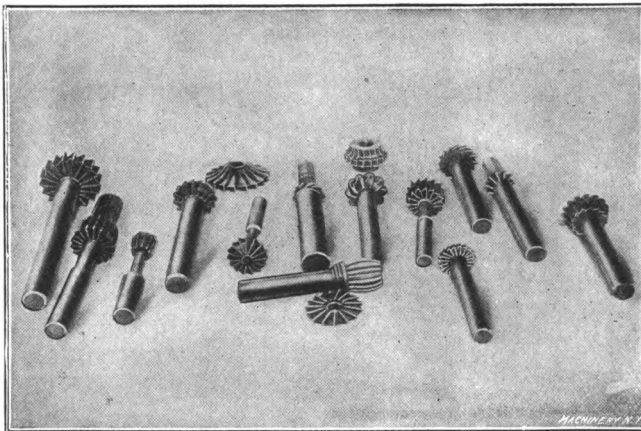

Fig. 33. Collection of Cherries used in Die-sinking

is raised to bring the cherry to the proper depth into the die, cutting very slowly on account of the large amount of cutting surface involved when the cherry is well into the die. When the impression is deep and is located at quite a distance from the front of the die block, the shank of the cherry must be long, and if the front end of the impression is shallow, the shank of the cherry will necessarily be small in diameter. In such cases, and in fact in all cases where possible, the cutting end of the cherry should be supported. This support consists of an arm, swung from the supporting arm of the milling machine. The cutting end of the cherry is deeply centered and the support consists of a very short center that is cut away to clear the rest of the die, substantially as shown in Fig. 32.

Fig. 33 shows a group of cherries used in different dies, as accumulated in doing general drop-forge die-sinking, these being of the average type. The operation of cherrying has been described in preference to some of the special milling fixtures, because it is the most common

method used in this connection. The special fixtures are not found in the majority of die-sinking departments, although the best-equipped shops employ them for special jobs that would be difficult to cherry.

Indicator Used in Making Deep Impressions

Fig. 34 shows a most interesting operation and the indicator used in connection therewith. This die is for making the sister hook illustrated in Fig. 40 and as may be seen, there is a very deep part of the impression used for forming the eye, that would be very difficult to mill out without the fixture shown in this illustration. The main rod of the fixture is screwed or clamped to the body of the die-sinking machine. This rod terminates in a ball and socket joint from which is supported a cross bar that holds the pointer of the indicator. The die in which the impression is to be milled is laid out as usual, and in addition, a line is scribed on the side of the die that indicates the

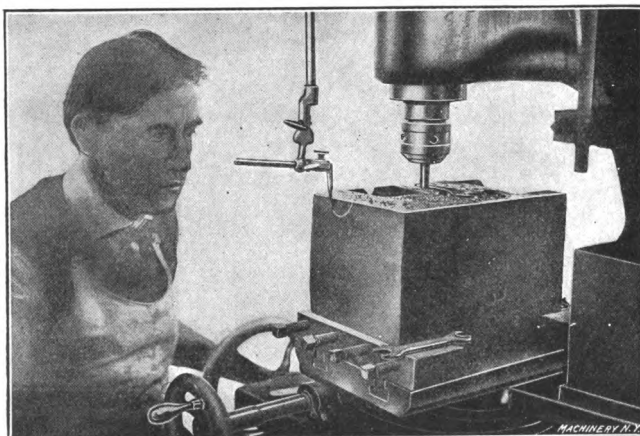

Fig. 34. Milling out a Deep Impression with the Aid of an Indicator

shape of the bottom of the impression, as projected from the impression that is to be cut. This line may be seen on the side of the die block that is shown on the machine in the illustration, Fig. 34. After the die has been set up on the die-sinking machine, a roughing cutter is held in the chuck and the table of the machine raised until the cutter just touches the top surface of the die. Next the indicator is adjusted so that the needle is on a line with the surface of the die and at the same part of the scribed outline on that side of the die that agrees with the position of the cutter within the outline of the die impression. With the cutter and indicator thus located, the impression may be roughed out, the die-sinker always keeping the needle of the indicator within the lines on the side of the die. After the die impression has been roughed out, a finishing cutter may be adjusted in the same manner as was the roughing cutter, and by carefully watching the indicator to see that the cutting is always within the scribed lines, the die may

be finished much quicker than would be possible without an attachment of this kind.

Cutter Milling Fixtures

The die-sinker uses so many special cutters in addition to the regular cutters, that it is essential that he be equipped to make cutters as expeditiously as possible, especially as it often happens that he must stop in the midst of the work of cutting the impression to replace a broken cutter or to make a new type of cutter. The cutter milling fixture shown in Fig. 35 is a great help in fluting all kinds of die-sinking cutters. As the illustration shows, it is merely a special form of index head, fitted with spring chucks to take the standard sizes of cutter shanks. The fixture is used on the die-sinking machine, using an end-mill for cutting the flutes. Both the fixture and its operation are so simple that a description is hardly necessary. The cutter blanks are turned up to the proper clearance angle and fluted while being held

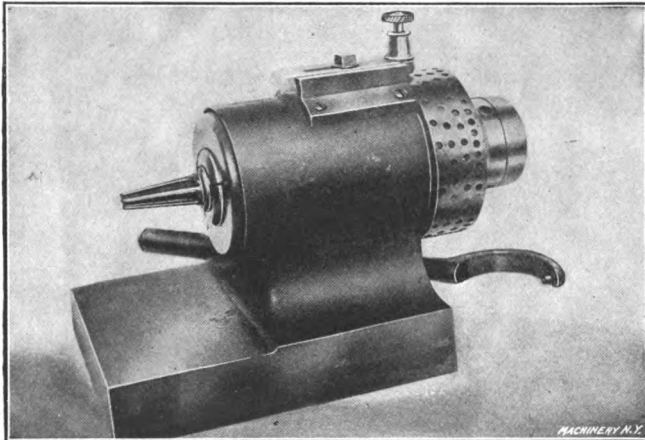

Fig. 35. Fixture for Fluting Cutters, used on the Die-sinking Machine

in the spring chuck of the fixture. The fixture is held in the vise of the die-sinking machine and the vise swung around enough to give the proper taper to the fluting out, which on a seven-degree cutter would be about five degrees. By means of the indexing arrangement at the back end of the fixture, the cutters may be given any number of flutes desired. It is only necessary to compare the time of setting up this fixture with the time of rigging up a horizontal miller for the job, to see where the advantage of this fluting method lies, especially when it is considered that this operation does not bring another machine into use.

Making Dies for Bronze and Copper Forgings

In making the dies for the production of drop forgings from bronze and copper, there are several points of the work that differ from the making of dies for steel or iron forgings. Foremost among these differences is the finish that must be given the dies. Copper, and bronze as

well, are much softer metals than iron or steel; consequently the metal is driven into every detail of the dies during the forging operation. On account of this fact, the dies must be perfectly free from scratches of any kind in order to obtain a copper or bronze forging with a smooth finish. This only means that extra care must be used in polishing out the dies both before and after hardening.

Forgings of copper and bronze are used for machine parts that would be liable to rust from the action of water and also in places that require a non-magnetic metal part. On account of their density they are tougher and harder than a casting of similar metal could possibly be. However, the hammering that is necessary to form such forgings is very hard on the dies, even though the metal being worked is soft. To prevent the dies from dishing or spreading, tool steel is nearly always used for the dies, unless the forgings to be produced are extra large and heavy. The shrink, draft and finish allowances on this class

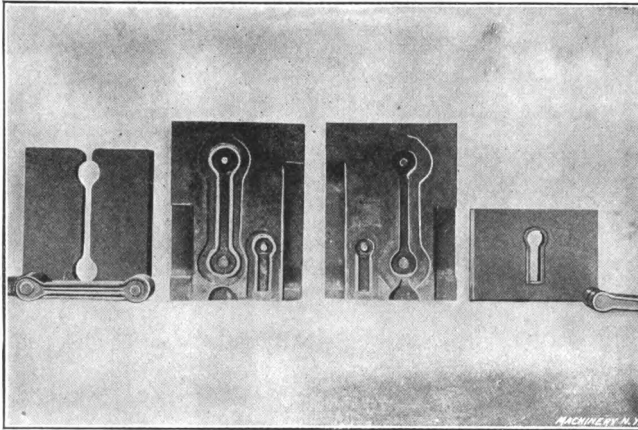

Fig. 36. Set of Dies for Drop-forging and Trimming Shackles and Pins

of drop-forge dies are practically the same as on dies for steel and iron. Bronze and copper forgings are trimmed the same as are forgings of iron and steel, but the dies must be kept sharp, in order to do good work; if allowed to become dull, the trimming will be ragged, leaving the forging with a rough surface on the edge.

Dies for Chain Shackles

In making the dies for drop-forging and trimming shackles for chains, we have a representative job of die-sinking, and in addition, there are several special points that are worth noting. Fig. 36 shows a set of dies for drop-forging and trimming a shackle and the pin used in connection therewith. The dies for the drop-forging are the pair in the center and the different parts of the die are well shown, the anvil, breakdown and the central impression. In addition, the impressions for the pin that is put through the shackle after it has been bent to shape, are included at the side of the central impression. The reason

for this is that the shackle pin impressions are so small that there is plenty of room for them without crowding the main impressions. Another reason, fully as important, is the fact that with every lot of shackles the same number of pins must be made, and by placing the pin impressions by the side of the shackle impressions, the job is set up and ready for use whenever the shackle dies are set up.

Fig. 37 shows the die-sinker starting to mill out the impressions in one of a pair of shackle dies. The system of lighting the work, when

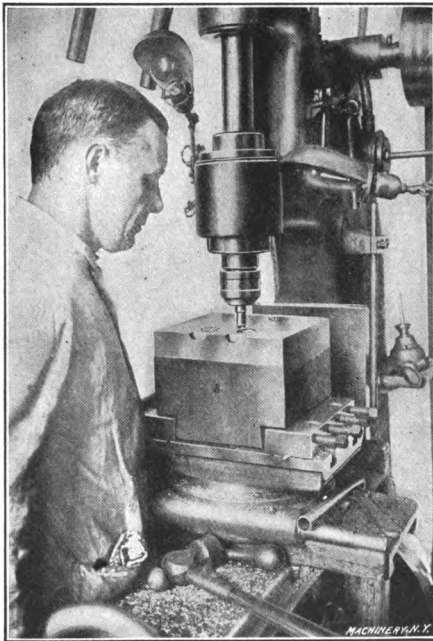

Fig. 37. Starting to Mill out a Drop-forged Die

artificial light is required, is indicated in the illustration where two adjustable incandescent lights are attached to the frame of the die-sinking machine. When these lights are swung down close to the cutter every detail of the cutting may be seen, for by the use of two lights, on opposite sides of the work, there is no shadow thrown on the die by the cutter.

The trimming dies for this job are interesting in that they illustrate both styles of dies, hot trimmers and cold trimmers. The die for trimming the shackles shown at the left of Fig. 36 is a hot trimmer, made in one piece. At the front is the punch for this die, recessed out to fit the forgings. The trimming die on

the right is a cold trimmer for the pin that goes through the shackle.

Connecting-rod Forging

In Fig. 33 is illustrated a forging for a connecting-rod that is shown as a further example of forgings for which the die impressions are best milled and typed for the irregular spots before the central hubs are cut. This illustration shows the finished connecting-rod. The parts that would require typing, are, of course, the projecting lugs through which the bolts pass. The forging for this connecting-rod would be solid at the two ends and into these open places in the impression the types would naturally slip, should the central opening of the impression be cut out before the projecting lugs were typed.

A Simple Set of Dies for Drop-forging a Thrust Collar

The thrust collar shown in Fig. 39 can be drop-forged in a pair of dies with but one impression. It would hardly seem possible to do this,

at first thought, but as a matter of fact, it is a practical piece of drop-forging. The secret of the success of this forging operation lies in the preparation of the stock from which the forging is to be made. The stock should be cut into blanks somewhat smaller in diameter than the greatest diameter of the forging and of such a thickness as will just give stock enough to fill the die, after allowing for a sprue

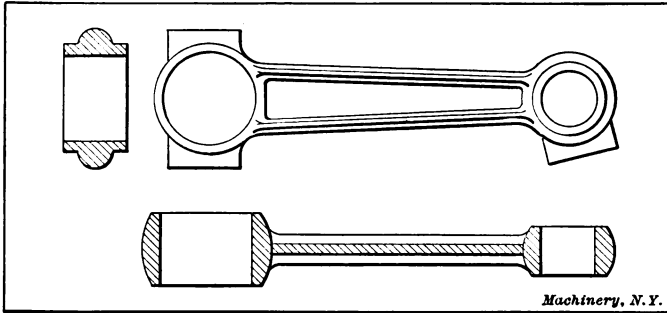

Fig. 38. Connecting-rod Forging, after Machining, to illustrate a Case where Parts of the Die Impression should be milled and typed before the Hub Impressions are milled

for handling the forging while being worked. The size of this blank can best be obtained by weight, the blank being two-thirds of the weight of the lead proof, after adding enough for the weight of the sprue and an allowance for the shrinkage of the steel in the fire from scaling,

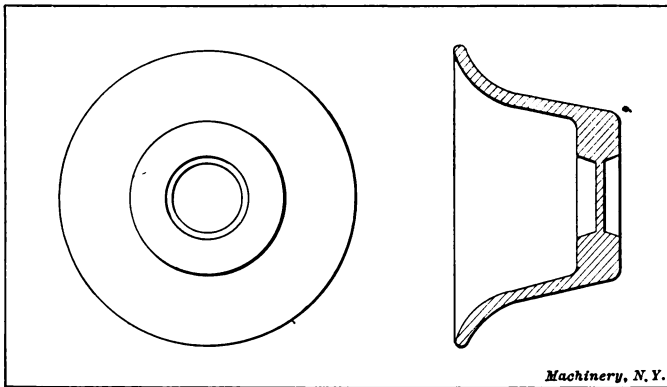

Fig. 39. Thrust Collar, made in a Pair of Dies with but One Set of Impressions; no Breakdown or Anvil required

etc. The corners of this blank are first hammered in and a short sprue drawn out under the hammer, after which the stock may be placed in the impression of the forging die and struck until full.

No breakdown or anvil are required with this set of dies and the central impression is designed so that the lower die will contain the cavity while the upper half will have the projecting plug. This arrangement is for the purpose of taking advantage of the "shooting up"

tendencies of the hot steel. For trimming the central web from the forging, a loose punch is used; that is, a punch that is not fastened in any way to the ram of the trimming press. The cutting end of this punch is made to the size that is wanted for the opening in the forging; back of the cutting edge, the stock is relieved to clear the forging when going through. When used, the punch is pushed through the forging, the punch dropping through the forging to the bolster, from whence it is taken and used again on the next forging. The trimming of this piece should be done hot, although if the central hole is small, that part of the trimming may be done cold. If the hole is trimmed hot, however, the dies will meet much more quickly, saving quite a little time in the forging operation.

Dies for Drop-forging Sister Hooks

Another interesting set of dies shown in Fig. 40, is for drop-forging sister hooks used in the United States Navy. The set consists of the

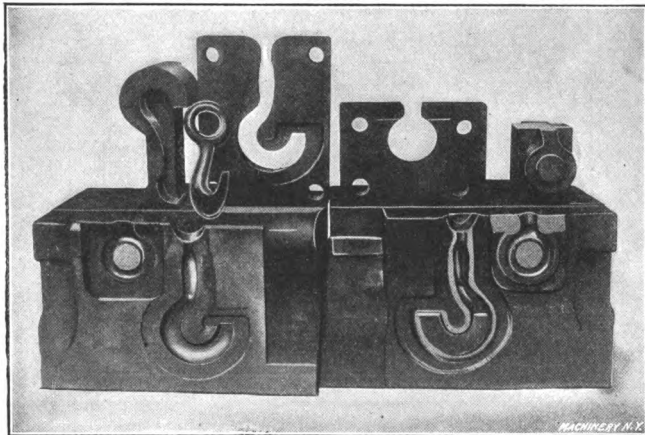

Fig. 40. Set of Dies for drop-forging and trimming Sister Hooks

two forging dies and the two pairs of trimming dies, one of which trims the hook end and the other takes care of the ring end of the sister hook. The center of the ring is trimmed by another die not shown. It is obvious that the entire forging could not be trimmed in one operation on account of the two different parting lines on the forging. It is also obvious that the shape of the forging makes it necessary to forge each end of the hook separately. To take care of this requirement, an additional set of impressions is cut in the dies to shape the ring at the end of the sister hook. This ring impression is gated the same as the main impression, but it is not used until after the front end of the hook has been completed and the forging with its unfinished ring end has been cut off from the bar. The forgings are made just as though the hook end were solid, being trimmed and cut from the bar, leaving the hook end in the shape of a flat disk. Then the ring ends of these semi-completed forgings are reheated and struck

in the second set of impressions at the front of the die. It will be noticed that these impressions are gated in such a manner that the hooks will not be crushed while being struck. The stock that is within the center of the ring is more than enough to form the outside in good shape, so no extra allowance need be made.

In the illustration, Fig. 40, the two trimming dies are shown placed on the top of the forging dies. These trimming dies are each made in two halves, being dowelled and screwed to bolsters while in use, a matter that will be more fully treated under the head of trimming dies. In this illustration will also be noticed the way in which trimming punches are cut away to properly support the forging during the trimming operation.

Dies for Upsetting Cam-shaft Forgings

The forging shown at *B*, Fig. 41, is for a cam shaft that is shown, after machining, at *C* in the same illustration. To produce this piece,

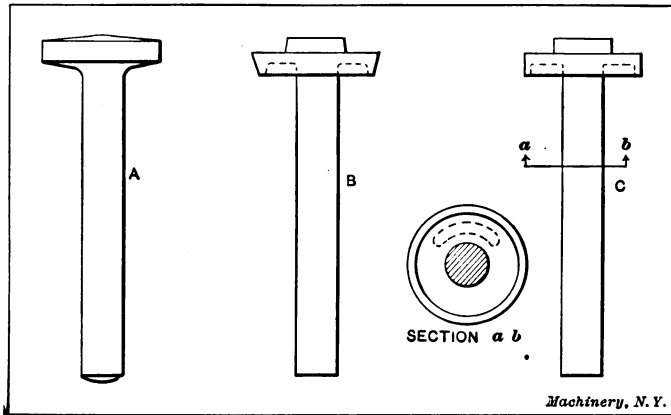

Fig. 41. The Operations of Making a Cam-shaft

a forging is made as shown at *A*, in the same illustration. This is done in a simple pair of dies, having half of the impression in each die. The forging is finished in the pair of dies shown in Fig. 42. A pair of dies of this design are known as "upsetting dies" and consist essentially of a recess to take care of the shank of the forging, confining it while a blow is struck to shape the head of the cam shaft in the impressions of the dies. Dies of this kind work after the manner of heading dies used in making rivets and screw blanks, except that they are not split for ejecting. The forging is forced from the die by means of a knock-out, as shown in the illustration. When the blow is struck, the knock-out pin is down, resting on the bottom of the die-shoe; after the striking is completed, the forger strikes the knock-out handle with a hand hammer, and the forging is ejected from the die. Ejection is made easier by the fact that the forging is losing heat all the time after the blows have been struck, consequently it is shrinking in diameter. Another precaution, taken to prevent the forging from

sticking in the die, is the practice of giving the recess a draft of one-half degree.

The impressions in the faces of the dies, in which the top of the forging is shaped, involve one feature that has not been touched upon before. Around the part of the lower die that contains the impression, the stock is turned down for about one-half inch, leaving the shoulder on a 15-degree bevel. To match this part, the upper die is recessed for the same distance and on the same bevel, thus forming a "lock" that insures the dies properly meeting within close limits of alignment. This particular lock, owing to its form, is called a circular lock. Circular locks are formed on dies that must produce forgings that are to be accurate to size, or of such a shape that there would be diffi-

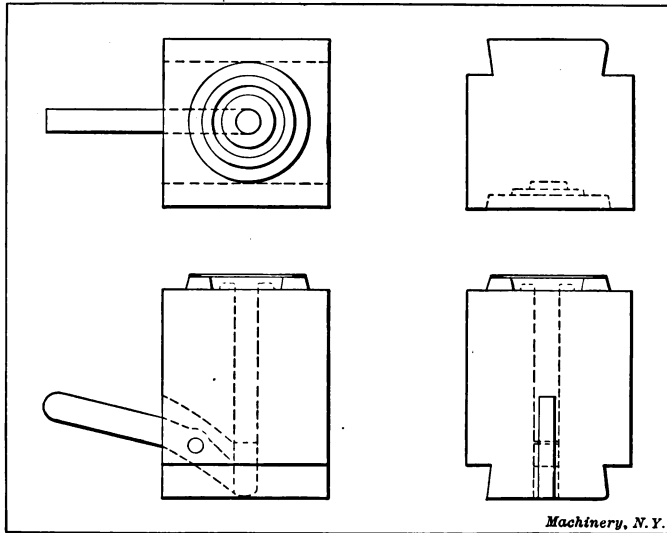

Fig. 42. Upsetting Die for the Second Operation in Forging the Cam-shaft

culty in setting the dies and holding them in proper alignment without such a help as the lock.

As to the impressions for shaping the top of this cam-shaft forging, there is nothing out of the ordinary about them. All parts are sunk with a seven-degree draft, including the sunken section for the outside of the cam. While being machined, these beveled sides are cut straight. The best method of cutting the arc impression for the cam is by the use of the circular attachment on the die-sinking machine.

A Lock Die for a Hinge

A difficult job of die-sinking is illustrated in the set of dies shown in Fig. 43. This set of dies is for drop-forging the heavy hinge shown on the top of the dies. At the right is the trimming die and punch. In these dies we have a good example of lock dies of another variety,

and a more complicated one as well. The forming impression and breakdown for this piece were cut in another set of die blocks, as the forging was too large to admit of the various impressions being placed on the same block. The finishing die shown is the most important and it will be noticed that the draft, flash, gate and sprue are just as much in evidence as they were in the straight type of die. In one of the dies may be noticed the cone-like projections for spotting the centers of holes that are afterwards to be drilled in the forging. The leaves of the hinge are inclined from the base at an angle of 70 degrees. If they were at right angles with the base, the forging of the piece would be simplified a great deal. The hot trimming die shown has its face cut to agree with the parting line of the forging dies, so that the fin will lie against the cutting edge of the die at all

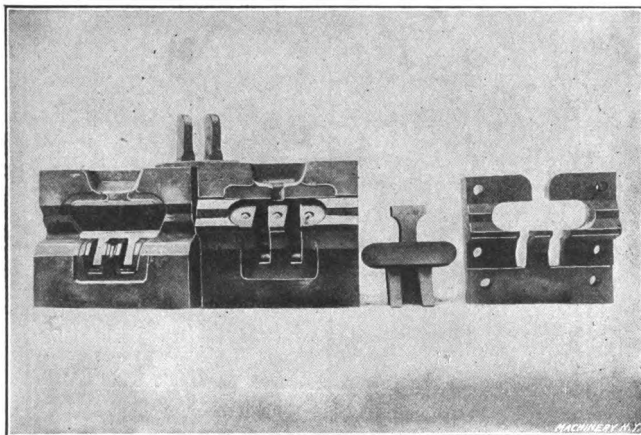

Fig. 49. Lock Dies for Forging and Trimming a Special Hinge

points. In cutting the deep parts of the impressions for the leaves of the hinge, the indicator previously described is a great help.

Dies for Making Extra Long Drop Forgings

An extra long forging cannot well be made in a die with one full length impression for several good reasons. First, the dies would be so large and heavy that the item of stock alone would be almost prohibitive, and second, such dies could only be used in an extra large hammer. The drawing in Fig. 44 shows the method of forging such awkward shaped pieces, taking for example a long heavy spanner wrench, three feet six inches in length. The impressions of each half of the wrench are cut side by side in the die blocks, keeping in from the edge of the die about one inch. At the halfway point where the two impressions leave off, square notches are cut nearly to the depth of the impressions; these notches are the key-note of the whole method of producing such forgings. They serve as locating points to start the forgings from and they will, in this particular die, prevent the metal from sliding forward when struck in the tapering impression for the

handle. As the steel fills these notches, it forms lugs on the forgings; these lugs fit into the notches in the second impression, thus locating the blank in the proper position. Some forgings would require breakdowns for each end of the piece when made in this manner, but this spanner wrench only requires a breakdown for the hook end. The horn, or bender, is dovetailed into the upper breakdown after the manner previously described.

Method of Forging Spanner Wrench of Very Large Dimensions

The method of forging the spanner wrench is as follows. Steel is used that is large enough to make the heavy end of the wrench. One forging is made complete, care being taken to note the length of the bar required to make the forging. After the proper length of the blank has been ascertained, the stock is cut to this size and the entire lot of forgings are made and trimmed on one end. The trimming dies

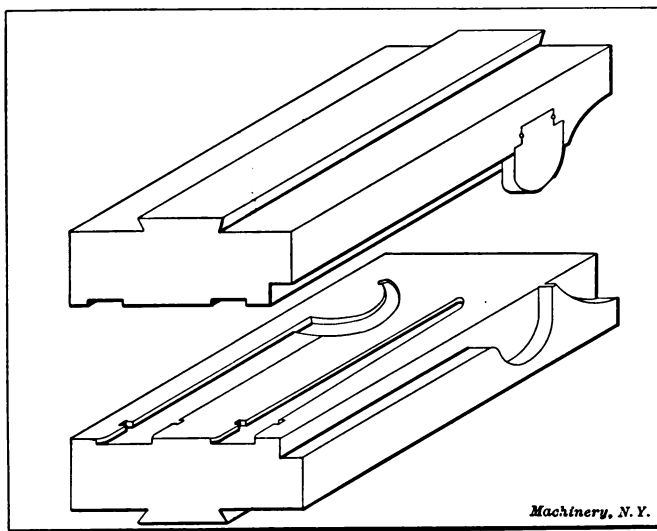

Fig. 44. Drop-forging Dies for Making a Long Forging by Halves, to Obviate the Necessity of Large Dies

for both ends are shown in Fig. 45. The stock for the handle end of the wrench is then drawn down and forged in the second set of impressions in the dies, using the lugs formed in the first operation as a guide to the proper location for the second operation. In turn, this small end is trimmed as was the forward end, and at last, when the forging is completed it is moved backward in the trimming die just enough to clip off the lugs on the sides and then struck once more in the dies to round the edges where the lugs were clipped off.

It often happens that the forging is of such a shape that no lugs are required to locate the forging in the second impression. A boss, hub or other projection, either vertical or lateral, does just as well as the

lugs just described. With care in the forging, it is possible to make drop forgings of this character within 1/32-inch limits of variation in length.

Trimming Dies

All drop forgings require trimming after the forging proper is done. The ideal forging comes from the dies with a small amount of fin evenly distributed all around the forging, at the parting line. In many ways the fin is to be desired, provided it is uniform. Its presence denotes that the dies are "full" in every respect and after being trimmed, the forging is sure to present a clean edge with all traces of the parting line removed. At the time of the trimming operation, a good part of the draft that has been given the forging may be trimmed off in case it is detrimental to the finished product.

Trimming dies are of two general classes, called hot-trimming dies and cold-trimming dies, according to the condition the forgings are in when trimmed. These two classes differ materially in their design

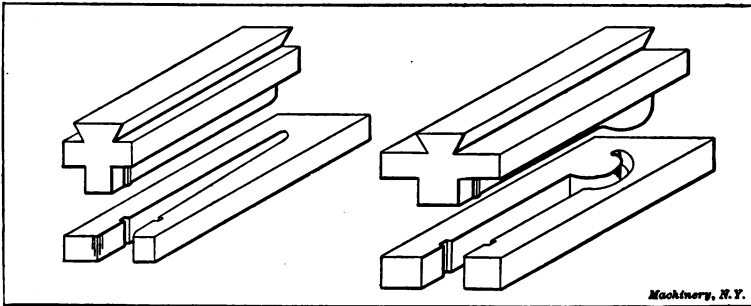

Fig. 45. Trimming Dies for Long Forgings made in Halves

and in the steel from which they are made, although the die-making operations are similar.

Hot trimmers, as they are called in the shop, trim the fin from the forging while the forging is being made. Fig. 46 illustrates a plain hot-trimming die and punch. Generally, the forging is practically completed, then trimmed and struck again to correct any twists or distortions due to the trimming as well as to bring the edges up sharp and size the forging. In the case of a piece having a large displacement of stock, there is apt to be more fin than in a uniform piece; consequently if this fin is trimmed out of the way just before the forging is finished, it is obvious that the dies will have a better effect upon the forging while striking the finishing blows. Most forgings of the medium and larger classes are hot trimmed.

Cold trimmers must do a great deal harder work than the hot trimmers, and for this reason they are made from high carbon steel and hardened the same as any blanking die. Forgings that are to be cold trimmed are severed from the bar when finished, with the fin un-

trimmed, and run through the trimming die when cold. Thus it will be seen that to trim other than small forgings in this manner, would be too great a strain upon both punch and die.

Hot-trimming Dies

There is a special grade of steel, commonly known as hot-trimming die-stock, that is used exclusively for making hot-trimming dies. The objection to using ordinary tool steel for hot-trimming dies is that the edges of the hardened die check very badly after the die has been in use for a short time. Checking is followed by breaking away of the steel around the edges, rendering the die unfit for use. This special grade of steel, used for hot trimmers, requires no hardening, and after the die has been put into use, the edges toughen up and give better service than the best hardened tool steel could possibly do.

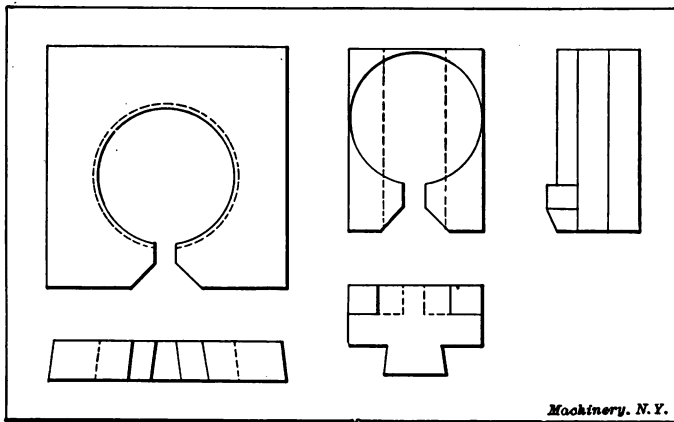

Fig. 46. Illustrating a Plain Hot-trimming Die and Punch

Hot-trimming dies, as well as cold-trimming dies, are made either solid or in sections, of which there may be two, three or even more. If the piece to be trimmed is a plain, regular shape, the die is best made in one piece, and at the other extreme, if the forging is a difficult one to trim, the die is built up of two or more pieces; the die construction is a matter to be decided by the die maker. Naturally a one-piece die is much easier to handle in setting up, etc., but a die of two or three sections has the advantage of being more easily sharpened and closed in whenever necessary. Fig. 47 shows the general idea of hot-trimming dies of one and two sections, and a cold trimmer in three sections. As shown, the different sections are properly located by means of dowels set between the sections. A die made in sections must have a special bolster on which the parts are mounted, while a one-piece trimmer can be mounted on a bolster that is used for other trimming dies.

The main difference in the appearance of hot- and cold-trimmers lies in the fact that the hot-trimmers are left open in the front, while

cold-trimmers have no openings of this kind. The opening in a hot-trimming die is for the purpose of clearing the sprue that connects the forging to the bar, otherwise the forging would be severed from the bar at the first trimming operation. As hot-trimmed forgings are trimmed two or three times in the forging operation, it is of course, necessary that the forging should remain intact with the bar until it is finished. The trimming die is made to trim the sprue section as well as the forging itself. After the forging is completed, it is cut off at the sprue by means of the special cut-off on the side of the trimming press. The opening at the front is cut clear through the thickness of the die stock, and there must be a corresponding opening through the bolster, so that the forgings may be carried

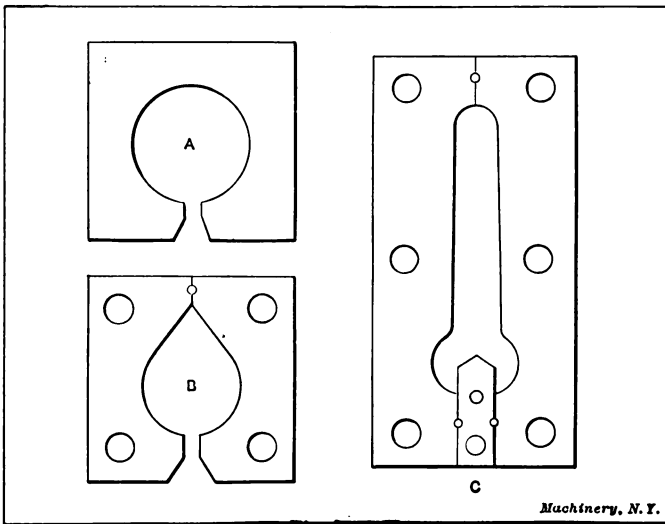

Fig. 47. Trimming Dies: A, One-piece Hot-trimmer; B, Two-piece Hot-trimmer; and C, Three-piece Cold-trimmer

through the die and bolster after trimming and taken out from beneath. The die shoe is made with an open space in the center beneath the die and bolster; therefore when the forging is trimmed, it drops through the die and bolster into this open space and is drawn out through the front of the shoe, still intact with the rest of the bar of steel. The positions of the die, bolster and shoe are graphically shown in Fig. 48.

Making a Hot-trimming Die

In making a hot-trimming die, the templet used in laying out the outline for the impression in the drop-forging dies comes into use again, for with it the trimming die may be laid out. The shrinkage allowances in this case are correct, being the same in the trimming dies as they were in the forging die. In connection with the templet, a half-lead should be taken from the forging dies, using the top die for

the purpose. A half-lead is easily taken by standing the die on end and clamping a piece of steel or iron over its face, and pouring the molten lead in the ordinary manner. This half-lead must be replaced in the impression after pouring, and the edges peened out to fill the impression when it is cold, for the shrinkage spoils it for use as a templet without this peening. The reason for taking this lead from the top die is that the forging is usually laid in the trimming die with the same side up as in the forging die, so as to be convenient for the forger. Using the lead from the top die as a templet will give the trimming die the proper outline to agree with the forging die without reversing. Another reason for using the top half of the lead, is due to the fact that it is easier to fit the die to the top half-lead than the bottom half-lead. The die is tried by pushing the lead up through the back side of the die at intervals during the filing. It is obvious, therefore, that the impression side of the top lead will show up the places in the die that must be filed out, far more clearly than

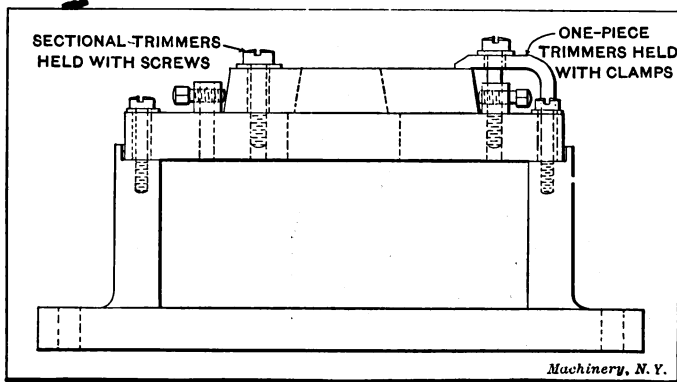

Fig. 48. Showing Method of Mounting a Trimming Die on the Bolster and Shoe

would the flat side of the bottom half-lead, in case it were used.

After the die has been laid out and the outline lightly prick-punched, a row of holes is laid out, the edges of which just clear each other and the outline of the die opening. The size of these holes is dependent upon the size of the die to be made; but for other than small dies, one-half inch is a good size for the holes. After these holes are drilled, the central core may be knocked out and the die is ready for milling.

Fig. 49 illustrates the operation of milling out a trimming die. The die is set up in the vise of the die-sinking machine and a stiff, straight cutter is held in the chuck. With this cutter the die is milled up to the scribed outline, cutting away the rough stock left by the drilling operation. The cutting section of this cutter should be long enough to extend through the entire thickness of the die. After the opening is roughed out, the straight cutter should be replaced by a three-degree cutter that is made with the larger diameter at the bottom. With this cutter the stock may be taken out just to the line. Next, the

die should be turned bottom side up in the vise, and a four-degree cutter of the regular die-sinking type placed in the cutter chuck. This cutter should be entered into the opening in the die to within $7/16$ -inch of the face of the die (which is now at the bottom), and a clearance milled all around the opening, about as shown at Fig. 50. As this illustration shows, this method of putting in the clearance leaves a sort of shelf about one-third the distance from the face of the die to the bottom. Trimming dies are, on an average, $1\frac{1}{2}$ -inch thick; therefore, with the above clearance, there will be less than $\frac{1}{2}$ inch to file at those points and corners that require filing.

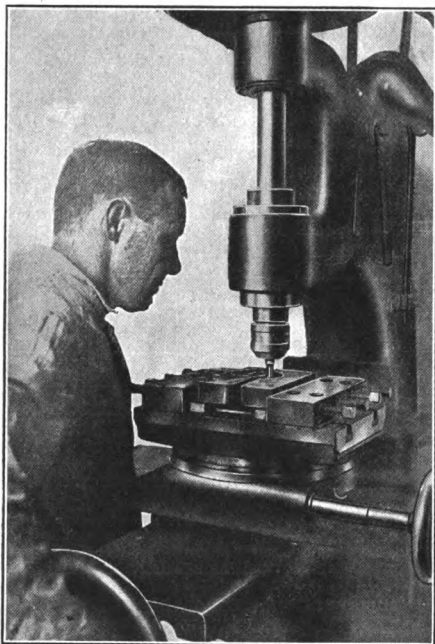

Fig. 49. Milling out a Trimming Die

Should the die be composed of more than one piece, the sections must be fitted and dowelled for alignment before drilling or milling, after which they may be clamped together in the vise of the die-sinking machine just as though they were one piece and treated that way during the milling operations. After the milling has been completed, some filing will be necessary to smooth up the cutting edge and to clean out any corners or angles that could not be milled. For a one-piece die, no holes are required to hold the die to the bolster, as that feature is taken care of by the clamps and side screws with which the bolster is supplied; this feature is illustrated in Fig. 48. This style of bolster is

used only with one-piece trimmers. If the trimmer is made up of more than one piece, the parts must be screwed and dowelled to the bolster.

Punches for Hot-trimming Dies

The general idea of a punch for a hot-trimming die is not to cut, but to support the forging while it is being pushed through the die. If the forging has a broad flat top face, the trimming punch need be little more than a flat punch that covers the top of the forging and acts as a "pusher" without regard to the size of the die itself. Such punches are commonly made of cast iron, and for wrench forgings and other flat work, especially of the larger class, they answer the purpose as well as a steel punch. A wood pattern is usually made,

and the casting from it will require little machining before it is ready for use. If the forging is of a round section, the punch must be hollowed out to fit the top face of the piece. There is but one part of the forging where the punch should fit fairly well, and that is the sprue section, for unless this part is fitted close, it will bend up and make extra work for the forger. On the other parts of the die it is an advantage to have the punch fit the die very loosely, so that the fin will not stick to the punch during the trimming. Punches for hot trimming are not usually hardened. They are held in the ram of the trimming press by means of a taper shank and key.

Cold-trimming Dies

Cold-trimming dies are made from good tool steel, 100- to 125-point carbon, and after making are hardened and drawn to a dark straw color. The machine operations in the making are the same as with the hot-trimmers except that the opening at the front is omitted because the forgings are not trimmed until they have left the forging press, and are cut from the bar at the sprue. Although trimming

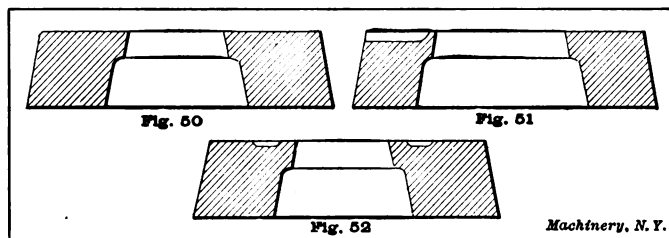

Fig. 50. Section of Trimming Die to show the Clearance given to the Cutting Edge. Fig. 51. Section of Cold-trimmer to show Method of Cutting away a Space at the Front to clear Rough Sprues. Fig. 52. Section of Trimming Die to show Channel Cut around the Die-opening to accommodate Forgings that must be trimmed wrong-side up

dies for cold work are not made with an opening in the front, there is usually a shallow space cut away just outside of the cutting edge at the front of the die to clear the ragged end of the sprue that is necessarily left after the forging is severed in the cut-off of a pair of drop-forging dies. This clearance appears about as shown in the illustration Fig. 51.

In laying out the cold trimmer for a drop forging, the shrinkage problem comes up again. One of the best methods of obtaining the outline, is to measure with a shrink-rule the templet that was used in laying out the drop-forging dies, and to make the outline of the trimming die to these dimensions as read from a standard rule. In making a cold-trimming die, it is a wise plan to first trim up one of the forgings by hand and then to keep away from the lines of the trimming die until it is sure that they are going to be correct for the actual forging. With this precaution it will be easier to fit the forging closer, for there is always a little uncertainty due to the difference in shrinkage arising from the use of the different steels from which the forgings are made.

The average thickness of trimming dies lies between one and two inches, probably being nearer the one-inch limit on small and medium work. In the case of lock dies, the thickness will depend upon the amount of irregularity caused by the parting line of the forging dies. The surfaces of some cold-trimming dies are cut away to within $\frac{1}{4}$ inch of the cutting edges of the dies. The reason for this is that on account of their shape, it is often advisable to trim some forgings in the opposite direction to that in which they were forged. This is not often necessary, but when it is, the trimmer must be cut away to clear the backflash that is left on the upper side of most fins. Such a trimming die is shown in Fig. 52. On account of the fact that in drop forging the steel is more easily forced up than down, into the dies, high projections would be in the upper dies, but it would be

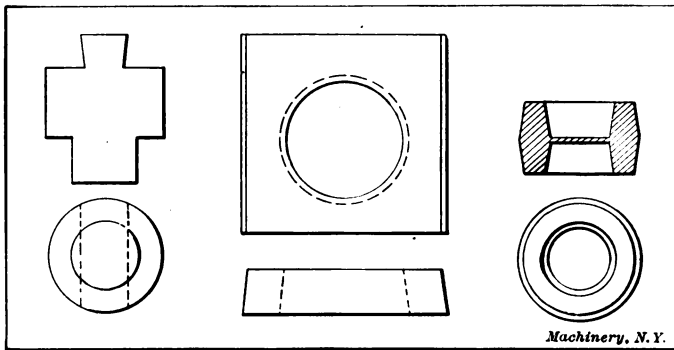

Fig. 53. Trimming Inside and Outside of a Ring Forging at the same Time

rather awkward to trim such forgings from this direction. For this reason the die is cut away as shown and the forging trimmed in the opposite way.

Punches for Cold-trimming Dies

The punches for cold-trimmers are made from tool steel, and are hardened and drawn to a very dark straw color. These punches are not hardened to make them cut better, but to prevent them from upsetting at the edges. As with hot-trimming punches, the punch should fit the die loosely, but it should support the forging at every point while it is being pushed through the die.

There are two cases in which trimming punches must fit the dies as closely as the average blanking die for sheet metal work. One case is in trimming forgings on which the fin comes at the corner of the forging and the other case is similar, being on forgings that are formed all in one die, having the other die flat. Unless the dies fit fairly well, burrs will result at the trimmed edges of such forgings.

Trimming a Ring Forging

Fig. 53 shows a trimming die that trims the inside and outside of a ring forging at one operation. The die is a hot-trimmer and made

to fit the outside edge of the ring. The punch is made with a pilot punch that just fits the inside of the ring at the parting line, while the shoulder that pushes the fin off from the outside edge of the forging, is left far enough from the face of the pilot punch to allow the center web to be cut out before the shoulder strikes the top face of the ring. The forging is laid in the trimming die, and the punch comes down and cuts out the central web before the shoulder of the punch reaches the top face of the ring. As soon as enough pressure is brought upon the top of the ring, the outside fin and the sprue are trimmed off. With this style of a punch and die, it is best

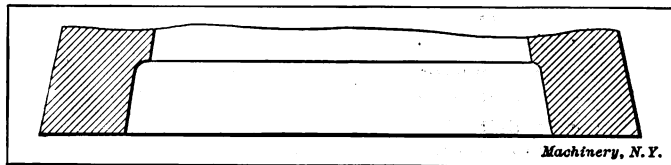

Fig. 54. The Way in which Long Trimming Dies are Sheared

to trim the outside very close, cutting off some of the draft so as to give more support to the punch while trimming the inside fin. The die will not require a stripper as might be supposed, for the inside punch will strip itself owing to the fact that it cannot draw the forging back through the trimming die. The inside punch should be

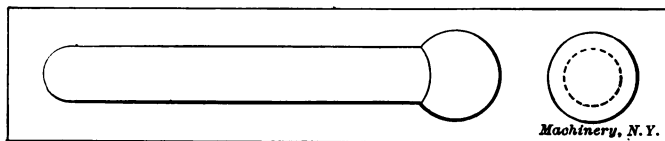

Fig. 55. A Difficult Forging to trim because of its Tendency to roll

no longer than necessary and should have a very slight taper toward the cutting edge.

General Notes on Trimming Dies

Trimming dies for forgings that are very irregular in shape, having been forged in lock dies, must have the surface of the trimming die, whether a hot- or cold-trimmer, shaped to agree with the face of the drop-forging die. The reason for this is very apparent, the object being to prevent the bending of the forging while being trimmed. A good example of this point is shown in the trimming and forging dies illustrated in Fig. 43.

Forgings that are to be cold trimmed should be pickled in a weak solution of sulphuric acid to remove the scale formed in the forging operation; by so doing, the dies will last much longer, saving the cutting edge from the hard scale that otherwise would have to be cut in trimming the forging.

A particularly difficult piece to trim is shown in the illustration Fig. 55. The difficulty lies in the tendency of the forging to roll in

the dies while being trimmed. If the forging is matched this tendency will be reduced, but even then, if conditions are not of the best, the forging will not trim well. One way of helping to overcome this rolling tendency, is to roughen the surface of the punch where it comes in contact with the forging. This causes the punch to grip the surface of the forging, but it also tends to mar the forging.

If the outline of the forging to be trimmed is long, or of a large perimeter, it will be a good plan to shear the die. Fig. 54 shows the method of shearing a trimming die by grinding hollows in its surface at intervals. This, of course, lessens the force required for the trimming or rather it divides the work of trimming, whereas in the case of a straight die, the trimming must be all concentrated into one stage of the blow.

By making the trimming die slightly smaller than the outline of the die impression, it is possible to trim off some of the draft that was given the forging in the dies. The appearance of this bevelled edge of the forging is often considered objectionable and by making the trimming die small, most of the draft may be shaved off.

Theoretical Mechanics

Reference Series No. 5. FIRST PRINCIPLES OF THEORETICAL MECHANICS.

Reference Series No. 19. USE OF FORMULAS IN MECHANICS.

Gearing

Reference Series No. 15. SPUR GEARING.

Reference Series No. 37. BEVEL GEARING.

Reference Series No. 1. WORM GEARING.

Reference Series No. 20. SPIRAL GEARING.

Data Sheet Series No. 5. SPUR GEARING. General reference book containing tables and formulas.

Data Sheet Series No. 6. BEVEL, SPIRAL AND WORM GEARING. General reference book containing tables and formulas.

General Machine Design

Reference Series No. 9. DESIGNING AND CUTTING CAMS.

Reference Series No. 11. BEARINGS.

Reference Series No. 56. BALL BEARINGS.

Reference Series No. 58. HELICAL AND ELLIPTIC SPRINGS.

Reference Series No. 17. STRENGTH OF CYLINDERS.

Reference Series No. 22. CALCULATIONS OF ELEMENTS OF MACHINE DESIGN.

Reference Series No. 24. EXAMPLES OF CALCULATING DESIGNS.

Reference Series No. 40. FLY-WHEELS.

Data Sheet Series No. 7. SHAFTING, KEYS AND KEYWAYS.

Data Sheet Series No. 8. BEARINGS, COUPLINGS, CLUTCHES, CRANE CHAIN AND HOOKS.

Data Sheet Series No. 9. SPRINGS, SLIDES AND MACHINE DETAILS.

Data Sheet Series No. 19. BELT, ROPE AND CHAIN DRIVES.

Machine Tool Design

Reference Series No. 14. DETAILS OF MACHINE TOOL DESIGN.

Reference Series No. 16. MACHINE TOOL DRIVES.

Crane Design

Reference Series No. 23. THEORY OF CRANE DESIGN.

Reference Series No. 47. DESIGN OF ELECTRIC OVERHEAD CRANES.

Reference Series No. 49. GIRDERS FOR ELECTRIC OVERHEAD CRANES.

Steam and Gas Engine Design

Reference Series Nos. 67 to 72, inclusive. STEAM BOILERS, ENGINES, TURBINES AND ACCESSORIES.

Data Sheet Series No. 15. HEAT, STEAM, STEAM AND GAS ENGINES.

Data Sheet Series No. 13. BOILERS AND CHIMNEYS.

Reference Series No. 65. FORMULAS AND CONSTANTS FOR GAS ENGINE DESIGN.

Special Course in Locomotive Design
Reference Series No. 27. BOILERS, CYLINDERS, THROTTLE VALVE, PISTON AND PISTON ROD.

Reference Series No. 28. THEORY AND DESIGN OF STEPHENSON AND WAL-SCHAERTS VALVE MOTION.

Reference Series No. 29. SMOKE-BOX, FRAMES AND DRIVING MACHINERY.

Reference Series No. 30. SPRINGS, TRUCKS, CAB AND TENDER.

Data Sheet Series No. 14. LOCOMOTIVE AND RAILWAY DATA.

Dynamos and Motors

Reference Series No. 34. CARE AND REPAIR OF DYNAMOS AND MOTORS.

Data Sheet Series No. 26. WIRING DIAGRAMS, HEATING AND VENTILATION, AND MISCELLANEOUS TABLES.

Reference Series Nos. 73 to 78, inclusive. PRINCIPLES AND APPLICATIONS OF ELECTRICITY.

Heating and Ventilation

Reference Series No. 39. FANS, VENTILATION AND HEATING.

Reference Series No. 66. HEATING AND VENTILATING SHOPS AND OFFICES.

Data Sheet Series No. 20. WIRING DIAGRAMS, HEATING AND VENTILATION, AND MISCELLANEOUS TABLES.

Iron and Steel

Reference Series No. 36. IRON AND STEEL.

Reference Series No. 62. TESTING THE HARDNESS AND DURABILITY OF METALS.

General Reference Books

Reference Series No. 35. TABLES AND FORMULAS FOR SHOP AND DRAFTING-ROOM.

Data Sheet Series No. 12. PIPE AND PIPE FITTINGS.

Data Sheet Series No. 17. MECHANICS AND STRENGTH OF MATERIALS.

Data Sheet Series No. 18. BEAM FORMULAS AND STRUCTURAL DESIGN.

Data Sheet Series No. 20. WIRING DIAGRAMS, HEATING AND VENTILATION AND MISCELLANEOUS TABLES.

