

# MACHINERY'S REFERENCE SERIES

EACH NUMBER IS ONE UNIT IN A COMPLETE LIBRARY OF  
MACHINE DESIGN AND SHOP PRACTICE REVISED AND  
REPUBLISHED FROM MACHINERY

NUMBER 113

## BOLT, NUT AND RIVET FORGING

By DOUGLAS T. HAMILTON

### CONTENTS

<b>Bolt Heading Machines</b>	- - - - -	<b>3</b>
<b>Continuous-Motion Bolt and Rivet Headers</b>	- - - - -	<b>20</b>
<b>Nut Forging Machines</b>	- - - - -	<b>31</b>

McGraw-Hill Industrial Press, Publishers of MACHINERY,  
370 West 32nd Street, New York City



## CHAPTER I

### BOLT HEADING MACHINES

The bolt and nut industry in America started in a very small way in Marion, Conn., in 1818. In that year Micah Rugg, a country blacksmith, made bolts by the forging process. The first machine used for this purpose was a device known as a heading block, which was operated by a foot treadle and a connecting lever. The connecting lever held the blank while it was being driven down into the impression in the heading block by a hammer. The square iron from which the bolt was made was first rounded, so that it could be admitted into the block. At first Rugg only made bolts to order, and charged at the rate of sixteen cents a piece. This industry developed very slowly until 1839, when Rugg went into partnership with Martin Barnes; together they built the first exclusive bolt and nut factory in the United States in Marion, Conn. The bolt and nut industry was started in England in 1838 by Thomas Oliver, of Darlston, Staffordshire. His machine was built on a somewhat different plan from that of Rugg's, but no doubt was a further development of the first machine; Oliver's machine was known as the "English Oliver."

As is generally the case with a new industry, the methods and machines used were very carefully guarded from the public, and this characteristic seems to have followed this industry down to the present time, judging by the scarcity of information available on the subject. Some idea of the methods which were at first employed to retain all information in the factory in which it was originated is well brought out by the following instance: In 1842, when the industry was beginning to be generally known, it is stated that a Mr. Clark, who at that time owned a bolt and nut factory in New England, and had devised a special machine for use in this manufacture, had his forging machine located in a room separated from the furnaces by a thick wall. A hole was cut through this wall, and the man who operated the machine received the heated bars from the furnace through the small hole in the wall. The only person who ever got a glimpse of the machine was the operator. The forge man was not permitted to enter the room.

Machine forging, as we know it to-day, is of wide application, embracing a large number of machines and processes that apply, in a measure, to almost any manufacturing plant. Machine parts hitherto made from castings are now made much more economically by the use of the drop-hammer or forging machine, and give much more satisfactory service.

#### Types of Machines

Upsetting and heading machines are divided into two genera, namely, stop-motion and continuous-motion headers. The

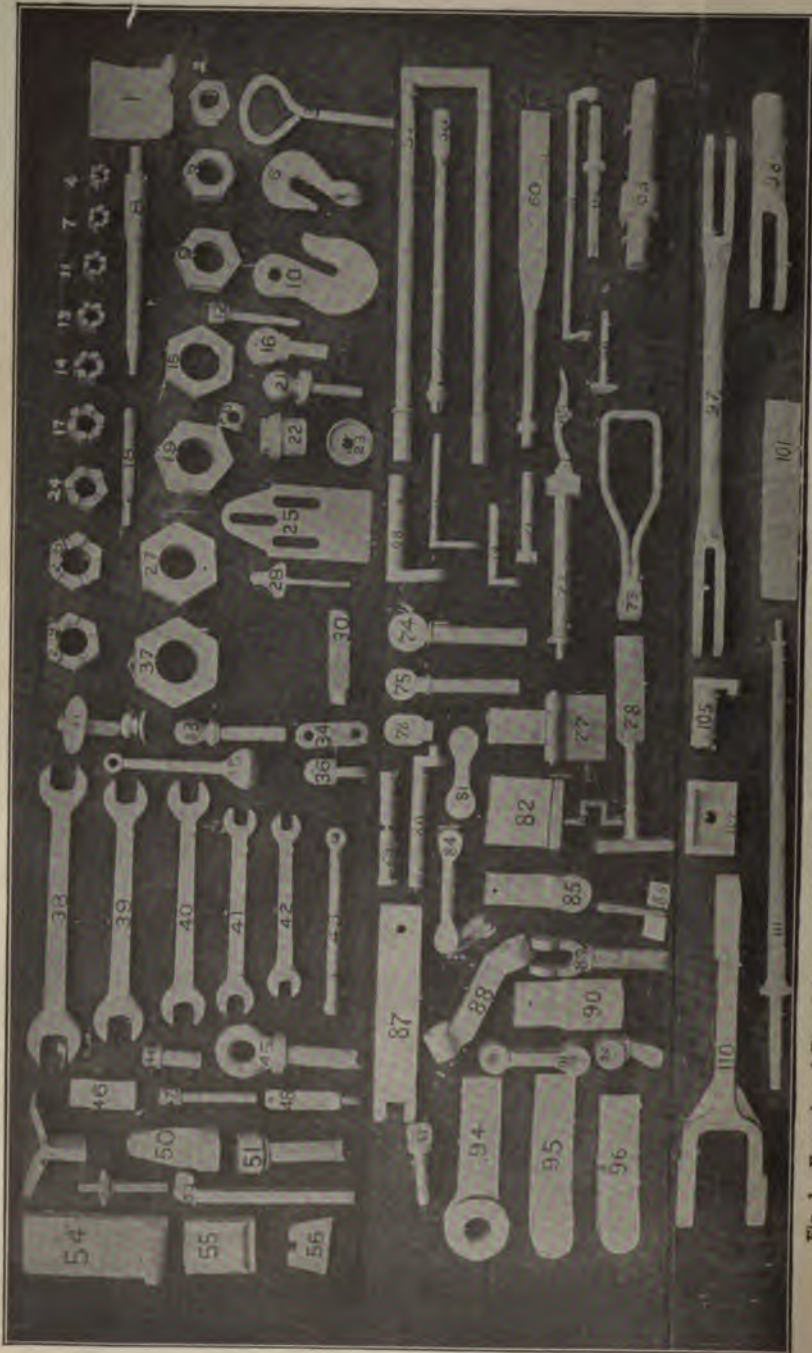

Fig. 1. Examples of Forged Parts produced in the Collinwood Shops of the L. S. & M. S. Railway on Ajax Forging Machines

headers have the greatest range, and are primarily used for heading bolts and for all kinds of upset forgings. The continuous-motion headers are used only for heading rivets, carriage bolts and short lengths of hexagon- and square-head machine bolts; they produce these parts at a much faster rate than is possible with a stop-motion header, but their range of work is limited. The universal practice is to shear the bars cold when working a stop-motion header, and only in special cases, when the shank of the headed piece is very short, is the side shear used.

Rivets, etc., forged in the continuous-motion header, are made by the process known as "off the bar;" that is, a bar is heated for a distance of approximately four feet, and is then pushed into the machine where the moving die acts as a shear and cuts off the blank. The

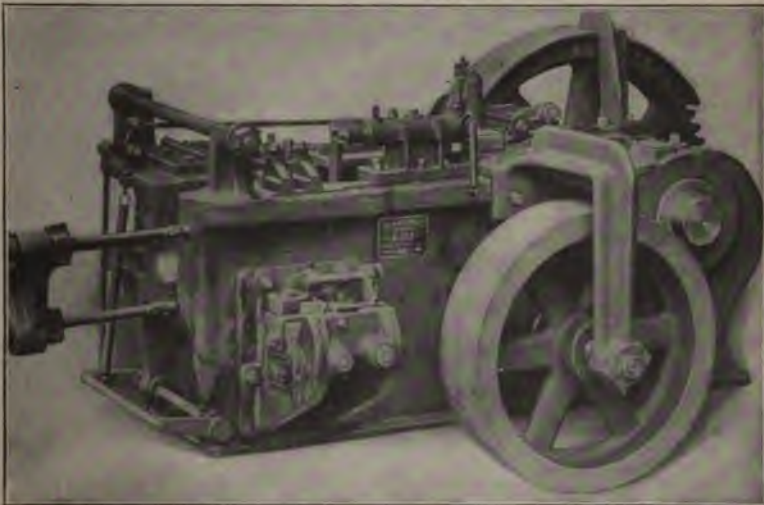

Fig. 2. Ajax Bolt Heading Machine suitable for all Types of Machine Bolts and Upset Forgings

latter is immediately gripped against the stationary die, whereupon it is headed and ejected. This whole cycle of movements is accomplished in one revolution of the flywheel.

#### Operation of Plain Bolt and Rivet Machines

Briefly stated, a plain bolt and rivet machine comprises two gripping dies, one movable and the other stationary, and a ram which carries the heading tool. The heated bar is placed in the impression in the stationary gripping die, and against the gage stop; the machine is then operated by pressing down the foot treadle shown in front of the machine in Fig. 2. As already mentioned, the stock is generally cut to the desired length before heading on this type of machine, especially when it is long enough to be conveniently gripped with the tongs; but it can be headed first and then cut off to the

desired length in the side shear. It is also possible, in some makes of machines, to insert a cutting tool to cut off the blank before heading, when the work is not greater in length than the capacity of the machine.

There are several methods used in making bolts and rivets in a regular forging machine. In Fig. 3 is shown a diagrammatical view

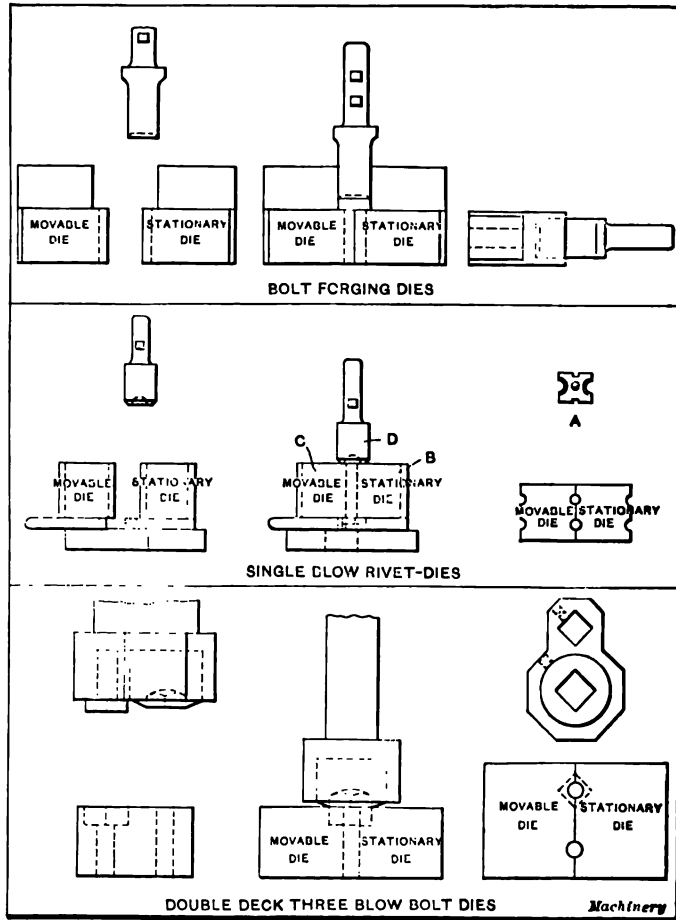

Fig. 3. Plain Type of Bolt Forging Dies of Universal Application.  
Fig. 4. Single-blow Rivet Dies. Fig. 5. Double-deck Three-blow Dies

of a set of forging dies which have a very wide range of application. In this type of dies the head on the bolt is formed by rotating the bar between the gripping dies after each blow of the plunger. For a square-headed bolt, the bar is turned twice through a space of 90 degrees, and is generally given two or more blows in each position. A hexagon-head bolt usually requires at least six blows to complete one



Fig. 7. Second Step in the Production of Bolt Heads



Fig. 6. First Step in the Production of Bolt Heads in Plain Forging  
Dies of the Type shown in Fig. 3

bolt, and the shape of the head depends to a large extent on the skill of the operator. The wide range of work, however, which can be handled in dies of this type, makes them of almost universal application, especially in a railroad shop.

Fig. 4 shows a set of single-blow rivet dies which are used in a continuous-motion rivet header, and illustrates how these dies are operated in the making of a rivet in one blow. The heated stock is fed in and cut off to the exact length by a shear *A*; it is gripped

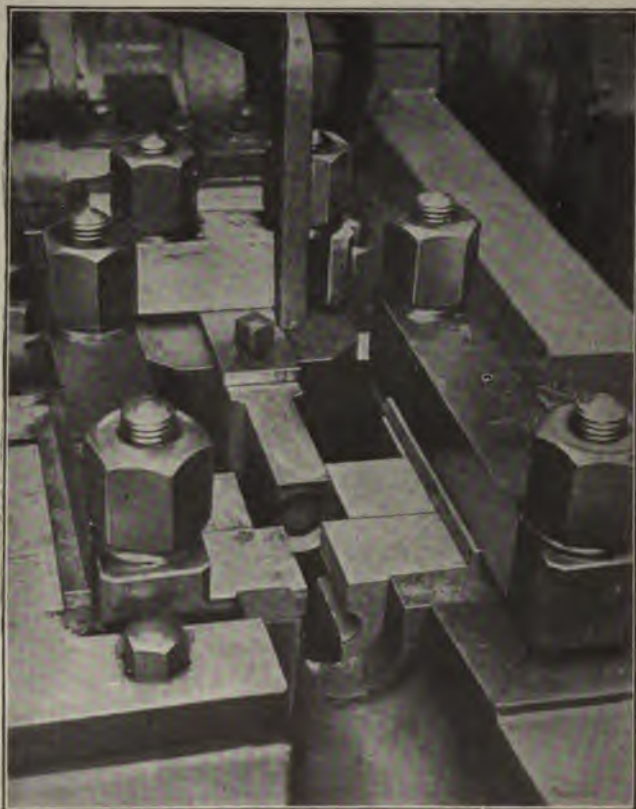

Fig. 8. Third Step in the Production of Bolt Heads

between dies *B* and *C* while being cut off. Tool *D*, held in the ram of the machine, then advances, upsetting the head to the shape shown, whereupon the movable die backs out, allowing the formed rivet to drop out and the bar to be inserted to the stop, ready for the next piece. The type of bolt heading tool illustrated in Fig. 5 is known as a double-deck three-blow bolt die; its use and operation will be explained later.



## Successive Steps in Heading Bolts

Figs. 6, 7 and 8 show the successive steps followed in the forging of a hexagon-head bolt in the type of bolt forging dies illustrated in Fig. 3. Bar *A*, which is heated for a portion of its length, is placed in the impression in the stationary gripping die *B*, as shown in Fig. 6, and is gaged to length by the lifting stop *C*. The machine is then operated, and the movable die *D* closes in on the bar, gripping it rigidly. The stop now rises, and, as the ram of the machine advances, the plunger *E* upsets the end of the bolt, the blocks *F* and *G* forming a flat on each side of the upset end. The operator keeps his foot on the treadle, and as the movable die backs out, he rotates the rod one-sixth of a turn. This operation is repeated until the head has been correctly formed. The operator now removes his foot from



Fig. 9. Heading Bolts in a 2-inch Ajax Forging Machine in the L. S. & M. S. Railway Shops

the treadle, stopping the operation of the machine, when the dies remain in the open position, allowing him to remove the completed bolt as shown in Fig. 7. This view shows the stop down and the dies open ready for the rod to be inserted again, while Fig. 8 shows the dies open and the plunger on its return stroke.

Fig. 9 shows how the furnace and forging machine are arranged for making bolts and machine forgings in a Cleveland railroad shop. The bars in this case are long enough to be gripped with the tongs, and are therefore cut off to the desired length in a power shear before heading. From the power shear the bars are brought to the heating furnace, in the truck shown to the right in the illustration, where one end of the bars is heated to the desired temperature. This furnace is heated by oil and is placed as close to the forging machine as possible. The man who attends to the bar places the stock places

the rods in a row, and as soon as the end to be headed reaches the proper temperature, he quickly removes the heated bar and passes it to the forging machine operator, who immediately places it between the dies, operates the machine, and forms the head. In this particular example the bolt is  $1\frac{1}{4}$  inch in diameter by 12 inches long, and is formed in three blows in double-deck dies of the type illustrated in Fig. 11. The dies and heading tool are kept cold by means of a constant stream of water. As soon as the bolt is headed it is thrown



Fig. 10. View looking down into the Die Space of an Ajax Bolt Forging Machine

in the truck to the left, which is used for conveying the bolts to the threading machines.

Fig. 10 shows a view looking down into the die space of the "Ajax" bolt header, from which an idea of the relation between the working members can be obtained. The back stop *A* is used for locating the bar in the correct position. This stop is sometimes used instead of the swinging stop *B*. This view also shows how the gripping dies are held in the die space; a heel plate fastened to the frame of the machine and to the movable die-slide by studs and nuts, carries set-screws which bear down on the die blocks, holding them tightly in the die space.

## Types of Bolt Header Dies

Fig. 11 shows a type of bolt heading dies known as double-deck three-blow bolt dies, which are used for finishing hexagon-head bolts. The two gripping dies *A* and *B*, as a rule, are made from blocks of tire steel; each gripping die is made from three pieces to facilitate machining. The lower header punch *C* is cupped out to form a hexagon, and is held in the heading tool-holder which is attached to the ram of the machine. The upper punch *D* is held in the same manner as the lower heading punch, and forces the bolt into the hexagon impression in the dies after it has been roughly formed in the lower impression. This type of die produces a bolt free from fins and burrs, and accurate as regards size and shape. The bolt is given one blow in the lower position and then raised to the upper die impression, where it is generally given two blows.

A combination set of double-deck gripping dies for making square- and hexagon-head bolts is shown in Fig. 12. The construction of these

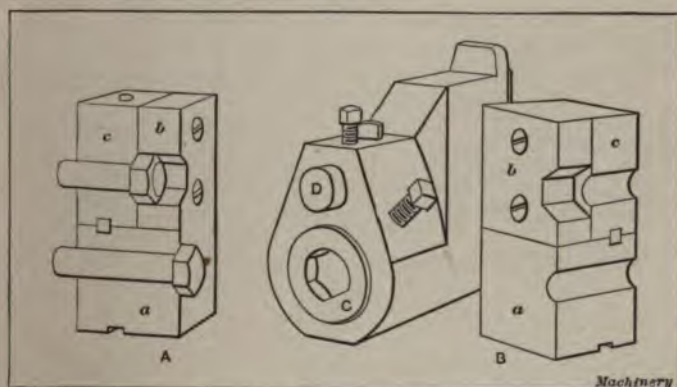

Fig. 11. Type of Double-deck Dies used in producing Bolt Heads without Fins or Burrs in Three Blows

dies is similar to that of the dies shown in Fig. 11, with the exception that these dies can be used for making both square- and hexagon-head bolts. The punches for forming the hexagon- and square-head bolts are shown at the right and left, respectively. A general idea of the class of work turned out in a bolt and rivet header may be obtained from Fig. 13.

## Construction of National Wedge-grip Bolt and Rivet Header

Fig. 14 shows a view of a two-inch National wedge-grip bolt and rivet header which is used for making bolts, rivets and miscellaneous forgings. There are a number of interesting features connected with this machine, one of which is the wedge-grip and automatic relief mechanism. In the bolt and rivet header it is necessary that the work be held in the impression in the gripping dies and not slip. Both of these dies must come

tightly together, and are made to do so by the mechanism of the machine; therefore any foreign body preventing the correct movement of these dies would cause trouble by breaking the machine, if no special means to safeguard against this were provided. Various



Fig. 12. Combination Square and Hexagon Double-deck Bolt Dies

methods have been used, however, for obviating this difficulty, one of which is the application of a shearing pin in the movable gripping die slide, which, when the foreign body is placed between the dies,

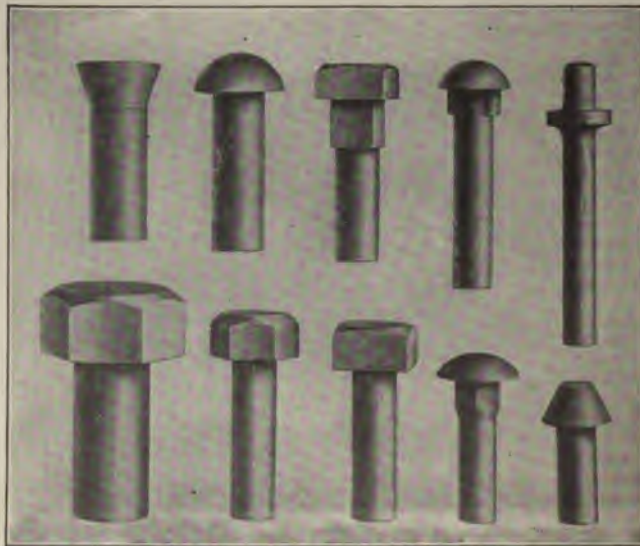

Fig. 13. Some Examples of Work turned out on National Wedge-grip Bolt and Rivet Header

is sheared off without causing any damage to the machine. Another method, which is a special feature of the National wedge-grip header, is a spring relief, which throws the entire gripping mechanism out of action should the stock or any foreign body be caught accidentally between the dies and prevent them from closing. The action of this

relief is indicated in Figs. 15 to 17. In Fig. 15 the gripping dies are shown closed and the relief mechanism does not operate. In Fig. 16, the gripping dies are shown open and the ram is at its extreme backward stroke, while in Fig. 17 the dies are open, but with the ram at the forward end of the stroke. The latter view shows what happens when a foreign body is caught between the gripping dies and prevents them from closing.

The relief mechanism consists of a spring plunger *A*, the front end of which is beveled, and which is kept in the "out" position by a coiled spring. This plunger, as indicated in Fig. 16, presses against an angular projection on the movable gripping slide. Now when a foreign body comes between the gripping dies and prevents them

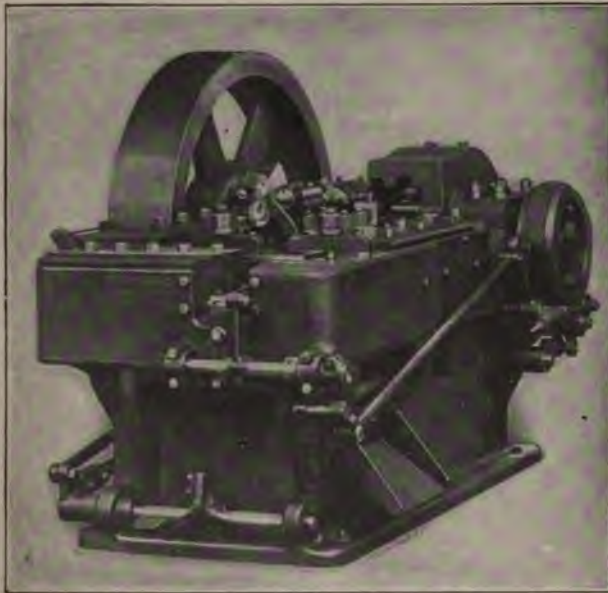
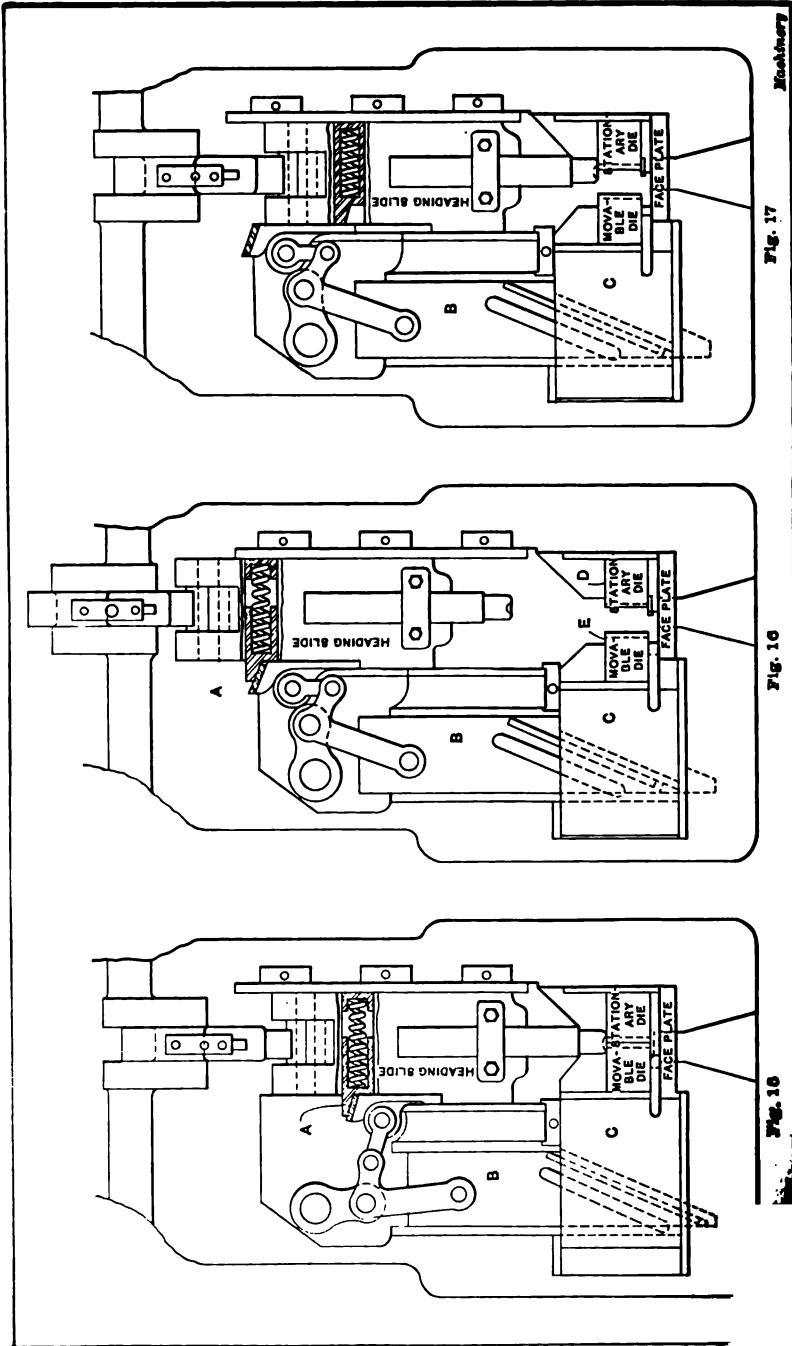

Fig. 14. Two-inch National Wedge-grip Bolt and Rivet Header

from closing, this spring plunger is forced back and the toggle joint operating the wedge-gripping slide remains stationary; this allows the dies to remain open, although the ram completes its full forward travel. This relief will operate up to the time the dies are closed, but when the dies are closed, the gripping pressure is positive.

An important feature of this machine is the wedge-grip for the movable slide. This consists of a slide *B* to which the toggle lever is attached, and which is moved back and forth by the latter through the movement of the crankshaft. The forward end of slide *B* is beveled and forms a wedge-shaped backing when the gripping slide *C* is in the forward position—when the dies are closed. This means of locking the slide during the heading operation prevents any rattle of the slide and causes an even pressure



Washburn

Fig. 17

Fig. 16

Fig. 18

Fig. 16 and 17. Diagrams illustrating Construction and Operation of National Wedge-grip Bolt and Rivet Headers

to be exerted over the entire working surface of the dies. The stationary die *D* and movable die *E* are set so that their working faces merely touch, and the rigidity of the grip prevents any spring, so that the work can be produced without fins and burrs. By not having to set the dies ahead, the pounding or battering and premature wearing out of the dies is prevented.

Fig. 18 shows more clearly how the movable and stationary dies are retained in the die space, and how they are backed up by steel liners. From an inspection of this illustration it will be seen that with this

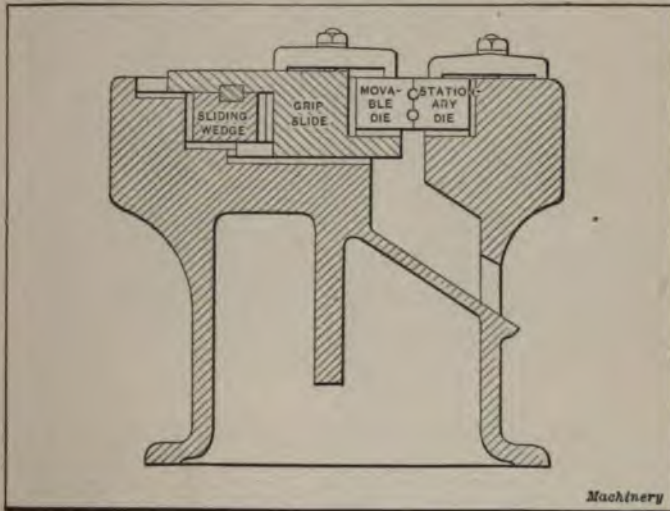

Fig. 18. Section through Die Box of the National Wedge-grip Bolt and Rivet Header

sliding wedge mechanism it is practically impossible for the dies to give or spring when in operation on the work.

#### Hammer Type of Bolt Header

In the type of bolt and rivet making machines so far described, the head is formed by hitting the heated bar on the end and forcing it into suitably shaped impressions in the gripping dies. In the following, attention will be given to a type of bolt heading machine in which the end of the bar is first upset and the head then formed to the desired shape by the combined action of the upsetting punch and hammer dies operating from all four sides.

In the hammer type of bolt header, shown in Figs. 19, 20 and 21, the head of the bolt is formed by an end-working upsetting punch and four hammers which are operated from all four sides at right angles to the bolt. In operation, the heated blank, which has a certain length, is placed in a seat (when the bolt is accommodated) and between the gripping dies, the adjustable stop *A*. Then by a move-

ment of the hand-lever *C*, the dies (one of which is shown at *B* in Fig. 21) are closed and the machine is started. The stock is not moved during the forging operation, but is kept up against the adjust-

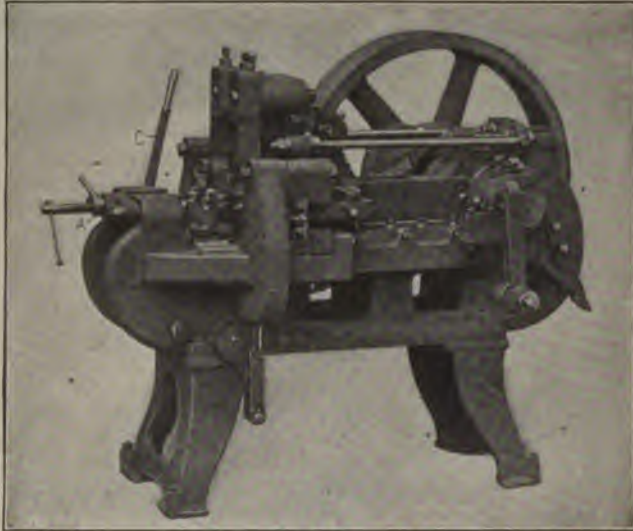

Fig. 19. Type of Hammer Header made by the National Machinery Co., Tiffin, Ohio

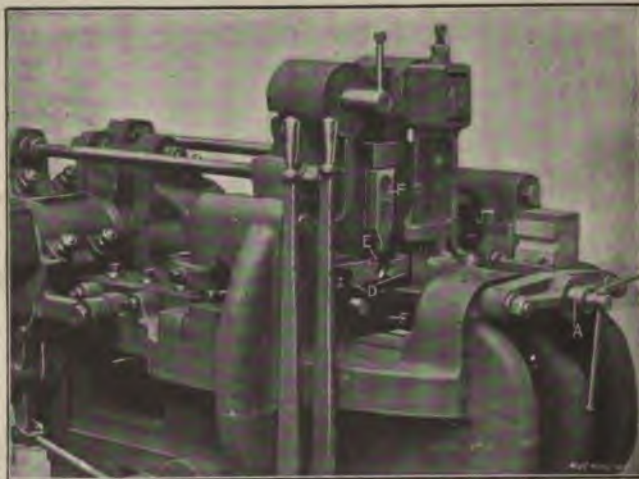

Fig. 20. View of Hammer Header showing Both Gripping Dies removed, and One Die Hanger

able stop, and the gripping dies are not opened until the head is completely formed. From three to five blows are struck, depending upon the size of the bolt and the finish desired, whereupon the machine is



stopped and the dies are opened by operating the hand-lever, allowing the finished work to drop from the machine. The side-forming hammers *D*, Fig. 20, give two blows to every blow struck by the heading tool *E* and the vertical hammers *F*.

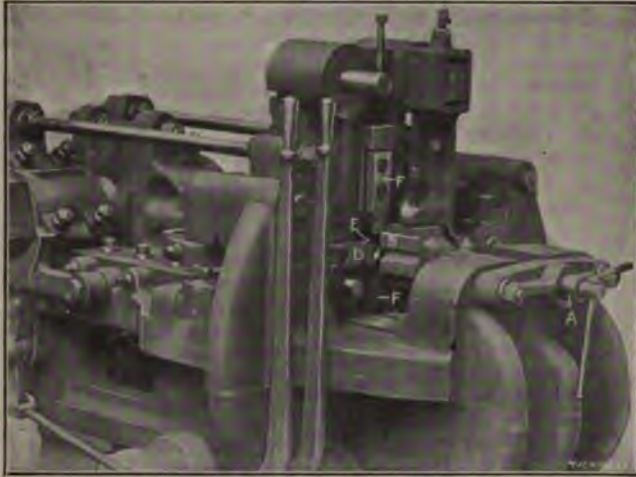

Fig. 21. View of Hammer Header showing Left-hand Die Hanger removed, and One Gripping Die in Place

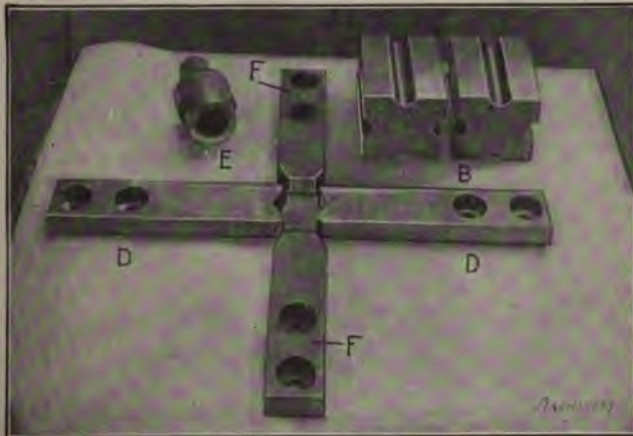

Fig. 22. Type of Dies, Hammers and Heading Tool used in the Hammer Type of Bolt Header shown in Fig. 19

The 1½-inch size of this type of hammer header is provided with two hand controlling levers, as shown in Figs. 20 and 21. One of these levers operates the arms carrying the gripping dies, and the other operates for starting and stopping the machine. On the smaller types, one lever controls both of these move-

ments. Fig. 20 shows one of these hammer headers with the gripping dies and the left-hand gripping die hanger removed; this view also shows clearly the upsetting punch and the four forming ham-

TABLE I. PROPORTIONS OF U. S. STANDARD AND MANUFACTURERS' STANDARD HEXAGON AND SQUARE HEAD BOLTS AND APPROXIMATE AMOUNT OF STOCK REQUIRED TO FORM HEAD

United States Standard						Manufacturers' Standard					
Dimensions in Inches						Dimensions in Inches					
D	A	B	C	E	F	D	A	B	C	E	F
1/4	3/8	1/2	1 1/8	1/2	1 1/8	1/4	3/8	1/2	1 1/8	1/2	1 1/8
5/16	7/16	5/8	1 1/4	5/8	1 1/4	5/16	7/16	5/8	1 1/4	5/8	1 1/4
3/8	1/2	3/4	1 1/2	3/4	1 1/2	3/8	1/2	3/4	1 1/2	3/4	1 1/2
1/2	3/4	1	1 3/4	1	1 3/4	1/2	3/4	1	1 3/4	1	1 3/4
5/8	7/8	1 1/8	2	5/8	2	5/8	7/8	1 1/8	2	5/8	2
3/4	1 1/8	1 1/4	2 1/4	3/4	2 1/4	3/4	1 1/8	1 1/4	2 1/4	3/4	2 1/4
7/8	1 1/4	1 3/8	2 3/4	7/8	2 3/4	7/8	1 1/4	1 3/8	2 3/4	7/8	2 3/4
1	1 1/2	1 3/4	3	1	3	1	1 1/2	1 3/4	3	1	3
1 1/8	1 3/4	2	3 1/4	1 1/8	3 1/4	1 1/8	1 3/4	2	3 1/4	1 1/8	3 1/4
1 1/4	2	2 1/4	3 1/2	1 1/4	3 1/2	1 1/4	2	2 1/4	3 1/2	1 1/4	3 1/2
1 1/2	2 1/4	2 3/4	3 3/4	1 1/2	3 3/4	1 1/2	2 1/4	2 3/4	3 3/4	1 1/2	3 3/4
1 3/4	2 3/4	3	4	1 3/4	4	1 3/4	2 3/4	3	4	1 3/4	4
2	3	3 1/2	4 1/2	2	4 1/2	2	3	3 1/2	4 1/2	2	4 1/2
2 1/4	3 1/4	3 3/4	4 3/4	2 1/4	4 3/4	2 1/4	3 1/4	3 3/4	4 3/4	2 1/4	4 3/4
2 1/2	3 1/2	4	5	2 1/2	5	2 1/2	3 1/2	4	5	2 1/2	5
2 3/4	3 3/4	4 1/4	5 1/4	2 3/4	5 1/4	2 3/4	3 3/4	4 1/4	5 1/4	2 3/4	5 1/4
3	4	4 1/2	5 1/2	3	5 1/2	3	4	4 1/2	5 1/2	3	5 1/2
3 1/4	4 1/4	4 3/4	5 3/4	3 1/4	5 3/4	3 1/4	4 1/4	4 3/4	5 3/4	3 1/4	5 3/4
3 1/2	4 1/2	4 3/4	5 3/4	3 1/2	5 3/4	3 1/2	4 1/2	4 3/4	5 3/4	3 1/2	5 3/4
3 3/4	4 3/4	5	6	3 3/4	6	3 3/4	4 3/4	5	6	3 3/4	6
4	5	5 1/2	6 1/2	4	6 1/2	4	5	5 1/2	6 1/2	4	6 1/2

mers. Fig. 21 shows the same machine with one of the gripping dies in place, but with the left-hand gripping die hanger removed. The tools used in this machine are more clearly illustrated in Fig. 22; the various members are denoted with the same reference letters as used in connection with the description of the machine. For making a

square-headed bolt, the side-working hammers, of course, are of the same shape as the vertical hammers.

The type of hammer header illustrated in Figs. 19, 20 and 21 is limited in its scope to the production of square, hexagon and tee-headed bolts as shown in Fig. 23. These, however, can be produced in large quantities at a low cost, and what is more important, the product is entirely free from fins and burrs, and is shaped as accurately as is possible by the forging method. The fact, however, that it takes longer to change the dies from one size to another in this type of machine militates against its installation in preference to the

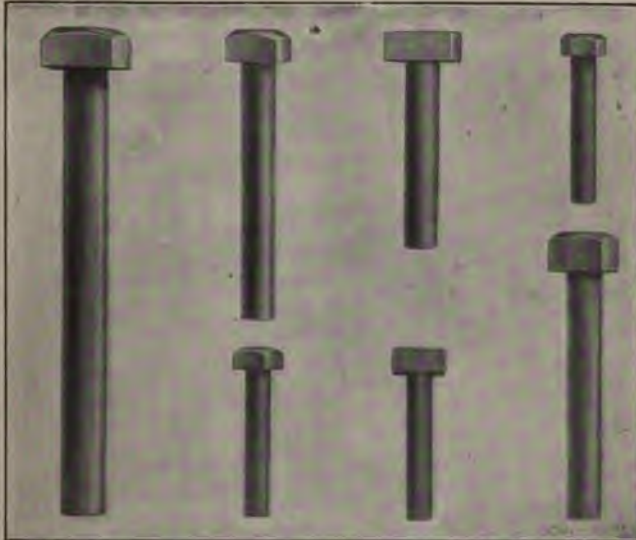

Fig. 23. Some Examples of Work produced in National Hammer Headers

other types of bolt headers, where frequent changes in the sizes of dies are necessary.

#### Stock Required for Bolt Heads

In forming a head on a bolt or rivet, the heated metal on the end of the bar is upset or formed into the desired shape by a plunger held in the ram of the forging machine. To produce the head requires considerably more metal than the thickness of the head—because of the increase in diameter—and hence it is necessary to allow a certain amount of excess stock to form the head. Table I gives proportions of U. S. standard and Manufacturers' standard hexagon and square bolt heads, and also the approximate amount of stock required to form the head—this information being listed in Columns "C" and "F." The excess amount of stock given is not close enough for starting the machine, as the stop is just to suit.

## CHAPTER II

### CONTINUOUS-MOTION BOLT AND RIVET HEADERS

Continuous-motion bolt and rivet headers are made in two types, one being hand-fed and the other provided with an automatic roll feed. A machine of the hand-fed type is shown in Fig. 24. In operating this type of machine, the bar, which has been heated for a length of four or five feet, is fed through a shear in the faceplate block of the machine, and as the movable gripping die closes on the bar, a blank of the required length is cut off and held rigidly in the gripping dies. The head is then formed by the forward movement of the

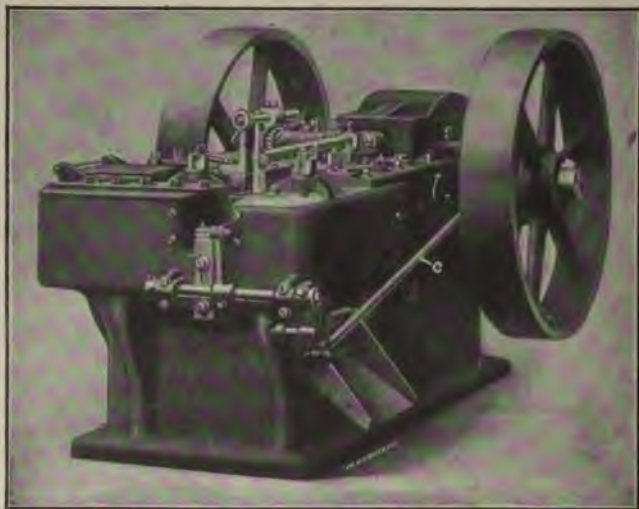

Fig. 24. Continuous-motion Wedge-grip Bolt and Rivet Header built by the National Machinery Co.

ram which carries the heading tool. After heading, the ram of the machine recedes, the gripping dies open, and a kicker, actuated by a connecting-rod *c* from a cam on the main shaft, ejects the finished work from the dies, depositing it, through a chute, into a box. As the dies open, the operator again pushes in the heated bar until it strikes the stop, and as the movable die advances, another blank is cut off and headed as before. The machine runs continuously until the heated portion of the bar has been exhausted, when the operator takes a newly heated bar from the furnace and proceeds as before.

A bolt or rivet made in a machine of this type receives only one blow, and, therefore, for work within the capacity of this machine the production is greatly increased over that obtained from the pl

type of forging machine. One of the chief requisites in a machine of the continuous-motion type is that of securing a rigid grip on the work while the head is being formed. If the grip is not satisfactory, that is, if the dies separate, it causes the shank of the bolt or rivet to become tapered or out of round, and also results in fins being produced on the shank and under the head. Furthermore, unless the machine is provided with suitable slides which can be kept in proper alignment, it is difficult to secure work on which the heads are centrally located with the shanks, and also to keep the shear and movable die in correct working relation.

The type of tools used in the bolt and rivet machine of the con-



Fig. 25. Type of Dies and Tools used in the Continuous-motion Bolt and Rivet Header shown in Fig. 24

tinuous-motion type is illustrated in Fig. 25. The two gripping dies *A* and *B* are held in the die space of the machine by heel clamps as shown in Fig. 24. The gripping dies are provided with four interchangeable grooves, so that when one groove wears out, it is only necessary to turn the blocks. The heading punch *C*, which is held in the holder *D* in the ram of the machine, is cupped out to suit the shape of the bolt or rivet head, and is so arranged that it will be in perfect alignment with the gripping dies. *E* is the shearing blade which is held in the faceplate block, and is used in cutting off the stock to the desired length. The length of the gripping dies is governed by the length of the bolt required; they are made shorter than

the blank from which the bolt is made, thus allowing for sufficient extra stock to form the head.

Continuous-motion Bolt and Rivet Header with Automatic Feed

Fig. 26 shows a continuous-motion bolt and rivet header furnished with a roll feed attachment, which consists of four rollers provided with suitably shaped grooves in their peripheries. This view shows the roller feed attachment swung back out of the way in order to exhibit the dies and tools. This machine is similar to the one shown in Fig. 24, with the exception of the roll feed attachment for handling the bars automatically. The tools used are shown in Fig. 27, together

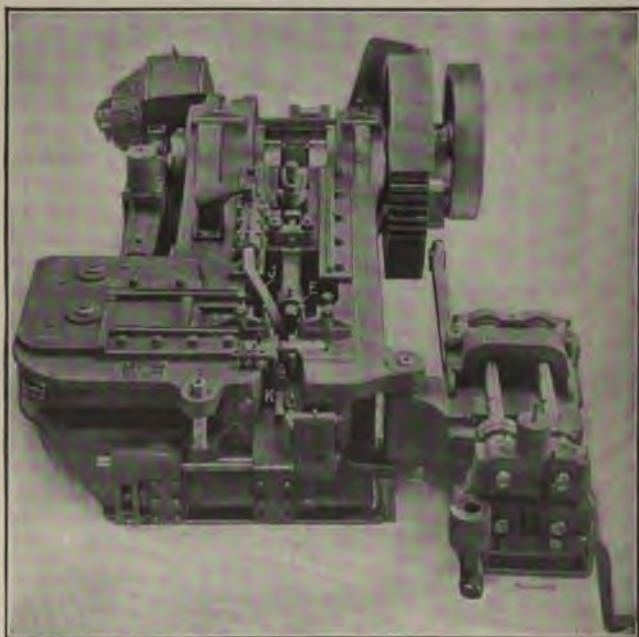

Fig. 26. Continuous-motion Bolt and Rivet Header built by the Ajax Mfg. Co., Cleveland, equipped with Roll Feed Attachment

with an example of work produced in them. The shearing die *A*, in this case, is steel bushed and is circular instead of oblong in shape. The gripping dies *B* and *C* are provided with four grooves each, as previously described, but to change the blocks for presenting a new groove, they are turned end for end, there being no grooves in the top faces. *D* is a  $\frac{3}{4}$  by 4-inch track bolt; *E* is the heading tool that is held in the ram of the machine.

A close view looking down into the die space of the machine shown in Fig. 26 is illustrated in Fig. 28. This view shows the relative positions of the feed rolls, shearing die, gripping dies, etc. The heated bar is fed by the rolls *F* through the guide pipe *G*, held by

bracket *H*, and through the shearing bushing *A*. This bushing is retained in the faceplate *I* which is held in grooves in the machine-bed. The bar is fed directly through the cut-off bushing *A* and is gaged to length by the swinging stop *J* (see also Fig. 26). The movable die *C* then advances, cuts off the blank and carries it into the

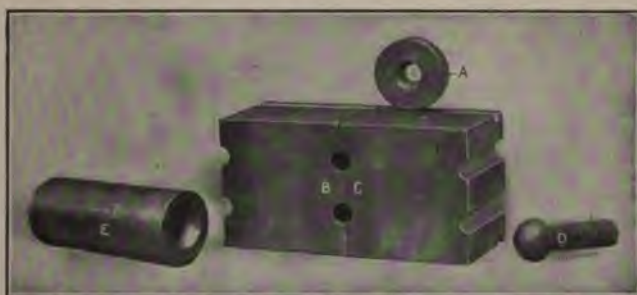

Fig. 27. Type of Dies and Tools used in Bolt and Rivet Making Machine shown in Fig. 26

groove in the stationary die *B*, gripping it while the heading tool (*E*, Fig. 26) advances and upsets the end of the bar, forming the head.

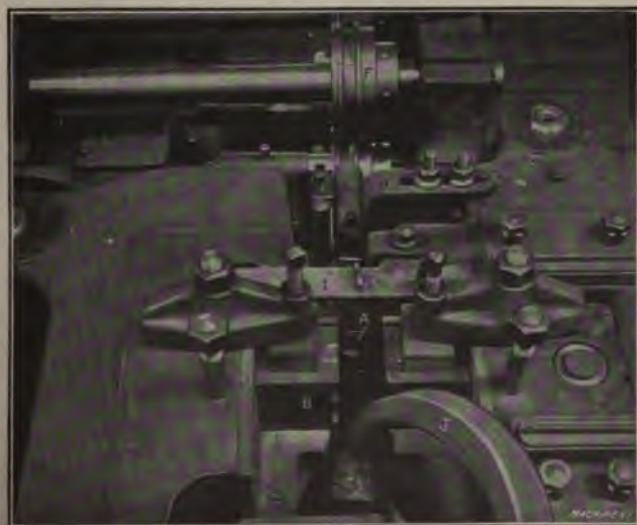

Fig. 28. View looking down into Die Space of Ajax Continuous-motion Bolt and Rivet Header

The stationary and movable gripping dies are held in place by straps, and are located as fitting in grooves in their lower faces. The lens is guided by the travel transmitted to the rolls through the main shaft, which receives power from the main crankshaft through a driving-rod, ratchet, pawl, gears, etc., and is adjusted by a screw-down mechanism.

The various steps in the production of a round-head rivet by the continuous-motion single-blow bolt and rivet machine, are clearly illustrated in the diagram Fig. 29. At A, the feed rolls have operated and have fed the heated bar out against the gage stop; at B, the

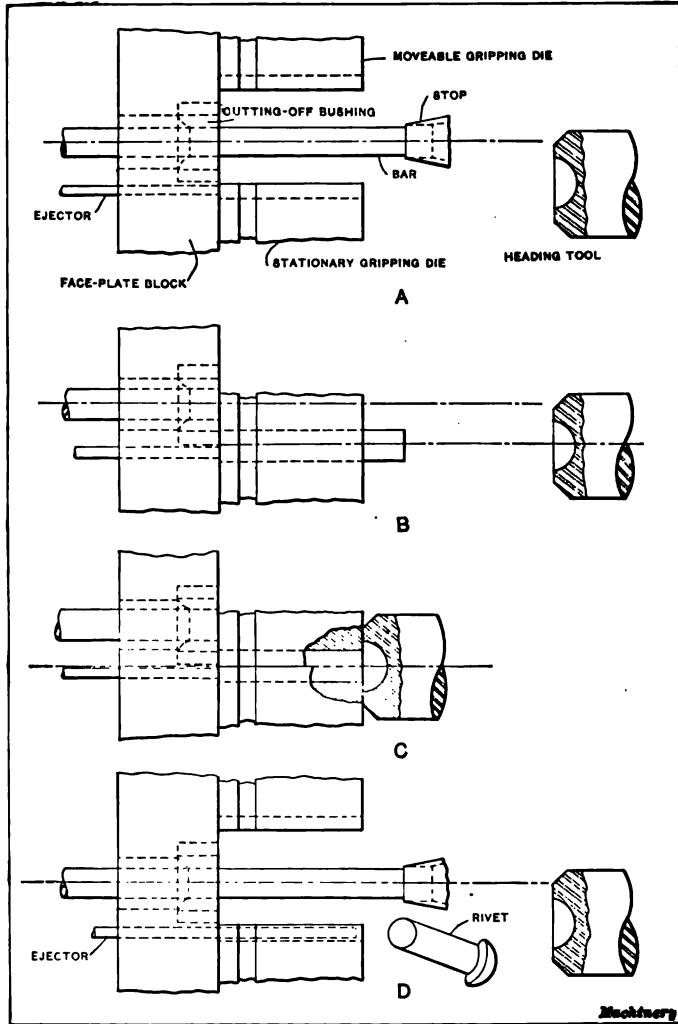

Fig. 29. Successive Steps in the Formation of a Round-head Rivet in a Single-blow Rivet Machine of the Continuous-motion Type

movable die has advanced, sheared off the end of the bar through the shearing bushing), and carried the blank in the stationary die. When the blank is held rigidly, the heading tool forms the head of the rivet. When the movable die has reached the end



movement, the heading tool advances, as shown at *C*, and upsets the end of the bar, forming the head. At *D*, the movable die and heading tool have retreated, the ejector pin (see *K*, Fig. 26) has advanced, pushing out the completed rivet, and the bar has been fed out again ready for a repetition of the operations.

Some idea of the methods pursued in the making of bolts and rivets by the continuous-motion machine process can be obtained from Fig. 30, which shows an operator attending to one of these automatic machines. The furnace in which the bar is heated (in the condition in which it comes from the mill) is located anywhere from  $3\frac{1}{2}$  to 4 feet from the feed rolls of the machine, and is provided in front with a roller *A*, over which the heated bar passes. The heating furnace,



Fig. 30. Ajax Continuous-motion Bolt and Rivet Machine in Action making  $1\frac{1}{2}$ -inch Rivets

as a rule, is 30 feet long, so that the entire length of a bar can be accommodated.

As soon as the bar in the furnace has reached the proper temperature, the operator grips it with a pair of tongs, as indicated in Fig. 30, draws it out, and places it between the feed rolls. Then he presses down the foot-lever *B*, thus starting the machine. The heated bar is then drawn in by the rolls, fed through the cutting-off die, gripped in the gripping dies, headed and ejected at the rapid rate of forty to seventy pieces per minute.

In the manufacture of rivets, as a rule, steel containing from 0.10 to 0.15 per cent carbon is more frequently used than wrought iron, and this material is used in considerable quantities in many establishments. Wrought iron for making rivets

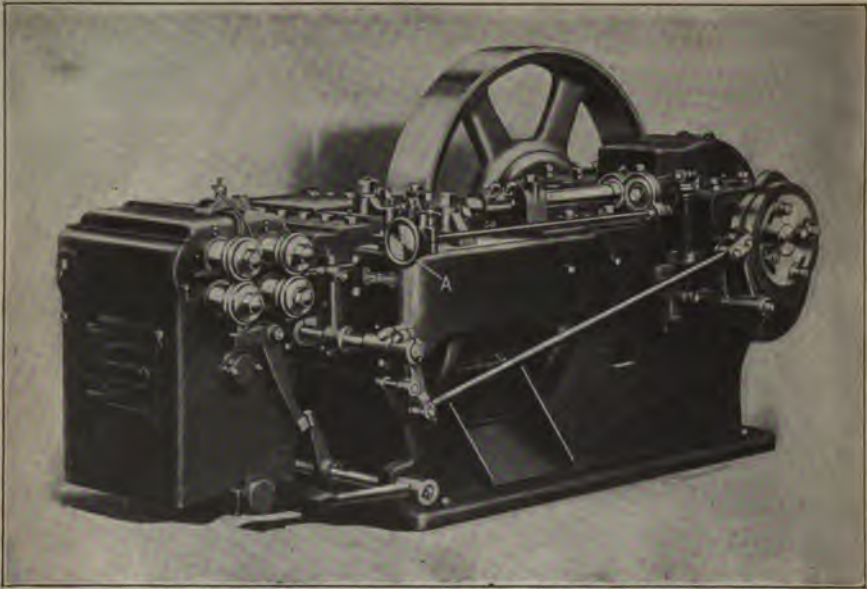

Fig. 31. National Continuous-motion Bolt and Rivet Making Machine equipped with Roll Feed and Adjustable Stop Gage

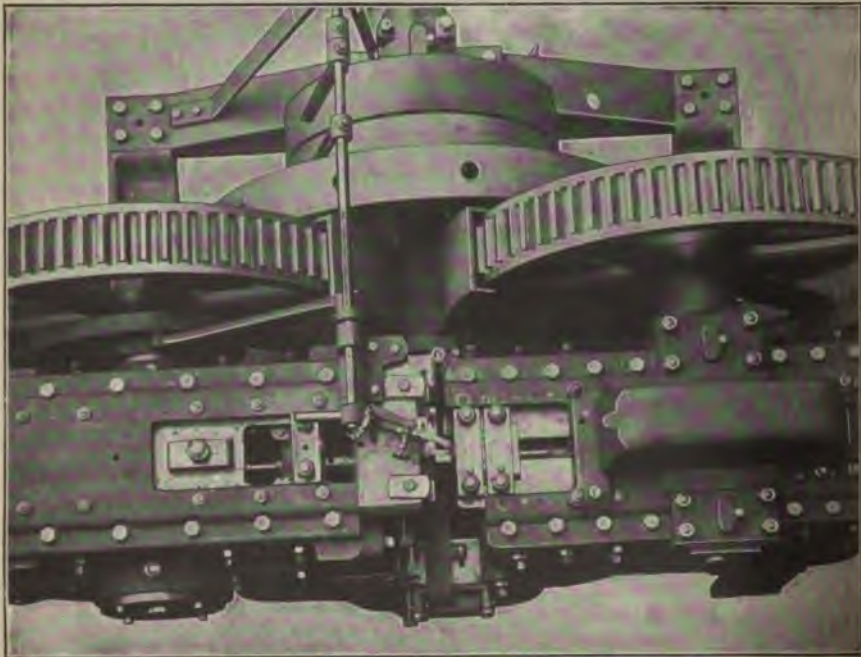

Fig. 32. Top View of "National" Hot-pressed Center-feed Nut Making Machine

is heated to almost a white heat, but steel which contains from 0.10 to 0.12 per cent carbon is heated to only about 1400 degrees F.—a bright red color. When the head of a rivet is so shaped that it is necessary to carry the stock down far into the heading tool, the temperature to which the bar is heated must be increased, in order to make the metal flow more readily and prevent buckling.

In making rivets with long tapered heads, the operator generally finds it necessary to change the length of feed, so that a rivet having a full head without flash is formed. The reason for this is that the bars sometimes vary in size and temperature, which makes this adjustment necessary. A continuous-motion bolt and rivet making machine, which is provided with means for taking care of the fluctua-



Fig. 33. Some Examples of Work which come within the Range of the Continuous-motion Type of Bolt and Rivet Headers

tions in size and temperature of stock, is shown in Fig. 31. In this machine the position of the stop is controlled by a handwheel *A*, within convenient reach of the operator, which he adjusts either way, depending upon the size of the bar, temperature of the metal, the shape of the part to be produced and the material from which it is made. When an over-size bar is encountered, the operator shortens the length of feed, as it is evident that too much stock would otherwise be supplied. When the bar is under-size, the reverse is the case. Again, when the bar is too hot, it is upset more on the end by the rolls forcing it against the stop, *e* *more* metal is provided than when the bar is not *e* *consequently* harder. The operator watches the pieces *from* the machine, and then adjusts the stop to keep them *as possible*—having a full head and without flash.

The feed rolls in the machine shown in Fig. 31 are made of chilled iron castings, and are kept cool by water jackets, insuring even temperature and minimum wear. They are operated from the main-shaft of the rolls. The movements of the machine are timed so as to allow ment as shown, adjustable for securing variations in the feeding time of the rolls. The movements of the machine are timed so as to allow the gripping dies to remain open a comparatively large part of the

TABLE II. DIMENSIONS OF RIVET HEADS OF VARIOUS SHAPES

Machinery

Dimensions in Inches

D	A	B	C	E	G	H	I	J	K
1/4	7/8	3/4	1/2	1/2	7/8	1/2	7/8	3/8	3/8
5/16	1	7/8	3/4	5/8	1	5/8	1	1/2	5/8
3/8	1 1/8	1	1 1/4	3/4	1 1/8	3/4	1 1/8	5/8	3/4
1/2	1 1/4	1 1/8	1 3/4	1	1 1/4	1	1 1/4	3/4	1
5/8	1 3/8	1 1/4	2	1 1/8	1 3/8	1 1/8	1 3/8	7/8	1 1/8
3/4	1 3/4	1 3/8	2 1/4	1 3/8	1 3/4	1 1/4	1 3/4	7/8	1 1/4
7/8	1 7/8	1 3/4	2 3/4	1 3/4	1 7/8	1 1/2	1 7/8	7/8	1 1/2
1	2	1 7/8	3	1 7/8	2	1 3/4	2	7/8	1 3/4
1 1/8	2 1/8	2	3 1/4	2	2 1/8	1 7/8	2 1/8	7/8	1 7/8
1 1/4	2 1/4	2 1/8	3 1/2	2 1/4	2 1/4	2	2 1/4	7/8	2
1 1/2	2 1/2	2 1/4	3 3/4	2 1/2	2 1/2	2 1/4	2 1/2	7/8	2 1/4
1 3/4	2 3/4	2 3/8	4	2 3/4	2 3/4	2 1/2	2 3/4	7/8	2 1/2
2	3	2 3/4	4 1/4	3	3	2 3/4	3	7/8	2 3/4
2 1/8	3 1/8	2 7/8	4 1/2	3 1/8	3 1/8	2 7/8	3 1/8	7/8	3
2 1/4	3 1/4	2 7/8	4 3/4	3 1/4	3 1/4	2 7/8	3 1/4	7/8	3 1/4
2 1/2	3 1/2	2 7/8	5	3 1/2	3 1/2	2 7/8	3 1/2	7/8	3 1/2
2 3/4	3 3/4	2 7/8	5 1/4	3 3/4	3 3/4	2 7/8	3 3/4	7/8	3 3/4
3	4	2 7/8	5 1/2	4	4	2 7/8	4	7/8	4
3 1/8	4 1/8	2 7/8	5 3/4	4 1/8	4 1/8	2 7/8	4 1/8	7/8	4 1/8
3 1/4	4 1/4	2 7/8	6	4 1/4	4 1/4	2 7/8	4 1/4	7/8	4 1/4
3 1/2	4 1/2	2 7/8	6 1/4	4 1/2	4 1/2	2 7/8	4 1/2	7/8	4 1/2
3 3/4	4 3/4	2 7/8	6 1/2	4 3/4	4 3/4	2 7/8	4 3/4	7/8	4 3/4
4	5	2 7/8	6 3/4	5	5	2 7/8	5	7/8	5
4 1/8	5 1/8	2 7/8	7	5 1/8	5 1/8	2 7/8	5 1/8	7/8	5 1/8
4 1/4	5 1/4	2 7/8	7 1/4	5 1/4	5 1/4	2 7/8	5 1/4	7/8	5 1/4
4 1/2	5 1/2	2 7/8	7 1/2	5 1/2	5 1/2	2 7/8	5 1/2	7/8	5 1/2
4 3/4	5 3/4	2 7/8	7 3/4	5 3/4	5 3/4	2 7/8	5 3/4	7/8	5 3/4
5	6	2 7/8	8	6	6	2 7/8	6	7/8	6

revolution, thereby allowing more time for the stock to be fed in and gaged, and the dies to be well flooded and cooled at the completion of each stroke.

Examples of Continuous-motion Bolt and Rivet Work

Inasmuch as only one blow can be struck in a continuous-motion bolt and rivet making machine, it is impossible to produce parts which cannot be completed in one blow. Fig. 33 shows a representative group of bolts and rivets for which the continuous-motion machines are especially adapted. These machines will also handle a

great variety of special work, such as square and hexagon head single-blow bolts, track bolts, etc. The cone-shaped rivets *A* and *B* illustrate the point mentioned in a previous paragraph regarding the difficulty encountered in producing work which is carried down far into the heading tool. Of course, these are not by any means extreme examples, but they serve to illustrate the point.

#### Making Bolt and Rivet Dies

Bolt dies which are used in a forging machine are as a rule made from steel containing from 0.60 to 0.80 per cent carbon, and are hardened and drawn. The gripping dies are tempered hard, so that the sharp corners on the edges of the dies will not wear away rapidly. It is customary to harden these dies in either oil or water, and then draw the temper so that a file will just take hold. The heading tool, which is comparatively small in diameter, and is called upon to perform heavy duty, must be much tougher than the gripping dies. Ordinarily the heading tool is made from a tough steel containing from 0.40 to 0.50 per cent carbon, and is drawn considerably more than the gripping dies.

In making the impressions in the gripping dies for heading ordinary sizes of bolts, no allowance is made for the shrinkage of the metal. However, in drilling the hole in the dies which grip the stock when it is being headed, a liner is placed between the two halves of the die, so that when they come together on the stock, the latter will be securely held. For dies with a  $\frac{1}{4}$ - to  $\frac{5}{8}$ -inch hole, a liner  $\frac{1}{64}$  inch thick is placed between the opposing faces, when drilling the hole. For holes larger than  $\frac{5}{8}$  inch and up to 1 inch, a liner  $\frac{1}{32}$  inch thick is used; for holes from 1 inch up to  $1\frac{1}{2}$  inch in diameter, a liner  $\frac{3}{64}$  inch thick is used; and from  $1\frac{1}{2}$  inch up to and including 3 inches in diameter, a liner  $\frac{1}{16}$  inch is employed. The double-deck type of dies are made from six blocks of steel bolted and keyed together to facilitate machining.

In making bolt and rivet dies which are used in continuous-motion machines, it is customary when making rivets from  $\frac{1}{2}$  to 1 inch in diameter, to use bar stock which is rolled  $\frac{1}{64}$  inch under-size. The dies referred to are shown in Figs. 25 and 27. The holes in the gripping dies are drilled to exact size (not  $\frac{1}{64}$  inch under-size, which is the diameter of stock used), and the expansion of the iron in heating gives sufficient grip, as it is only necessary to prevent the rivets from being pulled out of the dies by the return stroke of the heading tool. The reason for this is that in the continuous-motion type of bolt and rivet machine, the work is supported on the sides by the gripping dies, and is backed up by the shear, so that it is practically held in a box while the head is being formed. The same grade of steel is used for making rivet tools as for tools for producing bolts, and the heat-treatment is also in a similar manner.

**Stock Required for Rivet Heads**

In making rivets in a continuous-motion rivet machine, the amount of excess stock (X, Table II) required is generally obtained by trial, but when definite shapes and proportions of rivet heads have been decided upon, the amount of excess stock required can be calculated approximately. The great difficulty in giving tables covering the amount of excess stock required is that no standard for rivet heads is universally followed, with the result that a slight difference in the curve or height of the head changes the amount of stock necessary. In addition to this, the scale of the furnace, depending upon whether gas, oil or coal is used for heating, so changes the amount of stock required that a special setting of the stop in different cases is required. This is one of the reasons why up-to-date continuous-motion rivet making machines are provided with stops which can be adjusted while the machine is in motion. It is evident, therefore, that the exact amount of stock required is a question of some nicety, and it is surprising to what extent even the scaling off in the furnace will affect the stock required for the rivet head. What are considered in some shops standard shapes and sizes for rivet heads are given in Table II.

## CHAPTER III

### NUT FORGING MACHINES

The plain type of upsetting and forging machine which is used to a certain extent in the manufacture of bolts and rivets, especially the larger sizes, is also used for producing the ordinary square and hexagon nuts in sizes from 2 inches up. In making nuts by this process, the diameter of the round bar from which the nut is made should not exceed the root diameter of the thread in the finished nut, so it is evident that an extremely large upset is required to produce a full nut. When large nuts are produced in a plain forging machine, the usual method is first to form an upset on the end of the bar and then pierce the hole in the nut by punching the bar back, the metal removed to form the hole in the nut being attached to the bar. This operation requires considerable pressure, and as little, if any, material is wasted, it is a very successful method of producing nuts 2 inches and larger on a commercial basis. In the following, two types of machines, especially built to produce square and hexagon nuts, will be described. One of these machines is known as the hot-pressed center-feed nut machine, and the other as the hot-forged type; the latter is applicable only to the production of square nuts.

#### Hot-pressed Center-feed Nut Machine

The hot-pressed center-feed nut machine, as its name implies, produces nuts by pressing a heated blank of iron or steel into the required shape, the latter first being cut off as the bar is fed into the machine. The bar stock, which is rectangular in shape, is fed in from the side through a recess in the center of the machine and placed in front of the face of the dies. Fig. 34 shows one type of center-feed hot-pressed nut machine that works on the principle just stated. This machine consists essentially of two movable rams or slides which carry the cutting-off, crowning, piercing and wad-extracting punches, respectively. One ram is operated directly from the main crankshaft, while the other is operated by eccentrics and a connecting-rod.

Fig. 35 shows a detail view of this machine, and gives some idea of the construction of the dies, tools, etc. Here *A* is the cutting-off punch, *B* the crowning punch, *C* the piercing punch, *D* the wad extractor, *E* the nut dies, and *F* the ejector. The pipes *G* furnish a copious supply of water to keep the dies and tools cool during operation. A device for centering the bar in relation to the dies and tools is shown at *H*.

Another center-feed hot-pressed nut machine is used to produce hexagon and square nuts in the same manner.

lucet  
-g.



Fig. 34. Side View of "Ajax" Hot-pressed Center-fed Nut Machine showing Operating Side and Water Pipes for cooling Dies and Tools

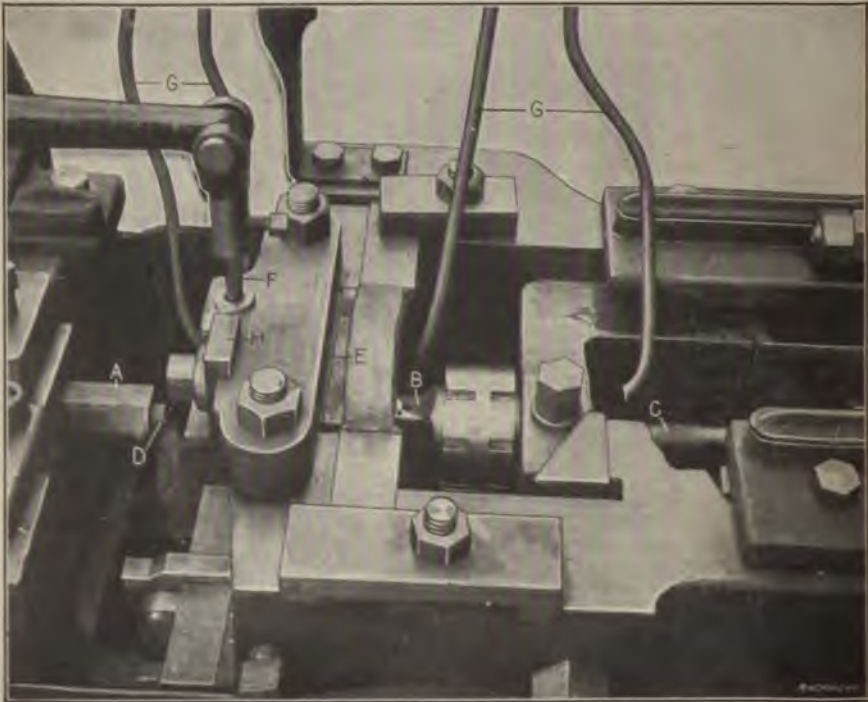

Fig. 35. Detail View of Machine shown in Fig. 34 showing Dies, Punching, Piercing, Crowning Tools, etc.



34 is shown in Fig. 32. In this machine, however, both rams or slides are operated directly from the source of power by a pinion and two large gears, one gear driving each slide. The majority of manufacturers produce nuts from a material known as soft, mild, open-hearth steel, which has a comparatively fine grain, and consequently, when forged, has less tendency to crack than does wrought iron. It can also be threaded much easier and with a smoother finish than wrought iron, owing to the fact that great difficulty is met with in

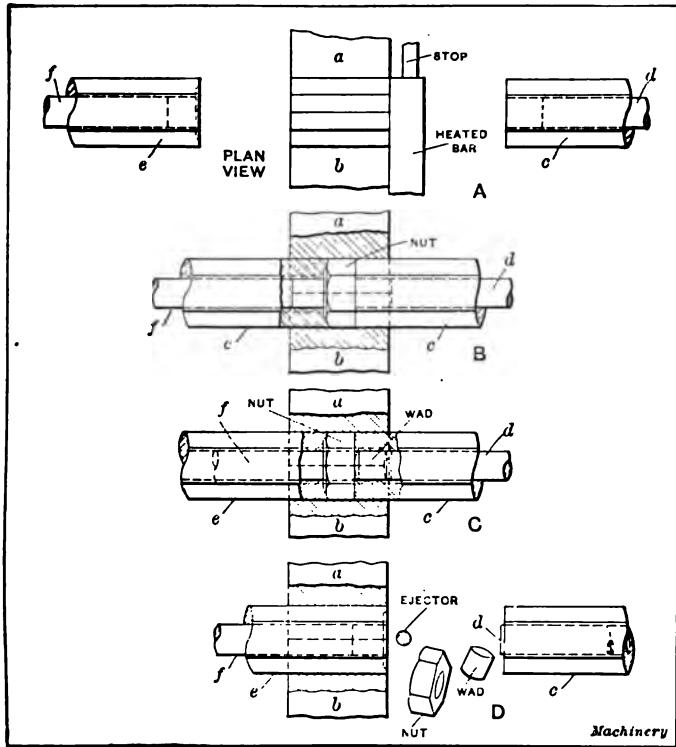

Fig. 36. Diagram illustrating Sequence of Operations in making Nuts in a Hot-pressed Center-feed Nut Machine

working the latter material, because the grain opens up, thus making it difficult to thread. Wrought iron, however, has one point in its favor—it can be worked at a much higher temperature than steel without affecting its structure, and hence does not need to be handled quite so carefully.

**Operation of a Center-feed Hot-pressed Nut Machine**

In operating a center-feed hot-pressed nut machine, the rectangular bar is heated to the correct temperature for a length of four or five feet. It is then brought to the machine and fed in from the side in

front of the face of the main dies, as indicated at *A* in Fig. 36. The cut-off tool *c* then moves up and shears the blank from the end of the bar, carries it into the main dies *a* and *b*, and presses it against the crowning tool *e*, which has also advanced, as indicated at *B*. The piercing tool *f* now advances, punches the hole in the nut, and carries the wad into the cutting-off tool, as shown at *C*; then the cutting-off and piercing tools *c* and *f* recede, and the crowning tool *e* advances, forcing the nut out of the dies. As the cut-off tool *c* recedes, the extractor *d* forces the wad out of the punch at the same time as the nut is ejected from the dies. The ejector, which is operated by a lever and cam, as shown in Fig. 32, is provided to prevent the nut from adhering to the crowning tool; this very seldom happens, however. A completed nut is produced at each revolution of the large gears.

The operations just described are repeated until the heated portion of the bar has been used up, after which the operator places the bar in the furnace to be re-heated, takes a freshly heated bar from the furnace, and proceeds as before. The machine is run continuously,



Fig. 37. Showing how a Hexagon Nut is produced from Rectangular Bar in a Hot-pressed Nut Machine

and is not stopped for the insertion of a newly heated bar. Finished nuts are turned out at the rate of from 40 to 70 per minute, depending upon the size of the machine and the skill of the operator. Fig. 37 shows how a hexagon nut is produced from a rectangular bar of stock in a center-feed hot-pressed nut machine. It will be seen that considerable scrap is lost in the production of a nut of hexagon shape, *viz.*, the wad removed to form the hole, and the triangular pieces which are removed to form the corners. On a square nut the material wasted is not quite so great, as in this case only the wad and a slight amount of stock, sheared off the end of the bar to form a square corner, are removed.

There are two common methods in use in nut forging. One is to set the stop so that the rounded corner of the bar is sheared off, leaving a square corner. This, of course, wastes somewhat more stock than the other method, yet to be described, but has the advantage of producing a perfect nut. The rounded corner is caused by the cut-off tool which, in removing the block of metal from the end of the bar to form the nut, rounds over the end of the bar, due to the hot metal

drawing over, and thus makes this waste of stock necessary if a full-shaped nut is to be secured.

Another method in common use to save stock and at the same time produce a practically full nut, is to invert the bar after each stroke of the machine. By this method opposite sides of the bar are alternately presented to the dies, which overcomes, to a large extent, the effect of the fin on one side and the rounded corner on the other, and produces a full nut without shearing any material from the end of the bar. The only objection to this method is the necessity of turning the bar, which, if heavy, soon tires the operator. On the larger sizes of nuts, the first method is used, as the bars are quite heavy

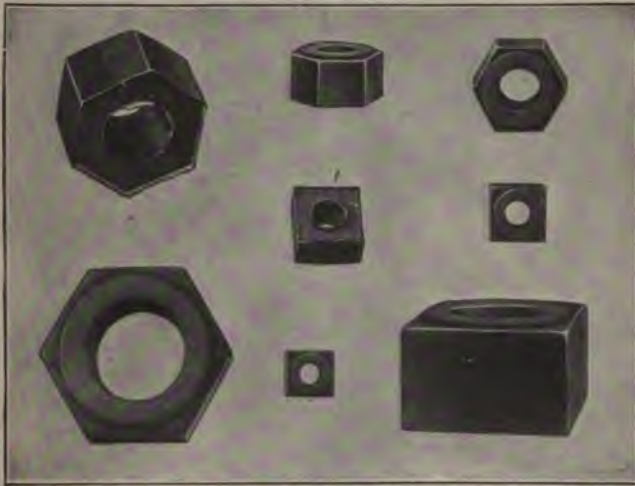

Fig. 36. Group of Square and Hexagon Nuts, showing Character of Work turned out in Hot-pressed Nut Machines

and the operator would find it difficult to turn them and keep up with the operation of the machine.

Fig. 38 shows a typical group of nuts which can be produced economically and on a commercial basis in the center-feed hot-pressed nut machine. In this illustration two of the nuts show fins on the under side, both around the outer edges and the hole. This is caused by the sharp edges of the cut-off tool becoming rounded and allowing the hot metal to "leak" past the edges. The clearance allowed between the cut-off punch and dies also tends to produce a slight fin. When the tools are new the burr or fin produced is very slight, but it increases as the tools wear. These fins are removed in a succeeding operation in a burring machine.

#### Hot-forged Nut Machine

Fig. 39 shows a type of nut making machine which is only applicable to the manufacture of square nuts, but produces this class of nuts free from fins and burrs at a rapid rate. Nut manufacturers who

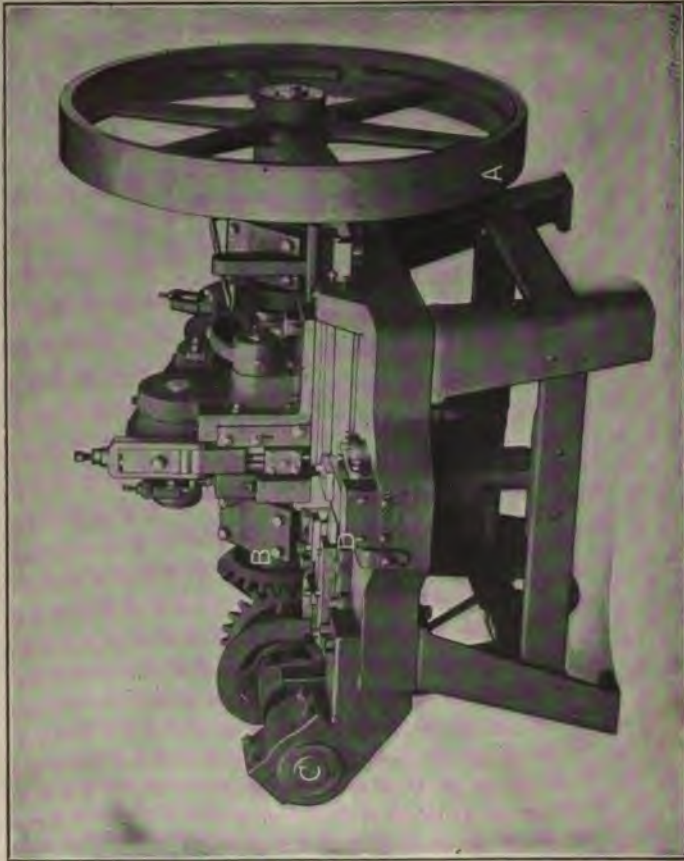

Fig. 39. "National" Hot-forged Nut Machine used exclusively for the Manufacture of Square Nuts from Rectangular Bar Stock

produce in great quantities are extensive users of this type of machine, but a concern making a variety of nuts in small quantities should not attempt to use it, owing to the delay incident to changing the dies and tools from one size to another. Briefly stated, the machine consists principally of a suitable mechanism for operating a shearing and crowning tool, four horizontal hammers which form the four sides of a square nut, and piercing and flattening punches. Power is transmitted from pulley *A* to the two shafts *B* and *C* located at right angles to each other and connected by miter gears. Shaft *C* carries eccentrics and cams which operate the left-side hammer and sizing tool for gripping the bar while it is being sheared; and shaft *B*, through cams, levers and eccentrics, operates the blank shearing tool, nut ejector, front and rear hammers, piercing punch and flattening tools.

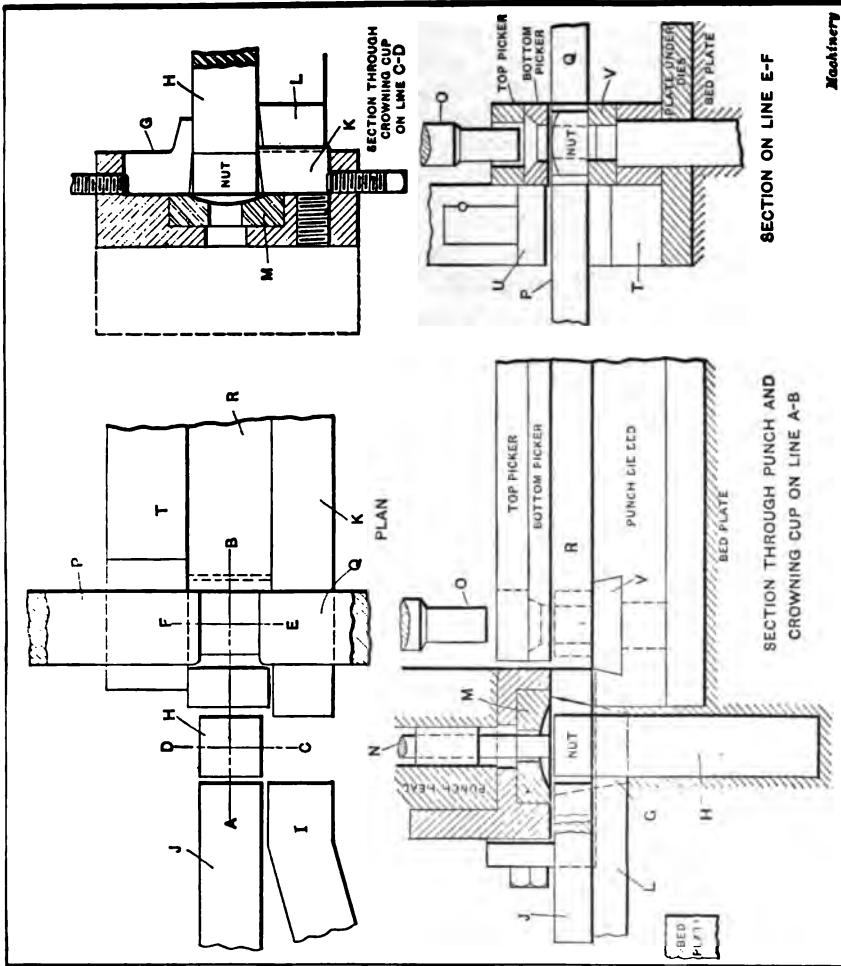

Fig. 40. Construction of Tools and Operation of the Hot-forged Type of Nut Machine shown in Fig. 39

Operation of Hot-forged Nut Machine

In order to illustrate how this hot-forged nut machine produces square nuts, the diagrams shown in Fig. 40 are included. These views show plan and sectional elevations which illustrate the relative positions of the various dies and tools, and the stages through which the nut passes before being ejected. In operating this machine, rectangular bar stock heated to a length of four or five feet is fed into the machine (see *D*, Fig. 39) along the line *CD*. The stock is equal in width to the diameter of the nut across the flats, and of the same thickness as the nut. It is fed into the machine with the greatest width horizontal and is located by the gage *G*.

As the heated bar is fed in, a shearing tool *H*, operated from the bottom of the machine, forces the heated end of the bar against the knife *K* and cuts off

a suitable blank; as this tool continues to rise, it presses the nut blank into the crowner cup *M*, which is located directly above the shearing tool. While the shearing operation is taking place, the sizing tool *I*, which moves in a line parallel with the side hammer *J*, holds the bar tightly against the stationary sizer *K*.

Gripping the bar in this manner tends to give a better shearing cut. The shearing tool *H* is now lowered until its top face is in line with the bottom of the side hammer *J*, and at the same time the kickout *N*, operated through a hole in the crowner *M*, ejects the nut, preventing it from sticking in the cup. The shearing tool now remains in its "down" position while the side hammer *J* carries the nut along line

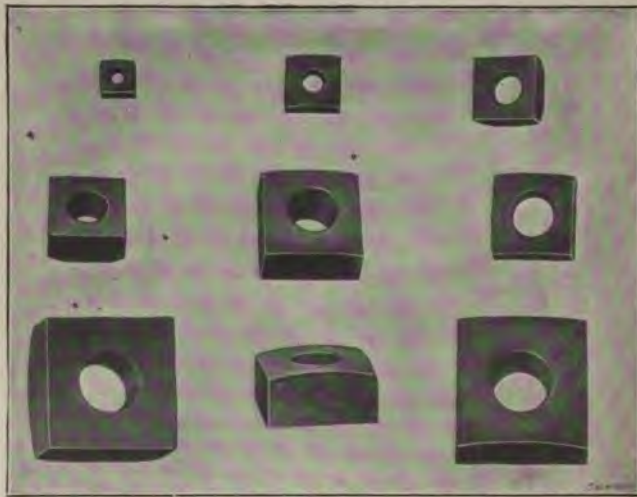

Fig. 41. Samples of Square Nuts produced on Hot-forged Type of Nut Machine—Note Absence of Burrs or Fins

*AB* until the center of the nut is in line with *EF* and directly under the piercing punch *O*.

As the side hammer *J* moves the nut blank under the piercing punch, the rear hammer *P* advances and presses the nut into the square box formed by the side hammer *J*, rear hammer *P*, stationary hammer *R* and front hammer *Q*. This tends to square up the sides of the nut and form it to the proper shape. While in this position, the punch *O* pierces the hole in the nut, forcing the wad through the die *V*, and immediately withdraws. The rear hammer *P* and side hammer *J* then return to their original positions, and the front hammer *Q* moves the nut back to the flatter bed *T*, which is located directly under the rear hammer *P*. While the nut is located on the flatter bed, the flattening tool *U*, which is over the rear hammer, comes down onto the nut, gives it a slight squeeze, which corrects any distortion of the top and bottom faces caused by the squeezes between the four hammers previously described, and also serves to flatten any

fins resulting from the piercing operation. The flattening tool *U* then rises, and the flatter bed *T* withdraws, allowing the finished nut to drop out of the machine. A completed nut is made at each revolution of the flywheel, and the machine is operated at from 60 to 90 revolutions per minute, depending upon its size.

Some idea of the character of the work turned out by the hot-forged nut machine can be obtained from Fig. 41, which shows a representative group of square nuts just as they come from the machine. The nuts produced by these machines are entirely free from fins or burrs, are of excellent finish, and are ready for tapping directly after being forged.

#### Dies and Tools Used in Hot-pressed Center-fed Nut Machines

The type of dies and tools used in the hot-pressed center-fed nut machine shown in Fig. 32 is shown in Fig. 42. The reference letters



Fig. 42. Type of Dies and Tools used in making Hexagon Nuts in Center-fed Hot-pressed Nut Machine shown in Fig. 32

used here are the same as those in Fig. 36. The dies *a* and *b*, which are reversible, are usually made from chilled iron castings, and are ground to size. Dies made from this material, it is claimed, will last fully eight times as long as those made from ordinary carbon steel, but as it is somewhat of a problem to get the proper amount of "chill," many manufacturers are using a good grade of open-hearth steel instead. A crucible steel which has been found to give good results for this class of work contains from 0.90 to 1.10 per cent carbon. Some nut manufacturers have found that a certain grade of vanadium alloy steel having a carbon content of from 0.15 to 0.30 per cent

gives excellent results when used for nut dies. In all cases, of course, it is necessary to harden the dies, and those made from crucible tool steel are hardened and drawn so that they can just be touched with the file, or in other words, the temper is drawn to a light straw color.

The composition of vanadium steel used for dies varies. Two grades of vanadium tool steel are recommended for forging machine dies by the American Vanadium Co., of Pittsburg, Pa. One is composed of carbon, 0.50 per cent; chromium, 0.80 to 1.10 per cent; manganese, 0.40 to 0.60 per cent; vanadium, not less than 0.16 per cent; silicon, not more than 0.20 per cent.

The heat-treatment recommended for this steel is as follows: Heat to 1550 degrees F. and quench in oil; then reheat to from 1425 to 1450 degrees F., and quench in water, submerging the face of the die only.

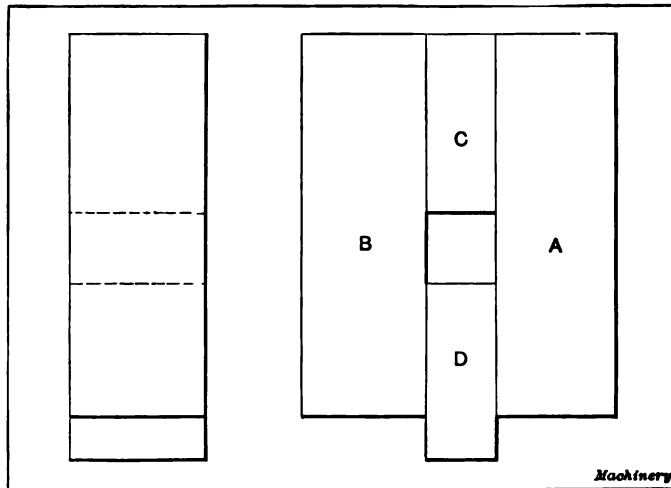

Fig. 43. Type of Dies used in making Square Nuts in Machine of the Type shown in Fig. 32

When this method is used, the die is drawn by the heat remaining in the body and is thus tempered, and the life of the die increased.

The second kind of vanadium tool steel recommended has the following analysis: Carbon, 0.65 to 0.75 per cent; manganese, 0.40 to 0.60 per cent; vanadium, not less than 0.16 per cent; silicon, not more than 0.20 per cent. The heat-treatment for this steel should be as follows: Heat to 1525 degrees F. and quench in water with the face of the die only submerged.

The length of life of vanadium steel dies is stated to be about six times the life of dies made from ordinary high-carbon tool steel.

The cut-off tool c is generally made from ordinary carbon tool steel, hardened and drawn. Some attempts have been made to use high-speed steel for this tool, but as this material is rather expensive, and as this particular tool wears away very rapidly, a cheaper brand of



steel is generally adopted. The piercing tool *f* when made from "Rex A" high-speed steel has been found very satisfactory for hot punching. The crowning tool *e* and wad extractor *d* can be made from ordinary carbon tool steel, hardened and drawn.

In order that the tools in a center-feed hot-pressed nut machine may work freely, it is necessary to provide a certain amount of clearance, especially between the cut-off tool, crowning tool and dies. On nuts from  $\frac{1}{2}$  to 2 inches in diameter (this is the size of the bolt for which the nut is used),  $\frac{1}{64}$  inch clearance is allowed. On sizes smaller than  $\frac{1}{2}$  inch, 0.010 inch clearance is allowed, whereas for tools used in making nuts larger than 2 inches, a clearance of from 0.020 to 0.060 inch is provided. The hole formed by the junction of the two halves of the dies is made perfectly straight, but the piercing tool is slightly tapered—being smaller at the front end. This enables it to withdraw more easily from the hole in the nut, and also increases its life. It is evident, of course, that after the hole is punched in the nut, the chilling effect of the dies (which are kept cool by water flowing over them) tends to "freeze" the nut onto the piercing tool, but the slight taper on the piercing tool prevents this.

There is no allowance made in the hole of the nut to provide for shrinkage, as the holes regularly punched in nuts are made considerably larger than the root diameter of the threads on the tap. The nuts can then be more easily tapped, and the percentage of tap breakages is reduced.

In Fig. 43 is shown the shape of the dies used for making square nuts in a center-feed hot-pressed nut machine. It will be seen that these dies are made in four pieces, and it is possible to raise or lower the outside blocks *A* and *B*, so that new cutting edges are secured. In addition to this the top and bottom dies *C* and *D* can be reserved, and also the two side pieces, thus giving long life for one redressing of the dies. As a rule, this type of dies is made from ordinary crucible tool steel containing from 0.90 to 1.00 per cent carbon, hardened and drawn, and ground all over.

#### Dies and Tools Used in Hot-forged Nut Machines

The four hammers used in the hot-forged nut machines are made from rectangular blocks of steel, shaped as shown in Fig. 40. The rear, front and stationary hammers are made wider than the nut, but of approximately the same thickness, and the front and rear hammers are rounded on the forward corners, to facilitate the insertion of the nut. The side hammer, which carries the nut into the "box-shaped impression" formed by all four hammers, is of the same width and thickness as the nut. The crowner, flatter tool and the four hammer blocks are all made from ordinary crucible steel, hardened and drawn, whereas the shearing tool and piercing punch and die are usually made from high-speed steel. The brand of steel known as "Rex A" has been found very satisfactory for this



purpose. The tools used in the hot-forged nut machine do not wear out nearly so quickly as those used in the hot-pressed type of machine, owing to the fact that there is not the same scraping action against the surfaces of the tools.

**Sizes of Rectangular Stock Used in Making Square and Hexagon Nuts**

In making nuts in center-feed hot-pressed nut machines of the types shown in Figs. 34 and 35, rectangular bar stock as shown in Fig. 37 is used. To allow for upsetting the stock slightly and pressing it into the desired shape, a rectangular bar is used which is slightly thicker than the finished nut, and slightly less in width than the diameter of the nut across the flats. As explained in a previous paragraph, in order to produce a perfectly shaped nut it is necessary to waste a certain amount of stock as indicated at *a* and *b* in Fig. 44. The amount of stock wasted depends upon the size of the nut and to a

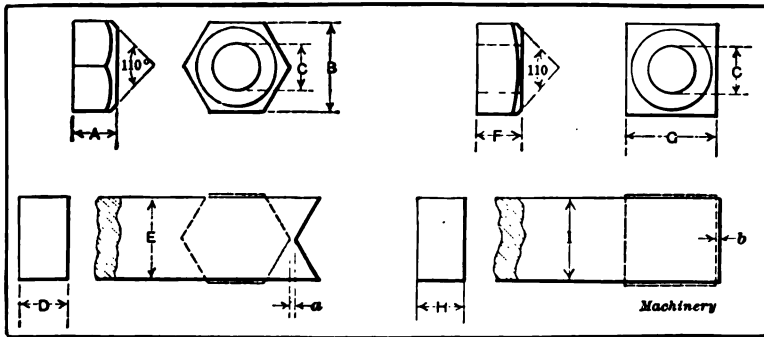
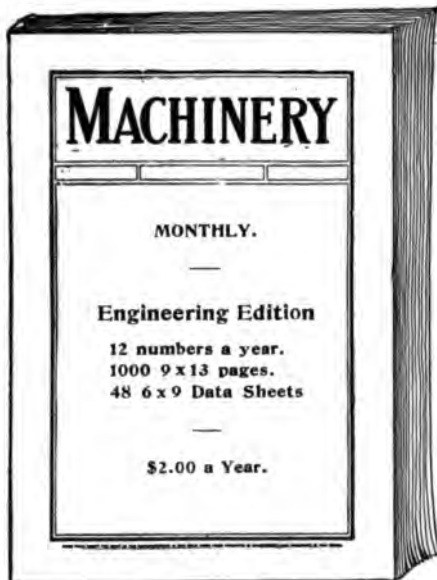

Fig. 44. Proportions of Standard Hexagon and Square Nuts; see Table on Opposite Page

slight extent upon the temperature at which the bar is being worked.

In producing a hexagon nut, only the front triangular corner is rounded (owing to the drawing over of the hot metal), whereas on a square nut, the entire front corner of the nut is rounded. A considerable saving of metal can be effected by turning the bar after each stroke of the machine, thus presenting opposite faces of the bar to the dies, as was previously explained. This can easily be done in making the smaller size of nuts where the bar does not exceed 40 to 80 pounds in weight. For large nuts, instead of turning the bar, a small amount of stock is wasted, as indicated at *a* and *b* in Fig. 44, which varies from 1/16 to 1/4 inch, depending upon the size of the nut.

The hot-forged type of nut-making machine shown in Fig. 39 has the advantage over the center-feed hot-pressed machine of not wasting any stock. The hot-forged nut machine, however, is only suitable for the manufacture of square nuts, and is only used where this type of nut is made in large quantities.



**M**ACHINERY is the leading journal in the machine-building field and meets the requirements of the mechanical engineer, superintendent, designer, tool-maker and machinist, as no other journal does. MACHINERY is a monthly and deals with machine design, tool design, machine construction, shop practice, shop systems and shop management. The reading matter in MACHINERY is written by practical men and edited by mechanical men of long practical training. The twelve numbers a year contain a thousand

pages of carefully selected and edited mechanical information.

Each number of MACHINERY contains a variety of articles on machine shop practice. These articles include carefully prepared descriptions of manufacturing methods and current mechanical developments. Shop systems and shop management are ably handled by the foremost writers. Every number contains the most extensive and complete monthly record published by any journal, or in any form, of new machinery and tools and accessories for the machine shop. A special department is devoted to "Letters on Practical Subjects," to which practical mechanics contribute their experiences. There is a department of Shop Kinks—brief, concise little contributions which contain ideas of value to the man in the shop or at the drafting table.

The mechanical engineer, machine designer and draftsman are also well provided for in MACHINERY. Every number contains articles on the theory and practice of machine design, on the properties of materials, and on labor-saving methods and systems. There are reviews of research work in the mechanical field, valuable results of carefully made experiments are recorded, and the world's progress in every field of mechanical endeavor is closely watched.

One of the most valuable features is the four-page monthly Data Sheet Supplement printed on strong manila paper. These Data Sheets contain high-grade, condensed mechanical data, covering machine design, machine operation and kindred subjects. They are the cream of mechanical information.

- No. 67. Boilers.
- No. 68. Boiler Furnaces and Chimneys.
- No. 69. Feed Water Appliances.
- No. 70. Steam Engines.
- No. 71. Steam Turbines.
- No. 72. Pumps, Condensers, Steam and Water Piping.

**LOCOMOTIVE DESIGN AND RAILWAY SHOP PRACTICE**

- No. 27. Locomotive Design, Part I.
- No. 28. Locomotive Design, Part II.
- No. 29. Locomotive Design, Part III.
- No. 30. Locomotive Design, Part IV.
- No. 79. Locomotive Building. — Main and Side Rods.
- No. 80. Locomotive Building. — Wheels; Axles; Driving Boxes.
- No. 81. Locomotive Building. — Cylinders and Frames.
- No. 82. Locomotive Building. — Valve Motion.
- No. 83. Locomotive Building. — Boiler Shop Practice.
- No. 84. Locomotive Building. — Erecting.
- No. 90. Railway Repair Shop Practice.

**ELECTRICITY—DYNAMOS AND MOTORS**

- No. 34. Care and Repair of Dynamos and Motors.
- No. 73. Principles and Applications of Electricity. — Static Electricity; Electrical Measurements; Batteries.
- No. 74. Principles and Applications of Electricity. — Magnetism; Electric-Magnetism; Electro-Plating.
- No. 75. Principles and Applications of Electricity. — Dynamos; Motors; Electric Railways.
- No. 76. Principles and Applications of Electricity. — Telegraph and Telephone.
- No. 77. Principles and Applications of Electricity. — Electric Lighting.
- No. 78. Principles and Applications of Electricity. — Transmission of Power.
- No. 115. Electric Motor Drive for Machine Tools.

**HEATING AND VENTILATION**

- No. 39. Fans, Ventilation and Heating.
- No. 66. Heating and Ventilation of Shops and Offices.

**IRON AND STEEL**

- No. 36. Iron and Steel.
- No. 62. Hardness and Durability Testing of Metals.
- No. 117. High-speed and Carbon Tool Steel.
- No. 118. Alloy Steels.

**FORGING**

- No. 44. Machine Blacksmithing.
- No. 45. Drop Forging.
- No. 61. Blacksmith Shop Practice.
- No. 113. Bolt, Nut and Rivet Forging.
- No. 114. Machine Forging.
- No. 119. Cold Heading.

**MECHANICAL DRAWING AND DRAFTING-ROOM PRACTICE**

- No. 2. Drafting-Room Practice.
- No. 8. Working Drawings and Drafting-Room Kinks.
- No. 33. Systems and Practice of the Drafting-Room.
- No. 85. Mechanical Drawing. — Geometrical Problems.
- No. 86. Mechanical Drawing. — Projection.
- No. 87. Mechanical Drawing. — Machine Details.
- No. 88. Mechanical Drawing. — Machine Details.

**DIE-CASTING**

- No. 108. Die-Casting Machines.
- No. 109. Die-Casting, Dies and Methods.

**MISCELLANEOUS**

- No. 35. Tables and Formulas for Shop and Drafting-Room.
- No. 110. Extrusion of Metals.

**MACHINERY'S DATA BOOKS**

MACHINERY'S Data Books include the material in the well-known series of Data Sheets published by MACHINERY during the past fifteen years. Of these Data Sheets, nearly 700 were published and 7,000,000 copies sold. Revised and greatly amplified, they are now presented in book form, kindred subjects grouped together. The price of each book is 25 cents (one shilling) delivered anywhere in the world.

**LIST OF MACHINERY'S DATA BOOKS**

- |  |  |
|--|--|
| No. 1. Screw Threads.  | No. 11. Milling Machine Indexing, Clamping Devices and Planer Jacks.       |
| No. 2. Screws, Bolts and Nuts.   | No. 12. Pipe and Pipe Fittings.  |
| No. 3. Taps and Dies.  | No. 13. Boilers and Chimneys.  |
| No. 4. Reamers, Sockets, Drills and Milling Cutters.                   | No. 14. Locomotive and Railway Data.                                       |
| No. 5. Spur Gearing.   | No. 15. Steam and Gas Engines.   |
| No. 6. Bevel, Spiral and Worm Gearing.                                 | No. 16. Mathematical Tables.   |
| No. 7. Shafting, Keys and Keyways.                                     | No. 17. Mechanics and Strength of Materials.                               |
| No. 8. Bearings, Couplings, Clutches, Crane Chain and Hooks.           | No. 18. Beam Formulas and Structural Design.                               |
| No. 9. Springs, Slides and Machine Details.                            | No. 19. Belt, Rope and Chain Drives.                                       |
| No. 10. Motor Drive, Speeds and Feeds, Chain Gearing, and Boring Bars. | No. 20. Wiring Diagrams, Heating and Ventilation and Miscellaneous Tables. |



# MACHINERY'S HANDBOOK

For MACHINE SHOP  
AND DRAFTING-ROOM

---

A REFERENCE BOOK ON MACHINE  
DESIGN AND SHOP PRACTICE FOR  
THE MECHANICAL ENGINEER,  
DRAFTSMAN, TOOLMAKER AND  
MACHINIST.

---

MACHINERY'S Handbook comprises nearly 1400 pages of carefully edited and condensed data relating to the theory and practice of the machine-building industries. It is the first and only complete handbook devoted exclusively to the metal-working field, and contains in compact and condensed form the information and data collected by MACHINERY during the past twenty years. It is the one essential book in a library of mechanical literature, because it contains all that is of importance in the text-books and treatises on mechanical engineering practice. Price \$5.00.

## GENERAL CONTENTS

Mathematical tables—Principal methods and formulas in arithmetic and algebra—Logarithms and logarithmic tables—Areas and volumes—Solution of triangles and trigonometrical tables—Geometrical propositions and problems—Mechanics—Strength of materials—Riveting and riveted joints—Strength and properties of steel wire—Strength and properties of wire rope—Formulas and tables for spring design—Torsional strength—Shafting—Friction—Plain, roller and ball bearings—Keys and keyways—Clutches and couplings—Friction brakes—Cams, cam design and cam milling—Spur gearing—Bevel gearing—Spiral gearing—Herringbone gearing—Worm gearing—Epicyclic gearing—Belted and rope drives—Transmission chain and chain drives—Crane chain—Dimensions of small machine details—Speeds and feeds of machine tools—Shrinkage and force fit allowances—Measuring tools and gaging methods—Change gears for spiral milling—Milling machine indexing—Jigs and fixtures—Grinding and grinding wheels—Screw thread systems and thread gages—Taps and threading dies—Milling cutters—Reamers, counterbores and twist drills—Heat-treatment of steel—Hardening, casehardening, annealing—Testing the hardness of metals—Foundry and pattern shop information—The welding of metals—Autogenous welding—Thermit welding—Machine welding—Blacksmith shop information—Die casting—Extrusion process—Soldering and brazing—Etching and etching fluids—Coloring metals—Machinery foundations—Application of motors to machine tools—Dynamics and motor troubles—Weights and measures—Metric system—Conversion tables—Specific gravity—Weights of materials—Heat—Pneumatics—Water pressure and flow of water—Pipes and piping—Lutes and cements—Patents.

---

MACHINERY, the leading journal in the machine-building field, the originator of the 25-cent Reference and Data Books. Published monthly. Subscription, \$2.00 yearly. Foreign subscription, \$3.00.

THE INDUSTRIAL PRESS, Publishers of MACHINERY

140-148 LAFAYETTE STREET

NEW YORK CITY, U. S. A.

Furnaces and Chimneys.  
 Water Appliances.  
 Engines.  
 Turbines.  
 Condensers, Steam and Water

#### DESIGN AND RAILWAY SHOP PRACTICE

motive Design, Part I.  
 motive Design, Part II.  
 motive Design, Part III.  
 motive Design, Part IV.  
 motive Building.—Main and Side  
 motive Building.—Wheels; Axles;  
 ing Boxes.  
 motive Building.—Cylinders and  
 ss.  
 motive Building.—Valve Motion.  
 motive Building.—Boiler Shop Prac-  
 motive Building.—Erecting.  
 ay Repair Shop Practice.

#### TY—DYNAMOS AND MOTORS

and Repair of Dynamos and Motors.  
 ples and Applications of Electricity.  
 tic Electricity; Electrical Measure-  
 s; Batteries.  
 ples and Applications of Electricity.  
 gnetism; Electric-Magnetism; Electro-  
 mating.  
 ples and Applications of Electricity.  
 namos; Motors; Electric Railways.  
 ples and Applications of Electricity.  
 egraph and Telephone.  
 ples and Applications of Electricity.  
 tric Lighting.  
 ples and Applications of Electricity.  
 nmission of Power.  
 tric Motor Drive for Machine Tools.

#### HEATING AND VENTILATION

No. 35. Fans, Ventilation and Heating.  
 No. 68. Heating and Ventilation of Shops and  
 Offices.

#### IRON AND STEEL

No. 36. Iron and Steel.  
 No. 62. Hardness and Durability Testing of  
 Metals.  
 No. 117. High-speed and Carbon Tool Steel.  
 No. 118. Alloy Steels.

#### FORGING

No. 44. Machine Blacksmithing.  
 No. 45. Drop Forging.  
 No. 61. Blacksmith Shop Practice.  
 No. 113. Bolt, Nut and Rivet Forging.  
 No. 114. Machine Forging.  
 No. 119. Cold Heading.

#### MECHANICAL DRAWING AND DRAFTING-ROOM PRACTICE

No. 2. Drafting-Room Practice.  
 No. 8. Working Drawings and Drafting-Room  
 Kinks.  
 No. 33. Systems and Practice of the Drafting-  
 Room.  
 No. 55. Mechanical Drawing.—Geometrical Prob-  
 lems.  
 No. 86. Mechanical Drawing.—Projection.  
 No. 87. Mechanical Drawing.—Machine Details.  
 No. 88. Mechanical Drawing.—Machine Details.

#### DIE-CASTING

No. 108. Die-Casting Machines.  
 No. 109. Die-Casting, Dies and Methods.

#### MISCELLANEOUS

No. 35. Tables and Formulas for Shop and Draft-  
 ing-Room.  
 No. 110. Extrusion of Metals.

### MACHINERY'S DATA BOOKS

ry's Data Books include the material in the well-known series of Data  
 shed by MACHINERY during the past fifteen years. Of these Data Sheets,  
 vere published and 7,000,000 copies sold. Revised and greatly amplified,  
 w presented in book form, kindred subjects grouped together. The price  
 c is 25 cents (one shilling) delivered anywhere in the world.

#### LIST OF MACHINERY'S DATA BOOKS

Threads.  
 s, Bolts and Nuts.  
 and Dies.  
 ers, Sockets, Drills and Milling Cut-  
 Gearing.  
 Spiral and Worm Gearing.  
 ng, Keys and Keyways.  
 gs, Couplings, Clutches, Crane  
 s and Hooks.  
 s, Slides and Machine Details.  
 Drive, Speeds and Feeds, Change  
 ng, and Boring Bars.

No. 11. Milling Machine Indexing, Clamping De-  
 vices and Planer Jacks.  
 No. 12. Pipe and Pipe Fittings.  
 No. 13. Boilers and Chimneys.  
 No. 14. Locomotive and Railway Data.  
 No. 15. Steam and Gas Engines.  
 No. 16. Mathematical Tables.  
 No. 17. Mechanics and Strength of Materials.  
 No. 18. Beam Formulas and Structural Design.  
 No. 19. Belt, Rope and Chain Drives.  
 No. 20. Wiring Diagrams, Heating and Ventila-  
 tion and Miscellaneous Tables.

## MACHINERY'S REFERENCE BOOKS

This book is one of a remarkably successful series of 25-cent Reference Books listed below. These books were originated by MACHINERY and comprise a complete working library of mechanical literature, each book covering one subject. The price of each book is 25 cents (one shilling) delivered anywhere in the world.

### CLASSIFIED LIST OF REFERENCE BOOKS

#### GENERAL MACHINE SHOP PRACTICE

- No. 7. Lathe and Planer Tools.
- No. 10. Examples of Machine Shop Practice.
- No. 15. Deep Hole Drilling.
- No. 32. Screw Thread Cutting.
- No. 48. Files and Filing.
- No. 50. Principles and Practice of Assembling Machine Tools, Part I.
- No. 51. Principles and Practice of Assembling Machine Tools, Part II.
- No. 57. Metal Spinning.
- No. 59. Machines, Tools and Methods of Automobile Manufacture.
- No. 91. Operation of Machine Tools.—The Lathe, Part I.
- No. 92. Operation of Machine Tools.—The Lathe, Part II.
- No. 93. Operation of Machine Tools.—Planer, Shaper, Slotter.
- No. 94. Operation of Machine Tools.—Drilling Machines.
- No. 95. Operation of Machine Tools.—Boring Machines.
- No. 96. Operation of Machine Tools.—Milling Machines, Part I.
- No. 97. Operation of Machine Tools.—Milling Machines, Part II.
- No. 98. Operation of Machine Tools.—Grinding Machines.
- No. 116. Manufacture of Steel Balls.
- No. 120. Arbors and Work Holding Devices.

#### TOOLMAKING

- No. 21. Measuring Tools.
- No. 31. Screw Thread Tools and Gages.
- No. 64. Gage Making and Lapping.
- No. 107. Drop Forging Dies and Die Sinking.

#### HARDENING AND TEMPERING

- No. 46. Hardening and Tempering.
- No. 63. Heat-treatment of Steel.

#### JIGS AND FIXTURES

- No. 3. Drill Jigs.
- No. 4. Milling Fixtures.
- No. 41. Jigs and Fixtures, Part I.
- No. 42. Jigs and Fixtures, Part II.
- No. 43. Jigs and Fixtures, Part III.

#### PUNCH AND DIE WORK

- No. 6. Punch and Die Work.
- No. 13. Blanking Dies.
- No. 26. Modern Punch and Die Construction.

#### AUTOMATIC SCREW MACHINE WORK

- No. 99. Operation of Brown & Sharpe Automatic Screw Machines.
- No. 100. Designing and Cutting Cams for the Automatic Screw Machine.

- No. 101. Circular Forming and Cut-off Tools for Automatic Screw Machines.
- No. 102. External Cutting Tools for Automatic Screw Machines.
- No. 103. Internal Cutting Tools for Automatic Screw Machines.
- No. 104. Threading Operations on Automatic Screw Machines.
- No. 105. Knurling Operations on Automatic Screw Machines.
- No. 106. Cross Drilling, Burring and Slotting Operations on Automatic Screw Machines.

#### SHOP CALCULATIONS

- No. 18. Shop Arithmetic for the Machinist.
- No. 52. Advanced Shop Arithmetic for the Machinist.
- No. 53. The Use of Logarithms—Complete Logarithmic Tables.
- No. 54. Solution of Triangles, Part I.
- No. 55. Solution of Triangles, Part II.

#### THEORETICAL MECHANICS

- No. 5. First Principles of Theoretical Mechanics.
- No. 19. Use of Formulas in Mechanics.

#### GEARING

- No. 1. Worm Gearing.
- No. 15. Spur Gearing.
- No. 20. Spiral Gearing.
- No. 37. Bevel Gearing.

#### GENERAL MACHINE DESIGN

- No. 9. Designing and Cutting Cams.
- No. 11. Bearings.
- No. 17. Strength of Cylinders.
- No. 22. Calculation of Elements of Machine Design.
- No. 24. Examples of Calculating Designs.
- No. 40. Flywheels.
- No. 56. Ball Bearings.
- No. 58. Helical and Elliptic Springs.
- No. 89. The Theory of Shrinkage and Forced Fits.

#### MACHINE TOOL DESIGN

- No. 14. Details of Machine Tool Design.
- No. 16. Machine Tool Drives.
- No. 111. Lathe Bed Design.
- No. 112. Machine Stops, Trips and Locking Devices.

#### CRANE DESIGN

- No. 23. Theory of Crane Design.
- No. 47. Electric Overhead Cranes.
- No. 49. Girders for Electric Overhead Cranes.

#### STEAM AND GAS ENGINES

- No. 65. Formulas and Constants for Gas Engine Design.

SEE INSIDE BACK COVER FOR ADDITIONAL TITLES



