

TJ

7

M3

v.76

UC-NRLF



B 3 018 803

5 CENTS

PRINCIPLES AND APPLICATIONS OF

# ELECTRICITY

PART IV—ELECTRIC LIGHTING

SECOND EDITION

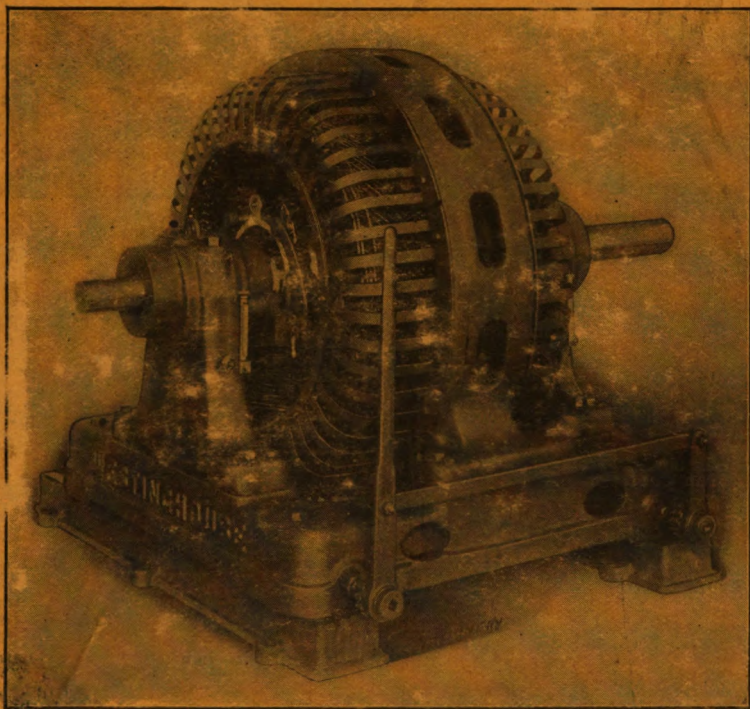

MACHINERY'S REFERENCE BOOK NO. 76  
PUBLISHED BY MACHINERY, NEW YORK

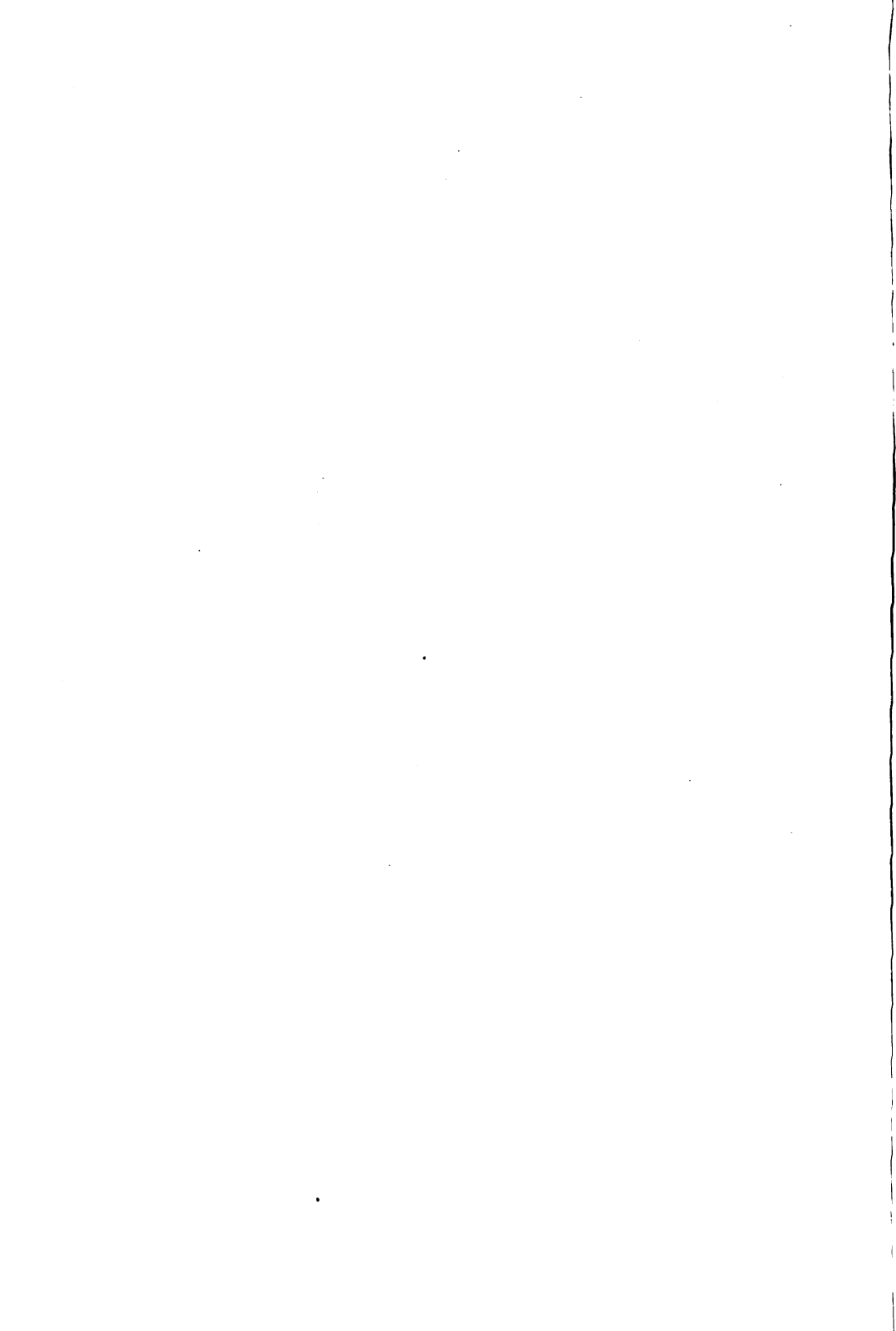

# MACHINERY'S REFERENCE SERIES

EACH NUMBER IS A UNIT IN A SERIES ON ELECTRICAL AND  
STEAM ENGINEERING DRAWING AND MACHINE  
DESIGN AND SHOP PRACTICE

NUMBER 76

## PRINCIPLES AND APPLICATIONS OF ELECTRICITY

PART IV  
ELECTRIC LIGHTING

SECOND EDITION

### CONTENTS

Arc Lamp Lighting - - - - -	3
Incandescent Lighting - - - - -	13
The Incandescent Lamp and its Manufacture - - -	25
Special Types of Lamps - - - - -	37

TJ7  
103  
2176

19 1911  
1911

## CHAPTER I

### ARC LAMP LIGHTING

Electric lighting has progressed with wonderful rapidity during the last two or three decades. Totally distinct systems have become merged into one, and power transmission has become a stepping stone to electric lighting proper, alternating currents being transmitted and converted into direct currents without difficulty. In fact, the greatest operating systems found in New York and other large cities in the United States combine high-pressure alternating power transmission with low-pressure direct-current distributing systems.

One of the earliest investigators of electric light was Sir Humphrey Davy, who in 1810 produced the first electric arc of any magnitude. During the middle of the last century considerable experimenting was done for producing a satisfactory arc lamp, but the attempts were not successful, chiefly on account of the lack of a satisfactory source of electricity, the battery being the only source of power. The invention of the Gramme dynamo in 1870 made new investigations and inventions possible. The Jablochhoff electric light was first introduced in 1876, and from this time the development of electric light has been very rapid. The incandescent lamp was used merely as a laboratory apparatus up to 1878, when a lamp was produced consisting of a platinum spiral in a vacuum. The first successful carbon filament lamp was made in 1879.

Electric lighting may be done either with an alternating or a direct current. Often an alternating current is used for the transmission lines, and is converted into a direct current at the point of distribution. There is no essential difference as far as the lamps and lighting are concerned, the sole difference being in the power plant and distribution. For smaller systems a direct current generator is often employed. The lighting may be done by means of a constant-current or by means of a constant-potential system. Dynamos suitable for the generation of these currents are termed constant-current and constant-potential dynamos, respectively. Constant-current dynamos are designed for the purpose of supplying energy to arc lamps, and constant-potential dynamos for the purpose of supplying energy to incandescent lamps.

#### Arc Lamps

The light in arc lamps is produced by two carbon rods which are connected in an electric circuit so that the circuit is closed by the contact of the tips of the carbon rods. When after such contact the carbon rods are again separated, the electric circuit is not broken if the space between the carbons is not made too great, and an arc of light will be

formed between the two points. The light emitted is due to the intense heat of the tips of the carbon rods, and also, to a smaller degree, to the arc itself.

When direct current is used for arc lighting, most of the light is produced by the end of the upper or positive carbon rod, or electrode, which acquires a hollow center known as the crater of the arc, as shown in Fig. 1. This crater, which throws the light downward, has a temperature of from 5,500 to 6,000 degrees F., a temperature that is high enough to vaporize carbon. The lower or negative carbon rod or electrode becomes pointed at the same time as the positive one is hollowed out. The carbons are consumed by the passage of the current, the positive electrode being reduced in size about twice as fast as the negative.

When an alternating current is used for arc lamps the upper carbon becomes alternately the positive and the negative electrode, and in this case no crater is formed; but both electrodes become pointed and the

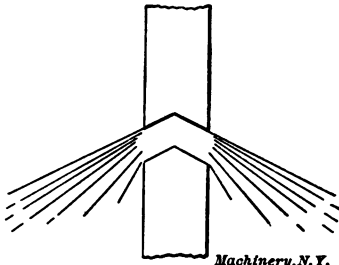

Fig. 1. Crater of Arc Lamp Carbon

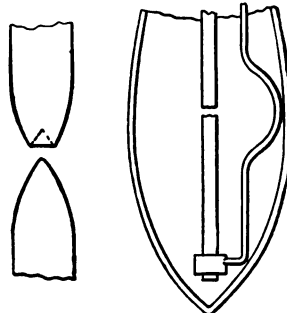

Fig. 2. Carbons Burning in Air and Enclosed in Globe

two electrodes give off about the same amount of light and are consumed with about the same rapidity. The great illuminating property of the crater in the direct-current arc, however, is lost, and the light given out by the alternating current arc is thrown upwards as much as downwards, which makes it necessary to use a reflector in order to take advantage of the full effect of the light produced.

#### Requirements in the Operation of Arc Lamps

It is evident that as the carbon rods are consumed, some arrangement must be provided for maintaining the tips at the proper distance apart, so that the current can flow continually without interruption. The mechanism for maintaining the distance between the carbons must be automatic, and must perform four distinct functions, as follows:

- 1.—The carbons should be in contact or be brought into contact when the current begins to flow through the lamp for the production of light.
- 2.—Immediately after the current has commenced to flow, the carbon rods should be separated a certain distance for forming an arc of light between the points.
- 3.—The carbon rods should be fed forward at the same rate as that at which they are consumed.

4.—When the carbons are entirely consumed, the circuit should be either opened or closed, according to the manner of power distribution used.

There are a number of different mechanisms used for producing the results desired. They all depend upon the action of a solenoid—that is, a soft iron core enclosed in and magnetized by a coil of wire through which an electric current flows—which acts against the force of gravity or against springs. In one type of mechanism, called the shunt-lamp type, the carbons are held apart until the current is turned on, and a solenoid is connected across the gap thus formed. When the current is turned on, it passes first through the solenoid coil, and the plunger or core of the solenoid forces the carbons together, thus starting the arc. The springs are so adjusted in relation to the pull of the solenoid that the carbons are separated again and the arc maintained at its proper length.

In another type called the series-lamp mechanism, the carbons are in contact when the current is turned on, and the current, flowing through a pair of solenoid coils in series, separates them immediately, thus producing the arc. The distance between the carbon electrodes is maintained by the fact that when the arc becomes too long, the resistance to the current is increased so that the strength of the current is lowered, and the pull on the solenoid weakened. Thus the carbons will feed automatically together by gravity until equilibrium is again established.

In a third type of mechanism, called the differential type, a combination of the two previously mentioned types is used. The carbons are in contact when the current is turned on, and series coils are used for separating them, while a shunt coil of the same type as used in the shunt lamp, and which is connected across the arc, prevents the electrodes from being pulled too far apart.

The mechanical methods used for securing and feeding the carbons may be divided into two classes, known as the rod feed and the carbon feed. In the rod-feed type of lamp the upper carbon electrode is supported by a metal rod, to which the regulating mechanism is attached. The current is fed to this rod by means of a sliding contact. In the carbon-feed lamps the controlling mechanism is connected directly to the carbon by means of a kind of releasing clutch which grips the carbon when it is to be lifted, but releases its grip when the tension is released.

#### Types of Arc Lamps

An early type of lamp, called the double carbon lamp, employed two pairs of carbons which were used for the purpose of increasing the life of the lamp. In this type the two sets of carbons were so arranged that when one pair of the carbon rods was consumed, the other pair went into action. Later improvements in arc lamp construction have made this type obsolete. The old type of arc lamp consumed about 10 amperes at 50 volts. The new type, with a closed globe, as shown in Fig. 2, takes about 12 amperes at 80 volts. The older type was built

with the carbons burning in the air, while the newer and improved type has them enclosed in a small globe supplied with a valve. When the oxygen in the air is consumed inside of this globe, only carbon monoxide and nitrogen remain, which are perfectly neutral gases as far as combustion is concerned. The result is that there is no further oxidation of the carbons, and the period of their usefulness is increased from the 8 or 10 hours common in the older designs to from 100 to 150 hours in the most improved designs. The increase in power required through the introduction of the later type is counterbalanced, in a financial sense, by the saving in labor in renovating the carbons, and, to some extent, by the saving in the carbons themselves, although, as we shall presently see, some of these advantages are offset to a serious degree by other considerations, and, in some respects, at least, the advantages are more apparent than real.

#### The Enclosed Type of Arc Lamp

In the enclosed type of arc lamp the access of air is restricted, as already mentioned, and in consequence of this all the oxygen contained in the enclosure is consumed shortly after the arc is struck and the contents within the enclosure is converted into carbon monoxide gas which is unable to support further combustion. The carbons then slowly volatilize, and the arc is maintained across the heated carbon vapor. The enclosure, however, is not made fully air-tight, as such an arrangement would be difficult to maintain, but the access of air is carefully restricted. Owing to the fact that there is practically no burning of the carbons, a much longer arc can be employed than that used in the open type, and hence a correspondingly higher difference of potential between the lamp terminals. The carbons remain practically flat at the ends instead of acquiring the pointed negative and coned positive electrode shape found in the open type.

For a given power, however, the enclosed type of lamp gives rather less light than the open form, and while the carbons last much longer, it must be remembered that only carbons of the best quality can be used for enclosed arc lamps. Cheaper carbons, such as would give good results in an open lamp, cannot be used for the enclosed type, because it is found that after a few hours' run, a thick white coating, consisting chiefly of silica, deposits itself over the inner surface of the enclosing glass covering, and this coating absorbs a large proportion of the light. Hence a more expensive carbon must be used, so that the saving in the actual cost of carbons is not as great as might be expected, while, of course, the cost of attention and trimming is largely reduced.

Due to the fact, however, that the carbons last so much longer in the enclosed type of lamp, there is a tendency to neglect the lamps until they require fresh carbons, and when the globes become coated with more or less thickly deposited silica, a considerable amount of the light is absorbed, so that the efficiency of the lamps is reduced. To avoid this the globes must be regularly cleaned, and this, in effect, reduces materially one of the chief advantages of the enclosed arc, as it takes nearly as much time to properly clean the globes as it would to replace



the carbons. The direct-current open type arc lamp also burns very steadily when once a proper crater has been formed, but the enclosed lamp has a rather unsteady arc which wanders around the edges and over the faces of the carbon ends; hence in many cases the inner and outer enclosing globes are made of opalescent glass, especially when a steady light is essential. The advantage of not having to replace carbons except at long intervals, and the consequent elimination of the risk of the lamps going out frequently because of burnt out carbons, constitutes, however, a more valuable feature than these defects, and the enclosed arc lamp has practically superseded older forms.

When the current running through an arc lamp is increased beyond a certain value for any given size of carbons, or when the arc of the lamp is reduced beyond a certain point, a peculiar hissing noise is heard, and the light produced is materially diminished. The hissing continues more or less irregularly until the length of the arc has been

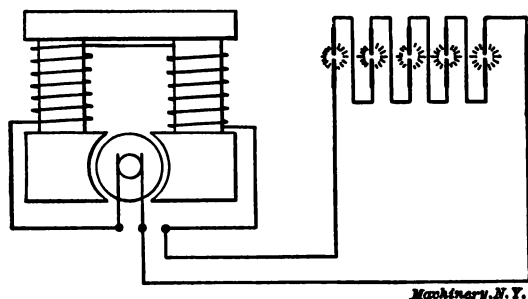

Fig. 3. Arc Lamps Connected in Series

re-established or the current diminished. In direct-current lamps, the positive carbon is frequently made with a core of softer carbon having a lower specific resistance. This assists in the formation of a good crater and thus is conducive to steadier and better burning of the lamp.

#### Current Supply for Arc Lamps

Arc lamps can, as already mentioned, operate either by direct current or alternating current and may be connected either in series or in multiple. There are, of course, still a great many open lamps used, but almost all lamps used in connection with alternating current or in connection with constant-potential direct current, are of the enclosed type.

The open arc lamps are always connected in series, the current being usually produced by a constant-current dynamo which is series-wound so that the current developed in the armature passes through the outside series circuit and then through the field windings back to the armature again. The illustration Fig. 3 clearly shows the simple character of this system. In the series system of electric lighting each arc lamp requires a certain current and pressure in order to give the candle power expected.

The arc lamps for constant-potential direct-current systems are similar to those used for direct-current series systems, but must be provided with a resistance connected in series with them. By this means the voltage of the arc is kept at its required value. The lamps for alternating-current circuits are similar in construction to those for direct currents, although they differ in some details. Arc lamps are made which can be adjusted so as to operate either on direct or alternating current and also at varying voltages.

When the electric current is produced by an alternator it may, as mentioned, either be used directly as an alternating current in the arc lamps or be converted into a direct current. When a constant-current dynamo is used for the production of the electric current, some regulation becomes necessary, and the methods used for this purpose will be explained in the following.

#### Constant Current Regulation

The regulation of a series dynamo connected to a series circuit requires a method by which the dynamo is capable of automatically increasing or decreasing its difference of potential as the number of lamps are increased or decreased in its circuit. If, for instance, 20 lamps of the older type were employed, each lamp requiring 50 volts and 10 amperes, a current of 10 amperes and 1,000 volts must be sustained, and the dynamo is required to automatically regulate its voltage and current if one-half or one-quarter of the lamps are cut off. This means that if 10 lamps are on the circuit 500 volts only are needed, 15 lamps, 750 volts, etc., as under all these circumstances of change the 10 amperes remain constant. The problem is that of a circuit in which, with every increase of resistance, an increase of voltage must take place. The means employed for the regulation of the voltage of a dynamo can be classified under the following heads: Increasing or decreasing the speed, increasing or decreasing the lines of force, and increasing or decreasing the armature conductors.

It is quite evident that it is not practical to attempt to change the speed to suit each particular voltage. The other two methods given have, however, been successfully carried out. The varying of the magnetic field is done by means of a resistance placed across the terminals of the field winding, so controlled by automatic means that when greater voltage is required, this resistance is increased, and when less voltage is required, the resistance is cut down.

#### Shunting the Field

The theory on which the method of changing the field strength is based, is as follows: If greater voltage is required of the dynamo, it can be generated if more lines of force are supplied to the rotating conductors. If an electro-magnet is placed in series with the outside circuit, a temporary increase or diminution of current caused for an instant by the lamps being increased or decreased in number, will make the coil a stronger or weaker electro-magnet. If the coil attracts a core of soft iron, which is attached by the proper mechanism to a pair

of carbons dipping into water, as shown in Fig. 4, and if the mechanism operates in such a manner that when the magnet is strengthened the carbons dip deeper, and when the magnet is weaker the carbons are lifted out, then the object is accomplished of weakening the field strength by shunting the fields when the pressure is too high outside, and increasing the field strength by lifting the carbons out when the outside pressure is too low. Tracing the circuits will show that the carbon rods dipping into the water offer a resistance which is greater or less across the field terminals according to the strength of the current in the main circuit. When the carbons dip deeply, current from the field passes through in such strength that the ampere turns are cut down and a smaller voltage is generated. When the carbons are lifted, less current passes through this liquid rheostat and more through the fields. In other words, the arrangement represents an adjustable resistance. The method outlined is theoretically correct, but the difficulty of adjusting the carbon rods and the resistance caused it to be superseded by the method described below, where the regulation is effected by shifting the dynamo brushes.

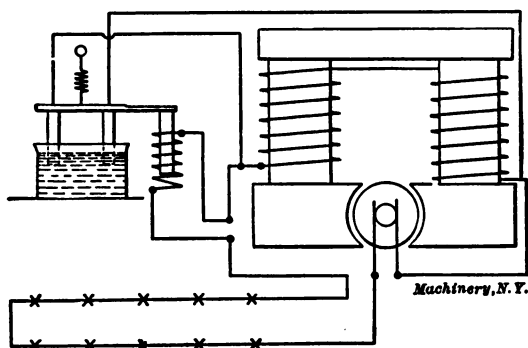

Fig. 4. Arrangement for Shunting the Field

The conductors of an armature can only give out their full electromotive force if the brushes on the commutator are properly adjusted for collecting it. There are points on the commutator where a pair of brushes can collect the maximum and minimum pressure. This is readily discovered in an ordinary shunt dynamo where the shifting of the brushes to different parts of the commutator increases or lowers the pressure a great many volts. Examination of the armature winding discloses the fact that the commutator is so connected to its conductor that the brushes can take off the pressure at a point where the electromotive force is low as well as at a point where it is high. In fact, between points 90 degrees apart from each other, the commutator can give the highest and lowest pressure of the armature. Hence a cutting down or raising up of the armature difference of potential can be accomplished by moving the rocker arm of the dynamo to which the brushes are attached either by hand or automatically. In arc light practice it is accomplished automatically by means of an electro-magnet

connected to the main circuit, as shown in Fig. 5. The current passing through the string of arc lamps actuates this coil and through it the core which it energizes. The core is so arranged that it moves the rocker arm of the dynamo according to the pull exercised upon it by the electro-magnet. If the current in the magnet is very great, the rocker arm is pulled over quite a distance, and in consequence the brushes take the pressure from different points of the commutator. When the magnet is not pulling very hard, the current in the main circuit is normal, that is to say, an adjustment has taken place between the resistance represented by the arc lamps and the voltage supplied to the line by the dynamo. This continuous adjustment is only brought about effectually by means of an electro-magnet sensitive to a rise or fall of the normal current and its consequent reaction upon the position of the brushes through the medium of the rocker arm.

Pressures as high as 6,000 volts have been used in high-tension direct-current lighting. The character of the current is pulsating, the throb

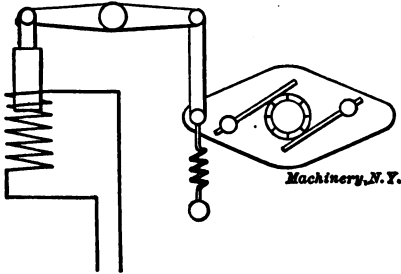

Fig. 5. Automatic Adjustment of Commutator Brushes

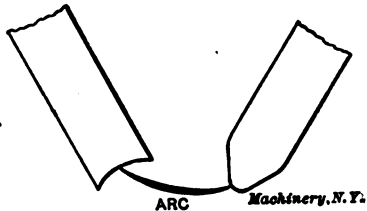

Fig. 6. Arrangement of Carbons in Flaming Arc Lamps

or pulsation being very effective in keeping the high-tension arc lamp mechanism in good adjustment. The candle power of arc lamps may be rated as either spherical or horizontal. The spherical candle power is the amount of light distributed on all sides of the arc. Light measured on a horizontal plane is the effective candle power produced. Means are employed to reflect as much of the light as possible downward, and thus increase the effectiveness of the lamp as a source of illumination. In arc lamps used on alternating current circuits a reflector is necessary on account of the constant reversal of the arc. During one alternation the crater of the carbon is above, during the next below. The result of this is the continuous shifting of the light upward and downward and hence the necessity for a reflecting device of some description to preserve a uniformity in the degree of horizontal illumination.

#### Flaming Arc Lamps

If metallic salts which readily volatilize at a relatively low temperature are added to a hollow or cored carbon, having a metal strip for a core, the character of the arc produced between the electrodes of an arc lamp is changed to a marked degree. The metallic vapor between the terminals lowers the resistance between the electrodes, and hence a

longer arc is made possible, the character of which is such as to produce considerably more light per watt than that of the ordinary arc lamp. Lamps of this type are called flaming arc lamps. It is claimed by the manufacturers of these lamps that one flaming arc lamp is sufficient to replace five regular enclosed arc lamps. In order to fully appreciate the illuminating qualities of the flaming arc lamps, the following comparison of the watts required per candle power by different kinds of lamps may be of interest.

	Watts per Candle Power
Carbon filament incandescent lamps.....	3.1 to 4.0
Tungsten filament incandescent lamps.....	1.2 to 1.5
Enclosed arc lamps.....	1.0 to 2.1
Flaming arc lamps.....	0.25

These figures are subject to modification, but will be found accurate for average conditions. The tantalum lamp consumes from 2 to 2.5 watts per candle power, and therefore occupies a place between the carbon filament and the tungsten lamp, the latter being, in regard to economy of current, the closest competitor of the arc lamp of all the incandescent lamps.

The mechanism of flaming arc lamps has been modified to meet certain requirements which they present. It has been found impracticable to operate electrodes containing metallic salts one above the other, hence the established practice is to have both electrodes pointing down in an inclined direction, and so arranged that they converge to a point where the arc is struck. (See Fig. 6.) As no obstructions are below the arc, this further increases the efficiency, does away with all shadows, and gives a most excellent distribution of the light.

In some cases where the regular arrangement of the carbon has been retained, the lower carbon is made heavier, is saturated with the metallic salts, and on direct-current circuits is used as the positive carbon. The light is thrown down by means of a small reflector surrounding the upper carbon.

Flaming arc lamps burn either two in series on a 110-volt circuit or four in series on a 220-volt circuit. Because of the liability of one lamp in a series going out and thus affecting the circuit, a device is added to each lamp so that a defect in one lamp will not open the circuit and thereby interrupt the other lamps in the same series. To accomplish this, an extra resistance is supplied which is equal to the normal voltage drop at the arc, which is automatically inserted when the arc fails and thus keeps the circuit closed.

#### Cost of Operation of Flaming Arc Lamps

While the flaming arc lamp is of high efficiency and in many respects, from a light standpoint, possesses advantages over practically all other types of lamps, it should not be assumed that flame lamps may be indiscriminately installed, and always give economical results, due especially to the fact that carbons for flaming arc lamps are very much more expensive than ordinary arc lamp carbons. Each case must be

investigated on its own merits, and in general flame lamps will be found more economical in ultimate cost where large areas are to be lighted or where smoke, dust or vapor is present.

In order to obtain a correct conception of the economical advantages of the use of flaming arc lamps, a concrete example may be analyzed. Assume that 40 flaming arc lamps are used to replace 200 enclosed lamps. Assume further that current costs 2 cents per kilowatt-hour, and that the enclosed arc lamps consume 132,000 kilowatt-hours per year, while the flaming arc lamps consume but 26,400 kilowatt-hours. The saving in current, then, would equal 105,600 kilowatt-hours, equivalent to a value of \$2,112.

The labor of trimming would be about equal, as the flame lamps require trimming five times as often, but only one-fifth as many are used. The carbon expense would be increased by \$1,540, but repairs and other items of expense would be but one-fifth of those for the enclosed lamps. A clear saving is thus shown, even at the very low cost of current assumed, and the saving would be greater where current costs more. Further, the saving on the power plant would in many cases be a feature of predominating importance, as that amount of power could be utilized for other purposes.

A considerable saving is also made possible in new installations through the far less extensive system of wiring required, due to the fewer lamps used to give an equal illumination. The same applies also to the size of the power plant, which can be proportionately less when flaming arc lamps are installed. The purposes for which these lamps are especially adapted are for the lighting of shops and factories, street lighting, dock lighting, and under certain conditions, for store lighting.

The disadvantages of the flaming arc lamp are that the carbons are expensive, require frequent renewal, as compared with the enclosed type of arc lamp, and that the globe becomes coated on the inside with a deposit, which requires frequent cleaning. As regards the life of the carbon, the maximum is given as 24 hours, with carbons 16 inches long.

Flaming arc lamps of ordinary size give from 3,000 to 4,500 candle power.

## CHAPTER II

### INCANDESCENT LIGHTING

Lighting by means of incandescent lamps is by far the most common type of electric lighting used. The current for the lamps may be either alternating or direct current. In a direct-current system the dynamo employed may be either shunt- or compound-wound. When electric lighting is conducted on a large scale, as in the case of stations which supply an entire city with electricity for light as well as for power, low-tension direct-current lighting is commonly combined with a high-tension two- or three-phase alternating current distributing system. This latter system is employed in order to increase the economy of transmission to points more or less distant from the original generating plant.

#### The Incandescent Lamp

The incandescent lamp is based upon the principle that when an electric current is sent through a conductor of high resistance, the conductor is heated. If the current, material for the conductor, and other conditions are such that the conductor will be heated until it becomes incandescent and hence gives out light, this combination embodies the principle of the incandescent electric lamp. The material for the conductor in ordinary lamps is carbon, which is formed into a small thread called the filament. Some lately developed lamps employ metallic filaments, and these lamps will be referred to in a later chapter. Carbon filament lamps, however, are as yet the most commonly used, the carbon having been selected for two reasons. In the first place, it is capable of standing the very high temperature required, or about 2,350 degrees F. In the second place, as a conductor of electricity it presents the required resistance, which in an incandescent lamp varies from 150 to 200 ohms. In addition, it does not deteriorate too rapidly when in use.

There are three features relating to the incandescent lamp which are of importance in connection with its use. These are the life, candle-power and efficiency of the lamp. The average life of an ordinary 16 candle-power lamp is from 600 to 800 hours. By efficiency of an incandescent lamp is meant the power in watts required per candle-power. This efficiency generally has a value between 3 and 4. In other words, a 16 candle-power lamp will consume anywhere from 16 times 3 to 16 times 4 watts to produce its light. Experience has taught that any increase in the normal candle-power, or decrease in the power consumed, is only gained at the expense of the life of the lamp. Regulation, as it is called, that is to say, the preservation of a uniform potential in the entire system of electric lighting is, therefore, necessary if any relationship is to be kept between the light produced, the power consumed

in producing it, and the life of the lamp. A fall of a few volts in the generator means a reduction of between 20 and 30 per cent in the candle-power of the lamps. A rise of a few volts will send so much more current through the lamps and so increase the candle-power that the life or durability of the lamps is reduced. The great increase in current with an increase of only a few volts is due to the lowering of the resistance of the carbon as its temperature rises. A hot carbon conducts much better than one that is cold, and when, as in the case of a carbon lamp filament, incandescence is reached, it becomes very sensitive to a slight increase in pressure.

#### Power Consumption and Life of Lamp

The two factors, power consumption and life of lamp, are very closely associated. In the 500th hour of the life of the lamp, it usually will begin to grow dim and then either new lamps or a higher voltage would be required. If a higher voltage is sent over the line the power consumption becomes very much greater. For instance, with 1,000 lamps, each requiring 50 watts, a total of 50,000 watts would be required when the lamps are new. But if the same lamps should give the same amount of light after they have commenced to grow dim, the power per lamp would rise to, say 64 watts, and a total of 64,000 would be required; the difference, 14,000 watts, represents such an increased cost in the production of electricity that it would become more expensive than lamp renewals. Again, if the voltage is not increased, the lamps will burn very dimly, and instead of giving 16 candle-powers, the light would be only about 12 candle-powers or thereabouts; thus equal power would be consumed at the plant for producing only 75 per cent of the light, which, of course, would be poor practice. Hence it will be understood that there is a certain point in the life of the lamp when it is more economical to replace the lamp with a new one than to continue to use the old one with its decreased candle-power. A decrease of about 80 per cent in the candle-power is commonly assumed to indicate the point at which the lamp ought to be replaced.

As regards the influence of the voltage on the life of the lamp, the following figures may be of interest. An increase of about 3 per cent in the voltage reduces the life of lamp by about one-half, while an increase of only 6 per cent causes the useful life of the lamp to fall to only one-third of its value at the normal voltage; hence it is evident that it is of extreme importance that the voltage of the current sent into the line remains at a definite point, so that there will be neither a variation in the lighting properties of the lamps nor a decrease in the length of life of the lamps.

The voltage ordinarily used for incandescent lamps depends to some extent on the method of distribution of the power. Ordinarily 110 or 220 volts pressure is used. When the higher voltage mentioned is employed, the filaments should be long and slender and lamps of less than 16 candle-power should not be used. The selection of lamps depends to a considerable extent upon their efficiency. Lamps of an efficiency of about 3, that is, lamps taking about 3 watts per candle-power, require



that the voltage be very carefully regulated at a constant value. Lamps taking 3.5 watts per candle-power permit a variation of 2 per cent from the maximum voltage, and when the voltage regulation is poor, lamps of an efficiency of 4 should be employed. The values mentioned are for lamps on 110-volt circuits; 220-volt lamps should be given a lower efficiency in order to obtain a longer life.

#### Regulation of Shunt- and Compound-wound Dynamos

The machines best suited to the service of supplying an incandescent system with its energy are the shunt- and compound-wound direct-current dynamos. It is most common to use compound-wound generators for smaller private installations, because in this case the dynamo is practically automatic in its action, which means that between no load and full load—the minimum and maximum of lights—it will preserve a comparatively uniform pressure. On the other hand, if a shunt-

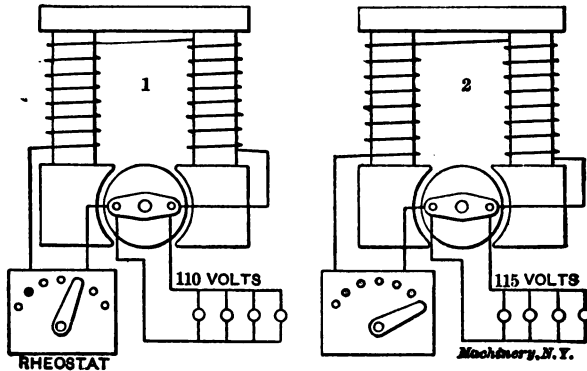

Fig. 7. Effect of Change in Resistance on Voltage

wound dynamo is installed, every important change in the number of lights will necessitate an adjustment of the resistance inserted in the field or shunt winding, in order that the voltage may remain constant, which, as already mentioned, is very important. When the various consumers of the current turn their lamps on or off, the dynamo, sensitive to such changes, will vary its terminal or brush pressure. Constant attention is, therefore, required to preserve a uniform potential by decreasing or diminishing the current in the shunt winding, which is done by means of a rheostat and the consequent throwing in or out of more or less resistance. The effect of this is indicated in a diagrammatical way in Fig. 7.

It is evident that when the current in the windings of the field is increased by cutting down the resistance in the rheostat, the current in amperes, and hence, the ampere-turns of the field winding increase. The lines of force of the field increase, as does also the electromotive force generated by the dynamo. The reverse happens when the resistance in the field winding is increased. The smaller the shunt-wound generator is, the more constant attention must be paid to this regula-

tion by means of the rheostat. If the consumption of current is very large, as, for instance, in a large city, where the station load may reach over 200,000 amperes, then the use of shunt-wound generators with rheostat regulation is considered as good practice. In this case station assistants are always at the rheostats to meet the rising or falling tide of the demand for electricity with a resistance adjusted to preserve the constant potential or voltage of the system. Contrary to expectations, this is a very reliable method of regulation, and meets every requirement.

#### Elements of a Small Electric Light Plant

The essentials of a small private electric lighting plant include as mechanical details boiler and engine with accessories, and as electrical details the dynamo, switchboard and wiring. The switchboard, in

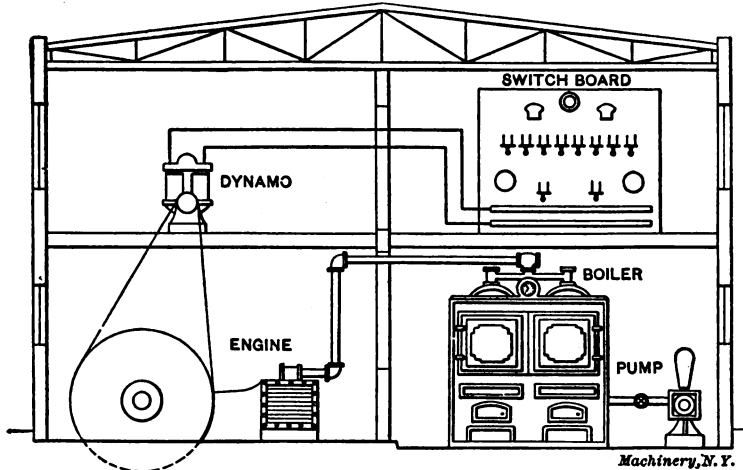

Fig. 8. Essential Parts of a Small Electric Light Plant

turn, contains the ordinary meters required, circuit breakers, lightning arresters, ground detectors, etc. The dynamo has been described in detail in Part III of this treatise, MACHINERY'S Reference Series No. 75. The switchboard and the instruments used on it are described in detail in MACHINERY'S Reference Series No. 78, "Principles and Applications of Electricity, Part VI, Power Transmission." The switchboard performs three functions: it receives the main wires from the generator or generators, and distributes or feeds the current thus received to the various circuits, and in addition it measures the current both as regards its voltage and its strength in amperes. The essential parts of a small electric plant are shown in Fig. 8, the boiler with its feed pump being indicated to the right on the lower floor, the engine to the left, and the dynamo and switchboard on the upper floor. In Fig. 9 is shown the essential parts of a switchboard, consisting of three panels called feeder panel, meter or load panel, and generator panel, respectively. On this switchboard are indicated the various switches and meters.

A necessary adjunct to the installation is the lightning arrester. Central stations as well as private plants are subjected to the influence of lightning or electrical storms, and it is necessary that the electrostatic discharge is led to the earth before it reaches the generator and causes damage to the machinery. The elementary principle of the lightning arrester is indicated in Fig. 10. It is provided with either an air gap, or a very high resistance path, leading to the earth. This

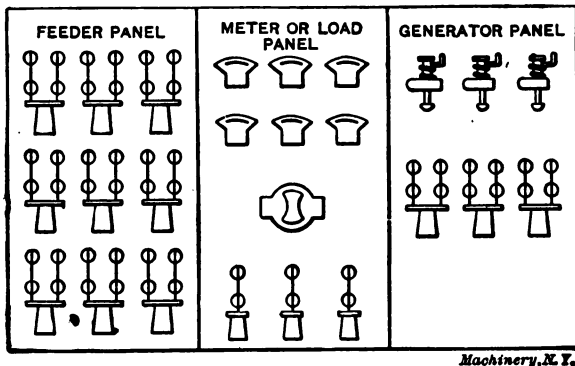

Fig. 9. Essential Parts of Switchboard

air gap does not permit the regular line current to jump across, but the lightning discharge will jump across, owing to its high potential. In order to prevent an arc from being established across the air gap, through which the regular current would find its way to the ground after the lightning discharge has taken place and started the arc, a

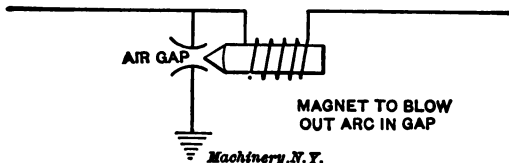

Fig. 10. Principle of Lightning Arrester

magnetic blow-out is provided, which extinguishes the arc. The electrostatic discharges due to lightning are dangerous because they tend to break down the insulation and thus cause grounds and short circuits.

**Systems of Distribution**

While the series system of distribution of current may be used for incandescent lighting systems the same as it is used for arc-light circuits, as described in the previous chapter, the most commonly used systems for incandescent lighting are the multiple or parallel systems of distribution. In these systems the lamps are connected across the lines leading to the central station or to the sub-station where the current is transformed or converted, as indicated in Figs. 11 to 13.

The most serious difficulty which has to be overcome in the multiple systems of lighting is due to the fact that the flow of current in a

conductor is always accompanied by a fall of the voltage due to the resistance of the conductor, so that the lamps at the end of the system will not have the same voltage impressed upon them as those nearer the source of the current. Various schemes have been worked out in order to overcome this difficulty. These methods may be classified as follows:

- Parallel feeding, conical conductors.
- Anti-parallel feeding, cylindrical conductors.
- Anti-parallel feeding, conical conductors.

If parallel feeding and cylindrical conductors (Fig. 11) are used, it is evident that the voltage becomes a minimum at the lamps at the end of the line. When a conical or tapering conductor is used, that is, a conductor having its diameter so proportioned throughout its length that the current divided by the cross section of the conductor is a constant, the difficulty is partly overcome. The constant (current ÷ cross section of conductor) is called current density. In practice,

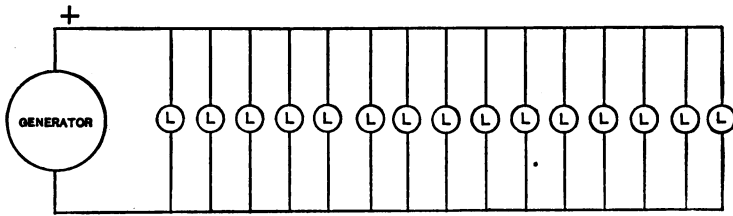

Fig. 11

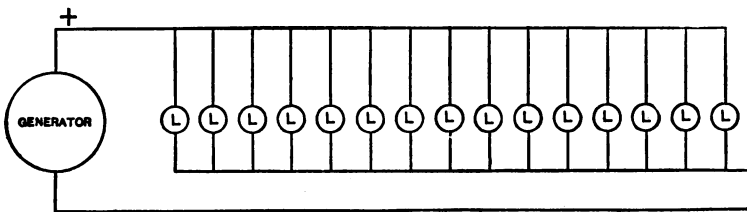

Fig. 12

Machinery, N. Y.

Figs. 11 and 12. Systems of Distribution of Lighting Current

conical conductors consist of lines having smaller diameter wires in the circuit as the current becomes less. In the anti-parallel systems (Fig. 12) the current is fed to the lamps from opposite ends of the system, so that a balanced condition is thus obtained.

**Two- or Three-wire Systems**

The two-wire system is simply the ordinary system indicated in Fig. 11, where the current passes out through one wire and returns through the other. A commonly used system, however, employs three wires for the circuit, and in some cases even five. In the three-wire system, three conductors are used as shown in Fig. 13. As indicated, this system dispenses with one wire, connecting two dynamos on three wires instead of on four. The positive pole of one dynamo is con-

nected to the outer wire, and the negative pole to the middle wire. The negative pole of the other dynamo is connected to the other outer wire, and the positive pole to the middle wire. This, in effect, gives two dynamos in series, the middle wire being called the neutral wire. The other two wires, one on each side of it, are respectively the posi-

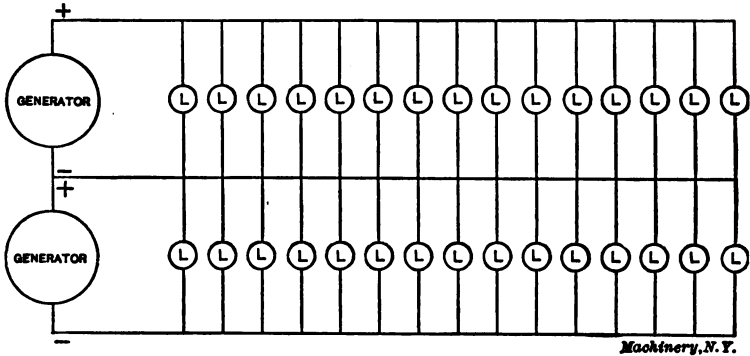

Fig. 13. Three-wire System of Distribution

tive and negative wires, as shown in Fig. 13. These wires are also frequently called the outer legs of the system. The general arrangement of the connections at the dynamos is indicated in Fig. 14.

**Advantages of the Three-wire System**

The advantages of the three-wire system are found in the saving of copper, and the increased flexibility of the system through the use of different voltage for lamps and for motors also fed with current from

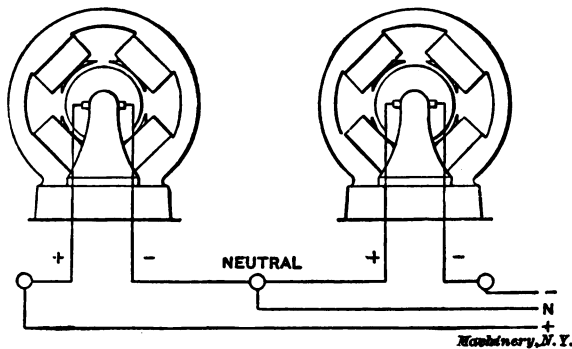

Fig. 14. Connections at the Dynamo for Three-wire System

the same supply. Between the middle or neutral wire and the outer leg on either side may be found a pressure of about 110 volts. Between the two outer wires double this pressure, or 220 volts, is on tap for motor service, although it is not good practice to feed motors directly from a lighting circuit. Take the case of 50 lamps taking  $\frac{1}{2}$  ampere apiece, fed respectively by a two- and a three-wire system for purposes of comparison. On this basis 50 lamps require 25 amperes, and a two-wire system would have to supply a wire of sufficient cross-section in

circular mils to carry this current with the small loss in pressure expected. The formula for this size of wire is given as follows:

$$\text{Circular mils} = \frac{\text{number of feet of wire} \times \text{amperes} \times 12}{\text{volts drop}}$$

[The area of copper wires is usually given in circular mils. By a circular mil is meant the area of a circle 0.001 inch in diameter. Square mils are sometimes used for expressing areas. A square mil is the area of a square whose side measures 0.001 inch. One square mil equals 1.27 circular mil. The diameters of copper wires used as conductors are usually given in the American or Brown & Sharpe wire gage.]

If in the above case the circuit is 100 feet in length and a drop of 2 volts is allowed in the wire, then the calculation will give

$$\text{Circular mils} = \frac{200 \times 25 \times 12}{2} = 30,000.$$

If the two-wire system calls for a wire of 30,000 circular mils for 50 lamps taking  $\frac{1}{2}$  ampere apiece with a 100 foot run and a 2 volt

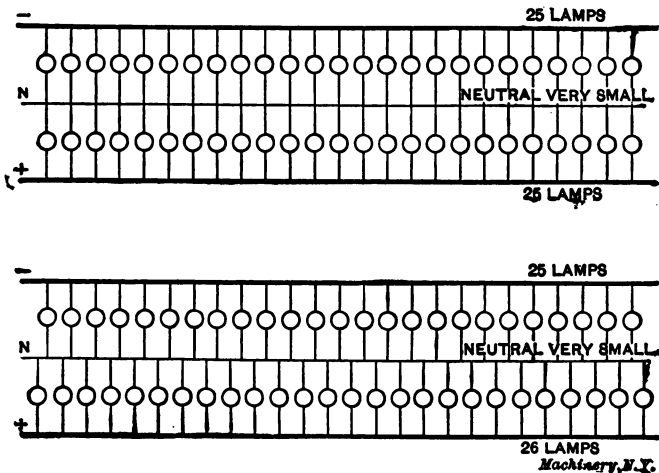

Fig. 15. Examples of Three-wire Systems

drop, calculation will show a smaller wire for a three-wire system of lighting with just as many lamps. In a three-wire system the lighting must be *balanced*, that is to say as many lamps must be placed on one side of the neutral wire as on the other. This will mean 25 lamps on each side of the neutral wire, as indicated in the upper view of Fig. 15, which represents 25 groups of two lamps apiece. The two lamp groups are connected across from the positive to the neutral wire, and from the neutral wire to the negative wire. Examination will show that the 220 volts will send  $\frac{1}{2}$  ampere through every two lamps in series. The neutral wire in this case, when the circuit is perfectly balanced, performs no service. If there were 25 lamps on one side of the neutral wire and 26 on the other, as shown in the lower view in

Fig. 15, then it would carry the current of one lamp, namely  $\frac{1}{2}$  ampere. A neutral wire, in a three-wire system, therefore, carries only the *difference* in current between one side of the neutral wire and the other. Consequently, if the circuit is balanced it carries no current at all. This is the case with 50 lamps burning on the three-wire system, and only  $12\frac{1}{2}$  amperes are required at 220 volts pressure, which, with the same length of run, 100 feet, and the same drop, 2 volts, according to the formula calls for an area in circular mils of

$$\frac{200 \times 12.5 \times 12}{2} = 15,000.$$

In interior house wiring, for *only* the three-wire system, three wires of this size should be used. This means, in comparison, that the two-wire system would require two 100-foot wires of 30,000 circular mils apiece, and the three-wire system three 100-foot wires of 15,000 circular mils apiece. A 100-foot wire of 60,000 circular mils would represent the equivalent of the first, and a 100-foot wire of 45,000 circular mils

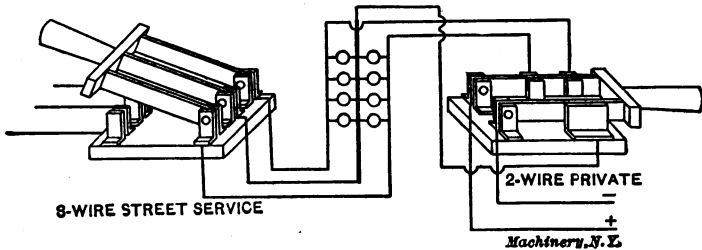

Fig. 16. Switch for Combining Two- and Three-wire Circuits

the equivalent of the second case. The saving would be the difference between 60,000 and 45,000 or 15,000 circular mils, which is 25 per cent. If the neutral wire, as is the case in the system employed in the conduits laid in a city's streets, is not as large as the outer legs, and it is easy to see that it need not be, the saving in copper is much greater, because here, the neutral wire, carrying only the difference in balance between one side of the circuit and the other, can be comparatively very small for balanced circuit. The wiring contractor must see that such a balance exists in planning out the circuits. A certain small difference in balance in the aggregate must of course be taken up by the neutral wire, through consumers turning lights on and off, which makes a perfect balance all of the time an impossibility.

**Combination of Two- and Three-wire Circuits**

In private houses and public buildings where electric light plants are installed it may become necessary through a break-down of the plant to throw in the street service. A difficulty here presents itself unless the wiring conforms to the system in the street. If it is a simple alternating current system, it may be thrown on without hesitation, provided it is of the same pressure as the lamps require. If the street system is a direct-current three-wire system and the wiring of the building is according to the two-wire system, then the wiring

must be composite, that is, suited to both a two-wire and three-wire system of lighting. All of this is easily accomplished if the building has been wired according to the three-wire system, only the neutral wire must be of *twice* the cross-section of the two outer legs. It can then be used for either purpose without any change whatsoever. A large double-throw switch is necessary to connect at will the street service or the source of private supply, as shown in Fig. 16.

#### Losses in Circuits

Wires carrying electricity from point to point dissipate energy to an extent dependent upon the current they carry and their resistance. This waste of power appears in the form of heat. An incandescent lamp is a good illustration of this when in use. The resistance of its carbon filament is sufficiently great with the current passing through it to raise it to incandescence. In the same manner, although not to the same extent, a conductor is heated by the energy it contains, and a certain percentage of power disappears. This can be regarded in two ways: first, as caused by lost voltage or drop, and second, as due to the energy wasted as heat. To calculate the first, or the voltage lost, this formula is employed:

$$\text{Volts lost} = \text{amperes in wire} \times \text{resistance of wire.}$$

If the lost voltage is multiplied by the amperes, the watts wasted in the wire are obtained. Again, the power which generates heat can be calculated by the formula:

$$\text{Watts wasted in heat} = \text{amperes} \times \text{amperes} \times \text{resistance of wire.}$$

These two results will be the same, as shown by the following example: Take a wire of 10 ohms resistance carrying 2 amperes, then the volts lost =  $2 \times 10 = 20$  volts, and the watts wasted =  $2 \times 20 = 40$  watts. If the watts wasted in heat are calculated by the other method the result is: watts wasted =  $2 \times 2 \times 10 = 40$ , or the same figure in both cases. One is obtained by the product of the drop in volts by the amperes, the other by the square of the amperes by the resistance. As there are 746 watts to a horsepower, the percentage of a horsepower wasted in the conductor can be readily obtained.

Where many lines are in use carrying power, the loss is considerable, particularly when the current is heavy. The loss increases rapidly as the current increases. In the case just stated, if the amperes are raised from 2 to 4 the watts wasted increase from  $2 \times 2 \times 10$  to  $4 \times 4 \times 10$ , equalling respectively 40 and 160 watts, a ratio of 4 to 1 with only twice the current. Therefore, if the resistance of a line remains the same and the current is doubled, tripled or quadrupled, the waste of power is increased 4, 9 and 16 times, respectively. Reducing the current in conductors transmitting electricity for light and power and increasing the pressure is, therefore, the logical consequence. To accomplish this successfully in electric light practice has been one of the most difficult problems. It has been solved by a flexible system of rotary converters, by means of which a high-potential alternating current is changed into a direct current of low poten-



tial, or by transformers in which the high-potential alternating current is changed into a low-potential current of the same kind.

#### Transmission and Distribution of Electric Current

The methods and apparatus used for transmission and distribution of electric current are described in detail in MACHINERY'S Reference Series No. 78, "Principles and Applications of Electricity, Part VI, Power Transmission." In the following, therefore, only a brief review of the methods employed will be given. The function of a central station is the generation and distribution of electricity for electric light and power service, but it must operate as well as a power transmission plant in order to distribute its energy with economy over an increasing radius. For this reason it must be equipped with apparatus by means of which it can both distribute electricity at low potential within a considerable radius of itself, and also transmit energy at a high pressure to certain points relatively far removed, and there have that energy undergo a process of transformation to low pressure preparatory to its distribution. The delivery of heavy amounts of

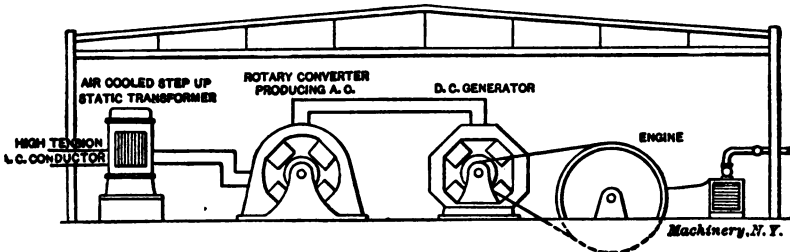

Fig. 17. General Arrangement of Power Station

energy one or more miles away with little loss, thus creating a new center of distribution, is accomplished as follows:

The central station is supplied with two classes of machinery: one, which generates the current at low pressure, continuous and ready for distribution; the other, which transforms it into a high-pressure alternating current for transmission, prior to ultimate distribution at a distance. The low-pressure direct-current generators supply an area in the immediate neighborhood by means of the three-wire system. They also supply energy to rotary converters, which are machines representing a combination of a motor and dynamo in one. On one side the machine receives a low-pressure direct current which operates it as a motor; it gives out an alternating two or three-phase current at a somewhat higher pressure. This result is obtained by means of two armature windings, one of which is for continuous and the other for alternating current. A commutator is connected on one side of the machine to the direct-current winding, and collector rings on the other side to the alternating-current winding.

Not only will a direct current rotate the armature and thus generate on the other side of the machine a two or three-phase alternating current, but if a two or three-phase alternating current, as the machine

may require, is sent in at the collector rings, the resulting rotation will develop a direct current at the commutator. Thus a rotary converter is capable of taking in a direct current and giving out an alternating current, and, conversely, it can take in an alternating current and give out a direct current. It is for this reason invaluable in the transmission of power.

The alternating current given out by the rotary converter is practically the full equivalent of the energy sent in in the shape of a direct current. This alternating current is received by a transformer, which it enters at a few hundred volts and leaves at a pressure of many thousands, but otherwise still unchanged in character. In this manner, an alternating current of high pressure is sent over transmission lines either underground, in conduits, or overhead, to re-

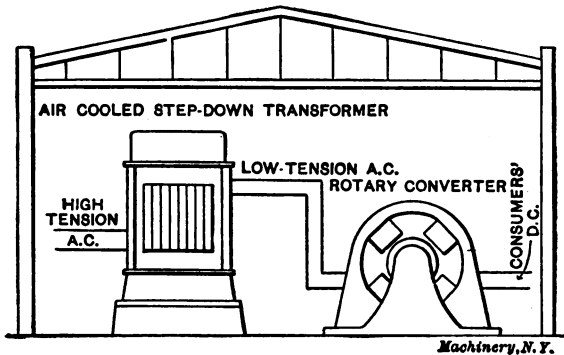

Fig. 18. General Arrangement of Sub-station

inforce distant stations or to create at new points what are called sub-stations. The general arrangement of the power station, with its generator, converter and transformer, is shown in Fig. 17.

#### The Sub-station

The current, which can be considered, for purposes of illustration, as 5,000-volt three-phase, is now received at the sub-station to undergo a new process of transformation. To outline the previous process in the station itself, it is only necessary to consider a 110 or a 220-volt direct current entering the rotary converter and issuing as a 300 or 500-volt three-phase alternating current. This current is sent into the transformer and emerges at 5,000 volts and goes over the line. In the sub-station are again to be found stationary or static transformers and rotary converters. The power is received in the transformers at 5,000 volts and issues at 300 or 500 volts. It is then directed into the rotary converter, from which it issues as a continuous current of 110 volts and feeds into the three-wire system. The essential details of a sub-station are shown in outline in Fig. 18. The transformers which raise the pressure are called *step-up*, and those which lower it *step-down* transformers.

## CHAPTER III

### THE INCANDESCENT LAMP AND ITS MANUFACTURE

Much of the development of electric lighting plants in the United States is directly attributable to the incandescent lamp. Nearly all indoor electric lighting is done by this means. Arc lights are employed almost exclusively for outdoor illumination. The incandescent lamp has passed through a system of evolutionary processes of manufacture, and its origin, first appearance, and the present methods of manufacture will be briefly reviewed in the following.

#### First Experiments

The heating of a wire in a glass bulb, from which some air had been removed, led to the further experiment of exhausting the bulb still more and noting the increased brilliancy and durability of the wire under these conditions. The glass bulb provided with electrodes connected with a metal wire was first used in laboratory experiments for the purpose of demonstrating the peculiarities of a static charge in a vacuum. The need of an air pump of a better quality than those composed of a cylinder and piston made itself felt, and led to the invention of the mercury vacuum pump. By means of this device, a much higher vacuum than that ordinarily obtained can be secured by letting mercury drop down a tube to which the bulb to be exhausted is attached. Small amounts of air are successively removed in this manner until, by continuing the process, the air pressure in the bulb is reduced to a very small fraction of an atmosphere.

The mercury method of obtaining a good vacuum stimulated inquiry in the inventive field with regard to the incandescent lamp. The first lamp of this type was constructed by Grove, who used a platinum wire inside of a glass bulb and connected it to a number of batteries, thereby raising the wire to a white heat. The vacuum in the bulb served to free the wire from the presence of oxygen and the effects of radiation of heat into the air, which would otherwise be surrounding it. This form of lamp, however, could not be used for commercial purposes, for two reasons. In the first place, it was too expensive, due to the cost of platinum; and, in the second place, the platinum wire filaments could not long resist the high temperature due to the current. In fact, while the light became brighter the more current was sent through the wire, a point was soon reached where the platinum would melt. The experiment, however, of raising platinum wire to a high point of incandescence which gave rise to a brilliant light, although of a temporary and expensive nature, led to further efforts to make a device more permanent as a light producer.

The name of Edison in the United States and that of Swan in England are closely connected with this stage of the history of the incandescent lamp, and it is curious to note how their experiments in many respects paralleled each other, although the ocean lay between the two laboratories, and great secrecy attended the work of each. The platinum wire proposition was rejected after a while, as was also, for the time being, the hope of using metals or metallic alloys of any description for the filaments. Edison followed the idea that the filament should have a granular structure and be composed of carbon. Swan believed that it should be of homogeneous nature, if its properties were to make it durable. Thus following different lines of investigation, one discovered in bamboo a good material from which, when carbonized, filaments for lamps could be made. The other treated threads with acid, and with subsequent carbonization accomplished equally good results. A patent for a lamp made according to the principles outlined was granted to Edison on January 27, 1880, and read in part as follows:

"An electric lamp for giving light by incandescence, consisting of a filament of carbon of high resistance, made as described and secured to metallic wires as set forth.

"The combination of carbon filaments with a receiver made entirely of glass, and conductors passing through the glass, and from which receiver the air is exhausted for the purpose set forth."

Other lamps containing improvements tending to advance the possibilities of incandescent lighting were invented by Edward Weston, Hiram Maxim and Moses G. Farmer. The introduction by Maxim of the hydro-carbon method of treating the filaments, which will be described in detail later, was one of the most important inventions in lamp manufacture, and is to-day considered as an indispensable element in the success of lamp manufacture.

The use of carbon for a lamp filament was in itself a discovery of no mean importance. It was led up to as a result of conclusions arising from considerations of temperature and vacuum. Metals melt readily at a certain degree of heat. Carbon, on the other hand, is very difficult to soften by heat, and its volatilization takes place in a very slow and limited manner. Carbon is, therefore, especially adapted to fill a unique place in incandescent lighting and possesses the additional advantage that it does not deteriorate at the high temperature to which it is subjected, nor will it become consumed unless air is present. A careful regulation of the current, and of the heat of the carbon, hence constitute the correct working condition.

Another reason why carbon is peculiarly suited for filaments of incandescent lamps is its high resistance, although it is true that the fact that its resistance rapidly lowers with an increasing current is one of the strongest arguments against it. In other respects, however, it was long found incomparably better than metals of any description, although of late metallic filaments have been introduced successfully for incandescent lamp manufacture.

### Filament Manufacture from a Solution

The original methods of making filaments have naturally undergone radical improvement. The bamboo strip is no longer employed, neither is the thread treated with acids, but a semi-liquid or viscous nitro-cellulose solution has taken the place of nearly all of the former filament bases. This is a product obtained by dissolving cotton wool of good quality in barrels of zinc-chloride solution. This solution is made of a consistency of a syrup, and is utilized for commercial purposes by forcing it through an aperture in a die or plate, from which it issues as a fine thread. The technical term "squirting" is used for this method of manufacture, which has become the generally adopted plan.

The fine continuous thread produced by the squirting process is put into a vessel containing alcohol, in which it is permitted to remain

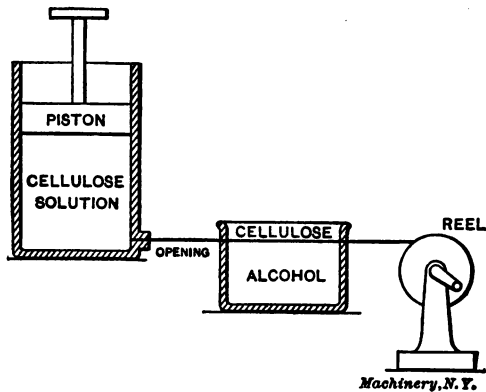

Fig. 19. Graphical Illustration of Filament Manufacture

for twenty-four hours for the purpose of dissolving and thoroughly freeing it from the zinc-chloride solution. When all traces of this solution have been removed, the squirted cotton threads must be freed from the alcohol, which is done by placing them in a sink, and permitting water to run over them for several hours. In this process they expand considerably, and in drying they contract and shrink. Some device must be employed to prevent them from breaking up in drying; one method commonly used is to wind them loosely on drums covered with velvet, so that the threads can sink into the velvet as they dry.

One of the serious difficulties met with in the original zinc-chloride solution of cotton is the presence of air bubbles contained in it, which destroy its uniformity. These are partially removed by agitating or stirring the solution, but this means alone is not sufficiently effective, and it is therefore common to heat the solution in a vacuum retort; this remedy, however, must be most judiciously applied, and the heat regulated, or the solution will suffer permanent injury. Various substances were originally tried for the purpose of making a pure and

comparatively inexpensive cellulose useful for filament manufacture; they resulted in the ultimate choice of absorbent cotton, a specially picked and prepared as well as readily available foundation.

The filament thread, after being prepared as outlined, is of the general appearance and strength, though of less diameter, than a silk violin E string, or the material used for holding fish hooks to lines. The next step in the process is that of cutting up the material into lengths and of winding these on formers, giving the desired horseshoe shape of the lamp filament. For mere purposes of comparison it may be stated that the most expensive manufactured product in the world is a pound of carbon filaments complete. Hair springs for watches cost less per pound, although it is still the popular idea that in this respect they stand first.

#### Carbonizing the Filament

The process of carbonization belongs to one of the most delicate processes in connection with incandescent lamp manufacture. Powdered charcoal is used as a bed and covering for the horseshoe lengths of the filaments, and direct contact with the air is carefully prevented during the subsequent heating and cooling period, which occupies close to twenty-four hours.

The oven in which the future filaments are to be carbonized is gradually raised to such a temperature that they all become red hot, this temperature being about 1,000 degrees F. It is evident that the oxygen of the air would rapidly convert the entire mass into ash if permitted to act directly upon it, hence the careful sealing of the crucibles containing the filaments during this process. When removed from the crucible after the process is completed, the filaments are hard and elastic and appear like fine steel wires. It was originally supposed that the carbon of which they are composed is of very fine grain, perfectly homogeneous, and of an average resistance throughout. Tests have shown serious differences between filaments in this respect, however, and individual filaments are not sufficiently uniform in structure to be ready for immediate use. The practice of "flashing," therefore, represents one of the important preliminaries to the final completion of the filament.

After carbonization, but before "flashing," the carbon filaments are mounted or joined to the wires which lead into the glass bulb and which connect the filament with the outside supply of current. These wires are secured in a small glass tube.

The connecting wires, called the leading-in wires, are made of platinum. This metal was chosen because the coefficient of expansion of glass and platinum are about identical. If a metal was used for this purpose which expanded more rapidly than glass, it is quite evident that the glass would crack, air would filter in, and the lamp would be ruined. An equal expansion of glass and leading-in wires thus eliminates this danger. Between these wires and the carbon filament ends a junction must be effected by a cement or conducting material which will withstand the requirements of practice. It was discovered that

one of the simplest ways of accomplishing this was to hold the platinum and carbon terminals in juxtaposition, and employ either a carbon gas or liquid to supply a deposit at the joint to form the permanent connection. Other ways of making a joint between these two elements are also used, consisting of the electroplating of one to the other, or clamping one around the other, or by means of a cement. Of these methods, the use of a carbonaceous paste, or the effecting of a junction by a carbon deposit, are most generally in use.

#### The Process of Flashing

A microscopic examination of newly carbonized filaments shows great differences in diameter at various parts of the filament and the presence of open pores. The idea was suggested, therefore, of heating the filament to redness, while exposed to the influence of a gas containing carbon. The advantage of this lies in the fact that the carbon of the

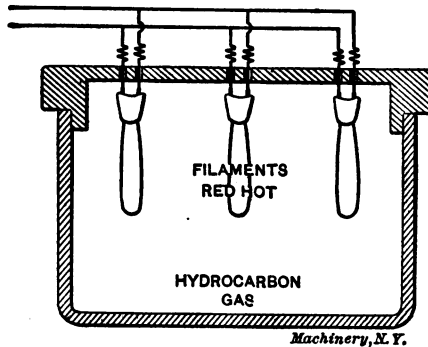

Fig. 20. Flashing the Filaments

gas will be deposited wherever the filament is unduly heated, and otherwise it will form a uniform coating, thus removing the drawbacks noted.

Glass receivers, holding a hydro-carbon gas, such as the vapor of naphtha for instance, are so mounted that the filaments to be exposed to the flashing process can be conveniently inserted and treated, a current being meanwhile sent through them, as shown in Fig. 20. The greater heat at the lesser diameters means a heavier deposit of carbon there than at other points in the filament. The pores fill equally, and the filament when withdrawn assumes a metallic luster and springiness which are regarded as its chief characteristics.

#### Governing the Resistance of Filaments

Although the flashing process builds up the filament, in the sense that it makes it uniform, the process in itself has the effect of reducing the resistance in total. In other words, discrimination must be exercised in exposing filaments to the current and gas; otherwise the resistances will be so varied that it would be impossible to obtain lamps of equal wattage and candle power. Thicker filaments than others can be kept longer in the gas, and during the flashing, tests of

amperes and volts will indicate the exact value of the resistance. This cannot be done successfully when the filament is cold, because of its variation in resistance between the two degrees of temperature. The resistance of a 250-ohm filament will drop during the flashing process to 225 or even 212 ohms, and the drop may take place with comparative rapidity unless the current supply is watched carefully. As the filaments before the flashing show great differences in resistance, it is evident that the commercial requirements make this particular phase of the manufacture the most important. The more uniform the ultimate products of the lamp factory, other things being equal, the greater the advantages where efficiency tests for superiority are to be made.

#### Presence of Foreign Matter and Gases

Volcanic actions seem to fairly represent the general character of the minute, but nevertheless similar class of phenomena, occurring in a filament undergoing flashing. Not only may these eruptions occur at this time, but when the lamp is finished and in use a peculiar yellowish-black coating will collect within the bulb. All of this is the consequence of the presence of gas in the filament, held by pores developed during the carbonizing process. The original cellulose string is uniform in character, and devoid of perforations, cracks or pores. But the continued heating yields defects which are partly removed in the carbon gas, although experience indicates their presence in the finished article. Foreign matter, infinitesimal in quantity, gives rise to equal minute explosions, the effect of which is to coat the interior of the lamp bulb with the film already noted. Oxygen gas is to some extent retained after the carbonization, but it is supposed to be entirely removed and absorbed during the flashing.

#### Effect of Flashing

The flashing process is one of the most important steps in the manufacture of an efficient lamp. Siemens & Halske, of Germany, made an exhaustive series of tests for the purpose of determining the relative merits of the treated and untreated carbon filaments with respect to the hydro-carbon or flashing process. Their results are tabulated as follows:

#### LAMPS WITH UNTREATED CARBONS

Burning Hours	Volts	Current in Amperes	Candle-power (C. P.)	C. P. per H. P.	Watts per C. P.
0	100	0.687	24.25	259	2.8
100	100	0.666	15.7	173	4.2
200	100	0.666	15.3	169	5.0
300	100	0.664	15.2	167	4.4
400	100	0.653	14.7	165	4.5
500	100	0.640	13.7	157	4.7
600	100	0.634	13.3	154	4.8
700	100	0.630	13.1	153	4.9
800	100	0.620	12.5	148	5.0



The results with treated carbons are doubly interesting when the column indicating the watts per candle-power are examined, particularly in connection with the number of hours burning.

LAMPS WITH TREATED CARBONS

Burning Hours	Volts	Current in Amperes	Candle-power (C. P.)	C. P. per H. P.	Watts per C. P.
0	100	0.552	25.0	333	2.2
100	100	0.550	22.5	300	2.4
200	100	0.550	22.0	290	2.5
300	100	0.548	21.0	282	2.6
400	100	0.547	20.0	270	2.7
500	100	0.545	18.6	251	2.9
600	100	0.545	17.1	231	3.2
700	100	0.540	16.0	218	3.4
800	100	0.532	15.3	210	3.4

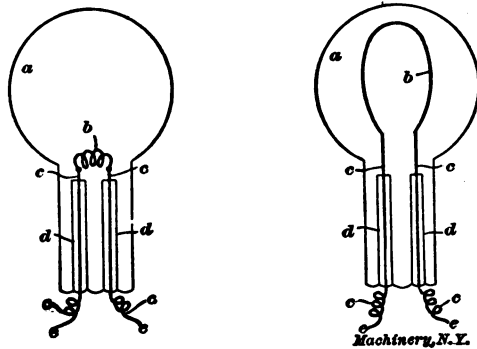

Fig. 21. Comparison between Crookes' Radiometer and the Incandescent Lamp

Summing up the results, the following data is of interest with respect to these figures:

	Treated Carbons	Untreated Carbons
Decrease in efficiency (per cent).....	36.9	57.10
Decrease in illumination (per cent).....	38.8	51.50
Average illumination, candle-power per lamp.....	19.67	14.91
Average output in candle-power, per H. P.....	264.1	167.70
Increase in resistance in per cent.....	3.8	10.80

The increase of over 30 per cent in light due to the hydro-carbon treatment establishes the immense value of this process in the commercial manufacture and use of lamps.

Making the Lamp

The filaments, after flashing, are ready to be enclosed in a glass bulb. This arrangement is a rather old discovery. Sir William Crookes invented a "radiometer" consisting of a glass bulb with leading-in wires, an account of which was published in the Philosophical Transactions of the Royal Society of London about the time that lamp-making only existed as an experiment. In this piece of physical apparatus leading-in wires of platinum were employed and a vacuum used

to develop the maximum effect with the illuminating element. The incandescent lamp differs only from this in the use of a carbon horse-shoe or high-resistance arch joining the platinum terminals, as shown in Fig. 21. In both figures in this illustration, *a* is the exhausted glass chamber, *b* is the illuminant or incandescent conductor, *c* shows the leading-in wires of platinum, to which the ends of the illuminant are attached, and which are hermetically sealed by fusion into glass tubes *d*. The main conducting wires are attached at *e*.

The glass bulbs for the lamps are blown from glass tubing about  $\frac{3}{4}$  inch in diameter with walls  $\frac{1}{8}$  inch thick. Afterwards a tube is formed on the lower end of the lamp about  $\frac{3}{16}$  inch in diameter and 3 inches long, this tube being used for attaching the bulb to the

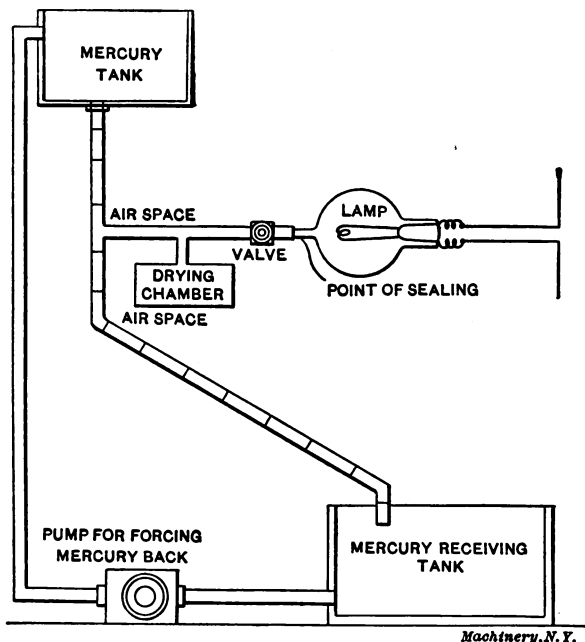

Fig. 22. Mercury Column Vacuum Pump

vacuum pump. The filament is then inserted into the lamp and the upper end closed around the glass tube in which the leading-in wires are held. After this the bulbs are connected to the vacuum pumps for exhausting the air.

#### The Vacuum Process

Pumps for the purpose of creating a good vacuum have reached a comparatively high stage of development. They are constructed on the general principle of the Torrecellian method of producing exhaustion by means of mercury in a glass tube. If a tube sealed at one end and about 40 inches in length is filled with mercury, and then its open end is carefully inserted in a deep vessel containing the metal, the

mercury will fall away from the upper sealed end to some extent. In this empty space is found what was originally called a Torrecellian vacuum, a vacuum of a very high degree of exhaustion.

The pumps originally employed in exhausting the lamps were of a type in which a falling column of mercury produced a vacuum in the lamp by dropping down a tube to which the lamp was attached. The junction was effected on the side of the tube between the lamp and exhaust pump. Globules or spaces form between the various sections of the mercury column. A systematic process of rarefaction goes on until the exhaustion reaches a point where the pressure is but a small fraction of an atmosphere. A diagrammatic sketch of this pump is shown in Fig. 22. This type of pump, however, is used only for laboratory purposes. For regular lamp manufacture, special mechanical rotary air pumps are now employed.

During the process of exhaustion the lamp has a weak current sent through it, only sufficient to heat the carbon and the surrounding air. As the rarefaction increases the current is increased, until at the end of the process the lamp burns with full candle-power.

The absence of air around the filament means less immediate radiation from the incandescent mass to the outside air. The value of this is found in the lower current value required to heat the filament to incandescence. The lower the current value the higher the efficiency, other things being equal. By means of a vacuum a degree of commercial economy is obtained which lifts the incandescent lamp, light for light, to a much higher plane than gas. The relative efficiencies may be noted in the following general manner as about 10 per cent for the arc light, 3 per cent for the incandescent, and 1 or 1.5 per cent for gas. Using a neutral gas in the bulb would mean a subtraction of heat from the filament to the outside air. This is not an efficient method, and for that reason has been practically discontinued.

Since the degree of exhaustion must be high, the bulb should be heated during the process of obtaining the vacuum, so as to drive off any gas which may cling to the glass. Immediately after the pumping process is completed, and before the lamp is finally sealed, previously introduced chemicals consisting of mercury sulphide or other suitable oxygen-absorbing mercury salts are heated in the small tube by means of which the lamp is connected with the air pump, and this serves to take up practically all of the remaining oxygen.

The prevalence of moisture is one of the difficulties in obtaining a complete vacuum. In order to make this difficulty as negligible a feature as possible, the moisture is largely removed by means of a small drying tank attached to the pump. This little vessel contains a vapor-absorbing mixture, such as sulphuric or phosphoric acid, called the drying solution. Lamps using no vacuum have come into the lighting field, but in this case the material giving incandescence is an inoxidizable substance.

After the vacuum process is completed, the glass tip, connecting it by an orifice to the exhaust tube, is melted and sealed permanently. In actual practice a long string of lamps are treated simultaneously

in this manner, the exhaustion and final sealing forming part of a rapid process.

After the lamps have been exhausted, they are tested and then the metal cap or top is finally attached. Plaster of paris is used between the cap and the glass bulb in order to give firmness and solidity to the joint, proper connections being made with the leading-in wires. The lamp is now complete, and is again tested to see that the contacts are properly made, after which they are packed in baskets and kept at a temperature of 90 degrees F. for four or five days, so that the plaster of paris may thoroughly harden, after which they are again tested to see that the caps have remained straight during the drying of the plaster. When the globes are to be frosted, this is done by holding them in a sand-blast.

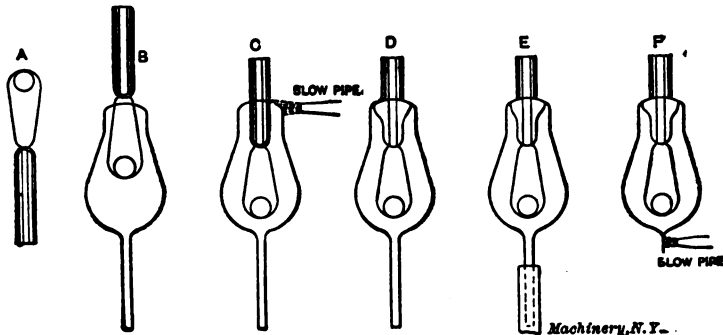

Fig. 23. Successive Stages in Lamp Manufacture

In Fig. 23 the successive processes in lamp manufacture are indicated. At A is shown the filament as attached to the platinum leading-in wires inserted in a small glass tube. It should be understood that platinum is used only for the short distance where the wire must pass through the glass wall, the platinum wires being not more than  $\frac{1}{8}$  inch long. The remainder of the leading-in wire is of copper. At B the glass bulb is shown with the filament ready to be inserted, and at C the filament is shown in place, the blowpipe being applied for sealing up the bulb at the top. At D the bulb is indicated as sealed. At E the vacuum pump is connected, and at F the blowpipe is finally applied at the lower end of the lamp, and the lamp sealed. Of course, this illustration is only diagrammatical and merely serves the purpose of indicating the various operations.

#### Metallic Filament Lamps

Metallic filament lamps have been used successfully only during the last few years. The first successful metallic filament lamp was the tantalum lamp, but the one now most commonly used is the tungsten lamp.

The chief advantages of the tungsten lamp are that tungsten can be heated to a very high temperature without fusing, and hence gives out a very brilliant light, and that the lamp consumes far less current

per candle-power than the ordinary carbon lamp. Edison's first incandescent lamp, using a bamboo filament, consumed from 4 to  $4\frac{1}{2}$  watts per candle-power. The present day carbon filament lamp consumes from 3 to  $3\frac{1}{2}$  watts per candle-power. In the metallic filament lamps these figures are considerably reduced, so that the tantalum lamp, for example, consumes only from 2 to  $2\frac{1}{2}$  watts, and the tungsten lamp from  $1\frac{1}{2}$  to 2 watts per candle-power. The disadvantages of the tungsten lamp are its higher cost and the fragility of the filament when no current passes through it. Owing to the low electrical resistance of tungsten, it is necessary to employ a very long filament as compared with that in carbon lamps, the filament for a 110-volt lamp, for example, being 30 inches long. This filament is mounted in the lamp on supports as shown in Fig. 24. Although tungsten

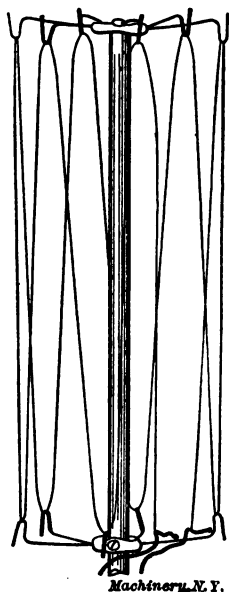

Fig. 24. Tungsten Lamp

itself occurs abundantly in nature, and is a comparatively cheap metal, the cost of producing the long filament is the cause of the higher cost of the lamp; the fragility is due to the fragile nature of the fine tungsten thread and the unsatisfactory method used for mounting it in the lamp, which is made necessary by the fact that the filament cannot, as yet, be procured in sufficiently long single lengths for a whole lamp.

The tungsten filament is, mechanically, quite similar to glass. A slender rod or thread of glass has great tensile strength and it can be bent; the smaller the diameter the more can it be bent without breaking. But it is fragile, and a slight blow shatters it. When it is warm it becomes quite soft. This description applies equally to the tungsten filament. Now, either a glass or a tungsten rod or filament, if rigidly held at one point is much more apt to break than if loosely supported. And yet the fragile tungsten filament is held rigidly at its ends. In the ordinary lamp the total filament consists of four or five hairpin shaped parts, each rigidly fastened to stiff wires at its ends, making a total of eight or ten points of rigid support. The support is made absolutely rigid, usually by electrically welding or fusing the supporting wire around the tiny filament. The result is that one of the best known features of the lamp is its fragility, and the mechanical break almost invariably occurs near the fused support.

The reason for this unfortunate construction is that tungsten filaments can only be made in short lengths in hairpin shape. It has not been practicable by usual methods to make and mount single filaments having a length of 30 inches, more or less, which is necessary for a 110-volt lamp. Consequently it has been common practice to connect in series a number of individual short filaments by fusing their ends

to stiff supporting wires; hence, the disadvantage of rigidly supported, delicate and fragile filaments results from the necessity of using many individual filaments, adapted in length to the size of the lamp bulb. The ideal way to overcome these difficulties would be to employ a single filament and to mount it without rigidly fastening it to its supports. This requires three things. First, a single or continuous filament; second, a loose winding back and forth around supports at numerous points, giving a final form appropriate to the ordinary lamp bulb; and, third, a suitable electrical contact with the leading-in wires, eliminating the fatal rigidity.

To sum up, the tungsten lamp has very quickly established its claim as to high efficiency, excellent light and general acceptability. On the other hand, a feature of the lamp which is firmly fixed in the minds of all who have had to do with it is its fragility. Its liability to accidental breakage in handling and in service is its great handicap. Whenever, therefore, an improvement is made in the materials or construction of the lamp, which will materially reduce its fragility, an important commercial advance will have been made. The life of the lamp, if the filaments remain unbroken, is about 1,000 hours.

## CHAPTER IV

### SPECIAL TYPES OF LAMPS

Besides the ordinary arc lamps and incandescent filament lamps commonly used, and described in detail in the previous chapters, a number of different types of electric lamps and methods for electrical illumination have appeared from time to time, some of which have proved very successful. Among these must especially be mentioned the Nernst

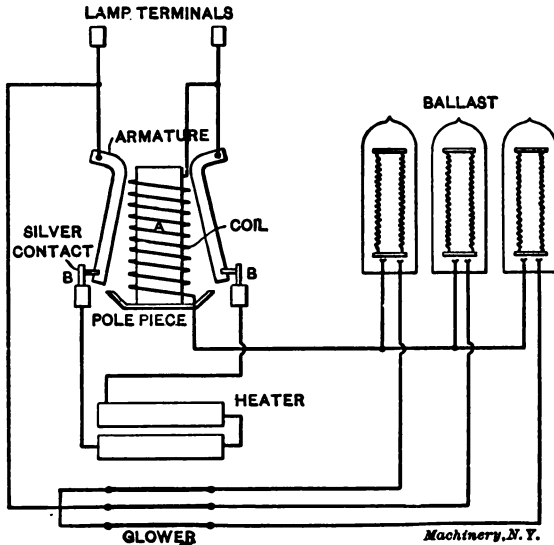

Fig. 25. Wiring Diagram of Nernst Lamp

lamp, and the mercury vapor lamp, also known as the Cooper Hewitt light.

#### The Nernst Lamp

The Nernst lamp, also known as the glower lamp, employs for its incandescent material a fine rod made of rare oxides, the exact composition of which appears to be a "trade secret." The oxide is originally made in the form of a paste, and then forced through a die in order to give it the required shape. The *glower* thus formed is then dried or "roasted," cut to the desired length for the lamps, and provided with platinum terminals to make contact with the circuit. The rare oxide rod or glower is non-conducting when cold, and must, in consequence, be heated before it can conduct the current and produce light. Therefore, a heater is required for the lamp, which will bring the temperature of the glower up to a point where it will become a conductor. The

heater works automatically when the light is turned on, it being connected across the circuit, but it is also necessary to cut it out automatically as soon as the glower has reached the required temperature, as it would otherwise quickly deteriorate. The automatic cut-out is accomplished by means of an electromagnet so connected that current flows through it as soon as the glower has become a conductor. This electromagnet operates a contact cutting out the heater.

The heaters are made in two forms. One kind of heater consists of a platinum wire wound around a porcelain tube and covered with porcelain to prevent too rapid deterioration. Such a heater is shown in the diagrammatical wiring diagram of a Nernst lamp in Fig. 25. As shown, it is mounted just above the glower, and is known as a heater tube. The second kind of heater is of the type shown in Fig. 26. It is known as a spiral heater, and consists of platinum wire wound around a porcelain rod, the whole being then bent to a helical form which surrounds the glower.

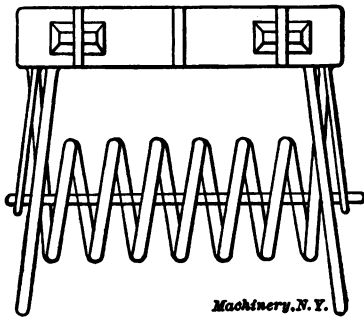

Fig. 26. Spiral Heater for Nernst Lamp, consisting of Platinum Wire wound around a Porcelain Rod

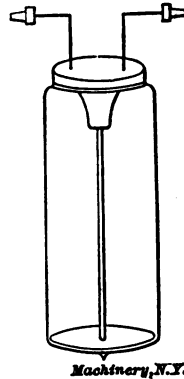

Fig. 27. Ballast Resistance of Nernst Lamp

When the current is turned on, the glower is heated, and then the heater cut out as already mentioned. When the current is turned off, the contacts for the heater assume their normal position, closing the circuit, so as to be ready for action when the current is again turned on. The closing of the heater circuit when the current is turned off is accomplished by means of gravity, so that it is necessary that lamps of this description should be mounted in a specific position.

The fact that the resistance of the glower decreases with an increasing temperature, introduces a peculiar condition in the construction of this class of lamps. If the lamp were used on a constant-potential circuit, without any means of regulation, the temperature of the glower would continue to increase (due to the greater amount of current flowing through it, on account of its increasing conductivity) until the glower would be entirely destroyed. In order to check this action, a resistance in the form of an iron wire, is connected in series with the glower. This resistance is called a ballast or a ballast resistance.



As the resistance of iron increases with an increasing temperature, it is possible to so adjust the resistance of the entire circuit that a balanced condition is obtained when the current reaches a given strength. In order to prevent oxidation of the iron wire, it is mounted in a glass tube or bulb containing hydrogen, in a manner as shown in Fig. 27, and as indicated in the wiring diagrams Figs. 25 and 28. The reason why hydrogen has been selected in preference to other gases which might have been used as well for their non-oxidizing properties, is that it conducts the heat from the iron wire better than other gases.

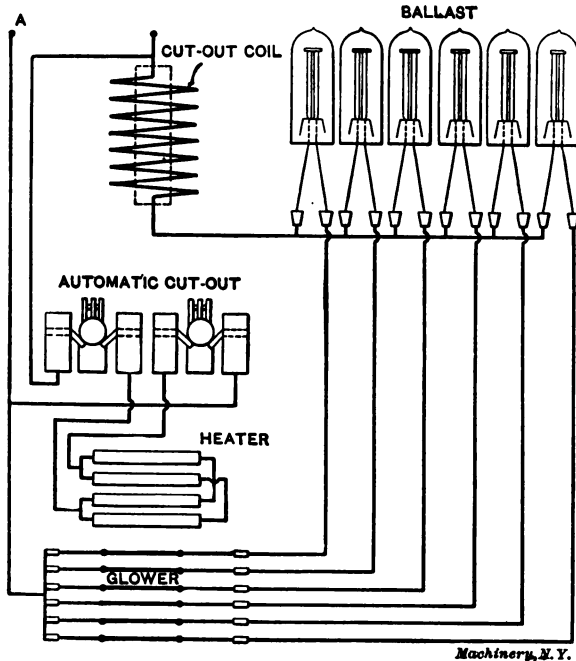

Fig. 28. Wiring Diagram of a Six-Glower Nernst Lamp

To sum up, the Nernst or glower lamp consists of four main constituent parts, as follows:

1. The rare oxide rod or glower which gives the light at a high temperature.
2. The heater for raising the temperature of the glower when the current is first turned on.
3. The automatic cut-out for the heater after it has done its work.
4. The iron wire ballast contained in a tube of gas which regulates the amount of current.

The parts enumerated are mounted together, smaller lamps having but one glower, and being made to fit a standard incandescent lamp socket, while larger lamps are made with as many as six glowers, and are supported the same as ordinary arc lamps.

The standard makes of Nernst lamps possess a glower which takes about 220 volts, is 1 inch in length and about 1/40 of an inch in diameter. The temperature at which the light is produced varies from 1,200 degrees F. to 1,400 degrees F., depending upon the current. A fair average is 1,300 degrees F., at which temperature the normal light appears.

The candle-power tests give results as follows: A two-glower, 220-volt lamp gives about 70 candle-power with a watt consumption of about 170, or about 2.5 watts per candle-power. The light given out during the life of the lamp is very white and agreeable to the eyes when passed through sand-blasted globes.

The glower lamp needs no vacuum, because the filament cannot be consumed in the air. If enclosed in a vacuum, the absence of air produces a higher temperature and a lower resistance; in consequence, more ballast is required to cut down the current, so the efficiency is not advanced to any remarkable extent by this method.

The general arrangement of the wiring for Nernst lamps is indicated in Fig. 25, for a three-glower lamp, and in Fig. 28, for a six-glower lamp. In the former illustration, the automatic device for cutting out the heater has been shown in detail. As soon as current begins to flow through the glowers, the electro-magnet *A* is also energized, and the silver contacts at *B* are opened, thus preventing current from flowing through the heater coils. In Fig. 28, the current enters at lamp terminal *A* and then passes through the contact of the automatic cut-out to the heater coils. When the glowers begin to conduct, current will pass through the cut-out coil, and this will open the contacts of the automatic cut-out, thus rendering the heater inoperative. On some of the newer types of lamps, the spiral heater is used in preference to the heater tubes, and both glower and heater are so mounted that they can be very quickly replaced. The life of the glower is about 700 hours. Nernst lamps are used exclusively on alternating current circuits.

### The Mercury Vapor Lamp

The mercury vapor lamp, invented by Cooper Hewitt, has gained considerable ground in a few years. Its chief advantage is that it consumes a very small amount of current per candle-power, the current consumption being only about 0.55 watt per candle-power. The objection to this lamp is that it gives out a light devoid of red light-rays, and, therefore, apparently, changes the color of objects illuminated by it. This absence of red rays makes the light very agreeable to the eyes, however, although it limits the application of the lamp to such places where its color is of no importance.

In this lamp the source of light consists of mercury vapor which is rendered incandescent by the passage of an electric current through a long glass tube from which the air is exhausted, and in which the vapor is contained. To one end of the glass tube is attached an electrode either of iron or mercury, while the other electrode is always of mercury.

When the lamp is to be started, mercury vapor may be formed in one of two ways. One method is by means of a high-tension spark which jumps between the electrodes, and thus forms the required conducting vapor. To obtain the spark, it is necessary to provide a powerful inductance coil and a quick-break switch. The other method used for starting the lamp is to tilt the tube until a stream of mercury is formed from electrode to electrode; the tube is then permitted to resume its

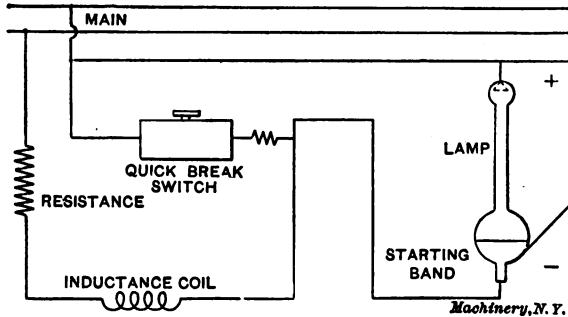

Fig. 29. Mercury Vapor Lamp started by High-tension Spark

original position, enough vapor having been formed to provide a conducting bridge between the electrodes. The mercury vapor lamp is especially adapted to operate on direct-current circuit, but considerable advance has been made in developing an alternating current lamp as well.

In Fig. 29 is shown a lamp circuit where the lamp is started by a high-tension spark. Fig. 30 shows the wiring diagram for two lamps

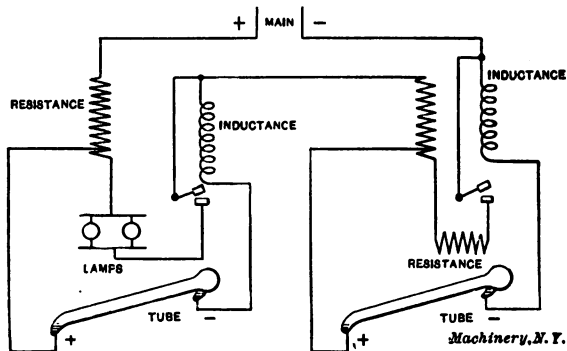

Fig. 30. Wiring Diagram for Lamp started by the Tipping Method

in series and arranged for being started by the "tipping" method.

Some general data relating to mercury lamps may be of interest. The length of the glass tube varies from 43 to 49 inches, according to the voltage. The diameter is 1 inch. The strength of the current is from 3 to 3.5 amperes, which with a voltage of 110 volts gives a candle-power of about 650. The life of the lamp is from about 1,000 to 1,600 hours.

The candle-power being unusually high for a small amount of current would make this light universal in application if red rays were present. Their absence, however, limits its use to docks, large lofts, factories and places where the color problem plays no important part. The suggestion once advanced that the tube be made of red glass to supply the missing rays would mean darkness instead of light. As there are no red rays in the light, and as none but red rays can pass through red glass, it is obvious that no light would penetrate the walls of the tube. The only remedy would be to provide a means of developing red rays in the tube itself by the introduction of another element or a modification of the method.

**The Moore Tube Light**

If a gas is contained at a high vacuum in a glass tube, and the tube is provided with electrodes and a high-tension alternating current forced through the gas, the latter will glow with a soft luminescence. The color of the light produced is governed by the gas contained in the tube. Carbon dioxide produces a white, diffused light, very similar to daylight, while nitrogen produces an orange light.

The Moore tube light is based upon the principles outlined above. It consists of a very long glass tube containing the gas at the required degree of vacuum. A transformer must be employed to obtain the necessary high voltage of the alternating current sent through the tube. As the gas used gradually deposits on the glass wall of the tube, and as it is necessary that a certain degree of vacuum be maintained, an automatic valve is provided for supplying the required amount of gas, whenever the vacuum becomes too great. The reason for the very long glass tubes used is that the intensity of the light is only about 0.65 candle-power per square inch of tube surface. The efficiency of the light tubes, however, is stated to be equal to that of tungsten filament incandescent lamps.

# OUTLINE OF A COURSE IN SHOP AND DRAFTING-ROOM MATHEMATICS, MECHANICS, MACHINE DESIGN AND SHOP PRACTICE

Any intelligent man engaged in mechanical work can acquire a well-rounded mechanical education by using as a guide in his studies the outline of the course in mechanical subjects given below. The course is laid out so as to make it possible for a man of little or no education to go ahead, beginning wherever he finds that his needs begin. The course is made up of units so that it may be followed either from beginning to end; or the reader may choose any specific subject which may be of especial importance to him.

## Preliminary Course in Arithmetic

JIG SHEETS 1A TO 5A:—Whole Numbers: Addition, Subtraction, Multiplication, Division, and Factoring.

JIG SHEETS 6A TO 15A:—Common Fractions and Decimal Fractions.

## Shop Calculations

Reference Series No. 18. SHOP ARITHMETIC FOR THE MACHINIST.

Reference Series No. 52. ADVANCED SHOP ARITHMETIC FOR THE MACHINIST. Reference Series No. 53. USE OF LOGARITHMIC TABLES.

Reference Series Nos. 54 and 55. SOLUTION OF TRIANGLES.

Data Sheet Series No. 16. MATHEMATICAL TABLES. A book for general reference.

## Drafting-room Practice

Reference Series No. 2. DRAFTING-ROOM PRACTICE.

Reference Series No. 8. WORKING DRAWINGS AND DRAFTING-ROOM KINKS.

Reference Series No. 33. SYSTEMS AND PRACTICE OF THE DRAFTING-ROOM.

## General Shop Practice

Reference Series No. 10. EXAMPLES OF MACHINE SHOP PRACTICE.

Reference Series No. 7. LATHE AND PLANEER TOOLS.

Reference Series No. 25. DEEP HOLE DRILLING.

Reference Series No. 38. GRINDING AND GRINDING MACHINES.

Reference Series No. 48. FILES AND FILING.

Reference Series No. 32. SCREW THREAD CUTTING.

Data Sheet Series No. 1. SCREW THREADS. Tables relating to all the standard systems.

Data Sheet Series No. 2. SCREWS, BOLTS AND NUTS. Tables of standards.

Data Sheet Series Nos. 10 and 11. MACHINE TOOL OPERATION. Tables relating to the operation of lathes, screw machines, milling machines, etc.

Reference Series Nos. 50 and 51.

## PRINCIPLES AND PRACTICE OF ASSEMBLING MACHINE TOOLS.

Reference Series No. 57. METAL SPINNING.

## Jigs and Fixtures

Reference Series Nos. 41, 42 and 43. JIGS AND FIXTURES.

Reference Series No. 3. DRILL JIGS. Reference Series No. 4. MILLING FIXTURES.

## Punch and Die Work

Reference Series No. 6. PUNCH AND DIE WORK.

Reference Series No. 13. BLANKING DIES.

Reference Series No. 26. MODERN PUNCH AND DIE CONSTRUCTION.

## Tool Making

Reference Series No 64. GAGE MAKING AND LAPPING.

Reference Series No. 21. MEASURING TOOLS.

Reference Series No. 31. SCREW THREAD TOOLS AND GAGES.

Data Sheet Series No. 3. TAPS AND THREADING DIES.

Data Sheet Series No. 4. REAMERS, SOCKETS, DRILLS, AND MILLING CUTTERS.

## Hardening and Tempering

Reference Series No. 46. HARDENING AND TEMPERING.

Reference Series No. 63. HEAT TREATMENT OF STEEL.

## Blacksmith Shop Practice and Drop Forging

Reference Series No. 44. MACHINE BLACKSMITHING.

Reference Series No. 61. BLACKSMITH SHOP PRACTICE.

Reference Series No. 45. DROP FORGING.

## Automobile Construction

Reference Series No. 59. MACHINES, TOOLS AND METHODS OF AUTOMOBILE MANUFACTURE.

Reference Series No. 60. CONSTRUCTION AND MANUFACTURE OF AUTOMOBILES.

### Theoretical Mechanics

Reference Series No. 5. FIRST PRINCIPLES OF THEORETICAL MECHANICS.  
Reference Series No. 19. USE OF FORMULAS IN MECHANICS.

### Gearing

Reference Series No. 15. SPUR GEARING.  
Reference Series No. 37. BEVEL GEARING.  
Reference Series No. 1. WORM GEARING.  
Reference Series No. 20. SPIRAL GEARING.  
Data Sheet Series No. 5. SPUR GEARING. General reference book containing tables and formulas.  
Data Sheet Series No. 6. BEVEL, SPIRAL AND WORM GEARING. General reference book containing tables and formulas.

### General Machine Design

Reference Series No. 9. DESIGNING AND CUTTING CAMS.  
Reference Series No. 11. BEARINGS.  
Reference Series No. 56. BALL BEARINGS.  
Reference Series No. 58. HELICAL AND ELLIPTIC SPRINGS.  
Reference Series No. 17. STRENGTH OF CYLINDERS.  
Reference Series No. 22. CALCULATIONS OF ELEMENTS OF MACHINE DESIGN.  
Reference Series No. 24. EXAMPLES OF CALCULATING DESIGNS.  
Reference Series No. 40. FLY-WHEELS.  
Data Sheet Series No. 7. SHAFTING, KEYS AND KEYWAYS.  
Data Sheet Series No. 8. BEARINGS, COUPLINGS, CLUTCHES, CRANE CHAIN AND HOOKS.  
Data Sheet Series No. 9. SPRINGS, SLIDES AND MACHINE DETAILS.  
Data Sheet Series No. 19. BELT, ROPE AND CHAIN DRIVES.

### Machine Tool Design

Reference Series No. 14. DETAILS OF MACHINE TOOL DESIGN.  
Reference Series No. 16. MACHINE TOOL DRIVES.

### Crane Design

Reference Series No. 23. THEORY OF CRANE DESIGN.  
Reference Series No. 47. DESIGN OF ELECTRIC OVERHEAD CRANES.  
Reference Series No. 49. GIRDERS FOR ELECTRIC OVERHEAD CRANES.

### Steam and Gas Engine Design

Reference Series Nos. 67 to 72, inclusive. STEAM BOILERS, ENGINES, TURBINES AND ACCESSORIES.  
Data Sheet Series No. 15. HEAT, STEAM, STEAM AND GAS ENGINES.  
Data Sheet Series No. 13. BOILERS AND CHIMNEYS.  
Reference Series No. 65. FORMULAS AND CONSTANTS FOR GAS ENGINE DESIGN.  
Special Course in Locomotive Design  
Reference Series No. 27. BOILERS, CYLINDERS, THROTTLE VALVE, PISTON AND PISTON ROD.  
Reference Series No. 28. THEORY AND DESIGN OF STEPHENSON AND WALSCHAERTS VALVE MOTION.  
Reference Series No. 29. SMOKE-BOX, FRAMES AND DRIVING MACHINERY.  
Reference Series No. 30. SPRINGS, TRUCKS, CAB AND TENDER.  
Data Sheet Series No. 14. LOCOMOTIVE AND RAILWAY DATA.

### Dynamos and Motors

Reference Series No. 34. CARE AND REPAIR OF DYNAMOS AND MOTORS.  
Data Sheet Series No. 20. WIRING DIAGRAMS, HEATING AND VENTILATION, AND MISCELLANEOUS TABLES.  
Reference Series Nos. 73 to 78, inclusive. PRINCIPLES AND APPLICATIONS OF ELECTRICITY.

### Heating and Ventilation

Reference Series No. 39. FANS, VENTILATION AND HEATING.  
Reference Series No. 66. HEATING AND VENTILATING SHOPS AND OFFICES.  
Data Sheet Series No. 20. WIRING DIAGRAMS, HEATING AND VENTILATION, AND MISCELLANEOUS TABLES.

### Iron and Steel

Reference Series No. 36. IRON AND STEEL.  
Reference Series No. 62. TESTING THE HARDNESS AND DURABILITY OF METALS.

### General Reference Books

Reference Series No. 35. TABLES AND FORMULAS FOR SHOP AND DRAFTING-ROOM.  
Data Sheet Series No. 12. PIPE AND PIPE FITTINGS.  
Data Sheet Series No. 17. MECHANICS AND STRENGTH OF MATERIALS.  
Data Sheet Series No. 18. BEAM FORMULAS AND STRUCTURAL DESIGN.  
Data Sheet Series No. 20. WIRING DIAGRAMS, HEATING AND VENTILATION AND MISCELLANEOUS TABLES.

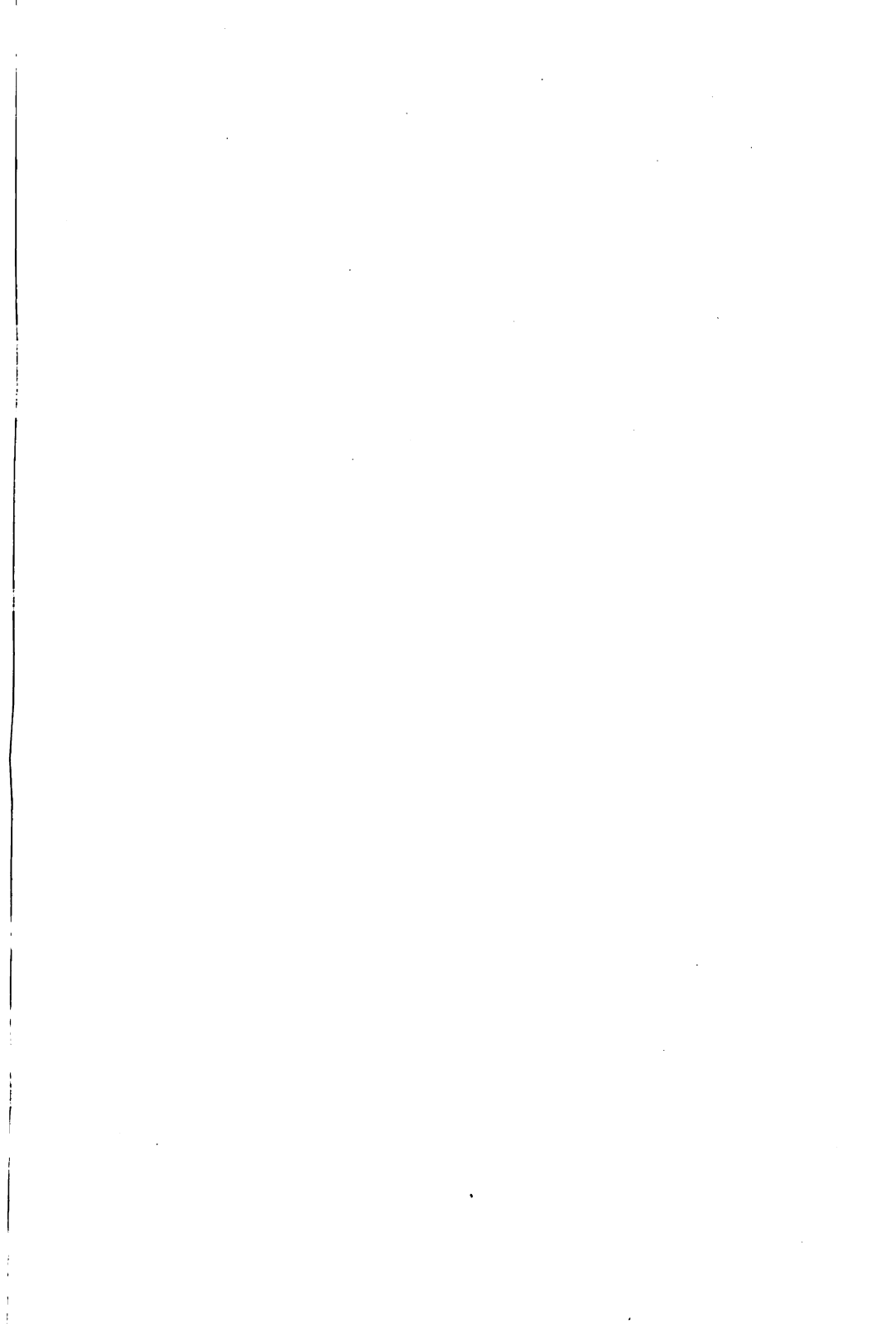



## CONTENTS OF DATA SHEET BOOKS

**No. 1. Screw Threads.**—United States, Whitworth, Sharp V- and British Association Standard Threads; Briggs Pipe Thread; Oil Well Casing Gages; Pipe Hose Connections; Acme Thread; Worm Threads; Metric Threads; Machine, Wood, and Lag Screw Threads; Carriage Bolt Threads, etc.

**No. 2. Screws, Bolts and Nuts.**—Fillister-head, Square-head, Headless, Collar-head and Hexagon-head Screws; Standard and Special Nuts; T-nuts, T-bolts and Washers; Thumb Screws and Nuts; A. L. A. M. Standard Screws and Nuts; Machine Screw Heads; Wood Screws; Tap Drills; Lock Nuts; Eye-bolts, etc.

**No. 3. Taps and Dies.**—Hand, Machine, Tapper and Machine Screw Taps; Taper Die Taps; Sellers; Hobs; Screw Machine Taps; Straight and Taper Boiler Taps; Stay-bolt, Washout, and Patch-bolt Taps; Pipe Taps and Hobs; Solid Square, Round Adjustable and Spring Screw Threading Dies.

**No. 4. Reamers, Sockets, Drills and Milling Cutters.**—Hand Reamers; Shell Reamers and Arbors; Pipe Reamers; Taper Pins and Reamers; Brown & Sharpe, Morse and Jarno Taper Sockets and Reamers; Drills; Wire Gages; Milling Cutters; Setting Angles for Milling Teeth in End Mills and Angular Cutters, etc.

**No. 5. Spur Gearing.**—Diametral and Circular Pitch; Dimensions of Spur Gears; Tables of Pitch Diameters; Odontograph Tables; Rolling Mill Gearing; Strength of Spur Gears; Horsepower Transmitted by Cast-iron and Rawhide Pinions; Design of Spur Gears; Weight of Cast-iron Gears; Epicyclic Gearing.

**No. 6. Bevel, Spiral and Worm Gearing.**—Rules and Formulas for Bevel Gears; Strength of Bevel Gears; Design of Bevel Gears; Rules and Formulas for Spiral Gearing; Tables Facilitating Calculations; Diagram for Cutters for Spiral Gears; Rules and Formulas for Worm Gearing, etc.

**No. 7. Shafting, Keys and Keyways.**—Horsepower of Shafting; Diagrams and Tables for the Strength of Shafting; Forcing, Driving, Shrinking and Running Fits; Woodruff Keys; United States Navy Standard Keys; Gib Keys; Milling Keyways; Duplex Keys.

**No. 8. Bearings, Couplings, Clutches, Crane Chain and Hooks.**—Pillow Blocks; Babbitted Bearings; Ball and Roller Bearings; Clamp Couplings; Plate Couplings; Flange Couplings; Tooth Clutches; Crab Couplings; Cone Clutches; Universal Joints; Crane Chain; Chain Friction; Crane Hooks; Drum Scores.

**No. 9. Springs, Slides and Machine Details.**—Formulas and Tables for Spring Calculations; Machine Slides; Machine Handles and Levers; Collars; Hand Wheels; Pins and Cotters; Turn-buckles, etc.

**No. 10. Motor Drive, Speeds and Feeds, Change Gearing, and Boring Bars.**—Power required for Machine Tools; Cutting Speeds and Feeds for Carbon and High-speed Steel; Screw Machine Speeds and Feeds; Heat Treatment of High-speed

Steel Tools; Taper Turning; Change Gearing for the Lathe; Boring Bars and Tools, etc.

**No. 11. Milling Machine Indexing, Clamping Devices and Planer Jacks.**—Tables for Milling Machine Indexing; Change Gears for Milling Spirals; Angles for setting indexing Head when Milling Clutches; Jig Clamping Devices; Straps and Clamps; Planer Jacks.

**No. 12. Pipe and Pipe Fittings.**—Pipe Threads and Gages; Cast-iron Fittings; Bronze Fittings; Pipe Flanges; Pipe Bends, Pipe Clamps and Hangers; Dimensions of Pipe for Various Services, etc.

**No. 13. Boilers and Chimneys.**—Flue Spacing and Bracing for Boilers; Strength of Boiler Joints; Riveting; Boiler Setting; Chimneys.

**No. 14. Locomotive and Railway Data.**—Locomotive Boilers; Bearing Pressures for Locomotive Journals; Locomotive Classifications; Rail Sections; Frogs, Switches and Cross-overs; Tires; Tractive Force; Inertia of Trains; Brake Levers; Brake Rods, etc.

**No. 15. Steam and Gas Engines.**—Saturated Steam; Steam Pipe Sizes; Steam Engine Design; Volume of Cylinders; Stuffing Boxes; Setting Corliss Engine Valve Gears; Condenser and Air Pump Data; Horsepower of Gasoline Engines; Automobile Engine Crankshafts, etc.

**No. 16. Mathematical Tables.**—Squares of Mixed Numbers; Functions of Fractions; Circumference and Diameters of Circles; Tables for Spacing off Circles; Solution of Triangles; Formulas for Solving Regular Polygons; Geometrical Progression, etc.

**No. 17. Mechanics and Strength of Materials.**—Work; Energy; Centrifugal Force; Center of Gravity; Motion; Friction; Pendulum; Falling Bodies; Strength of Materials; Strength of Flat Plates; Ratio of Outside and Inside Radii of Thick Cylinders, etc.

**No. 18. Beam Formulas and Structural Design.**—Beam Formulas; Sectional Moduli of Structural Shapes; Beam Charts; Net Areas of Structural Angles; Rivet Spacing; Splices for Channels and I-beams; Stresses in Roof Trusses, etc.

**No. 19. Belt, Rope and Chain Drives.**—Dimensions of Pulleys; Weights of Pulleys; Horsepower of Belting; Belt Velocity; Angular Belt Drives; Horsepower transmitted by Ropes; Sheaves for Rope Drive; Bending Stresses in Wire Ropes; Sprockets for Link Chains; Formulas and Tables for Various Classes of Driving Chain.

**No. 20. Wiring Diagrams, Heating and Ventilation, and Miscellaneous Tables.**—Typical Motor Wiring Diagrams; Resistance of Round Copper Wire; Rubber Covered Cables; Current Densities for Various Contacts and Materials; Centrifugal Fan and Blower Capacities; Hot Water Main Capacities; Miscellaneous Tables; Decimal Equivalents, Metric Conversion Tables, Weights and Specific Gravity of Metals, Weights of Fillets, Drafting-room Conventions, etc.

MACHINERY, the monthly mechanical journal, originator of the Reference and Data Sheet Series, is published in three editions—the *Shop Edition*, \$1.00 a year; the *Engineering Edition*, \$2.00 a year, and the *Foreign Edition*, \$3.00 a year.

The Industrial Press, Publishers of MACHINERY,  
49-55 Lafayette Street, New York City, U. S. A.



