

T

352

.C6

Drafting Room Methods

Standards and Forms

CHARLES D. COLLINS

CONTENTS

PART I

THE DRAFTING ROOM

| | PAGE | | PAGE |
|---------------------|-------|------------------------------------|------|
| Location | 9 | Methods of handling work | 18 |
| Equipment | 9-15 | Filing | 31 |
| Personnel | 15-18 | General Instructions | 33 |

STANDARD

| | |
|--------------------------------|----|
| Safety Standards — 1 | 72 |
| Abbreviations | 73 |
| Aëronautical Terms | 83 |
| Cross Sections | 84 |
| Definitions | 85 |
| Electrical Symbols | 86 |
| Lines | 87 |



Class T 352

| | | |
|------------------------------------|--------------------------------|-----|
| Drawing Sizes | Book | 101 |
| Form Sizes | <u>. C 6</u> | 102 |
| Application Blanks | | 103 |
| Arrangement of a drawing | Copyright N ^o _____ | 104 |
| Building Record Book | | 105 |
| Drawing Record Book | | 106 |
| Pattern Record Book | | 107 |
| Print Record Book | | 108 |

COPYRIGHT DEPOSIT.

PART IV

MISCELLANEOUS TABLES

| | | | |
|--------------------------------|---------|------------------------------------|---------|
| Bolt Stresses | 111 | Pipe Fittings — Flanged | 126-129 |
| Bolts and Nuts | 112 | Key Seats | 130-131 |
| Bolt Threads | 113 | Shafting, Horse Power of | 132 |
| Washers | 115 | Gages — Plate | 133 |
| Weight Steel Bars | 116 | Gages — Wire | 135 |
| Studs | 117 | Metric Conversion | 136-137 |
| Pipe Thread — Briggs | 117-119 | Weights and Measures | 138 |
| Pipe Sizes | 120-122 | Decimal Equivalents | 139 |
| Boiler Tubes | 123 | Areas of Circles | 139-142 |
| Pipe Flanges | 124-125 | Reference Books | 143 |





DRAFTING ROOM METHODS
STANDARDS AND FORMS

DRAFTING ROOM METHODS

STANDARDS AND FORMS

A REFERENCE BOOK FOR
ENGINEERING OFFICES
AND DRAFTSMEN

BY
CHARLES D. COLLINS

M. AM. SOC. C. E.

ILLUSTRATED



NEW YORK
D. VAN NOSTRAND COMPANY
25 PARK PLACE
1918

T352
C6

COPYRIGHT 1918, BY
D. VAN NOSTRAND COMPANY

JAN -2 1919

THE PLIMPTON PRESS
NORWOOD MASS U.S.A

©CL.A511207

ms 1

INTRODUCTION

It has heretofore generally been the custom for each company starting or operating a drafting room, to compile its own set of Standard Practice Sheets at much expense of time and with divers results.

This book is an attempt to describe methods and illustrate forms which would be generally applicable in engineering offices and drafting rooms and combine with this the conventional symbols or standards for the different branches of drafting, such as Architectural, Electrical, Mechanical, Patent Office, Structural, and Topographical.

Provision is also made in the index and at the end of each part for the inclusion of special information, data, instructions, etc., pertaining only to the business of each user, and the addition of which information should be a convenience and a step toward completeness.

Parts I and III are intended for those directing a drafting room, as well as draftsmen. The directions for draftsmen and particularly tracers are necessary if uniformity of work is to be attained; otherwise each man will do his work in his own way and the results will be anything but uniform. Part II will be of most value to draftsmen. Here it has been endeavored to give as complete a list of standard symbols as is now available and which either have no traceable parentage or have come into general use through the actions of Government Departments, Committees of the various Engineering and Manufacturers' Societies, and recommendations of the Engineering Publications. To all of these, grateful acknowledgment

is made for the matter used, as noted on the respective standards. Part IV is intended to give some of the tables most often referred to by the draftsman without entering the field of the engineering handbook.

The book was first compiled for the engineering division of a rapidly growing organization engaged in both construction and manufacture. A copy was given to each engineer, draftsman, and tracer, and the results attained in standardization and in the improved operation of the division encouraged the hope that it would prove as useful in other offices. The copy in the hands of the new man, with instructions and an opportunity given him to become familiar with it, was also found to materially reduce the not inconsiderable expense of instructing and training the new employee.

C. D. C.

NEW YORK, *May* 4, 1918

PART I
METHODS

“Method goes far to prevent trouble in business, for it makes the task easy, hinders confusion, saves abundance of time, and instructs those who have business depending what to do and what to hope.”

—WILLIAM PENN.

ARRANGEMENT AND EQUIPMENT

I

THE DRAFTING ROOM

Arrangement. — Many companies give this less consideration than any of their other departments in the matter of location, space per man, ventilation, and light. Why this is so is a mystery to one who knows the expense of running a large drafting room and the difference in output under good and adverse conditions.

The ideal drafting room would be one in a quiet location, with freedom from dust, plenty of north light, ventilation of the best, and at least sixty square feet of floor space per man. Given the proper men, then ventilation and light will be the next two factors affecting output, and any improvement in them will be reflected in the work. If artificial light has to be used, it should be indirect, with walls and ceiling tinted to prevent glare.

Equipment. — Following is a list of the principal articles of equipment of a drafting room, which have been selected only after trial and proven satisfaction.

Drafting Machine. — This tool is now so well known and its utility for detail work so well demonstrated, that its purchase is only a question of the kind and volume of work to be done.

Blueprint Machines. — When the advisability of installing a blueprint machine is considered, the governing factors should be the amount and private nature of the work, access to a professional blueprinter, and his prices.

With the cost of a horizontal machine, complete with washer and drier, around \$1000, office room \$2 per square foot (New York), and an operator at \$75 per month, it will not be a saving investment, when the monthly bills at a printer's would run under \$250 if figured at 2¢ per square foot.

A brief description of the various types of prints, with their prices, follows:

Blueprints, white lines on blue ground on paper

| | |
|---|-------------------|
| Minimum charge | .05 each |
| Charge per sq. ft. | .02, over 42" .03 |
| Specifications in lots of 100 | .02 each |
| Small blueprints in lots of one hundred or more | \$3.50 per 100 |

Blueprints, white lines on blue ground on cloth

| | |
|----------------------------------|-----------------|
| Minimum charge | .15 each |
| Charge per sq. ft. | .07 |
| In lots of 100 or more | \$10.00 per 100 |

Brown Vandyke Prints, negative and positive on paper

| | |
|------------------------------|----------|
| Minimum charge | .15 each |
| Charge per sq. ft. | .08 |
| On cloth per sq. ft. | .15 |
| Minimum charge | .25 each |

Blue Line Paper, from negative, blue lines on white ground

| | |
|------------------------------|----------|
| Minimum charge | .10 each |
| Charge per sq. ft. | .05 |
| On cloth per sq. ft. | .10 |
| Minimum charge | .15 each |

Litho Black Prints, on paper

| | | | | | | |
|----------|----|----|----|---|---|-------------|
| Quantity | 1 | 2 | 3 | 4 | 5 | or more |
| Price | 10 | 9 | 7 | 6 | 5 | per sq. ft. |
| On cloth | 15 | 12 | 10 | 9 | 8 | per sq. ft. |

Blueprint Frame. — A simple and most inexpensive "field office" blueprint frame can be made, for use against a single sash window, with a cleated back-board, with felt pad glued to it, a wood bar across the center of the window, and a wedge. When ready for a print the bottom of the board rests against the bottom of the sash

and the upper part leans against the cross-bar. The tracing and print paper being dropped in behind the board, the latter is pushed up against the glass and the wedge dropped in between the back of the board and the cross-bar. This apparatus is without doubt twice as fast to handle and consequently is only half the work of the usual frame and works very well up to about 18" x 24" size. Some extra tins are required outside to keep the glass from being pushed out if puttied. The board back must be perfectly flat to give even contact and should have a cross-bar for the wedge to act against. The felt should be at least $\frac{1}{4}$ " thick and glued to the board.

A small mirror outside the sash will enable inspection for color of print without disturbing anything.

Files. — The most satisfactory files for tracings were found to be those with five or six drawers to a section, and for prints, those with three or four drawers to a section. All drawers should have a board across the top at the back, and spring clips at the front corners. (See Fig. 1.)

These files can be obtained with drawers measuring 26" x 38" inside which will be the correct size for 24" x 36" drawings and will divide for the smaller sizes as shown in Fig. 1. For the largest standard size drawings (30" x 41") a file can be obtained measuring 32" x 42".

For the protection of the most valuable drawings or tracings from fire or theft, file drawers can now be obtained built in light steel safes of a kind approved by the Board of Fire Underwriters. Another method is to have a Van Dyke print made from each tracing and sent to a depository in a different building.

Ink Bottles. — The ordinary ink bottle has too small a neck for satisfactory use. In dipping a pen in it for

printing, ink is usually smeared on the holder and fingers. A much better arrangement is to buy bottles with larger mouths and corks through which the quills from the old bottles can be run. The drawing ink should then be bought by the pint and the small bottles filled as required.

Pens. — The most convenient for both ruling pens and compasses are the ones that have a spring blade

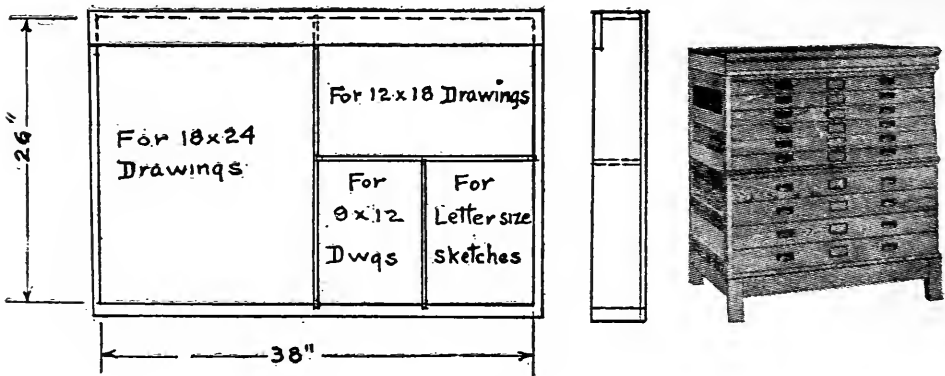

FIG. 1

and which do not require resetting after cleaning and closing.

For printing, the ball point pens seem to work the best, and faster printing can be done with them. Use the ordinary commercial styles for the larger letters, and for the lower case type and figures use a finer pen.

Pencils and Sharpeners. — In drafting rooms where the ordinary wood and lead pencils are used, a convenient instrument is a rotary sharpener, which makes a long taper on the wood part of the pencil and leaves the lead unsharpened. The latter is then finished to suit on the sandpaper board.

A very satisfactory arrangement and time saver is the double end holder with separate leads, a hard one

being kept in one end and a soft lead in the other. A turn of the end then loosens and tightens the lead for adjustment and a sandpaper board does all the sharpening necessary.

The sandpaper board is cleaner than a file, because it holds the lead on its surface.

Scales. — The most convenient and quickest to handle are the single flat scales with both bevels on one side and only one scale to a bevel reading from right to left. This for the $\frac{3}{8}$ and $\frac{3}{4}$ " scales, and the $1\frac{1}{2}$ and 3" scales.

To the above should be added one open divided scale, with inches and 32ds on one side and an open divided decimal scale to inches and 50ths on the other side, the tenth marks being longer and marked .1 to .9.

The $\frac{1}{8}$ and $\frac{1}{4}$ ", $\frac{1}{2}$ and 1", scales can be made of the same style but two scales to a bevel. Except the last, these will have to be made to order, but the extra convenience will repay the slight additional expense.

A small brass knurled knob screwed into the center of each scale will be found very useful for handling it.

The triangular scale is a nuisance for drafting, but convenient for the engineer who does not want a lot of single scales around. A spring clip snapped over the top side will keep the scale in use where it can be readily found.

For accurate scale mechanical work, such as jigs and fixtures, tools and gun parts, the steel scale should be used. A sharp and hard pencil point can then be run down the proper groove and the layout mark made where wanted.

Tables. — For small and medium size drawings a very convenient and satisfactory table, both as to price and operation, is found as shown in Fig. 2. An extra table

without rack and drawer is used alongside the first for reference prints.

If space is limited the reference table can be lower and partly under the drafting table top. Also in emergency a second drawing can be started on it if it is not desirable at the time to clear the regular board.



FIG. 2

For large drawings, where the floor space and resources warrant it, larger and heavier tables can be provided, the most satisfactory probably being the long, flat table with tilting board at the left and drawers at the right side. Not over two small drawers for tools and books and one large drawer for drawings are advisable. Otherwise, prints and drawings which should

be in the general files will collect in them and cause loss of time, and trouble before being found.

Thumb Tacks. — Small tacks with thin pins and heads are the most satisfactory both for ease in removing and least damage to the boards.

T Squares. — Those of hard wood with fixed heads and celluloid edges are the best for general use if it is not desired to go to the expense of fitting the boards with the sliding straight edge kept parallel with cords and pulleys. If the latter is used it should have the cords below the top of the board and have a wood grip screwed to the center for handling it and forming a place for the scale, pencil, and rubber.

Tracing Cloth. — It is advisable to order tracing sheets cut to the sizes required and with the border lines, material

list headings, and title forms printed on them. This will greatly improve the appearance of the work, and the cost will be less than buying cloth by the roll when the saving in cloth and time is considered.

II

ORGANIZATION

The drafting force may be divided as required into groups or squads for the following classes of work:

Architectural and
Structural
Electrical
Mechanical
Topographical
General and Tracing.

Each group should be in charge of a designated head, through whom all work for that group should be given and thereafter followed up.

The drafting work should be apportioned to give each group its special class of drafting whenever possible.

The head of any group should coöperate with the others in the use of his men when requested, and it can be done without detriment to his own work. In such cases the draftsmen thus temporarily assigned to another group will be under the direction of the head of that group until the completion of the work.

Administration. —

Hours.

Notification of change of address.

Notification, or permission for, intended absence.

Notification of special experience or ability, including foreign languages spoken.

Suggestions welcomed for improvement in apparatus or methods.

Rules as to smoking. Not permitted in some drafting rooms owing to interference with the work.

Overtime.

Above are a few suggested "Heads" for subjects on which no two offices agree, and which are therefore best covered by special instructions in each case.

Men. — A certain Iron Master taught us that success in a business mostly depended on the proper selection of men and their assignment to the class of work for which they were best adapted.

Nowhere can this be better demonstrated than in the conduct of an engineering and drafting force. A careful study of characteristics and training will be necessary and some trials at different kinds of work may be required to place some of the men. But this will be time well spent.

It has been demonstrated in companies which train their own men that certain types could not be developed into satisfactory draftsmen but made excellent tracers. Others who were not successful as designers did very good work as estimators. Still others who passed as excellent designers, having ability, boldness, and originality, were very liable to make many small errors and their work in consequence required very careful checking. Then a careful, thorough type who had the qualities to make excellent checkers were largely found to fail on work requiring original designing ability.

Such changes in the work of men, made with tact and judgment and with due analysis of the work as well as

the men, are bound to result in more and better work and a large decrease in the labor turnover.

The more varied the work, with the consequent larger force on which to work, the greater the proportionate results to be attained.

Men — Qualifications. — The five chief qualities a draftsman should cultivate are: accuracy, technique, speed, economy, and neatness.

Accuracy is the greatest of these. A mistake should be considered as a reflection on character, and an effort should be made to get in the habit of doing accurate work.

Technique should be studied thoroughly, as without it work appears amateurish and invites lack of confidence.

Speed in drafting is the result of mental processes as well as manual dexterity. It naturally follows quick thought when the subject is understood and technique is at command.

Economy. Speed will cover about half of this qualification. The other half is to be attained by close attention to what details, dimensions, and shading are essential and what are not.

Neatness is placed last from an efficiency standpoint when weighed with the other qualities. It should be developed into a habit, and will usually be noted in the work of men possessing the other qualities.

Men — Output. — With the great increase in rents, salaries, and equipment, a drafting room is now a more expensive part of an organization than ever before. Every draftsman should realize this, and that his output is given keener scrutiny than ever, and even weighed against the rental value of the space occupied. He should therefore try to save his employer what time he can on his work,

for the man who turns out the most of satisfactory work is the one who is kept on during slack times.

It is a conservative estimate to place at 20% the time that could be saved on the average draftsman's work by a stricter attention to the omission of *nonessential* detail, shading, and dimensions, and in many places the substitution of a note for a detail, particularly in calling for standard equipment.

Perception of what is essential and what not should be developed, so that the work turned out will be a mechanical drawing and not a "picture."

The ability to do this is particularly valuable as a time saver in the early stages of a drawing, before the design is approved, as any unnecessary work done up to this approval is frequently wasted if the design is changed.

Work is often seen which at first glance appears to be all that could be desired, but closer inspection reveals a lack of essential mechanical information necessary for the manufacture of the matter shown. This lack is covered up by nonessential information, shading, useless dimensions and detail of standard fittings, such as bolts, nuts, valves, etc., and makes of the drawing what is termed in factory drafting rooms a "pretty picture."

These remarks do not apply to drawings for illustration, advertising matter, or Patent Office work, where the pictorial effect is desired.

III

GENERAL DIRECTIONS

General Directions. — Two important rules should be kept in mind to insure satisfactory work in the drafting room:

First. — Arrange and perform the work in the order of its importance.

Second. — Do not start new work until the completion of old, unless the latter is held up for information or some other very good reason.

Work Orders. — Authorizations for drawing work should be issued by the chief draftsman on special forms, such as shown in Part III, and which shall give name of part or section of plant for which the work is intended, location, character of work, for whom intended, date, account or charge number, directions for and disposal of the completed work.

Copies of authorizations to the number required for office routine will be made, the usual distribution being to estimating department, engineer, chief draftsman, and draftsman.

The draftsman's copy has on reverse side a space in which to add directions as to titles, drawing numbers, and space for draftsman's time for cost account. The draftsman's copy follows the drawing throughout and is returned with completed drawings to chief draftsman for record and file. After completion of work any of the other copies may be destroyed as desired, their purpose being to assist in following up the work.

Much time is wasted and heavy drafting expense incurred when important proposed work is not first sketched out and discussed before any drafting is done. Some offices even make it a practice not to discuss such work until the tracings are finished; not realizing the time and money lost in making the changes which invariably follow this method, and the loss of interest and initiative on the part of the draftsman who has his supposedly completed work changed again and again.

At these discussions the endeavor should be made to get the source of information as close to the drawing board as possible, to avoid loss of value in transmitted information. Granting the information has come to the Chief or Squad Draftsman in good form for, let us say, an article to be manufactured, he is expected to make the drawing with due regard to all operations which follow, such as, tool making, pattern making, foundry work, machining, assembling, and, last but not least, selling. As few men are familiar with all these processes, preliminary sketches or prints and discussions should touch all these departments with a view to obtaining the best information relative to economical and rapid progress of the work through each.

With proper organization and handling, this can be done without friction and the results in the final product should justify the initial trouble and expense.

With sufficient new work it is advisable to have a man or men assigned to this class of preliminary work, preparing pencil sketches for discussion and approval of those in authority, before any real drafting work is attempted. Revised sketches should then be issued with the work authorizations and be filed with them when the drawings are completed.

Starting a Drawing. — Return to the proper source all work orders, drawings, reference prints, and data relating to the last completed job.

Write in pencil, on the lower right-hand edge of the paper, the name of the drawing, plant, order number of the work, and your initials.

Keep the work one and one half inches from the left edge of the paper or cloth, to leave room for binding of prints.

Do not crowd the views or parts shown. Leave space on detail sheets near title, for additions and revisions.

Scale. — The scale to which a drawing should be made is the one just large enough to show clearly the parts wanted, and to accommodate without crowding the dimensions and notes.

Use $\frac{3}{8}$ ", $\frac{3}{4}$ ", $1\frac{1}{2}$ ", 3", and full-size scales for mechanical work.

Use $\frac{1}{8}$ ", $\frac{1}{4}$ ", $\frac{1}{2}$ ", and 1" scales for architectural work.

Where more than one scale is used on the same drawing, give the scale under each part as well as in the title box.

Arrangement. — In general, draw plan at the left side of the sheet, with front elevation below and end elevation to the right.

Avoid unnecessary ornamental and shading work that will increase the drafting time and cost.

When more than one sheet is required for a piece of work, if practicable keep the sheets of uniform size.

When details call for several classes of materials which would be supplied by different companies, group the parts to be made of like material, and show each group on a separate sheet or sheets.

Do not crowd the work. If detailing several small parts on one sheet, use a drawing sheet large enough to leave room for the addition of two or three more parts and for revisions. Draw details in their natural position and to the same "hand" as seen in the assembly drawing.

Dimensions. — Give length and breadth dimensions on the plan, and dimensions of height or depth on one of the elevations only.

Do not repeat dimensions on the different elevations or projections.

Give over-all dimensions.

Give dimensions in inches up to 72", after that in feet and inches.

Center lines are often only imaginary lines, and for that reason, on mechanical work, it is better to work from a finished edge or surface.

Use thin broken lines for dimension lines and do not place them near construction lines.

Do not cross dimension and construction lines when it can be avoided.

Make notes about dimensions, above the construction lines rather than below.

Make notes and figures to read from not more than two directions; namely, bottom and right side of drawing.

Make notes and figures read from the same direction that the drawing reads to which the notes and figures apply.

Keep notes outside the objects drawn and use a light pointing line to the part to which reference is made.

Group the notes referring to the same detail.

Do not write notes across dimension or construction lines.

Be consistent and follow the same system of making notes and dimensions throughout the work.

Figures. — Make fractions with a horizontal dividing line, thus: $\frac{1}{2}$, not 1/2.

Use single-stroke inclined figures.

Make whole numbers about $\frac{7}{64}$ " to $\frac{1}{8}$ " high.

Make fractions with each figure about $\frac{5}{64}$ " to $\frac{3}{32}$ " high.

Make numbers of drawings about $\frac{5}{16}$ " high.

On pencil work for preliminary prints, be sure that the figures are made dark enough to print well.

Lettering. — Few things add so much to the appearance of a drawing as well-lettered notes and figures properly

placed. The art of making good letters and figures requires some study as well as practice, for the picture of a perfect letter or figure must exist in the mind before it can be made with the hand. The first step, then, is to memorize the appearance of a perfectly formed alphabet and set of figures, of the style to be used, and then practice the strokes necessary to make them. Single straight strokes should be tried first, then the *o*, *c*, and *s*, which will cover most of the strokes also required for the figures.

The most common faults to be guarded against are too much space between the letters of a word and not enough space between the words.

A fine but stiff pen will be found the most satisfactory for small lettering and figures, and a ball point pen for the larger sizes, titles, etc.

The use of single-stroke inclined Italic letters $\frac{7}{8}$ " to $\frac{1}{8}$ " high for capitals, and $\frac{5}{8}$ " to $\frac{3}{8}$ " for small letters, is recommended for appearance, ease, and rapidity of execution.

The style of letter in the first example below, called the Italic, is the simplest and quickest to make, as it requires the least number of strokes. When a straight line will do, it is used and an entire absence of extra curves and curls is aimed at. To avoid blurring where lines meet at a point, both strokes should be drawn toward the point whenever possible, and, for speed, a pen so fine that it sticks in the paper should not be used. It is better to use a slightly coarser pen and make the letters a trifle larger.

The second example, of the same general type of letter but made in a vertical position and with a heavier line, is called the Gothic alphabet and is gaining in favor. It is harder to make after using the Italic, but practice with the work squarely in front of one, and both eyes focusing at

the same angle, will overcome the trouble. This type looks better in the titles and can be well executed by using a piece of cross-section paper under the tracing cloth.

The above applies to working drawings for manufacturing and construction purposes. Drawings for illustration and advertising matter are in a different class and there more elaborate letters are frequently desired and used.

The third example is an adaptation of the Roman alphabet used by architects. Several modifications are seen and like the other alphabets they are made in both compressed and extended form, the underlying idea seeming to be equal blank spaces between the lines composing the letters, thus producing a pleasing uniform effect rather than extreme legibility. The round letters, such as *o*, *c*, and *s* are inclined to the right or left to suit the space, and when two *o*'s come together they are interlocked.

These three examples may be said to cover present requirements and all should be made freehand, as the day of the drawn letter has passed.

ABCDEFGHIJKLMNO
PQRSTUVWXYZ!?:;:-'
1234567890

ABCDEFGHIJKLMN OPQRSTUVWXYZ
WXYZ!?:;:-'
1234567890

abcdefghijklmnopqrstu vwxyz, &

1234567890, $\frac{1}{8}$ $\frac{1}{4}$ $\frac{3}{8}$ $\frac{1}{2}$ $\frac{5}{8}$ $\frac{3}{4}$ $\frac{7}{8}$ $\frac{15}{16}$

EXAMPLE 1

ABCDEFGHIJKLMNO
 PQRSTUVWXYZ&\$.-':!
 1234567890

ABCDEFGHIJKLMNO
 PQRSTUVWXYZ
 1234567890&\$

abcdefghijklmnopqrstu
 vwxyz 1234567890

EXAMPLE 2

ABCDEFGHIJKLMNO
 PQRSTUVWXYZ, &c
 1234567890.

ABCDEFGHIJKLMNO
 PQRSTUVWXYZ
 1234567890

abcdefghijklmnopqrstu
 vwxyz.
 1234567890.

EXAMPLE 3

Naming of Parts and Drawings. — It is very important that care be given to this matter as noted under filing, and general instructions issued covering this subject. Otherwise different names will creep into use for the same object and much confusion will result in getting prints out of the files, in discussion, and ordering of material.

Titles. — Name of the drawn parts should be the most prominent, company's name next, and data last. Whether the company's name or the subject-matter should be first is an open question; probably most engineers would say that to give the subject the most prominence would require it to be put at the top of the title frame, but this splits the information to be filled in, by insertion of the company's name at this place.

If the latter is kept in sufficiently small type, the name of the subject-matter can still be given prominence if it does come second, and this seems to make a better-looking title as a whole. When titles, borders, and material list headings are printed on the drafting sheets and the practice is made of cleaning tracings with benzine, the printing should be specified to be done with ink, which will not be affected by such cleaning.

It is important that care be given to the assignment of all drawing titles, as on them will depend the success of the alphabetical index. Titles, therefore, should be assigned by one person only.

For ready reference to any drawing by this system and a card index, the following rules should be observed:

First, Divide the title into three lines or parts, X, Y, Z, as follows:

X, Name of the part drawn. Name of part or machine to which it belongs.

Y, Name of section, subdivision, or group to which it belongs.

Z, Name of plant or location in which it belongs.

Second, Make the first word of each part of the title the true name of the object drawn, machine, section, or plant, as the case may be.

Third, Index by the name word of each section of the title. Never index by the adjective.

EXAMPLE: Assume a company operating three plants, known, we will say, as "Albany," "Buffalo," and "Rochester" plants. Each consists of X factories known as "A," "B," and "C," etc. Part to be indexed being "cylinder head of 6" x 8" blower engine" in "C" factory of "Buffalo" plant. Proceed to divide and assign the title in three parts, which, under the rules given, will read:

First line—CYLINDER HEAD—BLOWER ENGINE—6" X 8"

Second " —C FACTORY

Third " —BUFFALO PLANT

It will be noted that the first word of each part of the title is the true name of the part, section, or plant, as the case may be, and this fulfills the conditions for successful indexing by the alphabetical method.

The drawing number will then be found in the card index, under division "Buffalo Plant," subdivision, "C Factory," and cross-indexed in this subdivision under "C" for cylinder head, and "B" for blower engine. See index card forms.

To insure correct titles and proper indexing, the person assigning titles should write them on the reverse side of the original work-order forms, in the space provided for the purpose, and at the time the drawing numbers are

assigned. Draftsmen will then copy those titles on the drawings without change.

Tracing. — Tracings are to be made on the rough side of the cloth. Start at the top of the sheet and keep the work about $1\frac{1}{2}$ " from the left-hand edge, to allow for binding the prints in sets.

Trace center lines, curves, vertical, and horizontal lines in the order given. If cloth from the roll is used, trace border lines and titles last. A little ingenuity in doing the work will obviate the necessity of waiting for the ink to dry.

Keep pens properly ground; not sharp enough to cut, but thin enough to make the ink flow properly. Lines made with a single stroke save time.

Erasures are to be made with rubber only. Sand rubbers are not to be used.

The parts of the object that lie nearest the observer should be traced first and with the heaviest lines. This brings out the object and makes the drawing easier to read. The dotted lines, showing the invisible parts, will then be traced and confusion of these lines avoided.

When curves run into straight lines, the former are inked first, as it is then easy to make an exact meeting with the ruling pen. Outside of lettering, nothing betrays the novice so quickly as poorly executed tangent lines.

When the practice is made of keeping pencil drawings after they have been traced, the tracer should write his initials, date traced, and drawing number in the right-hand lower corner of such drawings.

Signatures. — Every finished drawing or tracing is to be signed with the initials of the draftsman, tracer, and checker who has worked on it.

Every drawing is to be signed "Approved" by the chief engineer, or whoever is sponsor for that drawing.

For estimating purposes on rush work only, preliminary prints may be issued before drawings are checked or approved. In that event all such prints should be stamped "PRELIMINARY," and one kept for record as noted under "RECORD PRINTS."

Calculations. — On design work calculations will be made in a book provided for that purpose on application to the file clerk.

Commence each note or calculation with date, name of drawing, and separate by a line notes relating to different drawings.

Make calculations and notes in a neat and legible manner and so marked as to be readily understood by others.

Catalogues. — Necessary catalogues can be applied for through the file clerk, who will obtain them as required and file and index them under manufacturers' names and names of articles. This file should be kept up to date with new issues of catalogues as they appear.

A receipt card should be signed when catalogues are taken from the files, and they are to be returned promptly to the files after serving their purpose.

Checking Prints. — All drawings shall be checked by checkers or squad foremen. For this purpose a check print shall be made when the drawing warrants it.

Correct matter shall be marked with yellow crayon and corrections with red crayon. After corrections have been made, the check prints are to be delivered to the file clerk for filing with the record prints.

Check prints are not to be taken from the drafting room, and receipt cards must be signed when they are taken from the files.

Compass Direction. — Maps and plant arrangement sheets of the same plant are to be made uniform as to compass direction. If not otherwise required, North will be toward the top of the sheet.

Show True North by a solid or full arrow head with an E. & W. line.

Show Magnetic North by a half arrow head on that side of the line toward the declination.

Field Drawings. — Field drawings should be made to these standards and should bear the date made and the approval of the resident engineer.

Title and number space should be left for filling in at the main office. Local title and number should appear over the regular title box, with name of plant and section or purpose for which the article is used.

Three prints or one original tracing of all field drawings that show any part of the plant or apparatus that has been built, or is to be built, should be noted accordingly and sent to the engineering division at the main office for filing.

It is important that field drawings be made to the sizes given, as the main office files are made and fitted for these sizes.

Field offices will see that their old prints are destroyed as soon as possible after receipt of revised prints. Useless work and expense will be avoided by careful attention to this matter.

Fit Dimensions. — In specifying fits on mechanical drawings, give limits expressed as plus or minus after the dimension figures.

EXAMPLE: $1.785 \pm .001$

For fit allowances, see machinists' handbooks.

Filing. — A file clerk should be in charge of the files and the recording of incoming and outgoing drawings, prints, and catalogues. He should see that titles and numbers are properly entered in his record book and on the index cards.

All drawings should be cross-indexed as to plant, division or section, and name of part shown.

The record book should show, in remarks column, the numbers of superseded and superseding drawings, also about cancellations of drawings with dates.

Drawings will be indexed and filed under the following classifications, indicated by the first or series number, followed by the size letter and serial number:

- 1-B-1278 would indicate drawings made at the main office.
- 2-B-etc. would indicate drawings made at branch offices, or in the field.
- 3-B-etc. would indicate miscellaneous foreign drawings of apparatus in use.
- 4-B-etc. would indicate miscellaneous foreign drawings of apparatus filed for reference only.

Series numbers to be continued as required. Serial numbers start with 1 for each series, as missing drawings are thus most easily detected.

The letter following the first number indicates the size of drawing, as follows:

- “A,” $8\frac{1}{2}'' \times 11''$, sketch or data size.
- “B,” $12'' \times 18''$.
- “C,” $18'' \times 24''$.
- “D,” $24'' \times 36''$.
- “E,” $30'' \times 41''$.

The number following the letter is the serial number and indicates the position of the drawing in the file.

File drawers will be marked with the series name and number, size letter, and range of serial numbers of the drawings they contain.

Tracings, record prints, sets of prints, and the classified prints will be kept in separate files.

Sets are to be kept up to date with the latest revised prints.

Drawings, tracings, and prints taken from the files are to be returned promptly after being used. Receipt cards should be signed for tracings taken from the files, and for drawings and prints according to their importance.

When the filing system is to be decided upon, consideration should be given to the rate of growth and ultimate number of drawings that will be filed. If a few thousand will be the limit, the alphabetical and numerical system described will be satisfactory if the rules for titling and indexing are observed. Should it be decided, however, to provide for many thousands or an unlimited number of drawings, tracings, and prints, then one of the decimal systems should be adopted.

In the former case all the drawings of one size would be numbered consecutively and filed numerically — a missing drawing being instantly detected; or, the number being had, it will readily be found in its numerical position. Also, new files will only have to be purchased when files already on hand are *completely* filled.

In the decimal system all the drawings of one class, or order, or contract are brought together under one preliminary number and subdivided by following numbers separated by dashes, or letters having special significance for subdivision. This system has the advantage of bring-

ing all the drawings of one group together, although possibly of varying sizes, and it has the disadvantage of difficulty of detecting missing drawings, and the greater amount of file and floor space required, as there will be more drawers in process of being filled than with the first system.

Transmitting Prints. — A letter of transmittal must accompany the first issue of all prints and all subsequent issues of revised prints.

To avoid confusion in filing, a separate letter should be written for each general subject.

In all letters of transmittal, state:

- 1, Number of prints transmitted;
- 2, Numbers of the prints;
- 3, Date of last revision;
- 4, Title;
- 5, Name of plant;
- 6, Instructions covering the disposition of, and purpose for which the prints are issued (if revisions, instructions should cover the destruction or return of obsolete prints);
- 7, Information relative to features of construction, ordering of material, etc.

Material Lists. — On mechanical work it is customary to put the short material lists, or parts lists, on the assembly drawings, and the long lists on a separate sheet with a drawing number.

On architectural work it is better to make the material lists on special letter-size sheets of thin paper, which may be typed with a reversed carbon sheet at the back. Very good blueprints to the number required may then be made from these typed sheets. Such material lists

will bear the same number as the authorization or order for the work, and will be filed under this number, in a vertical letter file reserved for material lists and specifications. The same order number appearing on the drawing will then serve to bring all parts of the work together. A form for such material lists is given.

Specifications. — It is recommended that specifications be typed on thin letter-size paper, with a reversed carbon sheet at the back, and blueprints made from these sheets as with material lists. Such specifications will also bear the authorization or order number of the work, and be filed with the material lists. The order number on the drawing will then bring all parts of the work together. A form for such specifications is given.

It is possible to get a lower price for blueprinting these small sheets by having several of them printed on a larger sheet and then cutting up such sheets in your own office.

Old Drawings and Prints. — Do not let old drawings and prints accumulate on the reference boards. Return them promptly to the files after using or to the squad foreman for destruction, as the case may require.

Parts Lists and Details. — Give names under the respective parts drawn, with kind of material, finish, and number required for one unit below it.

When a material list with part numbers is used, place the part number in a $\frac{5}{16}$ " diameter circle above the name of the part, and give the material and number required in the material list only. The descriptive matter under the part will then consist of part number, name, and finish, only.

When details cover more than one sheet, part numbers should run through the several sheets, allowing at least

ten blank numbers to a sheet before starting to number the parts on the next sheet.

Patterns. — Make the following notes on all drawings requiring pattern work:

Under each casting drawn, note that pattern is to be marked with the company's initials placed over the drawing and part number. The drawing and part number thus combined will constitute the pattern number.

EXAMPLE: Mark Pattern $\frac{\text{A. B. C. Co.}}{1-C-9990}$

On each drawing requiring pattern work make the following note:

“Use metal letters and figures on patterns to mark castings.”

“Mark the company's initials and pattern number on each piece of a pattern and core box.”

All orders placed for material including castings should have clearly stated on them whether or not the patterns are to become the property of the purchasing company. If so, the grade of pattern work should be covered, and a clause inserted specifying that the patterns and designs are to be for the exclusive use of the purchasers. Disposition of the completed patterns should be covered, also the matter of insurance or responsibility if they are to be left on storage.

Pattern Record Book. — A book for this purpose should be kept by the department having charge of making purchases or ordering material from the drawings, and this book should be kept up by having entered in it all purchases or transfers of patterns. This work is anticipated on the drawings by having a pattern number assigned to every casting called for.

A form is given for a pattern record book, the left-hand

page of which is for the pattern record and the right-hand page for the transfer record.

It is important that this book be kept up to date, for, if allowed to fall behind, it will be found very hard to bring it up and trace and locate old patterns.

Preliminary Prints. — When prints are sent out before being checked or approved, they should in all cases be marked "PRELIMINARY," and the usual charge should be made in the record book.

Tracings from which preliminary prints have been made should be returned to the squad foreman for completion. They must not be filed unless so directed by him.

Record Prints. — A record print shall be kept of the first printing from every tracing and from each subsequent revision. Every such print shall be stamped "RECORD PRINT," followed by date and number: 1, 2, or 3, etc., in the order of printing.

Record prints will be kept in a separate file, and are not to be taken from the drafting room. A receipt card should be signed when they are taken from the files for use in the drafting room.

References. — All tracings should bear, in space for that purpose, references to name and number of related drawings, such as details to assemblies, and assemblies to general arrangement drawings. Where there are no assembly drawings, reference should then be made from details to the general arrangement drawings. The arrangement drawings should bear the numbers of all their assembly or detail drawings.

Revisions. — Revisions to drawings will only be made with the approval of the chief engineer's office, and an order should be issued similar to that for new work. Each revision should be marked with a letter in the body of

the drawing, also noted in the space provided for the purpose near the title. This note should consist of the mark letter, date, and brief description of the revision, followed by draftsman's and checker's initials.

Old prints of revised drawings (except record and check prints) shall be destroyed by the file clerk. In order that he may do this, a copy of all orders for revisions should be given him.

All prints from revised tracings should be stamped above the title "REVISED PRINT."

Void Drawings. — Tracings will only be made void with the approval of the chief engineer's office, and an order should be issued as for new work and revisions. This order should state from what date the tracing is void, give the name or number of the superseding drawing or tracing, if any, and state to whom new prints should be sent. Tracings made void as above will be stamped with the "void" stamp, dated and initialed by the chief draftsman, and have the number of the superseding drawing noted on them.

A copy of all orders for making drawings or tracings void should be given to the file clerk, so that he may destroy the extra prints in the file.

Copyright.¹ — Drawings can be copyrighted by application to the Registrar of Copyright, Washington, D. C., for blanks, and putting the proper marks on drawings. These are a "C" in a circle, with initials and date, if full name appears elsewhere on the sheet; otherwise, the full name under the circle with the (C), and the date. A copy of the drawing, photo, or print so marked should then be sent, with the blank properly filled out and an enclosure of one dollar to the Registrar of Copyrights, Washington, D. C.

¹ See the following page for drawings qualified for copyright.

COPYRIGHT NOTICE

*Extract from the Act of March 4, 1909, respecting the
Copyright Notice*

“SEC. 18. That the notice of copyright required by section nine of this Act shall consist either of the word ‘Copyright’ or the abbreviation ‘Copr.,’ *accompanied by the name of the copyright proprietor*, and if the work be a printed literary, musical, or dramatic work, the notice shall include also the year in which the copyright was secured by publication. In the case, however, of copies of works specified in subsections (f) to (k), inclusive, of section five of this Act, the notice may consist of the letter c inclosed with a circle thus: © accompanied by the initials, monogram, mark, or symbol of the copyright proprietor: *Provided*, That on some accessible portion of such copies or of the margin back, permanent base, or pedestal, or of the substance on which such copies shall be mounted, his name shall appear. But in the case of works in which copyright is subsisting when this Act shall go into effect, the notice of copyright may be either in one of the forms prescribed herein or in one of those prescribed by the Act of June eighteenth, eighteen hundred and seventy-four.”

APPLICATION FORMS

Maps. — For a published map, ask for Application Form “F.”

Works of Art. — For a work of art (painting, drawing, or sculpture); or for model or design for a work of art, ask for Application Form “G.”

Drawing or Plastic Work. — For a published drawing or plastic work of a scientific or technical character, ask for Application Form “I 1.”

For an unpublished drawing or plastic work of a scientific or technical character, ask for Application Form "I 2."

Photographs. — For a photograph published for sale, ask for Application Form "J 1."

For a photograph of which copies are not reproduced for sale, ask for Application Form "J 2."

Fees. — The statutory fee for registration of any work, except a photograph, is one dollar, including a certificate of registration under seal. In the case of a *photograph*, if a certificate is not demanded the fee is fifty cents. In the case of several volumes of the same *book* deposited at the same time, only one registration at one fee is required.

Technical Journals. — Subscriptions should be made to the technical paper or papers best covering the work in hand.

These should be faithfully read, and such items or articles as apply should be preserved for future reference.

The following method can be recommended if the entire issue is not preserved: Bend up the staples in the back of book and remove the full pages that contain the matter of interest. These are to be punched and bound in a loose-leaf binder held together with brass fasteners. Shun the antiquated type that is sewed together, for new matter may be added every week or two. The weekly indexes should be bound in, with the articles in question checked on them. If the periodical publishes a semi-annual index, it should be included.

This practice will give one a valuable reference book for his chosen line of work and the pages so bound will not be as bulky or troublesome to keep as the complete files.

The few articles later wanted and which were not kept can be located as to issue by the index and consulted at a library.

After removing pages as described, the balance of the journal can be restored, the staples bent down again, and the paper put to any other use desired.

Diary and Notebook. — Notes and memoranda should be made in such a manner, with name, date, and description, that they mean something and are not merely “scraps of paper,” which, if picked up a day or two later, are Greek even to the man who made them.

If the information is worthy of preservation, it should be made on a loose-leaf sheet for insertion in an indexed book and it will be surprising how soon such a book will become valuable. A diary should go with this book and a distinction made between notes of temporary and permanent value; the former going into the diary with information relative to changes in work or position, date of trips and particulars, names of men met, etc. The same size for the diary as for the notebook should be adopted and this not too small. Also, the same kind of diary should be used from year to year. A few sheets from the notebook can be slipped in the diary to save carrying both books. These sheets, when filled out, can be filed in the alphabetical notebook when convenient. What has been said of the indexing for drawings will also apply to this matter.

PART II

STANDARDS AND SYMBOLS

| | |
|--------------------|-----------------------------|
| SAFETY STANDARDS | PATENT OFFICE SYMBOLS |
| ABBREVIATIONS | PIPE FITTING SYMBOLS |
| AËRONAUTICAL TERMS | RIVET SYMBOLS |
| CROSS SECTIONS | STRUCTURAL MATERIALS—BREAKS |
| DEFINITIONS | THREAD AND TAPPED HOLES |
| ELECTRICAL SYMBOLS | TOPOGRAPHIC SYMBOLS |
| LINES | |



SAFETY STANDARDS

Safety Standards. — Drawings and specifications for machinery or apparatus of any nature should cover the guarding of dangerous features such as gear, chain, or belt drives and around moving parts generally. Also, the guarding of high voltage electrical connections, etc.

Drawings and specifications for buildings should likewise cover the protection of all openings, elevated ways, stairs, ladders, or runways, with suitable railings, etc.

Most of the states have regulations covering these matters and copies of them can be obtained by application to the various Industrial Boards. Much valuable information on this subject can also be obtained from the publications of the Casualty Companies, notably the Fidelity and Casualty Company of New York and the Casualty Company of Maryland.

A lasting impression of the importance of this matter can best be obtained by a perusal of the workmen's compensation laws.

Text of these may be seen in Report of Bureau of Labor Statistics, U.S. Department of Labor, or for quick reference see *The World Almanac*.

ABBREVIATIONS

| | |
|---------------------------------|-----------------------------------|
| A.....Area | H. I.....Height of Instrument |
| A. C.....Alternating Current | H.....Harden |
| App.....Approximate | H. & G. . .Harden & Grind |
| Amp.....Ampere | H. G. & P. Harden, Grind & Polish |
| | Hem.....Hemlock |
| B.....Bore | Hor.....Horizontal |
| B. M.....Bench Mark | HP.....Horse Power |
| Br.....Brass | |
| Bz.....Bronze | I.....I-Beam |
| | I. D..... Inside Diameter |
| C.....Core | I. P.....Iron Pipe |
| C. C.....Center to Center | I. P. T....Iron Pipe Thread |
| C. I.....Cast Iron | |
| C. L.....Center Line | kg. Kilogramme |
| C. P.....Candle Power | km. Kilometer |
| C. S.....Cast Steel | K. W.....Kilowatt. Keyway |
| Csk.....Countersunk | K. S.....Keyseat |
| | |
| D.....Diameter | L.....Angle — Length |
| D. C.....Direct Current | L. H.....Left Hand |
| Dr.....Dressed | |
| | Max..... Maximum |
| E. H.....Extra Heavy | Min..... Minimum |
| E. M. F... Electro Motive Force | Mal..... Malleable |
| | M. I..... Malleable Iron |
| f..... Finish | Mang.... Manganese |
| F. & D. . . Faced & Drilled | M. S..... Machine Steel |
| F. to F... Face to Face | mm..... Millimeter |
| F. H..... Flat Head | M. & F... Male & Female |
| Fils. Hd... Fillister Head | |
| F. P. M... Feet per Minute | N. S.....Nickel Steel |
| F. S..... Forged Steel | |
| F. W..... Full Weight (Pipe) | O. D.....Outside Diameter |
| | O. H..... Open Hearth |
| G.....Grind | O. H. S... Open Hearth Steel |
| G. & P....Grind & Polish | |

| | |
|-----------------------------|-----------------------------|
| P.....Polish | S. S.....Set Screwed |
| Pl.....Plate | T. & G....Tongued & Grooved |
| P. C.....Point of Curvature | T. P. I....Threads per Inch |
| P. T.....Point of Tangency | |
| R.....Rough | V.....Volt |
| Req.....Required | Vert.....Vertical |
| R. H.....Right Hand | W. G.....Wire Gauge |
| R. & L....Right & Left | W. I.....Wrought Iron |
| Rev.....Revolutions | W. S.....Wrought Steel |
| RPM.....Rev. per Minute | |
| Sp.....Spruce | X. H.....Extra Heavy |
| S. 4 S....Surface 4 Sides | XXH.....Double Extra Heavy |
| Std.....Standard | Y. P.....Yellow Pine |

SPELLING AND ABBREVIATIONS OF UNITS

*Units of Weight and Measure from Circular No. 47, United States
Bureau of Standards*

“The spelling of the names of units adopted by the National Bureau of Standards is that given in the list below. The spelling of the metric units is in accordance with that given in the law of July 28, 1866, legalizing the metric system in the United States.

“Following the names of each unit in the list below is given the abbreviation which the Bureau has adopted. Attention is particularly called to the following principles:

“1. The period is omitted after the abbreviations of the metric units, while it is used after those of the customary system.

“2. The exponents ‘2’ and ‘3’ are used to signify area and volume, respectively, in the case of the metric units, instead of the longer prefixes, ‘sq.’ or ‘cu.’ In conformity with this principle the abbreviation for cubic centimeter is ‘cm³,’ instead of ‘c. c.’ or ‘c. cm.’ The

term 'cubic centimeter' as used in chemical work is, in fact, a misnomer, since the unit actually used is the 'milliliter,' which has a slightly larger volume.

"3. The use of the same abbreviation for both singular and plural is recommended. This practice is already established in expressing metric units and is in accordance with the spirit and chief purpose of abbreviations.

"4. It is also suggested that, unless all the text is printed in capital letters, only small letters be used for abbreviations except in the case of A. for acre, where the use of the capital letter is general."

The list of the most common units of weight and measure and their abbreviations follows:

| Unit | Abbreviation | Unit | Abbreviation | Unit | Abbreviation |
|------------------|------------------|----------------------|--------------|------------------------|------------------|
| acre | A. | dram, avoirdupois | dr. av. | ounce, avoirdupois | oz. av. |
| are | a | dram, fluid | fl. dr. | ounce, fluid | fl. oz. |
| avoirdupois | av. | fathom | fath. | ounce, troy | oz. t. |
| barrel | bb. | foot | ft. | peck | pk. |
| board foot | bd. ft. | firkin | fir. | pennyweight | dwt. |
| bushel | bu. | furlong | fur. | pint | pt. |
| carat, metric | c | gallon | gal. | pound | lb. |
| centare | ca | grain | gr. | pound, apothecaries' | lb. ap. |
| centigram | cg | gram | g | pound, avoirdupois | lb. av. |
| centiliter | cl | hectare | ha | pound, troy | lb. t. |
| centimeter | cm | hectogram | hg | quart | qt. |
| chain | ch. | hectoliter | hl | rod | rd. |
| cubic centimeter | cm ³ | hectometer | hm | scruple, apothecaries' | s. ap. or ʒ |
| cubic decimeter | dm ³ | hogthead | hhd. | square centimeter | cm ² |
| cubic dekameter | dkm ³ | hundredweight | cwt. | square chain | sq. ch. |
| cubic foot | cu. ft. | inch | in. | square decimeter | dm ² |
| cubic hectometer | hm ³ | kilogram | kg | square dekameter | dkm ² |
| cubic inch | cu. in. | kiloiter | kl | square foot | sq. ft. |
| cubic kilometer | km ³ | kilometer | km | square inch | sq. in. |
| cubic meter | m ³ | link | li. | square kilometer | km ² |
| cubic mile | cu. mi. | liquid | liq. | square meter | m ² |
| cubic millimeter | mm ³ | liter | l | square mile | sq. mi. |
| cubic yard | cu. yd. | metric ton | t | square millimeter | mm ² |
| decigram | dg | micron | μ | square rod | sq. rd. |
| deciliter | dl | mile | mi. | square yard | sq. yd. |
| decimeter | dm | milligram | mg | stere | s |
| decistere | ds | milliliter | ml | ton | tn. |
| dekagram | dkg | millimeter | mm | ton, metric | t |
| dekaliter | dkl | millimicron | m μ | troy | t. |
| dekameter | dkm | minim | min. | yard | yd. |
| dekastere | dks | ounce | oz. | | |
| dram | dr. | ounce, apothecaries' | oz. ap. or ʒ | | |

NOMENCLATURE FOR AËRONAUTICS

REPORT NO. 9

NATIONAL ADVISORY COMMITTEE FOR AËRONAUTICS

INTRODUCTION

For the information of those interested in aëronautics the following nomenclature has been prepared as a guide, with a view to eliminating the duplication of terms, the erroneous use of terms, and confusion of terms, and with a view to defining the principal terms which have come into use in the development of aëronautics. In the preparation of this nomenclature only those terms have been defined which are new and peculiar to this subject.

AËRONAUTICAL NOMENCLATURE

AËROFOIL: A thin wing-like structure, flat or curved, designed to obtain reaction upon its surfaces from the air through which it moves.

AËROPLANE: See Airplane.

AILERON: A movable auxiliary surface used for the control of rolling motion — i.e., rotation about the fore and aft axis.

AIRCRAFT: Any form of craft designed for the navigation of the air — airplanes, balloons, dirigibles, helicopters, kites, kite-balloons, ornithopters, gliders, etc.

AIRPLANE: A form of aircraft heavier than air which has wing surfaces for sustentation, with stabilizing surfaces, rudders for steering, and power plant for propulsion

through the air. The landing gear may be suited for either land or water use.

Pusher. — A type of airplane with the propeller or propellers in rear of the wings.

Tractor. — A type of airplane with the propeller or propellers in front of the wings.

AIR-SPEED METER: An instrument designed to measure the velocity of an aircraft with reference to the air through which it is moving.

ALTIMETER: An instrument mounted on an aircraft to indicate continuously its height above the surface of the earth.

ANEMOMETER: An instrument for measuring the velocity of the wind or air currents with reference to the earth or some fixed body.

ANGLE:

Of attack. — The angle between the direction of the relative wind and the chord of an aërofoil, or the fore and aft axis of a body.

Critical. — The angle of attack at which the lift is a maximum.

Gliding. — The angle the flight path makes with the horizontal when flying in still air under the influence of gravity alone.

ASPECT RATIO: The ratio of spread to chord of an aërofoil.

AXES OF AN AIRCRAFT: Three fixed lines of reference; usually centroidal and mutually rectangular.

The principal longitudinal axis in the plane of symmetry, usually parallel to the axis of the propeller, is called the fore and aft axis (or longitudinal axis); the axis perpendicular to this in the plane of symmetry is called the vertical axis; and the third axis, perpendicu-

lar to the other two, is called the athwartship axis (or transverse or lateral axis). In mathematical discussions the first of these axes is called the x -axis, the second the z -axis, and the third the y -axis.

BALLONET: A small balloon within the interior of a balloon or dirigible for the purpose of controlling the ascent or descent, and for maintaining pressure on the outer envelope to prevent deformation. The ballonnet is kept inflated with air at the required pressure, under the control of a blower and valves.

BALLOON: A form of aircraft comprising a gas bag and a car, whose sustentation depends on the buoyancy of the contained gas, which is lighter than air.

Captive. — A balloon restrained from free flight by means of a cable attaching it to the earth.

Kite. — An elongated form of captive balloon, fitted with tail appendages to keep it headed into the wind, and deriving increased lift due to its axis being inclined to the wind. .

BANK: To incline an airplane laterally — i.e., to rotate it about the fore and aft axis. Right bank is to incline the airplane with the right wing down.

BANKING RUDDER: See Aileron.

BAROGRAPH: An instrument used to record variations in barometric pressure. In aëronautics the charts on which the records are made are prepared to indicate altitudes directly instead of barometric pressure.

BIPLANE: A form of airplane in which the main supporting surface is divided into two parts, one above the other.

BODY OF AN AIRPLANE: A structure, usually inclosed, which contains in a stream-line housing the power plant, fuel, passengers, etc.

CABRÉ: A flying attitude in which the angle of attacks is greater than normal; tail down; down by the stern — tail low.

CAMBER: The convexity or rise of a curve of an aërofoil from its chord, usually expressed as the ratio of the maximum departure of the curve from the chord as a fraction thereof. "Top Camber" refers to the top surface of an aërofoil, and "Bottom Camber" to the bottom surface; "Mean Camber" is the mean of these two.

CAPACITY:

Lifting. — The maximum flying load of an aircraft.

Carrying. — Excess of the lifting capacity over the dead load of an aircraft, which latter includes structure, power plant, and essential accessories.

CARRYING CAPACITY: See Capacity.

CENTER: The point in which a set of effects is assumed to be accumulated, producing the same effect as if all were concentrated at this point.

Of buoyancy. — The center of gravity of the fluid displaced by the floating body.

Of pressure of an aërofoil. — The point on the chord of an element of an aërofoil, prolonged if necessary, through which at any instant the line of action of the resultant air force passes.

Of pressure of a body. — The point on the axis of a body, prolonged if necessary, through which at any instant the line of action of the resultant air force passes.

CHORD:

Of an aërofoil section. — A right line tangent to the under curve of the aërofoil section at the front and rear.

Length. — The length of the chord is the length of the aërofoil section projected on the chord, extended if necessary.

CONTROLS: A general term applying to the means provided for operating the devices used to control speed, direction of flight, and attitude of an aircraft.

CRITICAL ANGLE: See Angle, Critical.

DÉCALAGE: An increase in the angular setting of the chord of an upper wing of a biplane with reference to the chord of the lower wing.

DEVELOPED AREA OF A PROPELLER: A layout of the area of a propeller blade designed to represent the total area of the driving face, in which the elements of area are developed as if unfolded onto the plane of the drawing (necessarily an approximation on definite assumptions, as no true development of the helix can be made).

DIRIGIBLE: A form of balloon the outer envelope of which is of elongated form, provided with a propelling system, car, rudders, and stabilizing surfaces.

Nonrigid. — A dirigible whose form is maintained by the pressure of the contained gas assisted by the car-suspension system.

Rigid. — A dirigible whose form is maintained by a rigid structure contained within the envelope.

Semirigid. — A dirigible whose form is maintained by means of its attachment to an exterior girder construction containing the car.

DISK AREA OF A PROPELLER: The total area of the disk swept by the propeller tips.

DIVING RUDDER: See Elevator.

DOPE: A general term applied to the material used in treating the cloth surface of airplane members to increase strength, produce tautness, and act as a

filler to maintain airtightness; usually of the cellulose type.

DRAG: The total resistance to motion through the air of an aircraft — i.e., the sum of the drift and head resistance.

DRIFT: The component of the resultant wind pressure on an aërofoil or wing surface parallel to the air stream attacking the surface.

ELEVATOR: A hinged surface for controlling the longitudinal attitude of an aircraft — i.e., its rotation about the athwartship axis.

ENGINE RIGHT OR LEFT HAND: The distinction between a right-hand and a left-hand engine depends on the rotation of the output shaft, whether this shaft rotates in the same direction as the crank or not. A right-hand engine is one in which, when viewed from the output shaft end, the shaft is seen to rotate anticlockwise.

ENTERING EDGE: The foremost part of an aërofoil.

FINS: Small planes on aircraft to promote stability; for example, vertical tail fins, horizontal tail fins, skid fins, etc.

FLIGHT PATH: The path of the center of gravity of an aircraft with reference to the air.

FLOAT: That portion of the landing gear of an aircraft which provides buoyancy when it is resting on the surface of the water.

FUSELAGE: See Body.

GAP: The distance between the projections on the vertical axis of the entering edges of an upper and lower wing of a biplane.

GLIDE: To fly without power.

GLIDER: A form of aircraft similar to an airplane, but without any power plant.

When utilized in variable winds it makes use of the soaring principles of flight and is sometimes called a soaring machine.

GLIDING ANGLE: See Angle, gliding.

GUY: A rope, chain, wire, or rod attached to an object to guide or steady it, such as guys to wing, tail, or landing gear.

HEAD RESISTANCE: The total resistance to motion through the air of all parts of an aircraft not a part of the main lifting surface. Sometimes termed "parasite resistance."

HELICOPTER: A form of aircraft whose support in the air is derived from the vertical thrust of large propellers.

INCLINOMETER: An instrument for measuring the angle made by any axis of an aircraft with the horizontal.

KEEL PLANE AREA: The total effective area of an aircraft which acts to prevent skidding or side slipping.

KITE: A form of aircraft without other propelling means than the towline pull, whose support is derived from the force of the wind moving past its surface.

KITE BALLOON: See Balloon, kite.

LANDING GEAR: The under structure of an aircraft designed to carry the load when resting on, or running on, the surface of the land or water.

LATERAL STABILITY: See Stability, lateral.

LEADING EDGE: See Entering edge.

LEEWAY: The angular deviation from a course over the earth, due to cross currents of wind.

LIFT: The component of the force due to the air pressure of an aërofoil, resolved perpendicular to the flight path in a vertical plane.

LIFT BRACING: See Stay.

LIFTING CAPACITY: See Capacity, lifting.

LOAD, FULL: See Capacity, lifting.

Reserve (or useful). — See Capacity, carrying.

LOADING: See Wing, loading.

LONGITUDINAL: A fore-and-aft member of the framing of an airplane body, or of the floats, usually continuous across a number of points of support.

LONGITUDINAL STABILITY: See Stability.

METACENTER: The point of intersection of a vertical line through the center of gravity of the fluid displaced by a floating body when it is tipped through a small angle from its position of equilibrium and the inclined line which was vertical through the center of gravity of the body when in equilibrium. There is, in general, a different metacenter for each type of displacement of the floating body.

MONOPLANE: A form of airplane whose main supporting surface is disposed as a single wing on each side of the body.

MOTOR: See Engine.

NACELLE: See Body.

NATURAL STABILITY: See Stability.

NOSE DIVE: A dangerously steep descent, head-on.

ORNITHOPTER: A form of aircraft deriving its support and propelling force from flapping wings.

PITOT TUBE: A tube with an end open square to the fluid stream, used as a detector of an impact pressure. More usually associated with a concentric tube surrounding it, having perforations normal to the axis for indicating static pressure. The velocity of the fluid can be determined from the difference between the impact pressure and the static pressure. This instrument is often used to determine the velocity of an aircraft through the air.

PROPELLER:

Developed area of. — See Developed area of a propeller.

Disk area of. — See Disk area of a propeller.

Right-hand. — One in which the helix is right-handed.

PUSHER: See Airplane.

PYLON: A marker of a course.

RACE OF A PROPELLER: The air stream delivered by the propeller.

RIB: See Wing.

RIGHT (OR LEFT) HAND:

Engine. — See Engine.

Propeller. — See Propeller, right-hand.

RIGID DIRIGIBLE: See Dirigible, rigid.

RUDDER: A hinged or pivoted surface, usually more or less flat or stream-lined, used for the purpose of controlling the attitude of an aircraft about its vertical axis when in motion.

SIDE SLIPPING: Sliding toward the center of a turn. It is due to excessive amount of bank for the turn being made, and is the opposite of skidding.

SKIDDING: Sliding sideways in flight away from the center of the turn. It is usually caused by insufficient banking in a turn, and is the opposite of side slipping.

SKIDS: Long wooden or metal runners designed to prevent nosing of a land machine when landing or to prevent dropping into holes or ditches in rough ground. Generally designed to function should the wheels collapse or fail to act.

SLIP: This term applies to propeller action and is the difference between the actual velocity of advance of an aircraft and the speed calculated from the known pitch of the propeller and its number of revolutions.

SOARING MACHINE: See Glider.

SPREAD: The maximum distance laterally from tip to tip of an airplane wing.

STABILITY: The quality of an aircraft in flight which causes it to return to a condition of equilibrium when meeting a disturbance. (This is sometimes called "Dynamical stability.")

Directional. — Stability with reference to the vertical axis.

Inherent. — Stability of an aircraft due to the disposition and arrangement of its fixed parts.

Lateral. — Stability with reference to the longitudinal (or fore and aft) axis.

Longitudinal. — Stability with reference to the lateral (or athwartship) axis.

STABILIZER: See Fins.

Mechanical. — Any automatic device designed to secure stability in flight.

STAGGER: The amount of advance of the entering edge of the upper wing of a biplane over that of the lower; it is considered positive when the upper surface is forward.

STALLING: A term describing the condition of an airplane which from any cause has lost the relative speed necessary for steering-way and control.

STATOSCOPE: An instrument to detect the existence of a small rate of ascent or descent, principally used in ballooning.

STAY: A wire, rope, or the like, used as a tie piece to hold parts together, or to contribute stiffness; for example, the stays of the wing and body trussing.

STEP: A break in the form of the bottom of a float.

STREAM-LINE FLOW: A term in hydromechanics to describe the condition of continuous flow of a fluid, as

distinguished from eddying flow where discontinuity takes place.

STREAM-LINE SHAPE: A shape intended to avoid eddying or discontinuity and to preserve stream-line flow, thus keeping resistance to progress at a minimum.

STRUT: A compression member of a truss frame; for instance, the vertical members of the wing truss of a biplane.

SWEEP BACK: The horizontal angle between the lateral (athwartship) axis of an airplane and the entering edge of the main planes.

TAIL: The rear portion of an aircraft, to which are usually attached rudders, elevators, and fins.

TAIL FINNS: The vertical and horizontal surfaces attached to the tail, used for stabilizing.

THRUST DEDUCTION: Due to the influence of the propellers, there is a reduction of pressure under the stern of the vessel which appreciably reduces the total propulsive effect of the propeller. This reduction is termed "Thrust deduction."

TRACTOR: See Airplane.

TRAILING EDGE: The rearmost portion of an aërofoil.

TRIPLANE: A form of airplane whose main supporting surfaces are divided into three parts, superposed.

TRUSS: The framing by which the wing loads are transmitted to the body; comprises struts, stays, and spars.

VELOMETER: See Air-speed meter and anemometer.

VOL-PIQUÉ: See Nose dive.

VOL-PLANE: See Glide.

WAKE GAIN: Due to the influence of skin friction, eddying, etc., a vessel in moving forward produces a certain forward movement of the fluid surrounding it. The

effect of this is to reduce the effective resistance of the hull, and this effect, due to the forward movement of the wake, is termed the "wake gain."

In addition to this effect the forward movement of this body of fluid reduces the actual advance of the propeller through the surrounding medium, thereby reducing the propeller horsepower.

WARP: To change the form of the wing by twisting it, usually by changing the inclination of the rear spar relative to the front spar.

WINGS: The main supporting surfaces of an airplane.

WING LOADING: The weight carried per unit area of supporting surface.

WING RIB: A fore and aft member of the wing structure used to support the covering and to give the wing section its form.

WING SPAR: An athwartship member of the wing structure resisting tension and compression.

YAW: To swing off the course about the vertical axis, owing to gusts or lack of directional stability.

Angle of. — The temporary angular deviation of the fore and aft axis from the course.

In connection with the nomenclature of the Advisory Committee, the following cuts of airplanes with their part names should prove useful and are reproduced by permission of the *American Machinist* and the *Aircraft Mechanics Handbook*.

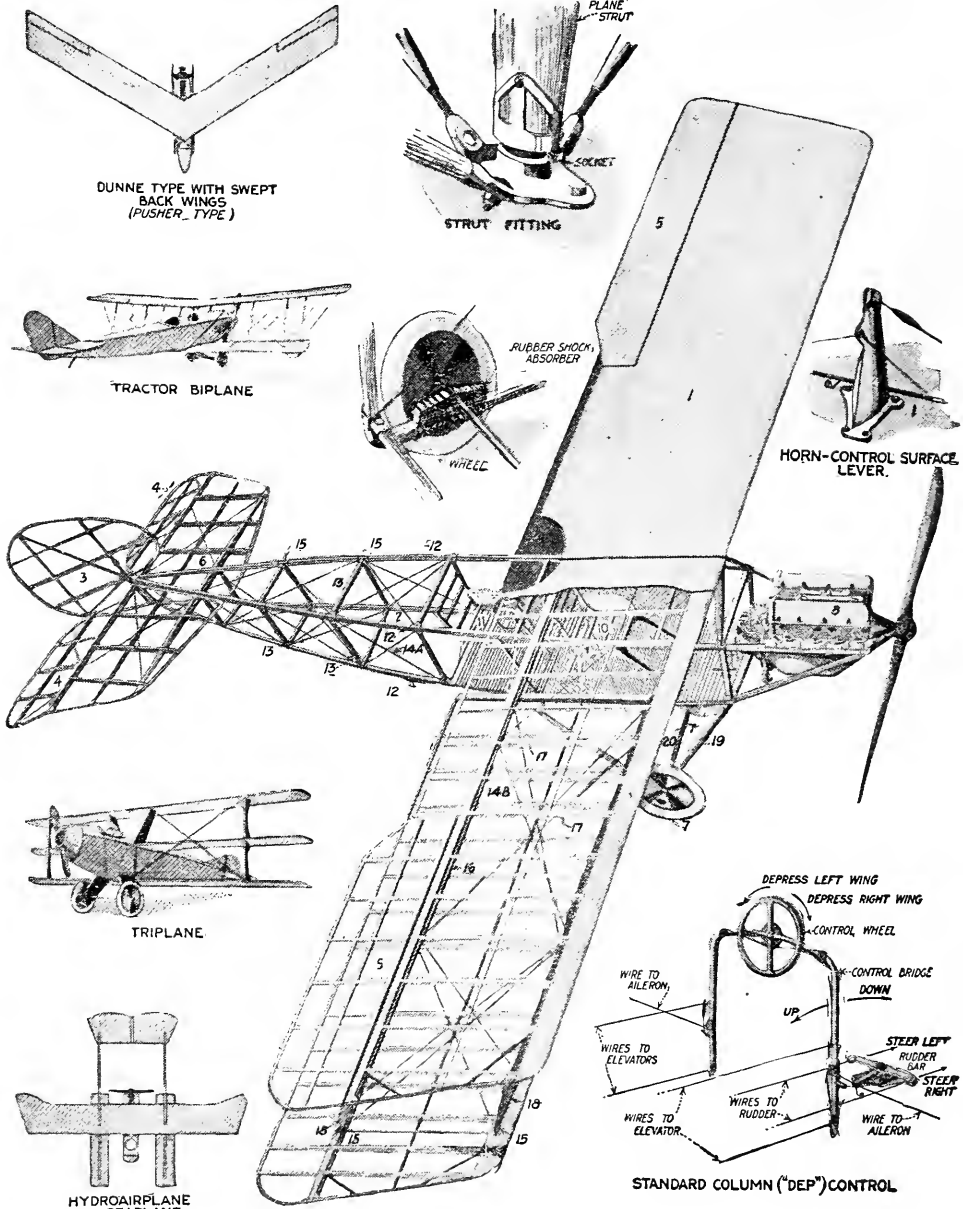

- No. 1-Upper plane
- “ 1A-Lower plane
- “ 2-Fuselage or body
- “ 3-Rudder
- “ 4-Elevator
- “ 5-Aileron
- “ 6-Horizontal stabilizer
- “ 7-Wheel











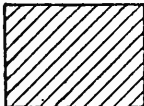
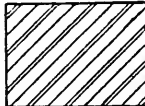
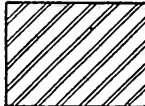
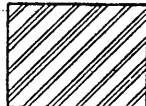
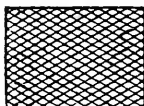
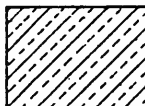
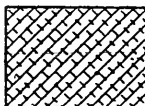

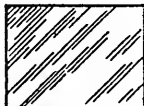

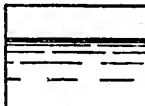
- No. 8-Engine
- “ 9-Propeller
- “ 10-Observer's or passenger's seat
- “ 11-Pilot's seat
- “ 12-Longeron
- “ 13-Fuselage strut
- “ 14A-Fuselage truss wire

- No. 14B-Internal draft wire
- “ 15-Socket
- “ 16-Plane or wing spars
- “ 17-Ribs
- “ 18-Wing strut, (front and rear)
- “ 19-Landing gear strut
- “ 20-Axle



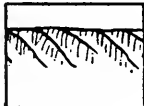

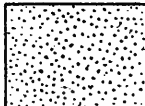

TYPICAL AIRPLANES AND DETAILS OF CONSTRUCTION

CONVENTIONAL SYMBOLS—CROSS-SECTIONS

Reported by the Committee on Standard Cross-sections and Symbols, December, 1914. The American Society of Mechanical Engineers.

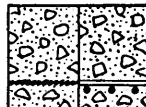
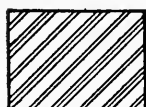
| | | | |
|---|---|---|---|
|  |  |  |  |
| Cast Iron | Wrought Iron | Cast Steel | Wrought Steel |
|  |  |  |  |
| Babbitt or White Metal | Copper, Brass or Composition | Aluminum | Rubber, Vulcanite or Insulation |
|  |  |  |  |
| Glass | Wood | Water | Puddle |
|  |  |  |  |
| Concrete | Brick | Coursed Uncoursed Rubble | Ashlar |
|  |  |  |  |
| Rock | Original Filling Earth | Sand | Other Materials |

RECOMMENDED STANDARD CROSS-SECTIONS

| | | | |
|---|---|---|---|
|  |  |  |  |
| Concrete | Concrete Blocks | Cyclopean Concrete | Expanded Wire or Metal Rods Reinforced Concrete |
|  |  |  |  |
| Wrought Steel | Nickel Steel | Chrome Steel | Vanadium Steel |

TYPICAL SUBDIVISIONS

DRAFTING ROOM METHODS

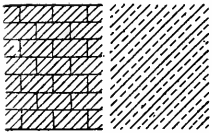

BRICK MASONRY
FIRE BRICK TILE TERRACOTTA

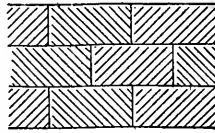

ASHLAR

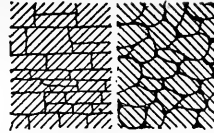

RUBBLE (COURSED) (UNCOURSED)



CONCRETE



CINDER CONCRETE

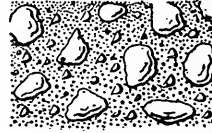

CYCLOPEAN CONCRETE



REINFORCED CONCRETE



GRAVEL CONCRETE



CINDER



ASPHALT



SAND



CEMENT OR PLASTER



BROKEN STONE



GRAVEL



ASBESTOS, MAGNESIUM



WOOD

CORK

SYMBOLS FOR BUILDING MATERIALS

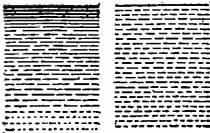

WATER

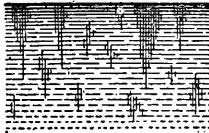

ICE

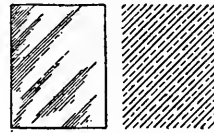

GLASS



LEATHER



RUBBER

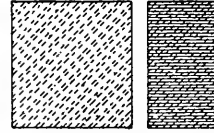

PORCELAIN MICA



FIBER

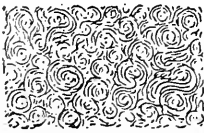

EXCELSIOR

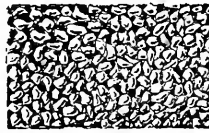

COKE

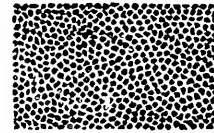

LOOSE COAL



UNDEFINED MISCELLANEOUS SYMBOLS

Geological Symbols. — From Report of Committee on Cross-sections A. S. M. E., and following those used by the U. S. Geological Survey.

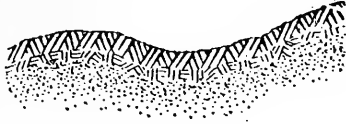

EARTH

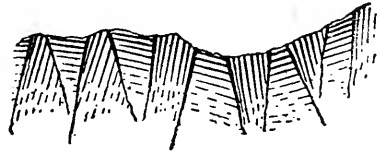

ROCK

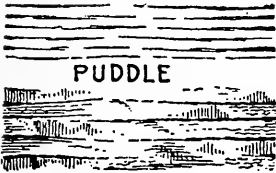

PUDDLE



QUICKSAND

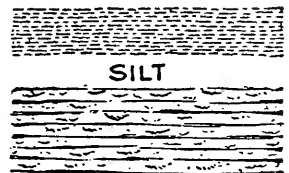

SILT

STRATIFIED
ROCK

CLAY, MARL

LOAM



SANDSTONE

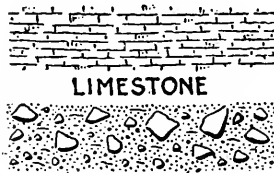

LIMESTONE

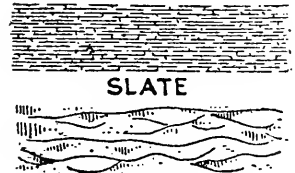

SLATE



GRANITE



CONGLOMERATE



SHALE

SYMBOLS FOR GEOLOGIC FORMATIONS

DEFINITIONS

Definitions of directions for shop operations frequently given on drawings:

Anneal. — To refine the structure of metals by heating and cooling slowly, which makes them more ductile, increases the tensile strength, and in castings, also removes strains.

Babbitt. — To pour a mixture of tin, antimony, copper and lead into a bearing as for a bushing.

Bevel. — To slope or remove sharp edges.

Bore. — To cut a hole with a tool as distinguished from a rough hole in a casting formed by a core.

Braze. — To unite metals with spelter or hard solder consisting of zinc and copper.

Bush. — To fit a lining or ring of metal in a hole to take the wear of a moving part.

Broach. — To form a hole with a serrated tool of that name and which operates with an endwise movement, as distinguished from the rotary movement of a drill.

Caulk, or Calk. — To fill joints or seams to prevent leakage.

Camber. — To curve the surface of a timber, as the deck beams or carlins of a boat, to assist in running off water.

Case Harden. — To harden the outer surface of iron or steel.

Chamfer. — To remove sharp edges with a flat cut, usually applied to timber. To bevel.

Chill. — To harden the outer surface of castings by quick cooling.

Chip. — To remove lumps or rough spots with a cold chisel and hammer.

Counterbore. — To bore the outer part of a hole to a larger diameter than the inner.

Countersink. — To bevel the outer edge of a hole, as for a rivet or bolt head of countersunk form.

Core. — To form a hole or recess in a casting, with a portion of the pattern of that name.

Dovetail. — To make a joint of that shape, usually in wood.

Dowel. — To fasten with pins of that name.

Drive. — See Fit.

Face. — To finish a flat surface, as in a lathe or planer.

Fillet. — To fill sharp corners to a radius, as on patterns and castings.

FITS. — The following definitions for the different fits are arranged in the order of their tightness. For uniform results it is better to designate the fit by the sizes of the parts, expressed to a three or four place decimal with limits, full directions for which can be found in the handbooks.

Running fit. — To fit parts so that they may move and run freely; as a shaft in bearings or a loose pulley.

Push fit. — To fit parts so they may be pushed together by hand.

Wring fit. — To fit parts so they may be turned or wrung to place.

Drive fit. — To fit parts so that blows, with a hammer or sledge, are required to get them to place.

Force fit. — To fit parts, as a shaft in a gear, so that force is required to insert it.

Press fit. — Same as force fit, but to be done in a press. Pressure in tons usually being specified.

Shrink fit. — To fit parts, as a coupling on a shaft, by having the hole a little smaller than the shaft, heating the coupling until the shaft enters, when the contraction of the metal on cooling makes the shrink fit.

FORGE. — To work metals by heating and hammering.

Drop forge. — To work metals by heating and forming with dies by a blow in a forge of that name.

Press forge. — To work metals by heating and forming with dies, in a forge which operates with a slow and steady pressure.

FINISH. — To turn bore or face.

Chip. — To remove lumps or rough spots with a cold chisel and hammer.

File. — To finish (as a casting) with a file.

Draw file. — To finish with a file held in both hands across the work and moved sideways, as in hand-fitting a key.

Grind. — To finish smoothly and accurately with an abrasive.

Lap. — To polish with a soft piece of metal of that name, either flat, or round for holes, and which retains the abrasive.

Polish. — To finish to a smooth bright surface with a fine abrasive.

Rough. — When no finish is desired, as parts of a casting.

Scrape. — To finish with a scraper as in fitting bab-bited bearings.

Dressed (or planed). — Sand papered; rough; finishes for timber and wood work.

Grout. — To fill with thin mortar or cement.

Ground joint. — To finish a joint in metals by grinding the parts together with an abrasive and oil.

Harden. — To heat steel and quench suddenly, usually used as, "harden and temper."

Heat treat.— To heat and quench steel to exact temperature and time rules, to improve the structure and strength; applied to steel of specified composition.

Key Seat. — To form a recess, as in a shaft pulley or gear for a key which may be straight or tapered.

Lap. — To polish with a soft piece of metal of that name, which may be either flat, or round for holes, and which retains the abrasive.

Mill. — To remove metal by the action of a toothed wheel or bar in a milling machine.

Miter. — To join at an angle, usually 45° as a miter joint.

Mortise. — To form a recess (in timber) to receive a tongue called a tenon.

Nurl. — To corrugate or make fine teeth, as on the edge of a thumb screw or any part to be turned by hand.

Peen. — To go over a surface to expand it, with the round nose of a hammer, called a ball peen hammer.

Polish. — To finish to a smooth bright surface with a fine abrasive.

Rabbet. — To recess or groove along the edge of a timber or plank, usually to relieve the ends of other timbers or plank and make a flush joint.

Ream. — To finish a hole smoothly and accurately with a tool of that name.

Rivet. — To fasten two or more parts together with pins, called rivets.

Shrink. — See Fit.

Scarf. — To form a long joint usually in timber, and as distinguished from a butt joint.

Spot face. — To finish a round surface at the spot

designated, usually on a casting around a bolt hole for a nut seat.

Solder. — To unite two metals with soft solder consisting of tin and lead.

Sweat (joint). — To unite metals by first “tinning” them with solder, then holding the parts together and applying just enough heat to start or sweat the solder.

Stay bolt. — To fasten with bolts of that name, as parallel plates in a boiler.

Tap. — To cut a thread in a hole with a tool of that name.

Temper. — To reheat hardened steel to a predetermined temperature or “color,” according to the intended use, and then quench.

Tenon. — To form a tongue of wood to fit in a recess, called a mortise.

Thread. — To form a screw thread either with a die or in a lathe.

Treenail. — To fasten with a wooden pin (Locust) the inside end of which is split and fitted with a wedge which on striking the bottom of the hole expands the pin and secures it.

Turn. — To finish in a machine which revolves the work as in a lathe, also used as “Turn Bore and Face.”



























Upset. — To rivet over or spread, as the end of a bolt over a nut.

Weld; Lap weld; Butt weld. — To join the edges of two pieces of metal by fusing, according to the manner in which the edges meet, whether “lapped” or “butted.”

CONVENTIONAL SYMBOLS — ELECTRICAL







STANDARD SYMBOLS ADOPTED BY THE NATIONAL ELECTRICAL CONTRACTORS' ASSOCIATION AND THE AMERICAN INSTITUTE OF ARCHITECTS

Copyrighted















-  Ceiling Outlet; Electric only. Numeral in center indicates number of Standard 16 C.P. Incandescent Lamps.
-  Ceiling Outlet; Combination. $\frac{1}{2}$ indicates 4-16 C. P. Standard Incandescent Lamps and 2 Gas Burners.  If gas only.
-  Bracket Outlet; Electric only. Numeral in center indicates number of Standard 16 C.P. Incandescent Lamps
-  Bracket Outlet; Combination. $\frac{1}{2}$ indicates 4-16 C.P. Standard Incandescent Lamps and 2 Gas Burners.  If gas only.
-  Wall or Baseboard Receptacle Outlet. Numeral in center indicates number of Standard 16 C.P. Incandescent Lamps.
-  Floor Outlet. Numeral in center indicates number of Standard 16 C. P. Incandescent Lamps.
-  Outlet for Outdoor Standard or Pedestal; Electric only. Numeral indicates number of Standard 16 C.P. Incandescent Lamps.
-  Outlet for Outdoor Standard or Pedestal; Combination. $\frac{2}{3}$ indicates 6-16 C.P. Standard Incandescent Lamps; 6 Gas Burners.
-  Drop Cord Outlet.
-  One Light Outlet, for Lamp Receptacle.
-  Arc Lamp Outlet.
-  Special Outlet, for Lighting, Heating and Power Current, as described in Specifications.
-  Ceiling Fan Outlet.
-  S. P. Switch Outlet.
-  D. P. Switch Outlet.
-  3-Way Switch Outlet.
-  4-Way Switch Outlet.
-  Automatic Door Switch Outlet.
-  Electrolier Switch Outlet.
-  Meter Outlet.
-  Distribution Panel.
-  Junction or Pull Box.
-  Motor Outlet; Numeral in center indicates Horse Power.
-  Motor Control Outlet.
-  Transformer





Show as many Symbols as there are Switches. Or in case of a very large group of Switches, indicate number of Switches by a Roman numeral, thus S' XII; meaning 12 Single Pole Switches.

Describe Type of Switch in Specifications, that is, Flush or Surface, Push Button or Snap.

-  Main or Feeder run concealed under floor.
-  Main or Feeder run concealed under Floor above.
-  Main or Feeder run exposed.
-  Branch Circuit run concealed under Floor.
-  Branch Circuit run concealed under Floor above.
-  Branch Circuit run exposed.
-  Pole Line.

| Heights of Center of Wall Outlets (unless otherwise specified): | |
|---|--------------|
| Living Rooms | 5 ft. 6 ins. |
| Chambers | 5 ft. 0 ins. |
| Offices | 6 ft. 0 ins. |
| Corridors | 6 ft. 3 ins. |
| Height of Switches (unless otherwise specified) | 4 ft. 0 ins. |

-  Telephone Outlet; Private Service.
-  Telephone Outlet; Public Service.
-  Bell Outlet.
-  Buzzer Outlet.
-  Push Button Outlet; Numeral indicates number of Pushes.
-  Annunciator; Numeral indicates number of Points.
-  Speaking Tube.
-  Watchman Clock Outlet.
-  Watchman Station Outlet.
-  Master Time Clock Outlet.
-  Secondary Time Clock Outlet.
-  Door Opener.
-  Special Outlet; for Signal Systems, as described in Specifications.
-  Battery Outlet.

-  { Circuit for Clock, Telephone, Bell or other Service, run under Floor, concealed.
-  { Kind of Service wanted ascertained by Symbol to which line connects.
-  { Circuit for Clock, Telephone, Bell or other Service, run under Floor above, concealed.
-  { Kind of Service wanted ascertained by Symbol to which line connects.

Suggestions in connection with Standard Symbols for Wiring Plans:

It is important that ample space be allowed for the installation of mains, feeders, branches and distribution panels.

It is desirable that a key to the symbols used accompany all plans.





If mains, feeders, branches and distribution panels are shown on the plans, it is desirable that they be designated by letters or numbers.

CONVENTIONAL SYMBOLS





Lines — It is considered that the three most important lines of a drawing are construction lines, center lines, and dimension lines. For this reason a difference is made in their construction rather than in their weight or width. This seems a logical distinction to make and one calculated to avoid confusion.

The lines of a drawing may be broadly divided into two general classes, namely, "Lines of Construction" and "Lines of Explanation," as noted in the following groups:

Lines of Construction

| | |
|---------------------------|--|
| General Construction Line |  |
| Heavy Construction Line |  |
| Invisible Part |  |
| Adjacent Part |  |

Lines of Explanation

| | |
|-------------------------------------|--|
| Center Lines and Pitch Lines |  |
| Extension Lines for Dimensions |  |
| Dimension Lines |  |
| Lines Showing Paths of Moving Parts |  |
| " " Section Cuts |  |

Cross-section Lines to Indicate Material. *See Cross-sections*

PATENT OFFICE PRACTICE

The following Patent Office Symbols and rules to be observed in making drawings, on which patent applications are to be filed, have been reproduced from "Rules of Practice in the United States Patent Office" — copy of which should be consulted for full directions relating to applications for patents, and to drawings.

"THE DRAWINGS

"49. The applicant for a patent is required by law to furnish a drawing of his invention whenever the nature of the case admits of it.

"50. The drawing may be signed by the inventor or one of the persons indicated in Rule 25, or the name of the applicant may be signed on the drawing by his attorney in fact. The drawing must show every feature of the invention covered by the claims, and the figures should be consecutively numbered, if possible. When the invention consists of an improvement on an old machine the drawing must exhibit, in one or more views, the invention itself, disconnected from the old structure, and also in another view, so much only of the old structure as will suffice to show the connection of the invention therewith.

"51. Two editions of patent drawings are printed and published — one for office use, certified copies, etc., of the size and character of those attached to patents, the work being about 6 by 9½ inches; and one reduction

CHART FOR DRAFTSMEN. SECTIONS

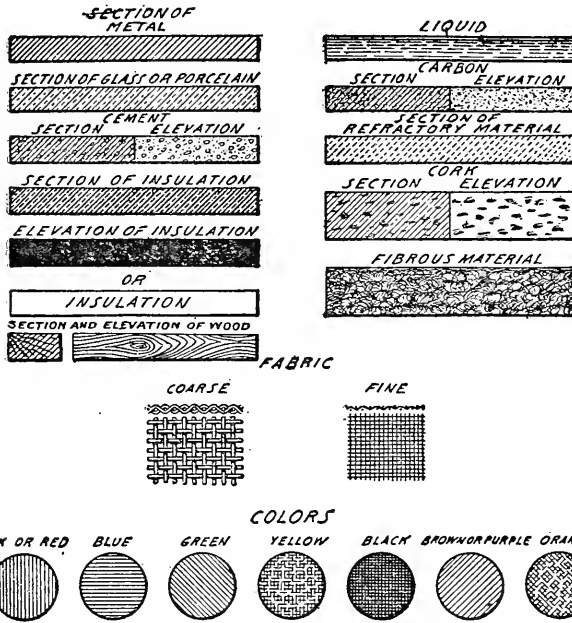

ABCDEFGHIJKLMN OPQRSTUVWXYZ
 abcdefghijklmnopqrstuvwxyz
 1234567890

ELECTRICAL SYMBOLS.

| | | | | | |
|---|--|---|----------------------------------|------------------------------------|-------------------------------------|
| 1. CROSSING AND JOINED WIRES OPEN | 2. CROSSING AND JOINED WIRES CLOSE | 3. MAIN CIRCUITS SHUNT OR CONTROL CIRCUITS | 4. REVERSING SWITCH | 5. SWITCH | 6. KNIFE SWITCH |
| 7. DOUBLE POLE SWITCH | 8. POLE CHANGER | 9. RESISTANCE | 10. NON INDUCTIVE RESISTANCE | 11. IMPEDANCE | 12. RHEOSTAT |
| 13. INDUCTIVE RESISTANCE | 14. INDUCTIVE RESISTANCE (ADJUSTABLE CORE) | 15. INDUCTIVE RESISTANCE (ADJUSTABLE COIL) | 16. CONDENSER | 17. CONDENSER (ADJUSTABLE) | 18. COMPRESSIBLE FILE REGULATOR |
| 19. CIRCUIT BREAKER (INDEPENDENTLY TRIPPED) | 20. FUSE | 21. LIGHTNING ARRESTER | 22. GROUND | 23. CIRCUIT BREAKER (OVERLOAD) | 24. CIRCUIT BREAKER (UNDERLOAD) |

ELECTRICAL SYMBOLS.

| | | | | | |
|--|--|--|--|---|--|
| 25. RELAY | 26. DIFFERENTIAL RELAY | 27. POLARIZED RELAY | 28. A.C. RELAY | 29. RETARDED RELAY | 30. RETARDED RELAY |
| 31. SHUNT | 32. GALVANOMETER | 33. VOLTMETER | 34. AMMETER | 35. WATTMETER | 36. NOT WIRE MEASURING INSTRUMENT |
| 37. INTEGRATING METER | 38. WATT HOUR METER-2 WIRE | 39. WATT HOUR METER-3 WIRE | 40. INCANDESCENT LAMP | 41. INCANDESCENT LAMPS LIGHTED OUT | 42. ELECTRIC ARC |
| 43. ARC LAMPS LIGHTED OUT | 44. TELEPHONE SUBSTATION | 45. AUDION | 46. BELL | 47. POLARIZED BELL | 48. BUZZER |
| 49. ANNUNCIATORS | 50. DROP ANNUNCIATOR | 51. TRANSMITTERS | 52. RECEIVERS | 53. TELEPHONE HOOK | 54. SWITCH BOARD PLUG AND JACK |
| 55. LISTENING RINGING KEY | 56. TELEGRAPH KEY | 57. D.C. RELAY OR SOUNDER | 58. CONERER | 59. WAVE DETECTOR | 60. ELECTROLYTIC DETECTOR |
| 61. QUENCHED SPARK-GAP | 62. BATTERY | 63. THERMO-ELECTRIC GENERATOR | 64. ANTENNAE | 65. STORAGE CELL | 66. COMMUTATOR MOTOR OR GENERATOR |
| 67. COMMUTATOR MOTOR OR GENERATOR (SERIES WOUND) | 68. COMMUTATOR MOTOR OR GENERATOR (SHUNT WOUND) | 69. COMMUTATOR MOTOR OR GENERATOR (COMPOUND WOUND) | 70. COMMUTATOR MOTOR OR GENERATOR (COMPOUND WOUND) (COMPENSATED) | 71. REPULSION MOTOR | 72. COMMUTATOR THREE-PHASE SHUNT MOTOR OR GENERATOR |
| 73. MOTOR-GENERATOR | 74. ROTARY CONVERTER (THREE-PHASE) | 75. SYNCHRONOUS MOTOR OR GENERATOR THREE-PHASE Y | 76. SYNCHRONOUS MOTOR OR GENERATOR QUARTER-PHASE Δ | 77. INDUCTION MOTOR OR GENERATOR SQUIRREL CAGE SINGLE-PHASE | 78. INDUCTION MOTOR OR GENERATOR SQUIRREL CAGE THREE-PHASE Y |
| 79. INDUCTION MOTOR OR GENERATOR SQUIRREL CAGE SIX-PHASE Δ | 80. INDUCTION MOTOR OR GENERATOR PHASE WOUND SECONDARY | 81. FREQUENCY CHANGER THREE-PHASE | 82. TRANSFORMER | 83. AUTO TRANSFORMER | 84. SERIES TRANSFORMER |
| 85. MERCURY ARC RECTIFIER | 86. ASYMMETRIC CELL | 87. ADJUSTABLE TRANSFORMER COUPLING | 88. ADJUSTABLE TRANSFORMER | 89. SPARK GAP | |

of a selected portion of each drawing for the Official Gazette.

“52. This work is done by the photolithographic process, and therefore the character of each original drawing must be brought as nearly as possible to a uniform standard of excellence, suited to the requirements of the process, to give the best results, in the interests of inventors, of the office, and of the public. The following rules will therefore be rigidly enforced, and any departure from them will be certain to cause delay in the examination of an application for letters patent:

“(a) Drawings must be made upon pure white paper of a thickness corresponding to two-sheet or three-sheet Bristol board. The surface of the paper must be calendered and smooth. India ink alone must be used, to secure perfectly black and solid lines.

“(b) The size of a sheet on which a drawing is made must be exactly 10 by 15 inches. One inch from its edges a single marginal line is to be drawn, leaving the “sight” precisely 8 by 13 inches. Within this margin all work and signatures must be included. One of the shorter sides of the sheet is regarded as its top, and, measuring downwardly from the marginal line, a space of not less than $1\frac{1}{4}$ inches is to be left blank for the heading of title, name, number, and date.

“(c) All drawings must be made with the pen only. Every line and letter (signatures included) must be absolutely black. This direction applies to all lines, however fine, to shading, and to lines representing cut surfaces in sectional views. All lines must be clean, sharp, and solid, and they must not be too fine or crowded. Surface shading, when used, should be open. Sectional shading should be made by oblique parallel lines, which

may be about one-twentieth of an inch apart. Solid black should not be used for sectional or surface shading. Free-hand work should be avoided wherever it is possible to do so.

“(d) Drawings should be made with the fewest lines possible consistent with clearness. By the observance of this rule the effectiveness of the work after reduction will be much increased. Shading (except on sectional views) should be used only on convex and concave surfaces, where it should be used sparingly, and may even there be dispensed with if the drawing be otherwise well executed. The plane upon which a sectional view is taken should be indicated on the general view by a broken or dotted line, which should be designated by numerals corresponding to the number of the sectional view. Heavy lines on the shade sides of objects should be used, except where they tend to thicken the work and obscure letters of reference. The light is always supposed to come from the upper left-hand corner at an angle of 45° .

“(e) The scale to which a drawing is made ought to be large enough to show the mechanism without crowding, and two or more sheets should be used if one does not give sufficient room to accomplish this end; but the number of sheets must never be more than is absolutely necessary.

“(f) The different views should be consecutively numbered. Letters and figures of reference must be carefully formed. They should, if possible, measure at least one-eighth of an inch in height, so that they may bear reduction to one twenty-fourth of an inch; and they may be much larger when there is sufficient room. They must be so placed in the close and complex parts of drawings as not to interfere with a thorough comprehension of the

same, and therefore should rarely cross or mingle with the lines. When necessarily grouped around a certain part they should be placed at a little distance, where there is available space, and connected by lines with the parts to which they refer. They should not be placed upon shaded surfaces, but when it is difficult to avoid this, a blank space must be left in the shading where the letter occurs, so that it shall appear perfectly distinct and separate from the work. If the same part of an invention appear in more than one view of the drawing it must always be represented by the same character, and the same character must never be used to designate different parts.

“(g) The signature of the applicant should be placed at the lower right-hand corner of each sheet, and the signatures of the witnesses, if any, at the lower left-hand corner, all within the marginal line, but in no instance should they trespass upon the drawings. (See specimen drawing, appendix.) The title should be written with pencil on the back of the sheet. The permanent names and title constituting the heading will be applied subsequently by the office in uniform style.

“(h) All views on the same sheet must stand in the same direction and must if possible stand so that they can be read with the sheet held in an upright position. If views longer than the width of the sheet are necessary for the proper illustration of the invention the sheet may be turned on its side. The space for heading must then be reserved at the right and the signatures placed at the left, occupying the same space and position as in the upright views and being horizontal when the sheet is held in an upright position. One figure must not be placed upon another or within the outline of another.

“(i) As a rule, one view only of each invention can be shown in the Gazette illustrations. The selection of that portion of a drawing best calculated to explain the nature of the specific improvement would be facilitated and the final result improved by the judicious execution of a figure with express reference to the Gazette, but which must at the same time serve as one of the figures referred to in the specification. For this purpose the figure may be a plan, elevation, section, or perspective view, according to the judgment of the draftsman. All its parts should be especially open and distinct, with very little or no shading, and it must illustrate the invention claimed only, to the exclusion of all other details. (See specimen drawing.) When well executed, it will be used without curtailment or change, but any excessive fineness, or crowding, or unnecessary elaborateness of detail, will necessitate its exclusion from the Gazette.

“(j) Drawings transmitted to the office should be sent flat, protected by a sheet of heavy binder’s board; or should be rolled for transmission in a suitable mailing tube, but should never be folded.

“(k) An agent’s or attorney’s stamp, or advertisement, or written address will not be permitted upon the face of a drawing, within or without the marginal line.

“53. All reissue applications must be accompanied by new drawings, of the character required in original applications, and the inventor’s name must appear upon the same in all cases; and such drawings shall be made upon the same scale as the original drawing, or upon a larger scale, unless a reduction of scale shall be authorized by the Commissioner.

“54. The foregoing rules relating to drawings will be rigidly enforced. A drawing not executed in conformity

thereto may be admitted for purposes of examination if it sufficiently illustrate the invention, but in such case the drawing must be corrected or a new one furnished before the application will be allowed. The necessary corrections will be made by the office, upon applicant's request and at his expense. (See Rule 72.)

“55. Applicants are advised to employ competent draftsmen to make their drawings.

“The office will furnish the drawings at cost, as promptly as its draftsmen can make them, for applicants who can not otherwise conveniently procure them.

THE MODEL

“56. A model will be required or admitted as a part of the application only when on examination of the case in its regular order the primary examiner shall find it to be necessary or useful. In such case, if a model has not been furnished, the examiner shall notify the applicant of such requirement, which will constitute an official action in the case. When a model has been received in compliance with the official requirement, the date of its filing shall be entered on the file wrapper. Models not required nor admitted will be returned to the applicants. When a model is required, the examination may be suspended until it shall have been filed.

“57. The model must clearly exhibit every feature of the machine which forms the subject of a claim of invention, but should not include other matter than that covered by the actual invention or improvement, unless it be necessary to the exhibition of the invention in a working model.

“58. The model must be neatly and substantially made of durable material, metal being deemed prefera-

ble; but when the material forms an essential feature of the invention, the model should be constructed of that material.

“59. A working model may be required if necessary to enable the office fully and readily to understand the precise operation of the machine.

“60. In all applications which have become abandoned, the model, unless it be deemed necessary that it be preserved in the office, may be returned to the applicant upon demand and at his expense; and the model in any pending case of less than one year's standing may be returned to the applicant upon the filing of a formal abandonment of the application, signed by the applicant in person and any assignee. (See Rule 171.)

“Models belonging to patented cases shall not be taken from the office except in the custody of some sworn employee of the office specially authorized by the Commissioner.

“61. Models filed as exhibits in contested cases may be returned to the parties at their expense. If not claimed within a reasonable time, they may be disposed of at the discretion of the Commissioner.”

(No Model.)

2 Sheets—Sheet 1.

W. A. COLLINS.
DREDGING BUCKET.

No. 572,651.

Patented Dec. 8, 1896.

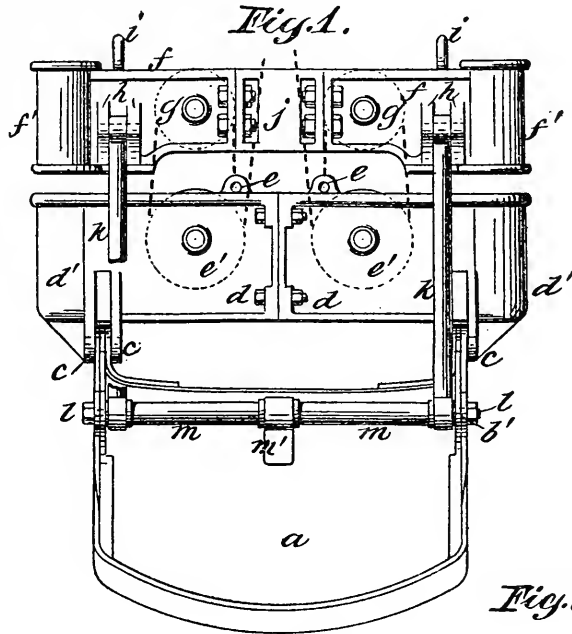
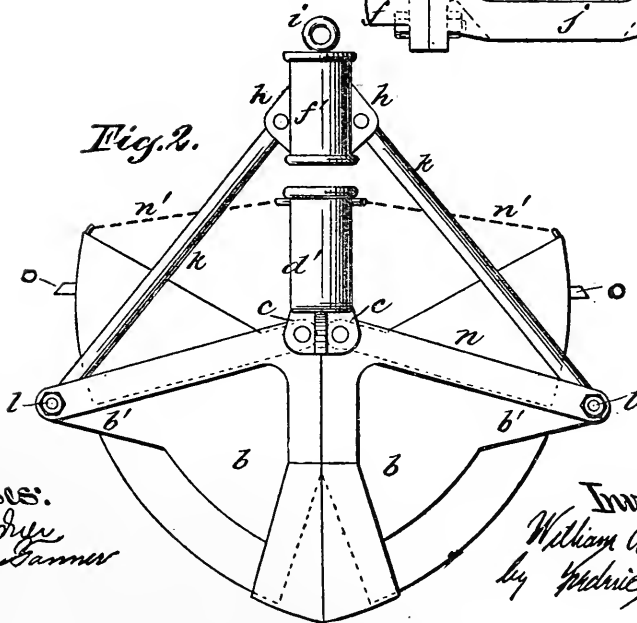
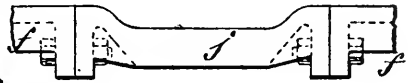

Fig. 3.



Witnesses:
D. W. andrye
J. Bradley Garner

Inventor:
William A. Collins
 by *Frederic Saragosa*
his Atty.

(No Model.)

2 Sheets—Sheet 2.

W. A. COLLINS.
DREDGING BUCKET.

No. 572,651.

Patented Dec. 8, 1896.

Fig. 4.

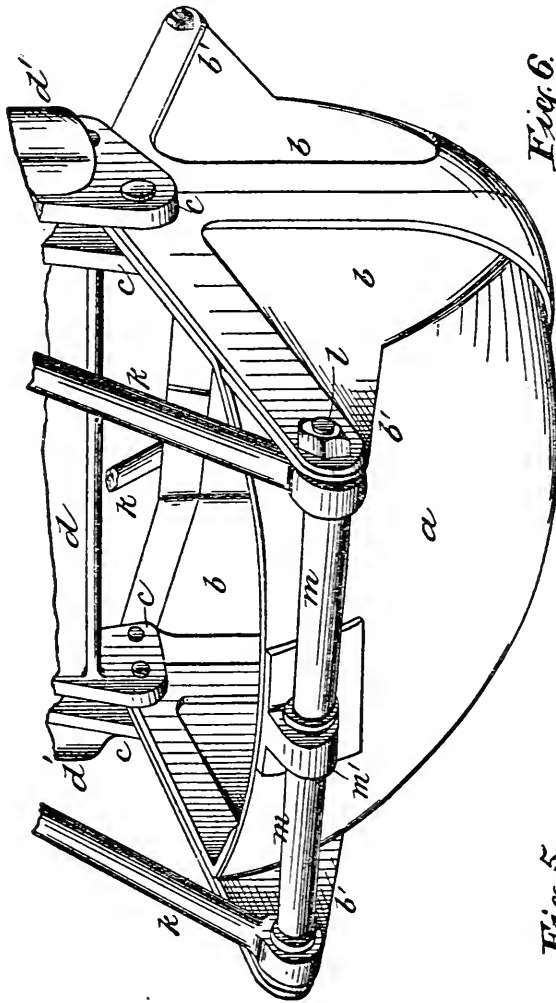

Fig. 6.

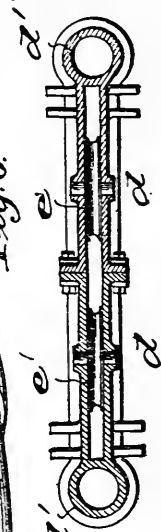
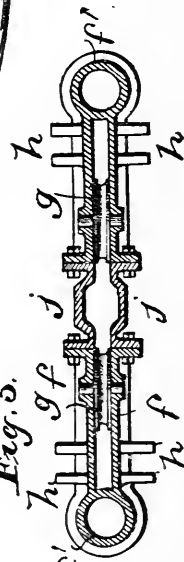

Fig. 5.



Witnesses:

D. W. Gardner.
J. Bradley Tamm

Inventor:

William A. Collins
by *Hubert S. ...*
his Atty.

CONVENTIONAL SYMBOLS

PIPE FITTINGS

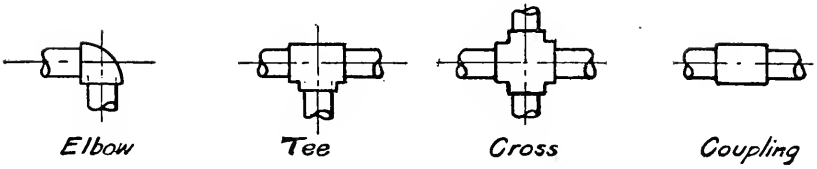

Elbow Tee Cross Coupling

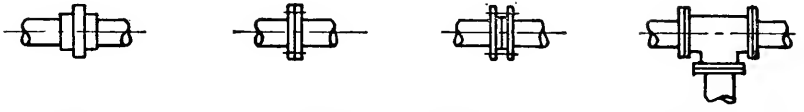

Union Flanged Unions Flanged Tee

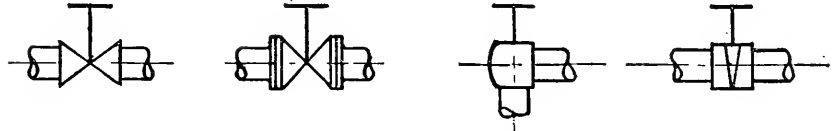

Screw Valve Flanged Valve Angle Valve Gate Valve

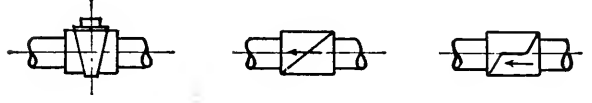

Plug Cock Swing Check Valve Lift Check Valve



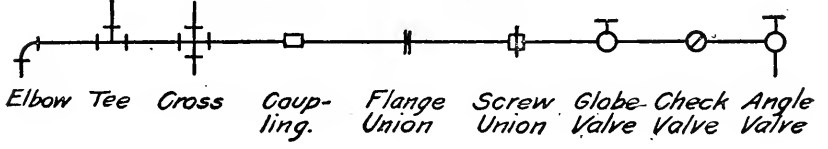













SINGLE LINE SYMBOLS



Elbow Tee Cross Coupling Flange Union Screw Union Globe Valve Check Valve Angle Valve

CONVENTIONAL SIGNS FOR RIVETING

Reproduced by permission from "Cambria."

| | Shop | Field | |
|--|---|---|---|
| Two Full Heads |  |  | |
| Countersunk Inside (Farside) and Chipped |  |  | |
| Countersunk Outside (Nearside) and Chipped |  |  | |
| Countersunk both sides and Chipped |  |  | |
| | Inside (Farside) | Outside (Nearside) | Both Sides |
| Flattened to $\frac{1}{8}$ " high or Countersunk and not Chipped |  |  |  |
| Flattened to $\frac{1}{4}$ " high |  |  |  |
| Flattened to $\frac{3}{8}$ " high |  |  |  |

This system, designed by F. C. Osborn, C. E., has for foundation the diagonal cross to represent a countersink, the blackened circle for a field rivet, and the diagonal stroke to indicate a flattened head. The position of the cross, with respect to the circle (inside, outside, or both sides), indicates the location of the countersink and, similarly, the number and position of the diagonal strokes indicate the height and position of the flattened heads.

Any combination of field, countersunk and flattened head rivets liable to occur may be readily indicated by the proper combination of above signs.

CONVENTIONAL SYMBOLS — BREAKS

STRUCTURAL MATERIAL

Round bar of metal. Section end according to material as given under cross-sections.

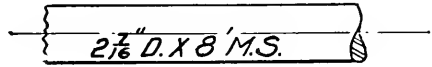

Tube or pipe. Section end as above.

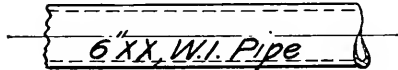

Rectangular bar of metal. Section end as above.

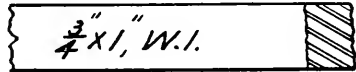

Hollow metal pipe or duct. Section end as above.

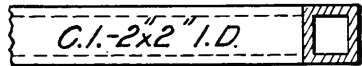

Breaks in rolled shapes usually shown by blacking ends in solid.

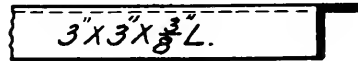

When number of pieces are not called for — mark this way.

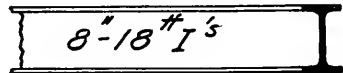

When number of pieces are called for, mark this way.

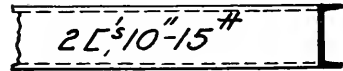

Rail — New or Relayers.

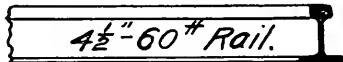

Round Timber.

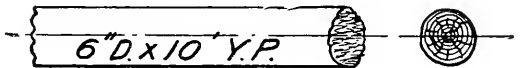

Square Timber.

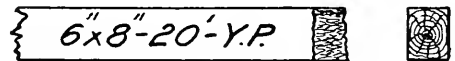

Plank.

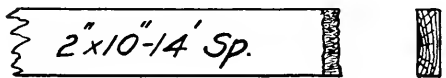

Timber — Usually rough or standing.
 Lumber — Sawn or worked timber.
 Kind — Round, square, plank, etc.
 Finishes — R. = Rough Dr. = Dressed
 S4S = Surfaced 4 Sides.
 S2S & 1 E = Surfaced 2 Sides and 1 edge, etc.

THREADS AND TAPPED HOLES

Threads and Tapped Holes. — For dimensions of all kinds of bolts, screws, etc., and much valuable tool and shop information which should be in the hands of every draftsman, reference should be made to the handbooks.

There is some difference noted in showing tapped holes, and similarity in showing counterbored and tapped holes. The following examples will at least make a distinction there.

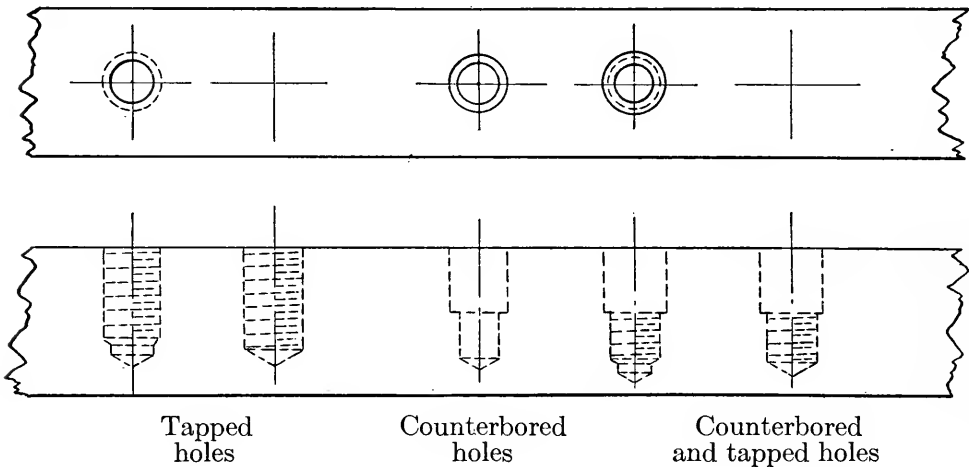

TOPOGRAPHIC SYMBOLS

The following symbols are used by the U. S. Geological Survey and, with the explanatory text, have been reproduced from a typical U. S. topographic map.

The features shown on these atlas sheets or maps may be classed in three groups — (1) *water*, including seas, lakes, rivers, canals, swamps, and other bodies of water; (2) *relief*, including mountains, hills, valleys, and other elevations and depressions; (3) *culture* (works of man), such as towns, cities, roads, railroads, and boundaries. The conventional signs used for these features are shown below, with explanations.

All water features are printed in *blue*, the smaller streams and canals in full blue lines and the larger streams, lakes, and the sea in blue water-lining. Intermittent streams — those whose beds are dry at least three months in the year — are shown by lines of dots and dashes.

Relief is shown by contour lines in *brown*. A contour on the ground passes through points that have the same altitude. One who follows a contour will go neither uphill nor downhill but on a level. The contour lines on the map show not only the shapes of the hills, mountains, and valleys but also their elevations. The line of the seacoast itself is a contour line, the datum or zero of elevation being mean sea level. The contour at, say, twenty feet above sea level would be the shore line if the sea were to rise or the land to sink twenty feet. On a gentle slope this contour is far from the present coast; on a steep slope it is near the coast. Where successive

contour lines are far apart on the map they indicate a gentle slope; where they are close together they indicate a steep slope; and where they run together in one line they indicate a cliff.

The manner in which contour lines express altitude, form, and grade is shown in the figure below.

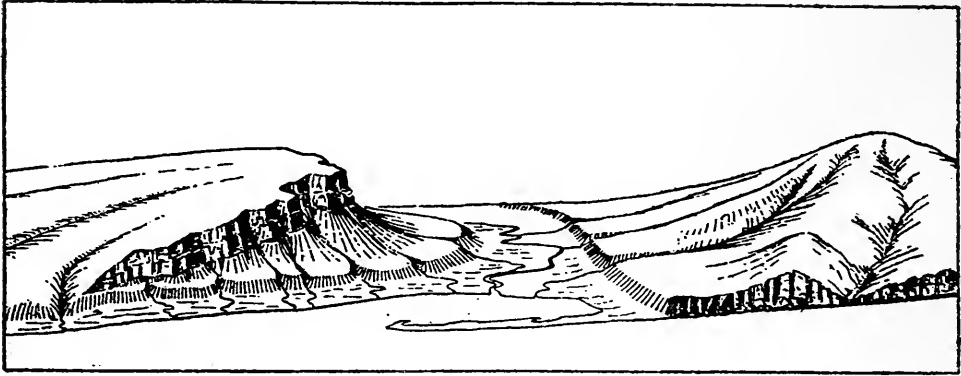

The sketch represents a river valley between two hills. In the foreground is the sea, with a bay that is partly inclosed by a hooked sand bar. On each side of the valley is a terrace into which small streams have cut narrow gullies. The hill on the right has a rounded summit and gently sloping spurs separated by ravines. The

spurs are truncated at their lower ends by a sea cliff. The hill on the left terminates abruptly at the valley in a steep scarp. It slopes gradually back away from the scarp and forms an inclined table-land, which is traversed by a few shallow gullies. On the map each of these features is indicated, directly beneath its position in the sketch, by contour lines.

The works of man are shown in *black*, in which color all lettering also is printed. Boundaries, such as those of a State, county, city, land grant, township, or reservation, are shown by continuous or broken lines of different kinds and weights. Public and through roads are shown by fine double lines; private and poor roads by dashed double lines; trails by dashed single lines.

CULTURE
(Printed in Black)



City or Village

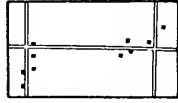

Roads and Buildings

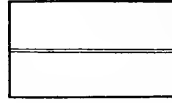

Metaled Road
(distinguished on recent maps only)

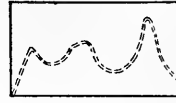

Private or Secondary Road

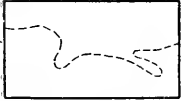

Trail or Path

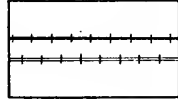

Railroads

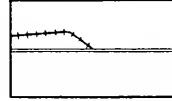

Electric Railroad

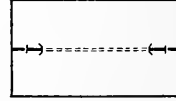

Tunnel

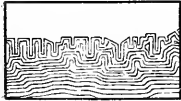

Wharves



Breakwater and Jetties

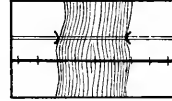

Bridges

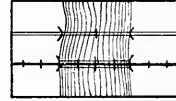

Drawbridges

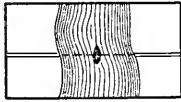

Ferry
(Point Upstream)

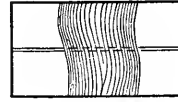

Ford

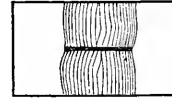

Dam

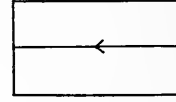

Canal Lock
(Point up Stream)

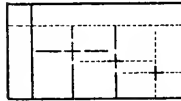

U. S. Township and Section Lines and located Corners

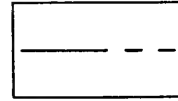

State Line

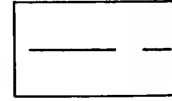

County Line



Civil Township or District Line

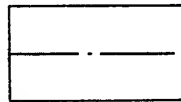

Reservation Line

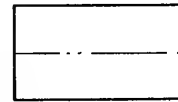

Land Grant Line

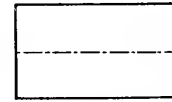

City Village or Borough Line

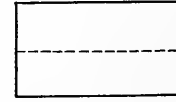

Small Park or Cemetery Line

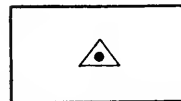

Triangulation or Primary Traverse Monument



U. S. Mineral Monument

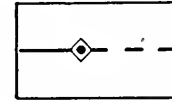

Boundary Monument

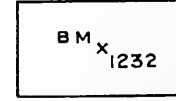

Bench Mark
(Temporary bench mark shown by brown cross and black figures without lettering)

CULTURE
(Continued)

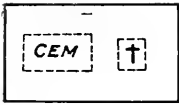

Cemeteries

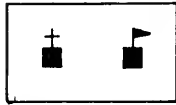

Church, School
(Distinguished on
recent Maps)

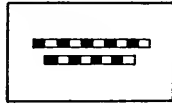

Coke Ovens

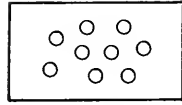

Oil Wells



Mine or Quarry

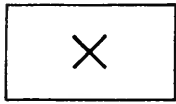

Prospect



Shaft

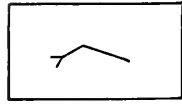

Mine Tunnel
(Showing Direction)



Mine Tunnel
(Direction Unknown)



Light-Ship

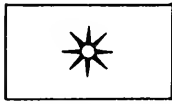

Lighthouse or Beacon



Life-Saving Station

RELIEF
(Printed in Brown)



Figures
(Showing heights above mean sea level instrumentally determined)

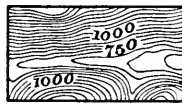

Contours
(Showing height above sea, horizontal form, and steepness of slope of the surface)

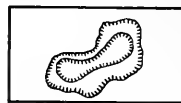

Depression Contours

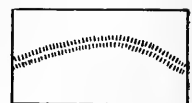

Levee

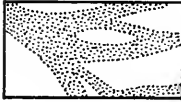

Wash



Cliffs



Mine Dumps

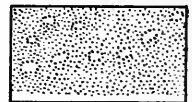

Sand and Sand Dunes

WATER
(Printed in Blue)

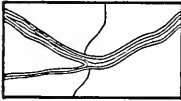

Streams

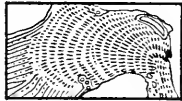

Falls and Rapids

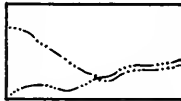

Intermittent Streams and Ditches

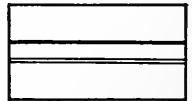

Canals or Ditches

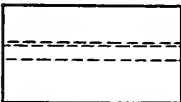

Aqueducts or Waterpipes

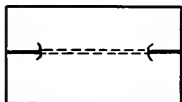

Aqueduct Tunnel

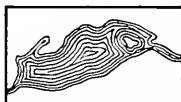

Lake or Pond

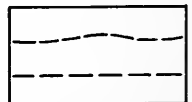

Unsurveyed Streams and abandoned Canals



Intermittent Lake



Glacier
(Or shown by contours printed in Blue)



Spring

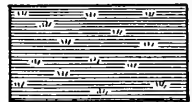

Salt Marsh



Fresh Marsh



Grassy Pond



Tidal Flat

WOODS
(When shown, printed in Green)

PART III
FORMS

FORM SIZES
DRAWING SIZES
APPLICATION BLANK
ARRANGEMENT OF DRAWING
BUILDING AND EQUIPMENT
RECORD
PRINT RECORD
PATTERN RECORD

INDEX CARDS
MATERIAL LIST
SPECIFICATIONS
ORGANIZATION CHART
RUBBER STAMPS
TITLES
WORK SCHEDULE
WORK ORDERS

FORM SIZES

Forms should be made on $8\frac{1}{2}'' \times 11''$ sheets, or fractions or multiples of this size, as:

$$\begin{aligned}
 &4\frac{1}{4}'' \times 5\frac{1}{2}'' \\
 &5\frac{1}{2}'' \times 8\frac{1}{2}'' \\
 &8\frac{1}{2}'' \times 11'' \\
 &11'' \times 17'' \\
 &17'' \times 22''
 \end{aligned}$$

Each form should have a number assigned to it for record in a form record book. This book is preferably $8\frac{1}{2}'' \times 11''$ size and a sample of each form should be pasted in it and records of numbers printed and printing costs kept.

It is advisable to have all new forms first made on typewriter and copies multigraphed for trial if size permits. Changes can then be made before final printing. An example is the application blank following. If the form is too large for this method, then a tracing can be made and Van Dyke prints, which give blue lines on a white ground, made from that for trial.

DRAWING SIZES

| MARK | OVER ALL | | MARGIN | TITLE | SQ. FT. |
|------|----------------|--------|---------------|------------------------------------|----------------|
| | HIGHT | LENGTH | | | |
| A | $8\frac{1}{2}$ | 11 | $\frac{1}{4}$ | $1\frac{5}{8} \times 4$ | $\frac{2}{3}$ |
| B | 12 | 18 | $\frac{1}{4}$ | $2\frac{1}{8} \times 4\frac{1}{2}$ | $1\frac{1}{2}$ |
| C | 18 | 24 | $\frac{3}{8}$ | $2\frac{1}{8} \times 4\frac{1}{2}$ | 3 |
| D | 24 | 36 | $\frac{3}{8}$ | $2\frac{1}{8} \times 4\frac{1}{2}$ | 6 |
| E | 30 | 41 | $\frac{3}{8}$ | $2\frac{1}{8} \times 4\frac{1}{2}$ | $8\frac{3}{4}$ |

APPLICATION

Name of company..... Department.....

Number..... Date..... Position applied for.....

Name..... Address.....

| Schools or colleges attended. | From | To | Courses | Degrees |
|-------------------------------|-------|-------|---------|---------|
| | | | | |
| | | | | |

Languages spoken..... Written.....

RECORD OF FORMER AND PRESENT EMPLOYMENT — LAST FOUR POSITIONS

| | From | | To | | Name of Employer | Head of Dep't. | Address |
|--------|-------|-------|-------|-------|------------------|----------------|---------|
| | Month | Year | Month | Year | | | |
| 1..... | | | | | | | |
| 2..... | | | | | | | |
| 3..... | | | | | | | |
| 4..... | | | | | | | |

(Give kind of work done in each position on back of this sheet.)

Can we refer to all?..... If not, indicate three.....

Reason for leaving last position.....

When available.....

Salary expected..... Last salary received.....

Date of birth..... Place of birth.....

Height..... Weight..... Married.....

Are you a citizen of the United States?.....

Ever employed by this company?..... If so, when?.....

Describe any special experience or training that you have had.....

.....

.....

.....

Engaged..... Date..... Rate..... Filed..... Rejected.....

*TYPICAL ARRANGEMENT OF VIEWS, TITLE AND MATERIAL LIST
FOR ALL SHEETS EXCEPT 'A':*

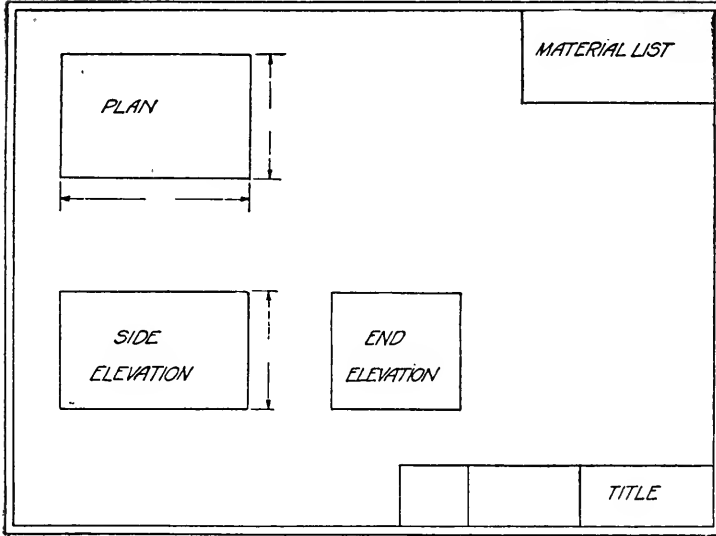

TYPICAL ARRANGEMENT OF 'A' SHEET.

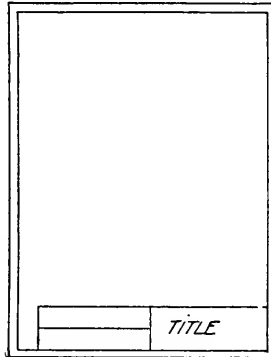

BUILDING AND EQUIPMENT RECORD

(Name of company)

Plant..... Date.....
 Section..... Product.....
 Building No..... Size..... Stories.....
 Type Roof.....
 Construction Materials.....
 Kind of Foundation.....

CONNECTIONS

| Comp. Air | Electric | Gas | Sewer | Steam | Water | |
|-----------|----------|-------|-------|-------|-------|-------|
| | | | | | | |

Railroad station..... Distance.....
 Telephone exchange..... Number.....

EQUIPMENT

| Name | No. in use | Maker's no. | Kind | Size | Type |
|-------|------------|-------------|-------|-------|-------|
| | | | | | |
| | | | | | |
| | | | | | |
| | | | | | |
| | | | | | |
| | | | | | |
| | | | | | |
| | | | | | |
| | | | | | |
| | | | | | |
| | | | | | |

Remarks.....

Compiled..... Checked..... Approved.....

DRAWING AND PATTERN RECORD BOOKS

| DRAWING RECORD | | | | <i>(Left hand Page)</i> | | |
|----------------|------|-------|------|-------------------------|--------|---------|
| N° | DATE | PLANT | PART | DESCRIPTION | DR. BY | REMARKS |
| | | | | | | |
| | | | | | | |
| | | | | | | |

| PRINT RECORD | | | | | | | | | | | | <i>(Right hand Page)</i> | | |
|--------------|----|------|----|----|------|----|----|------|----|----|------|--------------------------|----|------|
| N° | TO | DATE | N° | TO | DATE | N° | TO | DATE | N° | TO | DATE | DATE | TO | DATE |
| | | | | | | | | | | | | | | |
| | | | | | | | | | | | | | | |
| | | | | | | | | | | | | | | |

| PATTERN RECORD | | | | | | <i>(Left hand Page)</i> | |
|----------------|-----------|-------|-------------|---------|------|-------------------------|--|
| OUR N° | OTHERS N° | NAME | | MADE BY | DATE | COST | |
| | | PLANT | DESCRIPTION | | | | |
| | | | | | | | |
| | | | | | | | |
| | | | | | | | |

| PATTERN RECORD | | | | | | | | | | | | <i>(Right hand Page)</i> | | | |
|----------------|------|------|------|------|------|------|------|------|------|------|------|--------------------------|----|------|------|
| TO | NAME | DATE | NAME | DATE | NAME | DATE | NAME | DATE | NAME | DATE | NAME | DATE | TO | NAME | DATE |
| | | | | | | | | | | | | | | | |
| | | | | | | | | | | | | | | | |
| | | | | | | | | | | | | | | | |

INDEX CARDS

| <i>(Index letter)</i> | | <i>(Section of file)</i> | | | |
|-----------------------|------|--------------------------|----------|--|--|
| PLANT | PART | DESCRIPTION | DWG. NO. | | |
| | | | | | |
| | | | | | |
| | | | | | |
| | | | | | |
| | | | | | |
| | | | | | |
| | | | | | |
| | | | | | |
| | | | | | |

| <i>(Index letter)</i> | | <i>(By Articles or Manufacturers)</i> | |
|-----------------------|---------|---------------------------------------|--|
| NAME | ARTICLE | NO. | |
| | | | |
| | | | |
| | | | |
| | | | |
| | | | |
| | | | |
| | | | |
| | | | |
| | | | |
| | | | |

| PRINT ORDER _____ <i>(Date)</i> _____ 19__ | | | | |
|--|----------|-------------|-----|-------------|
| HOW MANY | DWG. NO. | REQUIRED BY | FOR | RECEIVED BY |
| | | | | |
| | | | | |
| | | | | |
| | | | | |
| | | | | |
| | | | | |
| | | | | |
| | | | | |
| | | | | |
| | | | | |

MATERIAL LIST

Form A 93.

*Name of Company
Address or Dept*

ORDER No. ----- PLANT -----
 PROJECT ----- PART -----
 DATE ----- MATERIAL ----- *(Kind or Misc.)*
 REQUISITION -----

| PART No | Dwg. No | PART OR MEMBER | No. Pcs | DESCRIPTION | TOTAL |
|---------|---------|----------------|---------|-------------|-------|
| | | | | | |

| | | | | | |
|--|--|--|--|--|--|
| | | | | | |
|--|--|--|--|--|--|

COMPILED ----- CHECKED ----- APPROVED -----

SPECIFICATIONS

| | | |
|---|-------------------|----------------------|
| O | ORDER No. | Plant |
| | Project | Part |
| | Date | SPECIFICATIONS |
| | Requisition | |
| | | |
| O | | Written |
| | | Checked |
| | | Approved |

ORGANIZATION CHART

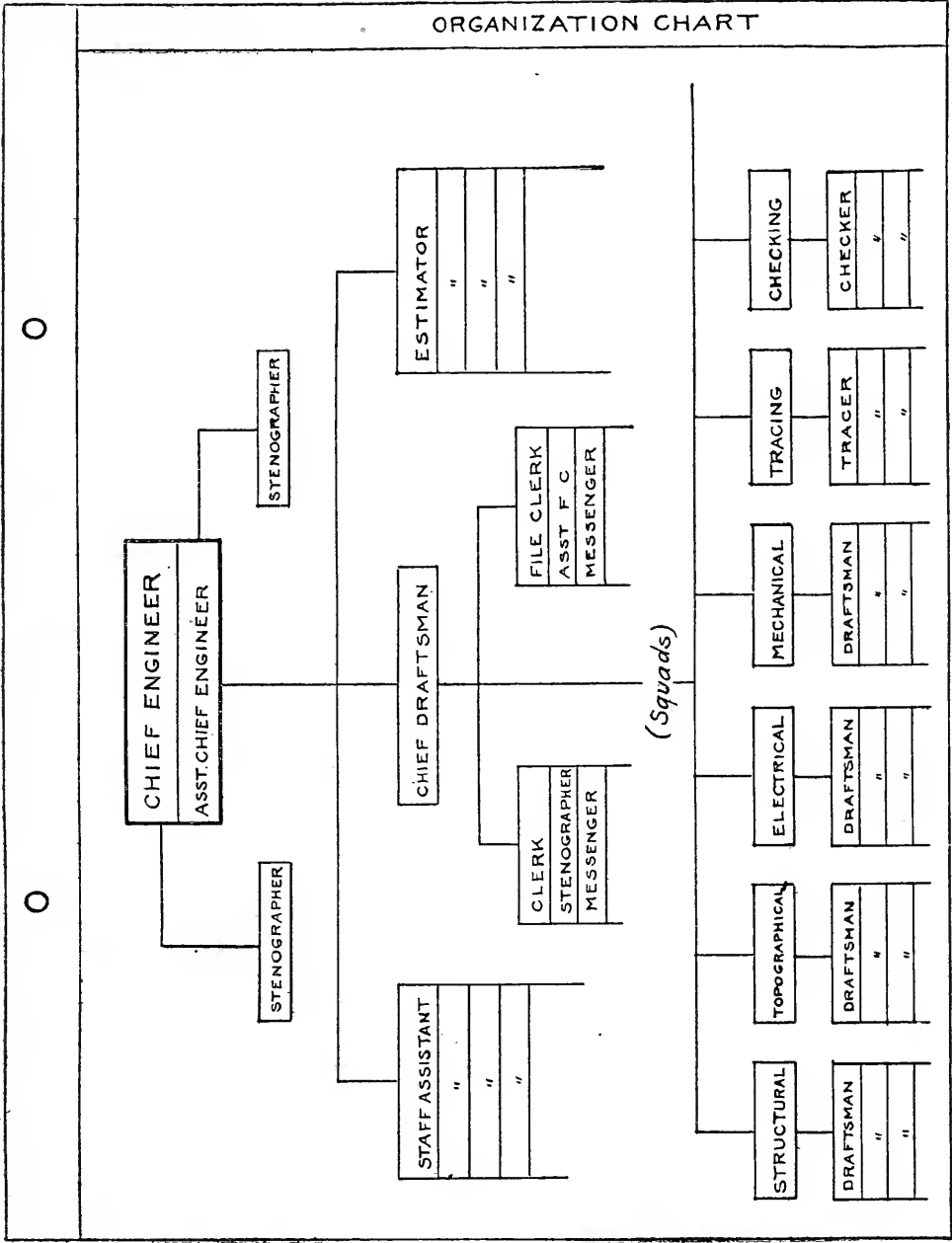

RUBBER STAMP FORMS

SCALE HALF SIZE

| | |
|---|--|
| <p><i>Filing Department stamp for foreign prints.</i></p> | <p>(Company Name) ENGINEERING DEPARTMENT, ..(Place).. RECEIVED....(Date)..... DRAFTING ROOM FILE N°.....</p> |
| <p><i>Stamp for prints sent out before approval.</i></p> | <p>PRELIMINARY PRINT</p> |
| <p><i>Stamp for the first print from all tracings including revisions.</i></p> | <p>RECORD PRINT (Date) Not to be taken from Eng. Dept.</p> |
| <p><i>Stamp for void drawings, giving name of person authorizing cancellation, and the superseding drawing N°</i></p> | <p>VOID (Date) 19... BY. (Authority).... SUPERSEDED BY ..(Drawing N°).....</p> |
| <p><i>Stamp for calling attention to a Revised Print.</i></p> | <p>REVISED PRINT (Date) DESTROY EARLIER REVISIONS</p> |

| <p style="margin: 0;">O</p> <p style="margin: 0; text-align: right;">TITLES</p> | | | | | | | | | | | | | | | | | | | | | | | | | | | | | | | | | | | | | | | | | | | | | | | | | | | | | | | | | | | | | | | | | | | | | | | | | | | | | |
|--|------------------|----------------------|-----------|----------|---------|--|--------------|--|---------|-----------------|------------------|----------------------|-----------|----------|-----------------|-------------------------------------|--|----|-----|-----|------|----|--|--------------|--|---------|-------------|------------------|----------------------|--|--|-----------------|----------|--|--|-----|-----|------|----|------|--|--|----|--|--|--|--|--|----|--|--|--|--|--|----|--|--|--|--|--|----|--|--|--|--|--|----|--|--|--|--|--|----|--|--|--|--|
| <p style="margin: 0;">O</p> <p style="margin: 0; text-align: right;">6 1/2</p> | | | | | | | | | | | | | | | | | | | | | | | | | | | | | | | | | | | | | | | | | | | | | | | | | | | | | | | | | | | | | | | | | | | | | | | | | | | | | |
| <p style="margin: 0;">24</p> <p style="margin: 0; text-align: center;">3 1/2</p> <p style="margin: 0; text-align: right;">4 1/2</p> | | | | | | | | | | | | | | | | | | | | | | | | | | | | | | | | | | | | | | | | | | | | | | | | | | | | | | | | | | | | | | | | | | | | | | | | | | | | | |
| <p style="margin: 0;">To suit number of parts</p> | | | | | | | | | | | | | | | | | | | | | | | | | | | | | | | | | | | | | | | | | | | | | | | | | | | | | | | | | | | | | | | | | | | | | | | | | | | | | |
| <p style="margin: 0;">MATERIAL LIST.</p> | | | | | | | | | | | | | | | | | | | | | | | | | | | | | | | | | | | | | | | | | | | | | | | | | | | | | | | | | | | | | | | | | | | | | | | | | | | | | |
| <table border="1" style="width: 100%; border-collapse: collapse;"> <thead> <tr> <th style="width: 10%;">MK</th> <th style="width: 40%;">NAME</th> <th style="width: 10%;">NO FOR I.....</th> <th style="width: 10%;">SIZE</th> <th style="width: 30%;">MATERIAL</th> <th style="width: 10%;">REMARKS</th> </tr> </thead> <tbody> <tr> <td style="text-align: center;">1</td> <td></td> <td></td> <td></td> <td></td> <td></td> </tr> <tr> <td style="text-align: center;">2</td> <td></td> <td></td> <td></td> <td></td> <td></td> </tr> <tr> <td style="text-align: center;">3</td> <td></td> <td></td> <td></td> <td></td> <td></td> </tr> </tbody> </table> | | | | | | | | | | MK | NAME | NO FOR I..... | SIZE | MATERIAL | REMARKS | 1 | | | | | | 2 | | | | | | 3 | | | | | | | | | | | | | | | | | | | | | | | | | | | | | | | | | | | | | | | | | | | | | | | | | |
| MK | NAME | NO FOR I..... | SIZE | MATERIAL | REMARKS | | | | | | | | | | | | | | | | | | | | | | | | | | | | | | | | | | | | | | | | | | | | | | | | | | | | | | | | | | | | | | | | | | | | | | | | |
| 1 | | | | | | | | | | | | | | | | | | | | | | | | | | | | | | | | | | | | | | | | | | | | | | | | | | | | | | | | | | | | | | | | | | | | | | | | | | | | | |
| 2 | | | | | | | | | | | | | | | | | | | | | | | | | | | | | | | | | | | | | | | | | | | | | | | | | | | | | | | | | | | | | | | | | | | | | | | | | | | | | |
| 3 | | | | | | | | | | | | | | | | | | | | | | | | | | | | | | | | | | | | | | | | | | | | | | | | | | | | | | | | | | | | | | | | | | | | | | | | | | | | | |
| <p style="margin: 0;">STANDARD TITLE & MATERIAL LIST FOR B, C, D & E SIZE DRAWINGS.</p> | | | | | | | | | | | | | | | | | | | | | | | | | | | | | | | | | | | | | | | | | | | | | | | | | | | | | | | | | | | | | | | | | | | | | | | | | | | | | |
| <table border="1" style="width: 100%; border-collapse: collapse;"> <thead> <tr> <th style="width: 15%;">REFERENCE DWG'S</th> <th style="width: 10%;">MK</th> <th style="width: 10%;">DATE</th> <th style="width: 20%;">REVISIONS</th> <th style="width: 10%;">BY</th> <th style="width: 10%;">GND</th> <th style="width: 30%;">NAME OF COMPANY LOCATION DATE</th> </tr> </thead> <tbody> <tr> <td></td> <td style="text-align: center;">A.</td> <td></td> <td></td> <td></td> <td></td> <td rowspan="6" style="vertical-align: top;"> <table border="1" style="width: 100%; border-collapse: collapse;"> <thead> <tr> <th colspan="2" style="text-align: center;">NAME OF PART</th> <th style="text-align: center;">ORD. NO</th> </tr> <tr> <th style="text-align: center;">DESCRIPTION</th> <th style="text-align: center;">FACTORY OR PLANT</th> <th style="text-align: center;">(Typical Drawing No)</th> </tr> </thead> <tbody> <tr> <td></td> <td></td> <td style="text-align: center;">F-D-1056</td> </tr> <tr> <td colspan="2" style="text-align: center;">SCALE --</td> <td></td> </tr> <tr> <td style="text-align: center;">DR.</td> <td style="text-align: center;">TR.</td> <td style="text-align: center;">CAD.</td> </tr> <tr> <td style="text-align: center;">AR</td> <td style="text-align: center;">DATE</td> <td></td> </tr> </tbody> </table> </td> </tr> <tr> <td></td> <td style="text-align: center;">B.</td> <td></td> <td></td> <td></td> <td></td> </tr> <tr> <td></td> <td style="text-align: center;">C.</td> <td></td> <td></td> <td></td> <td></td> </tr> <tr> <td></td> <td style="text-align: center;">D.</td> <td></td> <td></td> <td></td> <td></td> </tr> <tr> <td></td> <td style="text-align: center;">E.</td> <td></td> <td></td> <td></td> <td></td> </tr> <tr> <td></td> <td style="text-align: center;">F.</td> <td></td> <td></td> <td></td> <td></td> </tr> <tr> <td></td> <td style="text-align: center;">G.</td> <td></td> <td></td> <td></td> <td></td> </tr> </tbody> </table> | | | | | | | | | | REFERENCE DWG'S | MK | DATE | REVISIONS | BY | GND | NAME OF COMPANY LOCATION DATE | | A. | | | | | <table border="1" style="width: 100%; border-collapse: collapse;"> <thead> <tr> <th colspan="2" style="text-align: center;">NAME OF PART</th> <th style="text-align: center;">ORD. NO</th> </tr> <tr> <th style="text-align: center;">DESCRIPTION</th> <th style="text-align: center;">FACTORY OR PLANT</th> <th style="text-align: center;">(Typical Drawing No)</th> </tr> </thead> <tbody> <tr> <td></td> <td></td> <td style="text-align: center;">F-D-1056</td> </tr> <tr> <td colspan="2" style="text-align: center;">SCALE --</td> <td></td> </tr> <tr> <td style="text-align: center;">DR.</td> <td style="text-align: center;">TR.</td> <td style="text-align: center;">CAD.</td> </tr> <tr> <td style="text-align: center;">AR</td> <td style="text-align: center;">DATE</td> <td></td> </tr> </tbody> </table> | NAME OF PART | | ORD. NO | DESCRIPTION | FACTORY OR PLANT | (Typical Drawing No) | | | F-D-1056 | SCALE -- | | | DR. | TR. | CAD. | AR | DATE | | | B. | | | | | | C. | | | | | | D. | | | | | | E. | | | | | | F. | | | | | | G. | | | | |
| REFERENCE DWG'S | MK | DATE | REVISIONS | BY | GND | NAME OF COMPANY LOCATION DATE | | | | | | | | | | | | | | | | | | | | | | | | | | | | | | | | | | | | | | | | | | | | | | | | | | | | | | | | | | | | | | | | | | | | | | | |
| | A. | | | | | <table border="1" style="width: 100%; border-collapse: collapse;"> <thead> <tr> <th colspan="2" style="text-align: center;">NAME OF PART</th> <th style="text-align: center;">ORD. NO</th> </tr> <tr> <th style="text-align: center;">DESCRIPTION</th> <th style="text-align: center;">FACTORY OR PLANT</th> <th style="text-align: center;">(Typical Drawing No)</th> </tr> </thead> <tbody> <tr> <td></td> <td></td> <td style="text-align: center;">F-D-1056</td> </tr> <tr> <td colspan="2" style="text-align: center;">SCALE --</td> <td></td> </tr> <tr> <td style="text-align: center;">DR.</td> <td style="text-align: center;">TR.</td> <td style="text-align: center;">CAD.</td> </tr> <tr> <td style="text-align: center;">AR</td> <td style="text-align: center;">DATE</td> <td></td> </tr> </tbody> </table> | NAME OF PART | | ORD. NO | DESCRIPTION | FACTORY OR PLANT | (Typical Drawing No) | | | F-D-1056 | SCALE -- | | | DR. | TR. | CAD. | AR | | DATE | | | | | | | | | | | | | | | | | | | | | | | | | | | | | | | | | | | | | | | | | | | | | | | | | | | | | |
| NAME OF PART | | ORD. NO | | | | | | | | | | | | | | | | | | | | | | | | | | | | | | | | | | | | | | | | | | | | | | | | | | | | | | | | | | | | | | | | | | | | | | | | | | | |
| DESCRIPTION | FACTORY OR PLANT | (Typical Drawing No) | | | | | | | | | | | | | | | | | | | | | | | | | | | | | | | | | | | | | | | | | | | | | | | | | | | | | | | | | | | | | | | | | | | | | | | | | | | |
| | | F-D-1056 | | | | | | | | | | | | | | | | | | | | | | | | | | | | | | | | | | | | | | | | | | | | | | | | | | | | | | | | | | | | | | | | | | | | | | | | | | | |
| SCALE -- | | | | | | | | | | | | | | | | | | | | | | | | | | | | | | | | | | | | | | | | | | | | | | | | | | | | | | | | | | | | | | | | | | | | | | | | | | | | | |
| DR. | TR. | CAD. | | | | | | | | | | | | | | | | | | | | | | | | | | | | | | | | | | | | | | | | | | | | | | | | | | | | | | | | | | | | | | | | | | | | | | | | | | | |
| AR | DATE | | | | | | | | | | | | | | | | | | | | | | | | | | | | | | | | | | | | | | | | | | | | | | | | | | | | | | | | | | | | | | | | | | | | | | | | | | | | |
| | B. | | | | | | | | | | | | | | | | | | | | | | | | | | | | | | | | | | | | | | | | | | | | | | | | | | | | | | | | | | | | | | | | | | | | | | | | | | | | |
| | C. | | | | | | | | | | | | | | | | | | | | | | | | | | | | | | | | | | | | | | | | | | | | | | | | | | | | | | | | | | | | | | | | | | | | | | | | | | | | |
| | D. | | | | | | | | | | | | | | | | | | | | | | | | | | | | | | | | | | | | | | | | | | | | | | | | | | | | | | | | | | | | | | | | | | | | | | | | | | | | |
| | E. | | | | | | | | | | | | | | | | | | | | | | | | | | | | | | | | | | | | | | | | | | | | | | | | | | | | | | | | | | | | | | | | | | | | | | | | | | | | |
| | F. | | | | | | | | | | | | | | | | | | | | | | | | | | | | | | | | | | | | | | | | | | | | | | | | | | | | | | | | | | | | | | | | | | | | | | | | | | | | |
| | G. | | | | | | | | | | | | | | | | | | | | | | | | | | | | | | | | | | | | | | | | | | | | | | | | | | | | | | | | | | | | | | | | | | | | | | | | | | | | |

WORK ORDER FORM

Name of Company

ENGINEERING DIVISION - WORK AUTHORIZATION

Name

Plant Location

Character of Work

Authorized by Date

Appropriation Approved Charge No.

DIRECTIONS.

*Front side of first and second sheets.
First sheets on distinctive paper and
printed on both sides. Reverse side
for draftsmans time record.
Second sheets on thin white paper
suitable for manifolding; size 8½" x 11."*

Further information to be supplied by To complete

Commenced by Date Completed

SIGNED DATE N°

WORK ORDER FORM. (Reverse side)

TITLES MUST APPEAR ON DRAWINGS AS HERE GIVEN

| TITLE | Dwg No. | Notes |
|-------|---------|-------|
| | | |
| | | |
| | | |
| | | |
| | | |
| | | |
| | | |
| | | |
| | | |
| | | |
| | | |
| | | |
| | | |
| | | |
| | | |
| | | |
| | | |
| | | |
| | | |
| | | |
| | | |
| | | |
| | | |

IF ADDITIONAL SPACE IS REQUIRED FOR DWG NOS. ETC. USE TWO SHEETS.

DRAFTSMAN'S TIME RECORD

UNDER KIND, INSERT KIND OF WORK AS DES., DWG., TRC., CKG., REV.

| DATE | KIND | BY | COMMENCED | | COMPLETED | | TOTAL | | REMARKS |
|------|------|----|-----------|------|-----------|------|-------|-----|---------|
| | | | DATE | TIME | DATE | TIME | HRS | MIN | |
| | | | | | | | | | |
| | | | | | | | | | |
| | | | | | | | | | |
| | | | | | | | | | |
| | | | | | | | | | |
| | | | | | | | | | |
| | | | | | | | | | |
| | | | | | | | | | |
| | | | | | | | | | |
| | | | | | | | | | |
| | | | | | | | | | |
| | | | | | | | | | |
| | | | | | | | | | |
| | | | | | | | | | |
| | | | | | | | | | |
| | | | | | | | | | |
| | | | | | | | | | |
| | | | | | | | | | |
| | | | | | | | | | |
| | | | | | | | | | |
| | | | | | | | | | |
| | | | | | | | | | |

RETURN THIS SHEET, PROPERLY FILLED OUT, WITH COMPLETED WORK.

PART IV

MISCELLANEOUS TABLES

| | |
|--------------------|--------------------------|
| BOLT STRESSES | KEY-WAYS |
| BOLTS AND NUTS | SHAFTING H.P. |
| BOLT THREADS | GAGES—SHEET |
| WASHERS | GAGES—WIRE |
| WEIGHT—STEEL BARS | METRIC CONVERSION |
| STUDS | WEIGHTS AND MEASURES |
| PIPE THREAD—BRIGGS | DECIMAL EQUIVALENTS |
| PIPE SIZES | AREAS AND CIRCUMFERENCES |
| BOILER TUBES | OF CIRCLES |
| PIPE FLANGES | REFERENCE BOOKS |
| PIPE FITTINGS | |



STRESSES IN BOLTS

Tensile Stress at 10,000 lbs. per sq. in. at **Root of "U.S." Thread.**

Shearing Stress at 8000 lbs. per sq. in. on **Full Diam.**

| Size | T. S. | Shear | Size | T. S. | Shear |
|----------------|--------|--------|----------------|---------|---------|
| $\frac{1}{4}$ | 216 | 392 | $1\frac{3}{4}$ | 17,460 | 19,240 |
| $\frac{5}{16}$ | 450 | 608 | $1\frac{7}{8}$ | 20,510 | 22,088 |
| $\frac{3}{8}$ | 680 | 880 | 2 | 23,020 | 25,136 |
| $\frac{7}{16}$ | 930 | 1,200 | $2\frac{1}{4}$ | 30,230 | 31,808 |
| $\frac{1}{2}$ | 1,260 | 1,568 | $2\frac{1}{2}$ | 37,190 | 39,272 |
| $\frac{9}{16}$ | 1,620 | 1,984 | $2\frac{3}{4}$ | 46,200 | 47,520 |
| $\frac{5}{8}$ | 2,020 | 2,456 | 3 | 54,280 | 56,552 |
| $\frac{3}{4}$ | 3,020 | 3,536 | $3\frac{1}{4}$ | 65,100 | 66,368 |
| $\frac{7}{8}$ | 4,200 | 4,808 | $3\frac{1}{2}$ | 75,480 | 76,968 |
| 1 | 5,500 | 6,680 | $3\frac{3}{4}$ | 86,410 | 88,360 |
| $1\frac{1}{8}$ | 6,940 | 7,952 | 4 | 99,630 | 100,528 |
| $1\frac{1}{4}$ | 8,920 | 9,816 | $4\frac{1}{4}$ | 113,400 | 113,488 |
| $1\frac{3}{8}$ | 10,570 | 11,880 | $4\frac{1}{2}$ | 127,750 | 127,232 |
| $1\frac{1}{2}$ | 12,950 | 14,136 | $4\frac{3}{4}$ | 142,150 | 141,768 |
| $1\frac{5}{8}$ | 15,150 | 16,592 | 5 | 157,600 | 157,080 |

Tensile Stress at 10,000 lbs. per sq. in. at **Root of "V" Thread.**





| Size | Area at Root of Thread | T. S. | Size | Area at Root of Thread | T. S. |
|----------------|------------------------|--------|----------------|------------------------|---------|
| $\frac{1}{4}$ | .021 | 210 | $1\frac{3}{4}$ | 1.547 | 15,470 |
| $\frac{5}{16}$ | .036 | 360 | $1\frac{7}{8}$ | 1.744 | 17,440 |
| $\frac{3}{8}$ | .056 | 560 | 2 | 2.051 | 20,510 |
| $\frac{7}{16}$ | .077 | 770 | $2\frac{1}{4}$ | 2.746 | 27,460 |
| $\frac{1}{2}$ | .099 | 990 | $2\frac{1}{2}$ | 3.365 | 33,650 |
| $\frac{9}{16}$ | .137 | 1,370 | $2\frac{3}{4}$ | 4.227 | 42,270 |
| $\frac{5}{8}$ | .172 | 1,720 | 3 | 4.948 | 49,480 |
| $\frac{3}{4}$ | .261 | 2,610 | $3\frac{1}{4}$ | 5.983 | 59,830 |
| $\frac{7}{8}$ | .366 | 3,660 | $3\frac{1}{2}$ | 6.928 | 69,280 |
| 1 | .481 | 4,810 | $3\frac{3}{4}$ | 7.892 | 78,920 |
| $1\frac{1}{8}$ | .605 | 6,050 | 4 | 9.186 | 91,860 |
| $1\frac{1}{4}$ | .786 | 7,860 | $4\frac{1}{4}$ | 10.460 | 104,600 |
| $1\frac{3}{8}$ | .926 | 9,260 | $4\frac{1}{2}$ | 11.760 | 117,600 |
| $1\frac{1}{2}$ | 1.152 | 11,520 | $4\frac{3}{4}$ | 13.140 | 131,400 |
| $1\frac{5}{8}$ | 1.284 | 12,840 | 5 | 14.590 | 145,900 |

For diameters at root of thread see following tables.

The following cuts and information relative to bolts, nuts, washers and weights of steel have been reproduced by permission of the Upson Nut Co.

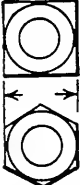
U. S. STANDARD THREADS, BOLTS, AND NUTS

The tap drill diameters in the table provide for a slight clearance at the root of the thread in order to facilitate tapping and reduce tap breakages. If full threads are required, use the diameters at the root of the threads for the tap drill diameters instead.

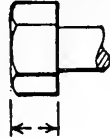
| Diam. of Bolt | No. of Th'ds Per Inch | Diam. at Root of Thread | Area in Sq. Inches | | Dimensions of Nuts and Bolt Heads | | | | |
|---------------|-----------------------|-------------------------|--------------------|----------------|---|---|---|---|--|
| | | | Of Bolt | At Rt. of Th'd |  |  |  |  |  |
| 1/4 | 20 | 0.185 | 0.049 | 0.027 | 1/2 | 0.578 | 0.707 | 1/4 | 1/4 |
| 5/16 | 18 | 0.240 | 0.076 | 0.045 | 9/32 | 0.686 | 0.840 | 5/16 | 1 9/16 |
| 3/8 | 16 | 0.294 | 0.110 | 0.068 | 1/2 | 0.794 | 0.972 | 3/8 | 1 3/2 |
| 7/16 | 14 | 0.345 | 0.150 | 0.093 | 25/32 | 0.902 | 1.105 | 7/16 | 2 5/4 |
| 1/2 | 13 | 0.400 | 0.196 | 0.126 | 7/8 | 1.011 | 1.237 | 1/2 | 2 6/4 |
| 9/16 | 12 | 0.454 | 0.248 | 0.162 | 33/32 | 1.119 | 1.370 | 9/16 | 7/16 |
| 5/8 | 11 | 0.507 | 0.307 | 0.202 | 1 1/16 | 1.227 | 1.502 | 5/8 | 3 1/4 |
| 3/4 | 10 | 0.620 | 0.442 | 0.302 | 1 1/4 | 1.444 | 1.768 | 3/4 | 3 6/4 |
| 7/8 | 9 | 0.731 | 0.601 | 0.419 | 1 7/16 | 1.660 | 2.033 | 7/8 | 1 7/2 |
| 1 | 8 | 0.838 | 0.785 | 0.551 | 1 5/8 | 1.877 | 2.298 | 1 | 1 5/8 |
| 1 1/8 | 7 | 0.939 | 0.994 | 0.694 | 1 11/16 | 2.093 | 2.563 | 1 1/8 | 2 3/2 |
| 1 1/4 | 7 | 1.064 | 1.227 | 0.893 | 2 | 2.310 | 2.828 | 1 1/4 | 1 |
| 1 3/8 | 6 | 1.158 | 1.485 | 1.057 | 2 3/16 | 2.527 | 3.093 | 1 3/8 | 1 3/2 |
| 1 1/2 | 6 | 1.283 | 1.767 | 1.295 | 2 3/8 | 2.743 | 3.358 | 1 1/2 | 1 3/8 |
| 1 5/8 | 5 1/2 | 1.389 | 2.074 | 1.515 | 2 9/16 | 2.960 | 3.623 | 1 5/8 | 1 9/2 |
| 1 3/4 | 5 | 1.490 | 2.405 | 1.746 | 2 3/4 | 3.176 | 3.889 | 1 3/4 | 1 3/8 |
| 1 7/8 | 5 | 1.615 | 2.781 | 2.051 | 2 11/16 | 3.393 | 4.154 | 1 7/8 | 1 1/2 |
| 2 | 4 1/2 | 1.711 | 3.142 | 2.302 | 3 1/8 | 3.609 | 4.419 | 2 | 1 9/16 |
| 2 1/4 | 4 1/2 | 1.961 | 3.976 | 3.023 | 3 1/2 | 4.043 | 4.949 | 2 1/4 | 1 3/4 |
| 2 1/2 | 4 | 2.175 | 4.909 | 3.719 | 3 7/8 | 4.476 | 5.479 | 2 1/2 | 1 1/2 |
| 2 3/4 | 4 | 2.425 | 5.940 | 4.620 | 4 1/4 | 4.909 | 6.010 | 2 3/4 | 2 1/8 |
| 3 | 3 1/2 | 2.629 | 7.069 | 5.428 | 4 5/8 | 5.342 | 6.540 | 3 | 2 5/16 |
| 3 1/4 | 3 1/2 | 2.879 | 8.296 | 6.510 | 5 | 5.775 | 7.070 | 3 1/4 | 2 1/2 |
| 3 1/2 | 3 1/4 | 3.100 | 9.621 | 7.548 | 5 3/8 | 6.208 | 7.600 | 3 1/2 | 2 1/16 |
| 3 3/4 | 3 | 3.317 | 11.045 | 8.641 | 5 3/4 | 6.641 | 8.131 | 3 3/4 | 2 7/8 |
| 4 | 3 | 3.567 | 12.566 | 9.963 | 6 1/8 | 7.074 | 8.661 | 4 | 3 1/16 |
| 4 1/4 | 2 7/8 | 3.798 | 14.186 | 11.340 | 6 1/2 | 7.508 | 9.191 | 4 1/4 | 3 1/4 |
| 4 1/2 | 2 3/4 | 4.028 | 15.904 | 12.750 | 6 7/8 | 7.941 | 9.721 | 4 1/2 | 3 7/16 |
| 4 3/4 | 2 5/8 | 4.255 | 17.721 | 14.215 | 7 1/4 | 8.374 | 10.252 | 4 3/4 | 3 5/8 |
| 5 | 2 1/2 | 4.480 | 19.635 | 15.760 | 7 5/8 | 8.807 | 10.782 | 5 | 3 1/16 |

Forms and Dimensions of Threads

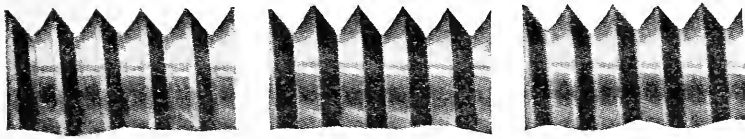

| Diam. Inches | United States Standard | | | V Standard | | Whitworth Standard | | | S. A. E. & A. L. A. M. | |
|--------------|------------------------|-------------------------|---------------|------------------|-------------------------|--------------------|-------------------------|-------------|------------------------|-------------------------|
| | Threads per Inch | Diam. at Root of Thread | Width of Flat | Threads per Inch | Diam. at Root of Thread | Threads per Inch | Diam. at Root of Thread | Radius Inch | Threads per Inch | Diam. at Root of Thread |
| 1/4 | 20 | .185 | .0062 | 20 | .163 | 20 | .186 | .0069 | 28 | .2036 |
| 5/16 | 18 | .240 | .0069 | 18 | .216 | 18 | .241 | .0076 | 24 | .2584 |
| 3/8 | 16 | .294 | .0078 | 16 | .267 | 16 | .295 | .0086 | 24 | .3269 |
| 7/16 | 14 | .345 | .0089 | 14 | .314 | 14 | .346 | .0098 | 20 | .3726 |
| 1/2 | 13 | .400 | .0096 | 12 | .356 | 12 | .393 | .0114 | 20 | .4351 |
| 9/16 | 12 | .454 | .0104 | 12 | .418 | 12 | .456 | .0114 | 18 | .4903 |
| 5/8 | 11 | .507 | .0114 | 11 | .468 | 11 | .508 | .0125 | 18 | .5528 |
| 11/16 | .. | ... | | ... | | .. | ... | | 16 | .6063 |
| 3/4 | 10 | .620 | .0125 | 10 | .577 | 10 | .622 | .0137 | 16 | .6688 |
| 7/8 | 9 | .731 | .0139 | 9 | .683 | 9 | .732 | .0152 | 14 | .7822 |
| 1 | 8 | .838 | .0156 | 8 | .783 | 8 | .840 | .0176 | 12 | .8918 |
| 1 1/8 | .. | ... | | .. | | .. | ... | | 14 | .9072 |
| 1 1/4 | 7 | .939 | .0179 | 7 | .878 | 7 | .942 | .0196 | 12 | 1.0168 |
| 1 1/2 | 7 | 1.064 | .0179 | 7 | 1.003 | 7 | 1.067 | .0196 | 12 | 1.1418 |
| 1 3/8 | 6 | 1.159 | .0208 | 6 | 1.086 | 6 | 1.161 | .0229 | 12 | 1.2668 |
| 1 1/2 | 6 | 1.284 | .0208 | 6 | 1.211 | 6 | 1.286 | .0229 | 12 | 1.3918 |
| 1 5/8 | 5 1/2 | 1.389 | .0227 | 5 | 1.279 | 5 | 1.368 | .0275 | .. | |
| 1 3/4 | 5 | 1.490 | .0250 | 5 | 1.404 | 5 | 1.494 | .0275 | .. | |
| 1 7/8 | 5 | 1.615 | .0250 | 4 1/2 | 1.490 | 4 1/2 | 1.590 | .0305 | .. | |
| 2 | 4 1/2 | 1.711 | .0278 | 4 1/2 | 1.616 | 4 1/2 | 1.715 | .0305 | .. | |
| 2 1/4 | 4 1/2 | 1.961 | .0278 | 4 1/2 | 1.87 | 4 | 1.930 | .0343 | .. | |
| 2 1/2 | 4 | 2.175 | .0313 | 4 | 2.07 | 4 | 2.180 | .0343 | .. | |
| 2 3/4 | 4 | 2.425 | .0313 | 4 | 2.32 | 3 1/2 | 2.384 | .0393 | .. | |
| 3 | 3 1/2 | 2.629 | .0357 | 3 1/2 | 2.51 | 3 1/2 | 2.634 | .0393 | .. | |
| 3 1/4 | 3 1/2 | 2.879 | .0357 | 3 1/2 | 2.76 | 3 1/4 | 2.856 | .0422 | .. | |
| 3 1/2 | 3 1/4 | 3.100 | .0385 | 3 1/4 | 2.97 | 3 1/4 | 3.105 | .0422 | .. | |
| 3 3/4 | 3 | 3.317 | .0417 | 3 | 3.17 | 3 | 3.320 | .0458 | .. | |
| 4 | 3 | 3.567 | .0417 | 3 | 3.42 | 3 | 3.573 | .0458 | .. | |

S. A. E. (Society of Automobile Engineers) Standard and A. L. A. M. (Association of Licensed Automobile Manufacturers) Standard threads are same angle and shape as United States Standard, differing only in number of threads per inch.

United States Standard Thread

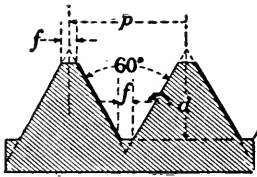

Formula {

$$p = \text{pitch} = \frac{1}{\text{No. threads per inch}}$$

$$d = \text{depth} = p \times .64952$$

$$f = \text{flat} = \frac{p}{8}$$

Sharp "V" Thread

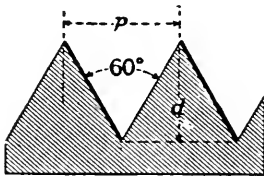

Formula {

$$p = \text{pitch} = \frac{1}{\text{No. threads per inch}}$$

$$d = \text{depth} = p \times .86603$$

Whitworth Standard Thread

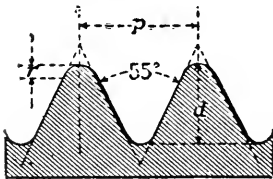

Formula {

$$p = \text{pitch} = \frac{1}{\text{No. threads per inch}}$$

$$d = \text{depth} = p \times .64033$$

$$b = \text{radius} = p \times .1373$$

Acme Standard Screw Thread

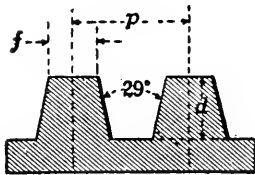

Formula {

$$p = \text{pitch} = \frac{1}{\text{No. threads per inch}}$$

$$d = \text{depth} = \frac{1}{2}p + .010$$

$$b = \text{flat on top of thread} = p \times .3707$$

Cast Washers

Government (O. G.) Standard

| Diameter Inches | Hole Inches | Thickness Inches | Bolt Inches | Weight Pounds |
|-----------------|-------------|------------------|-------------|---------------|
| 2¼ | 5/8 | 11/16 | ½ | ½ |
| 2¾ | ¾ | ¾ | 5/8 | 5/8 |
| 3 | 7/8 | 13/16 | ¾ | ¾ |
| 3½ | 1 | 7/8 | 7/8 | 1¼ |
| 4 | 1 1/8 | 15/16 | 1 | 1 3/8 |
| 4½ | 1¼ | 1 | 1 1/8 | 2¼ |
| 5 | 1 3/8 | 1 1/8 | 1¼ | 3 |
| 6 | 1 3/4 | 1 1/4 | 1 1/2 | 5 |

Standard Wrought Washers

U. S. Standard Sizes

In effect January 20, 1910

| Diameter Inches | Hole Inches | Thickness of Wire Gauge (Birmingham) No | Bolt Inches | Price per Lb. in 200 Lb. Kegs Cents | Number in 100 Pound | Weight per 1,000 Pieces Pounds |
|-----------------|-------------|---|-------------|-------------------------------------|---------------------|--------------------------------|
| 9/16 | ¼ | 18 | 3/16 | 14. | 39 400 | 2 53 |
| ¾ | 5/16 | 16 | ¼ | 12.2 | 15 600 | 6.4 |
| 7/8 | 3/8 | 16 | 5/16 | 11.4 | 11,250 | 8 8 |
| 1 | 7/16 | 14 | 3/8 | 10.5 | 6 800 | 14.7 |
| 1¼ | 1/2 | 14 | 7/16 | 9.8 | 4,300 | 21. |
| 1 3/8 | 9/16 | 12 | ½ | 9.4 | 2,600 | 38.4 |
| 1½ | 5/8 | 12 | 9/16 | 9.3 | 2,250 | 44.4 |
| 1¾ | 11/16 | 10 | 5/8 | 9.2 | 1,300 | 77. |
| 2 | 13/16 | 9 | ¾ | 9.1 | 900 | 111. |
| 2¼ | 15/16 | 8 | 7/8 | 9. | 782 | 153. |
| 2½ | 1 1/16 | 8 | 1 | 9. | 568 | 176. |
| 2¾ | 1¼ | 8 | 1 1/8 | 9. | 473 | 211. |
| 3 | 1 3/8 | 8 | 1¼ | 9.2 | 364 | 261. |
| 3¼ | 1½ | 7 | 1 3/8 | 9.2 | 275 | 364. |
| 3½ | 1 5/8 | 7 | 1½ | 9.2 | 156 | 390. |
| 3¾ | 1¾ | 7 | 1 5/8 | 9.5 | 220 | 454. |
| 4 | 1 7/8 | 7 | 1¾ | 9.5 | 197 | 508. |
| 4¼ | 2 | 7 | 1 3/4 | 9.5 | 174 | 575. |
| 4½ | 2 1/8 | 7 | 2 | 9.5 | 160 | 625. |
| 4¾ | 2 3/8 | 5 | 2¼ | 10.5 | 122 | 820. |
| 5 | 2 5/8 | 4 | 2½ | 10.5 | 106 | 943. |

Weights of Round, Square and Hexagon Steel

Weight of one Cubic Inch = .2836 lbs.

Weight of one Cubic Foot = 490 lbs.

| Thick- ness or Diameter | Round | Square | Hexagon | Thick- ness or Diameter | Round | Square | Hexagon |
|-------------------------------|-----------------------|-----------------------|-----------------------|-------------------------------|-----------------------|-----------------------|-----------------------|
| | Weight per Inch | Weight per Inch | Weight per Inch | | Weight per Inch | Weight per Inch | Weight per Inch |
| $\frac{1}{32}$ | .0002 | .0003 | .0002 | $1\frac{1}{8}$ | .7831 | .9970 | .8635 |
| $\frac{1}{16}$ | .0009 | .0011 | .0010 | $1\frac{1}{8}$ | .8361 | 1.0646 | .9220 |
| $\frac{3}{32}$ | .0020 | .0025 | .0022 | 2 | .8910 | 1.1342 | .9825 |
| $\frac{1}{8}$ | .0035 | .0044 | .0038 | $2\frac{1}{16}$ | .9475 | 1.2064 | 1.0448 |
| $\frac{5}{32}$ | .0054 | .0069 | .0060 | $2\frac{1}{8}$ | 1.0058 | 1.2806 | 1.1091 |
| $\frac{3}{16}$ | .0078 | .0101 | .0086 | $2\frac{3}{16}$ | 1.0658 | 1.3570 | 1.1753 |
| $\frac{7}{32}$ | .0107 | .0136 | .0118 | $2\frac{1}{4}$ | 1.1276 | 1.4357 | 1.2434 |
| $\frac{1}{4}$ | .0139 | .0177 | .0154 | $2\frac{5}{16}$ | 1.1911 | 1.5165 | 1.3135 |
| $\frac{9}{32}$ | .0176 | .0224 | .0194 | $2\frac{3}{8}$ | 1.2564 | 1.6569 | 1.3854 |
| $\frac{5}{16}$ | .0218 | .0277 | .0240 | $2\frac{7}{16}$ | 1.3234 | 1.6849 | 1.4593 |
| $\frac{11}{32}$ | .0263 | .0335 | .0290 | $2\frac{1}{2}$ | 1.3921 | 1.7724 | 1.5351 |
| $\frac{3}{8}$ | .0313 | .0405 | .0345 | $2\frac{5}{8}$ | 1.5348 | 1.9541 | 1.6924 |
| $\frac{13}{32}$ | .0368 | .0466 | .0405 | $2\frac{3}{4}$ | 1.6845 | 2.1446 | 1.8574 |
| $\frac{7}{16}$ | .0426 | .0543 | .0470 | $2\frac{7}{8}$ | 1.8411 | 2.3441 | 2.0304 |
| $\frac{15}{32}$ | .0489 | .0623 | .0540 | 3 | 2.0046 | 2.5548 | 2.2105 |
| $\frac{1}{2}$ | .0557 | .0709 | .0614 | $3\frac{1}{8}$ | 2.1752 | 2.7719 | 2.3986 |
| $\frac{17}{32}$ | .0629 | .0800 | .0693 | $3\frac{1}{4}$ | 2.3527 | 2.9954 | 2.5918 |
| $\frac{9}{16}$ | .0705 | .0897 | .0777 | $3\frac{3}{8}$ | 2.5371 | 3.2303 | 2.7977 |
| $\frac{19}{32}$ | .0785 | .1036 | .0866 | $3\frac{1}{2}$ | 2.7286 | 3.4740 | 3.0083 |
| $\frac{5}{8}$ | .0870 | .1108 | .0959 | $3\frac{5}{8}$ | 2.9269 | 3.7265 | 3.2275 |
| $\frac{21}{32}$ | .0959 | .1221 | .1058 | $3\frac{3}{4}$ | 3.1323 | 3.9880 | 3.4539 |
| $\frac{11}{16}$ | .1053 | .1340 | .1161 | $3\frac{7}{8}$ | 3.3446 | 4.2582 | 3.6880 |
| $\frac{23}{32}$ | .1151 | .1465 | .1270 | 4 | 3.5638 | 4.5374 | 3.9298 |
| $\frac{3}{4}$ | .1253 | .1622 | .1382 | $4\frac{1}{8}$ | 3.7900 | 4.8254 | 4.1792 |
| $\frac{25}{32}$ | .1359 | .1732 | .1499 | $4\frac{1}{4}$ | 4.0232 | 5.1223 | 4.4364 |
| $\frac{13}{16}$ | .1470 | .1872 | .1620 | $4\frac{3}{8}$ | 4.2634 | 5.4280 | 4.7011 |
| $\frac{27}{32}$ | .1586 | .2019 | .1749 | $4\frac{1}{2}$ | 4.5105 | 5.7426 | 4.9736 |
| $\frac{7}{8}$ | .1705 | .2171 | .1880 | $4\frac{5}{8}$ | 4.7645 | 6.0662 | 5.2538 |
| $\frac{29}{32}$ | .1829 | .2329 | .2015 | $4\frac{3}{4}$ | 5.0255 | 6.6276 | 5.5416 |
| $\frac{15}{16}$ | .1958 | .2492 | .2159 | $4\frac{7}{8}$ | 5.2935 | 6.7397 | 5.8371 |
| $\frac{31}{32}$ | .2090 | .2661 | .2305 | 5 | 5.5685 | 7.0897 | 6.1403 |
| 1 | .2227 | .2836 | .2456 | $5\frac{1}{8}$ | 5.8504 | 7.4496 | 6.4511 |
| $1\frac{1}{16}$ | .2515 | .3201 | .2773 | $5\frac{1}{4}$ | 6.1392 | 7.8164 | 6.7697 |
| $1\frac{1}{8}$ | .2819 | .3589 | .3109 | $5\frac{3}{8}$ | 6.4351 | 8.1930 | 7.0959 |
| $1\frac{3}{16}$ | .3141 | .4142 | .3464 | $5\frac{1}{2}$ | 6.7379 | 8.5786 | 7.4298 |
| $1\frac{1}{4}$ | .3480 | .4431 | .3838 | $5\frac{5}{8}$ | 7.0476 | 8.9729 | 7.7713 |
| $1\frac{5}{16}$ | .3837 | .4885 | .4231 | $5\frac{3}{4}$ | 7.3643 | 9.3762 | 8.1214 |
| $1\frac{3}{8}$ | .4211 | .5362 | .4643 | $5\frac{7}{8}$ | 7.6880 | 9.7883 | 8.4774 |
| $1\frac{7}{16}$ | .4603 | .5860 | .5076 | 6 | 8.0186 | 10.2192 | 8.8420 |
| $1\frac{1}{2}$ | .5012 | .6487 | .5526 | $6\frac{1}{4}$ | 8.7007 | 11.0877 | 9.5943 |
| $1\frac{9}{16}$ | .5438 | .6930 | .5996 | $6\frac{1}{2}$ | 9.4107 | 11.9817 | 10.3673 |
| $1\frac{5}{8}$ | .5882 | .7489 | .6480 | $6\frac{3}{4}$ | 10.1485 | 12.9211 | 11.1908 |
| $1\frac{11}{16}$ | .6343 | .8076 | .6994 | 7 | 10.9142 | 13.8960 | 12.0351 |
| $1\frac{3}{4}$ | .6821 | .8685 | .7521 | $7\frac{1}{2}$ | 12.5291 | 15.9520 | 13.8158 |
| $1\frac{13}{16}$ | .7317 | .9316 | .8069 | 8 | 14.2553 | 18.1497 | 15.7192 |

Multiply above weights by 1.125 for high speed steel, .993 for wrought iron, .918 for cast iron 1.0331 for cast brass, 1.1209 for copper, and 1.1748 for phosphor bronze.

Formula of Standard Studs

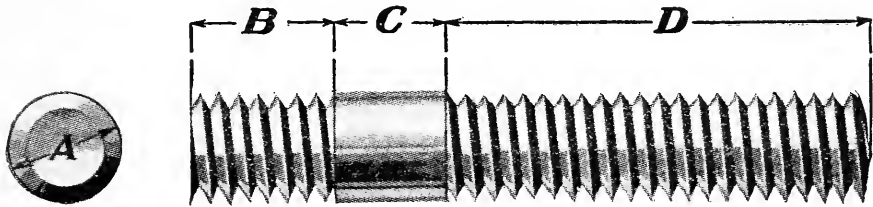

- A = Diameter of Stud
- B = $A + \frac{1}{8}$ in.
- C = A
- D = Whole length of Stud — (B + C)

Thread on B is steam tight unless otherwise ordered
 Studs furnished in either U. S. Standard or V Threads

The following information on pipe thread, pipe and boiler tubes has been taken, by permission, from Crane Company's catalogue.

LENGTH OF THREAD ON PIPE THAT IS SCREWED INTO VALVES OR FITTINGS TO MAKE A TIGHT JOINT

Dimensions given do not allow for variation in tapping or threading

| Size Inches | Dimension A Inches | Size Inches | Dimension A Inches |
|----------------|--------------------------|----------------|--------------------------|
| $\frac{1}{8}$ | $\frac{1}{4}$ | $3\frac{1}{2}$ | $1\frac{1}{16}$ |
| $\frac{1}{4}$ | $\frac{3}{8}$ | 4 | $1\frac{1}{16}$ |
| $\frac{3}{8}$ | $\frac{3}{8}$ | $4\frac{1}{2}$ | $1\frac{1}{8}$ |
| $\frac{1}{2}$ | $\frac{1}{2}$ | 5 | $1\frac{3}{16}$ |
| $\frac{3}{4}$ | $\frac{1}{2}$ | 6 | $1\frac{1}{4}$ |
| 1 | $\frac{9}{16}$ | 7 | $1\frac{1}{4}$ |
| $1\frac{1}{4}$ | $\frac{5}{8}$ | 8 | $1\frac{5}{16}$ |
| $1\frac{1}{2}$ | $\frac{5}{8}$ | 9 | $1\frac{3}{8}$ |
| 2 | $\frac{11}{16}$ | 10 | $1\frac{1}{2}$ |
| $2\frac{1}{2}$ | $\frac{15}{16}$ | 12 | $1\frac{5}{8}$ |
| 3 | 1 | | |

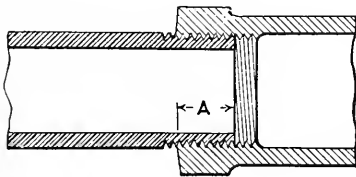

AMERICAN BRIGGS STANDARD FOR TAPER AND STRAIGHT PIPE THREADS AND LOCK-NUT THREADS

ADOPTED BY THE COMMITTEE OF MANUFACTURERS ON STANDARDIZATION OF FITTINGS AND VALVES AND THE AMERICAN SOCIETY OF AMERICAN ENGINEERS
SEPTEMBER 17, 1913

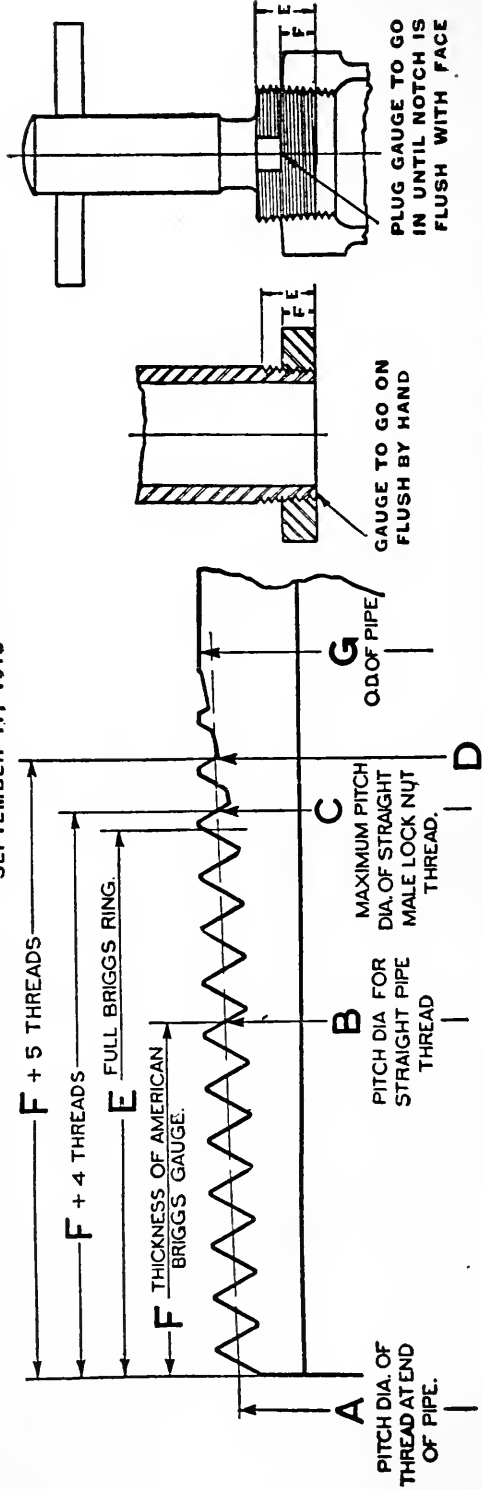

ALLOWABLE VARIATIONS ARE: ONE THREAD LARGE OR SMALL

- A equals $G - (0.05G + 1.9) \times \frac{1}{N} + \frac{0.8}{N}$
- B equals $A + (F \times 0.0625)$
- C equals $B + (\frac{4}{N} \times 0.0625)$
- D equals $B + (\frac{5}{N} \times 0.0625)$

- E equals $(0.8G + 4.8) \times \frac{1}{N} + \frac{2}{N}$
- F equals American Briggs Standard.
- N equals Number of threads per inch.
- Total Taper $\frac{3}{4}$ inch per foot.
- Depth of Thread $\frac{0.8}{N}$

PIPE THREADS

| Size | A | B | C | D | E | F | G | Depth of Thread | Threads per Inch |
|----------------|----------|----------|----------|----------|--------|-------|--------|-----------------|------------------|
| $\frac{1}{8}$ | .36350 | .37475 | .38400 | .38632 | .2638 | .180 | .405 | .02962 | 27 |
| $\frac{1}{4}$ | .47739 | .48989 | .50378 | .50725 | .4018 | .200 | .540 | .04444 | 18 |
| $\frac{3}{8}$ | .61201 | .62701 | .64090 | .64437 | .4078 | .240 | .675 | .04444 | 18 |
| $\frac{1}{2}$ | .75843 | .77843 | .79628 | .80075 | .5337 | .320 | .840 | .05714 | 14 |
| $\frac{3}{4}$ | .96768 | .98886 | 1.00671 | 1.01118 | .5457 | .339 | 1.050 | .05714 | 14 |
| 1 | 1.21363 | 1.23863 | 1.26036 | 1.26580 | .6828 | .400 | 1.315 | .06956 | $11\frac{1}{2}$ |
| $1\frac{1}{4}$ | 1.55713 | 1.58338 | 1.60511 | 1.61055 | .7068 | .420 | 1.660 | .06956 | $11\frac{1}{2}$ |
| $1\frac{1}{2}$ | 1.79609 | 1.82234 | 1.84407 | 1.84951 | .7235 | .420 | 1.900 | .06956 | $11\frac{1}{2}$ |
| 2 | 2.26902 | 2.29627 | 2.31801 | 2.32344 | .7565 | .436 | 2.375 | .06956 | $11\frac{1}{2}$ |
| $2\frac{1}{2}$ | 2.71954 | 2.76216 | 2.79341 | 2.80122 | 1.1375 | .682 | 2.875 | .100 | 8 |
| 3 | 3.34063 | 3.38850 | 3.41975 | 3.42756 | 1.2000 | .766 | 3.500 | .100 | 8 |
| $3\frac{1}{2}$ | 3.83750 | 3.88881 | 3.92006 | 3.92787 | 1.2500 | .821 | 4.000 | .100 | 8 |
| 4 | 4.33438 | 4.38713 | 4.41838 | 4.42619 | 1.3000 | .844 | 4.500 | .100 | 8 |
| $4\frac{1}{2}$ | 4.83125 | 4.88593 | 4.91718 | 4.92499 | 1.3500 | .875 | 5.000 | .100 | 8 |
| 5 | 5.39074 | 5.44930 | 5.48055 | 5.48836 | 1.4063 | .937 | 5.563 | .100 | 8 |
| 6 | 6.44610 | 6.50597 | 6.53722 | 6.54503 | 1.5125 | .958 | 6.625 | .100 | 8 |
| 7 | 7.43985 | 7.50235 | 7.53360 | 7.54141 | 1.6125 | 1.000 | 7.625 | .100 | 8 |
| 8 | 8.43360 | 8.50003 | 8.53128 | 8.53909 | 1.7125 | 1.063 | 8.625 | .100 | 8 |
| 9 | 9.42735 | 9.49797 | 9.52922 | 9.53703 | 1.8125 | 1.130 | 9.625 | .100 | 8 |
| 10 | 10.54532 | 10.62094 | 10.65219 | 10.66000 | 1.9250 | 1.210 | 10.750 | .100 | 8 |
| 11 | 11.53907 | 11.61938 | 11.65063 | 11.65844 | 2.0250 | 1.285 | 11.750 | .100 | 8 |
| 12 | 12.53282 | 12.61782 | 12.64907 | 12.65688 | 2.1250 | 1.360 | 12.750 | .100 | 8 |
| 14 O. D. | 13.7750 | 13.87262 | 13.90387 | 13.91168 | 2.250 | 1.562 | 14.00 | .100 | 8 |
| 15 O. D. | 14.76875 | 14.87418 | 14.90543 | 14.91324 | 2.350 | 1.687 | 15.00 | .100 | 8 |
| 16 O. D. | 15.76250 | 15.87575 | 15.90700 | 15.91481 | 2.450 | 1.812 | 16.00 | .100 | 8 |
| 17 O. D. | 16.75625 | 16.87500 | 16.90625 | 16.91406 | 2.550 | 1.900 | 17.00 | .100 | 8 |
| 18 O. D. | 17.7500 | 17.87500 | 17.90625 | 17.91406 | 2.650 | 2.000 | 18.00 | .100 | 8 |
| 20 O. D. | 19.73750 | 19.87031 | 19.90156 | 19.90937 | 2.850 | 2.125 | 20.00 | .100 | 8 |
| 22 O. D. | 21.72500 | 21.86562 | 21.89687 | 21.90468 | 3.050 | 2.250 | 22.00 | .100 | 8 |
| 24 O. D. | 23.71250 | 23.86093 | 23.89218 | 23.89999 | 3.250 | 2.375 | 24.00 | .100 | 8 |

STANDARD WROUGHT PIPE — TABLE OF STANDARD DIMENSIONS

| Size Inches | DIAMETERS | | Nominal Thickness Inches | CIRCUMFERENCE | | TRANSVERSE AREAS | | | LENGTH OF PIPE PER SQUARE FOOT OF | | Length of Pipe Containing One Cubic Foot Feet | NOMINAL WEIGHT PER FOOT | | Number of Threads Per Inch of Screw |
|----------------|--------------------|--------------------------------|-----------------------------|--------------------|--------------------|----------------------|----------------------|-------------------|-----------------------------------|--------------------------|--|-------------------------|----------------------|-------------------------------------|
| | External Inches | Approximate Internal Inches | | External Inches | Internal Inches | External Sq. Ins. | Internal Sq. Ins. | Metal Sq. Ins. | External Surface Feet | Internal Surface Feet | | Plain Ends | Threaded and Coupled | |
| 1/8 | .405 | .269 | .068 | 1.272 | .845 | .129 | .057 | .072 | 9.431 | 14.199 | 2533.775 | .244 | .245 | 27 |
| 1/4 | .540 | .364 | .088 | 1.696 | 1.144 | .229 | .104 | .125 | 7.073 | 10.493 | 1383.789 | .424 | .425 | 18 |
| 3/8 | .675 | .493 | .091 | 2.121 | 1.549 | .358 | .191 | .167 | 5.658 | 7.747 | 754.360 | .567 | .568 | 18 |
| 1/2 | .840 | .622 | .109 | 2.639 | 1.954 | .554 | .304 | .250 | 4.547 | 6.141 | 473.906 | .850 | .852 | 14 |
| 3/4 | 1.050 | .824 | .113 | 3.299 | 2.589 | .866 | .533 | .333 | 3.637 | 4.635 | 270.034 | 1.130 | 1.134 | 14 |
| 1 | 1.315 | 1.049 | .133 | 4.131 | 3.296 | 1.358 | .864 | .494 | 2.904 | 3.641 | 166.618 | 1.678 | 1.684 | 11 1/2 |
| 1 1/4 | 1.660 | 1.380 | .140 | 5.215 | 4.335 | 2.164 | 1.495 | .669 | 2.301 | 2.767 | 96.275 | 2.272 | 2.281 | 11 1/2 |
| 1 1/2 | 1.900 | 1.610 | .145 | 5.969 | 5.058 | 2.835 | 2.036 | .799 | 2.010 | 2.372 | 70.733 | 2.717 | 2.731 | 11 1/2 |
| 2 | 2.375 | 2.067 | .154 | 7.461 | 6.494 | 4.430 | 3.355 | 1.075 | 1.608 | 1.847 | 42.913 | 3.652 | 3.678 | 11 1/2 |
| 2 1/2 | 2.875 | 2.469 | .203 | 9.032 | 7.757 | 6.492 | 4.788 | 1.704 | 1.328 | 1.547 | 30.077 | 5.793 | 5.819 | 8 |
| 3 | 3.068 | 3.068 | .216 | 10.996 | 9.638 | 9.621 | 7.393 | 2.228 | 1.091 | 1.245 | 19.479 | 7.575 | 7.616 | 8 |
| 3 1/2 | 3.548 | 3.548 | .226 | 12.566 | 11.146 | 12.566 | 9.886 | 2.680 | .954 | 1.076 | 14.565 | 9.109 | 9.202 | 8 |
| 4 | 4.026 | 4.026 | .237 | 14.137 | 12.648 | 15.904 | 12.730 | 3.174 | .848 | .948 | 11.312 | 10.790 | 10.889 | 8 |
| 4 1/2 | 4.506 | 4.506 | .247 | 15.708 | 14.156 | 19.635 | 15.947 | 3.688 | .763 | .847 | 9.030 | 12.538 | 12.642 | 8 |
| 5 | 5.047 | 5.047 | .258 | 17.477 | 15.856 | 24.306 | 20.006 | 4.300 | .686 | .756 | 7.198 | 14.617 | 14.810 | 8 |
| 6 | 6.625 | 6.065 | .280 | 20.813 | 19.054 | 34.472 | 28.891 | 5.581 | .576 | .629 | 4.984 | 18.974 | 19.185 | 8 |
| 7 | 7.625 | 7.023 | .301 | 23.955 | 22.063 | 45.664 | 38.738 | 6.926 | .500 | .543 | 3.717 | 23.544 | 23.769 | 8 |
| 8 | 8.625 | 8.071 | .277 | 27.096 | 25.356 | 58.426 | 51.161 | 7.265 | .442 | .473 | 2.815 | 24.696 | 25.000 | 8 |
| 8 | 8.625 | 7.981 | .322 | 27.096 | 25.073 | 58.426 | 50.027 | 8.399 | .442 | .478 | 2.878 | 28.554 | 28.809 | 8 |
| 9 | 9.625 | 8.941 | .342 | 30.238 | 28.089 | 72.760 | 62.077 | 9.974 | .396 | .427 | 2.294 | 33.907 | 34.188 | 8 |
| 10 | 10.750 | 10.192 | .279 | 33.772 | 32.019 | 90.763 | 81.585 | 9.178 | .355 | .374 | 1.765 | 31.201 | 32.000 | 8 |
| 10 | 10.750 | 10.136 | .307 | 33.772 | 31.843 | 90.763 | 80.691 | 10.072 | .355 | .376 | 1.785 | 34.240 | 35.000 | 8 |
| 10 | 10.750 | 10.020 | .365 | 33.772 | 31.479 | 90.763 | 78.855 | 11.908 | .355 | .381 | 1.826 | 40.483 | 41.132 | 8 |
| 11 | 11.750 | 11.000 | .375 | 36.914 | 34.558 | 108.434 | 95.033 | 13.401 | .325 | .347 | 1.515 | 45.557 | 46.247 | 8 |
| 12 | 12.750 | 12.090 | .330 | 40.055 | 37.982 | 127.676 | 114.800 | 12.876 | .299 | .315 | 1.254 | 43.773 | 45.000 | 8 |
| 12 | 12.750 | 12.000 | .375 | 40.055 | 37.699 | 127.676 | 113.097 | 14.579 | .299 | .318 | 1.273 | 49.562 | 50.706 | 8 |

PIPE SIZES

EXTRA STRONG WROUGHT PIPE — TABLE OF STANDARD DIMENSIONS

| DIAMETER | | | Nominal Thickness Inches | CIRCUMFERENCE | | TRANSVERSE AREAS | | | LENGTH OF PIPE PER SQUARE FOOT OF | | Length of Pipe Containing One Cubic Foot Feet | Nominal Weight Per Foot Plain Ends Pounds |
|----------------------------|--------------------|---|-----------------------------|--------------------|--------------------|------------------------|------------------------|---------------------|-----------------------------------|-----------------------------|--|--|
| Nominal Internal Inches | External Inches | Approximate Internal Diameter Inches | | External Inches | Internal Inches | External Sq. Inches | Internal Sq. Inches | Metal Sq. Inches | External Surface Feet | Internal Surface Feet | | |
| 1 | .405 | .215 | .095 | 1.272 | .675 | .129 | .036 | .093 | 9.431 | 17.766 | 3966.392 | .314 |
| 1 1/4 | .540 | .302 | .119 | 1.696 | .949 | .229 | .072 | .157 | 7.073 | 12.648 | 2010.290 | .535 |
| 2 | .675 | .423 | .126 | 2.121 | 1.329 | .358 | .141 | .217 | 5.658 | 9.030 | 1024.689 | .788 |
| 2 1/2 | .840 | .546 | .147 | 2.639 | 1.715 | .554 | .234 | .320 | 4.547 | 6.995 | 615.017 | 1.087 |
| 3 | 1.050 | .742 | .154 | 3.299 | 2.331 | .866 | .433 | .433 | 3.637 | 5.147 | 333.016 | 1.473 |
| 3 1/2 | 1.315 | .957 | .179 | 4.131 | 3.007 | 1.358 | .719 | .639 | 2.904 | 3.991 | 200.193 | 2.171 |
| 4 | 1.660 | 1.278 | .191 | 5.215 | 4.015 | 2.164 | 1.283 | .881 | 2.301 | 2.988 | 112.256 | 2.996 |
| 4 1/2 | 1.900 | 1.500 | .200 | 5.969 | 4.712 | 2.835 | 1.767 | 1.068 | 2.010 | 2.546 | 81.487 | 3.631 |
| 5 | 2.375 | 1.939 | .218 | 7.461 | 6.092 | 4.430 | 2.953 | 1.477 | 1.608 | 1.969 | 48.766 | 5.022 |
| 5 1/2 | 2.875 | 2.323 | .276 | 9.032 | 7.298 | 6.492 | 4.238 | 2.254 | 1.328 | 1.644 | 33.976 | 7.661 |
| 6 | 3.500 | 2.900 | .300 | 10.996 | 9.111 | 9.621 | 6.605 | 3.016 | 1.091 | 1.317 | 21.801 | 10.252 |
| 6 1/2 | 4.000 | 3.364 | .318 | 12.566 | 10.568 | 12.566 | 8.888 | 3.678 | .954 | 1.135 | 16.202 | 12.505 |
| 7 | 4.500 | 3.826 | .337 | 14.137 | 12.020 | 15.504 | 11.497 | 4.407 | .848 | .998 | 12.525 | 14.983 |
| 7 1/2 | 5.000 | 4.290 | .355 | 15.708 | 13.477 | 19.635 | 14.455 | 5.180 | .763 | .890 | 9.962 | 17.611 |
| 8 | 5.563 | 4.813 | .375 | 17.477 | 15.120 | 24.306 | 18.194 | 6.112 | .686 | .793 | 7.915 | 20.778 |
| 8 1/2 | 6.625 | 5.761 | .432 | 20.813 | 18.099 | 34.472 | 26.067 | 8.405 | .576 | .663 | 5.524 | 28.573 |
| 9 | 7.625 | 6.625 | .500 | 23.955 | 20.813 | 45.664 | 34.472 | 11.192 | .500 | .576 | 4.177 | 38.048 |
| 9 1/2 | 8.625 | 7.625 | .500 | 27.096 | 23.955 | 58.426 | 45.663 | 12.763 | .442 | .500 | 3.154 | 43.388 |
| 10 | 9.625 | 8.625 | .500 | 30.238 | 27.096 | 72.760 | 58.426 | 14.334 | .396 | .442 | 2.464 | 48.728 |
| 10 1/2 | 10.750 | 9.750 | .500 | 33.772 | 30.631 | 90.763 | 74.662 | 16.101 | .355 | .391 | 1.929 | 54.735 |
| 11 | 11.750 | 10.750 | .500 | 36.914 | 33.772 | 108.434 | 90.763 | 17.671 | .325 | .355 | 1.587 | 60.075 |
| 12 | 12.750 | 11.750 | .500 | 40.055 | 36.914 | 127.676 | 108.434 | 19.242 | .299 | .325 | 1.328 | 65.415 |

DOUBLE EXTRA STRONG WROUGHT PIPE — TABLE OF STANDARD DIMENSIONS

| DIAMETER | | Nominal Thickness Inches | CIRCUMFERENCE | | TRANSVERSE AREAS | | | LENGTH OF PIPE PER SQUARE FOOT OF | | Length of Pipe Containing One Cubic Foot Feet | Nominal Weight Per Foot Plain Ends Pounds |
|----------------------------|--------------------|-----------------------------|---|--------------------|--------------------|------------------------|------------------------|-----------------------------------|-----------------------------|--|--|
| Nominal Internal Inches | External Inches | | Approximate Internal Diameter Inches | External Inches | Internal Inches | External Sq. Inches | Internal Sq. Inches | Metal Sq. Inches | External Surface Feet | | |
| $\frac{1}{2}$ | .840 | .294 | 2.639 | .792 | .554 | .050 | .504 | 4.547 | 15.157 | 2887.164 | 1.714 |
| $\frac{3}{4}$ | 1.050 | .308 | 3.299 | 1.363 | .866 | .148 | .718 | 3.637 | 8.801 | 973.404 | 2.440 |
| $\frac{1}{1}$ | 1.315 | .358 | 4.131 | 1.882 | 1.358 | .282 | 1.076 | 2.904 | 6.376 | 510.998 | 3.659 |
| $1\frac{1}{4}$ | 1.660 | .382 | 5.215 | 2.815 | 2.164 | .630 | 1.534 | 2.301 | 4.263 | 228.379 | 5.214 |
| $1\frac{1}{2}$ | 1.900 | .400 | 5.969 | 3.456 | 2.835 | .950 | 1.885 | 2.010 | 3.472 | 151.526 | 6.408 |
| 2 | 2.375 | .436 | 7.461 | 4.722 | 4.430 | 1.774 | 2.656 | 1.608 | 2.541 | 81.162 | 9.029 |
| $2\frac{1}{2}$ | 2.875 | .552 | 9.032 | 5.564 | 6.492 | 2.464 | 4.028 | 1.328 | 2.156 | 58.457 | 13.695 |
| 3 | 3.500 | .600 | 10.996 | 7.226 | 9.621 | 4.155 | 5.466 | 1.091 | 1.660 | 34.659 | 18.583 |
| $3\frac{1}{2}$ | 4.000 | .636 | 12.566 | 8.570 | 12.566 | 5.845 | 6.721 | .954 | 1.400 | 24.637 | 22.850 |
| 4 | 4.500 | .674 | 14.137 | 9.902 | 15.904 | 7.803 | 8.101 | .848 | 1.211 | 18.454 | 27.541 |
| $4\frac{1}{2}$ | 5.000 | .710 | 15.708 | 11.247 | 19.635 | 10.066 | 9.569 | .763 | 1.066 | 14.306 | 32.530 |
| 5 | 5.563 | .750 | 17.477 | 12.764 | 24.306 | 12.966 | 11.340 | .686 | .940 | 11.107 | 38.552 |
| 6 | 6.625 | .864 | 20.813 | 15.384 | 34.472 | 18.835 | 15.637 | .576 | .780 | 7.646 | 53.160 |
| 7 | 7.625 | .875 | 23.955 | 18.457 | 45.664 | 27.109 | 18.555 | .500 | .650 | 5.312 | 63.079 |
| 8 | 8.625 | .875 | 27.096 | 21.598 | 58.426 | 37.122 | 21.304 | .442 | .555 | 3.879 | 72.424 |

NOTE. — Sizes $3\frac{1}{2}$ inch and larger are made by telescoping.

BOILER TUBES

STANDARD BOILER TUBES — TABLE OF STANDARD DIMENSIONS

| DIAMETER | | Nominal Thickness | Nearest Wire Gauge | CIRCUMFERENCE | | TRANSVERSE AREAS | | | LENGTH OF TUBE PER SQUARE FOOT OF | | Nominal Weight per Foot |
|----------|----------|-------------------|--------------------|---------------|----------|------------------|------------|------------|-----------------------------------|------------------|-------------------------|
| | | | | External | Internal | External | Internal | Metal | External Surface | Internal Surface | |
| External | Internal | Inches | No. | Inches | Inches | Sq. Inches | Sq. Inches | Sq. Inches | Feet | Feet | Pounds |
| 1 1/4 | 1.560 | .095 | 13 | 5.498 | 4.901 | 2.405 | 1.911 | .494 | 2.182 | 2.448 | 1.679 |
| 2 | 1.810 | .095 | 13 | 6.283 | 5.686 | 3.142 | 2.573 | .569 | 1.909 | 2.110 | 1.932 |
| 2 1/4 | 2.060 | .095 | 13 | 7.069 | 6.472 | 3.976 | 3.333 | .643 | 1.697 | 1.854 | 2.186 |
| 2 1/2 | 2.282 | .109 | 12 | 7.854 | 7.169 | 4.909 | 4.090 | .819 | 1.527 | 1.673 | 2.783 |
| 2 3/4 | 2.532 | .109 | 12 | 8.639 | 7.955 | 5.940 | 5.036 | .904 | 1.388 | 1.508 | 3.074 |
| 3 | 2.782 | .109 | 12 | 9.425 | 8.740 | 7.069 | 6.079 | .990 | 1.273 | 1.373 | 3.365 |
| 3 1/4 | 3.010 | .120 | 11 | 10.210 | 9.456 | 8.296 | 7.116 | 1.180 | 1.175 | 1.269 | 4.011 |
| 3 1/2 | 3.260 | .120 | 11 | 10.996 | 10.242 | 9.621 | 8.347 | 1.274 | 1.091 | 1.171 | 4.331 |
| 3 3/4 | 3.510 | .120 | 11 | 11.781 | 11.027 | 11.045 | 9.677 | 1.368 | 1.018 | 1.088 | 4.652 |
| 4 | 3.732 | .134 | 10 | 12.566 | 11.724 | 12.566 | 10.939 | 1.627 | .954 | 1.023 | 5.532 |
| 4 1/2 | 4.232 | .134 | 10 | 14.137 | 13.295 | 15.904 | 14.066 | 1.838 | .848 | .902 | 6.248 |
| 5 | 4.704 | .148 | 9 | 15.708 | 14.778 | 19.635 | 17.379 | 2.256 | .763 | .812 | 7.669 |
| 6 | 5.670 | .165 | 8 | 18.850 | 17.813 | 28.274 | 25.249 | 3.025 | .636 | .673 | 10.282 |
| 7 | 6.670 | .165 | 8 | 21.991 | 20.954 | 38.485 | 34.942 | 3.543 | .545 | .572 | 12.044 |
| 8 | 7.670 | .165 | 8 | 25.133 | 24.096 | 50.265 | 46.204 | 4.061 | .477 | .498 | 13.807 |
| 9 | 8.640 | .180 | 7 | 28.274 | 27.143 | 63.617 | 58.629 | 4.988 | .424 | .442 | 16.955 |
| 10 | 9.594 | .203 | 6 | 31.416 | 30.140 | 78.540 | 72.292 | 6.248 | .381 | .398 | 21.240 |
| 11 | 10.560 | .220 | 5 | 34.558 | 33.175 | 95.033 | 87.582 | 7.451 | .347 | .361 | 25.329 |
| 12 | 11.542 | .229 | — | 37.699 | 36.260 | 113.097 | 104.629 | 8.468 | .318 | .330 | 27.888 |
| 13 | 12.524 | .238 | 4 | 40.840 | 39.345 | 132.732 | 123.190 | 9.542 | .293 | .304 | 32.439 |

NOTE. — In estimating effective steam-heating or evaporating surface of tubes, the surface in contact with air or gases of combustion, according to manner of application, as whether internal or external, is to be thus taken. For heating liquids by steam, superheating steam, or transferring heat from one liquid or one gas to another, mean surface of tubes to be computed.

STANDARD FLANGED FITTINGS - STRAIGHT SIZES

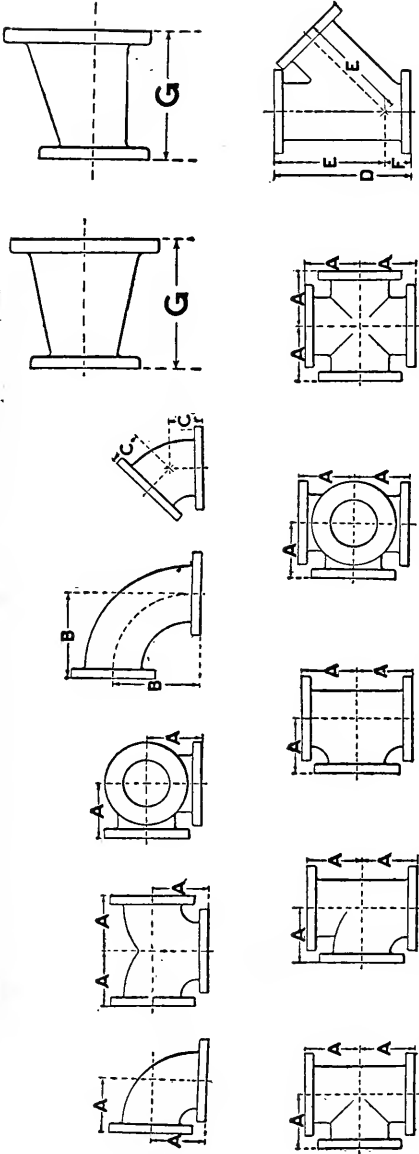

GENERAL DIMENSIONS—STANDARD FLANGED FITTINGS—STRAIGHT SIZES

(ALL DIMENSIONS ARE IN INCHES)

| | | | | | | | | | | | | | | | | | | | | | | | | | | | | | | | | |
|---|----|----|----|-----|----|----|-----|----|-----|-----|-----|-----|-----|-----|-----|-----|-----|-----|-----|-----|-----|-----|-----|-----|-----|-----|-----|-----|----|-----|-----|----|
| Size..... | 1 | 1½ | 2 | 2½ | 3 | 3½ | 4 | 4½ | 5 | 6 | 7 | 8 | 9 | 10 | 12 | 14 | 15 | 16 | 18 | 20 | 22 | 24 | 26 | 28 | 30 | 32 | 34 | 36 | 38 | 40 | | |
| AA—Face to Face, Tees and Crosses..... | 7 | 7½ | 8 | 9 | 10 | 11 | 12 | 13 | 14 | 15 | 16 | 17 | 18 | 20 | 22 | 24 | 28 | 29 | 30 | 33 | 36 | 40 | 44 | 46 | 48 | 50 | 52 | 54 | 56 | 58 | 60 | |
| A—Center to Face, Ells, Tees and Crosses..... | 3½ | 3½ | 4 | 4½ | 5 | 5½ | 6 | 6½ | 7 | 7½ | 8 | 8½ | 9 | 10 | 11 | 12 | 14 | 14½ | 15 | 16½ | 18 | 20 | 22 | 23 | 24 | 25 | 26 | 27 | 28 | 29 | 30 | |
| B—Center to Face, Long Radius Ells..... | 5 | 5½ | 6 | 6½ | 7 | 7½ | 8 | 9 | 9½ | 10½ | 11½ | 12½ | 14 | 15½ | 16½ | 19 | 21½ | 22½ | 24 | 26½ | 29 | 31½ | 34 | 36½ | 39 | 41½ | 44 | 46½ | 49 | 51½ | 54 | |
| C—Center to Face 45° Ells..... | 1½ | 2 | 2½ | 3 | 3 | 3½ | 4 | 4 | 4½ | 5 | 5½ | 6 | 6½ | 7½ | 8 | 8 | 8 | 8 | 8 | 8 | 8½ | 9½ | 10 | 11 | 13 | 14 | 15 | 16 | 17 | 18 | 19 | 20 |
| D—Face to Face Laterals..... | 7½ | 8 | 9 | 10½ | 12 | 13 | 14½ | 15 | 15½ | 17 | 18 | 20½ | 22 | 24 | 25½ | 30 | 33 | 34½ | 36½ | 39 | 43 | 46 | 49½ | 53 | 56 | 59 | | | | | | |
| E—Center to Face Laterals..... | 5½ | 6½ | 7 | 8 | 9½ | 10 | 11½ | 12 | 12½ | 13½ | 14½ | 16½ | 17½ | 19½ | 20½ | 24½ | 27 | 28½ | 30 | 32 | 35 | 37½ | 40½ | 44 | 46½ | 49 | | | | | | |
| F—Center to Face Laterals..... | 1½ | 1½ | 2 | 2½ | 3 | 3 | 3 | 3 | 3½ | 3½ | 4 | 4½ | 4½ | 5 | 5½ | 6 | 6 | 6 | 6½ | 7 | 8 | 8½ | 9 | 9 | 9½ | 10 | | | | | | |
| G—Face to Face Reducers..... | | | | | | 6 | 6½ | 7 | 7½ | 8 | 9 | 10 | 11 | 11½ | 12 | 14 | 16 | 17 | 18 | 19 | 20 | 22 | 24 | 26 | 28 | 30 | 32 | 34 | 36 | 38 | 40 | |
| Diameter of Flanges..... | 4 | 4½ | 5 | 6 | 7 | 7½ | 8½ | 9 | 9½ | 10 | 11 | 12½ | 13½ | 15 | 16 | 19 | 21 | 22½ | 23½ | 25 | 27½ | 29½ | 32 | 34½ | 36½ | 38½ | 41½ | 43½ | 46 | 48½ | 50½ | |
| Thickness of Flanges..... | ½ | ½ | ½ | ½ | ½ | ½ | ½ | ½ | ½ | ½ | ½ | ½ | ½ | ½ | ½ | ½ | ½ | ½ | ½ | ½ | ½ | ½ | ½ | ½ | ½ | ½ | ½ | ½ | ½ | ½ | ½ | ½ |
| Minimum Metal Thickness of Body..... | ⅜ | ⅜ | ⅜ | ⅜ | ⅜ | ⅜ | ⅜ | ⅜ | ⅜ | ⅜ | ⅜ | ⅜ | ⅜ | ⅜ | ⅜ | ⅜ | ⅜ | ⅜ | ⅜ | ⅜ | ⅜ | ⅜ | ⅜ | ⅜ | ⅜ | ⅜ | ⅜ | ⅜ | ⅜ | ⅜ | ⅜ | ⅜ |

For sizes 42" to 100", see manufacturer's lists.

EXTRA HEAVY FLANGED FITTINGS-STRAIGHT SIZES

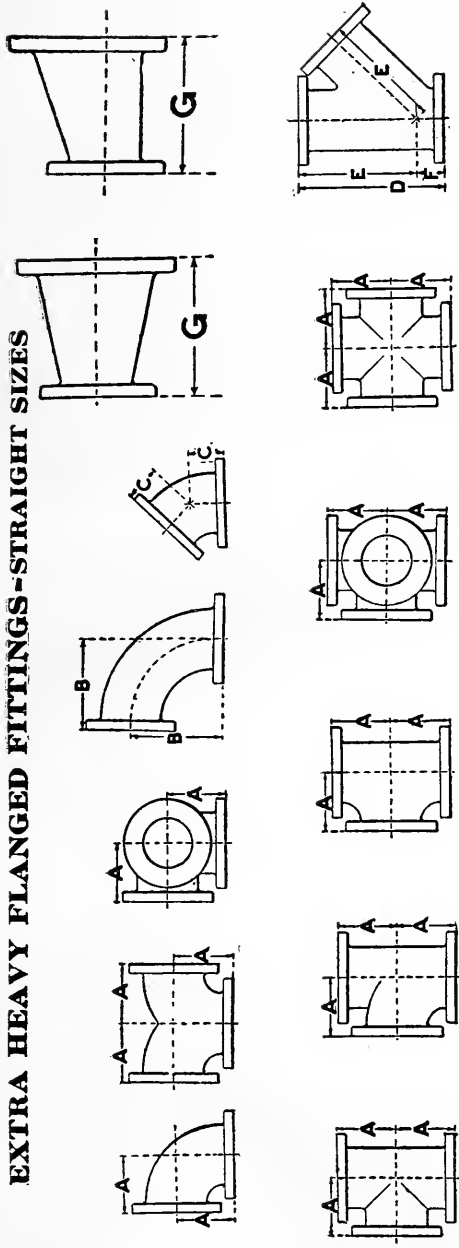

GENERAL DIMENSIONS-EXTRA HEAVY FLANGED FITTINGS-STRAIGHT SIZES

(ALL DIMENSIONS ARE IN INCHES)

| | | | | | | | | | | | | | | | | | | | | | | | | | | |
|--|----|----|----|-----|-----|----|-----|-----|-----|-----|-----|-----|-----|-----|-----|-----|-----|-----|-----|-----|-----|-----|----|-----|-----|-----|
| Size..... | 1 | 1½ | 2 | 2½ | 3 | 3½ | 4 | 4½ | 5 | 6 | 7 | 8 | 9 | 10 | 12 | 14 | 15 | 16 | 18 | 20 | 22 | 24 | 26 | 28 | 30 | |
| AA-Face to Face, Tees and Crosses..... | 8 | 8½ | 9 | 10 | 11 | 12 | 13 | 14 | 15 | 16 | 17 | 18 | 20 | 21 | 23 | 26 | 30 | 31 | 33 | 36 | 39 | 41 | 45 | 48 | 55 | |
| A-Center to Face, Ells, Tees and Crosses | 4 | 4½ | 5 | 5½ | 6 | 6½ | 7 | 7½ | 8 | 8½ | 9 | 10 | 10½ | 11½ | 13 | 15 | 15½ | 16½ | 18 | 19½ | 20½ | 22½ | 24 | 26 | 27½ | |
| B-Center to Face, Long Radius Ells..... | 5 | 5½ | 6 | 6½ | 7 | 7½ | 8½ | 9 | 9½ | 10½ | 11½ | 12½ | 14 | 15½ | 16½ | 19 | 21½ | 22½ | 24 | 26½ | 29 | 31½ | 34 | 36½ | 39 | 41½ |
| C-Center to Face 45° Ells..... | 2 | 2½ | 3 | 3½ | 4 | 4½ | 4½ | 5 | 5½ | 6 | 6 | 6 | 6 | 6 | 7 | 8 | 8½ | 9 | 9½ | 10 | 10½ | 11 | 12 | 13 | 14 | 15 |
| D-Face to Face, Laterals..... | 8½ | 9½ | 11 | 11½ | 13 | 14 | 15½ | 16 | 18 | 18½ | 21½ | 23 | 25½ | 27½ | 29½ | 33 | 37 | 39 | 42 | 45 | 49 | 53 | 57 | | | |
| E-Center to Face, Laterals..... | 6½ | 7½ | 8½ | 9 | 10½ | 11 | 12½ | 13½ | 14½ | 15 | 17½ | 19 | 20½ | 22½ | 24 | 27½ | 31 | 33 | 34½ | 37½ | 40½ | 43 | 47 | | | |
| F-Center to Face, Laterals..... | 2 | 2½ | 2½ | 2½ | 3 | 3 | 3 | 3 | 3½ | 3½ | 4 | 4½ | 5 | 5 | 5½ | 6 | 6½ | 6½ | 7½ | 8 | 8½ | 9½ | 10 | | | |
| G-Face to Face, Reducers..... | | | | | | | | | | | | | | | | | | | | | | | | | | |
| Diameter of Flanges..... | 4½ | 5 | 6 | 6½ | 7½ | 8½ | 9 | 10 | 10½ | 11 | 12½ | 14 | 15 | 16½ | 17½ | 20½ | 23 | 24½ | 25½ | 28 | 30½ | 33 | 36 | 38½ | 40½ | 43 |
| Thickness of Flanges..... | 1½ | 1½ | 1½ | 1½ | 1½ | 1½ | 1½ | 1½ | 1½ | 1½ | 1½ | 1½ | 1½ | 1½ | 1½ | 2 | 2½ | 2½ | 2½ | 2½ | 2½ | 2½ | 2½ | 2½ | 2½ | 3 |
| Minimum Metal Thickness of Body..... | 1 | 1 | 1 | 1 | 1 | 1 | 1 | 1 | 1 | 1 | 1 | 1 | 1 | 1 | 1 | 1 | 1 | 1 | 1 | 1 | 1 | 1 | 1 | 1 | 1 | 2 |

For sizes from 30" to 48", see manufacturer's lists.

**STANDARD FLANGED FITTINGS
GENERAL DIMENSIONS REDUCING TEES AND CROSSES**
(ALL DIMENSIONS ARE IN INCHES)

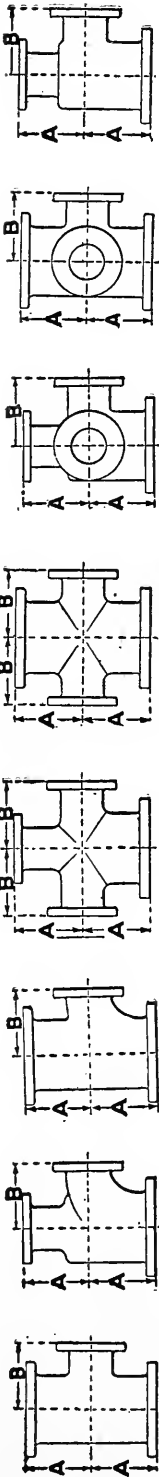

SHORT BODY PATTERN

| Size | 1 | 1½ | 2 | 2½ | 3 | 3½ | 4 | 4½ | 5 | 6 | 7 | 8 | 9 | 10 | 12 | 14 | 15 | 16 | 18 | 20 | 22 | 24 | 26 | 28 | 30 | 32 | 34 | 36 | 38 | 40 |
|----------------------------------|----|----|----|----|----|----|----|----|----|----|----|----|----|----|----|----|----|----|----|----|----|----|----|-----|-----|-----|-----|-----|-----|----|
| *Size of Outlet and Smaller..... | 44 | 46 | 48 | 50 | 52 | 54 | 56 | 58 | 60 | 62 | 64 | 66 | 68 | 70 | 72 | 74 | 76 | 78 | 80 | 82 | 84 | 86 | 88 | 90 | 92 | 94 | 96 | 98 | 100 | |
| AA-Face to Face, Run..... | 28 | 30 | 32 | 32 | 34 | 36 | 36 | 38 | 40 | 40 | 42 | 44 | 44 | 46 | 48 | 48 | 50 | 52 | 52 | 54 | 56 | 58 | 58 | 60 | 60 | 62 | 64 | 64 | 66 | |
| A-Center to Face, Run..... | 46 | 48 | 52 | 52 | 54 | 58 | 58 | 62 | 66 | 66 | 68 | 70 | 70 | 74 | 80 | 80 | 84 | 86 | 86 | 88 | 94 | 94 | 96 | 100 | 100 | 104 | 106 | 106 | 110 | |
| B-Center to Face, Outlet..... | 23 | 23 | 24 | 26 | 26 | 27 | 29 | 31 | 33 | 33 | 34 | 35 | 35 | 37 | 40 | 40 | 42 | 43 | 43 | 44 | 47 | 47 | 48 | 50 | 50 | 52 | 53 | 53 | 55 | |
| B-Center to Face, Outlet..... | 30 | 31 | 33 | 34 | 35 | 36 | 37 | 39 | 40 | 41 | 42 | 44 | 45 | 46 | 47 | 48 | 49 | 50 | 52 | 53 | 54 | 56 | 57 | 58 | 61 | 62 | 63 | 64 | 65 | 67 |

All reducing fittings 1" to 9" inclusive have the same center to face dimensions as straight size fittings.

*LONG BODY PATTERNS (Are used when outlets are larger than given in the above table, therefore have same dimensions as straight size fittings.)

The dimensions of "Reducing Flanged Fittings" are always regulated by the reduction of the outlet. **FITTINGS REDUCING ON THE RUN ONLY**, the long body pattern will always be used except Double Sweep Tees, on which the reduced end is always longer than the regular fitting. Dimensions on request. **BULL HEADS OR TEES** having outlets larger than the run, will be the same length center to face of all openings as a tee with all openings of the size of the outlet, for example: a 12 x 12 x 18 inch tee will be governed by the dimensions of the 18 inch long body tee; namely 16 ½ inches center to face of all openings and 33 inches face to face. **REDUCING ELBOWS**, carry same center to face dimensions as regular elbows of largest straight size.

EXTRA HEAVY FLANGED FITTINGS
GENERAL DIMENSIONS REDUCING TEES AND CROSSES
 (ALL DIMENSIONS ARE IN INCHES)

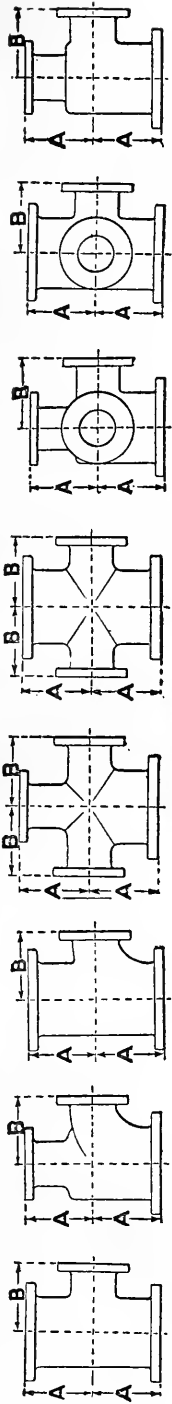

SHORT BODY PATTERN

| Size | 1 | 1½ | 2 | 2½ | 3 | 3½ | 4 | 4½ | 5 | 6 | 7 | 8 | 9 | 10 | 12 | 14 | 15 |
|----------------------------------|---|----|-----|-----|-----|----|----|-----|-----|----|-----|-----|-----|-----|-----|-----|-----|
| *Size of Outlet and Smaller..... | | | | | | | | | | | | | | | | | |
| AA-Face to Face, Run..... | All reducing fittings 1" to 9" inclusive have the same center to face dimensions as straight size fittings. | | | | | | | | | | | | | | | | |
| A-Center to Face, Run..... | | | | | | | | | | | | | | | | | |
| B-Center to Face, Outlet..... | | | | | | | | | | | | | | | | | |
| Size..... | 16 | 18 | 20 | 22 | 24 | 26 | 28 | 30 | 32 | 34 | 36 | 38 | 40 | 42 | 44 | 46 | 48 |
| *Size of Outlet and Smaller..... | 10 | 12 | 14 | 15 | 16 | 18 | 18 | 20 | 20 | 22 | 24 | 24 | 26 | 28 | 28 | 30 | 32 |
| AA-Face to Face, Run..... | 25 | 28 | 31 | 33 | 34 | 38 | 38 | 41 | 41 | 44 | 47 | 47 | 50 | 53 | 53 | 55 | 58 |
| A-Center to Face, Run..... | 12½ | 14 | 15½ | 16½ | 17 | 19 | 19 | 20½ | 20½ | 22 | 23½ | 23½ | 25 | 26½ | 26½ | 27½ | 29 |
| B-Center to Face, Outlet..... | 15½ | 17 | 18½ | 20 | 21½ | 23 | 24 | 25½ | 26½ | 28 | 29½ | 30½ | 31½ | 33½ | 34½ | 35½ | 37½ |

***LONG BODY PATTERNS** (Are used when outlets are larger than given in the above table, therefore have same dimensions as straight size fittings.)

The dimensions of "Reducing Flanged Fittings" are always regulated by the reduction of the outlet. **FITTINGS REDUCING ON THE RUN ONLY**, the long body pattern will always be used, except Double Sweep Tees, on which the reduced end is always longer than the regular fitting. Dimensions on request.

BULLS HEADS OR TEES having outlet larger than the run, will be the same length center to face of all openings as a tee with all openings of the size of the outlet. For example; a 12 x 12 x 16 inch tee will be governed by the dimensions of the 16 inch long body tee; namely 16½ inches center to face of all openings and 33 inches face to face. **REDUCING ELBOWS** carry same center to face dimension as regular elbow of largest straight size.

The following tables of key-seats and shafting horse powers in use by the Dodge Sales and Engineering Co. are reproduced by permission.

STANDARD DIMENSIONS FOR STRAIGHT KEY-SEATS
IN SHAFTS

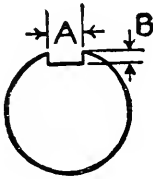

For Shafts

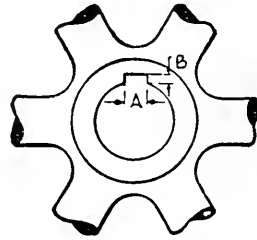

For Wheels

| Diameter of Shaft | Key-way | | Diameter of Shaft | Key-way | |
|-------------------------|------------|------------|-------------------------|------------|------------|
| | A Width | B Depth | | A Width | B Depth |
| $15/16$ to $1\ 1/4$ | $1/4$ | $1/8$ | $9\ 5/16$ to $10\ 1/4$ | $2\ 1/2$ | $7/8$ |
| $1\ 5/16$ to $1\ 3/4$ | $3/8$ | $3/16$ | $10\ 5/16$ to $11\ 1/4$ | $2\ 3/4$ | $7/8$ |
| $1\ 13/16$ to $2\ 1/4$ | $1/2$ | $1/4$ | $11\ 5/16$ to $12\ 1/4$ | 3 | $7/8$ |
| $2\ 5/16$ to $2\ 3/4$ | $5/8$ | $5/16$ | $12\ 5/16$ to $13\ 1/4$ | $3\ 1/4$ | 1 |
| $2\ 13/16$ to $3\ 1/4$ | $3/4$ | $3/8$ | $13\ 5/16$ to $14\ 1/4$ | $3\ 1/2$ | 1 |
| $3\ 5/16$ to $3\ 3/4$ | $7/8$ | $7/16$ | $14\ 5/16$ to $15\ 1/4$ | $3\ 3/4$ | 1 |
| $3\ 13/16$ to $4\ 1/4$ | 1 | $1/2$ | $15\ 5/16$ to $16\ 1/4$ | 4 | 1 |
| $4\ 5/16$ to $4\ 3/4$ | $1\ 1/8$ | $9/16$ | $16\ 5/16$ to $17\ 1/4$ | $4\ 1/4$ | $1\ 1/4$ |
| $4\ 13/16$ to $5\ 1/4$ | $1\ 1/4$ | $5/8$ | $17\ 5/16$ to $18\ 1/4$ | $4\ 1/2$ | $1\ 1/4$ |
| $5\ 5/16$ to $5\ 3/4$ | $1\ 3/8$ | $11/16$ | $18\ 5/16$ to $19\ 1/4$ | $4\ 3/4$ | $1\ 1/4$ |
| $5\ 13/16$ to $6\ 1/4$ | $1\ 1/2$ | $3/4$ | $19\ 5/16$ to $20\ 1/4$ | 5 | $1\ 1/4$ |
| $6\ 5/16$ to $7\ 1/4$ | $1\ 3/4$ | $3/4$ | $20\ 5/16$ to $21\ 1/4$ | $5\ 1/4$ | $1\ 1/2$ |
| $7\ 5/16$ to $7\ 15/16$ | 2 | $3/4$ | $21\ 5/16$ to $22\ 1/4$ | $5\ 1/2$ | $1\ 1/2$ |
| 8 to $8\ 1/4$ | 2 | $3/4$ | $22\ 5/16$ to $23\ 1/4$ | $5\ 3/4$ | $1\ 1/2$ |
| $8\ 5/16$ to $9\ 1/4$ | $2\ 1/4$ | $7/8$ | $23\ 5/16$ to $24\ 1/4$ | 6 | $1\ 1/2$ |

STANDARD DIMENSIONS FOR STRAIGHT KEY-WAYS IN HUBS OF COUPLINGS, CLUTCHES, PULLEYS, SHEAVES, ETC.

That are to be fitted to shafts

All Pulleys, Sheaves, etc., will be key-seated exactly the same as the shafts, as shown in the table opposite, *when they are to be fitted to shafts*, provided the bores of the pulleys, etc., do not exceed the limits shown below.

| Diameter Inches | Bore Inches | Diameter Inches | Bore Inches | Diameter Inches | Bore Inches |
|--------------------------------------|-------------------------------|--|--------------------------------|--|--------------------------------|
| 6 to 10 | 3 | 54 ¹ / ₄ to 72 | 6 | 144 ¹ / ₄ to 168 | 13 ¹ / ₂ |
| 10 ¹ / ₄ to 18 | 3 ¹ / ₂ | 72 ¹ / ₄ to 90 | 7 ¹ / ₂ | 168 ¹ / ₄ to 192 | 15 |
| 18 ¹ / ₄ to 30 | 4 | 90 ¹ / ₄ to 108 | 9 | 192 ¹ / ₄ to 216 | 16 ¹ / ₂ |
| 30 ¹ / ₄ to 42 | 4 ¹ / ₂ | 108 ¹ / ₄ to 126 | 10 ¹ / ₂ | 216 ¹ / ₄ to 240 | 18 |
| 42 ¹ / ₄ to 54 | 5 | 126 ¹ / ₄ to 144 | 12 | | |

Tapered Key-seats. — All pulleys and sheaves will have straight key-ways unless specifically ordered otherwise.

When tapered key-seats are used, the taper will be $\frac{1}{8}$ inch to the foot, dimension "B" always applying to the deep end of key-way.

DODGE STANDARD DIMENSIONS FOR STRAIGHT KEY-SEATS IN THE HUBS OF PULLEYS, SHEAVES, GEARS AND SPROCKET WHEELS. *To be Fitted to Friction Clutch Sleeves or Quills.*

| Bore of Hub | Key-seat | | Bore of Hub | Key-seat | | Bore of Hub | Key-seat | |
|--|-------------------------------|------|---|-------------------------------|-----|---|-------------------------------|-----|
| | A | B | | A | B | | A | B |
| 1 ¹³ / ₁₆ to 2 ¹ / ₄ | 1/2 | 1/8 | 7 ⁵ / ₁₆ to 7 ¹⁵ / ₁₆ | 2 | 1/4 | 16 ⁵ / ₁₆ to 17 ¹ / ₄ | 4 ¹ / ₄ | 1/2 |
| 2 ⁵ / ₁₆ to 2 ³ / ₄ | 5/8 | 3/16 | 8 to 8 ¹ / ₄ | 2 | 3/8 | 17 ⁵ / ₁₆ to 18 ¹ / ₄ | 4 ¹ / ₂ | 1/2 |
| 2 ¹³ / ₁₆ to 3 ¹ / ₄ | 3/4 | 3/16 | 8 ⁵ / ₁₆ to 9 ¹ / ₄ | 2 ¹ / ₄ | 3/8 | 18 ⁵ / ₁₆ to 19 ¹ / ₄ | 4 ³ / ₄ | 1/2 |
| 3 ⁵ / ₁₆ to 3 ³ / ₄ | 7/8 | 1/4 | 9 ⁵ / ₁₆ to 10 ¹ / ₄ | 2 ¹ / ₂ | 3/8 | 19 ⁵ / ₁₆ to 20 ¹ / ₄ | 5 | 1/2 |
| 3 ¹³ / ₁₆ to 4 ¹ / ₄ | 1 | 1/4 | 10 ⁵ / ₁₆ to 11 ¹ / ₄ | 2 ³ / ₄ | 3/8 | 20 ⁵ / ₁₆ to 21 ¹ / ₄ | 5 ¹ / ₄ | 1/2 |
| 4 ⁵ / ₁₆ to 4 ³ / ₄ | 1 ¹ / ₈ | 1/4 | 11 ⁵ / ₁₆ to 12 ¹ / ₄ | 3 | 3/8 | 21 ⁵ / ₁₆ to 22 ¹ / ₄ | 5 ¹ / ₂ | 1/2 |
| 4 ¹³ / ₁₆ to 5 ¹ / ₄ | 1 ¹ / ₄ | 1/4 | 12 ⁵ / ₁₆ to 13 ¹ / ₄ | 3 ¹ / ₄ | 3/8 | 22 ⁵ / ₁₆ to 23 ¹ / ₄ | 5 ³ / ₄ | 1/2 |
| 5 ⁵ / ₁₆ to 5 ³ / ₄ | 1 ³ / ₈ | 1/4 | 13 ⁵ / ₁₆ to 14 ¹ / ₄ | 3 ¹ / ₂ | 3/8 | 23 ⁵ / ₁₆ to 24 ¹ / ₄ | 6 | 1/2 |
| 5 ¹³ / ₁₆ to 6 ¹ / ₄ | 1 ¹ / ₂ | 1/4 | 14 ⁵ / ₁₆ to 15 ¹ / ₄ | 3 ³ / ₄ | 3/8 | | | |
| 6 ⁵ / ₁₆ to 7 ¹ / ₄ | 1 ³ / ₄ | 1/4 | 15 ⁵ / ₁₆ to 16 ¹ / ₄ | 4 | 3/8 | | | |

When pulleys, sheaves, etc., have bores in excess of table at bottom of preceding page, they will then be key-seated in accordance with the dimensions given above.

Horse Powers of Shafting Under Different Conditions

| Diam. of Shaft | For Head Shafts, Heavy Strains, shafts with gears, etc. H. P. = $\frac{D^3R}{125}$ | | | | | | | | | | For Line Shafts, with bearings every 8 ft. H. P. = $\frac{D^3R}{75}$ | | | | | | | | | | For simple transmission of power with no bending strains. H. P. = $\frac{D^3R}{50}$ | | | | | | | | | |
|------------------|---|-----|-----|-----|------|------|------|------|-----|-----|---|------|------|------|------|------|-----|------|------|------|--|------|------|------|--|--|--|--|--|--|
| | Revolutions per minute | | | | | | | | | | Revolutions per minute | | | | | | | | | | Revolutions per minute | | | | | | | | | |
| | 50 | 100 | 150 | 200 | 250 | 300 | 400 | 500 | 50 | 100 | 150 | 200 | 250 | 300 | 400 | 500 | 50 | 100 | 150 | 200 | 250 | 300 | 400 | 500 | | | | | | |
| $1\frac{3}{16}$ | 0.6 | 1.3 | 1.8 | 2.6 | 3.3 | 4 | 5 | 6 | 1 | 2 | 3 | 4 | 6 | 7 | 9 | 11 | 2 | 3 | 5 | 7 | 8 | 10 | 13 | 17 | | | | | | |
| $1\frac{7}{16}$ | 1.2 | 2.3 | 4 | 5 | 6 | 7 | 9 | 12 | 2 | 4 | 6 | 8 | 10 | 12 | 16 | 20 | 3 | 6 | 9 | 12 | 15 | 18 | 24 | 30 | | | | | | |
| $1\frac{11}{16}$ | 2 | 4 | 6 | 8 | 10 | 11 | 15 | 19 | 3 | 6 | 10 | 13 | 16 | 19 | 26 | 32 | 5 | 10 | 14 | 19 | 24 | 29 | 38 | 48 | | | | | | |
| $1\frac{5}{8}$ | 3 | 6 | 9 | 12 | 15 | 17 | 23 | 29 | 5 | 10 | 15 | 19 | 24 | 29 | 39 | 48 | 7 | 15 | 22 | 29 | 36 | 44 | 58 | 73 | | | | | | |
| $2\frac{3}{16}$ | 4 | 8 | 13 | 17 | 21 | 25 | 33 | 42 | 7 | 14 | 21 | 28 | 35 | 42 | 56 | 70 | 10 | 21 | 31 | 42 | 52 | 63 | 84 | 105 | | | | | | |
| $2\frac{7}{16}$ | 6 | 12 | 17 | 23 | 29 | 34 | 46 | 58 | 10 | 19 | 29 | 39 | 48 | 58 | 77 | 97 | 14 | 29 | 43 | 58 | 72 | 87 | 116 | 145 | | | | | | |
| $2\frac{11}{16}$ | 8 | 15 | 23 | 31 | 39 | 46 | 62 | 78 | 13 | 26 | 39 | 52 | 65 | 78 | 104 | 129 | 19 | 39 | 58 | 78 | 97 | 117 | 155 | 194 | | | | | | |
| $2\frac{15}{16}$ | 10 | 20 | 30 | 40 | 50 | 61 | 81 | 100 | 17 | 34 | 51 | 68 | 85 | 101 | 135 | 169 | 25 | 51 | 76 | 101 | 127 | 152 | 203 | 254 | | | | | | |
| $3\frac{1}{16}$ | 16 | 32 | 49 | 65 | 81 | 97 | 130 | 162 | 27 | 54 | 81 | 108 | 135 | 163 | 217 | 271 | 41 | 81 | 122 | 163 | 203 | 244 | 325 | 406 | | | | | | |
| $3\frac{5}{16}$ | 24 | 49 | 73 | 98 | 122 | 146 | 195 | 244 | 41 | 81 | 122 | 163 | 204 | 244 | 326 | 407 | 61 | 122 | 183 | 244 | 305 | 366 | 488 | 610 | | | | | | |
| $4\frac{1}{16}$ | 35 | 70 | 105 | 140 | 175 | 210 | 280 | 350 | 58 | 117 | 175 | 233 | 291 | 350 | 466 | 583 | 87 | 175 | 262 | 350 | 437 | 524 | 699 | 874 | | | | | | |
| $4\frac{5}{16}$ | 48 | 96 | 144 | 192 | 240 | 290 | 385 | 480 | 80 | 161 | 241 | 321 | 401 | 481 | 642 | 803 | 120 | 241 | 361 | 482 | 602 | 723 | 963 | 1204 | | | | | | |
| $5\frac{1}{16}$ | 66 | 133 | 200 | 265 | 332 | 400 | 520 | 640 | 111 | 222 | 333 | 444 | 555 | 666 | 888 | 1111 | 166 | 333 | 499 | 666 | 832 | 998 | 1331 | 1664 | | | | | | |
| $5\frac{5}{16}$ | 86 | 173 | 260 | 345 | 432 | 520 | 670 | 820 | 144 | 288 | 432 | 576 | 720 | 864 | 1152 | 1440 | 216 | 432 | 648 | 864 | 1080 | 1296 | 1728 | 2160 | | | | | | |
| $6\frac{1}{2}$ | 110 | 220 | 330 | 440 | 550 | 660 | 880 | 1100 | 183 | 366 | 549 | 732 | 915 | 1098 | 1464 | 1836 | 275 | 549 | 824 | 1099 | 1373 | 1647 | 2196 | 2745 | | | | | | |
| 7 | 137 | 275 | 412 | 550 | 686 | 822 | 1089 | 1377 | 229 | 457 | 686 | 915 | 1143 | 1371 | 1828 | 2291 | 343 | 686 | 1029 | 1372 | 1715 | 2058 | 2745 | 3432 | | | | | | |
| $7\frac{1}{2}$ | 170 | 337 | 506 | 675 | 844 | 1013 | 1351 | 1688 | 281 | 563 | 844 | 1125 | 1406 | 1687 | 2249 | 2811 | 422 | 844 | 1266 | 1688 | 2110 | 2532 | 3376 | 4220 | | | | | | |
| 8 | 205 | 410 | 614 | 820 | 1026 | 1232 | 1643 | 2054 | 341 | 683 | 1024 | 1365 | 1706 | 2047 | 2729 | 3411 | 512 | 1024 | 1536 | 2048 | 2560 | 3172 | 4224 | 5276 | | | | | | |

STANDARD GAGE FOR SHEET AND PLATE IRON AND STEEL

FROM CIRCULAR No. 18, BUREAU OF STANDARDS

Be it enacted by the Senate and House of Representatives of the United States of America in Congress assembled, That for the purpose of securing uniformity, the following is established as the only standard gage for sheet and plate iron and steel in the United States of America, namely:

| Number of gage | Approximate thickness in fractions of an inch | Approximate thickness in decimal parts of an inch | Approximate thickness in millimeters | Weight per square foot in ounces avoirdupois | Weight per square foot in pounds avoirdupois | Weight per square foot in kilograms | Weight per square meter in kilograms | Weight per square meter in pounds avoirdupois |
|----------------|---|---|--------------------------------------|--|--|-------------------------------------|--------------------------------------|---|
| 000000 | 1-2 | .5 | 12.7 | 320 | 20.00 | 9.072 | 97.65 | 215.28 |
| 000000 | 15-32 | .46875 | 11.90625 | 300 | 18.75 | 8.505 | 91.55 | 201.82 |
| 00000 | 7-16 | .4375 | 11.1125 | 280 | 17.50 | 7.983 | 85.44 | 188.37 |
| 0000 | 13-32 | .40625 | 10.31875 | 260 | 16.25 | 7.371 | 79.33 | 174.91 |
| 000 | 3-8 | .375 | 9.525 | 240 | 15 | 6.804 | 73.24 | 161.46 |
| 00 | 11-32 | .34375 | 8.73125 | 220 | 13.75 | 6.237 | 67.13 | 148.00 |
| 0 | 5-16 | .3125 | 7.9375 | 200 | 12.50 | 5.67 | 61.03 | 134.55 |
| 1 | 9-32 | .28125 | 7.14375 | 180 | 11.25 | 5.103 | 54.93 | 121.09 |
| 2 | 17-64 | .265625 | 6.746875 | 170 | 10.625 | 4.819 | 51.88 | 114.37 |
| 3 | 1-4 | .25 | 6.35 | 160 | 10 | 4.536 | 48.82 | 107.64 |
| 4 | 15-64 | .234375 | 5.953125 | 150 | 9.375 | 4.252 | 45.77 | 100.91 |
| 5 | 7-32 | .21875 | 5.55625 | 140 | 8.75 | 3.969 | 42.72 | 94.18 |
| 6 | 13-64 | .203125 | 5.159375 | 130 | 8.125 | 3.685 | 39.67 | 87.45 |
| 7 | 3-16 | .1875 | 4.7625 | 120 | 7.5 | 3.402 | 36.62 | 80.72 |
| 8 | 11-64 | .171875 | 4.365625 | 110 | 6.875 | 3.118 | 33.57 | 74.00 |
| 9 | 5-32 | .15625 | 3.96875 | 100 | 6.25 | 2.835 | 30.52 | 67.27 |
| 10 | 9-64 | .140625 | 3.571875 | 90 | 5.625 | 2.552 | 27.46 | 60.55 |
| 11 | 1-8 | .125 | 3.175 | 80 | 5 | 2.268 | 24.41 | 53.82 |
| 12 | 7-64 | .109375 | 2.778125 | 70 | 4.375 | 1.984 | 21.36 | 47.09 |
| 13 | 3-32 | .09375 | 2.38125 | 60 | 3.75 | 1.701 | 18.31 | 40.36 |
| 14 | 5-64 | .078125 | 1.984375 | 50 | 3.125 | 1.417 | 15.26 | 33.64 |
| 15 | 9-128 | .0703125 | 1.7859375 | 45 | 2.8125 | 1.276 | 13.73 | 30.27 |
| 16 | 1-16 | .0625 | 1.5875 | 40 | 2.5 | 1.134 | 12.21 | 26.91 |
| 17 | 9-160 | .05625 | 1.42875 | 36 | 2.25 | 1.021 | 10.99 | 24.22 |
| 18 | 1-20 | .05 | 1.27 | 32 | 2 | .9072 | 9.765 | 21.53 |

STANDARD GAGE FOR SHEET AND PLATE IRON AND STEEL

(Continued)

| Number of gage | Approximate thickness in fractions of an inch | Approximate thickness in decimal parts of an inch | Approximate thickness in millimeters | Weight per square foot in ounces avoirdupois | Weight per square foot in pounds avoirdupois | Weight per square foot in kilograms | Weight per square meter in kilograms | Weight per square meter in pounds avoirdupois |
|----------------|---|---|--------------------------------------|--|--|-------------------------------------|--------------------------------------|---|
| 19 | 7-160 | .04375 | 1.11125 | 28 | 1.75 | .7988 | 8.544 | 18.84 |
| 20 | 3-80 | .0375 | .9525 | 24 | 1.50 | .6804 | 7.324 | 16.15 |
| 21 | 11-320 | .034375 | .873125 | 22 | 1.375 | .6237 | 6.713 | 14.80 |
| 22 | 1-32 | .03125 | .793750 | 20 | 1.25 | .567 | 6.103 | 13.46 |
| 23 | 9-320 | .028125 | .714375 | 18 | 1.125 | .5103 | 5.493 | 12.11 |
| 24 | 1-40 | .025 | .635 | 16 | 1 | .4536 | 4.882 | 10.76 |
| 25 | 7-320 | .021875 | .555625 | 14 | .875 | .3969 | 4.272 | 9.42 |
| 26 | 3-160 | .01875 | .47625 | 12 | .75 | .3402 | 3.662 | 8.07 |
| 27 | 11-640 | .0171875 | .4365625 | 11 | .6875 | .3119 | 3.357 | 7.40 |
| 28 | 1-64 | .015625 | .396875 | 10 | .625 | .2835 | 3.052 | 6.73 |
| 29 | 9-640 | .0140625 | .3571875 | 9 | .5625 | .2551 | 2.746 | 6.05 |
| 30 | 1-80 | .0125 | .3175 | 8 | .5 | .2268 | 2.441 | 5.38 |
| 31 | 7-640 | .0109375 | .2778125 | 7 | .4375 | .1984 | 2.136 | 4.71 |
| 32 | 13-1280 | .01015625 | .25796875 | 6½ | .40625 | .1843 | 1.983 | 4.37 |
| 33 | 3-320 | .009375 | .238125 | 6 | .375 | .1701 | 1.831 | 4.04 |
| 34 | 11-1280 | .00859375 | .21828125 | 5½ | .34375 | .1559 | 1.678 | 3.70 |
| 35 | 5-640 | .0078125 | .1984375 | 5 | .3125 | .1417 | 1.526 | 3.36 |
| 36 | 9-1280 | .00703125 | .17859375 | 4½ | .28125 | .1276 | 1.373 | 3.03 |
| 37 | 17-2560 | .006640625 | .168671875 | 4¼ | .265625 | .1205 | 1.297 | 2.87 |
| 38 | 1-160 | .00625 | .15875 | 4 | .25 | .1134 | 1.221 | 2.69 |

And on and after July first, eighteen hundred and ninety-three, the same and no other shall be used in determining duties and taxes levied by the United States of America on sheet and plate iron and steel. But this act shall not be construed to increase duties upon any articles which may be imported.

SEC. 2. That the Secretary of the Treasury is authorized and required to prepare suitable standards in accordance herewith.

SEC. 3. That in the practical use and application of the standard gage hereby established a variation of two and one-half per cent either way may be allowed.

Approved, March 3, 1893.

Different Standards for Wire Gauge in Use in the United States

Dimensions of Sizes in Decimal Parts of an Inch

| Number of Wire Gauge | Bir- ming- ham, Wire Gauge | U. S. Stand. for Plate | American or Brown & Sharpe | Wash- burn & Moen Mfg. Co. Wor- ces- ter, Mass. | Im- perial Wire Gauge | Stubs' Steel Wire | Number of Wire Gauge |
|-------------------------|--|---------------------------|----------------------------------|---|--------------------------------|-------------------------|-------------------------|
| 000000 | | .46875 | | | .464 | | 000000 |
| 00000 | | .4375 | | | .432 | | 00000 |
| 0000 | .454 | .40625 | .46 | .3938 | .400 | | 0000 |
| 000 | .425 | .375 | .40964 | .3625 | .372 | | 000 |
| 00 | .38 | .34375 | .3648 | .3310 | .348 | | 00 |
| 0 | .34 | .3125 | .32486 | .3065 | .324 | | 0 |
| 1 | .3 | .28125 | .2893 | .2830 | .300 | .227 | 1 |
| 2 | .284 | .265625 | .25763 | .2625 | .276 | .219 | 2 |
| 3 | .259 | .25 | .22942 | .2437 | .252 | .212 | 3 |
| 4 | .238 | .234375 | .20431 | .2253 | .232 | .207 | 4 |
| 5 | .22 | .21875 | .18194 | .2070 | .212 | .204 | 5 |
| 6 | .203 | .203125 | .16202 | .1920 | .192 | .201 | 6 |
| 7 | .18 | .1875 | .14428 | .1770 | .176 | .199 | 7 |
| 8 | .165 | .171875 | .12849 | .1620 | .160 | .197 | 8 |
| 9 | .148 | .15625 | .11443 | .1483 | .144 | .194 | 9 |
| 10 | .134 | .140625 | .10189 | .1350 | .128 | .191 | 10 |
| 11 | .12 | .125 | .090742 | .1205 | .116 | .188 | 11 |
| 12 | .109 | .109375 | .080808 | .1055 | .104 | .185 | 12 |
| 13 | .095 | .09375 | .071961 | .0915 | .092 | .182 | 13 |
| 14 | .083 | .078125 | .064084 | .0800 | .080 | .180 | 14 |
| 15 | .072 | .0703125 | .057068 | .0720 | .072 | .178 | 15 |
| 16 | .065 | .0625 | .05082 | .0625 | .064 | .175 | 16 |
| 17 | .058 | .05625 | .045257 | .0540 | .056 | .172 | 17 |
| 18 | .049 | .05 | .040303 | .0475 | .048 | .168 | 18 |
| 19 | .042 | .04375 | .03589 | .0410 | .040 | .164 | 19 |
| 20 | .035 | .0375 | .031961 | .0348 | .036 | .161 | 20 |
| 21 | .032 | .034375 | .028462 | .03175 | .032 | .157 | 21 |
| 22 | .028 | .03125 | .025347 | .0286 | .028 | .155 | 22 |
| 23 | .025 | .028125 | .022571 | .0258 | .024 | .153 | 23 |
| 24 | .022 | .025 | .0201 | .0230 | .022 | .151 | 24 |
| 25 | .02 | .021875 | .0179 | .0204 | .020 | .148 | 25 |
| 26 | .018 | .01875 | .01594 | .0181 | .018 | .146 | 26 |
| 27 | .016 | .0171875 | .014195 | .0173 | .0164 | .143 | 27 |
| 28 | .014 | .015625 | .012641 | .0162 | .0149 | .139 | 28 |
| 29 | .013 | .0140625 | .011257 | .0150 | .0136 | .134 | 29 |
| 30 | .012 | .0125 | .010025 | .0140 | .0124 | .127 | 30 |
| 31 | .01 | .0109375 | .008928 | .0132 | .0116 | .120 | 31 |
| 32 | .009 | .01015625 | .00795 | .0128 | .0108 | .115 | 32 |
| 33 | .008 | .009375 | .00708 | .0118 | .0100 | .112 | 33 |
| 34 | .007 | .00859375 | .006304 | .0104 | .0092 | .110 | 34 |
| 35 | .005 | .0078125 | .005614 | .0095 | .0084 | .108 | 35 |
| 36 | .004 | .00703125 | .005 | .0090 | .0076 | .106 | 36 |
| 37 | | .006640625 | .004453 | | .0068 | .103 | 37 |
| 38 | | .00625 | .003965 | | .0060 | .101 | 38 |
| 39 | | | .003531 | | .0052 | .099 | 39 |
| 40 | | | .003144 | | .0048 | .097 | 40 |

METRIC CONVERSION TABLES — FROM CIRCULAR No. 47, BUREAU OF STANDARDS
 LENGTH — HUNDRETHS OF AN INCH TO MILLIMETERS — FROM 1 TO 99 HUNDRETHS

| 100ths of an inch | 0 | 1 | 2 | 3 | 4 | 5 | 6 | 7 | 8 | 9 |
|-------------------|--------|--------|--------|--------|--------|--------|--------|--------|--------|--------|
| | 0 | 0.254 | 0.508 | 0.762 | 1.016 | 1.270 | 1.524 | 1.778 | 2.032 | 2.286 |
| 10 | 2.540 | 2.794 | 3.048 | 3.302 | 3.556 | 3.810 | 4.064 | 4.318 | 4.572 | 4.826 |
| 20 | 5.080 | 5.334 | 5.588 | 5.842 | 6.096 | 6.350 | 6.604 | 6.858 | 7.112 | 7.366 |
| 30 | 7.620 | 7.874 | 8.128 | 8.382 | 8.636 | 8.890 | 9.144 | 9.398 | 9.652 | 9.906 |
| 40 | 10.160 | 10.414 | 10.668 | 10.922 | 11.176 | 11.430 | 11.684 | 11.938 | 12.192 | 12.446 |
| 50 | 12.700 | 12.954 | 13.208 | 13.462 | 13.716 | 13.970 | 14.224 | 14.478 | 14.732 | 14.986 |
| 60 | 15.240 | 15.494 | 15.748 | 16.002 | 16.256 | 16.510 | 16.764 | 17.018 | 17.272 | 17.526 |
| 70 | 17.780 | 18.034 | 18.288 | 18.542 | 18.796 | 19.050 | 19.304 | 19.558 | 19.812 | 20.066 |
| 80 | 20.320 | 20.574 | 20.828 | 21.082 | 21.336 | 21.590 | 21.844 | 22.098 | 22.352 | 22.606 |
| 90 | 22.860 | 23.114 | 23.368 | 23.622 | 23.876 | 24.130 | 24.384 | 24.638 | 24.892 | 25.146 |

LENGTH — MILLIMETERS TO DECIMALS OF AN INCH — FROM 1 TO 99 UNITS

| Milli-meters | 0 | 1 | 2 | 3 | 4 | 5 | 6 | 7 | 8 | 9 |
|--------------|---------|---------|---------|---------|---------|---------|---------|---------|---------|---------|
| | 0 | 0.03937 | 0.07874 | 0.11811 | 0.15748 | 0.19685 | 0.23622 | 0.27559 | 0.31496 | 0.35433 |
| 10 | 0.39370 | .43307 | .47244 | .51181 | .55118 | .59055 | .62992 | .66929 | .70866 | .74803 |
| 20 | .78740 | .82677 | .86614 | .90551 | .94488 | .98425 | 1.02362 | 1.06299 | 1.10236 | 1.14173 |
| 30 | 1.18110 | 1.22047 | 1.25984 | 1.29921 | 1.33858 | 1.37795 | 1.41732 | 1.45669 | 1.49606 | 1.53543 |
| 40 | 1.57480 | 1.61417 | 1.65354 | 1.69291 | 1.73228 | 1.77165 | 1.81102 | 1.85039 | 1.88976 | 1.92913 |
| 50 | 1.96850 | 2.00787 | 2.04724 | 2.08661 | 2.12598 | 2.16535 | 2.20472 | 2.24409 | 2.28346 | 2.32283 |
| 60 | 2.36220 | 2.40157 | 2.44094 | 2.48031 | 2.51968 | 2.55905 | 2.59842 | 2.63779 | 2.67716 | 2.71653 |
| 70 | 2.75590 | 2.79527 | 2.83464 | 2.87401 | 2.91338 | 2.95275 | 2.99212 | 3.03149 | 3.07086 | 3.11023 |
| 80 | 3.14960 | 3.18897 | 3.22834 | 3.26771 | 3.30708 | 3.34645 | 3.38582 | 3.42519 | 3.46456 | 3.50393 |
| 90 | 3.54330 | 3.58267 | 3.62204 | 3.66141 | 3.70078 | 3.74015 | 3.77952 | 3.81889 | 3.85826 | 3.89763 |

METRIC SYSTEM OF WEIGHTS AND MEASURES

In use in all European countries except Great Britain and Russia. In use in Mexico and South America.

The Meter, unit of length, is nearly the ten-millionth part of a quadrant of a meridian, of the distance between equator and pole. The International Standard Meter is, practically, nothing else but a length defined by the distance between two lines on a platinum-iridium bar at 0° Centigrade, deposited at the International Bureau of Weights and Measures, Paris, France.

The Liter, unit of capacity, is derived from the weight of one kilogram pure water at greatest density, a cube whose edge is one-tenth of a meter, and, therefore, the one-thousandth part of a metric ton.

The Gram, unit of weight, is a cube of pure water at greatest density, whose edge is one-hundredth of a meter, and, therefore, the one-thousandth part of a kilogram and the one-millionth part of a metric ton.

One silver dollar weighs 25 grams, 1 dime = 2½ grams, 1 five-cent nickel = 5 grams.

THE METRIC SYSTEM SIMPLIFIED

The following tables of the metric system of weights and measures have been simplified as much as possible by Mr. John Wilkes, of Nashville, Tenn., by omitting such denominations as are not in practical, everyday use in the countries where the system is used exclusively.

TABLES OF THE SYSTEM

LENGTH. — The denominations in practical use are millimeters (mm.), centimeters (cm.), meters (m.), and kilometers (km.).

10 mm. = 1 cm.; 100 cm. = 1 m.; 1000 m. = 1 km.

A decimeter is 10 cm.

WEIGHT. — The denominations in use are grams (g.), kilos* (kg.), and tons (metric tons).

1000 g. = 1 kg.; 1000 kg. = 1 metric ton.

CAPACITY. — The denominations in use are cubic centimeters (c.c.), and liters (l.).

1000 c.c. = 1 l.

A hectoliter is 100 l. (seldom used).

Relation of capacity and weight to length: A cubic decimeter is a liter, and a liter of water weighs a kilo.

* Contraction for kilogram.

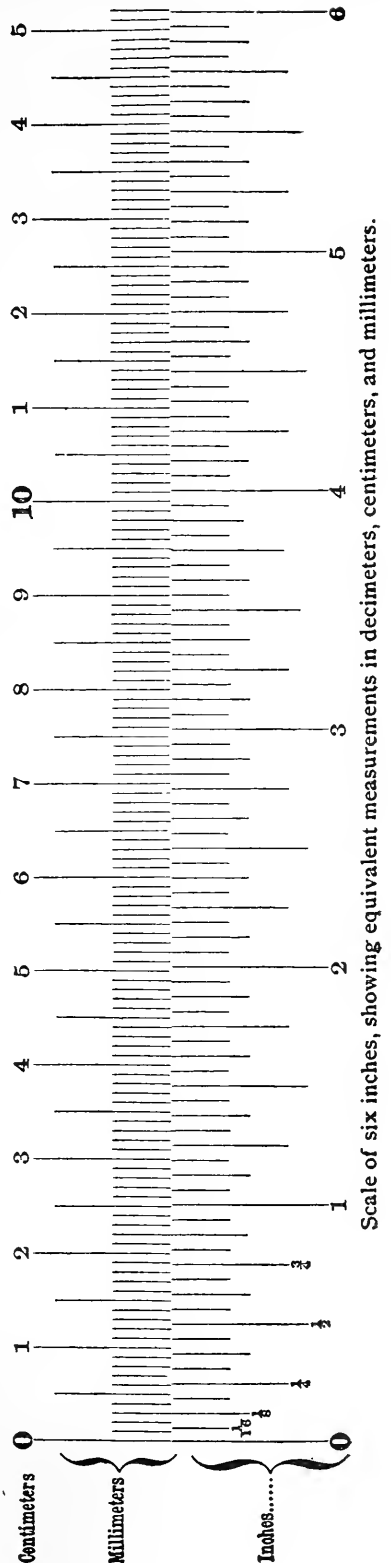

WEIGHTS AND MEASURES

TROY WEIGHT

| | | | |
|----|------------------------|----|------------------|
| 24 | Grains = 1 Pennyweight | 12 | Ounces = 1 Pound |
| 20 | Pwts. = 1 Ounce | | |

Used for weighing gold, silver, and jewels.

APOTHECARIES' WEIGHT

| | | | |
|----|--------------------|----|------------------|
| 20 | Grains = 1 Scruple | 8 | Drams = 1 Ounce |
| 3 | Scruples = 1 Dram | 12 | Ounces = 1 Pound |

The ounce and pound in this are the same as in Troy weight.

AVOIRDUPOIS WEIGHT

| | | | |
|------------------|--------------------|------|-----------------------------------|
| 27 $\frac{1}{2}$ | Grains = 1 Dram | 4 | Quarters = 1 Hundredweight (cwt.) |
| 16 | Drams = 1 Ounce | 20 | Cwt. = 1 Long Ton |
| 16 | Ounces = 1 Pound | 2240 | Pounds = 1 Long Ton |
| 28 | Pounds = 1 Quarter | 2000 | Pounds = 1 Short Ton |

DRY MEASURE

| | | | |
|---|-----------------|----|----------------------|
| 2 | Pints = 1 Quart | 4 | Pecks = 1 Bushel |
| 8 | Quarts = 1 Peck | 36 | Bushels = 1 Chaldron |

LIQUID MEASURE

| | | | |
|---|-------------------|------------------|-----------------------------|
| 4 | Gills = 1 Pint | 231 | Cu. In. = 1 Gallon |
| 2 | Pints = 1 Quart | 31 $\frac{1}{2}$ | Gallons = 1 Barrel |
| 4 | Quarts = 1 Gallon | 2 | Barrels = 1 Hogshead (App.) |
| | | 63 | Gallons = 1 Hogshead |
| | | 252 | Gallons = 1 Tun |

LONG MEASURE

| | | | |
|-----------------|-----------------|----|-------------------|
| 12 | Inches = 1 Foot | 40 | Rods = 1 Furlong |
| 3 | Feet = 1 Yard | 8 | Furlongs = 1 Mile |
| 5 $\frac{1}{2}$ | Yards = 1 Rod | 3 | Miles = 1 League |

SQUARE MEASURE

| | | | |
|------------------|-------------------------|--------|--------------------|
| 144 | Sq. Inches = 1 Sq. Foot | 160 | Sq. Rods = 1 Acre |
| 9 | Sq. Ft. = 1 Sq. Yard | 640 | Acres = 1 Sq. Mile |
| 30 $\frac{1}{2}$ | Sq. Yds. = 1 Sq. Rod | 43,560 | Sq. Ft. = 1 Acre |

CUBIC MEASURE

| | | | |
|---------|----------------------------|----|----------------------------------|
| 1728 | Cubic In. = 1 Cu. Ft. | 40 | Cu. Ft. = 1 Ton (U. S. shipping) |
| 27 | Cubic Ft. = 1 Cu. Yd. | 44 | Cu. Ft. = 1 Ton Anth. Coal |
| 128 | Cubic Ft. = 1 Cord | 47 | Cu. Ft. = 1 Ton Bitu. Coal |
| 2150.42 | Cubic In. = 1 U. S. Bushel | 50 | Cu. Ft. = 1 Ton Ashes |

| 1 inch = 25.4001 m/m. | | | 1 m/m. = .03937 inches | | | | | |
|-----------------------|---------|------|------------------------|---------|-------|-----------------|---------|-------|
| Inches | m/m. | | Inches | m/m. | | Inches | m/m. | |
| $\frac{1}{64}$ | .015625 | .40 | $\frac{2}{64}$ | .390625 | 9.92 | $\frac{49}{64}$ | .765625 | 19.45 |
| $\frac{1}{32}$ | .031250 | .79 | $\frac{1}{32}$ | .40625 | 10.32 | $\frac{2}{32}$ | .78125 | 19.84 |
| $\frac{3}{64}$ | .046875 | 1.19 | $\frac{2}{64}$ | .421875 | 10.72 | $\frac{5}{64}$ | .796875 | 20.24 |
| $\frac{1}{16}$ | .06250 | 1.59 | $\frac{7}{64}$ | .43750 | 11.11 | $\frac{13}{64}$ | .8125 | 20.64 |
| $\frac{5}{64}$ | .078125 | 1.98 | $\frac{2}{64}$ | .453125 | 11.51 | $\frac{5}{64}$ | .828125 | 21.03 |
| $\frac{3}{32}$ | .093750 | 2.38 | $\frac{7}{32}$ | .468750 | 11.91 | $\frac{2}{32}$ | .84375 | 21.43 |
| $\frac{7}{64}$ | .109375 | 2.78 | $\frac{3}{64}$ | .484375 | 12.30 | $\frac{5}{64}$ | .859375 | 21.83 |
| $\frac{1}{8}$ | .125 | 3.17 | $\frac{1}{2}$ | .50 | 12.70 | $\frac{7}{8}$ | .875 | 22.22 |
| $\frac{9}{64}$ | .140625 | 3.57 | $\frac{3}{64}$ | .515625 | 13.10 | $\frac{5}{64}$ | .890625 | 22.62 |
| $\frac{5}{32}$ | .156250 | 3.97 | $\frac{1}{32}$ | .53125 | 13.49 | $\frac{2}{32}$ | .90625 | 23.02 |
| $\frac{1}{64}$ | .171875 | 4.37 | $\frac{3}{64}$ | .546875 | 13.89 | $\frac{5}{64}$ | .921875 | 23.42 |
| $\frac{3}{16}$ | .18750 | 4.76 | $\frac{9}{16}$ | .5625 | 14.29 | $\frac{1}{16}$ | .9375 | 23.81 |
| $\frac{1}{64}$ | .203125 | 5.16 | $\frac{3}{64}$ | .578125 | 14.68 | $\frac{6}{64}$ | .953125 | 24.21 |
| $\frac{7}{32}$ | .218750 | 5.56 | $\frac{1}{32}$ | .59375 | 15.08 | $\frac{3}{32}$ | .96875 | 24.61 |
| $\frac{1}{64}$ | .234375 | 5.95 | $\frac{3}{64}$ | .609375 | 15.48 | $\frac{6}{64}$ | .984375 | 25.00 |
| $\frac{1}{4}$ | .25 | 6.35 | $\frac{5}{8}$ | .625 | 15.87 | 1 | 1.0000 | 25.40 |
| $\frac{17}{64}$ | .265625 | 6.75 | $\frac{4}{64}$ | .640625 | 16.27 | | | |
| $\frac{9}{32}$ | .281250 | 7.14 | $\frac{2}{32}$ | .65625 | 16.67 | | | |
| $\frac{19}{64}$ | .296875 | 7.54 | $\frac{4}{64}$ | .671875 | 17.07 | | | |
| $\frac{5}{16}$ | .31250 | 7.94 | $\frac{1}{16}$ | .6875 | 17.46 | | | |
| $\frac{21}{64}$ | .328125 | 8.33 | $\frac{4}{64}$ | .703125 | 17.86 | | | |
| $\frac{11}{32}$ | .343750 | 8.73 | $\frac{2}{32}$ | .71875 | 18.26 | | | |
| $\frac{23}{64}$ | .359375 | 9.13 | $\frac{4}{64}$ | .734375 | 18.65 | | | |
| $\frac{3}{8}$ | .375 | 9.52 | $\frac{3}{4}$ | .75 | 19.05 | | | |

AREAS AND CIRCUMFERENCES OF CIRCLES

| Diam. | Area | Circum. | Diam. | Area | Circum. | Diam. | Area | Circum. |
|-----------------|---------|---------|-----------------|---------|---------|----------------|---------|---------|
| $\frac{1}{64}$ | .000192 | 04909 | $\frac{13}{64}$ | .032405 | .63814 | $\frac{2}{64}$ | .119843 | 1.22719 |
| $\frac{1}{32}$ | .000767 | .09818 | $\frac{7}{32}$ | .037583 | .68722 | $\frac{1}{32}$ | .129622 | 1.27627 |
| $\frac{3}{64}$ | .001726 | .14726 | $\frac{1}{64}$ | .043143 | .73631 | $\frac{2}{64}$ | .139784 | 1.32536 |
| $\frac{1}{16}$ | .003068 | .19635 | $\frac{1}{4}$ | .049087 | .78540 | $\frac{7}{16}$ | .150330 | 1.37445 |
| $\frac{5}{64}$ | .004794 | .24544 | $\frac{1}{64}$ | .055415 | .83449 | $\frac{2}{64}$ | .161260 | 1.42354 |
| $\frac{3}{32}$ | .006903 | .29452 | $\frac{9}{32}$ | .062126 | .88357 | $\frac{1}{32}$ | .172573 | 1.47262 |
| $\frac{7}{64}$ | .009396 | .34361 | $\frac{1}{64}$ | .069221 | .93266 | $\frac{3}{64}$ | .184270 | 1.52171 |
| $\frac{1}{8}$ | .012272 | .39270 | $\frac{5}{16}$ | .076699 | .98175 | $\frac{1}{2}$ | .196350 | 1.57080 |
| $\frac{9}{64}$ | .015532 | .44179 | $\frac{2}{64}$ | .084561 | 1.03084 | $\frac{3}{64}$ | .208814 | 1.61989 |
| $\frac{5}{32}$ | .019175 | .49087 | $\frac{1}{32}$ | .092806 | 1.07992 | $\frac{1}{32}$ | .221661 | 1.66897 |
| $\frac{11}{64}$ | .023202 | .53096 | $\frac{2}{64}$ | .101435 | 1.12901 | $\frac{3}{64}$ | .234891 | 1.71806 |
| $\frac{3}{16}$ | .027612 | .58905 | $\frac{3}{8}$ | .110447 | 1.17810 | $\frac{9}{16}$ | .248505 | 1.76715 |

AREAS AND CIRCUMFERENCES OF CIRCLES (Continued)

| Diam. | Area | Circum. | Diam. | Area | Circum. | Diam. | Area | Circum. |
|------------------|---------|---------|------------------|----------|---------|----------------|----------|---------|
| $\frac{3}{8}$ | .26250 | 1.8160 | $1\frac{7}{16}$ | 1.62295 | 4.5160 | $3\frac{7}{8}$ | 11.79327 | 12.1737 |
| $\frac{1}{2}$ | .27688 | 1.8653 | $1\frac{5}{8}$ | 1.69427 | 4.6142 | 4 | 12.56640 | 12.5664 |
| $\frac{3}{4}$ | .29165 | 1.9144 | $1\frac{1}{2}$ | 1.76715 | 4.7124 | $4\frac{1}{8}$ | 13.36407 | 12.9591 |
| $\frac{5}{8}$ | .30679 | 1.9635 | $1\frac{3}{8}$ | 1.84155 | 4.8105 | $4\frac{1}{4}$ | 14.18629 | 13.3518 |
| $1\frac{1}{16}$ | .32233 | 2.0125 | $1\frac{9}{16}$ | 1.91748 | 4.9087 | $4\frac{3}{8}$ | 15.03305 | 13.7445 |
| $1\frac{1}{8}$ | .33824 | 2.0616 | $1\frac{7}{8}$ | 1.99495 | 5.0069 | $4\frac{1}{2}$ | 15.90435 | 14.1372 |
| $1\frac{3}{16}$ | .35454 | 2.1107 | $1\frac{5}{8}$ | 2.07395 | 5.1051 | $4\frac{5}{8}$ | 16.80019 | 14.5299 |
| $1\frac{1}{2}$ | .37122 | 2.1598 | $1\frac{3}{4}$ | 2.15448 | 5.2032 | $4\frac{3}{4}$ | 17.72059 | 14.9226 |
| $1\frac{5}{16}$ | .38829 | 2.2089 | $1\frac{1}{4}$ | 2.23655 | 5.3014 | $4\frac{7}{8}$ | 18.66552 | 15.3153 |
| $1\frac{3}{8}$ | .40574 | 2.2580 | $1\frac{3}{8}$ | 2.32015 | 5.3996 | 5 | 19.635 | 15.7080 |
| $1\frac{7}{16}$ | .42357 | 2.3071 | $1\frac{3}{4}$ | 2.40529 | 5.4978 | $5\frac{1}{8}$ | 20.62902 | 16.1007 |
| $1\frac{1}{2}$ | .44179 | 2.3562 | $1\frac{5}{8}$ | 2.49196 | 5.5959 | $5\frac{1}{4}$ | 21.64759 | 16.4934 |
| $1\frac{9}{16}$ | .46039 | 2.4052 | $1\frac{1}{2}$ | 2.58016 | 5.6941 | $5\frac{3}{8}$ | 22.69069 | 16.8861 |
| $1\frac{5}{8}$ | .47937 | 2.4543 | $1\frac{3}{4}$ | 2.66990 | 5.7923 | $5\frac{1}{2}$ | 23.75835 | 17.2788 |
| $1\frac{11}{16}$ | .49874 | 2.5034 | $1\frac{7}{8}$ | 2.76117 | 5.8905 | $5\frac{5}{8}$ | 24.85055 | 17.6715 |
| $1\frac{3}{4}$ | .51849 | 2.5525 | $1\frac{9}{8}$ | 2.85398 | 5.9886 | $5\frac{3}{4}$ | 25.96729 | 18.0642 |
| $1\frac{7}{8}$ | .53862 | 2.6016 | $1\frac{5}{8}$ | 2.94832 | 6.0868 | $5\frac{7}{8}$ | 27.10857 | 18.4569 |
| $1\frac{9}{8}$ | .55914 | 2.6507 | $1\frac{3}{2}$ | 3.04419 | 6.1850 | 6 | 28.27440 | 18.8496 |
| $1\frac{5}{4}$ | .58004 | 2.6998 | 2 | 3.14161 | 6.2832 | $6\frac{1}{8}$ | 29.46477 | 19.2423 |
| $1\frac{7}{8}$ | .60132 | 2.7488 | $2\frac{1}{16}$ | 3.34102 | 6.4795 | $6\frac{1}{4}$ | 30.67969 | 19.6350 |
| $1\frac{11}{16}$ | .62299 | 2.7979 | $2\frac{1}{8}$ | 3.54657 | 6.6759 | $6\frac{3}{8}$ | 31.91915 | 20.0277 |
| $1\frac{3}{4}$ | .64504 | 2.8470 | $2\frac{3}{16}$ | 3.75826 | 6.8722 | $6\frac{1}{2}$ | 33.18315 | 20.4204 |
| $1\frac{9}{8}$ | .66747 | 2.8961 | $2\frac{1}{4}$ | 3.97609 | 7.0686 | $6\frac{5}{8}$ | 34.47169 | 20.8131 |
| $1\frac{5}{4}$ | .69029 | 2.9452 | $2\frac{5}{16}$ | 4.20005 | 7.2649 | $6\frac{3}{4}$ | 35.78479 | 21.2058 |
| $1\frac{11}{8}$ | .71349 | 2.9943 | $2\frac{3}{8}$ | 4.43015 | 7.4613 | $6\frac{7}{8}$ | 37.12242 | 21.5984 |
| $1\frac{3}{2}$ | .73708 | 3.0434 | $2\frac{7}{16}$ | 4.66638 | 7.6576 | 7 | 38.48460 | 21.991 |
| $1\frac{7}{8}$ | .76105 | 3.0925 | $2\frac{1}{2}$ | 4.90875 | 7.8540 | $7\frac{1}{8}$ | 39.87132 | 22.384 |
| $1\frac{9}{8}$ | .7854 | 3.1416 | $2\frac{9}{16}$ | 5.15725 | 8.0503 | $7\frac{1}{4}$ | 41.28259 | 22.776 |
| $1\frac{5}{4}$ | .83525 | 3.2397 | $2\frac{5}{8}$ | 5.41189 | 8.2467 | $7\frac{3}{8}$ | 42.71839 | 23.169 |
| $1\frac{11}{16}$ | .88664 | 3.3379 | $2\frac{11}{16}$ | 5.67267 | 8.4430 | $7\frac{1}{2}$ | 44.17875 | 23.562 |
| $1\frac{3}{4}$ | .93056 | 3.4361 | $2\frac{3}{4}$ | 5.93959 | 8.6394 | $7\frac{5}{8}$ | 45.66364 | 23.954 |
| $1\frac{7}{8}$ | .99402 | 3.5429 | $2\frac{13}{16}$ | 6.21264 | 8.8357 | $7\frac{3}{4}$ | 47.17309 | 24.347 |
| $1\frac{9}{8}$ | 1.05001 | 3.6324 | $2\frac{7}{8}$ | 6.49182 | 9.0321 | $7\frac{7}{8}$ | 48.70707 | 24.740 |
| $1\frac{5}{4}$ | 1.10754 | 3.7306 | $2\frac{15}{16}$ | 6.77714 | 9.2284 | 8 | 50.26560 | 25.132 |
| $1\frac{11}{16}$ | 1.16659 | 3.8288 | 3 | 7.06860 | 9.4248 | $8\frac{1}{8}$ | 51.84869 | 25.525 |
| $1\frac{3}{4}$ | 1.22719 | 3.9270 | $3\frac{1}{8}$ | 7.66992 | 9.8175 | $8\frac{1}{4}$ | 53.45629 | 25.918 |
| $1\frac{7}{8}$ | 1.28931 | 4.0251 | $3\frac{1}{4}$ | 8.29579 | 10.2102 | $8\frac{3}{8}$ | 55.08845 | 26.311 |
| $1\frac{9}{8}$ | 1.35297 | 4.1233 | $3\frac{3}{8}$ | 8.94619 | 10.6029 | $8\frac{1}{2}$ | 56.74515 | 26.703 |
| $1\frac{5}{4}$ | 1.41817 | 4.2215 | $3\frac{1}{2}$ | 9.62115 | 10.9956 | $8\frac{5}{8}$ | 58.42637 | 27.096 |
| $1\frac{11}{16}$ | 1.48489 | 4.3197 | $3\frac{5}{8}$ | 10.32065 | 11.3883 | $8\frac{3}{4}$ | 60.13218 | 27.489 |
| $1\frac{3}{4}$ | 1.55316 | 4.4178 | $3\frac{3}{4}$ | 11.04469 | 11.7810 | $8\frac{7}{8}$ | 61.86252 | 27.881 |

AREAS AND CIRCUMFERENCES OF CIRCLES (Continued)

| Diam. | Area | Circum. | Diam. | Area | Circum. | Diam. | Area | Circum. |
|------------------|-----------|---------|------------------|-----------|---------|------------------|-----------|---------|
| 9 | 63.61740 | 28.274 | 14 | 153.9384 | 43.982 | 19 | 283.5294 | 59.690 |
| 9 $\frac{1}{8}$ | 65.39682 | 28.667 | 14 $\frac{1}{8}$ | 156.69957 | 44.375 | 19 $\frac{1}{8}$ | 287.27232 | 60.083 |
| 9 $\frac{1}{4}$ | 67.20078 | 29.059 | 14 $\frac{1}{4}$ | 159.48528 | 44.767 | 19 $\frac{1}{4}$ | 291.03979 | 60.475 |
| 9 $\frac{3}{8}$ | 69.02929 | 29.452 | 14 $\frac{3}{8}$ | 162.29554 | 45.160 | 19 $\frac{3}{8}$ | 294.83179 | 60.868 |
| 9 $\frac{1}{2}$ | 70.88235 | 29.845 | 14 $\frac{1}{2}$ | 165.13035 | 45.553 | 19 $\frac{1}{2}$ | 298.64835 | 61.261 |
| 9 $\frac{5}{8}$ | 72.75994 | 30.237 | 14 $\frac{5}{8}$ | 167.98969 | 45.945 | 19 $\frac{5}{8}$ | 302.48945 | 61.653 |
| 9 $\frac{3}{4}$ | 74.66208 | 30.630 | 14 $\frac{3}{4}$ | 170.87358 | 46.338 | 19 $\frac{3}{4}$ | 306.35509 | 62.046 |
| 9 $\frac{7}{8}$ | 76.58877 | 31.023 | 14 $\frac{7}{8}$ | 173.78202 | 46.731 | 19 $\frac{7}{8}$ | 310.24527 | 62.439 |
| 10 | 78.54 | 31.416 | 15 | 176.715 | 47.124 | 20 | 314.159 | 62.832 |
| 10 $\frac{1}{8}$ | 80.51577 | 31.808 | 15 $\frac{1}{8}$ | 179.67252 | 47.516 | 20 $\frac{1}{8}$ | 318.09927 | 63.224 |
| 10 $\frac{1}{4}$ | 82.51608 | 32.201 | 15 $\frac{1}{4}$ | 182.65458 | 47.909 | 20 $\frac{1}{4}$ | 322.06309 | 63.617 |
| 10 $\frac{3}{8}$ | 84.54094 | 32.594 | 15 $\frac{3}{8}$ | 185.66119 | 48.302 | 20 $\frac{3}{8}$ | 326.05145 | 64.010 |
| 10 $\frac{1}{2}$ | 86.59035 | 32.986 | 15 $\frac{1}{2}$ | 188.69235 | 48.694 | 20 $\frac{1}{2}$ | 330.06435 | 64.402 |
| 10 $\frac{5}{8}$ | 88.66429 | 33.379 | 15 $\frac{5}{8}$ | 191.74804 | 49.087 | 20 $\frac{5}{8}$ | 334.10179 | 64.795 |
| 10 $\frac{3}{4}$ | 90.76278 | 33.772 | 15 $\frac{3}{4}$ | 194.82828 | 49.480 | 20 $\frac{3}{4}$ | 338.16379 | 65.188 |
| 10 $\frac{7}{8}$ | 92.88582 | 34.164 | 15 $\frac{7}{8}$ | 197.93307 | 49.872 | 20 $\frac{7}{8}$ | 342.25032 | 65.580 |
| 11 | 95.03340 | 34.557 | 16 | 201.0624 | 50.265 | 21 | 346.3614 | 65.973 |
| 11 $\frac{1}{8}$ | 97.20552 | 34.950 | 16 $\frac{1}{8}$ | 204.21627 | 50.658 | 21 $\frac{1}{8}$ | 350.49702 | 66.366 |
| 11 $\frac{1}{4}$ | 99.40218 | 35.343 | 16 $\frac{1}{4}$ | 207.39468 | 51.051 | 21 $\frac{1}{4}$ | 354.65719 | 66.759 |
| 11 $\frac{3}{8}$ | 101.62339 | 35.735 | 16 $\frac{3}{8}$ | 210.59764 | 51.443 | 21 $\frac{3}{8}$ | 358.84189 | 67.151 |
| 11 $\frac{1}{2}$ | 103.86915 | 36.128 | 16 $\frac{1}{2}$ | 213.82515 | 51.836 | 21 $\frac{1}{2}$ | 363.05115 | 67.544 |
| 11 $\frac{5}{8}$ | 106.13944 | 36.521 | 16 $\frac{5}{8}$ | 217.07719 | 52.229 | 21 $\frac{5}{8}$ | 367.28495 | 67.937 |
| 11 $\frac{3}{4}$ | 108.43428 | 36.913 | 16 $\frac{3}{4}$ | 220.35378 | 52.621 | 21 $\frac{3}{4}$ | 371.54329 | 68.329 |
| 11 $\frac{7}{8}$ | 110.75367 | 37.306 | 16 $\frac{7}{8}$ | 223.65492 | 53.014 | 21 $\frac{7}{8}$ | 375.82617 | 68.722 |
| 12 | 113.0976 | 37.699 | 17 | 226.9806 | 53.407 | 22 | 380.1336 | 69.115 |
| 12 $\frac{1}{8}$ | 115.46607 | 38.091 | 17 $\frac{1}{8}$ | 230.33082 | 53.799 | 22 $\frac{1}{8}$ | 384.46557 | 69.507 |
| 12 $\frac{1}{4}$ | 117.85908 | 38.484 | 17 $\frac{1}{4}$ | 233.70558 | 54.192 | 22 $\frac{1}{4}$ | 388.82209 | 69.900 |
| 12 $\frac{3}{8}$ | 120.27664 | 38.877 | 17 $\frac{3}{8}$ | 237.10489 | 54.585 | 22 $\frac{3}{8}$ | 393.20315 | 70.293 |
| 12 $\frac{1}{2}$ | 122.71875 | 39.270 | 17 $\frac{1}{2}$ | 240.52875 | 54.978 | 22 $\frac{1}{2}$ | 397.60875 | 70.685 |
| 12 $\frac{5}{8}$ | 125.18539 | 39.662 | 17 $\frac{5}{8}$ | 243.97714 | 55.370 | 22 $\frac{5}{8}$ | 402.03889 | 71.078 |
| 12 $\frac{3}{4}$ | 127.67658 | 40.055 | 17 $\frac{3}{4}$ | 247.45008 | 55.763 | 22 $\frac{3}{4}$ | 406.49359 | 71.471 |
| 12 $\frac{7}{8}$ | 130.19232 | 40.448 | 17 $\frac{7}{8}$ | 250.94757 | 56.156 | 22 $\frac{7}{8}$ | 410.97282 | 71.864 |
| 13 | 132.7326 | 40.840 | 18 | 254.4696 | 56.548 | 23 | 415.4766 | 72.256 |
| 13 $\frac{1}{8}$ | 135.29742 | 41.233 | 18 $\frac{1}{8}$ | 258.01617 | 56.941 | 23 $\frac{1}{8}$ | 420.00492 | 72.649 |
| 13 $\frac{1}{4}$ | 137.88678 | 41.626 | 18 $\frac{1}{4}$ | 261.58728 | 57.334 | 23 $\frac{1}{4}$ | 424.55779 | 73.042 |
| 13 $\frac{3}{8}$ | 140.50069 | 42.019 | 18 $\frac{3}{8}$ | 265.18294 | 57.726 | 23 $\frac{3}{8}$ | 429.13519 | 73.434 |
| 13 $\frac{1}{2}$ | 143.13915 | 42.411 | 18 $\frac{1}{2}$ | 268.80315 | 58.119 | 23 $\frac{1}{2}$ | 433.73715 | 73.827 |
| 13 $\frac{5}{8}$ | 145.80214 | 42.804 | 18 $\frac{5}{8}$ | 272.44789 | 58.512 | 23 $\frac{5}{8}$ | 438.36365 | 74.220 |
| 13 $\frac{3}{4}$ | 148.48968 | 43.197 | 18 $\frac{3}{4}$ | 276.11718 | 58.905 | 23 $\frac{3}{4}$ | 443.01469 | 74.613 |
| 13 $\frac{7}{8}$ | 151.20177 | 43.589 | 18 $\frac{7}{8}$ | 279.81102 | 59.297 | 23 $\frac{7}{8}$ | 447.69027 | 75.005 |

AREAS AND CIRCUMFERENCES OF CIRCLES (Continued)

| Diam. | Area | Circum. | Diam. | Area | Circum. | Diam. | Area | Circum. |
|------------------|-----------|---------|------------------|-----------|---------|------------------|-----------|---------|
| 24 | 452.3904 | 75.398 | 32 | 804.2496 | 100.531 | 42 | 1385.4456 | 131.947 |
| 24 $\frac{1}{8}$ | 457.11507 | 75.791 | 32 $\frac{1}{4}$ | 816.8650 | 101.316 | 42 $\frac{1}{4}$ | 1401.9881 | 132.732 |
| 24 $\frac{1}{4}$ | 461.86428 | 76.183 | 32 $\frac{1}{2}$ | 829.5787 | 102.102 | 42 $\frac{1}{2}$ | 1418.6287 | 133.518 |
| 24 $\frac{3}{8}$ | 466.63804 | 76.576 | 32 $\frac{3}{4}$ | 842.3905 | 102.887 | 42 $\frac{3}{4}$ | 1435.3676 | 134.303 |
| 24 $\frac{1}{2}$ | 471.43635 | 76.969 | 33 | 855.3006 | 103.673 | 43 | 1452.2046 | 135.088 |
| 24 $\frac{5}{8}$ | 476.25919 | 77.361 | 33 $\frac{1}{4}$ | 868.3087 | 104.458 | 43 $\frac{1}{4}$ | 1469.1398 | 135.874 |
| 24 $\frac{3}{4}$ | 481.10658 | 77.754 | 33 $\frac{1}{2}$ | 881.4151 | 105.243 | 43 $\frac{1}{2}$ | 1486.1731 | 136.659 |
| 24 $\frac{7}{8}$ | 485.97852 | 78.147 | 33 $\frac{3}{4}$ | 894.6196 | 106.029 | 43 $\frac{3}{4}$ | 1503.3047 | 137.445 |
| 25 | 490.8750 | 78.540 | 34 | 907.9224 | 106.814 | 44 | 1520.5344 | 138.230 |
| 25 $\frac{1}{8}$ | 495.79602 | 78.932 | 34 $\frac{1}{4}$ | 921.3232 | 107.599 | 44 $\frac{1}{4}$ | 1537.8623 | 139.015 |
| 25 $\frac{1}{4}$ | 500.74158 | 79.325 | 34 $\frac{1}{2}$ | 934.8223 | 108.385 | 44 $\frac{1}{2}$ | 1555.2883 | 139.801 |
| 25 $\frac{3}{8}$ | 505.71169 | 79.718 | 34 $\frac{3}{4}$ | 948.4196 | 109.170 | 44 $\frac{3}{4}$ | 1572.8126 | 140.586 |
| 25 $\frac{1}{2}$ | 510.70635 | 80.110 | 35 | 962.1150 | 109.956 | 45 | 1590.435 | 141.373 |
| 25 $\frac{5}{8}$ | 515.72554 | 80.503 | 35 $\frac{1}{4}$ | 975.9086 | 110.741 | 45 $\frac{1}{4}$ | 1608.1556 | 142.157 |
| 25 $\frac{3}{4}$ | 520.76928 | 80.896 | 35 $\frac{1}{2}$ | 989.8003 | 111.527 | 45 $\frac{1}{2}$ | 1625.9743 | 142.942 |
| 25 $\frac{7}{8}$ | 525.83757 | 81.288 | 35 $\frac{3}{4}$ | 1003.7903 | 112.312 | 45 $\frac{3}{4}$ | 1643.8913 | 143.728 |
| 26 | 530.9304 | 81.681 | 36 | 1017.8784 | 113.097 | 46 | 1661.9064 | 144.513 |
| 26 $\frac{1}{4}$ | 541.18968 | 82.467 | 36 $\frac{1}{4}$ | 1032.0647 | 113.883 | 46 $\frac{1}{4}$ | 1680.0197 | 145.299 |
| 26 $\frac{1}{2}$ | 551.54715 | 83.252 | 36 $\frac{1}{2}$ | 1046.3491 | 114.668 | 46 $\frac{1}{2}$ | 1698.2311 | 146.084 |
| 26 $\frac{3}{4}$ | 562.00278 | 84.037 | 36 $\frac{3}{4}$ | 1060.7318 | 115.453 | 46 $\frac{3}{4}$ | 1716.5408 | 146.869 |
| 27 | 572.5566 | 84.823 | 37 | 1075.2126 | 116.239 | 47 | 1734.9486 | 147.655 |
| 27 $\frac{1}{4}$ | 583.20858 | 85.608 | 37 $\frac{1}{4}$ | 1089.7916 | 117.024 | 47 $\frac{1}{4}$ | 1753.4546 | 148.440 |
| 27 $\frac{1}{2}$ | 593.95875 | 86.394 | 37 $\frac{1}{2}$ | 1104.4687 | 117.810 | 47 $\frac{1}{2}$ | 1772.0587 | 149.226 |
| 27 $\frac{3}{4}$ | 604.80708 | 87.179 | 37 $\frac{3}{4}$ | 1119.2441 | 118.595 | 47 $\frac{3}{4}$ | 1790.7611 | 150.011 |
| 28 | 615.7536 | 87.964 | 38 | 1134.1176 | 119.381 | 48 | 1809.5616 | 150.796 |
| 28 $\frac{1}{4}$ | 626.79828 | 88.750 | 38 $\frac{1}{4}$ | 1149.0893 | 120.166 | 48 $\frac{1}{4}$ | 1828.4603 | 151.582 |
| 28 $\frac{1}{2}$ | 637.94115 | 89.535 | 38 $\frac{1}{2}$ | 1164.1591 | 120.951 | 48 $\frac{1}{2}$ | 1847.4571 | 152.367 |
| 28 $\frac{3}{4}$ | 649.18218 | 90.321 | 38 $\frac{3}{4}$ | 1179.3272 | 121.737 | 48 $\frac{3}{4}$ | 1866.5522 | 153.153 |
| 29 | 660.5214 | 91.106 | 39 | 1194.5934 | 122.522 | 49 | 1885.7454 | 153.938 |
| 29 $\frac{1}{4}$ | 671.95878 | 91.891 | 39 $\frac{1}{4}$ | 1209.9577 | 123.308 | 49 $\frac{1}{4}$ | 1905.0368 | 154.723 |
| 29 $\frac{1}{2}$ | 683.49435 | 92.677 | 39 $\frac{1}{2}$ | 1225.4203 | 124.093 | 49 $\frac{1}{2}$ | 1924.4263 | 155.509 |
| 29 $\frac{3}{4}$ | 695.12808 | 93.462 | 39 $\frac{3}{4}$ | 1240.9811 | 124.878 | 49 $\frac{3}{4}$ | 1943.9141 | 156.294 |
| 30 | 706.8600 | 94.248 | 40 | 1256.64 | 125.664 | 50 | 1963.50 | 157.080 |
| 30 $\frac{1}{4}$ | 718.69008 | 95.033 | 40 $\frac{1}{4}$ | 1272.3971 | 126.449 | 50 $\frac{1}{4}$ | 1983.1841 | 157.865 |
| 30 $\frac{1}{2}$ | 730.61835 | 95.818 | 40 $\frac{1}{2}$ | 1288.2523 | 127.235 | 50 $\frac{1}{2}$ | 2002.9663 | 158.650 |
| 30 $\frac{3}{4}$ | 742.64478 | 96.604 | 40 $\frac{3}{4}$ | 1304.2058 | 128.020 | 50 $\frac{3}{4}$ | 2022.8468 | 159.436 |
| 31 | 754.7694 | 97.389 | 41 | 1320.2574 | 128.805 | 51 | 2042.8254 | 160.221 |
| 31 $\frac{1}{4}$ | 766.99218 | 98.175 | 41 $\frac{1}{4}$ | 1336.4072 | 129.591 | 51 $\frac{1}{4}$ | 2062.9022 | 161.007 |
| 31 $\frac{1}{2}$ | 779.31315 | 98.960 | 41 $\frac{1}{2}$ | 1352.6551 | 130.376 | 51 $\frac{1}{2}$ | 2083.0771 | 161.792 |
| 31 $\frac{3}{4}$ | 791.73228 | 99.745 | 41 $\frac{3}{4}$ | 1369.0013 | 131.161 | 51 $\frac{3}{4}$ | 2103.3503 | 162.577 |

ENGINEERING AND REFERENCE BOOKS

| | |
|---|--------|
| Aeronautical. The Flying Machine from an Engineering Standpoint. Lanchester..... | \$3.00 |
| Air — Compressed. Mechanics of Air Machinery. Weisbach..... | 3.75 |
| Architecture. Architects' and Builders' Pocketbook. Kidder..... | 5.00 |
| Automobile Engineering. The Modern Gasolene Automobile. Page..... | 3.00 |
| Chemical. Manual of Industrial Chemistry. Rogers..... | 5.00 |
| Chemical Data. Chemical Annual for 1918. Olsen..... | 3.00 |
| Boilers — Marine. U. S. Rules and Regulations. Dept. of Commerce | |
| Boilers — Marine. Report of Boiler Code Committee. Am. Soc. Mech. Engrs. | |
| Civil Engineering. Handbook. Frye..... | 5.00 |
| " " Handbook. Merriman..... | 5.00 |
| " " Handbook. Trautwine..... | 5.00 |
| Electrical Engineering. Handbook. Foster..... | 5.00 |
| Fans. Fan Engineering. Buffalo Forge Co. | |
| Foundry. General Foundry Practice. Roxburgh..... | 2.00 |
| Gas and Gasolene Engines. Internal Combustion Engines. Carpenter and Diederichs..... | 5.00 |
| Gearing. Treatise on Gears. Grant..... | 1.00 |
| Hydraulics. Hydraulic Power Engineering. Marks..... | 3.50 |
| Machine Design. Elements of Machine Design. Kimball and Barr..... | 3.00 |
| Marine Engineering. The Naval Constructor. Simpson.. | 5.00 |
| Mechanical Engineering. Handbook. Kent..... | 5.00 |
| " " Handbook. Marks..... | 5.00 |
| Mining Engineering. Mining Engineers' Handbook. Peele | 5.00 |
| Molding and Patternmaking. Modern Molding and Patternmaking. Mullin..... | 2.50 |

| | |
|--|------|
| Pipe. Pipe Standards. National Tube Co. | |
| Piping. A Handbook of. Svenson..... | 4.00 |
| Pipe and Fittings. Catalogue No. 50. Crane Co. | |
| Pipe — Lead. Sizes and Information. Nat'l Lead Co. | |
| Pipe — Lead. Sizes and Information. United Lead Co. | |
| Power Plants. Steam Power Plants. Gebhart..... | 4.00 |
| Pumps — Centrifugal. Their Design and Construction. Loewenstein and Crissey..... | 4.50 |
| Railroad Engineering. Railway Maintenance Engineering. Sellew..... | 2.50 |
| Railroad Engineering. Elements of. Raymond..... | 3.25 |
| Railway Locomotive. The Railway Locomotive. Pendred | 2.00 |
| Railway Clearances. Railway Line Clearances. The R'y Equip. & Pub. Co. | |
| Refrigeration. Refrigeration, Cold Storage and Ice Making. Wallis-Taylor..... | 5.50 |
| Safety Engineering. Practical Safety Methods and Devices. Cowee..... | 3.00 |
| Safety Standards. Universal Safety Standards. Hansen. | 3.00 |
| " " Field Book. Maryland Casualty Co. | |
| Sanitation. Modern Sanitary Engineering. Thompson.. | 3.00 |
| Slide Rule. The Slide Rule. Pickworth..... | 1.00 |
| Steel. A Manual for Users. Metcalf | 2.00 |
| " Handbook and Catalogue. Carnegie Steel Co. | 2.00 |
| " Handbook and Catalogue. Cambria Steel Co. | 1.25 |
| " Handbook and Catalogue. Jones and Laughlin. | |
| " Handbook and Catalogue. Lukens Iron and Steel Co. | |
| Tables. Table Book for Engineers. Plimpton..... | 0.50 |
| " Tables for Engineering Calculations. Powell..... | 3.00 |
| Turbines. Steam Turbines. Lowenstein | 5.00 |

Any book in this list (catalogues excepted) will be sent prepaid on receipt of price.

D. VAN NOSTRAND COMPANY
25 Park Place NEW YORK

D. VAN NOSTRAND COMPANY

are prepared to supply, either from
their complete stock or at
short notice,

Any Technical or Scientific Book

In addition to publishing a very large and varied number of SCIENTIFIC AND ENGINEERING BOOKS, D. Van Nostrand Company have on hand the largest assortment in the United States of such books issued by American and foreign publishers.

All inquiries are cheerfully and carefully answered and complete catalogs sent free on request.

25 PARK PLACE

- - - NEW YORK

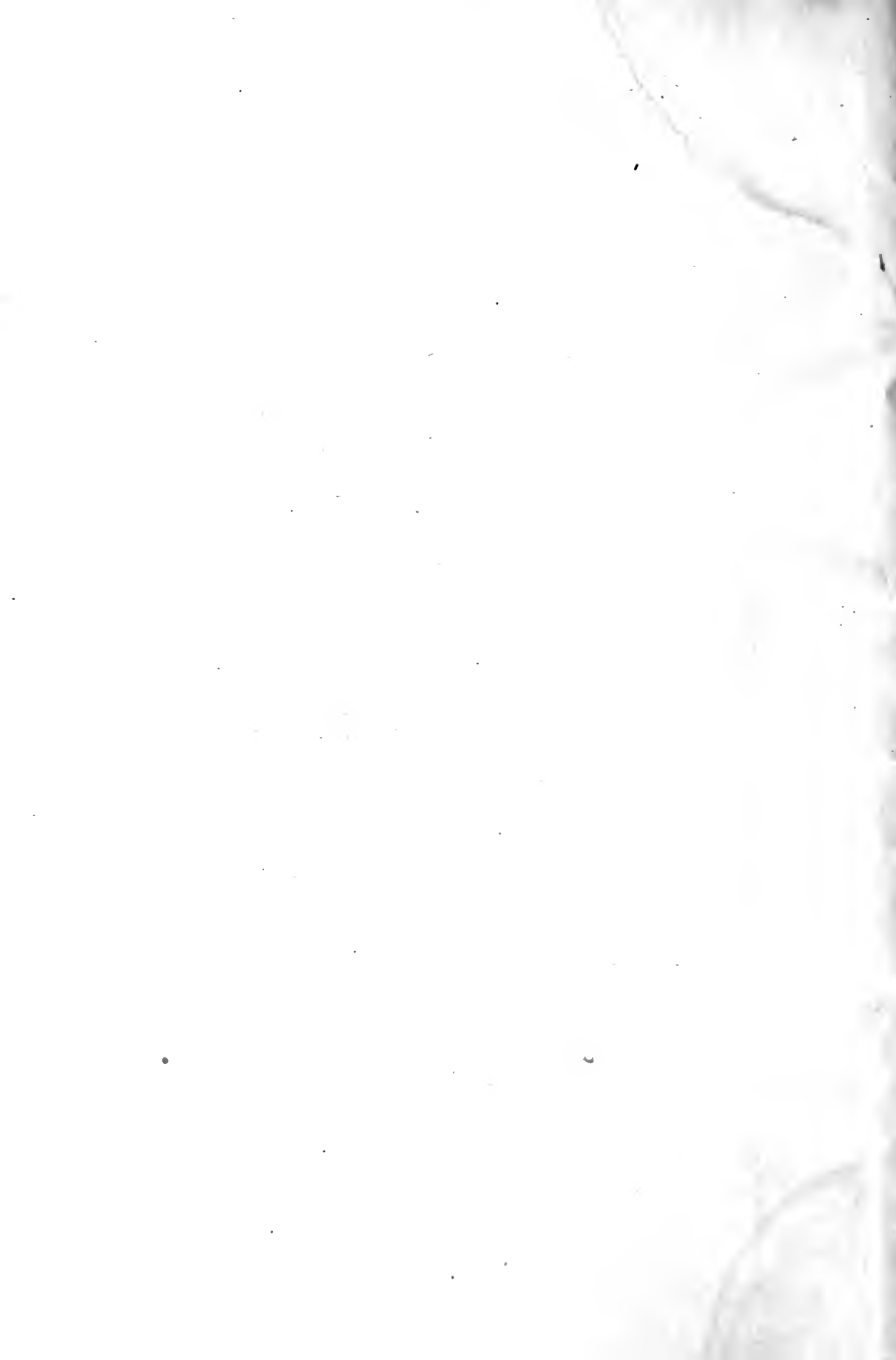

INDEX

| | PAGE |
|--|---------|
| Abbreviations | 44-47 |
| Administration. | 15 |
| Aëronautical terms | 48 |
| Aëroplane types | 60 |
| Applications | 97 |
| Areas of circles | 139-142 |
| Arrangement of a drafting room | 9 |
| Arrangement of a drawing. | 21-98 |
| | |
| Blueprint frame | 10 |
| Blueprint machines. | 9 |
| Blueprints, prices | 10 |
| Boiler tube sizes | 123 |
| Bolt stresses. | 111 |
| Bolt threads | 113-114 |
| Bolts and nuts — sizes | 112 |
| Building records | 99 |
| | |
| Calculations | 29 |
| Catalogues | 29 |
| Check prints. | 29 |
| Circumferences of circles | 139-142 |
| Compass direction | 30 |
| Copyright for drawings | 37 |
| Cross-sections | 61-63 |
| | |
| Decimal equivalents | 113-114 |
| Definitions. | 64 |
| Details | 34 |
| Diary. | 40 |
| Dimensioning a drawing. | 21 |
| Drafting machine. | 9 |
| Drafting room | 9 |
| Drawing record book | 31-100 |
| Drawing sizes | 96 |
| | |
| Electrical symbols | 69 |

| | PAGE |
|--|---------|
| EQUIPMENT. Part I | 9-15 |
| Blueprint frame | 10 |
| Blueprint machine | 9 |
| Blueprint prices | 10 |
| Drafting machine. | 9 |
| Files | 11 |
| Ink bottles | 11 |
| Pencil sharpeners. | 12 |
| Pencils | 12 |
| Pens, ruling | 12 |
| Scales. | 13 |
| Tables | 13 |
| Thumb tacks | 14 |
| Tracing cloth | 14 |
| T squares | 14 |
| Equipment record | 99 |
| Field drawings | 30 |
| Figures | 22 |
| Files | 11 |
| Filing. | 31 |
| Fit dimensions | 30 |
| FORMS. Part III | 95-109 |
| Applications | 97 |
| Arrangement of a drawing. | 21 |
| Building and equipment record. | 99 |
| Drawing record book | 100 |
| Index cards | 101 |
| Material list | 102 |
| Organization chart | 104 |
| Pattern record book | 100 |
| Print record book | 100 |
| Rubber stamp forms | 105 |
| Sizes of forms | 96 |
| Specification. | 103 |
| Titles. | 106 |
| Work order | 108-109 |
| Work schedule | 107 |
| Gages, sheet and plate | 133-134 |
| Gages, wire | 135 |
| General directions | 18-39 |
| Index cards | 101 |
| Ink bottles | 11 |

INDEX

147

| | PAGE |
|---|-------------|
| Lettering | 22 |
| Lines | 71 |
| Material list | 33-102 |
| Memoranda | 41 |
| Men | 16 |
| Millimeter equivalents | 136-137-139 |
| Miscellaneous symbols | 62 |
| Names of parts | 26 |
| Nomenclature of aëronautics. | 48-59 |
| Notebook | 40 |
| Notes on drawings | 22 |
| Old drawings and prints. | 34 |
| Orders for drawings. | 19-108 |
| Organization. | 15 |
| Organization chart | 104 |
| Output | 17 |
| Parts list | 34 |
| Patent office symbols | 72-74 |
| Pattern record book | 35-100 |
| Patterns | 35 |
| Pencils, sharpeners | 12 |
| Pens, ruling | 12 |
| Pipe and fittings, sizes, flanged | 126-129 |
| Pipe fittings, symbols | 83 |
| Pipe threads, | 117-118-119 |
| Preliminary prints | 36 |
| Print record book | 31-100 |
| Pipe dimensions | 120-121-122 |
| Pipe flange dimensions | 124-125 |
| Qualifications | 17 |
| Record prints | 36 |
| Reference books | 143 |
| Reference drawings. | 36 |
| Revisions | 36 |
| Rivet symbols | 84 |
| Rubber stamp forms | 105 |
| Safety standards — notes | 43 |
| Scales. | 13-21 |
| Sections. | 61-63 |

| | PAGE |
|---|-------------|
| Shading | 21 |
| Signatures on drawings | 28 |
| Sizes of drawings | 96 |
| Specifications | 34-103 |
| Stamp forms | 105 |
| STANDARDS AND SYMBOLS. Part II | 44-92 |
| Abbreviations | 44-47 |
| Cross-sections, building materials | 61-62 |
| Cross-sections, geological | 63 |
| Cross-sections, miscellaneous | 62 |
| Cross-sections, structural materials | 85 |
| Definitions | 64 |
| Electrical | 69 |
| Lines | 71 |
| Miscellaneous | 62 |
| Patent office symbols | 72-74 |
| Pipe fittings | 83 |
| Rivet symbols | 84 |
| Structural | 85 |
| Threads and tapped holes | 86 |
| Topographical symbols | 87-92 |
| Starting a drawing | 20 |
| Structural symbols | 85 |
| Studs | 117 |
| | |
| TABLES. Part IV | 109 |
| Areas of circles | 139-142 |
| Boiler tubes | 123 |
| Bolt stresses | 111 |
| Bolt threads | 113-114 |
| Bolts and nuts | 112 |
| Decimal equivalents | 139 |
| Gages, plate | 133-134 |
| Gages, wire | 135 |
| Key seats | 130-131 |
| Millimeter equivalents | 136-137-139 |
| Pipe dimensions | 120-121-122 |
| Pipe fittings—flanged | 126-129 |
| Pipe flange dimensions | 124-125 |
| Pipe threads | 117-118-119 |
| Shafting—H. P. | 132 |
| Studs | 117 |
| Washers | 115 |
| Weights and measures | 138 |
| Weights of round, square and hex. steel | 116 |

INDEX

149

| | PAGE |
|---|---------|
| Tables, drafting | 13 |
| Technical journals | 39 |
| Threads. | 86 |
| Title forms | 106 |
| Titles. | 26 |
| Topographical symbols | 87-92 |
| Tracing | 28 |
| Tracing sheets | 14 |
| Transmitting prints. | 33 |
| T squares | 14 |
| Void drawings and prints | 37 |
| Washers | 115 |
| Weights of bars | 116 |
| Weights and measures | 138 |
| Work order form | 108 |
| Work order form, reverse side | 109 |
| Work orders | 19 |
| Work schedule | 107 |



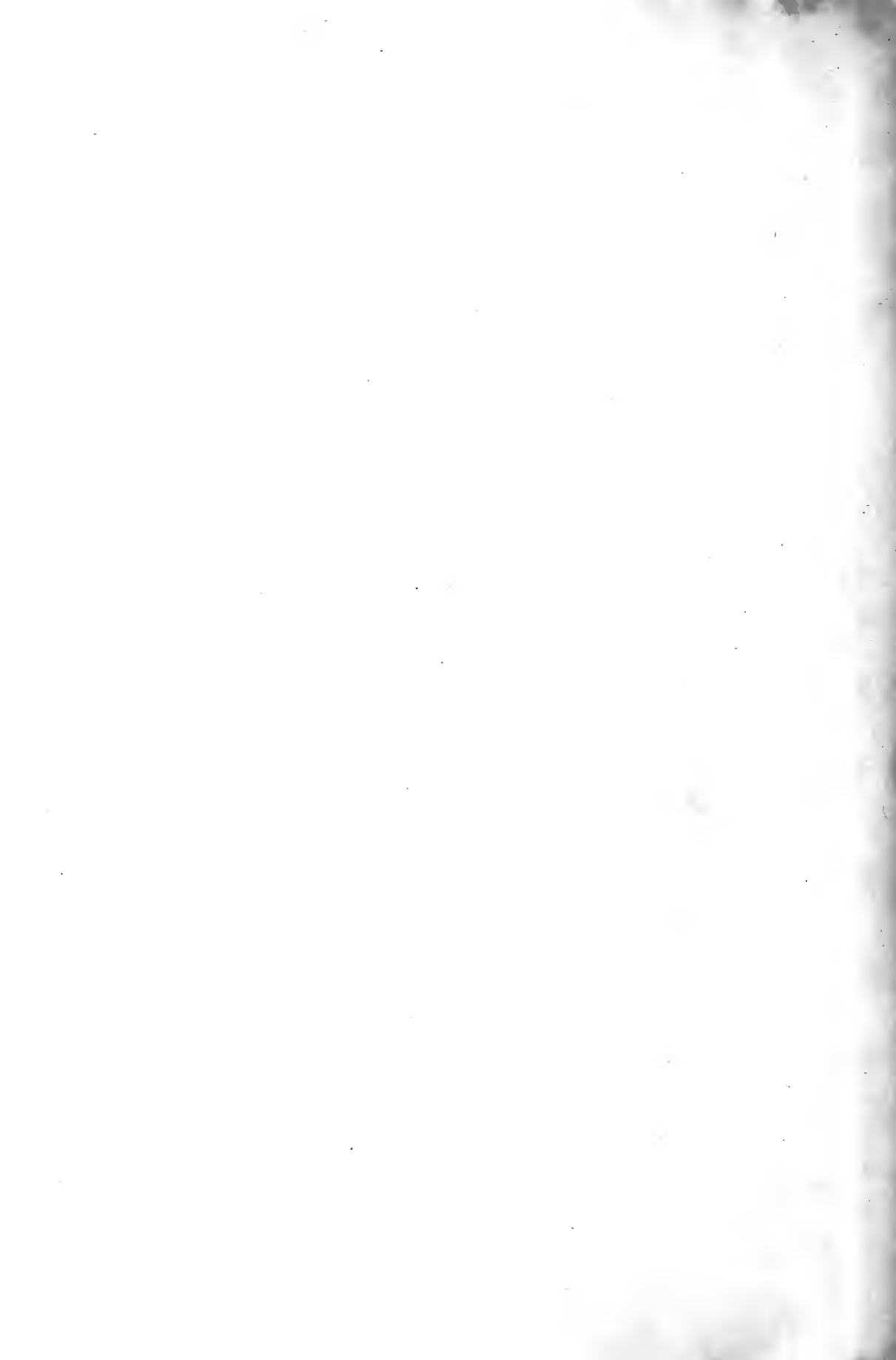





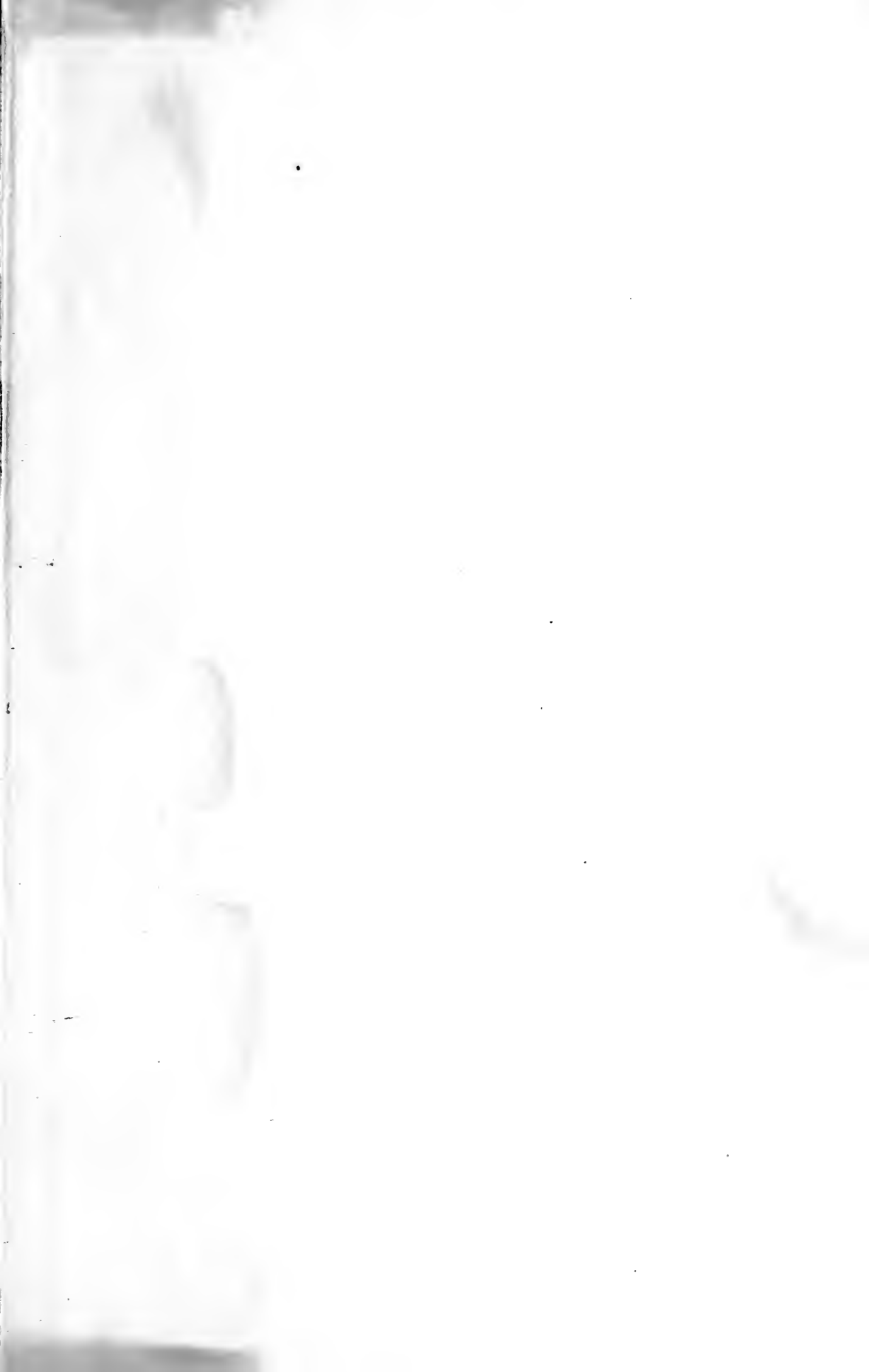

LIBRARY OF CONGRESS



0 019 936 633 6